



PRODUCT DATA SHEET

CREATED ON 26.08.2024 ON WWW.GEISTER.COM

03-0038.21V

Microsurgical Scissors flat handle 21cm 125° "V" edge 10mm Type: Jacobson

Material: ...

GTIN Number: 04057034003848



Illustrations, technical changes and the like are subject to product changes and are therefore not binding.



PRODUCT DATA SHEET

CREATED ON 26.08.2024 ON WWW.GEISTER.COM

03-0032.21

Microsurgical Scissors flat handle 21cm 45° edge 10mm Type: Jacobson

Material: ...

GTIN Number: 04057034003237



Illustrations, technical changes and the like are subject to product changes and are therefore not binding.



PRODUCT DATA SHEET

CREATED ON 26.08.2024 ON WWW.GEISTER.COM

10-3930

Microsurgical Tissue Forceps, round hdl. 21.0cm 0.5x1.0mm Type: Ring, Sapphire™

Material: 1.4021

GTIN Number: 04057034027189

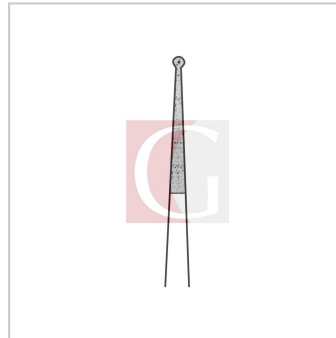

Illustrations, technical changes and the like are subject to product changes and are therefore not binding.



PRODUCT DATA SHEET

CREATED ON 26.08.2024 ON WWW.GEISTER.COM

10-3730

Microsurgical Tissue Forceps, round hdl. counterbalanced 21.0cm tip 1.0mm Type: DeBakey

Material: 1.4021

GTIN Number: 04057034026526

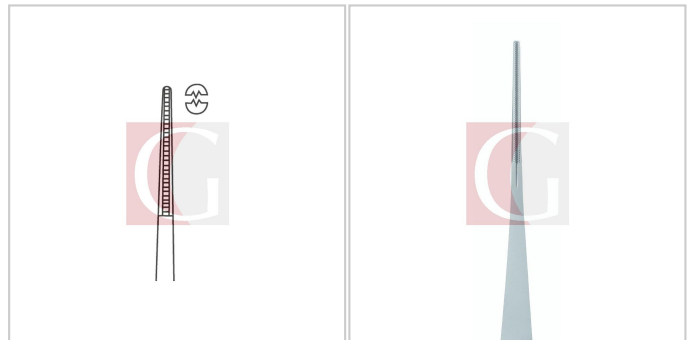

Illustrations, technical changes and the like are subject to product changes and are therefore not binding.



PRODUCT DATA SHEET

CREATED ON 26.08.2024 ON WWW.GEISTER.COM

03-0205

Microsurgical Needle Holder, ratchet round handle 21cm 0.8mm [$\leq 6-0$] Type: Jacobson, Sapphire™

Material: ...

GTIN Number: 04057034005477



Illustrations, technical changes and the like are subject to product changes and are therefore not binding.



PRODUCT DATA SHEET

CREATED ON 26.08.2024 ON WWW.GEISTER.COM

03-0195

Microsurgical Needle Holder, ratchet round handle 21cm 0.4mm [$\leq 8-0$] Type: Jacobson, Sapphire™

Material: ...

GTIN Number: 04057034005408

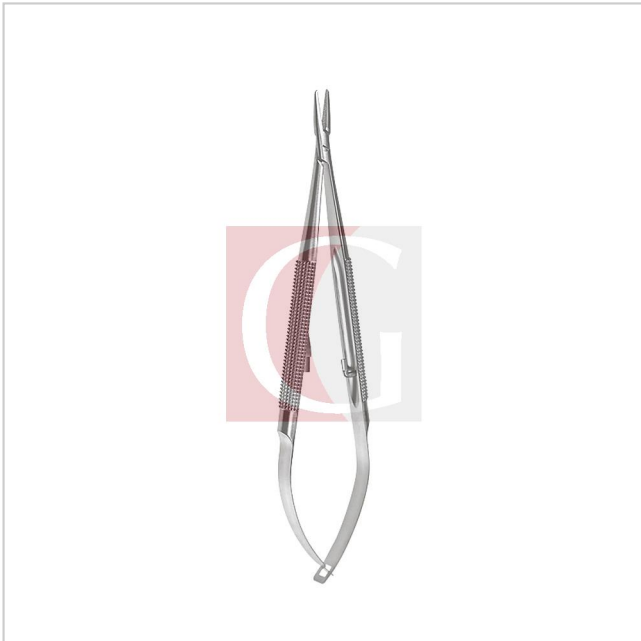

Illustrations, technical changes and the like are subject to product changes and are therefore not binding.



PRODUCT DATA SHEET

CREATED ON 26.08.2024 ON WWW.GEISTER.COM

25-0148

Dissecting Forceps (transient use) 19cm strongly curved Type: Jacobson

Material: ...

GTIN Number: 04057034070390

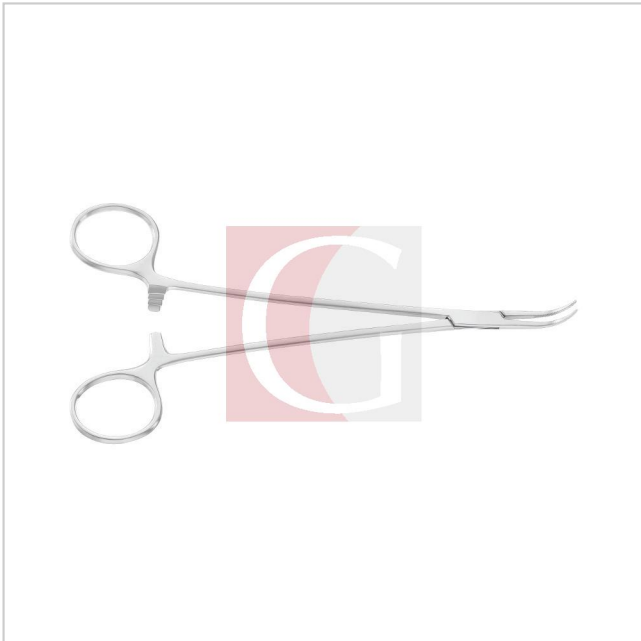

Illustrations, technical changes and the like are subject to product changes and are therefore not binding.

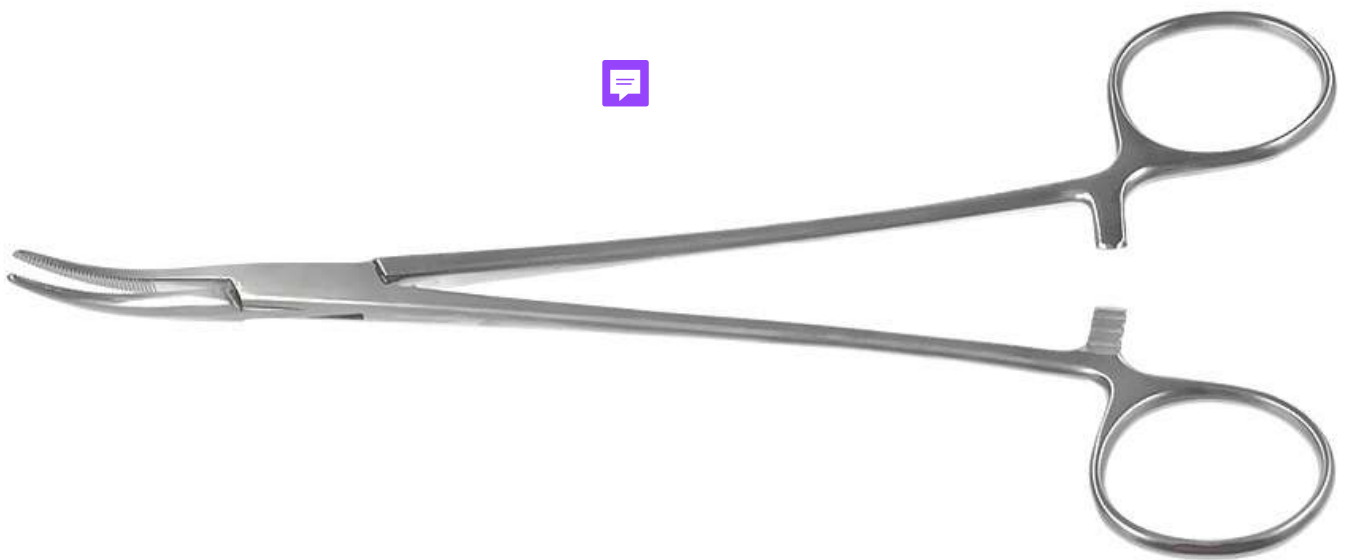

25-1355 picture is used as reference



PRODUCT DATA SHEET

CREATED ON 26.08.2024 ON WWW.GEISTER.COM

25-0151

Dissecting Forceps (transient use) 20cm curved Type: Heiss

Material: ...

GTIN Number: 04057034070420

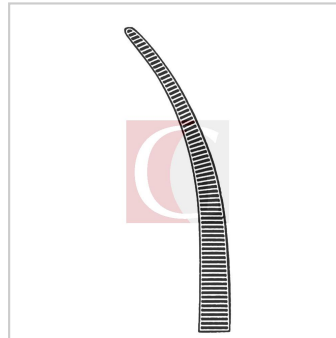
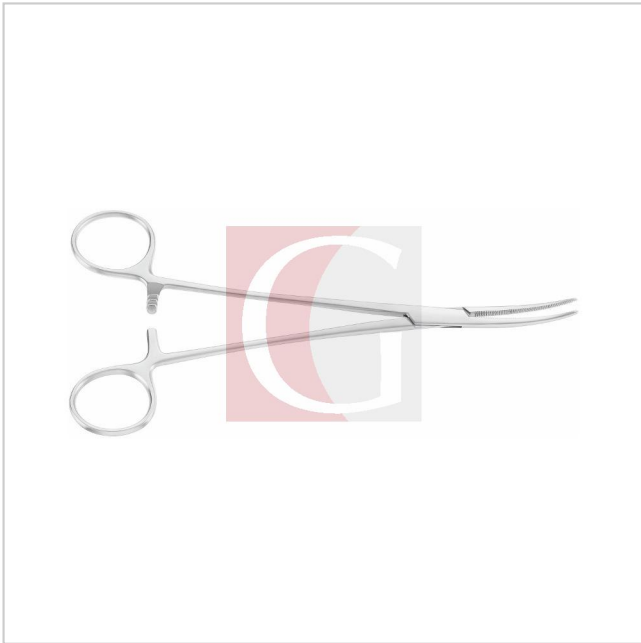

Illustrations, technical changes and the like are subject to product changes and are therefore not binding.



PRODUCT DATA SHEET

CREATED ON 26.08.2024 ON WWW.GEISTER.COM

25-1211

Artery Forceps (transient use) 16cm curved Type: Crile-Rankin

Material: ...

GTIN Number: 04057034072998

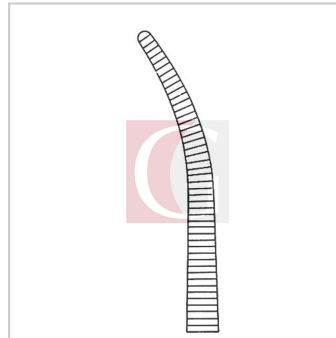

Illustrations, technical changes and the like are subject to product changes and are therefore not binding.



PRODUCT DATA SHEET

CREATED ON 26.08.2024 ON WWW.GEISTER.COM

25-1121

Artery Forceps (transient use) 16cm Type: Rochester-Pean

Material: ...

GTIN Number: 04057034072363

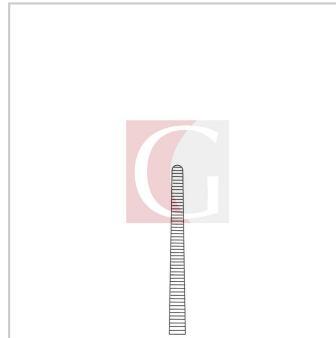
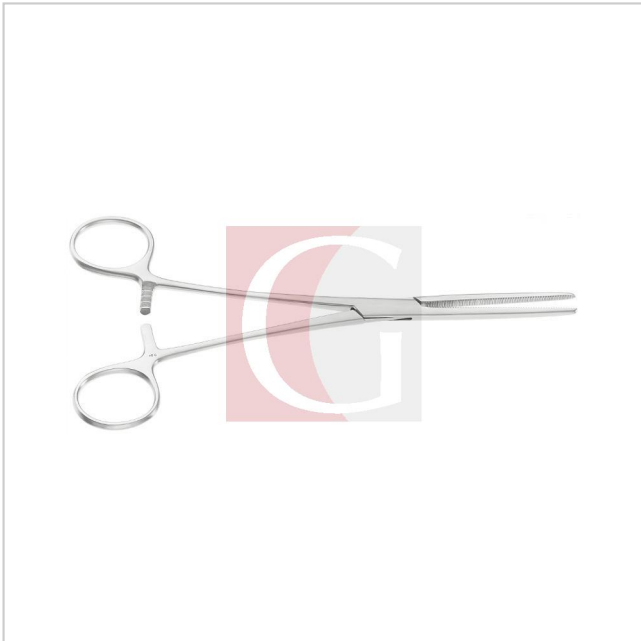

Illustrations, technical changes and the like are subject to product changes and are therefore not binding.



PRODUCT DATA SHEET

CREATED ON 26.08.2024 ON WWW.GEISTER.COM

24-0920

Wire Cutting Forceps, TC 22cm, wire max. 2.2mm Type: Mega

Material: ...

GTIN Number: 04057034067635

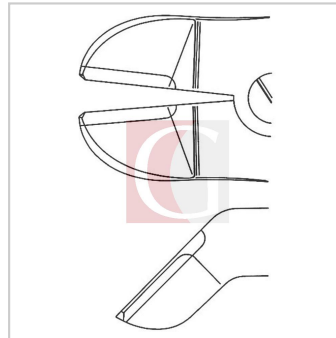

Illustrations, technical changes and the like are subject to product changes and are therefore not binding.



PRODUCT DATA SHEET

CREATED ON 26.08.2024 ON WWW.GEISTER.COM

24-8143

Needle Holder 19cm Type: Mayo-Hegar

Material: ...

GTIN Number: 04057034068465

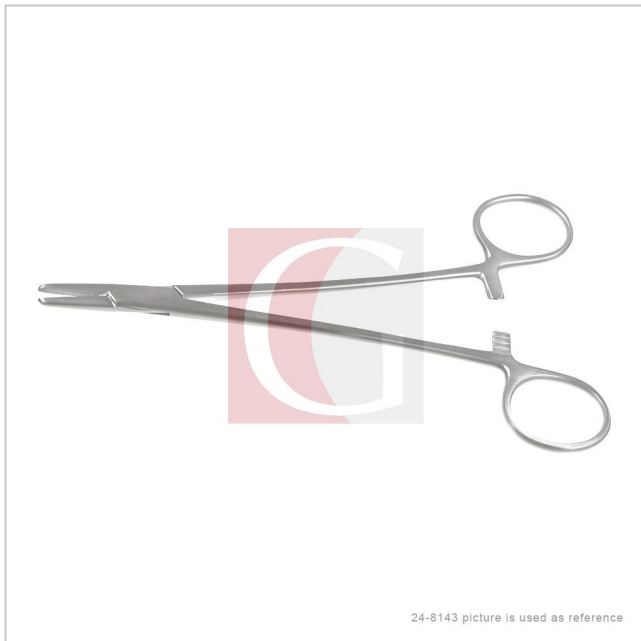

Illustrations, technical changes and the like are subject to product changes and are therefore not binding.



PRODUCT DATA SHEET

CREATED ON 26.08.2024 ON WWW.GEISTER.COM

22-0171

Atraumatic Clamp (transient use) 26.5cm curved stronglye pattern Type: DeBakey

Material: 1.4021

GTIN Number: 04057034053126

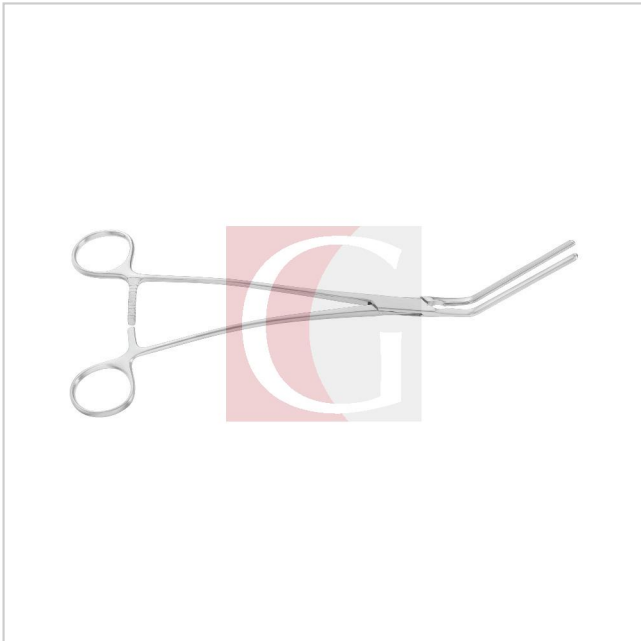

Illustrations, technical changes and the like are subject to product changes and are therefore not binding.



PRODUCT DATA SHEET

CREATED ON 26.08.2024 ON WWW.GEISTER.COM

10-0152

Atraumatic Tissue Forceps 19.5cm angled tip 1.5mm Type: DeBakey-Diethrich

Material: 1.4024

GTIN Number: 04057034019009



Illustrations, technical changes and the like are subject to product changes and are therefore not binding.



PRODUCT DATA SHEET

CREATED ON 26.08.2024 ON WWW.GEISTER.COM

18-0375

Suction Tube, VATS, without interruptor 36cm / 22cm 7.5mm curved Ø5.0mm Type: ThoraGate™

Material: 1.4301/1.4305

GTIN Number: 04057034040140

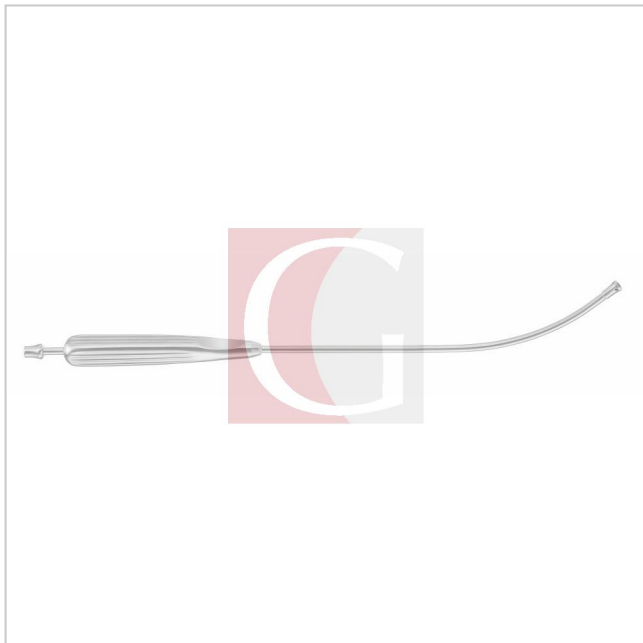

Illustrations, technical changes and the like are subject to product changes and are therefore not binding.



PRODUCT DATA SHEET

CREATED ON 26.08.2024 ON WWW.GEISTER.COM

34-7824S

Atraumatic Tissue Forceps, tube-shaft 2.9mm 16mm Ø5 17cm Type: Resano ValveGate™

Material: ...

GTIN Number: 04057034122587

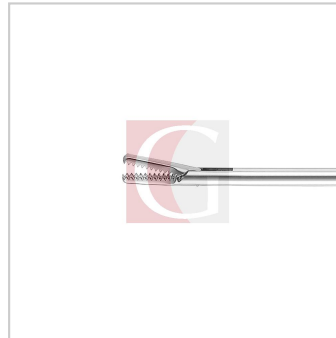
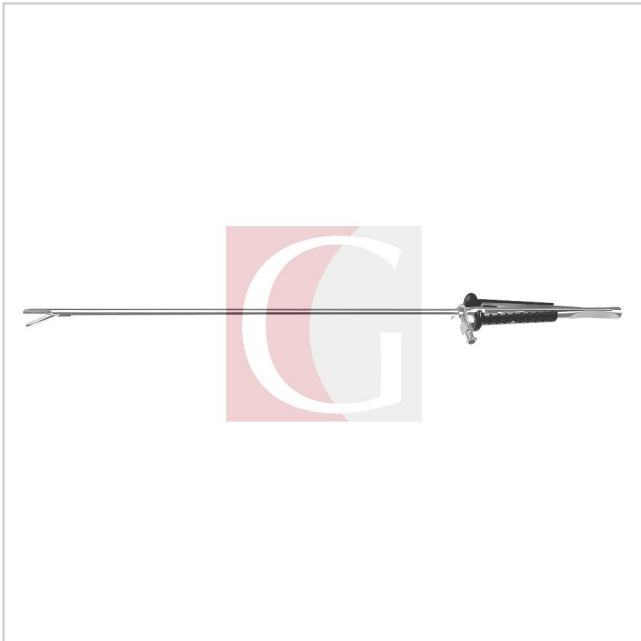

Illustrations, technical changes and the like are subject to product changes and are therefore not binding.



PRODUCT DATA SHEET

CREATED ON 26.08.2024 ON WWW.GEISTER.COM

34-7862

Scissors, Micro, tube-shaft single-action Ø3.4 25cm Type: Potts ValveGate™

Material: ...

GTIN Number: 04057034123553

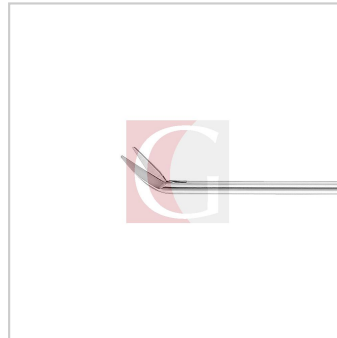
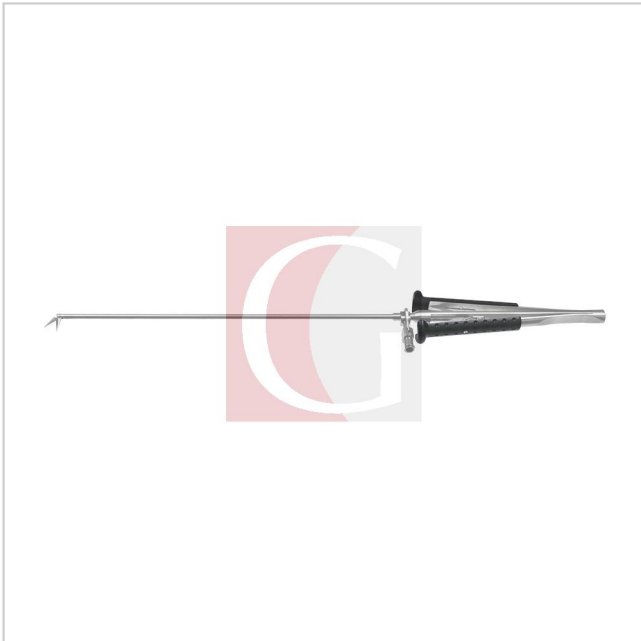

Illustrations, technical changes and the like are subject to product changes and are therefore not binding.



PRODUCT DATA SHEET

CREATED ON 26.08.2024 ON WWW.GEISTER.COM

34-7840

Scissors, tube-shaft 70° double-action Ø5 25cm Type: ValveGate™

Material: ...

GTIN Number: 04057034123201

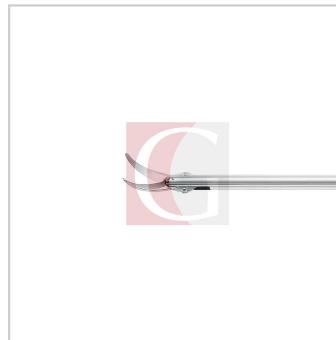
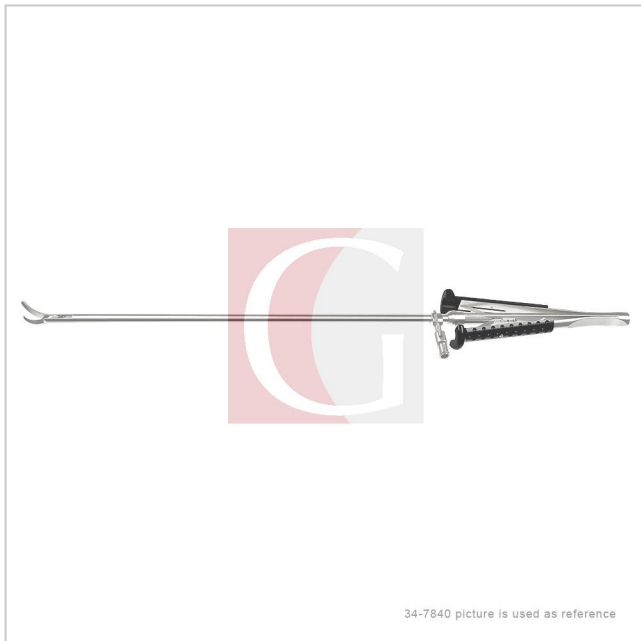

Illustrations, technical changes and the like are subject to product changes and are therefore not binding.



PRODUCT DATA SHEET

CREATED ON 26.08.2024 ON WWW.GEISTER.COM

34-7822

Atraumatic Tissue Forceps, tube-shaft 1.5mm 1x2 14mm Ø5 25cm Type: DeBaKey ValveGate™

Material: ...

GTIN Number: 04057034122433

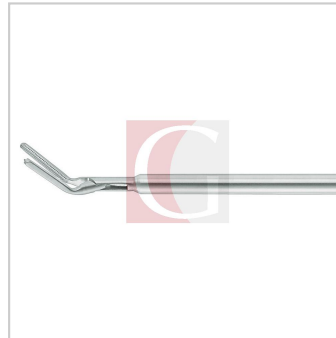

Illustrations, technical changes and the like are subject to product changes and are therefore not binding.



PRODUCT DATA SHEET

CREATED ON 26.08.2024 ON WWW.GEISTER.COM

38-7802

Needle Holder, tube-shaft, TC curved with ratchet Ø5 25cm Type: ValveGate™PRO

Material: 1.4021

GTIN Number: 04057034131497

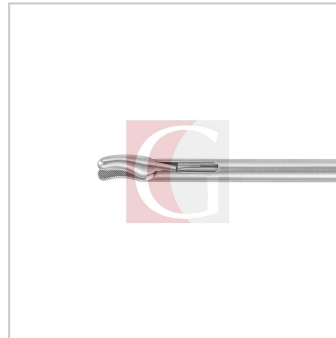
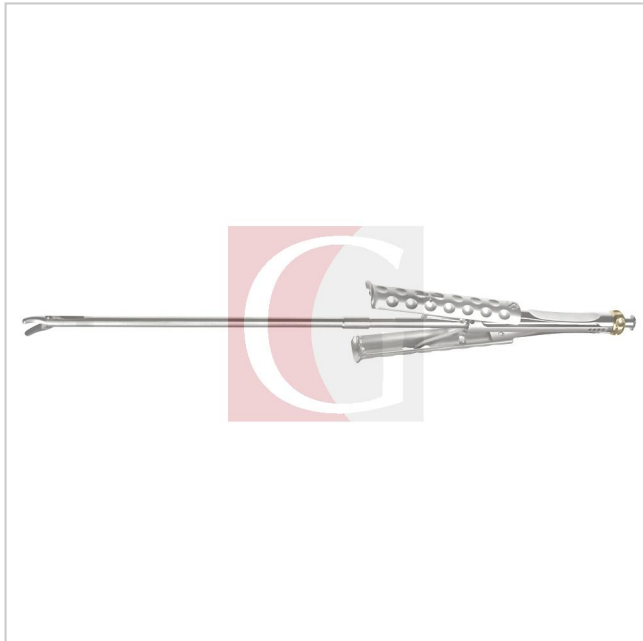

Illustrations, technical changes and the like are subject to product changes and are therefore not binding.



PRODUCT DATA SHEET

CREATED ON 26.08.2024 ON WWW.GEISTER.COM

26-2535

Vascular Scissors 17.5cm curved Type: DeBakey

Material: 1.4117/ 1.4305

GTIN Number: 04057034079799

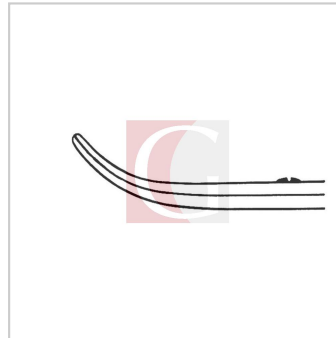
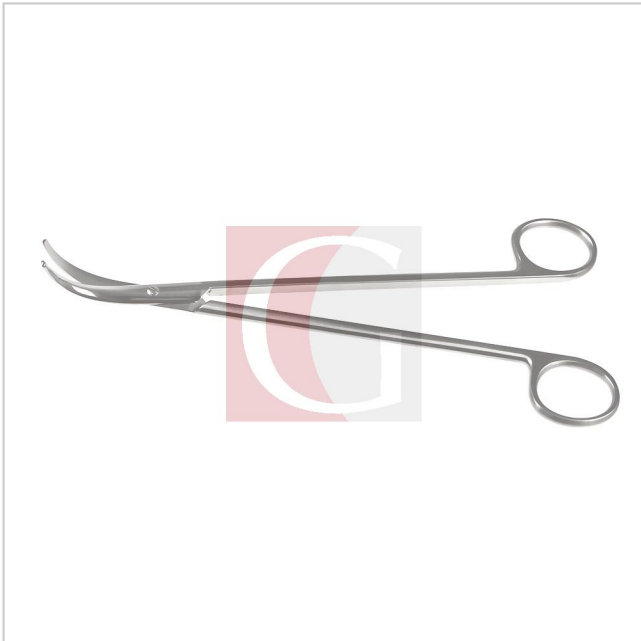

Illustrations, technical changes and the like are subject to product changes and are therefore not binding.



PRODUCT DATA SHEET

CREATED ON 26.08.2024 ON WWW.GEISTER.COM

26-0111.DF

Dissecting Scissors, TC 28cm curved Type: Metzenbaum Pandor™

Material: 1.4117/ 1.4305

GTIN Number: 04057034077931

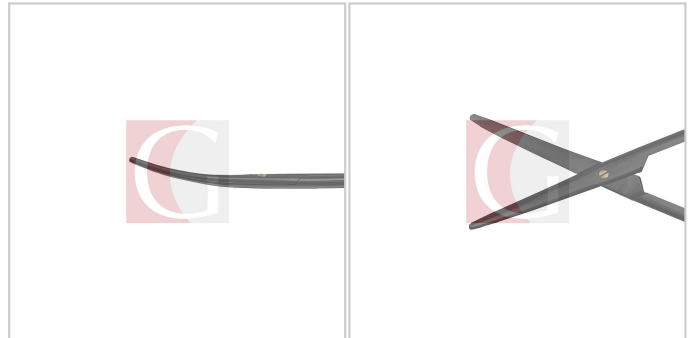
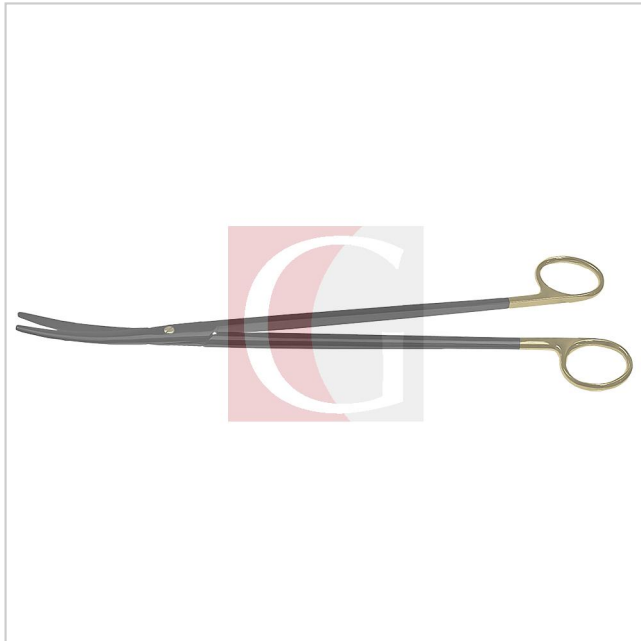

Illustrations, technical changes and the like are subject to product changes and are therefore not binding.



PRODUCT DATA SHEET

CREATED ON 26.08.2024 ON WWW.GEISTER.COM

30-0606

Wound Retractor (transient use) 3x4 16cm semi-sharp Type: Weitlaner

Material: 1.4021

GTIN Number: 04057034109410

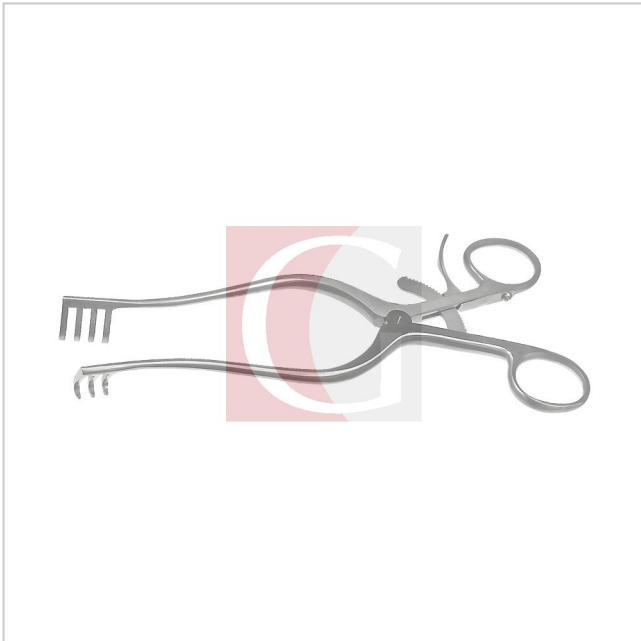

Illustrations, technical changes and the like are subject to product changes and are therefore not binding.



PRODUCT DATA SHEET

CREATED ON 26.08.2024 ON WWW.GEISTER.COM

03-7601

Chest Tube Passer 24cm with ratchet with guide Type: Stern

Material: ...

GTIN Number: 04057034015360

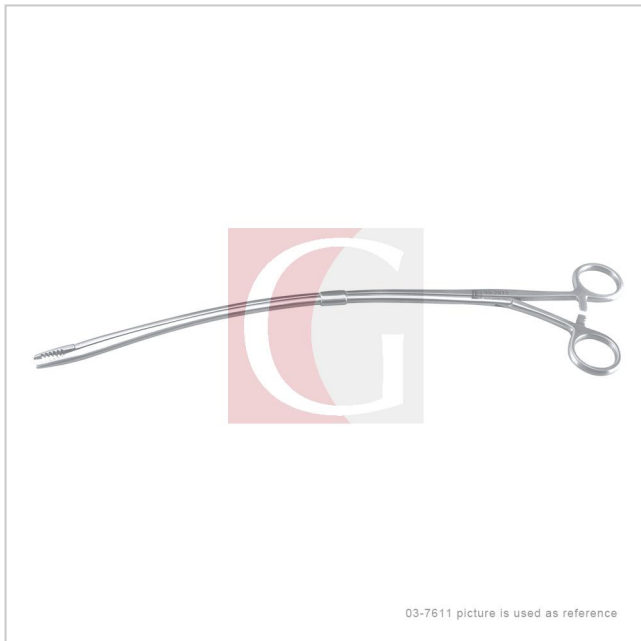

Illustrations, technical changes and the like are subject to product changes and are therefore not binding.



PRODUCT DATA SHEET

CREATED ON 26.08.2024 ON WWW.GEISTER.COM

34-7313.SP

Clamp, slider-shaft, Dissecting 35cm 70/55mm 90° curved with ratchet Type: DeBakey-Cooley ThoraGate™ Soft-Tou

Material: ...

GTIN Number: 04057034119099

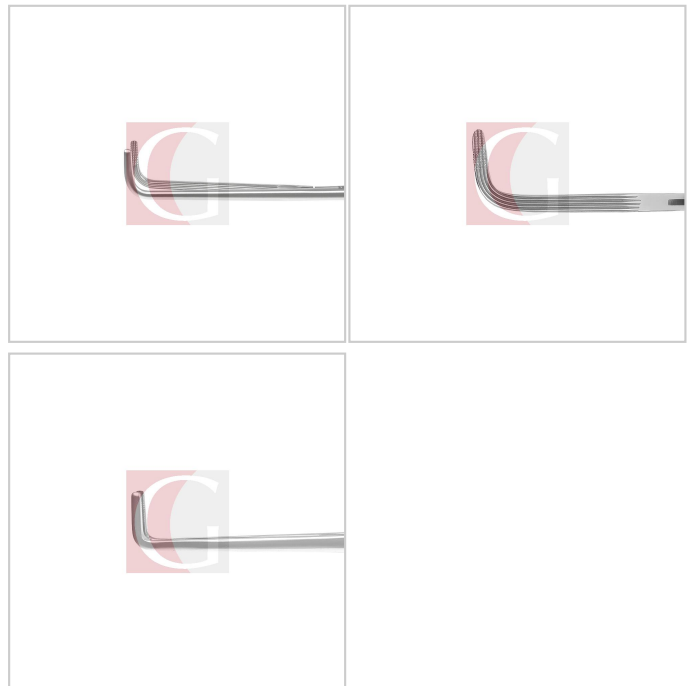
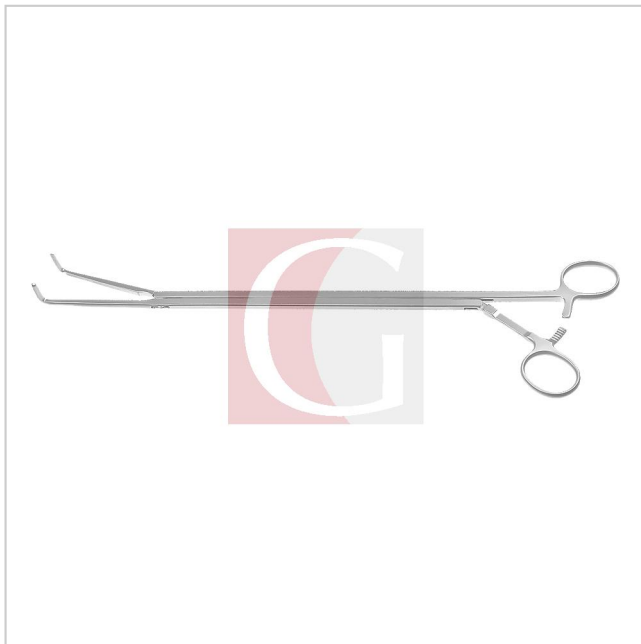

Illustrations, technical changes and the like are subject to product changes and are therefore not binding.



PRODUCT DATA SHEET

CREATED ON 26.08.2024 ON WWW.GEISTER.COM

34-6278

Dissecting Forceps, slider-shaft 34cm 7.5x6mm curved without ratchet Type: Cobra ThoraGate™ Soft-Touch

Material: ...

GTIN Number: 04057034503782

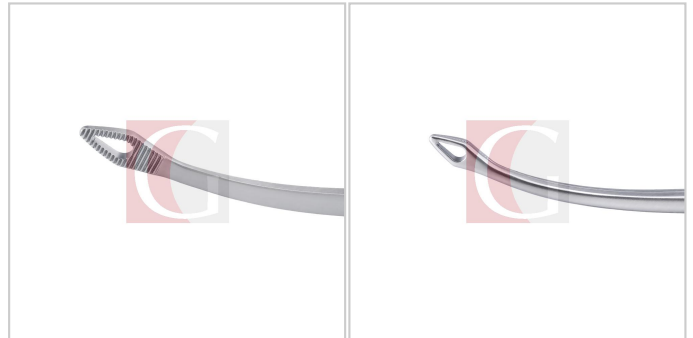

Illustrations, technical changes and the like are subject to product changes and are therefore not binding.



PRODUCT DATA SHEET

CREATED ON 26.08.2024 ON WWW.GEISTER.COM

34-7338

Scissors, slider-shaft 31cm 33mm curved Type: Metzenbaum ThoraGate™ Soft-Touch

Material: ...

GTIN Number: 04057034119396

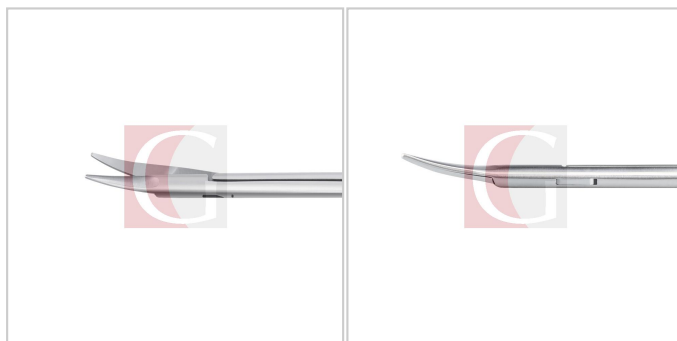

Illustrations, technical changes and the like are subject to product changes and are therefore not binding.



PRODUCT DATA SHEET

CREATED ON 26.08.2024 ON WWW.GEISTER.COM

34-6270

Grasping Forceps, slider-shaft 37cm 20x12mm oval ring curved w/ratchet Type: Foerster ThoraGate™ Soft-Touch

Material: ...

GTIN Number: 04057034219003

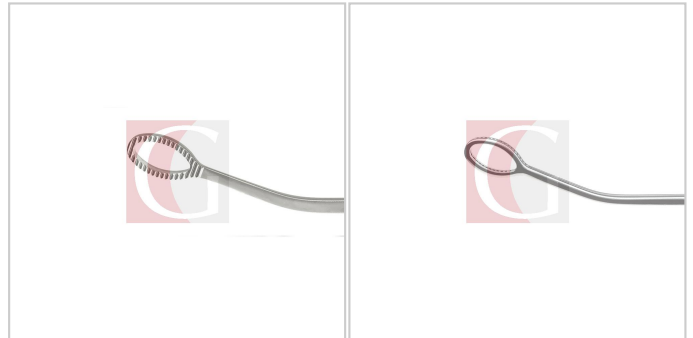
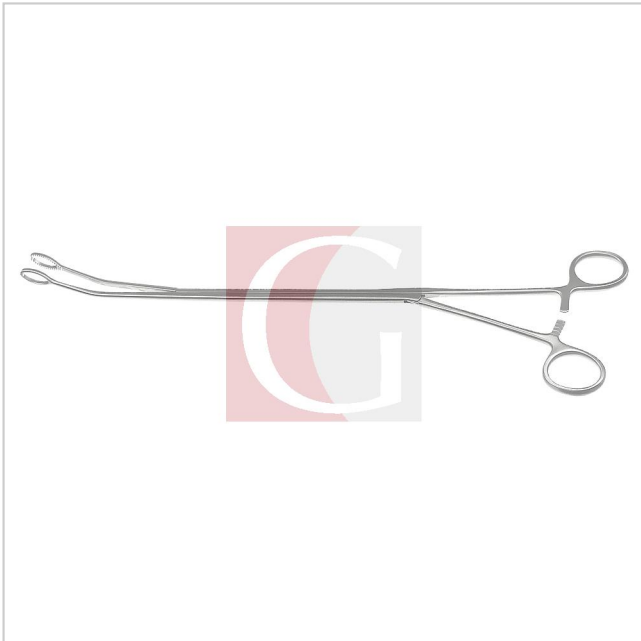

Illustrations, technical changes and the like are subject to product changes and are therefore not binding.



PRODUCT DATA SHEET

CREATED ON 26.08.2024 ON WWW.GEISTER.COM

34-7352

Needle Holder, slider-shaft, TC 34cm curved fine jaw with ratchet Type: ThoraGate™ Soft-Touch

Material: ...

GTIN Number: 04057034119495

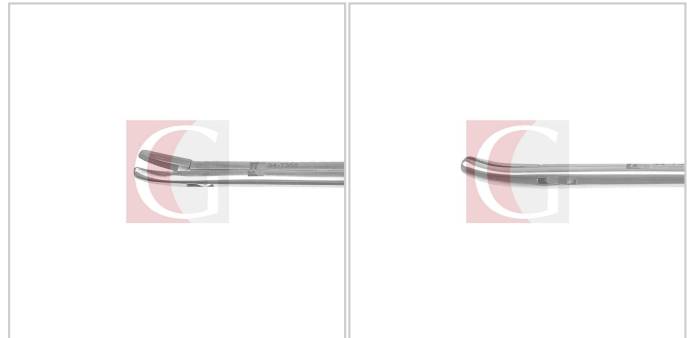
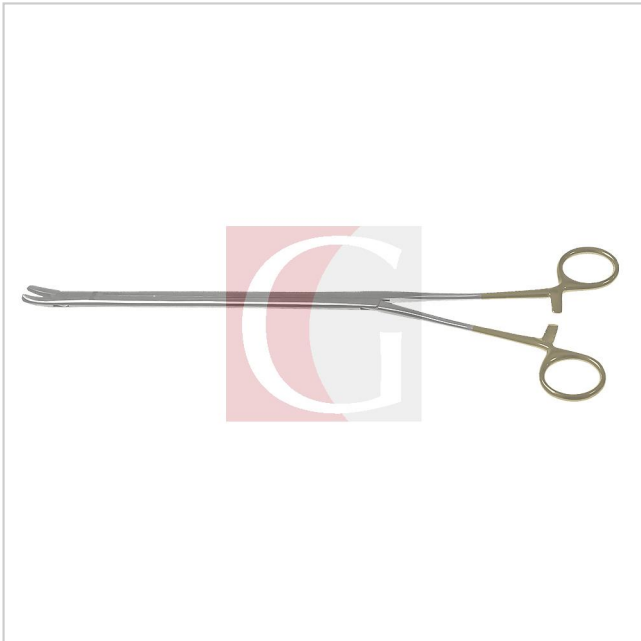

Illustrations, technical changes and the like are subject to product changes and are therefore not binding.



PRODUCT DATA SHEET

CREATED ON 26.08.2024 ON WWW.GEISTER.COM

18-0376

Suction Tube, VATS, without interruptor 45cm / 32cm 7.5mm curved Ø5.0mm Type: ThoraGate™

Material: 1.4301/1.4305

GTIN Number: 04057034040164

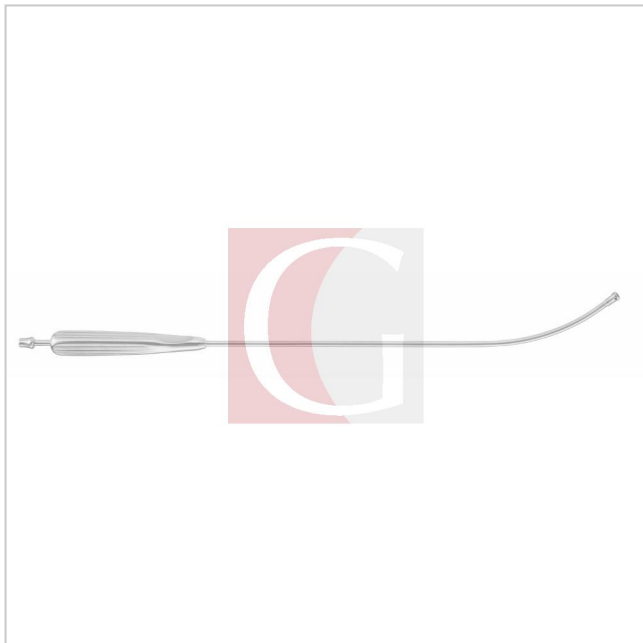

Illustrations, technical changes and the like are subject to product changes and are therefore not binding.

Suction, Cannula



18-0550

18-0550

with control

Length: 340 mm

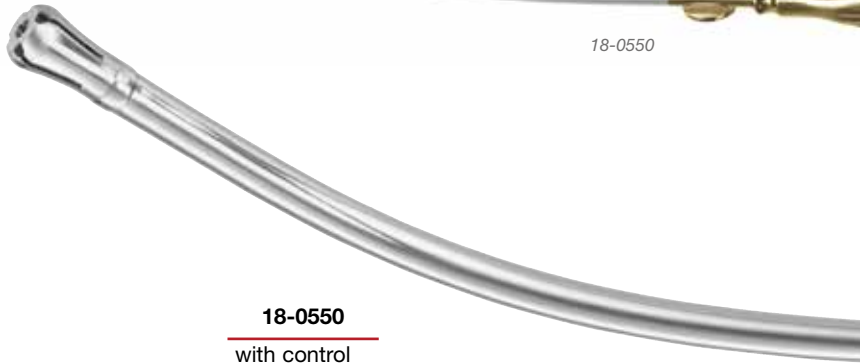

18-0551

without control
large basket

Length: 300 mm

Biopsy, Graspers



25-7100

25-7100

straight

Length: 320 mm



25-7101

curved

Length: 280 mm



PRODUCT DATA SHEET

CREATED ON 26.08.2024 ON WWW.GEISTER.COM

34-7485

Hook, Vascular- and Tissue 35cm Type: ValveGate™

Material: 1.4021

GTIN Number: 04057034120729

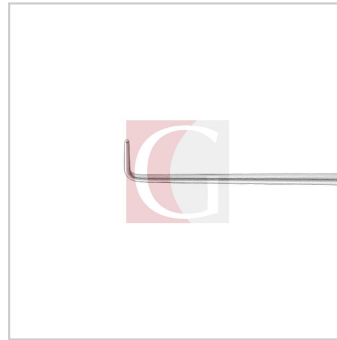
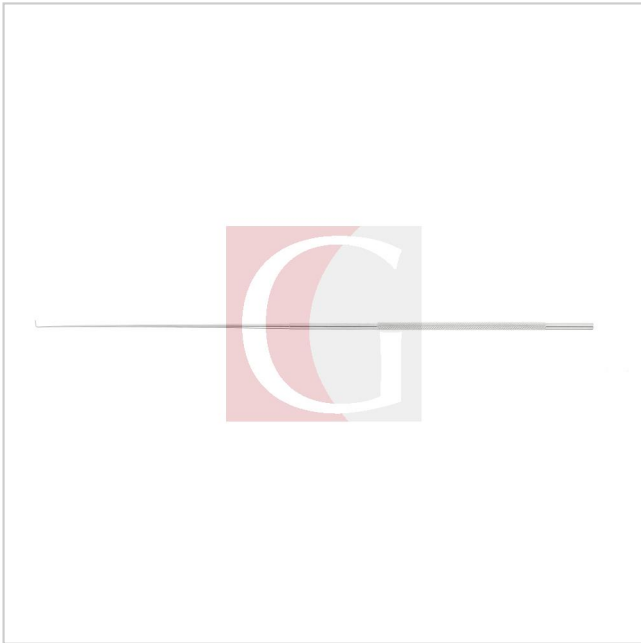

Illustrations, technical changes and the like are subject to product changes and are therefore not binding.



PRODUCT DATA SHEET

CREATED ON 26.08.2024 ON WWW.GEISTER.COM

34-7485

Hook, Vascular- and Tissue 35cm Type: ValveGate™

Material: 1.4021

GTIN Number: 04057034120729

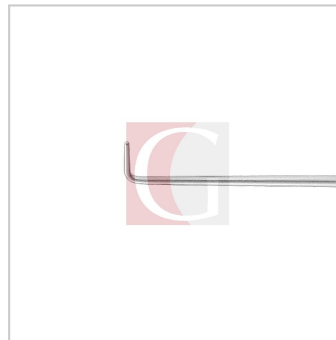
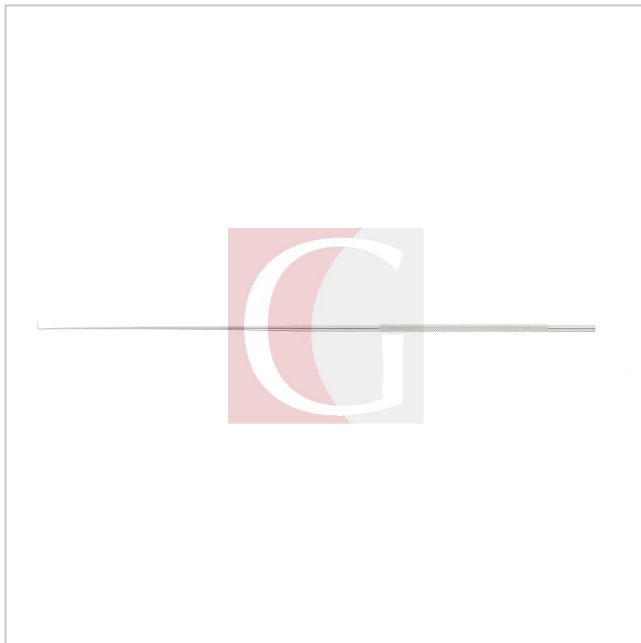

Illustrations, technical changes and the like are subject to product changes and are therefore not binding.

GEISTER®

ValveGate™
classic line

The gold standard for
minimally invasive heart surgery



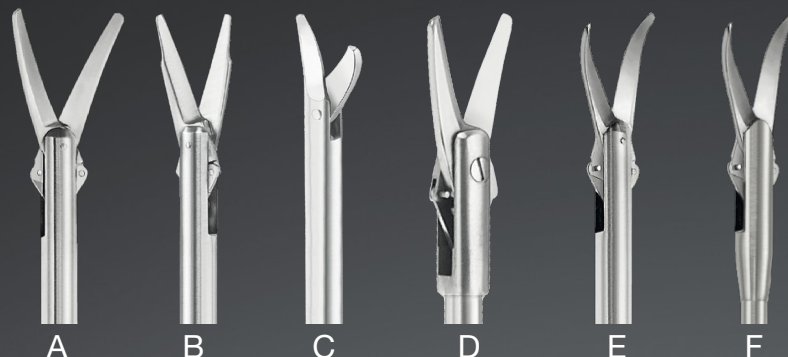

ValveGate™ Scissors

Fig	Art.-No.	
A	34-7830	15° curved
B	34-7831	Jameson Scissors, curved, tenotomy tips
C	34-7832	20° curved, single action
D	34-7833	robust, 7 mm shaft, 30° curved
E	34-7835	30° curved
F	34-7958	30° curved, 3,4 mm shaft
G	34-7836	40° curved, single action
H	34-7840	70° curved
I	34-7842	Ligature Scissors, 70° curved wave-cut
J	34-7860	Potts Scissors 125°, 3,4 mm shaft
K	34-7862	Potts Scissors 45°, 3,4 mm shaft
L	34-7861	Potts Scissors 30°, heavy pattern



5 mm shaft diameter, unless otherwise specified. Standard working length 25 cm/10" for minimally invasive valve surgery. For different length add "A", "B", "C", "S", "L" or "XL" behind article number.

A = 10 cm/4" B = 12 cm/5" C = 15 cm/6" S = 17 cm/6¾" L = 30 cm/12" XL = 35 cm/14"

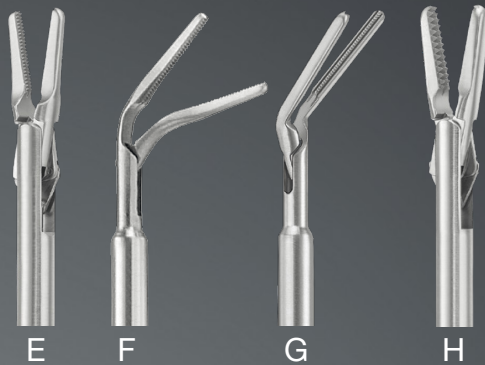

ValveGate™ Graspers with DeBakey Jaws

Fig.	Art.-No.	Description
E	34-7820	1x2 teeth, narrow, straight, 1,5x11 mm
F	34-7821	1x2 teeth, narrow, angled upwards, 1,5x18 mm
G	34-7822	1x2 teeth, narrow, angled sideways, 1,5x18 mm, vertically opening inline with handle
H	34-7825	1x2 teeth, wide jaw, 2,8x11 mm, straight
I	34-7827	1x2 teeth, delicate, 1,5x11 mm, 5/3 mm malleable shaft
J	34-7881	1x2 teeth, 1,5x15 mm, length of jaw 22 mm, narrow, straight
K	34-7918	1x2 teeth, narrow, 1,5x15 mm, angled sideways 10°
L	34-7919	1x2 teeth, narrow, 1,5x15 mm, angled sideways 25°
M	34-7922	1x2 teeth, narrow, angled sideways, 1,5x18 mm, horizontally opening

5 mm shaft diameter, unless otherwise specified. Standard working length 25 cm/10" for minimally invasive valve surgery. For different length add "A", "B", "C", "S", "L" or "XL" behind article number.

A = 10 cm/4" B = 12 cm/5" C = 15 cm/6" S = 17 cm/6¾" L = 30 cm/12" XL = 35 cm/14"

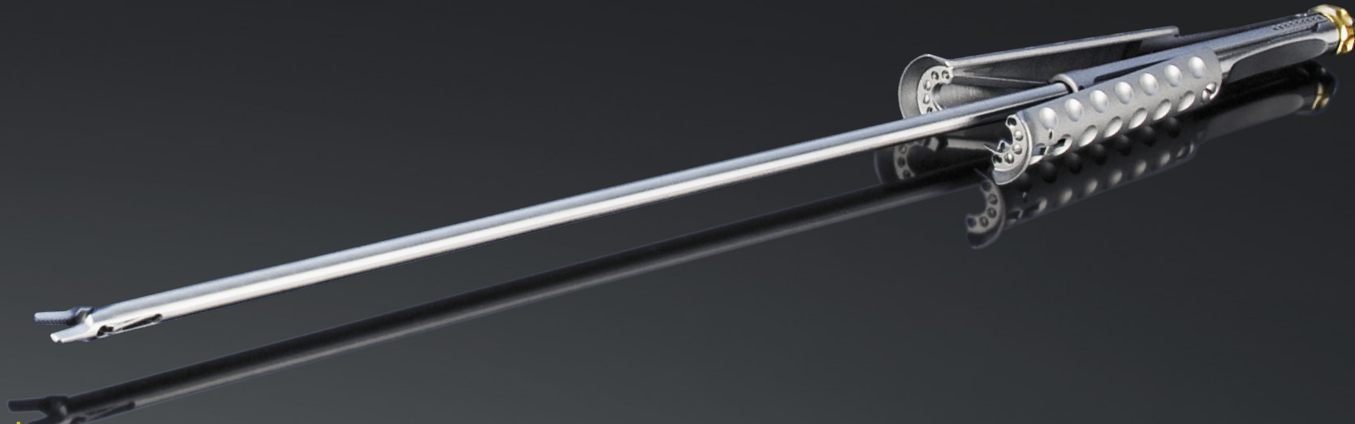

Scissors

Fig.	Art.-No.	Fig.	Art.-No.	Fig.	Art.-No.	Fig.	Art.-No.	Fig.	Art.-No.
1	38-7830	3	38-7832	5	38-7835	7	38-7840	9	38-7860
2	38-7831	4	38-7833	6	38-7836	8	38-7842	10	38-7862
								11	38-7863
								12	38-7861

Graspers

Fig.	Art.-No.	Fig.	Art.-No.	Fig.	Art.-No.	Fig.	Art.-No.	Fig.	Art.-No.	Fig.	Art.-No.
13	38-7816	15	38-7821	17	38-7824	19	38-7826	21	38-7881	23	38-7918
14	38-7820	16	38-7822	18	38-7825	20	38-7827	22	38-7917	24	38-7919
										25	38-7922

Needle Holders

Fig.	Art.-No.	Fig.	Art.-No.	Fig.	Art.-No.	Fig.	Art.-No.
26	38-7799	28	38-7802	30	38-7804	32	38-7805
27	38-7800	29	38-7803	31	38-7806	33	38-7807
						34	38-7823
						35	38-7828
						36	38-7878

Dissecting Forceps

Accessories

Fig.	Art.-No.	Fig.	Art.-No.	Fig.	Art.-No.	Fig.	Art.-No.	Fig.	Art.-No.	Fig.	Art.-No.
37	34-7486	39	34-7484	41	34-7480	43	34-7470	45	34-7494	47	34-7496
38	34-7485	40	34-7475	42	34-7471	44	34-7465	46	34-7495	48	38-7460
										49	38-7850
										50	38-7851

Preliminary version –
Technical changes and design reserved.



ThoraGate™

VATS/Soft-Touch



GEISTER®

Atraumatic Clamps

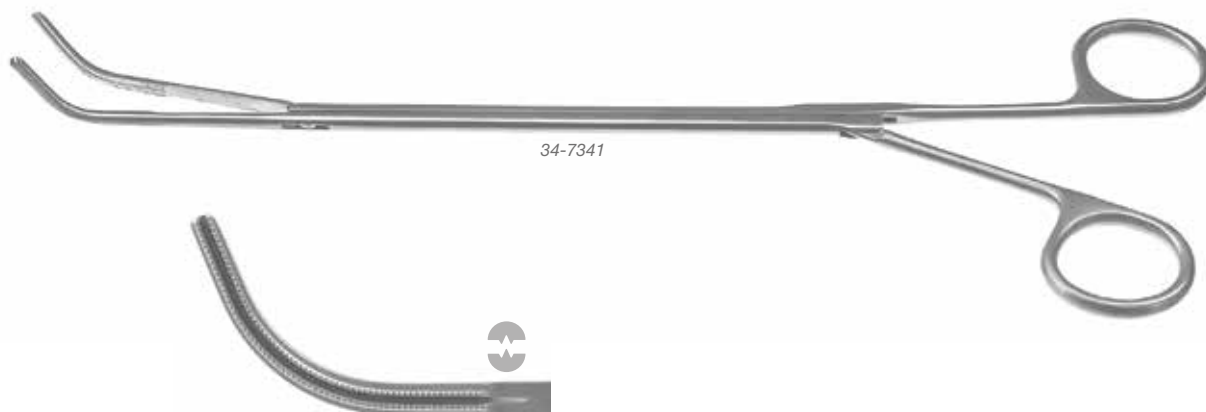

	<u>34-7341</u>	<u>34-7341.SP</u>
Jaw:	strongly curved, 1x2 DeBakey serrations shaft 6,5 mm	shaft 5,0 mm
Ratchet:	without	with
Length:	290 mm	

Needle Holders

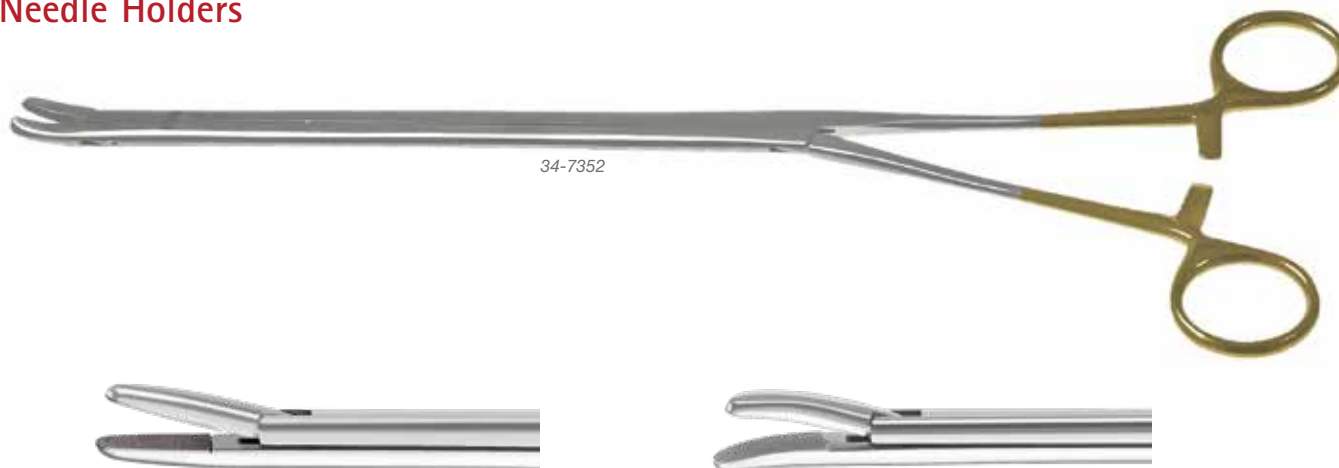

	<u>34-7351</u>	<u>34-7353</u>
Jaw:	TC, straight	delicate
Ratchet:	with	with
Length:	340 mm	290 mm

	<u>34-7352</u>	<u>34-7354</u>
Jaw:	TC, curved	delicate
Ratchet:	with	with
Length:	340 mm	290 mm



Graspers



34-6269



34-6269

34-6269.NC

	acc. Foerster	
Jaw:	17x8 mm, curved small smooth	
Ratchet:	with	without
Length:	365 mm	



34-6270

	acc. Foerster
Jaw:	20x12 mm, curved
Ratchet:	with
Length:	370 mm



34-7330R



34-7330R

	acc. Foerster
Jaw:	7x13 mm, curved
Ratchet:	with
Length:	350 mm



34-7329

	acc. Foerster
Jaw:	20x32 mm, curved
Ratchet:	with
Length:	350 mm

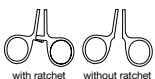

with ratchet without ratchet



Cobra Dissector



34-6268



34-6268

Jaw: 7,5x6 mm, angled
Ratchet: without
Length: 340 mm

Clamps



34-7312



34-7312 **34-7312.SP**

Jaw: serrated
Ratchet: without with
Length: 340 mm



34-7313 **34-7313.SP**

Jaw: acc. DeBakey-Cooley
70/55 mm, 90° curved,
Pusher,
Ratchet: without with
Length: 340 mm

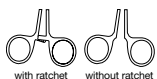

with ratchet without ratchet

Scissors



34-7323

34-7323

Jaw: 55 mm, slightly, curved
Ratchet: without
Length: 360 mm

34-7338

Jaw: 30 mm curved,
Ratchet: without
Length: 290 mm

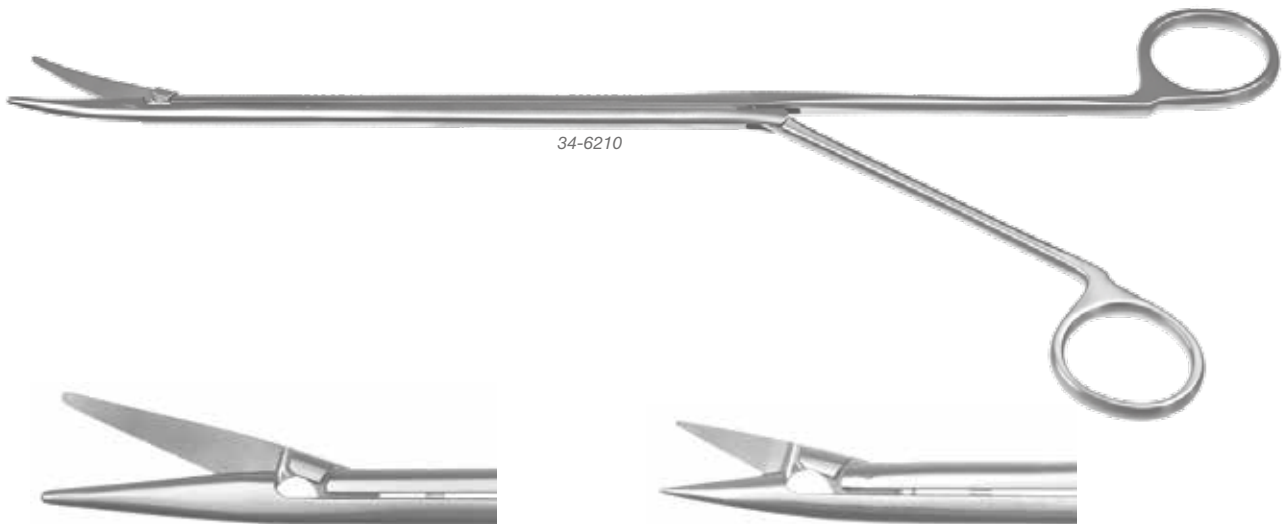

34-6210

34-6210

acc. Metzenbaum
Blade: 35 mm, curved
Ratchet: without
Length: 320 mm

34-6211

acc. Metzenbaum
Blade: 25 mm, curved
Ratchet: without
Length: 305 mm

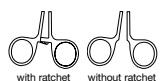

with ratchet without ratchet



Needle Holders



38-7799

acc. **Crile-Wood**
TC, curved with catch



38-7800

TC, with catch



38-7802

TC, curved with catch



38-7803

acc. **Colvin**, TC, curved
with catch short jaw



38-7804

acc. **Crile-Wood**
TC, Micro, with catch



38-7805

TC, Ryder, with catch



38-7806

TC, Mini, curved with
catch



38-7807

TC, Micro, upwards with
catch

Dissecting Graspers



38-7823

acc. **Lange**, with catch,
push to close



38-7828

acc. **Gemini**, smooth,
pushing action



38-7878

Micro, IMA, upwards
0.8 mm with 1x2
mouse-teeth

Accessories



34-7484

Hook, Vessel, blunt

Length: 350 mm



34-7485

Hook, Nerve

Length: 350 mm



34-7486

Hook, Nerve with Ball

Length: 350 mm



34-7475

Catcher, Suture, 1.8 mm

Length: 355 mm



34-7465

Pusher,
for Valve positioning

Length: 350 mm



34-7470

Scalpel, Handle,
for mini-blades

Length: 370 mm



34-7471

Scalpel, Handle
for #11 blades

Length: 350 mm



34-7480

Probe, Magnet

Length: 350 mm



acc. Jamie Dissections



		Ø Hole/Ball	length	
18-0420	straight	1,5 mm	270 mm	with Mandrin
18-0420.01	straight	1,0 mm	270 mm	with Mandrin
18-0420.09	straight	0,5 mm	270 mm	with Mandrin
18-0420.10	straight	1,0 mm	210 mm	with Mandrin
18-0420.02	60° angled	1,0 mm	260 mm	without Mandrin
18-0420.03	90° angled	1,5 mm	270 mm	without Mandrin
18-0420.04	Fino, straight	1,5 mm	290 mm	without Mandrin
18-0420.05	Fino, 30° angled	1,5 mm	290 mm	without Mandrin
18-0420.06	30° angled	0,5 mm	270 mm	with Mandrin
18-0420.11	15° angled	0,5 mm	270 mm	with Mandrin
18-0420.07	30° angled	1,0 mm	270 mm	with Mandrin
18-0420.12	15° angled	1,0 mm	270 mm	with Mandrin
18-0420.08	30° angled	1,0 mm	270 mm	with Mandrin
18-0420.MA	spare part Mandrin			

Suction Tubes

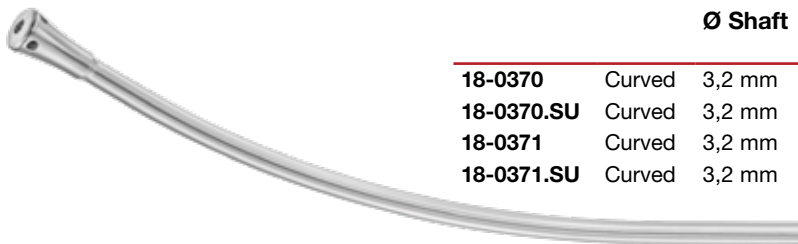
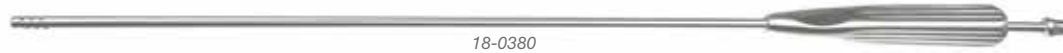

		Ø Shaft	Ø Tip	working length	length	
18-0370	Curved	3,2 mm	6,0 mm	170 mm	310 mm	
18-0370.SU	Curved	3,2 mm	6,0 mm	170 mm	310 mm	variable suction
18-0371	Curved	3,2 mm	6,0 mm	220 mm	360 mm	
18-0371.SU	Curved	3,2 mm	6,0 mm	220 mm	360 mm	variable suction



		Ø Shaft	Ø Tip	working length	length	
18-0375	Curved	5,0 mm	7,5 mm	220 mm	360 mm	
18-0375.SU	Curved	5,0 mm	7,5 mm	220 mm	360 mm	variable suction
18-0376	Curved	5,0 mm	7,5 mm	320 mm	455 mm	
18-0376.SU	Curved	5,0 mm	7,5 mm	320 mm	455 mm	variable suction



		Ø Shaft	working length	length	
18-0380	straight	5,0 mm	320 mm	455 mm	
18-0380.SU	straight	5,0 mm	320 mm	455 mm	variable suction
18-0381	straight	10,0 mm	320 mm	455 mm	
18-0381.SU	straight	10,0 mm	320 mm	455 mm	variable suction

Suction, Cannula



18-0550

18-0550

with control

Length: 340 mm

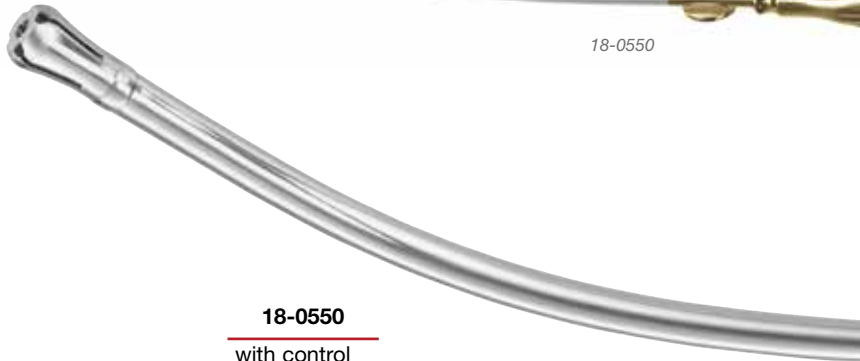

18-0551

without control
large basket

Length: 300 mm

Biopsy, Graspers



25-7100

25-7100

straight

Length: 320 mm



25-7101

curved

Length: 280 mm

GEISTER®

ValveGate™ PRO

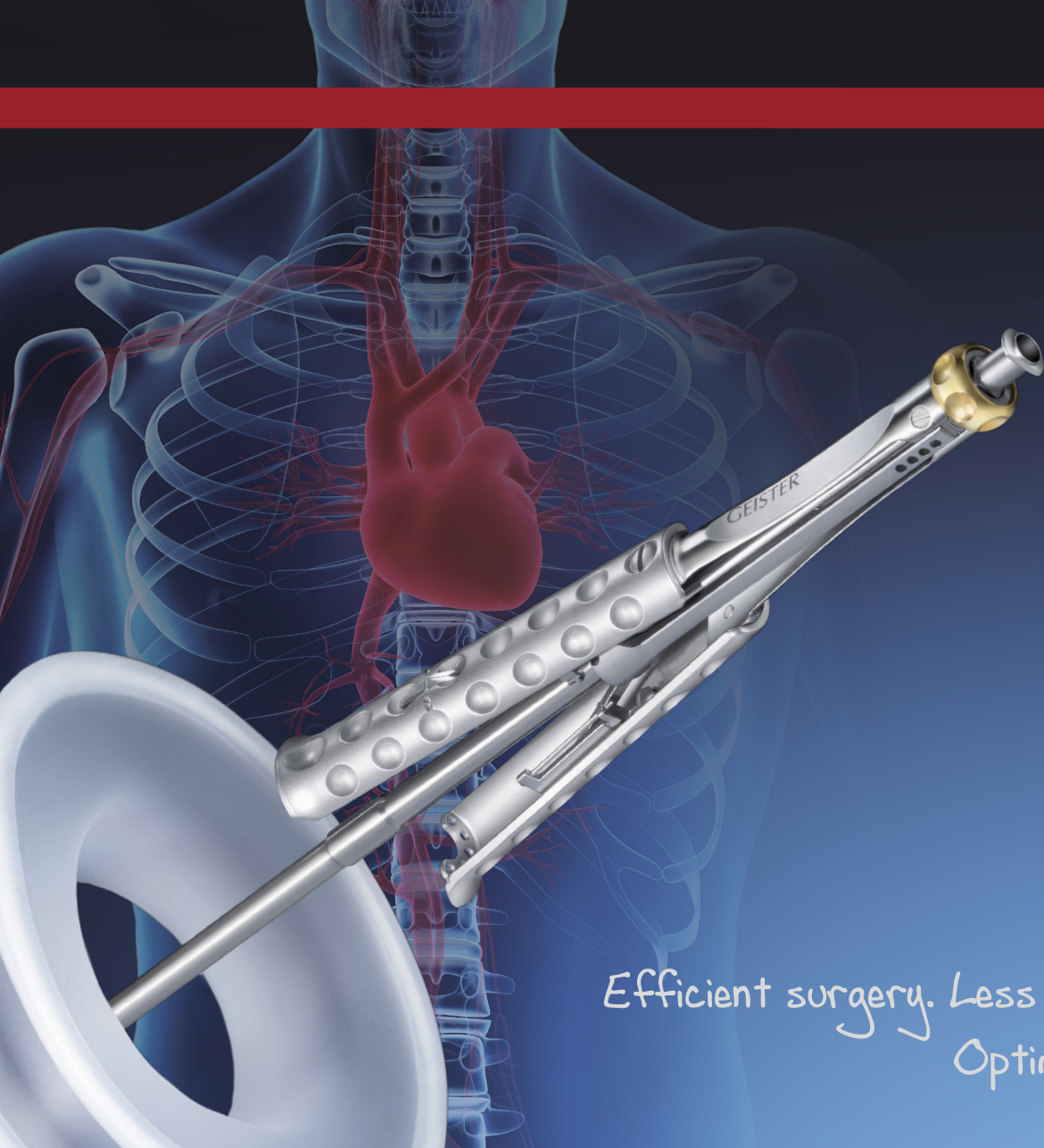

Efficient surgery. Less invasive.
Optimum results.





Wet-Set for transport and storage for ValveGate™ Instruments

Keeps the distal end moist and facilitates the reprocessing. Protects the instrument tip during transport.

- 00-2250 Set: 3 tubes and caps (with hole)
- 00-2251 Set: 20 tubes and caps (with hole)
- 00-2252 Set: 20 tubes and caps (without hole)
- 00-2253 Set: 20 tubes and 10 caps without hole and 10 caps with hole

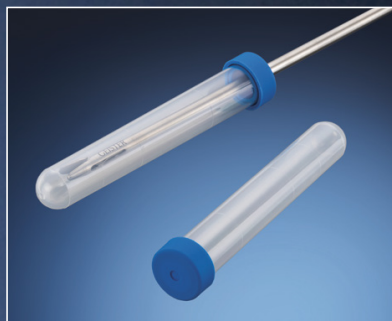

ValveGate™ PRO Needle Holders with ratchet for sutures ±

A	38-7799	TC curved, Crile-Wood	2/0
B	38-7800	TC straight	2/0
C	38-7802	TC curved	2/0
D	38-7803	TC curved, short Colvin jaw	4/0
E	38-7804	TC curved, del., Micro Crile-Wood	6/0
F	38-7806	Mini TC curved, 2.7 mm shaft	6/0
G	38-7805	TC Ryder straight	6/0
H	38-7807	TC angled up	2/0

ValveGate™ PRO Dissecting Forceps

I	38-7823	Lange, Leaflet Grasper, long 28 mm, with ratchet (push to close)
I	38-7823.NC	Lange, Leaflet Grasper, long 28 mm, without ratchet (push to close)
J	38-7828	Gemini Dissecting Forceps, smooth dilating tips 25 mm (push to open)

ValveGate™ PRO Knot Pusher

K	38-7850	push to close
L	38-7851	push to open

ValveGate™ PRO Mini IMA Holding Forceps

M	38-7878	Jaw 0.8x7 mm, upwards, 1x2 teeth, Sapphire™, 3.4 mm shaft
---	---------	---

5 mm shaft diameter, unless otherwise specified. Standard working length 25 cm/10" for minimally invasive valve surgery. For different length add "B", "C", "S", "L" or "XL" behind article number.

B = 12 cm/5" C = 15 cm/6" S = 17 cm/6¾" L = 30 cm/12" XL = 35 cm/14"

Jacobson Scissors

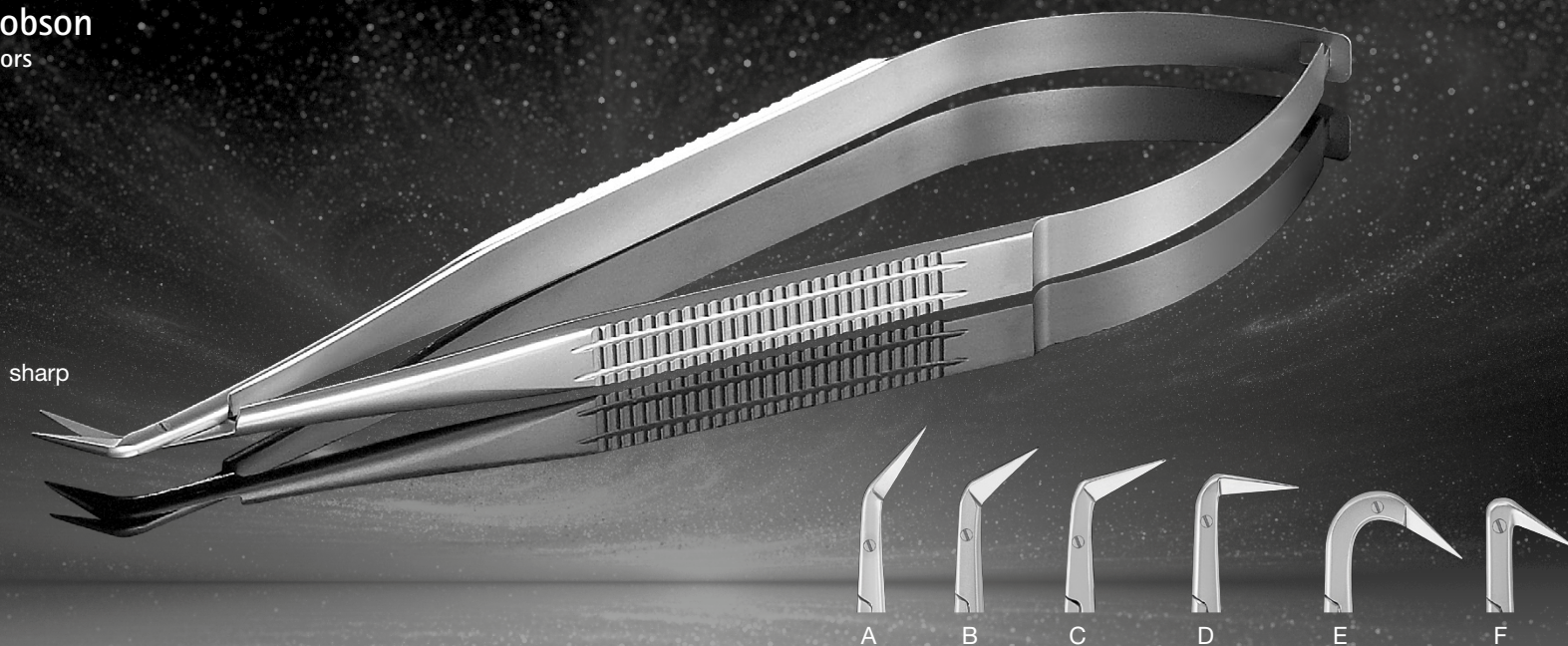

Fig.	✂	Length mm/"	Art.-No. sharp	Art.-No. nano sharp	Length mm/"	Art.-No. sharp	Length mm/"	Art.-No. sharp
A	25°	170/6½	03-0030	03-0030.KS	210/8¼	03-0030.21	230/9	03-0030.23
B	45°	170/6½	03-0032	03-0032.KS	210/8¼	03-0032.21	230/9	03-0032.23
C	60°	170/6½	03-0034	03-0034.KS	210/8¼	03-0034.21	230/9	03-0034.23
D	90°	170/6½	03-0036	03-0036.KS	210/8¼	03-0036.21	230/9	03-0036.23
E	125°	170/6½	03-0038	—	210/8¼	03-0038.21	230/9	03-0038.23
F	125°	170/6½	03-0038V	03-0038.KS	210/8¼	03-0038.21V	—	—

Standard blade length 10mm. For shorter 7mm blade add "KS" behind Art.-No. for ordering.