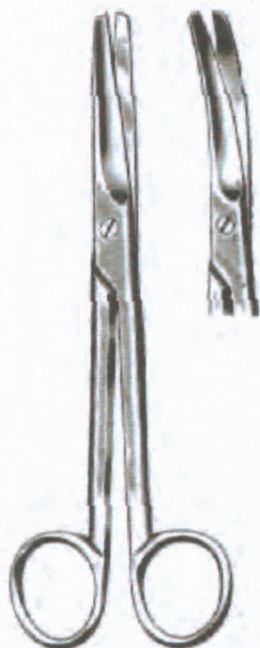


Präparierscheren
 Dissecting Scissors
 Tijeras de disección
 Forbici per dissezione



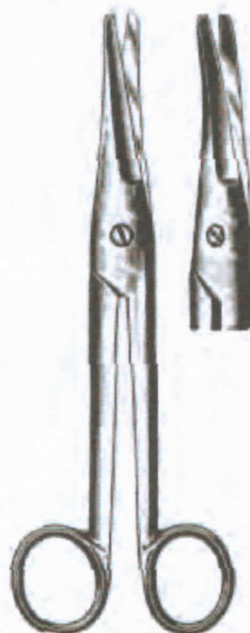
MAYO

09160-14	14,5 cm, 5 $\frac{1}{4}$ "	09161-14
09164-14 TC	14,5 cm, 5 $\frac{1}{4}$ "	09165-14 TC
09160-15	15 cm, 6"	09161-15
09160-17	17,0 cm, 6 $\frac{3}{4}$ "	09161-17
09164-17 TC	17,0 cm, 6 $\frac{3}{4}$ "	09165-17 TC
09160-19	19,0 cm, 7 $\frac{1}{2}$ "	09161-19
09160-23	23,0 cm, 9"	09161-23
09164-23 TC	23,0 cm, 9"	09165-23 TC
09160-28	28,0 cm, 11"	09161-28



MAYO-STILLE

09170-15	15,0 cm, 6"	09171-15
09174-15 TC	15,0 cm, 6"	09175-15 TC
09170-17	17,0 cm, 6 $\frac{3}{4}$ "	09171-17
09174-17 TC	17,0 cm, 6 $\frac{3}{4}$ "	09175-17 TC
09170-21	21,0 cm, 8 $\frac{1}{4}$ "	09171-21
09174-21 TC	21,0 cm, 8 $\frac{1}{4}$ "	09175-21 TC



MAYO-NOBLE

09180-17	17,0 cm, 6 $\frac{3}{4}$ "	09181-17
----------	----------------------------	----------

Präparierscheren
Dissecting Scissors
Tijeras de disección
Forbici per dissezione



METZENBAUM

09280-12	09284-12 TC
12 cm, 4¾"	
09280-15	09284-15 TC
15 cm, 6"	
09280-18	09284-18 TC
18 cm, 7"	
09280-20	09284-20 TC
20 cm, 8"	
09280-23	09284-23 TC
23 cm, 9"	
09280-25	09284-25 TC
25 cm, 10"	
09280-28	09284-28 TC
28 cm, 11"	
09280-30	09284-30 TC
30 cm, 12"	



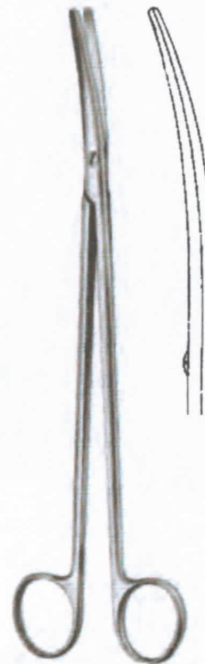
METZENBAUM

09281-12	09285-12 TC
12 cm, 4¾"	
09281-15	09285-15 TC
15 cm, 6"	
09281-18	09285-18 TC
18 cm, 7"	
09281-20	09285-20 TC
20 cm, 8"	
09281-23	09285-23 TC
23 cm, 9"	
09281-25	09285-25 TC
25 cm, 10"	
09281-28	09285-28 TC
28 cm, 11"	
09281-30	09285-30 TC
30 cm, 12"	



METZENBAUM FINO

09282-15	09286-15 TC
15 cm, 6"	
09282-18	09286-18 TC
18 cm, 7"	
09282-20	09286-20 TC
20 cm, 8"	
09282-23	09286-23 TC
23 cm, 9"	
09282-25	09286-25 TC
25 cm, 10"	
09282-28	09286-28 TC
28 cm, 11"	



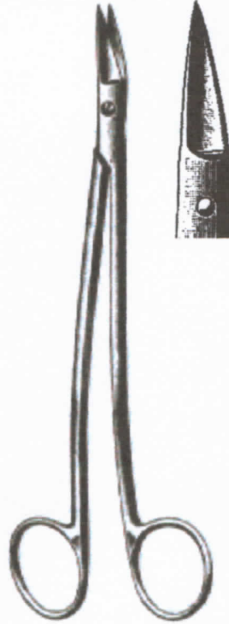
METZENBAUM FINO

09283-15	09287-15 TC
15 cm, 6"	
09283-18	09287-18 TC
18 cm, 7"	
09283-20	09287-20 TC
20 cm, 8"	
09283-23	09287-23 TC
23 cm, 9"	
09283-25	09287-25 TC
25 cm, 10"	
09283-28	09287-28 TC
28 cm, 11"	

Tonsillen-, Gefäßscheren
 Tonsil, Vascular Scissors
 Tijeras amígdalas y vasculares
 Forbici per tonsilli e vascolari



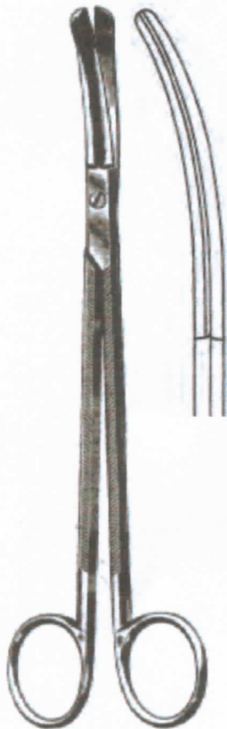
COTTLE
 09405-16
09406-16 TC
 16 cm, 6 $\frac{1}{4}$ "



DEAN
 09425-17 09427-17
 17 cm, 6 $\frac{3}{4}$ "



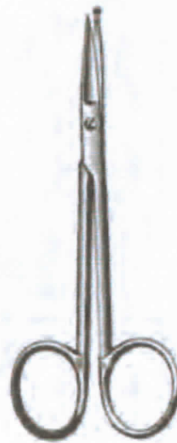
BOETTCHER
 09435-18
 18 cm, 7"



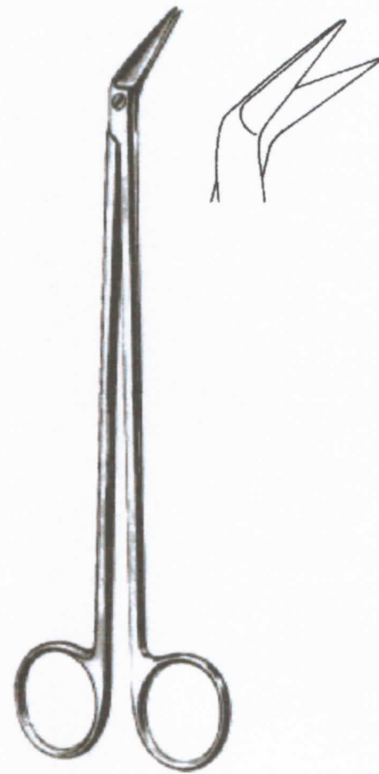
GOOD
 09437-19
 19 cm, 7 $\frac{1}{2}$ "



PRINCE
 09439-17
 17 cm, 6 $\frac{3}{4}$ "



09470-11
 11 cm, 4 $\frac{1}{8}$ "

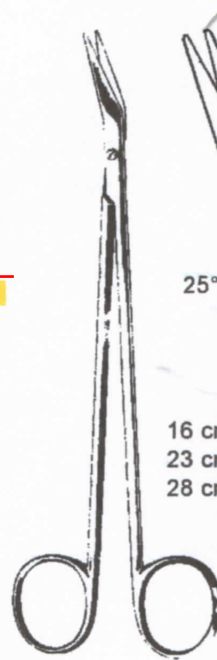
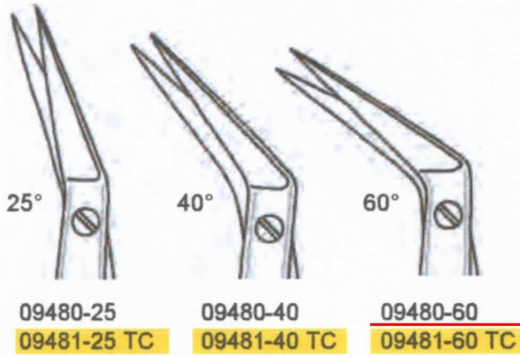


POTTS-DE MARTEL
 09473-21
 21 cm, 8 $\frac{1}{4}$ "

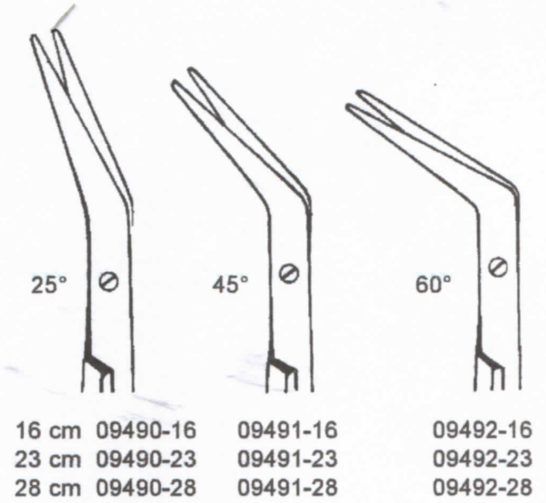
Gefäßscheren
Vascular Scissors
Tijeras vasculares
Forbici vascolari



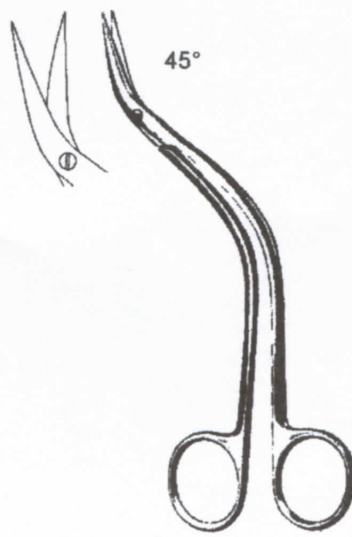
POTTS-SMITH
19 cm, 7½"



DE BAKEY



FAVALORO
09496-15 15 cm, 6"



DE BAKEY
09497-15 15,5 cm, 6"



KELLY
09540-16 09541-16
09542-16 TC 09543-16 TC
16 cm, 6¼"

Ultra-Light-Pinzetten
Ultra-Light-Forceps
Pinzas-Ultra-Ligera
Pinza-ultra-leggera

1,5 mm

1,2 mm

1,5 mm

1,5 mm



12110-15
15 cm, 6"



12110-20
18 cm, 7"



12110-24
24 cm, 9½"



12110-30
30 cm, 11¼"

Atraumatische Pinzetten
Atraumatic Tissue Forceps
Pinzas atraumáticas
Pinze atraumatiche



DE BAKEY
12302-16 16 cm, 6¼"
12302-20 18 cm, 7"
12302-24 24 cm, 9½"



DE BAKEY
12306-16 16 cm, 6¼"
12306-20 18 cm, 7"
12306-24 24 cm, 9½"
12306-30 30 cm, 11¾"



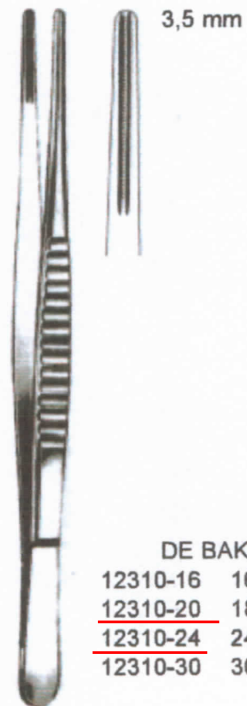
DE BAKEY
12308-16 16 cm, 6¼"
12308-20 18 cm, 7"
12308-24 24 cm, 9½"
12308-30 30 cm, 11¾"



DE BAKEY
12309-16 16 cm, 6¼"
12309-20 18 cm, 7"
12309-24 24 cm, 9½"
12309-30 30 cm, 11¾"



DE BAKEY
12304-16 16 cm, 6¼"
12304-20 18 cm, 7"
12304-24 24 cm, 9½"
12304-30 30 cm, 11¾"

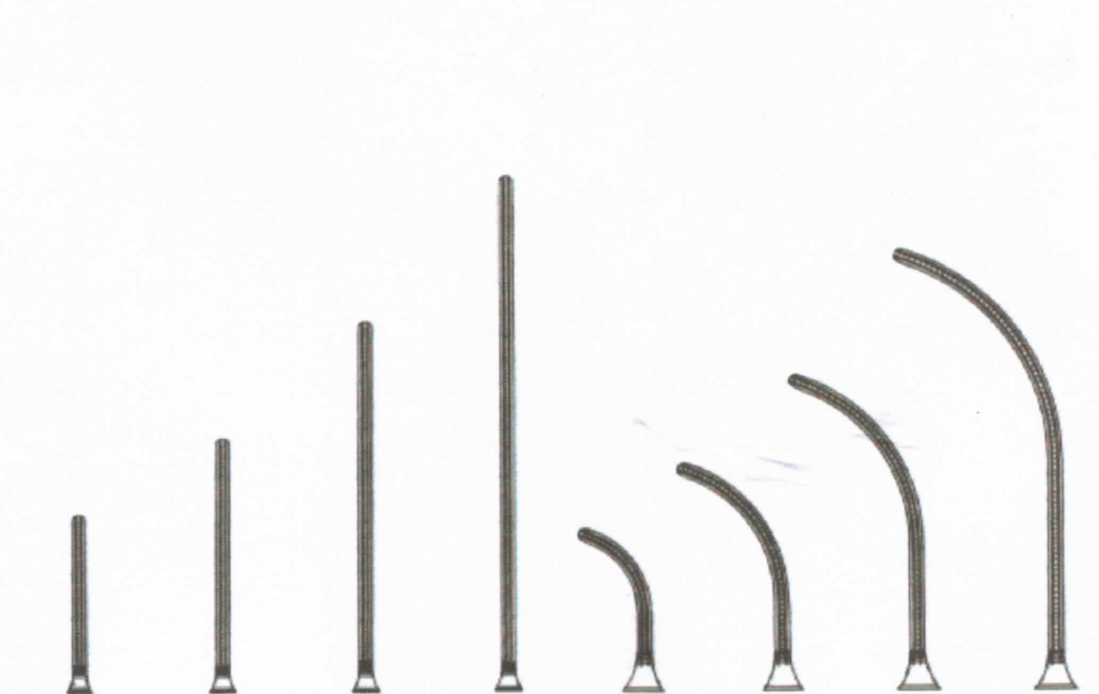


DE BAKEY
12310-16 16 cm, 6¼"
12310-20 18 cm, 7"
12310-24 24 cm, 9½"
12310-30 30 cm, 11¾"

Atrauma-Bulldogklemmen
Atrauma Bulldog Clamps
 Clamps Atrauma Bulldog
 Pinze Atrauma Bulldog



DE BAKEY



13092-07	13092-08	13092-10	13092-12	13093-07	13093-08	13093-10	13093-12
7,5 cm	8,5 cm	10,5 cm	12 cm	7 cm	8 cm	10 cm	11,5 cm
3"	3.4"	4"	4 3/4"	2 3/4"	8 1/8"	4"	4 1/2"



GLOVER



13096-06	13096-07	13096-09	13096-11	13097-06	13097-07	13097-09	13097-11
6 cm	7 cm	9 cm	11 cm	5,5 cm	6,5 cm	8,5 cm	10,5 cm
2 1/4"	2 3/4"	3 1/2"	4 3/8"	2"	2 1/2"	3 1/4"	4"

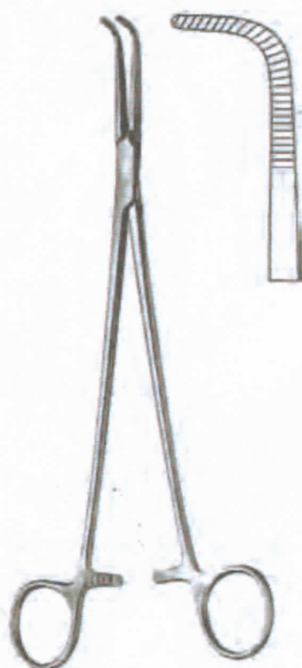
Arterienklemmen
Hemostatic Forceps
Pinzas hemostáticas
Pinze emostatiche



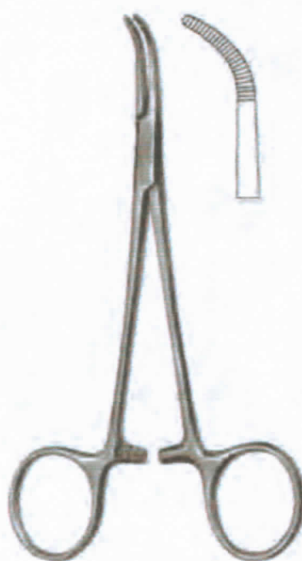
MIXTER
13471-14 14 cm, 5 ½"
13471-16 16 cm, 6 ¼"
13471-18 18 cm, 7"
13471-23 23 cm, 9"



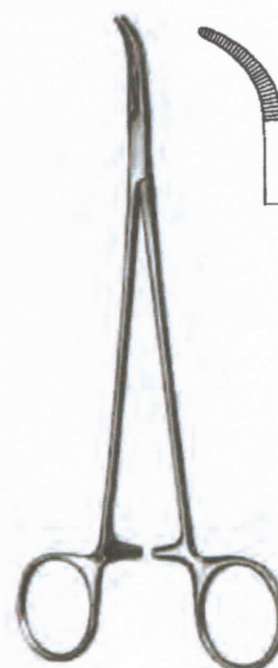
MIXTER
13473-22
22 cm, 8 ¾"



KANTROWITZ
13474-19 19 cm, 7 ½"
13474-24 24 cm, 9 ½"
13474-26 26 cm, 10 ¼"

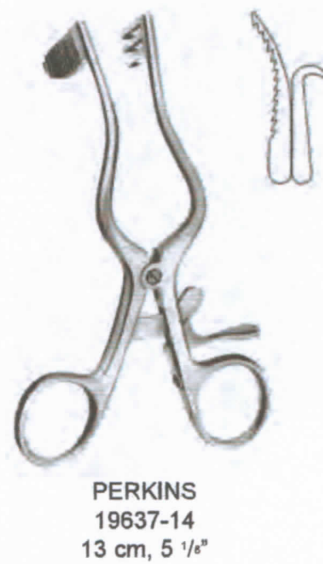
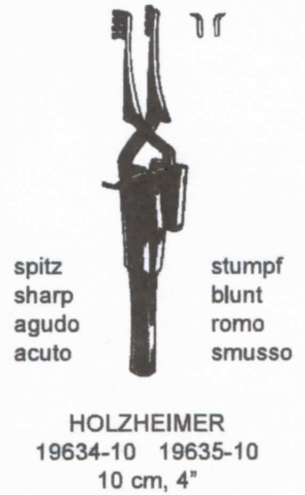
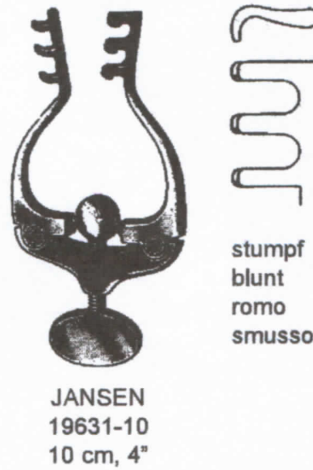
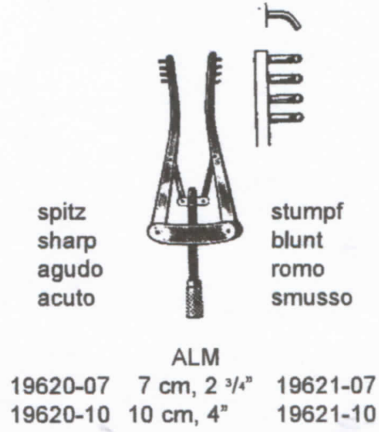
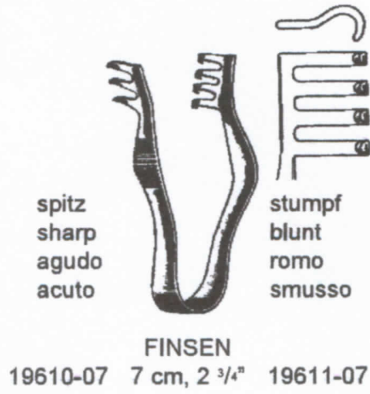


MIXTER BABY
13475-14
14 cm, 5 ½"

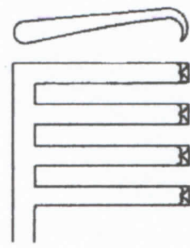
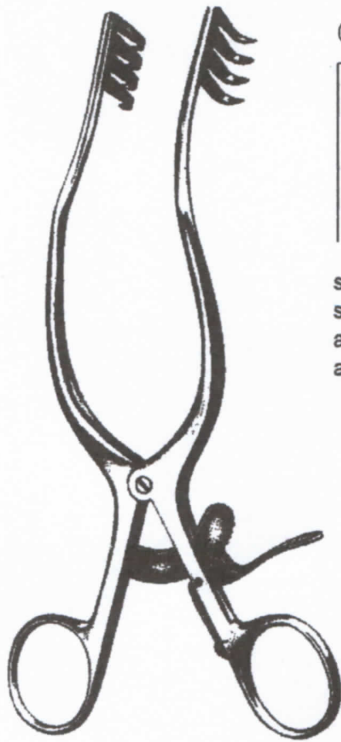


MIXTER BABY
13475-18
18 cm, 7"

Wundsperrer, Kieferhöhlensperrer
 Retractors, Antrum Retractor
 Separadores, Separadores para seno maxilar
 Divaricatori, Divaricatori per seno mascellare



Wundsperrer
Retractors
Separadores
Divaricatori



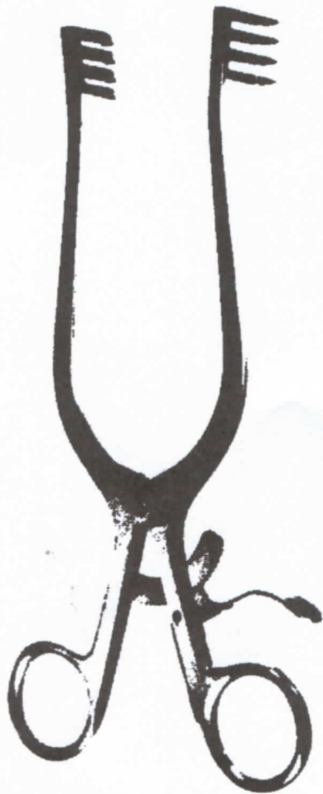
spitz
sharp
agudo
acuto

ANDERSON ADSON
19679-20 19,5 cm, 7 3/4"



stumpf
blunt
romo
smusso

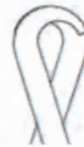
NORFOLK / NORWICH
19679-22 22 cm, 8 3/4"



spitz
sharp
agudo
acuto

ADSON
19680-19 19 cm, 7 1/2" 19681-19

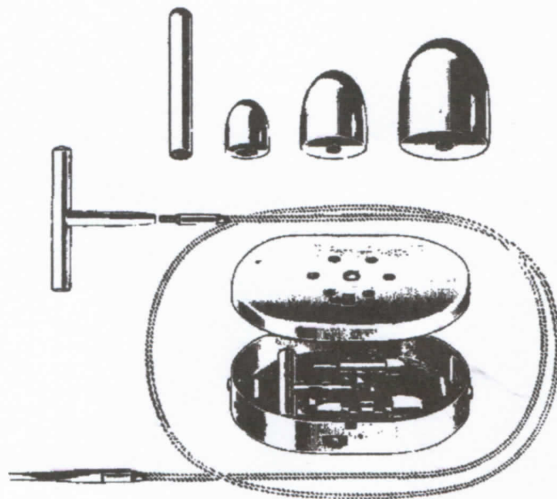
stumpf
blunt
romo
smusso



stumpf
blunt
romo
smusso

TRAVERS
19681-21 21,5 cm, 8 1/2"

Krampfader-Besteck in Metalletui
 Varicose vein probe set in metal case
 Juego para várices en estuche de metal
 Astuccio per varici in scatola di metallo



NABATOFF
 21150-00
 135x100x25 mm
 compl.

21150-02
 Sondenspitze
 Probe Tip
 Puntas sueltas
 Punte



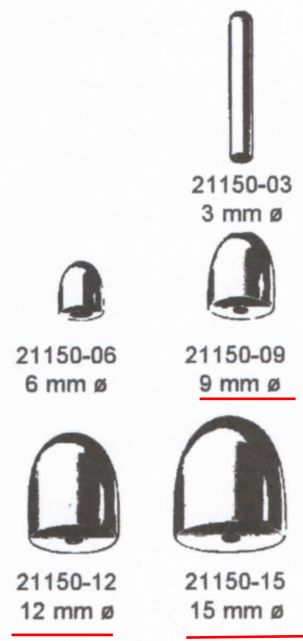
21150-90

Zugseil
 cable flexible
 cable de traccion flex.
 Corda di trazione fless.

21150-80
 Handgriff
 Handle only
 Mango suelto
 Manico solo



Oliven
 Olives
 Olivas
 Olivas



21150-03
 3 mm ø

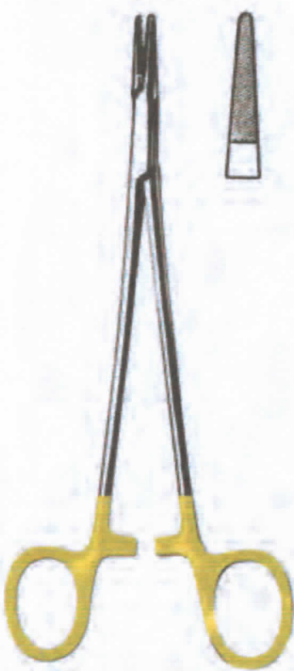
21150-06
 6 mm ø

21150-09
 9 mm ø

21150-12
 12 mm ø

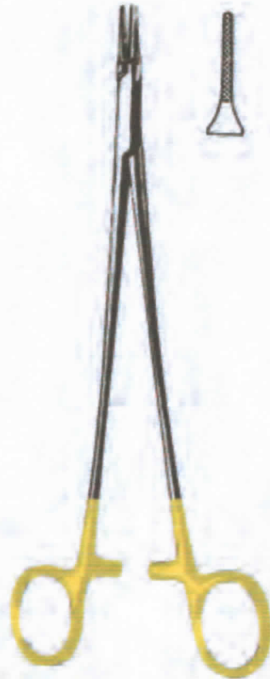
21150-15
 15 mm ø

Nadelhalter
Needle Holders
Porta-agujas
Port'aghi



DE BAKERY

25214-16 TC	16 cm, 6 ¹ / ₄ "
25214-18 TC	18 cm, 7"
25214-20 TC	20 cm, 8"
25214-23 TC	23 cm, 9"
25214-26 TC	26 cm, 10 ¹ / ₄ "
25214-31 TC	31 cm, 12 ¹ / ₄ "

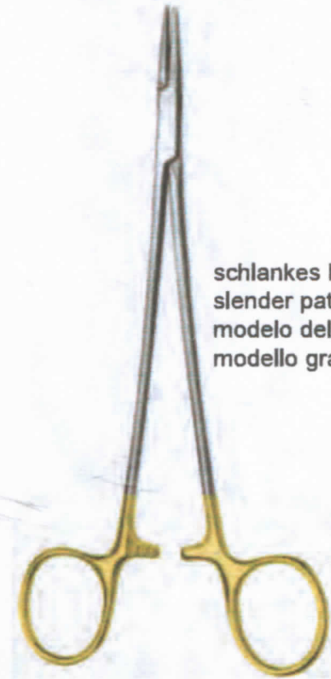


RYDER 1 mm

25224-13 TC	13 cm, 5 ¹ / ₈ "
25224-15 TC	15 cm, 6"
25224-18 TC	18 cm, 7"
25224-20 TC	20 cm, 8"
25224-23 TC	23 cm, 9"
25224-26 TC	26 cm, 10 ¹ / ₄ "

RYDER 2 mm

25225-13 TC	
25225-15 TC	
25225-18 TC	
25225-20 TC	
25225-23 TC	
25225-26 TC	



schlankes Modell
slender pattern
modelo delgado
modello gracile

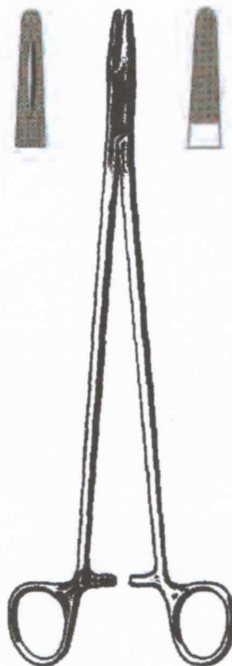
MICROVASCULAR

25230-18 TC	18 cm, 7"
25230-20 TC	20 cm, 8"
25230-23 TC	23 cm, 9"



HEANEY

25241-21	21 cm, 8 ¹ / ₄ "
25241-26	26 cm, 10 ¹ / ₄ "
25245-21 TC	21 cm, 8 ¹ / ₄ "
25245-26 TC	26 cm, 10 ¹ / ₄ "



MASSON

25250-27	27 cm, 10 ¹ / ₂ "
25254-27 TC	27 cm, 10 ¹ / ₂ "



WANGENSTEEN

25260-27	27 cm, 10 ¹ / ₂ "
25264-27 TC	27 cm, 10 ¹ / ₂ "

Nadelhalter
Needle Holders
Porta-agujas
Port'aghi



25670-14
glatt
smooth
lisa
liscia



25672-14
gerieft
serrated
estriada
zigrinato



25676-14 TC



25671-14
glatt
smooth
lisa
liscia



25673-14
gerieft
serrated
estriada
zigrinato



25677-14 TC

JACOBSEN

- 25667-18 18 cm, 7"
- 25668-18 TC 18 cm, 7"
- 25667-21 21 cm, 8 1/4"
- 25668-21 TC 21 cm, 8 1/4"

CASTROVIEJO

14 cm, 5 1/2"



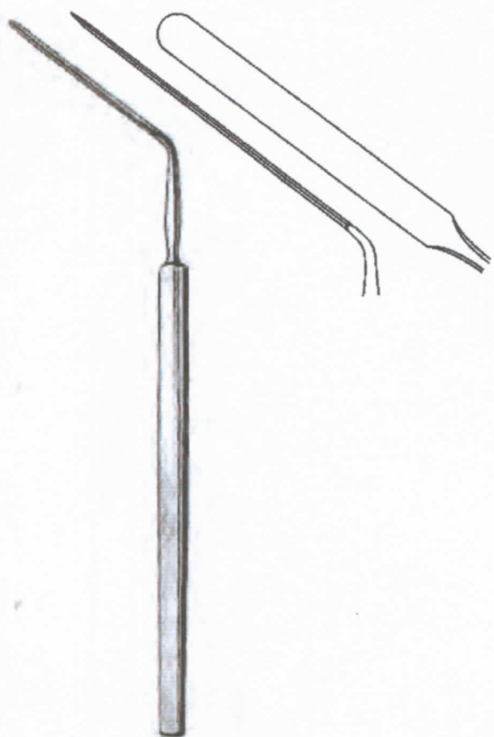
CASTROVIEJO-MICRO
9 cm, 3 1/2"



CASTROVIEJO

- 25680-13 13 cm, 5 1/8"
- 25684-13 TC 13 cm, 5 1/8"

Dura Dissektoren
Dura Dissectors
Elevadores
Scollatori



HORSLEY
41155-20
20 cm, 8"



WOODSON
41156-18
18 cm, 7"



FRAZIER
41158-01
15 cm, 6"



HOEN
41158-02
15 cm, 6"



HOEN
41158-03
15 cm, 6"



PENFIELD
41161-01
17,5 cm, 6,9"



PENFIELD
41161-02
19,5 cm, 7 3/4"



PENFIELD
41161-03
19,5 cm, 7 3/4"



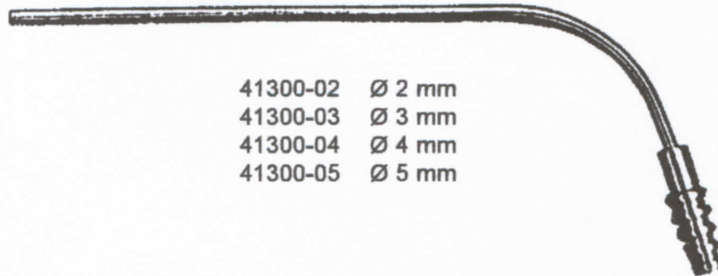
PENFIELD
41161-04
21,5 cm, 8 1/2"



PENFIELD
41161-05
29 cm, 11,4"

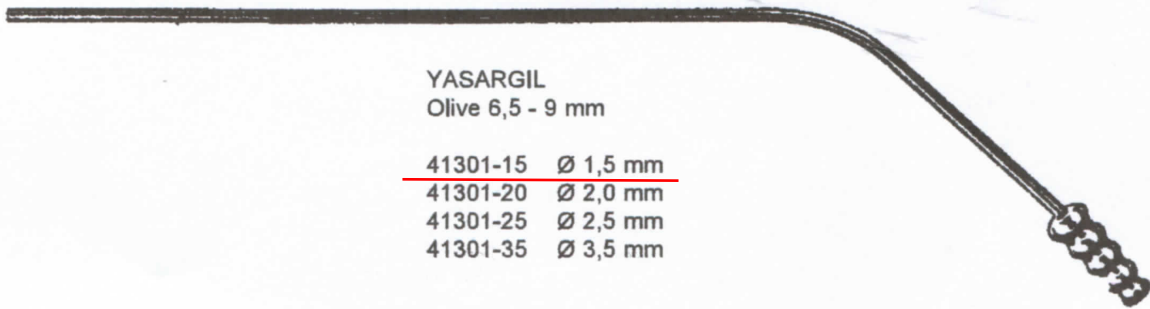
Saugrohre
Suction Tubes
Tubos de aspiración
Tubi aspirazioni

11 cm, 4,4"



41300-02 Ø 2 mm
41300-03 Ø 3 mm
41300-04 Ø 4 mm
41300-05 Ø 5 mm

15 cm, 6"



YASARGIL
Olive 6,5 - 9 mm

41301-15 Ø 1,5 mm
41301-20 Ø 2,0 mm
41301-25 Ø 2,5 mm
41301-35 Ø 3,5 mm



ZÖLLNER
41302-02



0,5 mm Ø 41306-05
0,7 mm Ø 41306-07
0,9 mm Ø 41306-09
1,2 mm Ø 41306-12

Kanüle für Sauggriff für ZÖLLNER und WULLSTEIN
Tip for Suction Handle for ZÖLLNER and WULLSTEIN
Cánula para mango t ZÖLLNER y WULLSTEIN
Cannula per manico di aspirazione t ZÖLLNER e WULLSTEIN

Iris Pinzetten
 Iris Forceps
 Pinzas para iris
 Pinze per iride



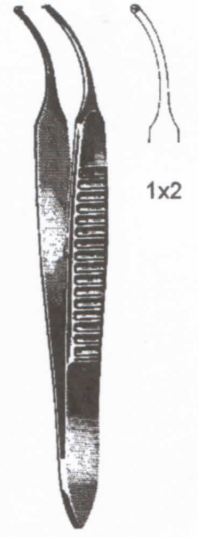
GRAEFE
 43802-07
 7 cm (2 3/4")/1 mm



GRAEFE
 43803-07
 7 cm (2 3/4")/1 mm



GRAEFE
 43804-07
 7 cm (2 3/4")/1 mm



GRAEFE
 43805-07
 7 cm (2 3/4")/1 mm



GRAEFE
 43810-10
 10 cm
 4"



GRAEFE
 43811-10
 10 cm
 4"



GRAEFE
 43813-10
 10 cm
 4"



GRAEFE
 43820-10
 10 cm
 4"



GRAEFE
 43821-10
 10 cm
 4"



GRAEFE
 43823-10
 10 cm
 4"

1x2

1x2

1x2

Löffel, Schlingen, Häkchen
 Ear spoons, Loops, Hooklets
 Cucharas, Asas, Ganchitos
 Cucchiai, Anse, Uncinetti



GROSS
 45171-12
 12 cm, 4 3/4"



BILLEAU
 16 cm, 6 1/4"



45180-01



45180-02



45180-03



LANGENBECK
 45181-13
 13 cm, 5 1/8"



ZAUFAL
 45184-16
 16 cm, 6 1/4"



ZAUFAL-JANSEN
 45185-15
 15 cm, 6"



DAY
 16 cm, 6 1/4"



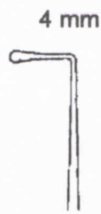
45190-01



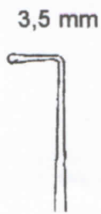
45190-02



WAGENER
 14 cm, 5 1/2"



45192-01



45192-02



45192-03



45192-04



45192-05



45192-06



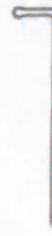
LUCAE
 14 cm, 5 1/2"



45193-01
 2 mm



45193-02
 3 mm

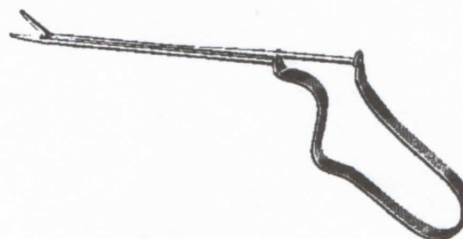


45193-03
 4 mm

Fremdkörperheber, Fremdkörperzängchen
 Foreign Body Levers, Ear Polypus Forceps
 Elevadores para cuerpos extraños, Pinzas para pólipos
 Leve per corpi estranei, Pinze per polipi



QUIRE
 45251-10
 10 cm, 4"



BUCK
 45253-11
 11 cm, 4 3/8"



45255-08 - 45275-08



HARTMANN-WULLSTEIN
 45255-08
 8,5 cm, 3.4"



○ 1 mm Ø
 HARTMANN-WULLSTEIN
 45257-08
 8,5 cm, 3.4"



HARTMANN
 45261-08 8,5 cm, 3.4"
 45261-14 14,0 cm, 5 1/2"
 45261-16 16,0 cm, 6 1/4"



HARTMANN
 45263-08 8,5 cm, 3.4"
 45263-14 14,0 cm, 5 1/2"



HARTMANN
45265-08
 8,5 cm, 3.4"



Ø mm HARTMANN
 2,0 45267-20 8,5 cm, 3.4"
 2,5 45267-25 8,5 cm, 3.4"
 3,0 45267-30 8,5 cm, 3.4"



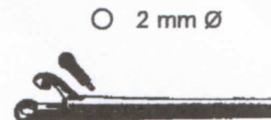
○ 3 mm Ø
 HARTMANN
 45269-30
 8,5 cm, 3.4"



STRUEMPEL
 45271-08 8,5 cm, 3.4"
 2,5x5 mm

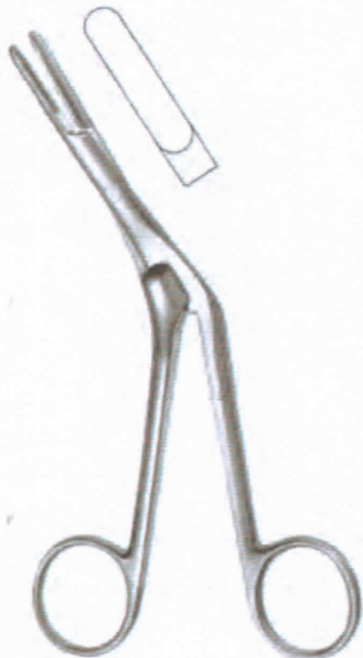


HARTMANN
45273-08
 8,5 cm, 3.4"

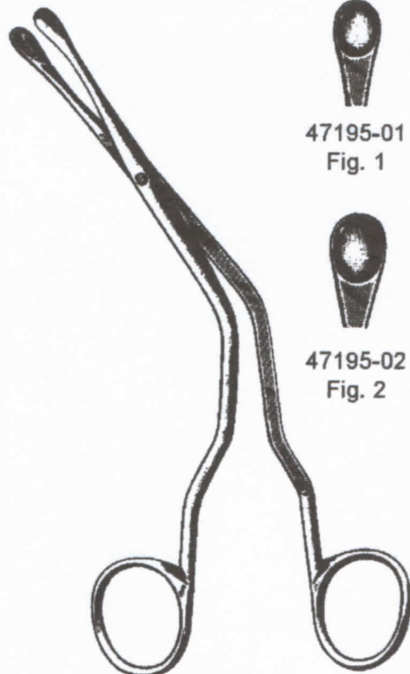


○ 2 mm Ø
 HARTMANN-HOFFMANN
 45275-08
 8,5 cm, 3.4"

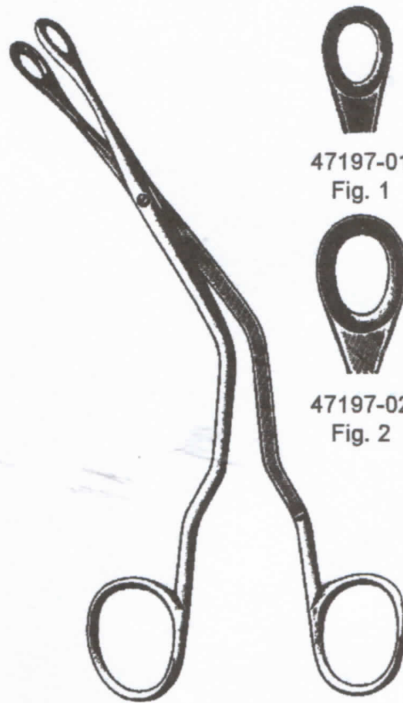
Scharfe Nasenzangen, Septumzangen
 Nasal Cutting Forceps, Septum Forceps
 Pinzas cortantes nasales y para el tabique nasal
 Pinze taglianti nasali, Pinze per il setto nasale



CRAIG
 47192-18
 18 cm, 7"



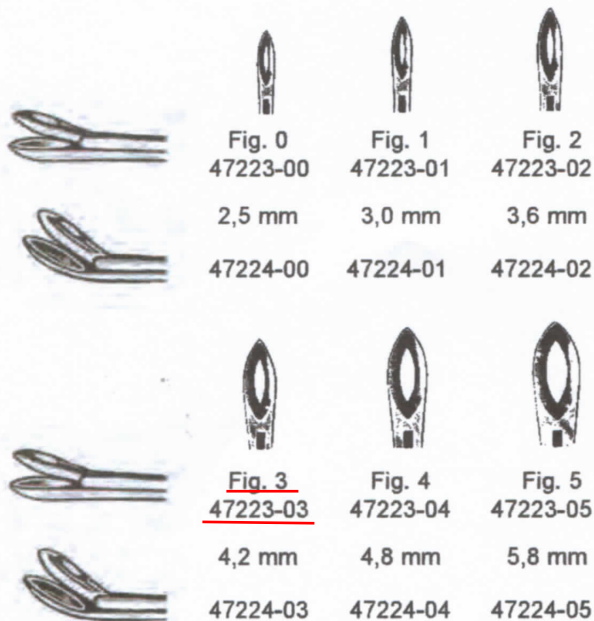
LUC
 47195-01 - 47195-02
 19 cm, 7 1/2"



LUC
 47197-01 - 47197-02
 19 cm, 7 1/2"

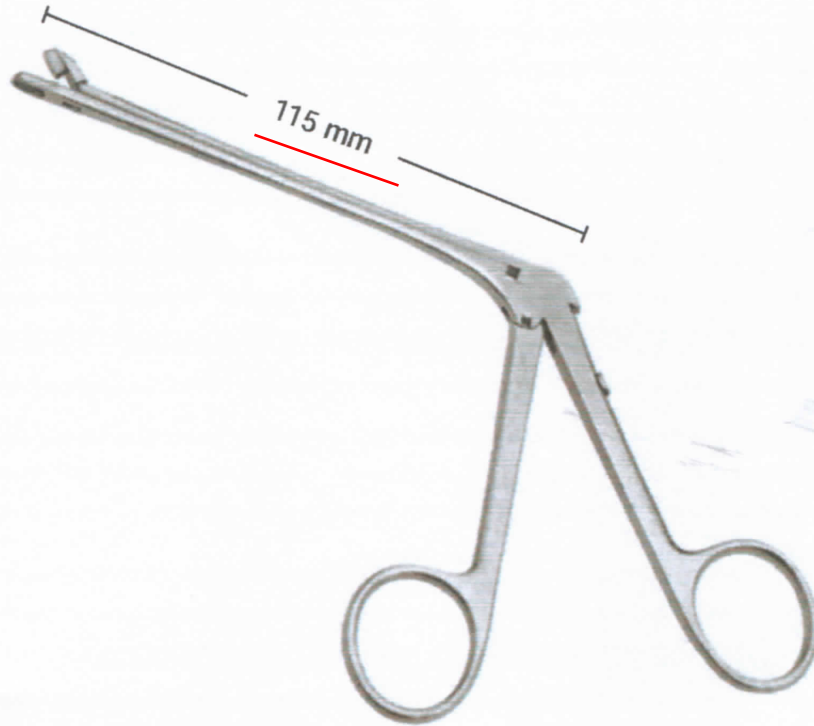


Fig. 1	Fig. 2
47223-01	<u>47223-02</u>
3,0 mm	3,6 mm



WEIL-BLAKESLEY
 47223-01 - 47224-05

Scharfe Nasenzangen, durchschneidend
 Nasal Cutting Forceps
 Pinzas nasales cortantes



gerade
 straight
 recta



47230-00
 2,7 x 6,8 mm



47230-01
 3 x 7,7 mm

aufgewinkelt
 angled up
 angulada hacia arriba



47230-02
 2,2 x 6,5 mm



47230-03
 2,6 x 6,5 mm



47230-04
 3 x 6,5 mm

fein, gerade
 delicate, straight
 fina, recta



47230-05
 1,4 x 5 mm

fein, aufgewinkelt
 delicate, angled up
 fina, angulada hacia arriba



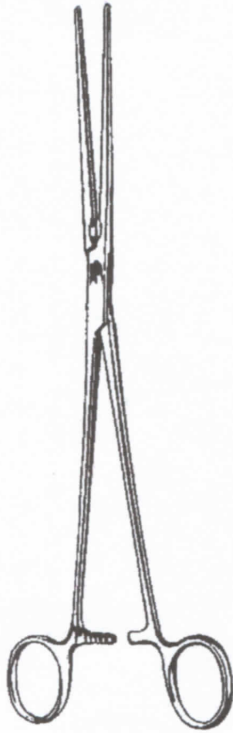
47230-06
 1,4 x 4 mm

Aorta-Aneurysmaklemmen
 Aortic aneurysm clamps
 Pinzas-clamps para aneurisma de la aorta
 Pinze per aneurisma aorta



Atrauma

Mehrzweck-Gefäßklemme
 Multi purpose Vascular Clamps
 Pinzas vasculares de usos multiples
 Pinze vascolari universali



DE BAKEY
 61034-21 - 61034-31



53 mm
 61034-21
 21,5 cm
 8 1/2"



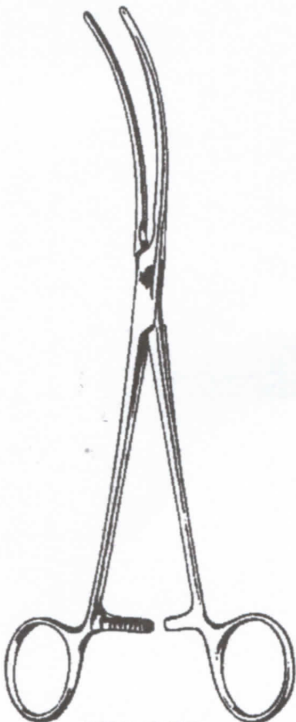
68 mm
 61034-23
 23 cm
 9"



75 mm
 61034-27
 27 cm
 10 1/2"



112 mm
 61034-31
 31,5 cm
 12 1/2"



DE BAKEY
 61035-21 - 61035-31



60 mm
 61035-21
 21,5 cm
 8 1/2"



77 mm
 61035-23
 23 cm
 9"

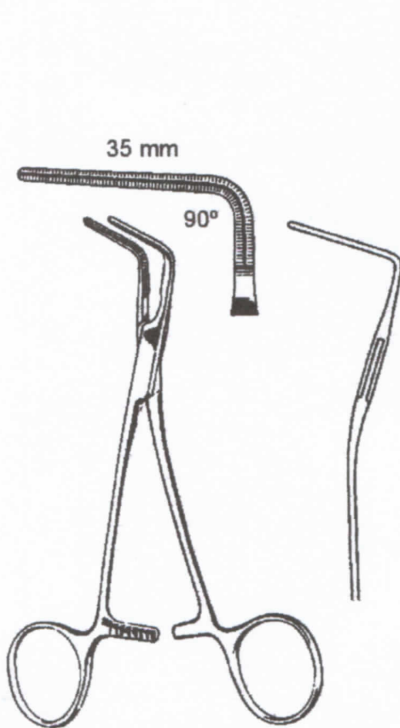


89 mm
 61035-27
 27 cm
 10 1/2"

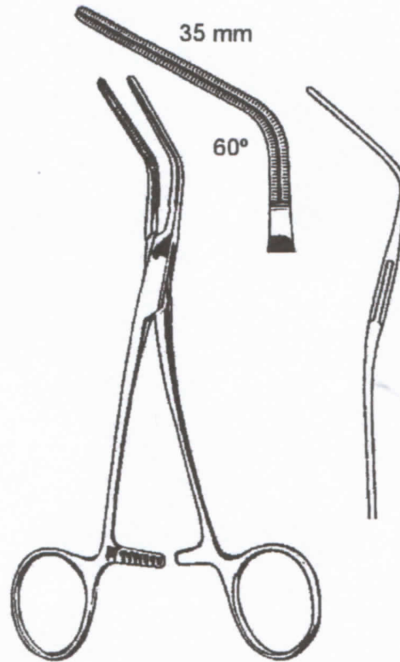


111 mm
 61035-31
 31 cm
 12 1/4"

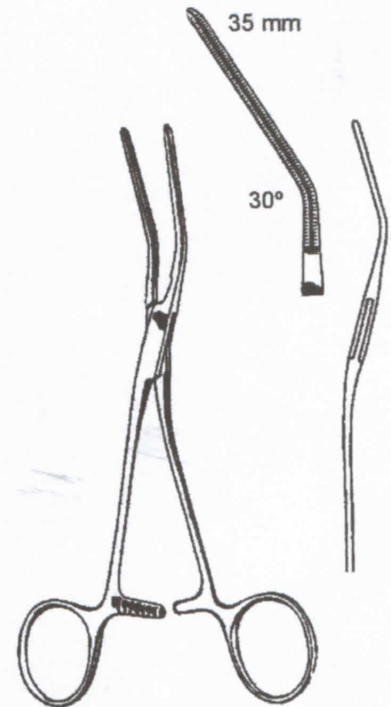
Mehrzweck-Gefäßklemmen
 Multi purpose Vascular Clamps
 Pinzas vasculares de usos múltiples
 Pinze vascolari universali



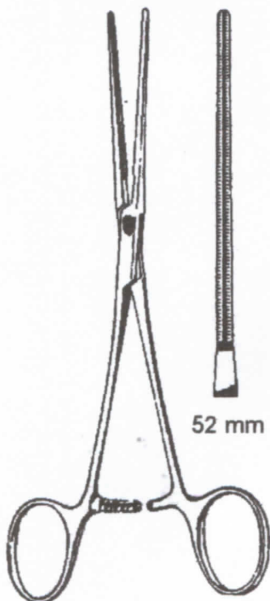
COOLEY
 61172-15
 15 cm, 6"



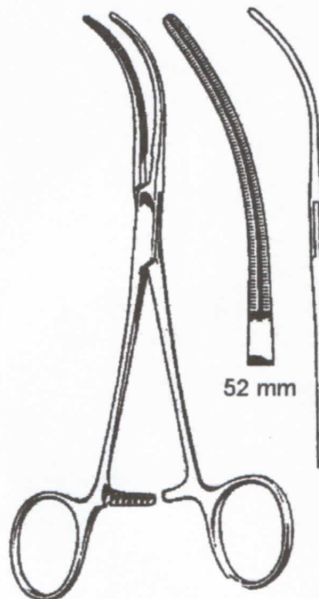
COOLEY
 61173-16
 15,5 cm, 6"



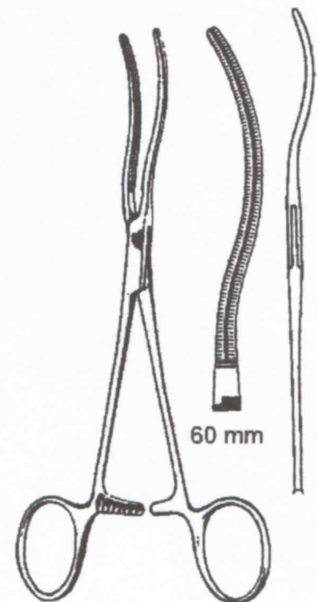
COOLEY
 61174-17
 17 cm, 6 3/4"



COOLEY
 61175-17
 17 cm, 6 3/4"

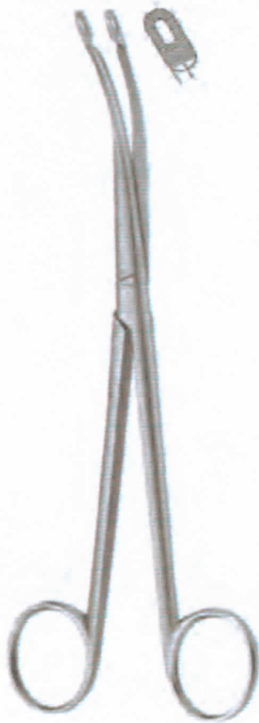


COOLEY
 61176-17
 17 cm, 6 3/4"



COOLEY
 61177-17
 17 cm, 6 3/4"

Nierensteinzange
Kidney Stone Forceps
Pinzas para cálculos renales
Pinze per calcoli renali

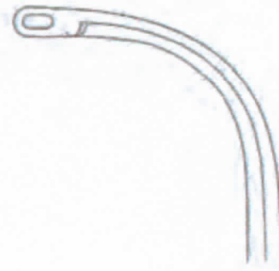


HEIMING

für Kinder
for children
para niños
per bambini

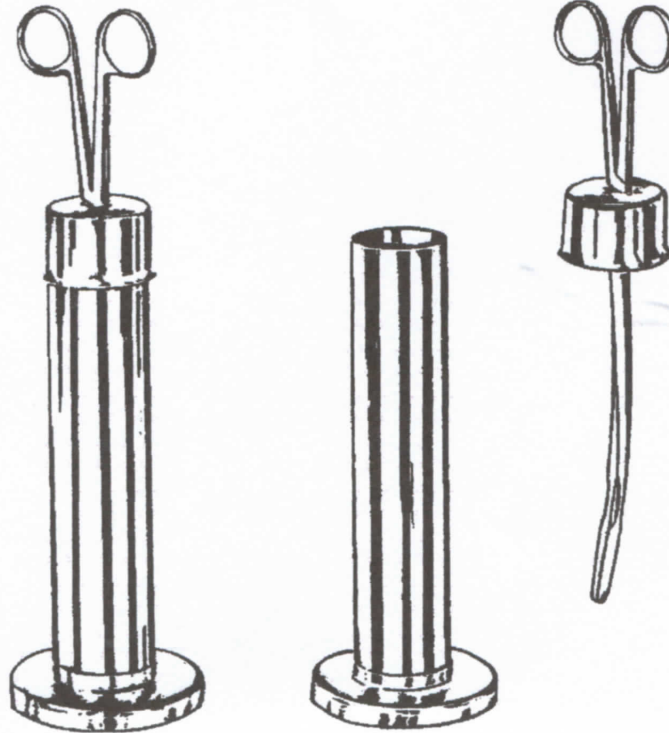


63232-01
17 cm, 6 3/4"



63232-02
16 cm, 6 1/4"

Kappenzangen, Nadel-Sterilisierkästen
Sterilizing Forceps, Needle Sterilizing cases
Combinacion tapa-pinza, Estuches para esterilizar agujas
Pinza coperchio, Scatole per sterilizzare aghi



89111-25 25 cm, 10"
89111-32 32 cm, 12 3/4"



89112-65
65 x 15 mm



89113-65



89114-00
150 x 95 x 13 mm

Schüsseln
Bowls
Cubetas
Scondelle

18/10
Stainless Steel
Acero inoxidable
Acciajo inossidabile

matt
satin finish
pulidas mate
opaco



Abmessungen in mm sizes in mm Tamaños en mm misura in mm		Inhalt capacity capacidad capacità	
Ø x h	oz	l	
40 x 19	2	0,05	89127-04
61 x 30	3	0,07	89127-06
80 x 40	5	0,14	89127-08
116 x 50	12	0,35	89127-11
128 x 55	16	0,45	89127-12
147 x 65	25	0,70	89127-14
167 x 75	39	1,10	89127-16
187 x 85	57	1,60	89127-18

Abmessungen in mm sizes in mm Tamaños en mm misura in mm		Inhalt capacity capacidad capacità	
Ø x h	l		
100x30	0,15		89129-11



	mm x mm	l
89133-16	165 x 60	0,75
89133-17	175 x 70	1,00
89133-22	220 x 80	2,00
89133-24	240 x 110	3,00
89133-31	310 x 120	6,00
89133-34	345 x 125	8,50
89133-38	380 x 130	11,00

89139-17	170 mm	0,25 l
89139-20	200 mm	0,35 l
89139-25	250 mm	0,5 l
89139-27	275 mm	0,75 l