

Reda Instrumente GmbH

Gänsäcker 34 · P.O. Box 131
D-78532 Tuttlingen

Telefon +49 / 74 62 / 94 45-0

Telefax +49 / 74 62 / 94 45-20

E-mail: info@Reda-Instrumente.de

<http://www.Reda-Instrumente.de>

Ausgabe Nr. 8

Datum: 02/2014

Charrière (Ch) French (F)	Durchmesser in mm	Inches
1	0,33	0,013
2	0,67	0,025
3	1,00	0,039
4	1,33	0,051
5	1,67	0,065
6	2,00	0,0787
7	2,33	0,092
8	2,67	0,105
9	3,00	0,1181
10	3,33	0,131
11	3,67	0,144
12	4,00	0,1575
13	4,33	0,170
14	4,67	0,184
15	5,00	0,1968
16	5,33	0,210
17	5,67	0,223
18	6,00	0,2362
19	6,33	0,249
20	6,67	0,263
21	7,00	0,2756
22	7,33	0,288
23	7,67	0,302
24	8,00	0,3150
25	8,33	0,328
26	8,67	0,341
27	9,00	0,3543
28	9,33	0,367
29	9,67	0,380
30	10,00	0,3973
31	10,33	0,407
32	10,67	0,420
34	11,33	0,446
36	12,00	0,4724
38	12,67	0,494
40	13,33	0,5199
45	15,00	0,5905

Gauge (G)	Durchmesser in mm	Inches
35	0,13	0,005
34	0,18	0,007
33	0,20	0,008
32	0,23	0,009
31	0,25	0,010
30	0,30	0,012
29	0,33	0,013
28	0,36	0,014
27	0,41	0,016
26	0,46	0,018
25	0,51	0,020
	0,53	0,021
24	0,56	0,022
23	0,64	0,025
22	0,71	0,028
21	0,81	0,032
20	0,89	0,035
	0,97	0,038
19	1,07	0,042
18	1,27	0,050
17	1,50	0,059
16	1,65	0,065
15	1,83	0,072
14	2,11	0,083
13	2,41	0,095
12	2,77	0,109
11	3,05	0,120
10	3,40	0,134
9	3,76	0,148
8	4,19	0,165
7	4,57	0,180
6	5,16	0,203

1 OZ	0,028 ml
5 OZ	0,140 ml
16 OZ	0,450 ml

35 OZ	1,0 l
128 OZ	3,7 l

GARANTIE / WARRANTY / GARANTIA / GARANZIA

GARANTIE

Wir gewähren auf alle **Reda**-Instrumente 5 Jahre Garantie.
Voraussetzung ist der sach- und fachgerechte Einsatz der Instrumente.
Von der Garantie sind Verschleißerscheinungen ausgeschlossen.

WARRANTY

Our **Reda** products are free from manufacturing defects in material and workmanship. We therefore give on all instruments a guarantee of five years provided that the instruments are maintained and cleaned properly and used normally for their intended purpose.

GARANTIA

Estamos convencidos de nuestra calidad y concedemos a todos los instrumentos de **Reda** 5 años de garantía contra cualquier defecto de fabricación, siempre y cuando se usen adecuadamente. De la garantía excluimos la manifestación de desgaste.

GARANZIA

Siamo convinti della nostra qualità e concediamo cinque anni di garanzia sulla funzione dei tutti gli strumenti **Reda** sotto la presupposizione che l'utilizzo è da esperto.
Escluso della garanzia sono tracce di consumo.

Arbeitsanweisung **Aufbereitung (Reinigung) und Sterilisation von resterilisierbaren** **chirurgischen Instrumenten**

DIN EN ISO 17664:2004 (D)

Hersteller:
REDA Instrumente GmbH, Gänsäcker 34
78532 Tuttlingen

Alle von Reda gelieferten wieder verwendbaren Instrumente wurden ausschließlich für den chirurgischen Gebrauch konstruiert und dürfen zu keinen anderen Zwecken benutzt werden. Unsachgemäße Handhabung und sorglose Pflege sowie zweckentfremdeter Gebrauch können zu vorzeitigem Verschleiß der Instrumente führen. Die Produkte sind bei der Auslieferung nicht sterilisiert.

Reinigungsvorbereitung

Fabrikneue Instrumente müssen vor der ersten Anwendung den gesamten Aufbereitungsprozess durchlaufen. Instrumente unmittelbar nach Anlieferung aus den Folienverpackungen entnehmen und in trockenen Räumen bei gleichbleibender Raumtemperatur lufttrocknen lagern, um Kondensationsbildung zu vermeiden. Die Instrumente keinen Sonnenlichteinstrahlungen oder Dämpfen durch Chemikalien (Säuren oder scharfe Reinigern) aussetzen. Vor der ersten Sterilisation alle Schutzkappen und Folien vollständig entfernen und anschließend reinigen.

Gebrauchte Instrumente unmittelbar nach Beendigung des Eingriffs von Blut, Gewebe und Arzneimittel reinigen. Instrumente in eine freigegebene Lösung eines kombinierten Reinigungs- und Desinfektionsmittels, das keine proteinfixierende Wirkung besitzt, einlegen. Dosierung des Herstellers beachten. Nicht in NaCl Lösung einlegen, ansonsten Gefahr für Loch- bzw. Spannungsriss-Korrosion

Überfüllung von Instrumentensieben und Wasch-Trays vermeiden.

Gelenkinstrumente vor dem Aufbereiten öffnen. Zerlegbare Instrumente gemäß Bedienungsanleitung (Piktogramm) zur Reinigung zerlegen. Reinigungsgerechtes Zubehör verwenden. Für die manuelle Reinigung nie Metallbürsten oder Metallschwämme verwenden. Spülmaschinen und Ultraschallanlagen nicht überladen. Spül- oder Schallschatten vermeiden. Dosierung, Einwirkzeit und Einwirktemperatur bei der Desinfektion und Reinigung unbedingt einhalten. Nach der Reinigung sorgfältig spülen. Möglichst vollentsalztes (demineralisiertes) Wasser verwenden. Nach dem Spülen ausreichend trocknen. Abgenutzte, korrodierte, deformierte, poröse oder anderweitig beschädigte Instrumente aussortieren.

Aus hygienischen Gründen müssen Instrumente, die zur Reparatur eingesandt werden komplett aufbereitet werden. Gelenkinstrumente nach jeder Aufbereitung mit einem Pflegemittel auf Basis von Paraffinöl behandeln (gilt nicht für flexible Endoskope und Zubehör). Funktionsprüfung in zusammengebautem Zustand durchführen. Instrumente mit Rastensperre vor der Sterilisation nur im ersten Zahn schließen.

Als Sterilisationsverfahren empfehlen wir die Dampfsterilisation (üblicherweise mit Sattedampf bei 134° C)

Sterilisation ist kein Ersatz für Sauberkeit!

Die Broschüre "Instrumenten-Aufbereitung richtig gemacht" des Arbeitskreis Instrumenten-Aufbereitung dient als Anhalt.

Reda Instrumente GmbH
78532 Tuttlingen

IMPORTANT INFORMATION CONCERNING PREPARING AND STERILIZING SURGICAL INSTRUMENTS

Dear Sirs,
please read the following instructions very carefully before using the instruments.

1. INITIAL USE

All instruments which are being used for the first time must be thoroughly cleaned, rinsed and then sterilized before using.

2. TREATING INSTRUMENTS AFTER USAGE

- a.) The instruments might be immediately thoroughly cleaned and disinfected. Please follow the manufacturer's instructions when using cleaning agents and disinfectants.
- b.) Instruments which may be dismantled must be cleaned and disinfected after being taken apart.
- c.) Cleaning may be carried out either manually or with a machine. Care should be taken that only cleaning agents and disinfectants are used, which are changed daily.
- d.) Following chemical disinfection and manual cleaning, all instruments must always be thoroughly rinsed under running water.
- e.) The temperature of water used in a machine for cleaning should not exceed 45°C.
- f.) Whether cleaning is carried out manually or by machine, we especially ask you to ensure that the correct dosage for cleaning solutions or the correct combination of disinfectant and cleaning solution, is employed. Similar importance should be applied to the length of time the agents require to perform properly and to the temperature set.
- g.) Hinged instruments should be opened before cleaning.
- h.) Please ensure that the perforated instrument trays, when loaded, do not exceed 10 kg in weight.
- i.) Please take care that when instruments are being cleaned they are arranged proper in a manne that fluids can circulate freely.
- j.) Deposits remaining after the cleaning process must be completely removed in the first rinse which now follows. The optimum temperature for final rinsing has proved to be between 70° and 90° C. Please use only purified water in this final cleaning stage.
- k.) The instruments must be carefully dried after cleaning and rinsing is completed.
- l.) Moving parts and the cutting edges of shears and scissors must be treated with preservatives which are both suitable and physiologically safe.

3. TESTING FOR CORRECT FUNCTIONING

- a.) Instruments must be carefully and thoroughly checked before every occasion that they are used.

- b.) After each time they are cleaned, the instruments must be macroscopically clean, i.e., visibly free from proteinbased residues and other soiling.
- c.) Care should be taken so that cracks, breakages and corrosion are noticed.
- d.) Instruments with flecks should be separated and taken out for special treatment.
- e.) All moving parts as well as working tips and blades should be checked with special care.
- f.) Checking should be carried out according to the extent to which the instruments will be used.
- g.) Instruments which are in any way defective or damaged should be immediately sorted out from the others.

4. STERILIZATION

- a.) All stainless steel surgical instruments supplied by us may be sterilized in an autoclave.
- b.) Please follow the manufacturer's operating instructions when using autoclave. All machines used must comply with all current quality and other standards.
- c.) Instruments are being sterilized/ autoclaved at a temperature of 134°C.
- d.) Sterilization packing material must comply with all current standards.
- e.) Instruments with ratchets or self-retaining mechanisms should be sterilized opened or in the first ratchet position.
- f.) Please ensure that perforated instrument trays, when loaded do not exceed 10 kg in weight.

5. IN GENERAL

- a.) All surgical instruments supplied by us have been thoroughly inspected before dispatch and leave our factory in perfect condition. Damage which can arise as a result of transporting, cleaning, preserving, sterilizing or storing, must be prevented.
- b.) Please handle surgical instruments always with the utmost care.
- c.) Instruments must be stored in a clean and dry place.
- d.) If you have any queries or problems please contact us at any time:

We should like to point out that, if the above-mentioned directions are not followed or the instruments supplied by us are not properly used, all guarantee claims become void and any consequences must be borne by yourselves.

SUGERENCIAS PARA LA LIMPIEZA, ESTERILIZACIÓN Y MANTENIMIENTO DE INSTRUMENTOS QUIRÚRGICOS

ENJUAGADO

Tras el uso enjuagar enseguida los instrumentos bajo un chorro de agua caliente (no hirviendo). El enjuagado debe servir para quitar los residuos de sangre, mucosas y tejidos.

LIMPIEZA

Si la limpieza no se efectúa inmediatamente después del enjuagado, los instrumentos tienen que sumergirse en una solución de agua y detergente con PH neutro (7)

Para los instrumentos muy delicados (algunos tipos de porta agujas o tijeras se aconseja una limpieza manual: ver punto "C").

a.- Limpieza en la pila de ultrasonido

Los instrumentos tienen que estar en la pila el tiempo necesario recomendado por el fabricante para efectuar el ciclo del lavado, generalmente de 5 a 10 minutos.

Los instrumentos con bisagras o juntas (articulaciones) tienen que sumergirse en la pila en posición abierta.

Asegurarse de que las hojas afiladas de las tijeras, bisturís para gingivectomía, curetas, etc. no estén en contacto con otros instrumentos.

Todos los instrumentos deben estar completamente sumergidos en la solución de lavado.

No poner instrumentos de diferentes metales (acero inoxidable, instrumentos cromados, latón, etc.) en el mismo ciclo de lavado.

Cambiar a menudo la solución para el lavado, como mínimo todas las veces que lo recomienda el fabricante de la pila de ultrasonidos.

Enjuagar concienzudamente los instrumentos con agua corriente tras lavado con ultrasonidos para quitar los residuos de la solución de lavado.

b.- Limpieza con lavadora

Seguir las indicaciones del fabricante. Asegurarse de que los instrumentos hayan sido lubricados tras el último ciclo de lavado y antes del ciclo de esterilización.

c.- Limpieza manual

La mayor parte de los fabricantes de instrumentos indican el lavado con los ultrasonidos como el modo mejor y más eficaz para limpiar los instrumentos quirúrgicos, especialmente los que tienen bisagras, cierres y en general articulaciones. Si la limpieza con los ultrasonidos no es posible, se aconseja usar el método siguiente:

- Usar cepillos rígidos de plástico, nylon, etc.
- Cepillar concienzudamente los instrumentos más delicados y, si es posible, enjuagar, limpiar y esterilizar estos instrumentos separadamente.
- Verificar que toda la superficie de estos instrumentos esté limpia.
- Tras haber cepillado los instrumentos, enjuagarlos bajo el chorro de agua corriente.
- Durante el enjuagado abrir y cerrar las tijeras, las pinzas hemostáticas, los porta agujas y los demás instrumentos con bisagras o juntas y asegurarse de que las partes internas de las bisagras estén perfectamente enjuagadas como la superficie externa del instrumento.

SECADO, LUBRIFICACIÓN E INSPECCIÓN

Tras las operaciones de limpieza y de enjuagado, los instrumentos quirúrgicos tienen que ser secados perfectamente.

Todos los instrumentos con juntas o bisagras (acción "metal contra metal") como tijeras, pinzas hemostáticas, porta agujas, fórceps de extracción, etc., tienen que ser lubricados. Se aconsejan lubricantes específicos para el instrumental quirúrgico. No usar aceites o lubricantes industriales.

A este punto es buena norma inspeccionar el estado de cada instrumento y verificar el funcionamiento según el uso específico. Controlar y asegurarse de que:

- Las hojas de las tijeras estén lisas de arriba abajo y de que, una vez cerradas, no hagan juego. Probar las tijeras cortando gasa muy fina. Tres cuartas parte de la hoja tienen que cortar la gasa sin retenerla.
- Las puntas de las pinzas estén al mismo nivel.

- Las pinzas hemostáticas y los porta agujas no dejen pasar la luz entre las puntas cuando estén cerradas, se abran y cierren fácilmente y que las bisagras no estén demasiado flojas.
- Controlar el desgaste de la porta agujas sobre la superficie interna de las puntas.
- Las cánulas metálicas de aspiración estén bien limpias en su interior.
- Los instrumentos cortantes y los bisturís tengan las hojas bien afiladas y no estropeadas.

ESTERILIZACIÓN EN AUTOCLAVE

Tras haber enjuagado, limpiado, secado, lubricado e inspeccionado los instrumentos, éstos pueden ser preparados para la esterilización separadamente o en serie.

Instrumentos individuales:

Las bolsas especiales monouso son el ideal para contener los instrumentos. Asegurarse de que las bolsas que contendrán los instrumentos con cierres y articulaciones (pinzas hemostáticas, porta agujas, etc.) sean lo bastante grandes como para contener los citados instrumentos en posición abierta.

Instrumentos en serie:

Poner los instrumentos en los especiales cestos o bandejas de acero inoxidable. Poner los instrumentos más pesados en la parte inferior cuando sean necesarias varias bandejas.

No cerrar nunca los instrumentos durante el ciclo en autoclave. Un instrumento cerrado no estará nunca bien esterilizado, ya que el vapor no puede penetrar en la parte de cierre a contacto "metal contra metal". En el instrumento podría además romperse en la parte de la bisagra a causa de la expansión del metal debida al calor durante el ciclo del autoclave.

No cargar demasiado la cámara del autoclave ya que algunos instrumentos podrían formar "zonas de sombra" sobre otros en los que el vapor no penetraría.

ATENCIÓN

Al final del ciclo de esterilización - antes del ciclo de secado- abrir ligeramente la portezuela del autoclave y preceder con el ciclo desecado según las instrucciones del fabricante. Si la portezuela del autoclave se abriese completamente antes del ciclo de secado, el aire frío de la habitación entraría en la cámara del autoclave causando la formación de condensación sobre los instrumentos y de consecuencia aparecerían las manchas de agua que vemos a menudo en los mismos.

ESTERILIZACIÓN EN FRÍO:

La mayor parte de las soluciones para la esterilización en frío esterilizan los instrumentos completamente tras 10 horas de inmersión. Esta acción química prolongada puede ser más perjudicial para los instrumentos que el ciclo normal de 20 minutos en autoclave.

Si los instrumentos tienen necesidad de ser simplemente "desinfectados", el proceso en frío es adecuado, ya que la desinfección tiene lugar en 10 minutos solamente.

Recuerde bien la diferencia entre:

ESTÉRIL - término absoluto (ningún organismo logra sobrevivir) y

DESINFECTADO - perfectamente limpio.

Usen siempre la técnica más adecuada de esterilización/limpieza de los instrumentos según el uso que se haga posteriormente de ellos.

Recuerden que la esterilización de los instrumentos no sustituye la limpieza de los mismos.

Recomendamos no volver a usar ni esterilizar los artículos de un solo uso.

Si se tratan en el modo correcto los instrumentos construidos con las modernas aleaciones inoxidables pueden durar muchos años.

INDICAZIONI PER LA CURA, PULITURA E LA STERILIZZAZIONE DELLO STRUMENTARIO CHIRURGICO RISTERILIZZABILE

Misure preventive anticorrosione

- 1) Raggruppare accuratamente gli strumenti correttamente confezionati e sterilizzati prima dell'operazione; selezionarli secondo l'intervento. Verificare sempre che la confezione esterna sia integra e che lo strumento stesso non sia danneggiato.
- 2) Assicurarli tramite l'indicatore di sterilizzazione collocato all'interno del vaglio che il contenuto sia stato sterilizzato.
- 3) Disporre gli strumenti seguendo l'ordine di utilizzo durante l'operazione; lasciare gli strumenti non necessari nel vaglio; predisporre gli strumenti solo immediatamente prima dell'operazione.
- 4) Nel corso dell'operazione rimuovere dagli strumenti sangue ed altri materiali biologici; dopo l'uso, riporre gli strumenti nel corretto alloggiamento.
- 5) Risciacquare opportunamente gli strumenti cavi, al fine di evitare l'adesione di sangue e polvere d'osso.
- 6) Per la pulitura degli strumenti utilizzare una soluzione lattata o una soluzione salina, ma non immergerli nelle suddette soluzioni.
- 7) Iniziare l'operazione di pulitura subito dopo l'intervento. Strumenti utilizzati su pazienti con possibili infezioni: smaltire in modo analogo, eliminando sangue, polvere d'osso parti di tessuto in eccesso.
- 8) Pulire gli strumenti in un luogo previsto nell'ambito della sala operatoria.

Nel caso in cui gli strumenti vadano collocati direttamente nella centrale di sterilizzazione, è necessario dapprima coprirli, per evitare il rischio di contaminazione ai danni del personale o dell'ambiente circostante.

Disinfezione

Durante l'uso di disinfettanti chimici è necessario osservare scrupolosamente le indicazioni del produttore; utilizzare le soluzioni sempre previa diluizione. Nella fase termica di disinfezione con acqua bollente assicurarsi che l'acqua sia priva di corpi estranei.

Pulitura

Indipendentemente dal metodo utilizzato per la pulitura (meccanico o manuale) si raccomanda di verificare attentamente quale detergente vada utilizzato con ciascun metodo. Valori pH consigliati: tra 7,0 e 8,5.

1) Pulitura meccanica

Osservare scrupolosamente le istruzioni d'uso fornite dal produttore della macchina pulitrice. Predisporre gli

strumenti per la pulitura meccanica. Tutti gli strumenti appuntiti e delicati dovrebbero essere puliti manualmente.

Non sovraccaricare i vagli, mettere gli strumenti pesanti sul fondo del vaglio. Se necessario, immergere e risciacquare gli strumenti molto sporchi (strumenti cavi), prima di collocarli nella lavatrice.

2) Pulitura ad ultrasuoni

(fa parte dei metodi di pulitura meccanica)

Prima di inserire uno strumento nel bagno ad ultrasuoni, rimuovere i materiali organici in eccesso. I bagni ad ultrasuoni sono consigliati per le filettatrici o gli strumenti con solchi profondi. L'ultrasuono deve essere seguito da un programma di risciacquo normale.

3) Pulitura manuale

Richiede diverse spazzole in nylon, una canna da soffio ed un ugello da soffio/ un dispositivo ad aria compressa pulito, detergenti e solventi come per la pulitura meccanica.

Per gli additivi di pulitura osservare le indicazioni fornite dal produttore.

Per la pulitura degli strumenti dotati di cannula, passare più volte lo spazzolino di nylon attraverso la cannula eseguendo movimenti rotatori (non utilizzare spazzole in lana d'acciaio/metallo) fino alla completa rimozione dei residui eliminabili con questo metodo.

Soffiare poi con aria compressa nella cannula.

4) Asciugatura

Ogni strumento deve essere asciugato completamente sia internamente che esternamente per evitare la formazione di ruggine o malfunzionamenti.

Indicazioni per la sterilizzazione della strumentazione

Pulire immediatamente ed asciugare bene gli strumenti usati, non utilizzare detergenti e disinfettanti con additivi fortemente acidi o alcalini (ad es. soda, soda caustica o acidi)!

Sterilizzare la strumentazione solo a vapore A 134°!

Prima della sterilizzazione, assicurarsi che gli strumenti siano perfettamente funzionanti ed integri. La sterilizzazione non sostituisce la pulitura.



Index

03: Diagnostik
05: Narkose
07: Skalpelle, Messer
09: Scheren
10: Mikroscheren
11: Pinzetten
12: Mikrochirurgie-Pinzetten

13: Klemmen
15: Tuchklemmen
17: Tupferzangen
19: Wundhaken
21: Sonden, Watteträger
23: Trokare, Biopsiekanülen, Führungsnadeln

25: Nadelhalter
27: Naht
29: Sterilisations-Instrumente

31: Verband, Gips
33, 34: Knochenchirurgie
41: Neurochirurgie
43, 44: Ophthalmologie
45: Otologie
47: Rhinologie
49: Mund und Zunge
51: Tonsillektomie
53: Laryngo-, Bronchoskopie
55: Tracheotomie
57: Thorax
61: Herz- und Gefäßchirurgie
63: Galle
65: Magen, Darm
67: Urologie
69: Rektum
71: Gynäkologie
73: Geburtshilfe
75: Dermatologie
89: Sterilisation, Behälter
91: Hochfrequenz-Chirurgie

Index

Diagnostic
Anesthesia
Scalpels
Scissors
Micro Scissors
Thumb and Tissue Forceps
Microsurgery Forceps
Atrauma Bulldog Clamps
Hemostatic Forceps
Towel Forceps
Dressing Forceps
Retractors
Probes, Cotton Applicators
Trocars

Needle Holders
Suturing Instruments
Sterilization Instruments

Plaster of Paris
Bone Surgery
Neurosurgery
Ophtalmology
Otology
Rhinology
Mouth and Tongue
Tonsils
Larynx
Tracheotomy
Thorax
Cardiovascular Surgery
Gall and Kidney
Intestines, Stomach
Urology
Rectum
Gynecology
Obstetrics
Dermatology, Hygiene
Different Containers
High Fequency Surgery

Indice

03:	Diagnóstico
05:	Anestesia
07:	Bisturíes
09:	Tijeras
10:	Tijeras p/micro cirugía
11:	Pinzas de disección
12:	Pinzas p/micro cirugía Clamp Atrauma Bulldog
13:	Pinzas hemostáticas
15:	Pinzas de campo
17:	Pinzas p/tapones
19:	Separadores
21:	Sondas, Porta-algodón
23:	Trócares
25:	Porta-agujas
27:	Instrumentos para sutura
29:	Instrumentos para la esterilización
31:	Vendajes enyesados
33, 34:	Cirugía ósea
41:	Neurocirugía
43, 44:	Oftalmología
45:	Otología
47:	Rinología
49:	Boca y lengua
51:	Amígdalas
53:	Laringe
55:	Traqueotomía
57:	Tórax
61:	Cirugía cardiovascular
63:	Vesícula biliar
65:	Intestinos, Estómago
67:	Urología
69:	Recto
71:	Ginecología
73:	Obstetricia
75:	Dermatología, Higiene
89:	Contenedores varios
91:	Electrocirugía

Index

Diagnostica
Anestesia
Bisturi
Forbici
Forbici per microchirurgia
Pinze per dissezione
Pinze per microchirurgia
Pinze Atrauma Bulldog
Pinze emostatiche
Pinze fissateli
Pinze per medicatura
Divaricatori
Sonde, Portacotone
Trequarti
Port'aghi
Strumenti per suture
Strumenti per la sterilizzazione
Bendaggi gessati
Chirurgia ossea
Neurochirurgia
Oftalmologia
Otologia
Rinologia
Bocca e lingua
Tonsille
Laringe
Tracheotomia
Torace
Chirurgia cardiovascolare
Vescicola biliare, rene
Intestini, Stomaco
Urologia
Retto
Ginecologia
Ostetrica
Dermatologia, Igiene
Vassoi diversi
Elettrochirurgia

Die Firma REDA Instrumente GmbH wurde im September 1990 gegründet. Ziel der Firmengründung war die Herstellung und der Vertrieb von chirurgischen Instrumenten.

Von anfangs 3 Mitarbeitern ist die Firma REDA innerhalb von sechs Geschäftsjahren zu einem mittelständischen Unternehmen gewachsen. Die Betriebsgröße beträgt heute mehr als 30 Mitarbeiter. Firma REDA exportiert in fast alle Länder der Welt und stellt dem Kunden weltweit Produkte und Dienstleistungen mit hoher Qualität zur Verfügung. Die Erwartungen der Kunden sollen stets erfüllt werden.

Um dieses zu erreichen, sind zufriedene und motivierte Mitarbeiter notwendig. Aus diesem Grund besitzen alle Mitarbeiter einen hohen Grad an Selbständigkeit und Eigenverantwortung für das Unternehmen. Darüber hinaus wird der familiäre Charakter seitens der Geschäftsführung unterstrichen und gefördert.

Der partnerschaftliche Stil setzt sich auch im hohen Maße bei den Geschäftsbeziehungen mit unseren Lieferanten und Kunden durch. Ziel ist es, Fehler zu vermeiden und kostenbewußt zu handeln.

Durch den Aufbau und den Unterhalt eines Qualitätsmanagementsystems nach den GMP regulation of the FDA, der DIN ISO 13485, Richtlinie 93/42 und die Zertifizierung des Systems wollen wir die erreichte Marktposition und Wettbewerbsfähigkeit halten und in der Zukunft weiter ausbauen.

In Zusammenarbeit mit Ärzten entwickeln, fertigen und vertreiben wir in den Bereichen:

- Allgemein- und Viszeralchirurgie
- Gefäß-, Mikro- und Neurochirurgie
- Herz- und Thoraxchirurgie
- Gynäkologie und Urologie
- HNO, Ophthalmologie
- Orthopädie
- Plastische Chirurgie
- Laparoskopie
- Endo-Neurochirurgie
- Arthroskopie
- Sinuskopie
- Cystoskopie
- Hysteroskopie
- Gynäkologie

Sehr gut ausgebildetes Personal und ein umfassender Maschinenpark ermöglichen es uns, die hohe Qualität und Präzision unserer Produkte umzusetzen und zu erreichen.

Unsere moderne EDV und die schlanke Organisation sind die wichtigsten Bestandteile unserer hohen Produktivität. Dadurch können wir unseren Kunden stets eine hohe Lieferbereitschaft und Flexibilität garantieren.

REDA Instrumente GmbH
Deutschland - Tuttlingen, 02/2014

REDA INSTRUMENTS GmbH was founded in September 1990. Starting with just three employees, REDA has grown within six years to a company who now employs over thirty people while still retaining the values of a family run business, and we pride ourselves on our customer service.

REDA exports to countries all over the world, offering to their customers a full range of surgical instruments.

REDA has a first class quality management system built upon the regulations of the FDA. In 1997 we became registered to DIN ISO 13485 and EEC 93/42.

REDA are able to offer a complete range of surgical instruments covering all types of surgery, including:

- General and Visceral Surgery
- Micro- Neuro- and Vascular Surgery
- Heart and Thorax Surgery
- Gynaecology
- ENT, Ophtalmology
- Orthopaedics etc.
- Laparoscopy
- Endo-Neurosurgery
- Arthroscopy
- Urology
- Gynaecology

We strive to offer first class products, manufactured by our highly trained precision engineers using most up to date C & C machines.

At our modern offices, together with modern technology, we can offer our customers a fast and efficient service from our large stocked warehouse.

REDA Instrumente GmbH
Deutschland - Tuttlingen, 02/2014

REDA Instrumente GmbH fundada en 1990 en Tuttlingen, Alemania, comenzó con éxito y con la intención de ocupar un lugar de privilegio como líder en la fabricación y venta internacional de instrumentos quirúrgicos de calidad superior.

Nuestra compañía comenzó con un pequeño staff integrado por el grupo familiar y fué creciendo con paso firme contando en la actualidad con un personal capacitado de aproximadamente 30 operarios y con presencia internacional a través de sus distribuidores en las principales capitales del mundo.

Un gran porcentaje de nuestra producción se compone de productos solicitados bajo características y marcas de nuestros clientes.

Con el objetivo de asegurar nuestro alto nivel de calidad nuestra empresa mantiene un staff muy entusiasta acompañado de una integrada relación con la gerencia, independencia en el empleo y motivación propia para el bienestar del personal.

Nos satisface trabajar junto a nuestros proveedores y en busca de un claro objetivo que nos permita lograr mutuos beneficios. Estamos seguros que éste sistema de trabajo nos permite evitar errores y lograr una mejor manufacturación de nuestros productos, la mayoría de ellos se diseñan con la colaboración y asesoramiento de médicos profesionales.

Nuestras especialidades en cirugía incluyen instrumentos para:

- cirugía general y visceral
- cirugía vascular, microcirugía, neurocirugía
- cirugía cardiovascular
- ginecología y urología
- ORL, Oftalmología
- Ortopedia
- cirugía plástica
- Laparoscopia
- Endo-neurocirugía
- Atroscopia
- sinuscopia
- cistoscopia
- histeroscopia
- ginecología

Estamos orgullosos de nuestra calidad, manteniendo periódicamente los tests correspondientes de GMP que exigen los standards regulares de agencias tales como la FDA, contando con los certificaciones de DIN ISO 13485 and EEC 93/42.

Desde los inicios, a través de modernos equipos computarizados logramos producir solamente instrumental de alta calidad.

REDA Instrumente GmbH
Deutschland - Tuttlingen, 02/2014

La REDA Instrumente GmbH fondata nel 1990 a Tuttlingen in Germania incominciò con l'intenzione di produrre e vendere strumenti chirurgici di qualità superiore sul mercato internazionale.

La nostra ditta incominciò con uno staff di 3 persone che attualmente è cresciuto a circa 30 persone con una presenza internazionale in tutti i paesi del mondo.

Una grande percentuale della nostra produzione è composta di prodotti richiesti a base caratteristiche e con il marchio dei nostri clienti.

Per poter assicurare il nostro alto livello di qualità la nostra impresa tiene uno staff molto entusiasta accompagnato da una relazione con la direzione, l'indipendenza e la propria motivazione per il benessere del personale.

Noi desideriamo lavorare in relazioni commerciali fra il fornitore ed il cliente, quale ci permette di ottenere un effetto utile reciproco. Siamo sicuri che questo tipo di collaborazione aiuta a limitare malintesi ed errori nella produzione e fornitura dei nostri prodotti. La maggiore parte dei nostri prodotti vengono sviluppati con la collaborazione di chirurghi professionali.

Le nostre specialità nella chirurgia includono strumenti per:

- Chirurgia generale e viscerale
- Micro chirurgia, neurochirurgia, chirurgia per vasi
- Chirurgia cardiovascolare e toracica
- Ginecologia e urologia
- ENT, oftalmologia
- Ortopedia
- Chirurgia plastica
- Laparoscopia
- Endo neurochirurgia
- Artroscopia
- Sinuscopia
- Cistoscopia
- Isteroscopia
- Ginecologia

Siamo orgogliosi della nostra qualità mantenuta periodicamente con i test corrispondenti agli standard GMP che mantengono o superano gli standard regolari come tali della FDA, la certificazione DIN ISO 13485 and EEC 93/42. Il nostro sistema moderno computerizzato ci permette di produrre solamente strumenti di alta qualità.

REDA Instrumente GmbH
Deutschland - Tuttlingen, 02/2014

Blutdruckmeßgeräte
Sphygmomanometer
Esfigmomanómetros
Sfigmomanometri



**DIPLOMAT
PRESAMETER**

Preiswertes und sehr beliebtes Quecksilbergerät in Metalltui. Lichtgraue Kunststoffbeschichtung. Glasröhre von höchster Präzision mit Innendurchmesser 4,2 mm +/- 0,2 mm. Gute Ablesbarkeit der eloxierten Skala bis 300 mmHG. Vernickelte Metallteile. Mit Quecksilbersicherung. Maximale Fehlertoleranz des Gerätes: +/- 3 mmHg. Mit Latexpolster und verchromtem Ablaufventil.

Nr. 03112-00 - Mit Wickelmanschette aus Baumwolle komplett mit Latexpolster 2-Schlauch.

Nr. 03112-01 - Mit Hakenmanschette aus Baumwolle komplett mit Latexpolster 2-Schlauch.

Nr. 03112-02 - Mit kalibrierter Nylon-Velcromanschette komplett mit Latexpolster 2-Schlauch.

Economical and attractive mercurial sphygmomanometer in metal case. Enameled in light gray color. Precision glass tube with inside diameter 4,2 mm +/- 0,2 mm. Anodized faceplate with easy-to-read graduated scale. Maximum reading 300 mmHg. Nickel-plated metal parts. Mercury lock. Maximum error throughout range +/- 3 mmHg. Complete with latex bulb and chrome-plated air-release valve.

No. 03112-00 - With cotton bandage cuff complete with 2-tube latex bladder.

No. 03112-01 - With cotton hook cuff complete with 2-tube latex bladder.

No. 03112-02 - With calibrated nylon velcro complete with 2-tube latex bladder.

Tensiómetro de mercurio económico y de una gran difusión en estuche metálico. Recubierto con plástico de color gris claro. Tubo vidrio de máxima precisión con diámetro interior de 4,2 mm +/- 0,2 mm. Lectura cómoda en la escala anodizada hasta 300 mmHg. Partes metálicas niqueladas. Tiene cierre de seguridad en el depósito de mercurio. Tolerancia de errores máxima del aparato +/- 3 mmHg. Pera latex y válvula cromada.

No. 03112-00 - Con brazaletes de venda de algodón, completo, bolsa latex de 2 tubos.

No. 03112-01 - Con brazaletes de ganchos de algodón, completo, con bolsa latex de 2 tubos.

No. 03112-02 - Con brazaletes velcro de nilón, calibrado, completo con bolsa latex de 2 tubos.

Sfigmomanometro a mercurio economico ed elegante in astuccio di metallo. Verniciato in grigio chiaro. Colonna di precisione di vetro con diametro interno 4,2 mm +/- 2 mm. Quadrante anodizzato con scala graduata di facile lettura. Valore massimo 300 mmHg. Parti metalliche nichelate. Chiusura di sicurezza del mercurio. Tolleranza +/- 3 mmHg. Completo di monopalla in latex e valvola di sfiato cromata.

No. 03112-00 - Con bracciale di cotone a fascia, complete di camera d'aria in latex a due tubi.

No. 03112-01 - Con bracciale di cotone a ganci, completo di camera d'aria in latex a due tubi.

No. 03112-02 - Con bracciale calibrato velcro-nylon completo di camera d'aria in latex a due tubi.

Blutdruckmeßgeräte
Sphygmomanometer
Esfigmomanómetros
Sfigmomanometri

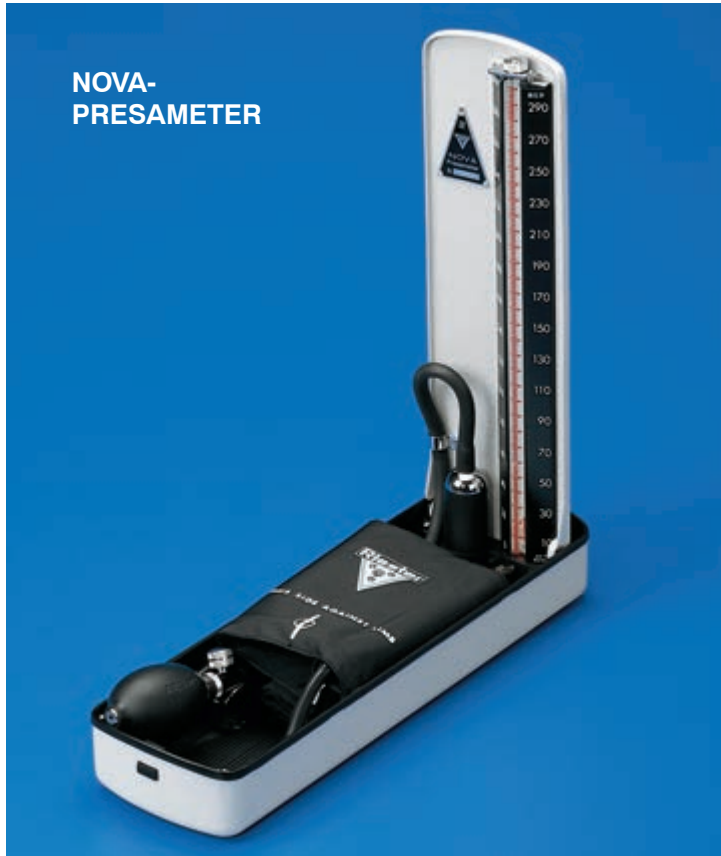

**NOVA-
PRESAMETER**

Qualitativ sehr hochwertiges Quecksilbergerät in Metallgehäuse mit 2-farbiger Einbrennlackierung (hellgrau und schwarz). Glasröhre von höchster Präzision mit Innendurchmesser 4,2 mm +/- 0,2 mm. Gute Ablesbarkeit der eloxierten Skala bis 300 mmHg. Verchromte Metallteile. Mit Quecksilbersicherung und Ballhalterung. Maximale Fehlertoleranz des Gerätes: +/- 3 mmHg. Mit Latexball und verchromtem Ablaßventil.

Nr. 03113-00 - Mit Wickelmanschette aus Baumwolle komplett mit Latexpolster 2-Schlauch.

Nr. 03113-01 - Mit Hakenmanschette aus Baumwolle komplett mit Latexpolster 2-Schlauch.

Nr. 03113-02 - Mit kalibrierter Nylon-Velcromanschette komplett mit Latexpolster 2-Schlauch.

High quality extra-sturdy mercurial sphygmomanometer in metal case. Enamelled in light gray with contrasting trim. Precision glass tube with inside diameter 4,2 mm +/- 0,2 mm. Anodized faceplate with easy-to-read graduated scale. Maximum reading 300 mmHg. Chrome-plated metal parts. Mercury lock. Bulb holder. Maximum error throughout range +/- 3 mmHg. With latex bulb and chrome-plated air release valve.

No. 03113-00 - With cotton bandage cuff complete with 2-tube latex bladder.

No. 03113-01 - With cotton hook cuff complete with 2-tube latex bladder.

No. 03113-02 - With calibrated nylon velcro complete with 2-tube latex bladder.

Tensiómetro de mercurio de alta calidad en estuche metálico barnizado al fuego en gris claro y negro. Tubo vidrio de precisión máxima con diámetro interior de 4,2 mm +/- 0,2 mm. Cómoda lectura de la escala anodizada hasta 300 mmHg. Partes metálicas cromadas. El depósito de mercurio lleva un cierre de seguridad. Soporte para pera. Tolerancia de errores máxima del aparato +/- 3 mmHg. Con pera latex y válvula cromada.

No. 03113-00 - Con brazaletes de venda de algodón completo, con bolsa latex con 2-tubos.

No. 03113-01 - Con brazaletes de ganchos de algodón completo, con bolsa latex con 2-tubos.

No. 03113-02 - Con brazaletes velcro de nilón calibrado completo, con bolsa latex con 2-tubos.

Sfigmomanometro a mercurio di alta qualità, molto robusto, in astuccio di metallo, verniciato in grigio chiaro con eleganti rifiniture. Colonna di precisione di vetro con diametro interno 4,2 mm +/- 0,2 mm. Quadrante anodizzato con scala graduata di facile lettura. Valore massimo 300 mmHg. Parti metalliche cromate. Chiusura di sicurezza del mercurio. Supporto per monopalla. Tolleranza +/- 3 mmHg. Con monopalla in latex e valvola di sfiato cromata.

No. 03113-00 - Con bracciale di cotone a fascia completo di camera d'aria di latex a 2-tubi.

No. 03113-01 - Con bracciale di cotone a ganci completo di camera d'aria di latex a 2-tubi.

No. 03113-02 - Con bracciale calibrato velcro-nylon completo di camera d'aria di latex a 2-tubi.

Blutdruckmeßgeräte
Sphygmomanometer
Esfigmomanómetros
Sfigmomanometri

**NOVA
WANDMODELL**

Quecksilbergerät von höchster Qualität, ideal für Praxis und Klinik. Nicht schwenkbar. Lichtgrau kunststoffbeschichtete Metallplatte. Glasröhre von höchster Präzision mit Innendurchmesser 4,2 mm +/- 0,2 mm. Gute Ablesbarkeit der eloxierten Skala bis 300 mmHg. Verchromte Metallteile. Quecksilbersicherung. Kunststoffbeschichteter Metallkorb zur optimalen Aufbewahrung des Zubehörs. Spiralschlauch dehnbar bis zu 3 m. Maximale Fehlertoleranz des Gerätes: +/- 3 mmHg. Mit Latexball und verchromtem Ablaßventil. Befestigungsschrauben und Dübel werden mitgeliefert.

Nr. 03114-00 - Mit Wickelmanschette aus Baumwolle komplett mit Latexpolster 2-Schlauch.

Nr. 03114-01 - Mit Hakenmanschette aus Baumwolle komplett mit Latexpolster 2-Schlauch.

Nr. 03114-02 - Mit kalibrierter Nylon-Velcromanschette komplett mit Latexpolster 2-Schlauch.

High quality mercurial sphygmomanometer ideal for use in hospitals and physicians' offices. Non-swiveling metal housing enameled in light gray. Precision glass tube with inside diameter 4,2 mm +/- 0,2 mm. Anodized faceplate with easy-to-read graduated scale. Maximum reading 300 mmHg. Chrome-plated metal parts. Mercury lock. Plastic coated metal basket for convenient accessory storage. Coiled tubing extensible to 3 m. Maximum error throughout range +/- 3 mmHg. With latex bulb and chrome-plated air-release-valve. Mounting hardware included.

No. 03114-00 - With cotton bandage cuff complete with 2-tube latex bladder.

No. 03114-01 - With cotton hook cuff complete with 2-tube latex bladder.

No. 03114-02 - With calibrated nylon velcro cuff complete with 2-tube latex bladder.

Tensiómetro de mercurio de alta calidad y fiabilidad, ideal para consultorios y clínicas. Fijo, no movable. Placa metal recubierta plástico de color gris claro. Tubo vidrio de precisión máxima y diámetro interior de 4,2 mm +/- 0,2 mm. Cómoda lectura de la escala anodizada hasta 300 mmHg. Partes metálicas cromadas. Con cierre de seguridad en el depósito de mercurio. Cestillo metálico recubierto de plástico para la colocación del accesorio. Con tubo espiral extensible hasta 3 metros. Tolerancia de errores máxima del aparato: +/- 3 mmHg. Con pera latex y válvula cromada. Se incluyen tacos y tornillos para la sujeción.

No. 03114-00 - Con brazalete de venda de algodón completo con bolsa latex con 2 tubos.

No. 03114-01 - Con brazalete de ganchos de algodón completo con bolsa latex con 2 tubos.

No. 03114-02 - Con brazalete velcro de nilón calibrado completo con bolsa latex con 2 tubos.

Sfigmomanometro a mercurio di alta qualità, ideale per ospedali ed ambulatori. Corpo dell'apparecchio in metallo, non orientabile, verniciato in grigio chiaro. Colonna di precisione di vetro con diametro interno 4,2 mm +/- 0,2 mm. Quadrante anodizzato con scala graduata di facile lettura. Valore massimo 300 mmHg. Parti metalliche cromate. Chiusura di sicurezza del mercurio. Cestello porta accessori in metallo rivestito di plastica. Tubo a spirale estensibile fino a 3 m. Tolleranza +/- 3 mmHg. Con monopalla in latex e valvola di sfiato cromata. Fornito con accessori di montaggio.

No. 03114-00 - Con bracciale di cotone a fascia completo di camera d'aria di latex a 2-tubi.

No. 03114-01 - Con bracciale di cotone a ganci completo di camera d'aria di latex a 2-tubi.

No. 03114-02 - Con bracciale calibrato velcro-nylon completo di camera d'aria di latex a 2-tubi.



Blutdruckmeßgeräte
Sphygmomanometer
Esfigmomanómetros
Sfigmomanometri



EXACTA-SPEZIAL

Noch modernere Ausführung unseres bisherigen sehr bekannten und beliebten Exacta Manometers. Sehr interessant im Preis. Metallgehäuse, schwarz einbrennlackiert. Mit spezialgehärteter Kupfer-Beryllium Membrane. Keine Nullpunktfixierung. Gut ablesbare Aluminiumskala \varnothing 49 mm bis 300 mmHg. Metallklemme an der Rückseite des Manometers zum Einhängen an der Manschette. Mit Latexball und verchromtem Ablaufventil. In Vinyltasche mit Reißverschluß. Maximale Fehlertoleranz des Gerätes: \pm 3 mm Hg.
No. 03120-00 - Mit kalibrierter Nylon-Velcromanschette komplett mit Latexpolster 2-Schlauch.

Latest version of our well-known Exacta classic sphygmomanometer, with an especially attractive price. Metal housing with baked-on black enamel finish. Special tempered copper-beryllium diaphragm. No stop pin. Easy-to-read graduated aluminium scale 49 mm \varnothing . Maximum reading 300 mmHg. Clip on rear of manometer for attachment to cuff. With latex bulb and chrome-plated air release valve, in vinyl zipper case. Maximum error \pm 3 mmHg throughout range.
No. 03120-00 - With calibrated nylon-velcro cuff complete with 2-tube latex bladder.

Modelo más moderno que nuestro anterior Exacta manómetro muy popular y conocido. Con precio muy económico. Caja metálica barnizada al fuego de color negro. Con membrana cobreberilio endurecido especial. Sin fijación a cero. Buena lectura de la escala aluminio \varnothing 49 mm hasta 300 mmHg. Con pinza metálica a la parte posterior del manómetro para ganchar en el brazalete. Con pera de latex y válvula cromada. En estuche de vinyl con cierre de cremallera. Tolerancia de errores máxima del aparato: \pm 3 mmHg.
No. 03120-00 - Con brazalete velcro de nilón calibrado completo con bolsa de latex con 2 tubos.

La più recente versione dei famosi sfigmomanometri tradizionali Exacta, ad un prezzo veramente interessante. Realizzato in metallo rifinitura smaltata a forno. Membrana speciale di rame-berillio indurito. Senza fissaggio a zero. Scala graduata in alluminio \varnothing 49 mm di facile lettura. Valore massimo 300 mmHg. Con morsetto nella parte posteriore del manometro per l'attacco al bracciale. Monopalla di latex e valvola di sfiato cromata. Fornito in borsa di vinilpelle con cerniera lampo. Tolleranza \pm 3 mmHg.
No. 03120-00 - Con bracciale calibrato velcro-nylon completo di camera d'aria di latex a 2 tubi.

Blutdruckmeßgeräte
Sphygmomanometer
Esfigmomanómetros
Sfigmomanometri



PRECISA

Sehr preisgünstiges, modernes und beliebtes Einhandmodell. Stabiles Kunststoffgehäuse, schwarz. Spezialgehärteter Kupfer-Beryllium Membrane. Keine Nullpunktfixierung. Gut ablesbare Aluminiumskala \varnothing 63 mm bis 300 mmHg. Löffel aus rostfreiem Stahl. Mit Latexball und verchromtem Ablaufventil. Mit verchromter Schlauchverschraubung auf der rechten Seite unterhalb des Manometers. In Vinyltasche mit Reißverschluss. Maximale Fehlertoleranz des Gerätes: \pm 3 mmHg.

No. 03122-00 - Mit kalibrierter Nylon-Velcromanschette komplett mit Latexpolster 1-Schlauch.

Very attractive and economical modern palm-style sphygmomanometer. Black housing of engineering plastic with chrome-plated tube connection at lower right. Special tempered copper-beryllium diaphragm. No stop pin. Easy-to-read graduated aluminium scale \varnothing 63 mm. Maximum reading 300 mmHg. Stainless steel handle. With latex bulb and chrome-plated air release valve, in vinyl zipper case. Maximum error \pm 3 mmHg throughout range.

No. 03122-00 - With calibrated nylon-velcro cuff complete with 1-tube latex bladder.

Modelo de mano, muy económico, moderno y popular. Estuche plástico duro de color negro. Con membrana cobre-berilio endurecido especial. Sin fijación a cero. Buena lectura de la escala de aluminio \varnothing 63 mm hasta 300 mmHg. Con cuchara de acero inoxidable. Con pera de latex y válvula cromada. Con atornilladura de tubo cromada al lado derecho debajo del manómetro. En estuche de vinil con cierre de cremallera. Tolerancia de errores máxima del aparato: \pm 3 mmHg.

No. 03122-00 - Con brazalete velcro de nilón, calibrado, completo con bolsa de latex con 1 tubo.

Sfigmomanometro molto elegante, moderno ed economico. Modello a mano. Scatola del manometro in materiale sintetico robusto con uscita laterale cromata per collegamento del tubo (in basso a destra). Membrana speciale in rame-berillio indurito. Senza fissaggio a zero. Scala graduata in alluminio di facile lettura, \varnothing 63 mm. Valore massimo 300 mmHg. Manico in acciaio inossidabile. Con monopalla di latex, valvola di sfiato cromata. Fornito in borsa di vinilpelle con chiusura lampo. Tolleranza \pm 3 mmHg.

No. 03122-00 - Con bracciale calibrato velcro-nylon completo di camera d'aria di latex add 1 tubo.

Blutdruckmeßgeräte
Sphygmomanometer
Esfigmomanómetros
Sfigmomanometri



BABYPHON

Einhandblutdruckmessgerät, besonders geeignet für Kinderarztpraxen. Wurde speziell in der kinderfreundlichen Farbe blau gestaltet. Verchromtes Metallgehäuse. Spezialgehärtete Kupfer-Beryllium Membrane. Keine Nullpunktfixierung. Gut ablesbare blau-weiße Aluminiumskala \varnothing 49 mm bis 300 mmHg. Löffel aus rostfreiem Stahl. Blauer Weichkunststoffball und verchromtes Ablaßventil. Verchromte Schlauchverschraubung am Manometeroberteil. In blauer Kunstledertasche mit Reißverschluss. Maximale Fehlertoleranz: \pm 3 mmHg. Komplett mit 3 verschiedenen blauen, kalibrierten Nylon-Velcro-Manschetten, mit Latexpolster 1-Schlauch. Alle Manschetten werden mit besonders kinderfreundlichem Bäreindruck geliefert.

Nr. 03126-00 - Komplettes Set mit 3 austauschbaren Manschetten mit Metallkonnektoren.
Neugeborene: 15,5 x 5,0 cm - Säuglinge: 23,0 x 7,2 cm - Kinder: 35,5 x 10,0 cm

Modern palm-model sphygmomanometer specially designed for pediatric use. Interchangeable cuffs equipped with metal tube connectors for quick and reliable attachment to unit of cuff appropriate to age of patient. Scale, bulb, cuffs, and case in attractive light blue color, with cuffs printed with child-friendly bear motif. Chrome-plated metal housing with tube connection at top. Stainless steel handle. Special tempered copper-beryllium diaphragm. No stop pin. Easy-to-read graduated manometer scale \varnothing 49 mm. Maximum reading 300 mmHg. With soft plastic bulb, chrome-plated air-release valve, and set of three interchangeable cuffs, in leatherette zipper case. Maximum error \pm 3 mmHg throughout range.

No. 03126-00 - Complete with set of three interchangeable cuffs with metal connectors.
Newborn: 15,5 x 5,0 cm - Infant: 23,0 x 7,2 cm - Child: 35,5 x 10,0 cm

Tensiómetro a mano, apropiado especialmente p. consultorios de pediatra. Se fabrica en color azul, agradable p. niños. Estuche metálico cromado. Membrana cobre-berilio endurecido especial. Sin fijación a cero. Buena lectura de la escala aluminio de colores azul y blanco \varnothing 49 mm hasta 300 mmHg. Cuchara de acero inoxidable. Pera de hule de plástico suave azul. Válvula cromada. Atornilladura de tubo cromada a la parte superior del manómetro. En estuche de cuero artificial, azul. c. cierre de cremallera. Tolerancia de errores máxima: \pm 3 mmHg. 3 brazaletes velcro de nilón, calibrados, con bolsas latex, 1 tubo de tamanos diferentes de color azul. Los tres brazaletes llevan impreso unos osos especialmente atractivo p. niños.

No. 03126-00 - Juego, completo con 3 brazaletes intercambiables con conectores metálicos.
Recien nacidos: 15,5 x 5,0 cm - Lactantes: 23,0 x 7,2 cm - Niños: 35,5 x 10,0 cm

Sfigmomanometro moderno, modello a mano, per uso pediatrico. Bracciali intercambiabili corredati di connettori di metallo per un veloce e sicuro attacco all'apparecchio del bracciale più adatto all'età del paziente. Scala graduata, monopalla, bracciali e astuccio di colore azzurro. Bracciali con stampato motivo adatto per bambini. Manometro cromato con uscita per collegamento tubo nella parte superiore. Manico in acciaio inossidabile. Membrana speciale in rame-berillio indurito. Senza fissaggio a zero. Scala graduata del manometro \varnothing 49 mm di facile lettura. Valore massimo 300 mmHg. Monopalla in plastica morbido, valvola di sfianto cromata e set di 3 bracciali intercambiabili in astuccio di finta pella con cerniera lampo. Tolleranza \pm 3 mmHg.

Nr. 03126-00 - Comprende set di 3 bracciali intercambiabili con raccordi di metallo.
Neonati: 15,5 x 5,0 cm - Bambini piccoli: 23,0 x 7,2 cm - Bambini: 35,5 x 10,0 cm

Blutdruckmeßgeräte
Sphygmomanometer
Esfigmomanómetros
Sfigmomanometri



MINIMUS II

Weltweit bekanntes und überaus beliebtes Einhandmodell. Verchromtes Metallgehäuse. Spezialgehärtete Kupfer-Beryllium Membrane. Keine Nullpunktfixierung. Gut ablesbare Aluminiumskala \varnothing 49 mm bis 300 mmHg. Löffel aus rostfreiem Stahl. Mit Latexball und verchromtem Ablaufventil. Mit verchromter Schlauchverschraubung am Manometeroberteil. In Vinyltasche mit Reißverschluß. Maximale Fehlertoleranz des Gerätes: \pm 3 mmHg.

Nr. 03132-00 - Mit Wickelmanschette aus Baumwolle komplett mit Latexpolster 1-Schlauch.

Nr. 03132-01 - Mit Hakenmanschette aus Baumwolle komplett mit Latexpolster 1-Schlauch.

Nr. 03132-02 - Mit kalibrierter Nylon-Velcromanschette komplett mit Latexpolster 1-Schlauch.

World-famous palm-style aneroid sphygmomanometer. Chrome-plated metal housing. Special tempered copper-beryllium diaphragm. No stop pin. Easy-to-read graduated aluminum scale 49 mm \varnothing . Maximum reading 300 mmHg. Stainless steel handle. With latex bulb and chrome-plated air release valve. In vinyl zipper case. Maximum error \pm 3 mmHg throughout range.

No. 03132-00 - With cotton bandage cuff, complete with 1-tube latex bladder.

No. 03132-01 - With cotton hook cuff, complete with 1-tube latex bladder.

No. 03132-02 - With calibrated nylon-velcro cuff, complete with 1-tube latex bladder.

Modelo de mano, de fama mundial y preferido por los medicos. Caja metálica cromada donde se aloja el mecanismo. Con membrana cobre-berilio endurecido especial. Sin fijación a cero. Buena lectura de la escala de aluminio \varnothing 49 mm hasta 300 mmHg. Con cuchara de acero inoxidable. Con pera latex y válvula cromada. Con atornilladura de tubo cromada a la parte superior del manómetro. En estuche de vinilio con cierre de cremallera. Tolerancia máxima del aparato: \pm 3 mmHg.

No. 03132-00 - Con brazalete de venda de algodón completo con bolsa de latex con 2 tubos.

No. 03132-01 - Con brazalete de ganchos de algodón completo con bolsa de latex con 2 tubos.

No. 03132-02 - Con brazalete velcro de nilón calibrado completo con bolsa de latex con 2 tubos.

Sfigmomanometro ad aneroido, modello a mano di fama mondiale. Manometro cromato con uscita per collegamento tubo cromata, nella parte superiore. Membrana speciale di rame-berillio indurito. Senza fissaggio a zero. Scala graduata in alluminio \varnothing 49 mm di facile lettura. Valore massimo 300 mmHg. Manico in acciaio inossidabile. Con monopalla di latex e valvola di sfianto cromato. Fornito in borsa vinilpelle con cerniera lampo. Tolleranza \pm 3 mmHg.

No. 03132-00 - Con bracciale di cotone a fascia completo di camera d'aria latex ad 1 tubo.

No. 03132-01 - Con bracciale di cotone a ganci completo di camera d'aria di latex ad 1 tubo.

No. 03132-02 - Con bracciale calibrato velcro-nylon completo di camera d'aria di latex ad 1 tubo.

Blutdruckmeßgeräte
Sphygmomanometer
Esfigmomanómetros
Sfigmomanometri



MINIMUS III

Weltweit bekanntes und beliebtes Einhandmodell. Verchromtes Metallgehäuse. Spezialgehärtete Kupfer-Beryllium Membrane. Keine Nullpunktfixierung. Gut ablesbare Aluminiumskala \varnothing 49 mm bis 300 mmHg. Löffel aus rostfreiem Stahl. Latexball und verchromtes Ablaßventil. Zwei verchromte Schlauchverschraubungen an der rechten Seite unterhalb des Manometers. In Vinyltasche mit Reißverschluss. Maximale Fehlertoleranz des Gerätes: \pm 3 mmHg.

Nr. 03133-00 - Mit Wickelmanschette aus Baumwolle, komplett mit Latexpolster mit Doppelschlauch.

Nr. 03133-01 - Mit Hakenmanschette aus Baumwolle, komplett mit Latexpolster mit Doppelschlauch.

Nr. 03133-02 - Mit kalibrierter Nylon-Velcromanschette, komplett mit Latexpolster mit Doppelschlauch.

World-famous and popular palm-style sphygmomanometer. Chrome-plated metal housing with 2 chromed-tube connections at lower right. Special tempered copper-beryllium diaphragm. No stop pin. Easy-to-read graduated aluminium scale \varnothing 49 mm. Maximum reading 300 mmHg. Stainless steel handle. With latex bulb and chrome-plated air release valve. In vinyl zipper case. Maximum error \pm 3 mmHg throughout range.

No. 03133-00 - With cotton bandage cuff, complete with double-tube latex bladder.

No. 03133-01 - With cotton hook cuff, complete with double-tube latex bladder.

No. 03133-02 - With calibrated nylon velcro cuff complete with double-tube latex bladder.

Modelo de mano, conocido en el mundo entero y de gran aceptación. Caja metálica cromada donde se aloja el mecanismo. Membrana cobre-berilio endurecido especial. Sin fijación a cero. Buena lectura de la escala aluminio \varnothing 49 mm hasta 300 mmHg. Cuchara de acero inoxidable. Pera latex y válvula cromada. Dos atornilladuras de tubo cromadas al lado derecho debajo del manómetro. En estuche vinílico con cierre de cremallera. Tolerancia de errores máxima: \pm 3 mmHg.

No. 03133-00 - Con brazalete de venda de algodón, completo con bolsa de latex doble tubos.

No. 03133-01 - Con brazalete de ganchos de algodón, completo con bolsa de latex doble tubos.

No. 03133-02 - Con brazalete velcro de nilón calibrado, completo con bolsa de latex doble tubos.

Sfigmomanometro ad aneroide di fama mondiale. Manometro in metallo cromato con uscita cromata laterale (in basso a destra) per collegamento a due tubi. Membrana speciale di rame-berillio indurito. Senza fissaggio a zero. Scala graduata in alluminio \varnothing 49 mm di facile lettura. Valore massimo 300 mmHg. Manico in acciaio inossidabile. Con monopalla di latex e valvola di sfiato cromata. Fornito in borsa vinilpelle con cerniera lampo. Tolleranza \pm 3 mmHg.

No. 03133-00 - Con bracciale di cotone a fascia, completo di camera d'aria di latex a 2 tubi.

No. 03133-01 - Con bracciale di cotone a ganci, completo di camera d'aria di latex a 2 tubi.

No. 03133-02 - Con bracciale calibrato velcro-nylon completo di camera d'aria a 2 tubi.

Diagnostik-Bestecke mit Standardbeleuchtung
 Diagnostic Sets with Standard illumination
 Estuches de diagnóstico con iluminación standard
 Combinazioni per diagnostica con illuminazione standard



Nr. 03161-00

Weltbekanntes und preiswertes Otoskop mit Standardbeleuchtung 2,5 V. Besonders geeignet für Studenten und Ärzte.

Set bestehend: Aus **Otoskopkopf** verchromt, mit Steckverschluss. **Verchromter Batteriegriff 28 mm ø** für 2 Batterien Typ C. Mit abnehmbarem Abdeckglas in Kunststoff-Fassung mit Plastikconnector für den pneumatischen Test. Die verchromte Schwenklinse ist abnehmbar und vergrößert 4,0-fach. Die Lichtstärke kann anhand des Rheostates reguliert werden. Mit 3 wiederverwendbaren Ohrtrichtern 2, 3 und 4 mm ø. Komplet in silberfarbener Kunststofftasche.

No. 03161-00

World famous otoscope set at a budget price for physicians and students. 2,5 V standard illumination for use with 2 batteries type C.

Set includes: **Otoscope head** with pin contact fitting. Chrome-plated. Fixed protective lens in plastic mount may be removed for introduction of instruments. Plastic connector for pneumatic otoscopy. Removable swivel-mounted 4 x magnifier. 2, 3 and 4 mm reusable specula included. **Battery handle 28 mm ø** for 2 C-cell batteries. Chrome-plated. With thumb wheel for securing pin contact heads. With rheostat for adjustment of illumination. Complete in silver-colored plastic pouch.

No. 03161-00

Otoscopio muy popular y económico con iluminación standard 2,5 V apropiado para estudiantes y médicos, de fama mundial.

Cabeza otoscopio cromada, con cierre de tornillo. **Mango a pilas cromado 28 mm ø** para dos pilas tipo C. Con cristal de cubierto desmontable en armadura plástica. Con conector plástico para el test neumático. La lente giratoria es desmontable y amplifica 4,0 veces mas. La intensidad de la luz es regulable con el reostato. Con tres espejuelos reutilizables 2, 3 y 4 mm ø. Completo en bolsa de plástico de color gris plata.

No. 03161-00

Combinazione otoscopio molto conosciuta, ad un prezzo economico, per ambulatori e studenti. Illuminazione standard 2,5 V con 2 batterie tipo C.

La combinazione comprende: **Testa otoscopio** con chiusura a vite. Cromata. La lente di protezione fissa in supporto di plastica può essere tolta per l'inserimento di strumenti. Connettore di plastica per test pneumatico. Lente d'ingrandimento 4 x in montatura girevole estraibile. Inclusi specoli riusabili da 2, 3 e 4 mm. **Manico a pila ø 28 mm** per 2 batterie tipo C. Cromato. Con ruota ad orlo zigrinato per fissare la testa dell'otoscopio con chiusura a vite. Con reostato per la regolazione dell'illuminazione. Fornito in busta di plastica colore grigio argento.

Diagnostik-Bestecke mit Standardbeleuchtung
 Diagnostic Sets with Standard illumination
 Estuches de diagnóstico con iluminación standard
 Combinazioni per diagnostica con illuminazione standard



Nr. 03161-01

Weltbekanntes und preisgünstiges **May-Ophthalmoskop**: mit Standardbeleuchtung 2,5 V. Besonders für Studenten und Ärzte geeignet. Ophthalmoskop mit Steckverschluß. Anhand des Linsenrades können Korrekturlinsen von 0 bis +20 und 0 bis -20 Dioptrien gewählt werden. Mit einer Blende: großer Kreis. Mit verchromtem **Batteriegriff**: 28 mm ϕ für 2 Batterien Typ C. Die Lichtstärke kann anhand des Rheostates reguliert werden. Komplett in silbergrauer Kunststofftasche.

No. 03161-01

World-famous ophthalmoscope set at a budget price for physicians and students. 2,5 V standard illumination for use with 2 batteries Type C. Set includes: **May ophthalmoscope head**: Pin contact fitting. Lens selection wheel permits choice of corrective lenses from 0 to +20 and 0 to -20 diopters. Single large circle aperture. **Battery handle**: 28 mm ϕ for 2 C-cell batteries. Chrome-plated. With thumb wheel for securing pin-contact heads. Rheostat for adjustment of illumination. Complete in silver-gray plastic pouch.

No. 03161-01

Oftalmoscopio May: muy popular y económico con iluminación standard 2,5 V, apropiado para estudiantes y médicos de fama mundial. Oftalmoscopio con cierre de tornillo. Con ayuda de la rueda de lentes se puede elegir lentes de corrección de 0 a +20 y 0 a -20 dioptrías. Y con una apertura: gran círculo. Con **mango a pilas**: cromado 28 mm ϕ para dos pilas tipo C. La intensidad de la luz es regulable con el reostato. Completo en bolsa de plástico de color gris plata.

No. 03161-01

Combinazione oftalmoscopio molto conosciuta, a prezzo economico, per ambulatori e studenti. Illuminazione standard 2,5 V con 2 batterie tipo C. La combinazione comprende: **Oftalmoscopio di May**: Con chiusura a vite. La rotella di selezione delle lenti permette la scelta di lenti di correzione da 0 a +20 e da 0 a -20 diottrie. Apertura singola a cerchio grande. **Manico a pila**: ϕ 28 mm per 2 batterie tipo C. Cromato. Con ruota ad orlo zigrinato per fissare la testa dell'otoscopio con chiusura a vite. Reostato per la regolazione dell'illuminazione. Fornito con busta di plastica di colore grigio argento.

Diagnostik-Bestecke mit Standardbeleuchtung
 Diagnostic Sets with Standard illumination
 Estuches de diagnóstico con iluminación standard
 Combinazioni per diagnostica con illuminazione standard

Nr. 03161-02

Weltbekanntes diagnostisches Besteck mit Standardbeleuchtung 2,5 V. Äußerst beliebt und sehr preiswert. Besonders geeignet für Studenten und Ärzte. Das Set besteht aus folgenden Teilen: **Otoskopkopf** verchromt, mit Steckverschluß. Abnehmbares Abdeckglas in Kunststofffassung, mit Plastikconnector für pneumatischen Test. Abnehmbarer Schwenklinse (Vergrößerung 4,0-fach). 3 wiederverwendbaren Ohrtrichtern 2, 3 und 4 mm ø. **May-Ophthalmoskop** mit Steckverschluß. Anhand des Linsenrades können Korrekturlinsen von 0 bis +20 und 0 bis -20 Dioptrien gewählt werden. Mit einer Blende: großer Kreis. **Batteriegriff** verchromt, 28 mm ø für 2 Batterien Typ C. Die Lichtstärke kann anhand des Rheostates am Batteriegriff reguliert werden. Alle Teile komplett in silbergrauer Kunststofftasche.

No. 03161-02

World-famous otoscope/ophthalmoscope diagnostic set at a budget price for physicians and students. 2,5 V Standard illumination for use with 2 batteries type C. Set includes: **Otoscope head** - Pin contact fitting. Chrome-plated. Fixed protective lens in plastic mount may be removed for introduction of instruments. Plastic connector for pneumatic otoscopy. Removable swivel-mounted 4 x magnifier. 2, 3 and 4 mm reusable specula included. **May ophthalmoscope head**. Pin contact fitting. Lens selection wheel permits choice of corrective lenses from 0 to +20 and 0 to -20 diopters. Single large circle aperture. **Battery handle**. 28 mm ø for 2 C-cell batteries. Chrome-plated. With thumb wheel for securing pin-contact heads. Rheostat for adjustment of illumination.

No. 03161-02

Este estuche de diagnóstico con iluminación standard 2,5 V es muy popular y muy económico, apropiado para estudiantes y médicos. Juego, compuesto de: **Cabeza otoscopio** cromado, con cierre de tornillo. Con cristal de cubierto en armadura plástica, con conector plástico para el test neumático. Con lente giratorio desmontable (amplificación: 4 veces más). **Cabeza oftalmoscopio May** con cierre de tornillo. Con ayuda de la rueda de lentes se puede elegir lentes de corrección de 0 a +20 y 0 a -20 dioptrías. Con una apertura: gran círculo. **Mango a pilas** cromado, 28 mm ø para dos pilas tipo C. La intensidad de la luz es regulable con el reostato al tope del mango. Todos los partes se presentan en una bolsa plástica de color gris plata.

No. 03161-02

Combinazione per diagnostica otoscopio/oftalmoscopio a prezzo economico, per ambulatori e studenti. Illuminazione standard 2,5 V con 2 batterie tipo C. La combinazione comprende: **Testa otoscopio** - Chiusura a vite. Cromata. La lente di protezione fissa in supporto di plastica può essere tolta per l'inserimento di strumenti. Connettore di plastica per test pneumatico. Lente d'ingrandimento 4 x in montatura girevole estraibile. Inclusi specoli da 2, 3 e 4 mm riusabili. **Oftalmoscopio May**. Chiusura a vite. La rotella di selezione permette la scelta di lenti di correzione da 0 a +20 e da 0 a -20 diottrie. Apertura singola a cerchio grande. **Manico a pila** ø 28 mm con 2 batterie tipo C. Cromato. Con ruota ad orlo zigrinato per fissare la testa dell'otoscopio con chiusura a vite. Reostato per la regolazione dell'illuminazione. Fornita in busta di plastica colore grigio argento.

Diagnostik-Bestecke mit Standardbeleuchtung
 Diagnostic Sets with Standard illumination
 Estuches de diagnóstico con iluminación standard
 Combinazioni per diagnostica con illuminazione standard



ECO "T" 03161-03T

- a) Otoskop, mit Schraubverschluss und 3 Ohrtrichtern, 2-3-4 mm
 Otoscope with screw fitting and 3 ear speculas with, 2-3-4 mm
 Otopscopio, con cierre a tornillo y con 3 espéculos auriculares de 2-3-4 mms
 Testa otoscopio: chiusura a vite, connettore di plastica per test pneumatico,
 3 specoli (2, 3 e 4 mm) riutilizzabili, lente di protezione da togliere
- b) Ophthalmoskop, 0 bis +20 und 0 bis -20 Dioptrien, mit Schraubverschluss
 Ophthalmoscope from 0 to +20 and 0 to -20 dioptres with screw fitting
 Oftalmoscopio, 0 a + 20 y 0 a - 20 dioptrías, con cierre a tornillo
 Testa oftalmoscopio: chiusura a vite, lenti di correzione da 0 a +20 e da 0 a -20 diottrie.
- c) Nasenspekulum
 Nasal Speculum
 Espéculo nasal
 Specoli nasali divaricabili
- d) Lampenträger mit Schraubverschluss
 Bent arm illuminator with screw fitting
 Porta-lámpara, con cierre a tornillo
 Porta lampada con 2 specchi laringei, misura 3 e 4.
- e) 2 Kehlkopfspiegel No. 3 und 4
 2 laryngeal mirrors no. 3 and 4
 Espejos laringeos Nos. 3 y 4
 Porta lampada con 2 specchi laringei, misura 3 e 4.
- f) Mundspatelhalter
 Tongue blade holder
 Abaja-lenguas
 Porta abbassa-lingua
- g) Batteriegriff für 2 Batterien mit Schraubverschluss (ohne Batterien)
 Battery handle for 2 batteries
 Mango para 2 pilas, con cierre a tornillo (sin pilas)
 Manico a pila (senza pila), illuminazione regolabile
- h) Ersatzlämpchen 2.5 V
 Spare lamp 2.5 V
 Bombillo de repuesto 2.5 V
 Lampadina di ricambio

ECO "C" 03161-03C

Inhalt gleich wie oben, mit drehbarem Schnellverschluss.
 Contents same as above, but with quick plug-in connector.
 Mismo contenido como arriba pero con CIERRE RAPIDO GIRATORIO.
 Lo stesso contenuto come sopra ma con chiusura a baionetta.

Diagnostik-Bestecke mit Xenonbeleuchtung
 Diagnostic Sets with Xenon illumination
 Estuches de diagnóstico con iluminación Xenon
 Combinazioni per diagnostica con illuminazione Xenon



Kleine, sehr moderne Qualitätsinstrumente aus Kunststoff, grau, mit Xenonbeleuchtung XL 2.5 V. Sehr preiswert und aufgrund der Größe besonders gut für die Arzttasche geeignet. Schraubverschluss. **Otoskop:** Fiber-Optik. Anschluß für pneumatischen Test. Lupe vergrößert 2,5-fach. Batteriegriff für 2 Batterien Typ AA. **Ophthalmoskop:** Korrekturlinsen: 0 bis +20 und 0 bis -20 Dioptrien. Blenden: Kreis groß + klein, Halbkreis, Fixierstern und Grünfilter. Griff für 2 Batterien Typ AA. Das Otoskop- und das Otoskop/Ophthalmoskop-Besteck werden jeweils mit einem Metallkonnector für pneumatischen Test und Plastikröhrchen mit jeweils 5 wiederverwendbaren Ohrtrichtern 2,5 und 4,0 mm geliefert. Komplet in modernem schwarzen Kunststoffetui.

Nr. 03171-00 - Otoskop mit Griff AA.

Nr. 03171-01 - Ophthalmoskop mit Griff AA.

Nr. 03171-02 - Otoskop/Ophthalmoskop jeweils mit Griff AA.

Economically priced state-of-the-art quality instrument made of plastics, gray color, with Xenon illumination XL 2.5 V. Due to its small size it is most suitable for each practitioner's bag. **Otoscope:** Fiber optic. Screw type fitting. 2.5 x magnifying glass. Battery handle for 2 AA-cell batteries. **Ophthalmoscope:** Corrective lenses ranging from 0 to +20 and 0 to -20 diopters. Apertures: large and small circle, semi-circle, fixation star and green filter. Otoscope and otoscope/ophthalmoscope set each contain a metal connector for pneumatic otoscopy as well as plastic tube with 5 each reusable ear specula 2,5 and 4,0 mm. All sets come in modern black plastic case.

No. 03171-00 - Ootoscope with AA-handle.

No. 03171-01 - Ophthalmoscope with AA-handle.

No. 03171-02 - Ootoscope/ophthalmoscope with 1 each AA-handle.

Instrumentos de calidad, muy moderno y pequeño de plástico resistente, gris, con iluminación Xenon XL 2.5 V. Muy económico y gracias al tamaño apropiado para el bolsillo del médico. Cierre roscado. **Otoscopio:** fibra óptica. Conexión para test neumático. Lupa aumenta 2,5 veces más. Mango a pilas para 2 pilas, tipo AA. **Oftalmoscopio:** Lentes de corrección: 0 hasta +20 y o hasta -20 dioptrías. Aberturas: círculo grande y pequeño, semicírculo, estrella fijadora y filtro verde. Con mango para 2 pilas, tipo AA. Juego de otoscopio y de otoscopio/oftalmoscopio con conector metálico para el test neumático y con 5 espejuelos reutilizables de 2,5 y 4,0 mm en tubito de plástico. Todos los juegos se presentan en estuche de plástico negro moderno.

No. 03171-00 - Otoscopio con mango AA.

No. 03171-01 - Oftalmoscopio con mango AA.

No. 03171-02 - Oto/oftalmoscopio con mangos AA.

Strumento piccolo, moderno, di alta qualità realizzato in plastica, grigio, con illuminazione Xenon XL 2.5 V. Molto economico e, date le sue dimensioni, il più adatto a stare nella borsa del medico. **Otoscopio:** con attacco a vite. Lente d'ingrandimento 2,5X. Manico a pila per 2 batterie tipo AA. **Oftalmoscopio:** Lenti correttive da 0 a +20 e da 0 a -20 diottrie. Aperture: a cerchio grande e piccolo, semicerchio, a stella, filtro verde. Con manico per 2 batterie tipo AA. L'otoscopio e la combinazione otoscopio/oftalmoscopio hanno un connettore per test pneumatico e tubo di plastica con 5 specoli auricolari 2,5 e 4,0 mm. cad. Tutte le combinazioni sono fornite in un moderno astuccio di plastica nera.

No. 03171-00 - Otoscopio con manico AA.

No. 03171-01 - Oftalmoscopio con manico AA.

No. 03171-02 - Oto/Oftalmoscopio con manici AA.



Nystagmusbrille
 Nystagmus spectacles
 Anteojos para nistagmo
 Occhiali nistagmo



FRENZEL

03167-03
 Beleuchtete Nystagmusbrille
 mit querliegendem Batterie-
 handgriff und festen Gläsern

Energiequelle:
 2 Stück 4-Volt-Lämpchen
 2 Stück Baby-Zellen 1.5 V

03167-03
 Anteojos para nistagmo, con
 iluminación, con mango para
 pilas en forma horizontal,
 vidrios fijos,

Alimentación:
 2 unidades de bombillos de
 4 voltios
 2 unidades de pilas de
 1.5 voltios

03167-03
 Nystagmus spectacles for
 observation of the eyes during
 examination of the vestibular
 apparatus, with battery handle
 and fixed glasses. Illuminated
 on inside of lenses.

Source of energy:
 2 bulbs 4-volt
 2 baby-battery cells 1.5 V

03167-03
 Occhiali Nistagmo illuminati
 con manipoło a batteria,
 lenti fisse.
 Per la rilevazione della reazione
 patologica del nistagmo.

Alimentazione:
 2 lampadine 4 Volt
 2 batterie 1,5 Volt

Stirnspiegel
Head Mirror
Espejos frontales
Specchi frontali



03180-93
ø 90 mm



ZIEGLER
03180-90
compl.



03180-92

03180-90
Ziegler-Stirnspiegel,
komplett, mit schwarzem
Stirnreifen,
mit Kugelgelenk,
90 mm ø

03180-90
Ziegler Head Mirror,
complete with black head
band, with ball socket,
90 mm ø

03180-90
Ziegler espejo frontal, com-
pleto con cinta negra,
con articulación,
90 mm ø

03180-90
Specchio frontale, Ziegler,
completo con fascia nera,
con snodo sferico,
90 mm di ø

03180-92
Stirnreifen, allein

03180-92
head band, only

03180-92
cinta, suelta

03180-92
fascia, sola

03180-93
Spiegel, allein
90 mm ø

03180-93
Mirror, only
90 mm ø

03180-93
Espejo, suelto
90 mm ø

03180-93
Specchio,
solo 90 mm ø

Stirnlampe
Head Light
Lámpara frontal
Lampada frontale



CLAR
03195-00

komplett mit Stirnstreifen und Kabel
complete with head band and cable
completo con cinta frontal y cable
completa con fascia frontale e cordone



03195-01
ø 55 mm

Spiegel aus Glas ohne Fassung
Glass Mirror without frame
Reflector de cristal, sin montura
Riflettore di cristallo, senza montatura



03195-06
6 Volt



03195-07 Kleintransformator
220 Volt = 0 - 10 Volt / 3 Watt
Mini-Transformer Unit
Transformador eléctrico pequeño
Mini-trasformatore elettrico

03195-08 Kleintransformator
110 Volt = 0 - 10 Volt / 3 Watt
Mini-Transformer Unit
Transformador eléctrico pequeño
Mini-trasformatore elettrico

03195-09 CLAR-Spiegel-Gelenkverbindung
CLAR special socket joint
Articulación especial de CLAR
Snodo speciale di CLAR

03195-04 Stirnstreifen, alleine
head band, only
cinta frontal, suelta
fascia frontale, sola

03195-10 CLAR Kopfspange allein aus
Metall mit Kabelaschen und
Fixierschraube mit Gelenk
CLAR spring metal head band
only, with cable clips and fixing
screw with socket joint
Casco frontal de resorte metálico
suelto de CLAR, con bridas de
cable, y tornillo de sujeción con
articulación
Fascia metallica a casco di CLAR,
solo, con portacordoni e vite di
fissaggio a snodo

Stethoskope
Stethoscopes
Estetoscopios
Stetoscopi

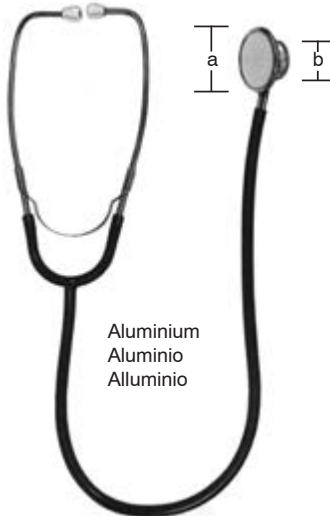

Aluminium
Aluminio
Alluminio

DUPLEX



Aluminium
Aluminio
Alluminio

ANESTOPHON
03248-00

	a	b	
03246-00	48 mm, 1.9"	30 mm, 1.2"	
03246-01	39 mm, 1.5"	25 mm, 1.0"	Baby
03246-02	21 mm, 0.8"	21 mm, 0.8"	Neonatal



PINARD
03260-15 15 cm, 6"
ALU



PINARD
03262-18 18 cm, 7"
Holz, wood, madera, legno

Perkussionshämmer
Percussion Hammers
Martillos de percusión
Martelli da percussione



TAYLOR - USA Mod.
03288-17 17 cm, 6 ³/₄"
03288-20 20 cm, 8"



BABINSKY
03292-22 22 cm, 8 ³/₄"

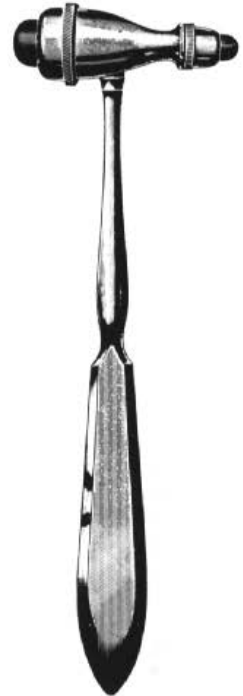

TROEMNER
03294-24 24 cm, 9 ¹/₂"



DEJERINE
03304-20 20 cm, 8"



BERLINER
03306-17 17 cm, 6 ³/₄"

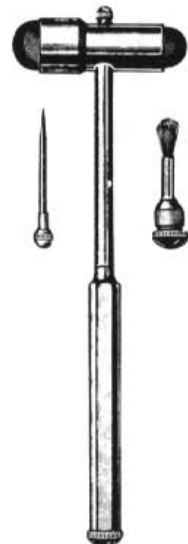

BUCK
03308-18 18 cm, 7"

Prüf- und Meßinstrumente
 Examination and Measuring Instruments
 Instrumentos para exámenes y medidas
 Strumenti per esaminare e misurare

Dynamometer
 Dynamometer
 Dinamómetro
 Dinamometro



COLLIN
 03310-01 Erwachsene, Adult,
 adultos, adulti
 03310-02 Kind, child, niños, bambini

Winkelmesser
 Goniometer
 Goniómetro
 Goniometro



MOELTGEN
 03312-01



Finger-Goniometer
 Finger goniometer
 Goniómetro para dedos
 Goniometro per le dita
 03314-01



WARTENBERG
 03320-19 19 cm, 7 1/2"



Wachstuchbandmaß
 Tape Measure, oil cloth
 Cinta métrica, tela encerada
 Metro a nastro in tela cerata

03350-15 1,8 m

mm / Inch

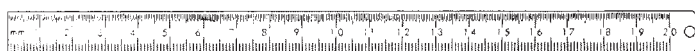

Metall

03340-10	10 cm	4"
03340-15	15 cm	6"
03340-20	20 cm	8"
03340-30	30 cm	12"
03340-50	50 cm	20"

Schieblehren
Calipers
Calibres
Calibro

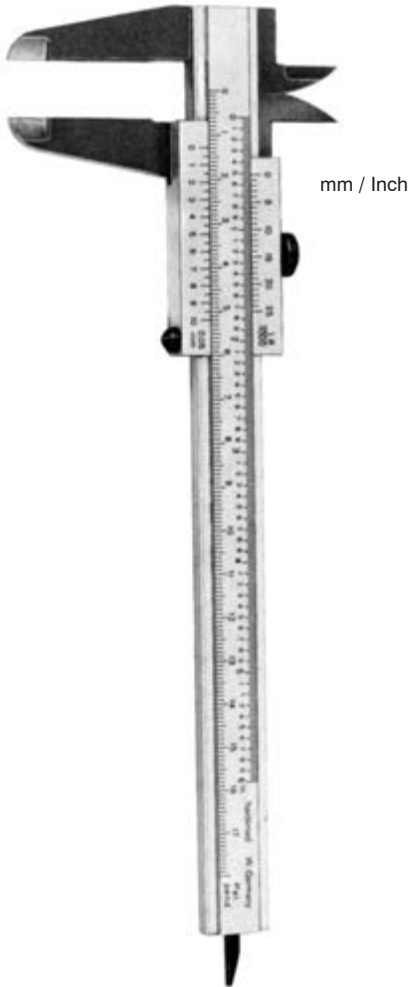

03360-21
21 cm, 8 1/4"

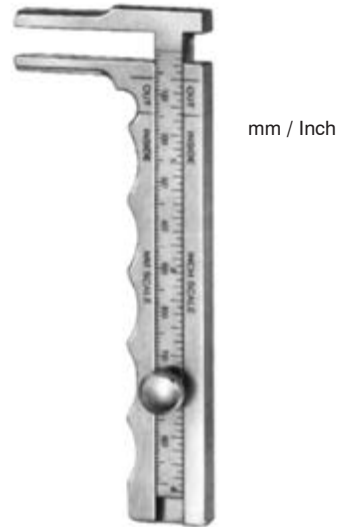

TOWNLEY
03361-10
11,5 cm, 4 1/2"

Saugrohre
Suction tubes
Tubos de aspiración
Cannule per aspirazione



POOLE 20 cm, 8"
05130-05 5.5 mm ø, 0.2"
(17 Fr.)

05130-10 10 mm ø, 0.4"
(30 Fr.)



POOLE 19 cm, 7 1/2"
05140-05 5.5 mm ø, 0.2"
(17 Fr.)

05140-08 8 mm ø, 0.3"
(23 Fr.)

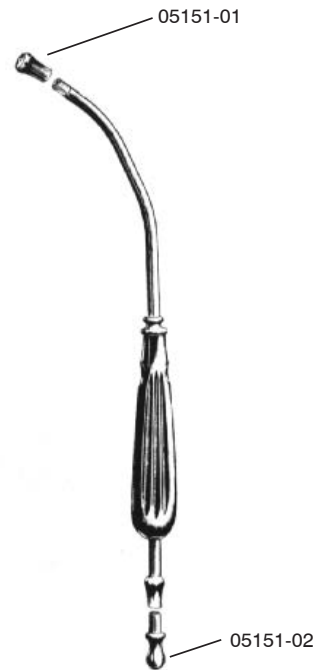

BABY-YANKAUER, compl.
05150-21 21 cm, 8 1/4"

YANKAUER, compl.
05150-27 27 cm, 10 1/2"

Kathetereinführzangen, Saugrohre
 Catheter Introducing Forceps, Suction tubes
 Pinzas para catéteres, Tubos de aspiración
 Pinze per introdurre le sonde, Cannule per aspirazione

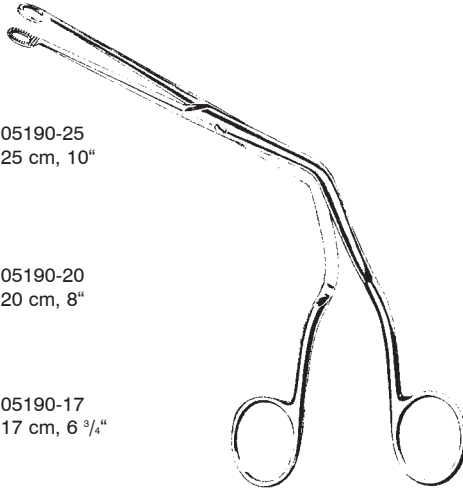
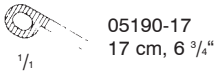
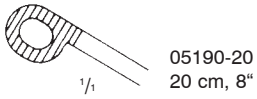
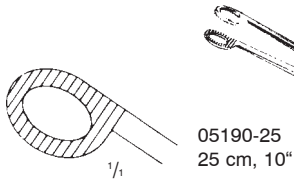

MAGILL



ANDREW-PYNCHON

05170-24
6 mm ø, 1/2"
24 cm, 9 1/2"



COOLEY
05160-02
8 mm ø, 0.3"
36 cm, 14 1/4"



COOLEY
05160-03
8 mm ø, 0.3"
30 cm, 11 3/4"



DE BAKEY
05160-04
3 mm ø, 0.1"
27 cm, 10 1/2"

Laryngoskope
Laryngoscopes
Laringoscopios
Laringoscopi



McINTOSH

Fig. 0	5,5 cm	2 1/4"	05210-00
Fig. 1	7,5 cm	3"	05210-01
Fig. 2	9,0 cm	3 1/2"	05210-02
Fig. 3	11,0 cm	4 3/8"	05210-03
Fig. 4	13,5 cm	5 1/4"	05210-04

Cold light
05211-00
05211-01
05211-02
05211-03
05211-04



05239-03
Halogen-Lampe
Halogen Lamp
Lámpara Halógena
Lampada Alogena



05239-01
f./p. Fig. 0-1



05239-02
f./p. Fig. 2-4

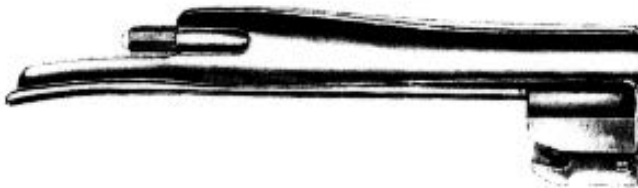

FOREGGER

Fig. 0	5,5 cm	2 1/4"	05220-00
Fig. 1	7,0 cm	2 3/4"	05220-01
Fig. 2	9,0 cm	3 1/2"	05220-02
Fig. 3	11,0 cm	4 3/8"	05220-03
Fig. 4	13,5 cm	5 1/4"	05220-04

Cold light
05221-00
05221-01
05221-02
05221-03
05221-04



05239-03
Halogen-Lampe
Halogen Lamp
Lámpara Halógena
Lampada Alogena



05239-01
f./p. Fig. 0-1



05239-02
f./p. Fig. 2-4

Laryngoskope
Laryngoscopes
Laringoscopios
Laringoscopi

MILLER



05230-00
55 mm, 2 1/2"
Nutzlänge
working length
largo útil
lunghezza utile

für Säuglinge
for babies
para neonatales
per neonati



05230-01
80 mm, 3 1/8"
Nutzlänge
working length
largo útil
lunghezza utile

für Kinder
for children
para niños
per bambini

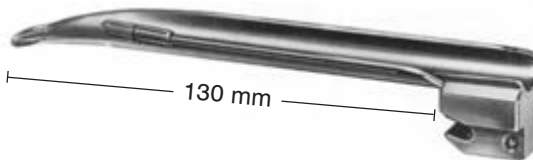

05230-02
130 mm, 5"
Nutzlänge
working length
largo útil
lunghezza utile

für Jugendliche
for adolescents
para adolescentes
per adolescenti

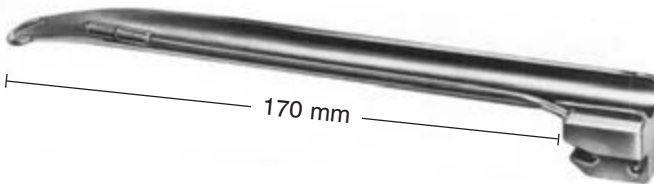

05230-03
170 mm, 6 3/4"
Nutzlänge
working length
largo útil
lunghezza utile

für Frauen
for women
para mujeres
per donne



05230-04
180 mm, 7"
Nutzlänge
working length
largo útil
lunghezza utile

für Männer
for men
para hombres
per uomini



05239-01
f./p. Fig. 0-1



05239-02
f./p. Fig. 2-4

Laryngoskope
Laryngoscopes
Laringoscopios
Laringoscopi



McINTOSH

05203-00

Set bestehend aus:
1 Etui
1 Batteriegriff 05234-28
3 Spatel (Fg. 1-3)

Set consisting of:
1 Case
1 Handle
3 Blades (Fg. 1-3)

Juego compuesto de:
1 Estuche
1 Mango
3 Hoja (Fg. 1-3)

Set composto da:
1 Astuccio
1 Manico
3 Spatole (Fg. 1-3)

05204-00

Set bestehend aus:
1 Etui
1 Batteriegriff 05234-28
4 Spatel (Fg. 1-4)

Set consisting of:
1 Case
1 Handle
4 Blades (Fg. 1-4)

Juego compuesto de:
1 Estuche
1 Mango
4 Hoja (Fg. 1-4)

Set composto da:
1 Astuccio
1 Manico
4 Spatole (Fg. 1-4)



FOREGGER

05223-00

Set bestehend aus:
1 Etui
1 Batteriegriff 05234-28
3 Spatel (Fg. 2-4)

Set consisting of:
1 Case
1 Handle
3 Blades (Fg. 2-4)

Juego compuesto de:
1 Estuche
1 Mango
3 Hoja (Fg. 2-4)

Set composto da:
1 Astuccio
1 Manico
3 Spatole (Fg. 2-4)

05224-00

Set bestehend aus:
1 Etui
1 Batteriegriff 05234-28
4 Spatel (Fg. 1-4)

Set consisting of:
1 Case
1 Handle
4 Blades (Fg. 1-4)

Juego compuesto de:
1 Estuche
1 Mango
4 Hoja (Fg. 1-4)

Set composto da:
1 Astuccio
1 Manico
4 Spatole (Fg. 1-4)

Batteriegriffe, Warmlicht
Battery handles, warm light
Mango de pila, luz caliente
Manico a batteria, luce calda



05233-18 18 mm \varnothing , $\frac{3}{4}$ "



05234-28 28 mm \varnothing , 1"
05234-37 37 mm \varnothing , 1 $\frac{1}{2}$ "



05238-01 30 mm \varnothing , 1 $\frac{1}{4}$ "

Batteriegriffe, Kaltlicht
Battery handles, cold light
Mango de pila, luz fria
Manico a batteria per luce fredda



05238-02
18 mm \varnothing
 $\frac{3}{4}$ "



05238-03
30 mm \varnothing
 $1 \frac{1}{4}$ "

Batteriegriffe, Warmlicht
 Battery handles, warm light
 Mango de pila, luz caliente
 Manico a batteria, luce calda



05240-30 30 mm \varnothing , 1 1/4"
 Griff mit Trafo-Anschluß
 Handle with Transformer-connection
 Mango con conexión al transformador
 Manico con connessione al trasformatore



05241-11 Trafo 120 V
 05241-22 Trafo 230 V

Trafo 120 Volt mit amerikanischem Netzanschluß
 Transformer 120 Volt with american mains connection
 Transformador 120 V con conexión americana
 Trasformatore 120 V ricarica batteria

Trafo 230 Volt mit 1,40 m (55") langem Kabel
 Transformer 230 Volt with cable 1,40 m (55") long
 Transformador, 230 V con cable de 1,40 m (55")
 Trasformatore 230 V ricarica batteria

Laryngoskope
Laryngoscopes
Laringoscopios
Laringoscopi

Operation Laryngoskop:
rostfreier Edelstahl
Rohr: innen matt/außen glänzend
Griff: ganz matt

Operation Laryngoscope:
stainless steel
tube: inner surface matt/outer
surface polished
handle: matt

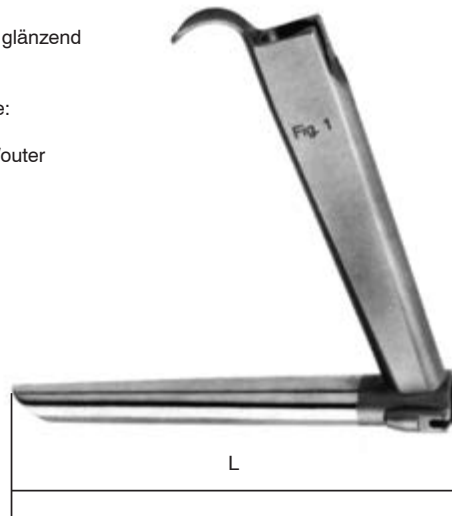

Laringoscopio para operaciones:
Acero inoxidable
Pala: Superficie interior: Mate
Superficie exterior: Brillante
Mango entero: Mate

Laringoscopio a luce
fredda per microchirurgia
endolaringeo
tubo: interiore opaco – esterno lucido
manico: opaco

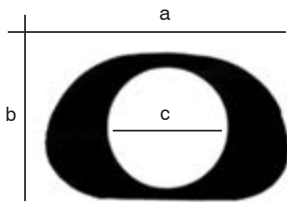

Nr.	L (mm)	a (mm)	b (mm)	c (mm)	Lichtträger light guide Portador de luz portatore di luce
05301-01	135	21,8	14,0	13,0	05302-01
05301-02	152	22,5	14,8	13,0	05302-01
05301-03	182	23,0	15,0	14,0	05302-02
05301-04	172	29,5	18,0	17,0	05302-02
05301-05	172	31,5	21,5	19,0	05302-02

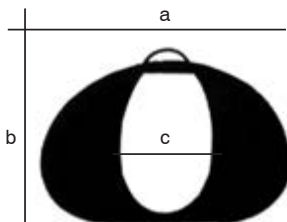

Nr.	L (mm)	a (mm)	b (mm)	c (mm)	Lichtträger light guide Portador de luz portatore di luce
05301-06	182	29,0	20,0	16,0 x 26,0	05302-02
05301-07	222	29,0	20,0	16,0 x 26,0	05302-03

Laryngoskope
Laryngoscopes
Laringoscopios
Laringoscopi

05300-01/02 Bruststütze für Erwachsene/Kinder bestehend aus:
05300-03 Stützstange für Erwachsene 34 cm / 05300-06 Ring / 05300-05 Gelenk
05300-04 Stützstange für Kinder 24 cm / 05300-06 Ring / 05300-05 Gelenk
05300-01/02 Chest Support for adults/children complete consisting of:
05300-03 Support rod for adults 34 cm / 05300-06 Ring / 05300-05 Joint
05300-04 Support rod for children 24 cm / 05300-06 Ring / 05300-05 Joint
05300-01/02 Soporte pectoral para adultos/niños compuesto de:
05300-03 para adultos 34 cm / 05300-06 / 05300-05
05300-04 para niños 24 cm / 05300-06 / 05300-05
05300-01/02 Braccio portalarinoscopio sternale per adulti/bambini composto da:
05300-03 per adulti 34 cm / 05300-06 anello / 05300-05 giunto
05300-04 per bambini 24 cm / 05300-06 anello / 05300-05 giunto

Operationslaryngoskop, Kleinsasser
Operation laryngoscope, Kleinsasser
Laringoscopios operativo, Kleinsasser
Laringoscopio operativo, Kleinsasser

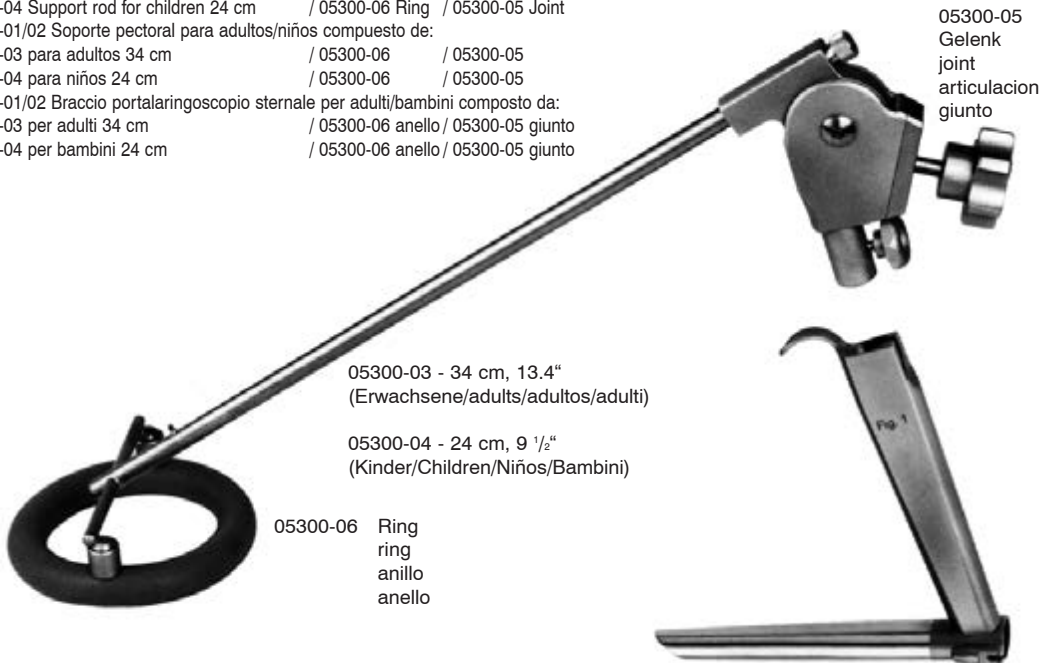

05300-05
Gelenk
joint
articulacion
giunto

05300-03 - 34 cm, 13.4"
(Erwachsene/adults/adultos/adulti)

05300-04 - 24 cm, 9 1/2"
(Kinder/Children/Niños/Bambini)

05300-06 Ring
ring
anillo
anello

Fiberglas-Lichtträger – Fiberglas-light-guide –
Portador de luz fria – portatore di luce fredda
a fibre di vetro



05302-01 for Laryngoskope
05301-01 - 05301-02

05303-01
Injektionskanüle für Laryngoskope: 05301-01 - 05301-07
Injetion drain tube for Laryngoscopes: 05301-01 - 05301-07
Canúla de inyeccion para laringoscopios: 05301-01 - 05301-07
Cannula da iniezione per laringoscopi: 05301-01 - 05301-07

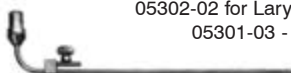

05302-02 for Laryngoskope
05301-03 - 05301-06

05304-01
Rauchabsaugrohr für Laryngoskop: 05301-03 - 05301-07
Suction tube for Laryngoscopes: 05301-03 - 05301-07
Canúla de succion para laringoscopios: 05301-03 - 05301-07
Tubo di aspirazione per laringoscopi: 05301-03 - 05301-07

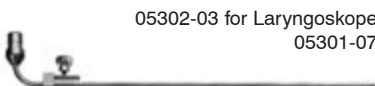

05302-03 for Laryngoskope
05301-07



Laryngoskope
Laryngoscopes
Laringoscopios
Laringoscopi

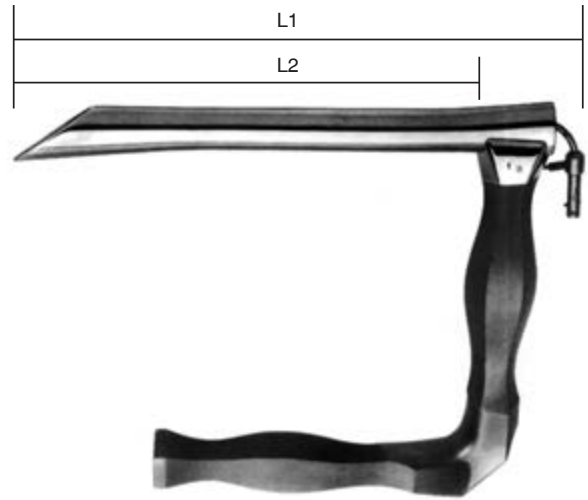

HOLINGER

Nr.	L1	L2	Lichtträger light guide Portador de luz portatore di luce
05310-01	180 mm	157 mm	05311-01
05310-02	170 mm	146 mm	05311-02
05310-03	120 mm	98 mm	05311-03
05310-04	90 mm	77 mm	05311-04

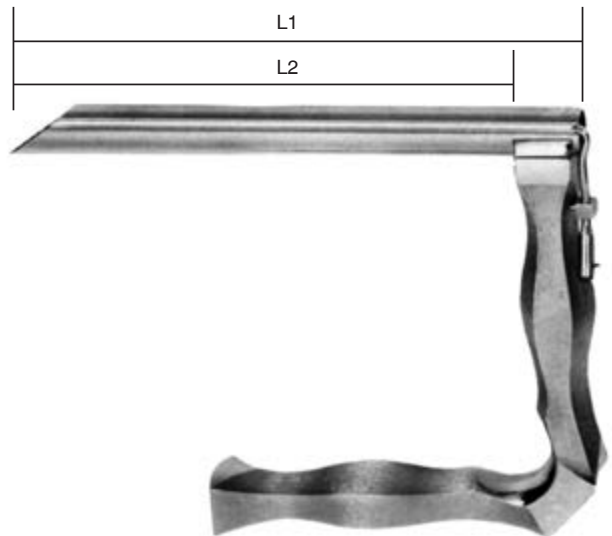

JACKSON

Nr.	L1	L2	Außen-Dm Outer-dm dm-exterior dm-esterno	Innen-Dm Inner-dm dm-interior dm-interno	Lichtträger light guide Portador de luz portatore di luce
05320-01	160 mm	135 mm	17,5 mm	14,5 mm	05321-01
05320-02	160 mm	135 mm	14,5 mm	12,0 mm	05321-02
05320-03	120 mm	105 mm	14,0 mm	11,5 mm	05321-03
05320-04	90 mm	75 mm	13,0 mm	10,0 mm	05321-04

Skalpelli-Griffe
 Scalpel Handles
 Mangos de bisturíes
 Manici per lama bisturi

passend zu den Klängen
 for blades
 para las hojas
 per lama bisturi

Ⓐ No. 10, 11, 12, 13, 14, 15, 16, 17, 18, 19

Ⓑ No. 20, 21, 22, 23, 24, 25



07103-00

Fig. 3

Ⓐ



07103-01

Fig. 3 grad.

Ⓐ



07103-02

Fig. 3 L

Ⓐ

Skalpell-Griffe
Scalpel Handles
Mangos de bisturías
Manici per lama bisturi



07104-00
Fig. 4
ⓑ



07104-02
Fig. 4 L
ⓑ

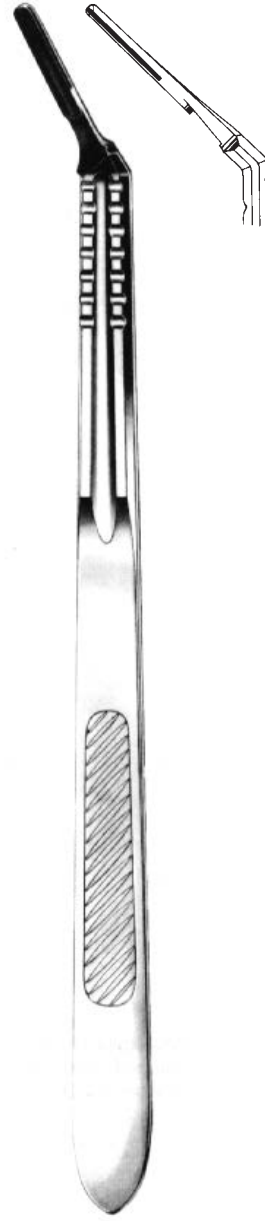

07105-02
Fig. 4 L
ⓑ

Skalpelli-Griffe
Scalpel Handles
Mangos de bisturíes
Manici per lama bisturi



07106-01
14,5 cm 5 3/4"

(A)



07106-02
14 cm 5 1/2"

(A)

Skalpelli-Griffe
Scalpel Handles
Mangos de bisturíes
Manici per lama bisturi



07107-00
16,5 cm, 6 1/2"
Fig. 7
Ⓐ



07107-01
12 cm, 4 3/4"
Fig. 7K
Ⓐ



07107-03
22,5 cm, 8.9"
Ⓐ



07107-04
22,5 cm, 8.9"
Ⓐ

Skalpell-Griffe
Scalpel Handles
Mangos de bisturíes
Manici per lama bisturi



07108-00
Fig. 8

(A)

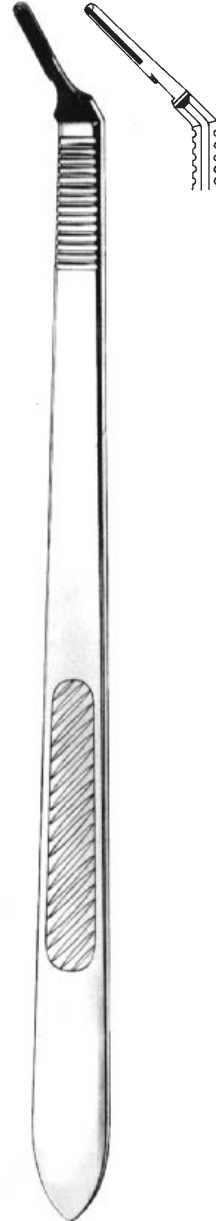

07109-03
Fig. 3 L

(A)

Skalpelli-Griffe
Scalpel Handles
Mangos de bisturíes
Manici per lama bisturi



07161-00 07162-00 07165-00 07167-00

Packung mit 10 Stück
box of 10
en cajas de 10 pzas
confezione di 10

07109-10 10,0 cm, 4"
07109-13 13,0 cm, 5"
07109-15 15,5 cm, 6"



Amputationsmesser
Amputation Knives
Cuchillos para amputaciòn
Coltelli per amputazione

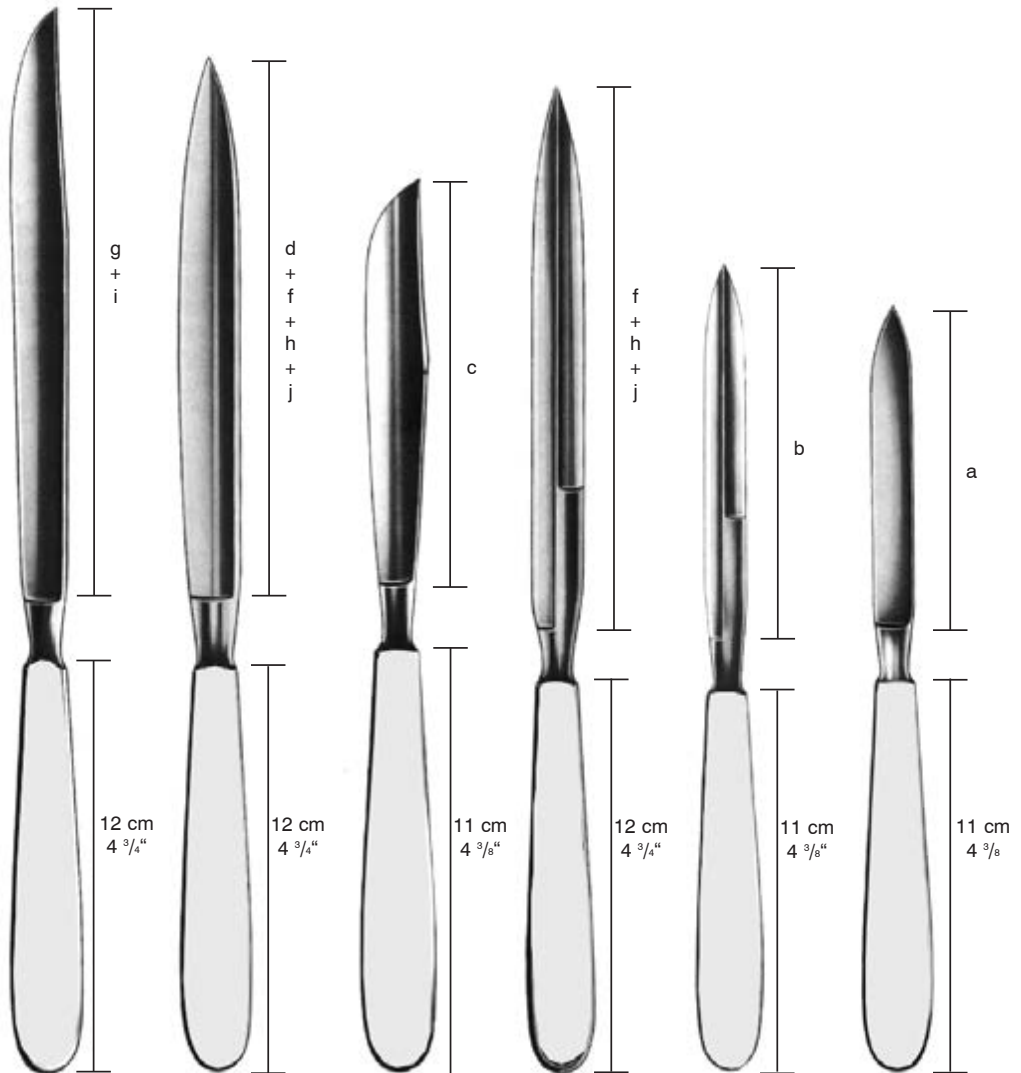

LISTON
07200-17
07200-20

REDA
07201-13
07201-16
07201-19
07201-22

LANGENBECK
07202-12

CATLIN
doppelschneidig
double cutting
filo doble
doppio taglio
07203-16
07203-19
07203-22

07204-11
Zwischenknochen-
messer doppel-
schneidig
Inerosseous knife
double cutting
Cuchillo interóseo
filo doble
Coltello interosseo
doppio taglio

07205-09
Phalangen-
messer
Phalangeal knife
Cuchillos para
falanges
Coltello per falangi

Schnittlänge
Length of blades
Largo de hojas
Lunghezze delle lame

a - 9,5 cm	c - 12,0 cm	e - 15,0 cm	g - 17,0 cm	i - 20,0 cm
b - 11,0 cm	d - 13,0 cm	f - 16,0 cm	h - 19,0 cm	j - 22,0 cm
a - 3 3/4"	c - 4 3/4"	e - 6"	g - 6 3/4"	i - 8"
b - 4 3/8"	d - 5"	f - 6 1/4"	h - 7 1/2"	j - 8 3/4"

Klingenbrecher, Rasierklingen
Blade Breakers, Razor Blades
Rompe-hojas, hojas de afeitar
Lama di rasoio, Rompilamette



TROUTMAN-CHRIS
07290-09 9 cm, 3 1/2"



REDA
07291-11 11 cm, 4 3/8"



CASTROVIEJO
07294-13 13 cm, 5 1/8"

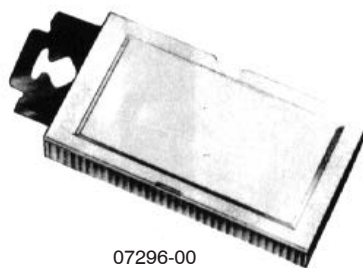

07296-00

Packung = 10 Stück
package = 10 each
caja = 10 c/u
confezione = 10 pezzi

Skalpelle mit Metallheft
 Scalpels with Metal Handle
 Bisturíes, mango metálico
 Bisturi, manico di metallo



Fig. 1
 07402-01
 15 cm, 6"
 30 mm, 1.2"



Fig. 2
 07402-02
 15 cm, 6"
 36 mm, 1.4"



Fig. 3
 07402-03
 15,5 cm, 6"
 40 mm, 1 1/2"



Fig. 4
 07402-04
 16 cm, 6 1/4"
 45 mm, 1 3/4"



Fig. 5
 07402-05
 16 cm, 6 1/4"
 50 mm, 2"



Fig. 6
 07402-06
 15 cm, 6"
 27 mm, 1"



Fig. 7
 07402-07
 15 cm, 6"
 35 mm, 1.4"



Fig. 8
 07402-08
 16 cm, 6 1/4"
 40 mm, 1 1/2"



Fig. 9
 07402-09
 16 cm, 6 1/4"
 47 mm, 1.9"



Fig. 10
 07402-10
 17 cm, 6 3/4"
 50 mm, 2"

Resektions- und Knorpelmesser
 Resection and Cartilage Knives
 Cuchillos para resección/cartilagos
 Coltelli per resezione e cartilagini



6,5 cm
2.6"

Beinhautmesser
 mit Schaber
 Periosteum Knife
 with raspatory
 Cuchillo para
 periostio, con
 periostótamo
 Coltello per
 periostio con
 raschino

19 cm, 7 1/2"

07403-01

Metallheft
 metal handle
 mango metálico
 manico di metallo



6,5 cm
2.6"

19 cm, 7 1/2"

07403-02

Holzheft
 wooden handle
 mango de madera
 manico in legno



5,5 cm
2.2"

18 cm, 7"

LANGENBECK
07410-05



18 cm, 7"

LANGENBECK
07412-05

Sezier-, Hirn- und Organmesser
Autopsy- Brain- and Post mortem knives
Cuchillos para autopsia- cerebro- órganos
Coltelli per cartilagini- cervello e organi

Schnittlänge
Length of blades
Largo de hojas
Lunghezze delle lame

- a - 8,5 cm, 3,4"
- b - 9,5 cm, 3 3/4"
- c - 11,0 cm, 4 3/8"
- d - 14,0 cm, 5 1/2"
- e - 16,0 cm, 6 1/4"
- f - 17,0 cm, 6 3/4"
- g - 19,5 cm, 7 3/4"
- h - 20,0 cm, 8"
- i - 24,0 cm, 9 1/2"

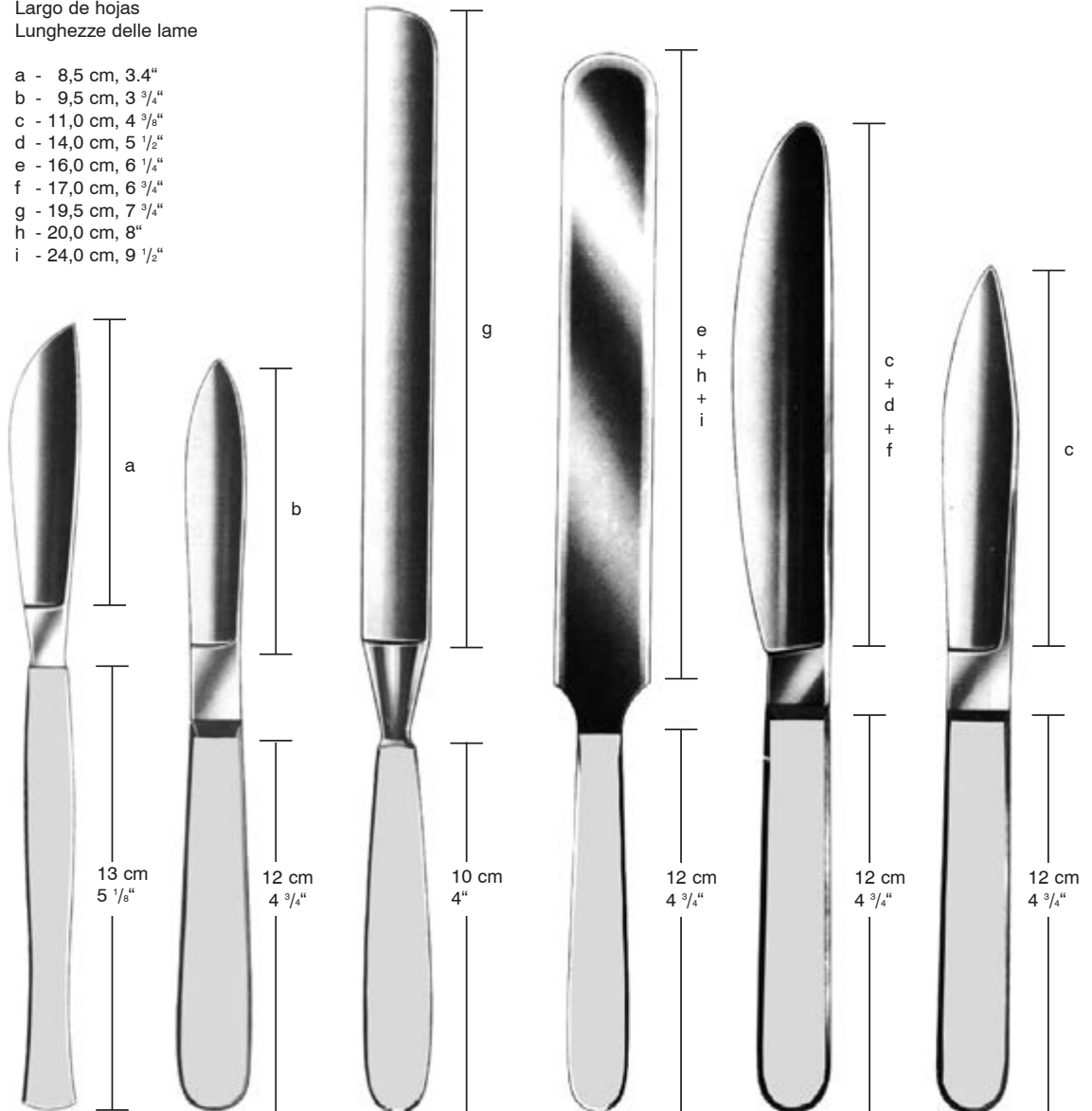

VIRCHOW
07420-08

VIRCHOW
07421-09

07422-19

VIRCHOW
07423-16
07423-20
07423-24

07424-11
07424-14
07424-17

07425-11

Dermatome, Rasiermesser
 Dermatome, Razor
 Dermátomo, Navajas
 Dermatomo, Rasoio



SCHINK
 07490-00
 30 cm, 11 3/4"
 0,1 - 2 mm
 compl.
 mit/with/con

07490-01 (1) Stk./ pcs/ pzas
 07490-02 (2) Stk./ pcs/ pzas



07490-01
 Ersatzklinge
 Spare blade
 Hoja de repuesto
 Lama di ricambio per dermatomo

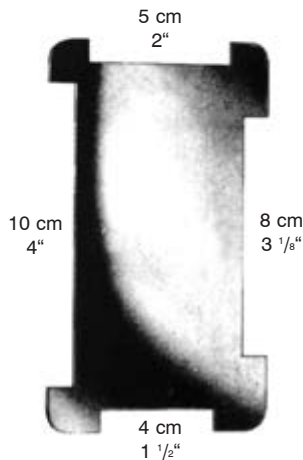

07490-02
 Spannplatte
 Skin straightening plate
 Placa para extender la piel
 Placca per stendipelle



07496-00
 Rasiermesser 8 cm, 3 1/8"
 Razors 8 cm, 3 1/8"
 Navajas 8 cm, 3 1/8"
 Rasoio 8 cm, 3 1/8"

Dermatome
 Dermatome
 Dermátomo
 Dermatomo



07496-31
 Ersatzklingen
 Spare blades
 Hoja de repuesto
 Lama di ricambio



07296-00
 Ersatzklingen
 Spare blades
 Hoja de repuesto
 Lama di ricambio



07499-01
 Ersatzklingen
 Spare blades
 Hoja de repuesto
 Lama di ricambio

für handelsübliche Rasierklingen
 for usual razor blades
 para hojas de afeitar usuales
 per lamette da barba normali

HUMBY

07495-31 31 cm, 12 1/4"
 0,1 - 1,5 mm
 mit 1 Klinge
 with 1 blade
 con 1 hoja
 con 1 lama

SILVER

07498-00 19 cm, 7 1/2"
 mit 1 Klinge
 with 1 blade
 con 1 hoja
 con 1 lama

WATSON

07499-00 30 cm, 11 3/4"
 0,1 - 1,5 mm
 mit 1 Klinge
 with 1 blade
 con 1 hoja
 con 1 lama

Chirurgische Scheren
 Operating Scissors
 Tijeras para cirugía
 Forbici per chirurgia

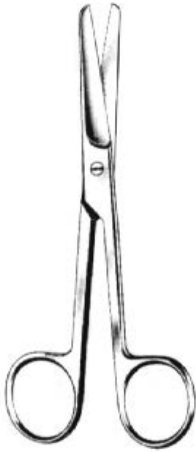

STANDARD
 09102-11 11,5 cm, 4 1/2"
 09102-13 13,0 cm, 5"
 09102-14 14,5 cm, 5 3/4"
09104-14 TC
 09102-15 15,5 cm, 6"
 09102-16 16,5 cm, 6 1/2"
 09102-18 18,5 cm, 7 1/4"
 09102-20 20,0 cm, 8"



STANDARD
 09110-11 11,5 cm, 4 1/2"
 09110-13 13,0 cm, 5"
 09110-14 14,5 cm, 5 3/4"
09114-14 TC
 09110-15 15,5 cm, 6"
 09110-16 16,5 cm, 6 1/2"
 09110-18 18,5 cm, 7 1/4"
 09110-20 20,0 cm, 8"



STANDARD
 09120-11 11,5 cm, 4 1/2"
 09120-13 13,0 cm, 5"
 09120-14 14,5 cm, 5 3/4"
09124-14 TC
 09120-15 15,5 cm, 6"
 09120-16 16,5 cm, 6 1/2"
 09120-18 18,5 cm, 7 1/4"
 09120-20 20,0 cm, 8"



STANDARD
 09103-11 11,5 cm, 4 1/2"
 09103-13 13,0 cm, 5"
 09103-14 14,5 cm, 5 3/4"
09105-14 TC
 09103-15 15,5 cm, 6"
 09103-16 16,5 cm, 6 1/2"
 09103-18 18,5 cm, 7 1/4"
 09103-20 20,0 cm, 8"



STANDARD
 09111-11 11,5 cm, 4 1/2"
 09111-13 13,0 cm, 5"
 09111-14 14,5 cm, 5 3/4"
09115-14 TC
 09111-15 15,5 cm, 6"
 09111-16 16,5 cm, 6 1/2"
 09111-18 18,5 cm, 7 1/4"
 09111-20 20,0 cm, 8"

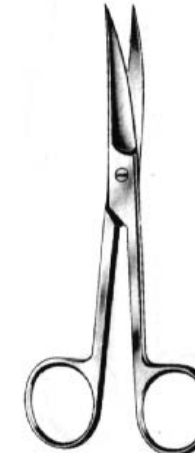

STANDARD
 09121-11 11,5 cm, 4 1/2"
 09121-13 13,0 cm, 5"
 09121-14 14,5 cm, 5 3/4"
09125-14 TC
 09121-15 15,5 cm, 6"
 09121-16 16,5 cm, 6 1/2"
 09121-18 18,5 cm, 7 1/4"
 09121-20 20,0 cm, 8"

Chirurgische Scheren
 Operating Scissors
 Tijeras para cirugía
 Forbici per chirurgia



Inzisionsschere
 Incision Scissors
 Tijera de incision
 Forbici per incisione

09128-14
 14,0 cm
 5 1/2"

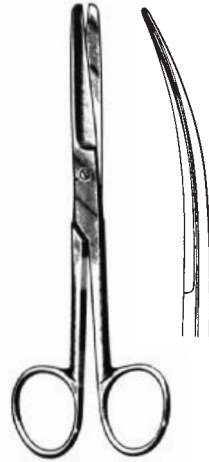

— DEAVER —
 09130-14 14 cm 09131-14
 5 1/2"

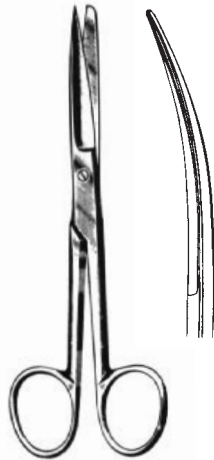

— DEAVER —
 09140-14 14 cm 09141-14
 5 1/2"

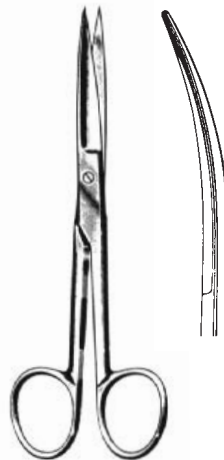

— DEAVER —
 09150-14 14 cm 09151-14
 5 1/2"

Präparierscheren
 Dissecting Scissors
 Tijeras de disección
 Forbici per dissezione



MAYO

09160-14	14,5 cm	09161-14
09164-14 TC	5 3/4"	09165-14 TC
09160-17	17,0 cm	09161-17
09164-17 TC	6 3/4"	09165-17 TC
09160-19	19,0 cm	09161-19
	7 1/2"	
09160-23	23,0 cm	09161-23
09164-23 TC	9"	09165-23 TC
09160-28	28,0 cm	09161-28
	11"	

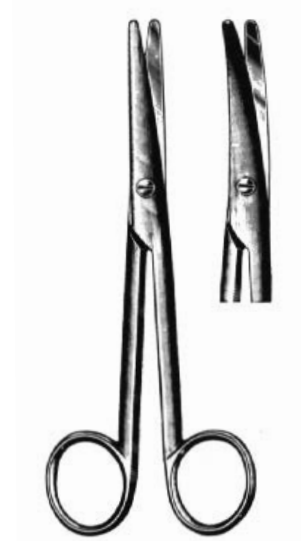

MAYO-STILLE

09170-15	15,0 cm	09171-15
09174-15 TC	6"	09175-15 TC
09170-17	17,0 cm	09171-17
09174-17 TC	6 3/4"	09175-17 TC
09170-21	21,0 cm	09171-21
09174-21 TC	8 1/4"	09175-21 TC

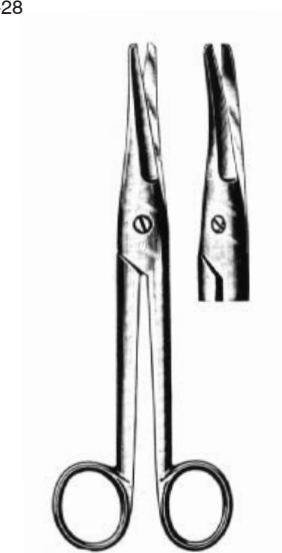

MAYO-NOBLE

09180-17	17,0 cm	09181-17
	6 3/4"	



Präparierscheren
Dissecting Scissors
Tijeras de disección
Forbici per dissezione



LEXER
09190-16
09194-16 TC
16 cm, 6 1/4"

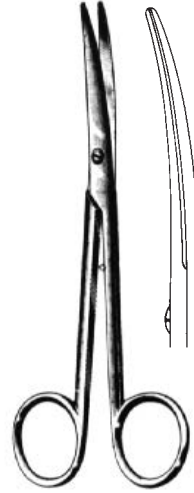

LEXER
09191-16
09195-16 TC
16 cm, 6 1/4"



— LEXER BABY —
09202-10 09203-10
09206-10 TC 09207-10 TC
10 cm, 4"

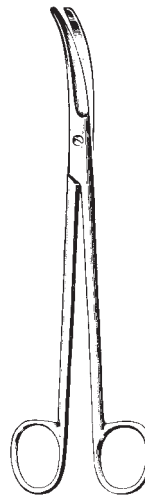

JORGENSEN
09204-22
22 cm, 8 3/4"

Präparierscheren
Dissecting Scissors
Tijeras de disección
Forbici per dissezione



METZENBAUM	
09280-12	09284-12 TC
12 cm	4 3/4"
09280-15	09284-15 TC
15 cm	6"
09280-18	09284-18 TC
18 cm	7"
09280-20	09284-20 TC
20 cm	8"
09280-23	09284-23 TC
23 cm	9"
09280-25	09284-25 TC
25 cm	10"
09280-28	09284-28 TC
28 cm	11"
09280-30	09284-30 TC
30 cm	12"



METZENBAUM	
09281-12	09285-12 TC
12 cm	4 3/4"
09281-15	09285-15 TC
15 cm	6"
09281-18	09285-18 TC
18 cm	7"
09281-20	09285-20 TC
20 cm	8"
09281-23	09285-23 TC
23 cm	9"
09281-25	09285-25 TC
25 cm	10"
09281-28	09285-28 TC
28 cm	11"
09281-30	09285-30 TC
30 cm	12"



METZENBAUM FINO	
09282-15	09286-15 TC
15 cm	6"
09282-18	09286-18 TC
18 cm	7"
09282-20	09286-20 TC
20 cm	8"
09282-23	09286-23 TC
23 cm	9"
09282-25	09286-25 TC
25 cm	10"
09282-28	09286-28 TC
28 cm	11"

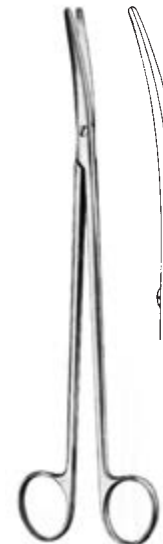

METZENBAUM FINO	
09283-15	09287-15 TC
15 cm	6"
09283-18	09287-18 TC
18 cm	7"
09283-20	09287-20 TC
20 cm	8"
09283-23	09287-23 TC
23 cm	9"
09283-25	09287-25 TC
25 cm	10"
09283-28	09287-28 TC
28 cm	11"

Präparierschere, Kapselschere
Dissecting Scissors, Capsula Scissor
Tijeras de disección, Tijera p. cápsula
Forbici per dissezione, Forbici per capsula



WELLER
09289-28
28 cm, 11"



RESANO
09290-25
25 cm, 10"

Präparierscheren, Ligaturscheren
 Dissecting Scissors, Ligature Scissors
 Tijeras de disección, Tijeras para ligaduras
 Forbici per dissezione, Forbici per legature



METZENBAUM "S"

09291-18 18 cm, 7" 09295-18 TC
 09291-20 20 cm, 8" 09295-20 TC
 09291-23 23 cm, 9" 09295-23 TC

Wellenschliff - wave cut

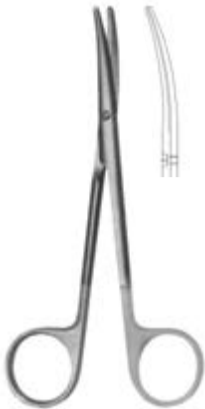

09296-15 TC
 14,5 cm 5 3/4"



09296-18 TC
 18 cm 7"



09296-23 TC
 23 cm 9"

Präparierscheren
 Dissecting Scissors
 Tijeras de disección
 Forbici per dissezione

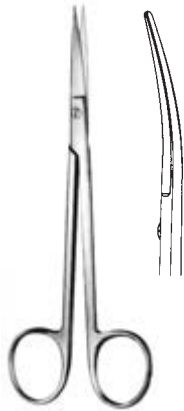

— SANVENERO —
 09302-14 14 cm 09303-14
 5 1/2"



— JOSEPH —
 09304-14 14 cm 09305-14
 5 1/2"

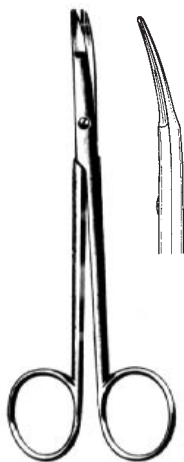

— KILNER —
 09310-12 12 cm **09314-12 TC**
 09310-15 15 cm
 09312-12 12 cm gerade/straight/recta/retta



— REYNOLDS —
 09320-15 15 cm 09321-15
 09321-18
09325-15 TC

Chirurgische Scheren, fein
 Operating Scissors, fine
 Tijeras para cirugía, finas
 Forbici per chirurgia, fine



IRIS



09340-09 9 cm
 09340-10 10 cm
 09340-11 11 cm
09344-11 TC

gerade
 straight
 rectas
 rette



09341-09
 09341-10
 09341-11
09345-11 TC

gebogen
 curved
 curvas
 curve

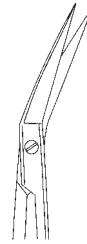

09346-11 11 cm

abgewinkelt
 angled
 angulada
 angolata

Chirurgische Scheren, Präparierscheren
Operating Scissors, Dissecting Scissors
Tijeras para cirugía, Tijeras de disección
Forbici per chirurgia, Forbici per dissezione

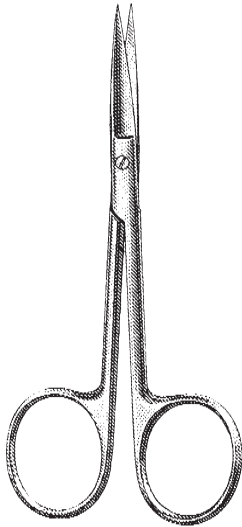

KNAPP
10 cm, 4"
09348-01 09348-02

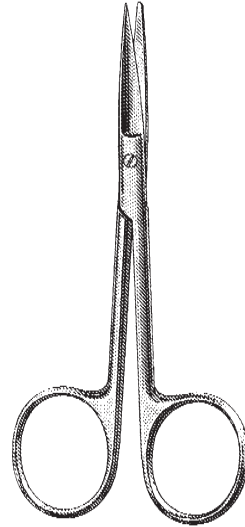

KNAPP
10 cm, 4"
09348-03 09348-04

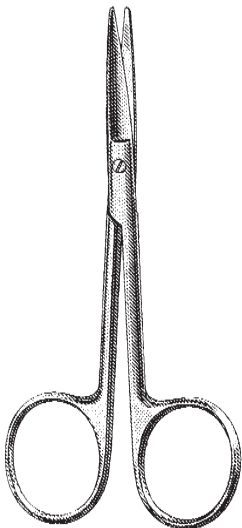

KNAPP
10 cm, 4"
09348-05 09348-06



LITTLER
12 cm, 4 3/4"
09349-12

Präparierscheren, feines Modell
Dissecting Scissors, fine pattern
Tijeras de disección, finas
Forbici per preparazione, modello fino

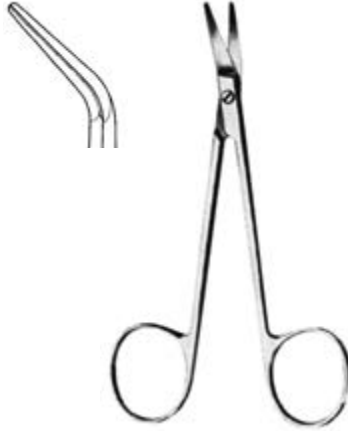

GRAEFE
09350-10
10 cm 4"



COTTLE
09358-11
11,5 cm 4 1/2"

Präparierscheren, feines Modell
Dissecting Scissors, fine pattern
Tijeras de disección, finas
Forbici per preparazione, modello fino



— GRADLE —
09350-09 9,5 cm, 3³/₄" 09351-09



— —
09352-09 9,5 cm, 3³/₄" 09353-09



— —
09354-10 10 cm, 4" 09355-10



— —
09356-10 10 cm, 4" 09357-10

Scheren
Scissors
Tijeras
Forbici

Sehnenscheren
Tendon Scissors
Tijeras para tendones
Forbici per tenotomia

Enucleationsschere
Enucleation Scissors
Tijera para enucleación
Forbici per enucleazione

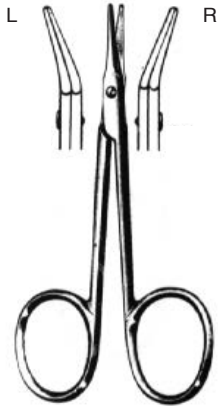

09347-09 AEBLI 9 cm 09349-09
3 1/2"



STEVENS
11 cm
4 3/8"



09360-11 09361-11



09362-11 09363-11



LANDOLT
09381-11
12 cm, 4 3/4"

Nasenscheren - Nasal Scissors - Tijeras nasales - Forbici nasali



STRABISMUS
09370-11 09371-11
09374-11 TC 09375-11 TC
11 cm, 4 3/8"



HEYMANN
09401-18
18 cm, 7"



FOMON
09403-15
15 cm, 6"

Tonsillen-, Gefäßscheren
 Tonsil, Vascular Scissors
 Tijeras amígdalas y vasculares
 Forbici per tonsilli e vascolari



COTTLE
 09405-16
09406-16 TC
 16 cm, 6 1/4"

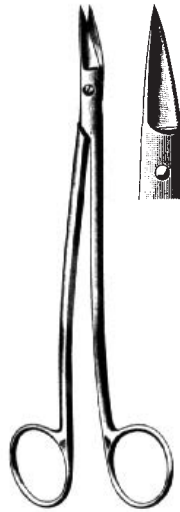

DEAN
 09425-17 09427-17
 17 cm, 6 3/4"

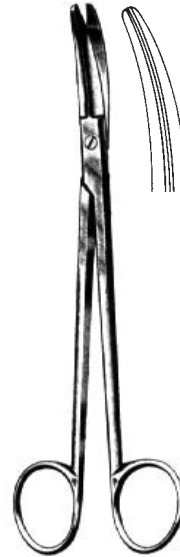

BOETTCHER
 09435-18
 18 cm, 7"

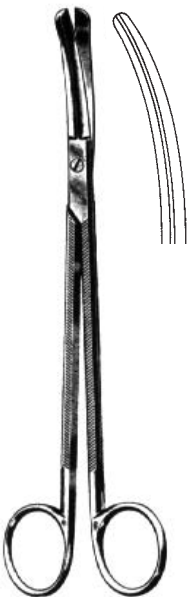

GOOD
 09437-19
 19 cm, 7 1/2"

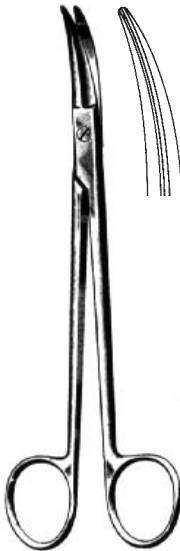

PRINCE
 09439-17
 17 cm, 6 3/4"



09468-15
 15 cm, 6"



09470-11
 11 cm, 4 3/8"

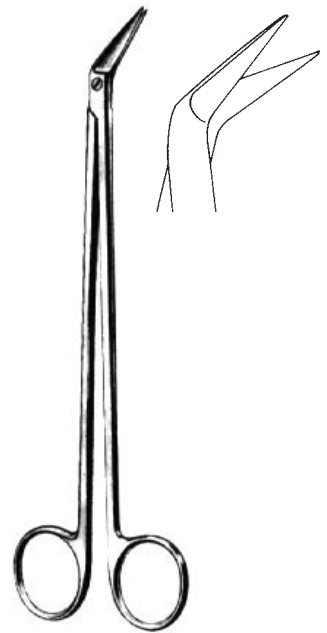

POTTS-DE MARTEL
 09473-21
 21 cm, 8 1/4"

Scheren, Thorax und Gefäße
 Scissors, thorax and vascular
 Tijeras, torácicas y vasculares
 Forbici vascolari e toraciche



DIETRICH
 09475-25 – 09475-00
 17 cm, 6 3/4"



09475-25
09476-25 TC
 18 cm, 7"

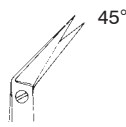

09475-45
09476-45 TC
 18 cm, 7"

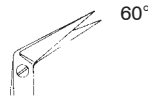

09475-60
09476-60 TC
 17,5 cm, 6,9"

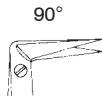

09475-90
09476-90 TC
 17 cm, 6 3/4"



09475-00
09476-00 TC
 17 cm, 6 3/4"



DIETRICH
 09477-01
 17 cm, 6 3/4"

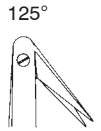

DE BAKEY
 (POTTS-SMITH)



09478-25
 19 cm
 7 1/2"



09478-45
 19 cm
 7 1/2"

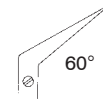

09478-60
 19 cm
 7 1/2"



09479-25
 23 cm
 9"

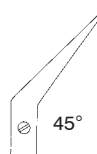

09479-45
 23 cm
 9"

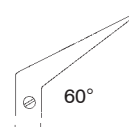

09479-60
 23 cm
 9"

Gefäßscheren
 Vascular Scissors
 Tijeras vasculares
 Forbici vascolari



POTTS-SMITH
 19 cm, 7 1/2"

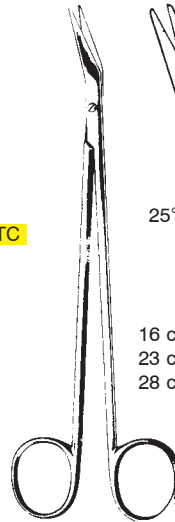
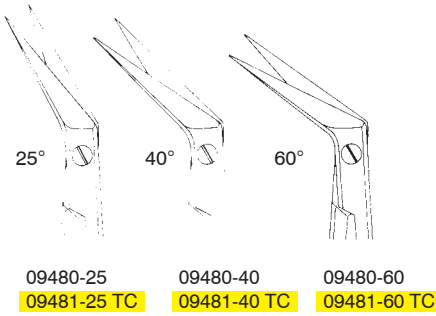

DE BAKEY

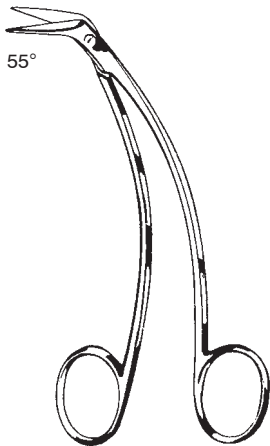
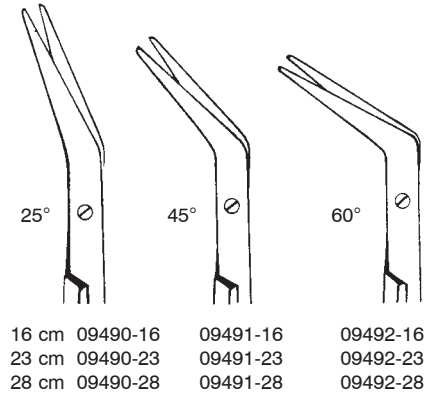

FAVALORO
 09496-15 15 cm, 6"

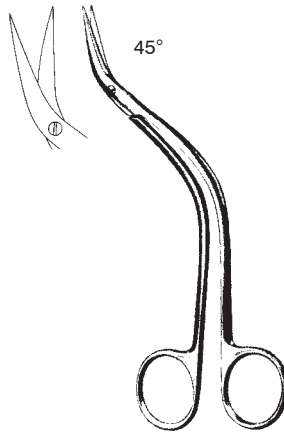

DE BAKEY
 09497-15 15,5 cm, 6"



KELLY
 09540-16 09541-16
09542-16 TC **09543-16 TC**
 16 cm, 6 1/4"

Gynäkologische Scheren
 Gynecological Scissors
 Tijeras ginecológicas
 Forbici ginecologiche

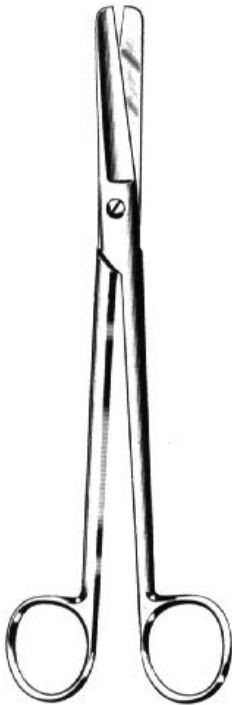

SIMS

09510-20	20 cm, 8"	09511-20
09510-23	23 cm, 9"	09511-23
09516-23 TC	23 cm, 9"	09517-23 TC



09512-20
 09512-23



09513-20
 09513-23



09514-20
 09514-23



09515-20
 09515-23



SIEBOLD

09523-24 24 cm, 9 1/2"

Gynäkologische Scheren
 Gynecological Scissors
 Tijeras ginecológicas
 Forbici ginecologiche

Parametriumscheren - Parametrium scissors - Parametrium nasales - Parametrium nasali

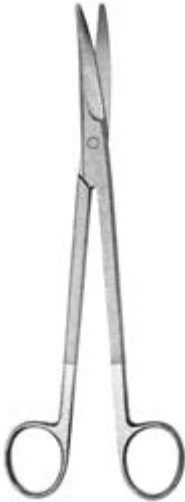

REDA

09501-23	23 cm, 9"
09505-23 TC	23 cm, 9"
09505-26 TC	26 cm, 10 1/4"
09505-30 TC	30 cm, 12"



09501-22	22,5 cm, 8.9"
09507-23 TC	23 cm, 9"
09507-26 TC	26 cm, 10 1/4"
09507-30 TC	30 cm, 12"



WERTHEIM

09525-22 22,5 cm, 8.9"



DOYEN

09530-17 09531-17
17,5 cm, 6.9"



DUBOIS

09536-27 09537-27
27 cm, 10 1/2"

Episiotomiescheren, Nabelschnurscheren
 Episiotomy Scissors, Umbilical Scissors
 Tijeras para episiotomía, Tijeras umbilicales
 Forbici per episiotomia, Forbici ombelicali



gezahnt
 saw edge
 dentadas
 dentellata

WALDMANN
 09548-18
 18 cm, 7"



U.S.A. Mod.
 09550-10
 10,5 cm, 4"

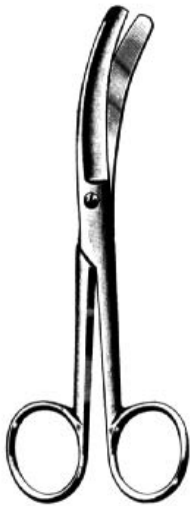

BUSCH
 09551-16
 16 cm, 6 1/4"



SCHUMACHER
 09553-16
 16 cm, 6 1/4"



BRAUN-STADLER
 09560-14 14,5 cm, 5 3/4"
 09560-22 22,0 cm, 8 3/4"

Neurochirurgische Scheren, Gefäßschere, Präparierscheren
 Neurosurgical Scissors, Vascular Scissors, Dissecting Scissors
 Tijera para neurocirugía, Tijeras vasculares, Tijeras de disección
 Forbici per neurochirurgia, Forbici vascolari, Forbici per preparazione

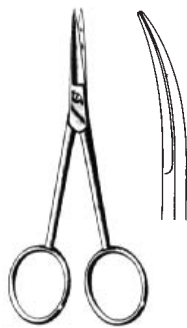

09580-11 09581-11
 11 cm, 4 ³/₈"

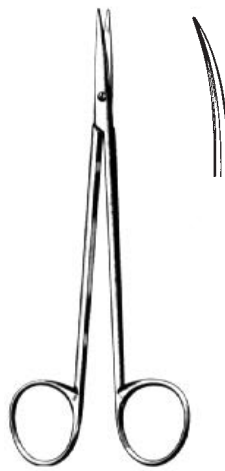

09582-15 09583-15
 15 cm, 6"

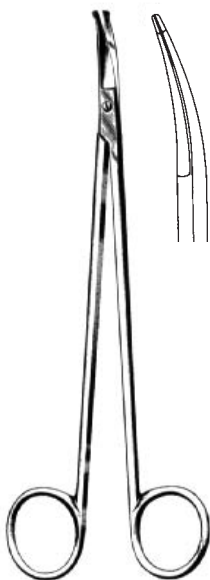

STRULLY
 09601-22
 22 cm, 8 ³/₄"



TOENNIS-ADSON
 09610-18
 18 cm, 7"

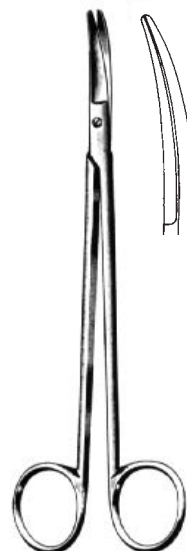

TOENNIS-ADSON
 09611-18
 18 cm, 7"

Knorpelscheren, Nasenschere, Gefäßscheren
 Cartilage Scissors, Nasel Scissors, Vascular Scissors
 Tijeras para cartilago, Tijeras nasales, Tijeras vasculares
 Forbici per cartilagine, Forbici nasali, Forbici vascolari

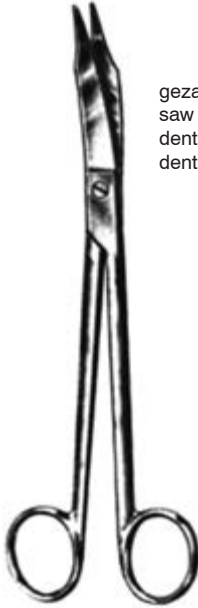

gezahnt
 saw edge
 dentadas
 dentellata

MARTIN
 09613-20
 20 cm, 8"



McINDOE
 09614-19
 19 cm, 7 1/2"



FOMON
 09617-13
 13 cm, 5 1/8"



SCHMIEDEN-TAYLOR
 09619-17
 17 cm, 6 3/4"

Gefäßscheren, Präparierscheren
Vascular Scissors, Dissecting Scissors
Tijeras vasculares, Tijeras de disección
Forbici vascolari, Forbici per preparazione

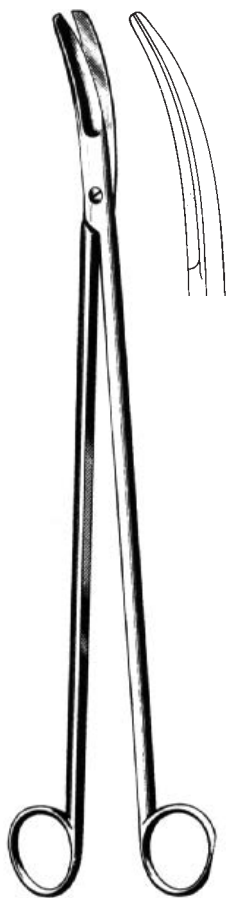

CRAFOORD
09641-30
30 cm, 11 ³/₄"

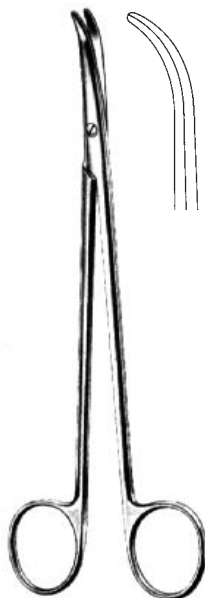

THOREK
09643-19 19 cm, 7 ¹/₂"
09643-25 25 cm, 10"

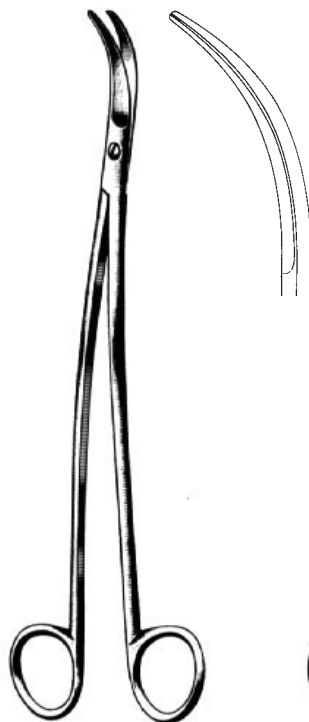

SATINSKY
09651-24
24,5 cm, 9 ¹/₂"

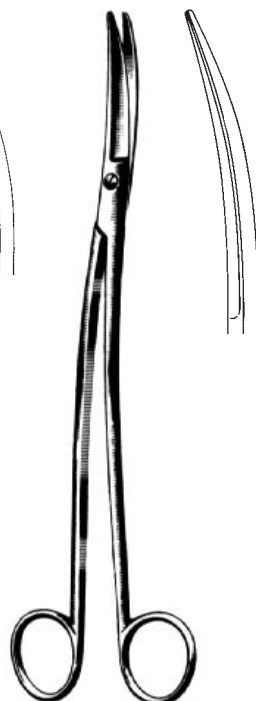

KLINKENBERGH-LOTH
09661-23
23 cm, 9"

Darmscheren, Nagelspaltschere, Fadenscheren
 Enterotomy Scissors, Nail Splitting Scissors, Stitch Scissors
 Tijeras para intestino, Tijeras para hender uña, Tijeras para hilos
 Forbici per enterotomia, Forbici per staccare unghie, Forbici per legature



FERGUSSON
 09770-18
 18 cm, 7"

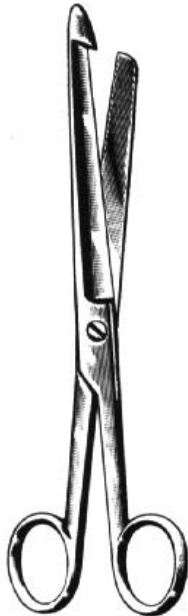

09772-21
 21 cm, 8 1/4"



09774-21
 21 cm, 8 1/4"



SYSTRUNK
 09775-13 09777-13
 13 cm, 5 1/8"



SPENCER
 09802-09
 9 cm, 3 1/2"



SPENCER
 09802-11
 11 cm, 4 3/8"



NORTHBENT
 09803-09 9 cm, 3 1/2"
 09803-13 13 cm, 5 1/8"



LITTAUER
 09804-14
 14 cm, 5 1/2"



HEATH
 09809-15
 15 cm, 6"

Zahnfleissscheren, feine Scheren, Drahtschere
 Gum Scissors, Delicate Scissors, Wire Cutting Scissors
 Tijeras para encías, Tijeras finas, Tijeras para alambre
 Forbici per gengiva, Forbici delicate, Forbici per filo di metallo

1 Schneide gezahnt
 1 blade toothed
 1 hoja dentada
 1 taglio della lama dentellato

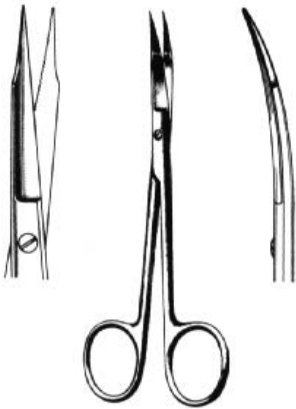

GOLDMAN-FOX
 09820-13 13 cm, 5 1/8" 09821-13

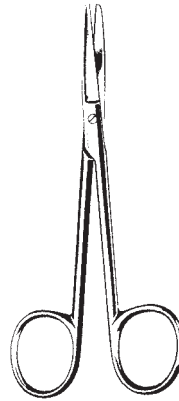

WAGNER
 12 cm, 4 3/4"

gerade
 straight
 rectas
 rette



Fig. 1
 09828-12



Fig. 2
 09826-12



Fig. 3
 09824-12

gebogen
 curved
 curvas
 curve



Fig. 1
 09823-12



Fig. 2
 09829-12



Fig. 3
 09825-12



QUINBY
 09827-12 12 cm, 4 3/4"



UNIVERSAL
 09831-12 12 cm, 4 3/4"
 09835-12 TC 12 cm, 4 3/4"

Kronenscheren
Crown Scissors
Tijeras para coronas
Forbici per corona

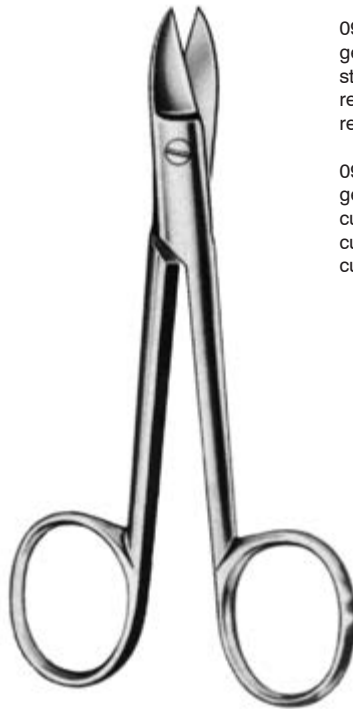

09850-10
gerade spitz
straight pointed
rectas agudas
rette acute

09851-10
gebogen spitz
curved pointed
curvas agudas
curve acute

BEEBEE
10,5 cm, 4"

Zahnfleissscheren
Gum Scissors
Tijeras para encias
Forbici per gengiva



LA GRANGE
09854-11
11,5 cm, 4 1/2"



gezahnt
saw edge
dentadas
dentellata

LOCKLIN
09859-16
16 cm, 6 1/4"



gezahnt
saw edge
dentadas
dentellata

LOCKLIN
09860-16
16,5 cm, 6 1/2"



LOCKLIN
09861-16 TC
16,5 cm, 6 1/2"

Verbandscheren, Gipsschere
 Bandage Scissors, Plaster Scissors
 Tijeras para vendajes, Tijeras para yeso
 Forbici per bendaggi, Forbici per gesso

Gaze
 Gauze
 Gaza
 Garza



SMITH US ARMY
 09898-20
 20 cm, 8"



LISTER
 9 cm, 3 1/2" 09901-09
 11 cm, 4 3/8" 09901-11
 14 cm, 5 1/2" 09901-14
 18 cm, 7" 09901-18
 20 cm, 8" 09901-20

09905-14 TC
 09905-18 TC



LISTER
 09906-18 18 cm, 7"
 09906-20 20 cm, 8"



BERGMANN
 09911-23
 23 cm, 9"

Gipsscheren, Verbandscheren
Plaster Scissors, Bandage Scissors
Tijeras para yeso, Tijeras para vendajes
Forbici per gesso, Forbici per bendaggi



ESMARCH
09913-20 20 cm, 8"
09913-22 22 cm, 8 3/4"



SEUTIN
09915-23
23 cm, 9"

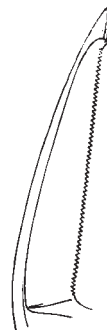

gezahnt
toothed
dentadas
dentellata

REDA EXCENTER
09921-16 16 cm, 6 1/4"
09921-19 19 cm, 7 1/2"

Verbandscheren, Gipsschere
 Bandage Scissors, Plaster Scissors
 Tijeras para vendajes, Tijeras para yeso
 Forbici per bendaggi, Forbici per gesso



KNOWLES
 09930-14
 14 cm, 5 1/2"



KNOWLES
 09931-14
 14 cm, 5 1/2"



LORENZ
 09933-23
 23 cm, 9"



BRUNS
 09935-23 23 cm, 9" **09939-23 TC**
 AAAAAAAAA 09937-23 23 cm, 9"



09941-20
 20 cm, 8"

in verschiedenen Farben lieferbar
 in different colours available
 en diferentes colores disponibles
 in differenti colori disponibile



UNIVERSAL
 09950-15 15 cm, 6"
 09950-18 18 cm, 7"

Supercut Scheren, gezahnt
 Supercut Scissors, saw edge
 Tijeras Supercut, dentadas
 Forbici Supercut, dentellate



09960-14 09961-14
 14,5 cm, 5 3/4"



MAYO
 09962-14 14,5 cm 09963-14
 09962-17 17,0 cm 09963-17
 09962-23 23,0 cm 09963-23

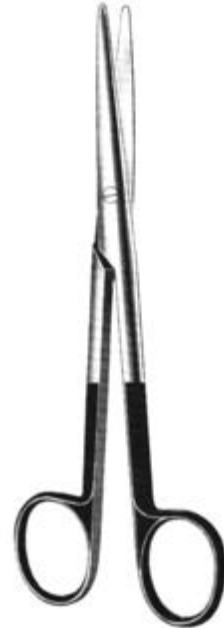

MAYO-STILLE
 09964-15 15,0 cm 09965-15
 09964-17 17,0 cm 09965-17



BABY METZENBAUM
 09966-11 09967-11
 11,5 cm, 4 1/2"

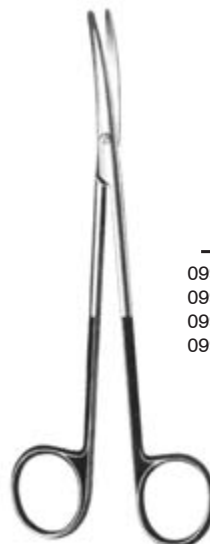

METZENBAUM
 09970-14 14,5 cm 09971-14
 09970-18 18,0 cm 09971-18
 09970-20 20,0 cm 09971-20
 09970-23 23,0 cm 09971-23

Supercut Scheren, gezahnt
 Supercut Scissors, saw edge
 Tijeras Supercut, dentadas
 Forbici Supercut, dentellate



IRIS
 09980-11 09981-11
 11,5 cm, 4 1/2"



WAGNER
 09982-12 09983-12
 12 cm, 4 3/4"



STEVENS
 09984-11 09985-11
 11,5 cm, 4 1/2"



LaGrange
 09986-11 11,5 cm, 4 1/2"



LISTER
 09990-14 14,5 cm, 5 3/4"
 09990-18 18,0 cm, 7"



REYNOLDS
 09993-15 15 cm, 6"
 09993-18 18 cm, 7"



KILNER/RAGNELL
 09995-12 12 cm, 4 3/4"

Face-Lift-Scheren
 Face-Lift-Scissors
 Tijeras para Face-Lift
 Forbici per Face-Lift



GORNEY
 19 cm, 7 1/2"



10010-19
10012-19 TC
 10014-19 Supercut



10011-19
10013-19 TC
 10015-19 Supercut

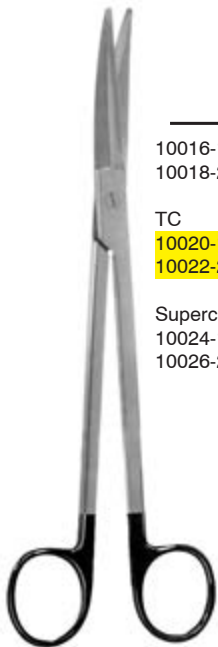

REES

10016-17	17,0 cm, 6 3/4"	10017-17
10018-20	20,5 cm, 8"	10019-20
TC		
10020-17	17,0 cm, 6 3/4"	10021-17
10022-20	20,5 cm, 8"	10023-20
Supercut		
10024-17	17,0 cm, 6 3/4"	10025-17
10026-20	20,5 cm, 8"	10027-20



KAYE

TC		
10028-14	14,5 cm, 5 3/4"	10029-14
10030-18	18,5 cm, 7 1/4"	10031-18
10032-23	23,0 cm, 9"	10033-23
Supercut		
10034-14	14,5 cm, 5 3/4"	10035-14
10036-18	18,5 cm, 7 1/4"	10037-18
10038-23	23,0 cm, 9"	10039-23

Face-Lift-Scheren
 Face-Lift-Scissors
 Tijeras para Face-Lift
 Forbici per Face-Lift

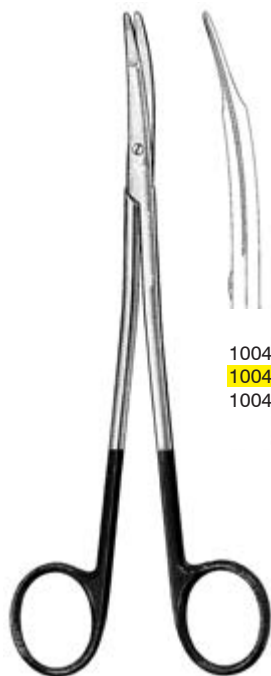

10040-18
 10041-18 TC
 10042-18 Supercut

FREEMAN
 18 cm, 7"

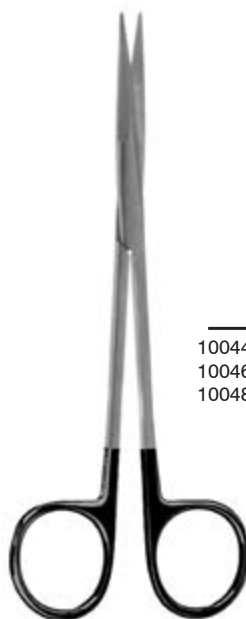

10044-14
 10046-14 TC
 10048-14 Supercut

10045-14
 10047-14 TC
 10049-14 Supercut

PECK JOSEPH
 14,5 cm, 5 3/4"

Augenscheren
Ophthalmic Scissors
Tijeras oculares
Forbici oculistiche



spitz
pointed
agudas
acute

WESTCOTT
10102-11
11 cm, 4 3/8"



stumpf
blunt
romas
smusse

WESTCOTT
10104-11
11 cm, 4 3/8"



spitz
pointed
agudas
acute

NOYES
10110-12 10111-12
12 cm, 4 3/4"



WECKER
11 cm, 4 3/8"



10113-11

spitz
pointed
agudas
acute



10115-11

spitz / stumpf
pointed / blunt
agudas / romas
acute / smusse



10117-11

stumpf
blunt
romas
smusse



BARRAQUER
10119-10 5,5 cm, 2.2"
(Colibri)

Mikro-Scheren
 Micro-Scissors
 Micro-Tijeras
 Micro-Forbici



10120-16
 10120-18
 10120-22

16,0 cm, 6 1/4"
 18,5 cm, 7 1/4"
 22,5 cm, 8.9"



10121-16
 10121-18
 10121-22



10122-16
 10122-18
 10122-22

16,0 cm, 6 1/4"
 18,5 cm, 7 1/4"
 22,5 cm, 8.9"



10123-16
 10123-18
 10123-22



10124-16
 10124-18
 10124-22

16,0 cm, 6 1/4"
 18,5 cm, 7 1/4"
 22,5 cm, 8.9"



10125-16
 10125-18
 10125-22

Circumflex

Mikro-Scheren
Micro-Scissors
Micro-Tijeras
Micro-Forbici



25°

10126-25

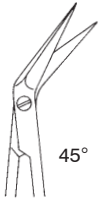

45°

10126-45

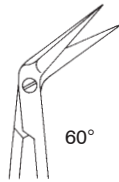

60°

10126-60



25°

10127-25

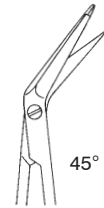

45°

10127-45

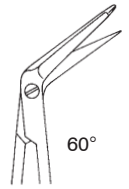

60°

10127-60

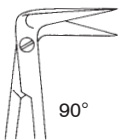

90°

10126-90

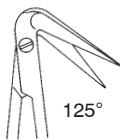

125°

10126-00

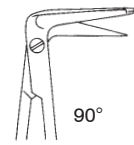

90°

10127-90



125°

10127-00



REDA
18 cm, 7"

Mikro-Scheren
 Micro-Scissors
 Micro-Tijeras
 Micro-Forbici



10128-09
 9 cm, 3 1/2"



10128-15 - 10130-15
 15 cm, 6"

10128-15
 gerade
 straight
 rectas
 rette

10129-15
 gebogen
 curved
 curvas
 curvo

10130-15
 gebogen, 1 Schneide gezahnt
 curved, 1 blade toothed
 curvas, 1 hoja dentada
 curva, 1 lama dentellata

halbscharf
 semi-sharp
 medio roma
 lame semi smusse



HEPP-SCHEIDEL
 10131-14 14 cm, 5 1/2"
 10131-18 18 cm, 7"



HEPP-SCHEIDEL
 10132-18
 18 cm, 7"



HEPP-SCHEIDEL
 10137-01
 18 cm, 7"
 spitz
 pointed
 agudas
 acute

HEPP-SCHEIDEL
 10137-02
 18 cm, 7"
 stumpf
 blunt
 romas
 smusse

Augen-, Mikroscheren
 Ophthalmic, Micro Scissors
 Tijeras oculares, micro tijeras
 Forbici oculistiche, micro chirurg.

Iridektomie, Iridectomy, Iridectomía, iridectomia

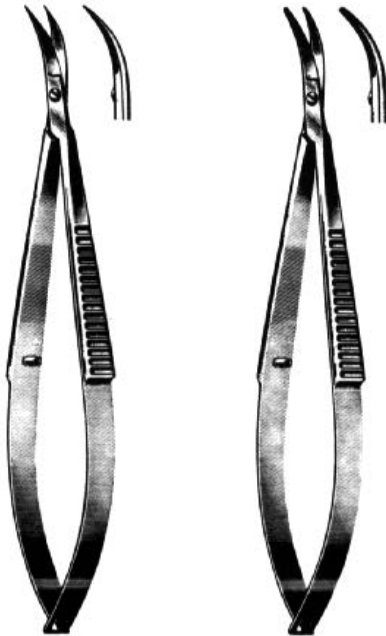

CASTROVIEJO
 10133-10 10 cm, 4"

CASTROVIEJO
 10135-10 10 cm, 4"



VANNAS
 10140-08 8 cm, 3 1/8"



VANNAS
 10141-08 8 cm, 3 1/8"



10142-08
 kniegebogen
 angular
 acodada
 angolate



10143-08
 aufgewinkelt
 angled up
 acodada hacia arriba
 angolate verso l'alto

Hornhautscheren, Corneal scissors, Tijeras corneales, Forbici corneali



CASTROVIEJO
 10151-11 11 cm, 4 3/8"



CASTROVIEJO
 10153-11 11 cm, 4 3/8"



CASTROVIEJO
 10155-11 11 cm, 4 3/8"



Mikro-Scheren
 Micro-Scissors
 Micro-Tijeras
 Micro-Forbici



— REDA
 10202-18 - 10203-18
 18 cm, 7"



GOMEL



10313-14
 14 cm
 5 1/2"



10313-16
 16 cm
 6 1/4"

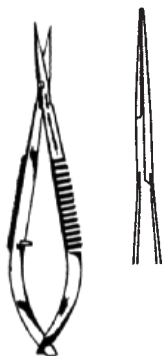

REDA micro
 10320-09
 9 cm, 3 1/2"



REDA
 10330-19 - 10333-19
 18,5 cm, 7 1/4"



10330-19



10331-19



10333-19

Anatomische und chirurgische Pinzetten
 Dressing and Tissue Forceps
 Pinzas de disección, sin/con dientes
 Pinze per dissezione, chirurgiche/anatomiche

STANDARD



USA

STILLE

cm				
10,5	4 1/4"	11102-10		
11,5	4 1/2"	11102-11		
12,0	4 3/4"			11104-12
13,0	5 1/8"	11102-13		11104-13
14,5	5 3/4"	11102-14	11103-14	11104-14
15,0	6"			11104-15
16,0	6 1/4"	11102-16		
18,0	7"	11102-18		11104-18
20,0	8"	11102-20		
21,0	8 1/4"			11104-21
25,0	10"	11102-25		11104-25
30,0	12"	11102-30		

 schmal
 narrow
 estrecha
 stretta

POTTS-SMITH

 POTTS-SMITH
 1x2

cm					
11,5	4 1/2"	11110-11			
13,0	5 1/8"	11110-13			
14,5	5 3/4"	11110-14	11114-14 TC		
16,0	6 1/4"	11110-16	11114-16 TC		
18,0	7"	11110-18		11112-18	11116-18 TC
20,0	8"	11110-20	11114-20 TC		11126-18
21,0	8 1/4"			11112-21	11116-21 TC
25,0	10"	11110-25	11114-25 TC	11112-25	11116-25 TC
30,0	12"	11110-30			11126-25

Chirurgische Pinzetten
Tissue Forceps
Pinzas de disección, con dientes
Pinze per dissezione, chirurgiche

STANDARD	1x2	USA	1x2	STILLE	1x2	schmal narrow estrecha stretta
cm						
10,5	4 1/4"	11120-10				
11,5	4 1/2"	11120-11				11130-11
12,0	4 3/4"		11122-12			
13,0	5 1/8"	11120-13	11122-13			11130-13
14,5	5 3/4"	11120-14	11122-14			11130-14
15,0	6"			11124-15		
15,5	6"		11122-15			
16,0	6 1/4"	11120-16				11130-16
18,0	7"	11120-18	11122-18			11130-18
20,0	8"	11120-20				11130-20
21,0	8 1/4"		11122-21			
25,0	10"	11120-25	11122-25			
30,0	12"	11120-30				

	1x2	2x3	3x4	4x5
cm				
11,5	4 1/2"			
13,0	5 1/8"	11140-11		
14,5	5 3/4"	11140-13	11150-13	11160-13
14,5	5 3/4"	11140-14	11150-14	11160-14
16,0	6 1/4"	11132-16 TC	11140-16	11150-16
18,0	7"	11132-18 TC	11140-18	
20,0	8"	11132-20 TC	11140-20	
25,0	10"	11132-25 TC	11140-25	
30,0	12"	11132-30 TC		

Anatomische und chirurgische Pinzetten
 Dressing and Tissue Forceps
 Pinzas de disección, sin/con dientes
 Pinze per dissezione, chirurgiche/anatomiche



ADSON
 11170-12 12,0 cm, 4 ³/₄"
 11170-15 15,0 cm, 6"



ADSON
 11174-12 TC 12,0 cm, 4 ³/₄"
 11174-15 TC 15,0 cm, 6"



ADSON micro
 11176-12 12,0 cm, 4 ³/₄"
 11176-15 15,0 cm, 6"



ADSON-DEBAKEY atraumatic
 11177-12
 12,0 cm, 4 ³/₄"



ADSON
 11178-12
 12,0 cm, 4 ³/₄"



ADSON
 11179-12
 12 cm, 4 ³/₄"

Anatomische und chirurgische Pinzetten
 Dressing and Tissue Forceps
 Pinzas de disección, sin/con dientes
 Pinze per dissezione, anatomiche/chirurgiche



1x2

ADSON

11180-12 12,0 cm, 4 $\frac{3}{4}$ "
 11180-15 15,0 cm, 6"



1x2

ADSON

11181-12 TC 12,0 cm, 4 $\frac{3}{4}$ "
 11181-15 TC 15,0 cm, 6"



1x2

ADSON micro

11186-12 12,0 cm, 4 $\frac{3}{4}$ "
 11186-15 15,0 cm, 6"



1x2

ADSON

11187-12
 12 cm, 4 $\frac{3}{4}$ "



7x7

ADSON-BROWN

11188-12 12,0 cm, 4 $\frac{3}{4}$ "
 11188-15 15,0 cm, 6"
 11189-12 TC 12,0 cm, 4 $\frac{3}{4}$ "

Anatomische und chirurgische Pinzetten
 Dressing and Tissue Forceps
 Pinzas de disección, sin/con dientes
 Pinze per dissezione, chirurgice/anatomiche



9x9

BROWN
 11189-15 15,0 cm, 6"
 11189-20 20,0 cm, 8"
 11189-25 25,0 cm, 10"



GRAEFE
 11190-10 10,5 cm, 4.1"



1x2

WAUGH
 11187-18 18 cm, 7"
 11187-20 20 cm, 8"
 11187-25 25 cm, 10"
 11187-30 30 cm, 11 3/4"



11221-17

CUSHING
 11220-17
11224-17 TC
 17,0 cm, 6 3/4"



1x2

11223-17

CUSHING
 11222-17
11225-17 TC
 17,0 cm, 6 3/4"

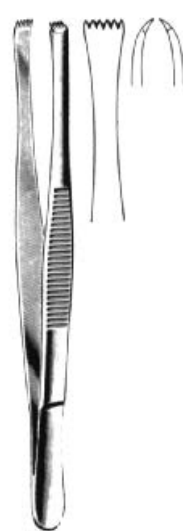

5x6

LERCHE
 11232-15
 15,0 cm, 6"

Anatomische und chirurgische Pinzetten, Faßpinzetten
 Dressing and Tissue Forceps
 Pinzas de disección, sin/con dientes
 Pinze per dissezione, chirurgiche/anatomiche



BROPHY
 11231-20
 20,0 cm, 8"



BROPHY
 11233-20
 20,0 cm, 8"



BROPHY
 20,0 cm, 8"



ADLERKREUTZ
 11236-15 15,0 cm, 6"
 11236-20 20,0 cm, 8"



DUEHRSEN
 11237-20
 20 cm, 8"



LANE
 11240-14
 14,5 cm, 5 3/4"



LANE
 11242-14
 14,5 cm, 5 3/4"

Anatomische und chirurgische Pinzetten, Faßpinzetten
 Dressing and Tissue Forceps
 Pinzas de disección, sin/con dientes
 Pinze per dissezione, chirurgiche/anatomiche



FERRIS-SMITH
 11246-18
 18,0 cm, 7"



FERRIS-SMITH
 11248-18
 18,0 cm, 7"



DUVAL
 11250-14
 14,5 cm, 5 3/4"



COLLIN-DUVAL
 11252-20
 20,0 cm, 8"



Russ. Mod.
 11256-15 15,0 cm, 6"
 11256-20 20,0 cm, 8"
 11256-25 25,0 cm, 10"



McINDOE
 11257-15
 15,0 cm, 6"



McINDOE
 11258-15 15,0 cm, 6"
 11259-15 TC 15,0 cm, 6"

Anatomische und chirurgische Pinzetten
 Dressing and Tissue Forceps
 Pinzas de disección, sin/con dientes
 Pinze per dissezione, chirurgiche/anatomiche



SEMKEN

11260-12	12,5 cm, 5"
11260-15	15,5 cm, 6"
11261-15 TC	15,5 cm, 6"



1x2

SEMKEN

11270-12	12,5 cm, 5"
11270-15	15,5 cm, 6"
11271-15 TC	15,5 cm, 6"
11271-18 TC	18 cm, 7"



1x2

GILLIES

11272-15	15,5 cm, 6"
11273-15 TC	15,5 cm, 6"



15,5 cm, 6"

11274-06
0,6 mm11274-08
0,8 mm11274-10
1,0 mm

GERALD

11302-17	17,5 cm, 6.9"
11302-23	23,0 cm, 9"
11304-17 TC	17,0 cm, 6 3/4"



GERALD

11303-17	17,5 cm, 6.9"
----------	---------------

Anatomische und chirurgische Pinzetten
 Dressing and Tissue Forceps
 Pinzas de disección, sin/con dientes
 Pinze per dissezione, chirurgiche/anatomiche



GERALD
 11305-17
 17,5 cm, 6.9"



GERALD
 11310-17 17,5 cm, 6.9"
 11312-17 TC 17,5 cm, 6.9"



GERALD
 11311-17
 17,5 cm, 6.9"



CUSHING-TAYLOR
 11312-18 TC
 18,5 cm, 7 1/4"



GERALD
 11313-17
 17,5 cm, 6.9"



11314-01



11314-02

TAYLOR
 17 cm, 6 3/4"



11315-01



11315-02

TAYLOR
 17 cm, 6 3/4"

Anatomische und chirurgische Pinzetten
 Dressing and Tissue Forceps
 Pinzas de disección, sin/con dientes
 Pinze per dissezione, chirurgiche/anatomiche

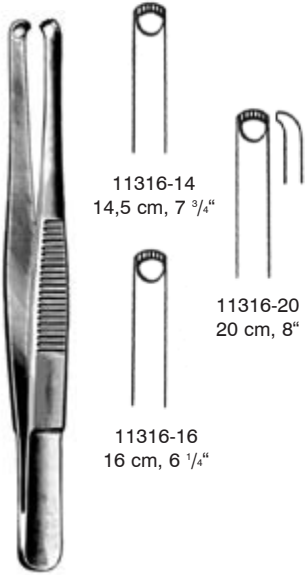

11316-14
 14,5 cm, 7 3/4"

11316-20
 20 cm, 8"

11316-16
 16 cm, 6 1/4"

DURANTE

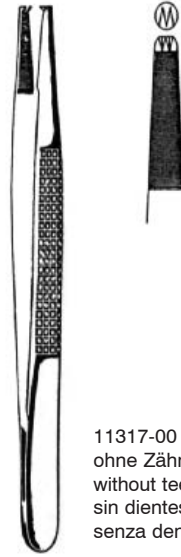

- 11317-12 1x2
- 11317-23 2x3
- 11319-12 TC 1x2

11317-00
 ohne Zähne
 without teeth
 sin dientes
 senza denti

BONNEY
 18 cm, 7"

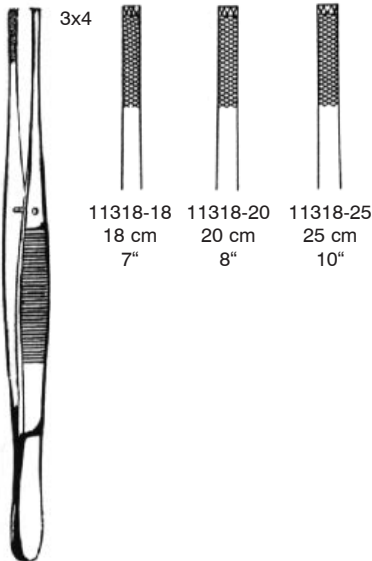

3x4

11318-18
 18 cm
 7"

11318-20
 20 cm
 8"

11318-25
 25 cm
 10"

STILLE-BARRAYA



OCHSNER
 11319-14 14,5 cm 5 3/4"



SINGLEY
 11320-18 18 cm 7"
 11320-23 23 cm 9"

Anatomische und chirurgische Pinzetten
 Dressing and Tissue Forceps
 Pinzas de disección, sin/con dientes
 Pinze per dissezione, chirurgiche/anatomiche



NELSON
 11322-15 15 cm 6"
 11322-18 18 cm 7"
 11322-23 23 cm 9"



WANGENSTEEN
 11324-23
 23 cm 9"



11325-15 TC
 15 cm, 6"

11325-23 TC
 23 cm, 9"

11325-25 TC
 25 cm, 10"

WANGENSTEEN



MAYO
 11326-23 23 cm, 9"



STRASSBURGER
 MODELL



1x2

11328-15
 15 cm, 6"

1x2

11328-20
 20 cm, 8"

Uhrmacherpinzetten
Jeweler Type Forceps
Pinzas de relojero
Pinze da orologiaio

Fig. 1



11401-01
12 cm, 4 $\frac{3}{4}$ "

Fig. 3



11403-03
12 cm, 4 $\frac{3}{4}$ "

Fig. 3c



11403-04
11 cm, 4 $\frac{3}{8}$ "

Fig. 4



11404-04
11 cm, 4 $\frac{3}{8}$ "

Fig. 5



11405-05
11 cm, 4 $\frac{3}{8}$ "

Fig. 7



11407-07
12 cm, 4 $\frac{3}{4}$ "

Splitterpinzetten
 Splinter Forceps
 Pinzas para espinas
 Pinze per schegge



11802-09 9,0 cm, 3 1/2"
 11802-10 10,5 cm, 4.1"
 11802-11 11,5 cm, 4 1/2"



FEILCHENFELD
 11810-07 7,5 cm, 3"
 11810-09 9,0 cm, 3 1/2"
 11810-11 11,5 cm, 4 1/2"



HUNTER
 11812-10 10,5 cm, 4.1"



HUNTER
 11813-10
 10,5 cm, 4.1"



HUNTER
 11815-12
 12,5 cm, 5"



CARMALT
 11816-10
 10,5 cm, 4.1"



CARMALT
 11817-10
 10,5 cm, 4.1"

Splitterzangen
 Splinter Forceps
 Pinzas para espinas
 Pinze per schegge



PEET
 11821-11
 11,5 cm, 4 1/2"

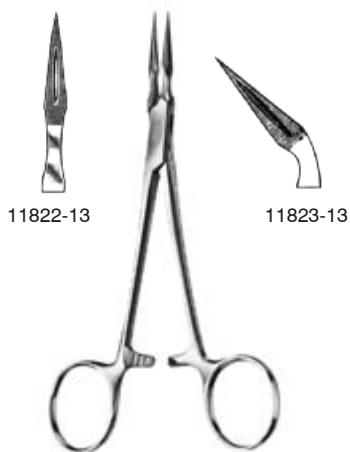

STIEGLITZ
 11822-13
 11823-13
 13,5 cm, 5 1/4"

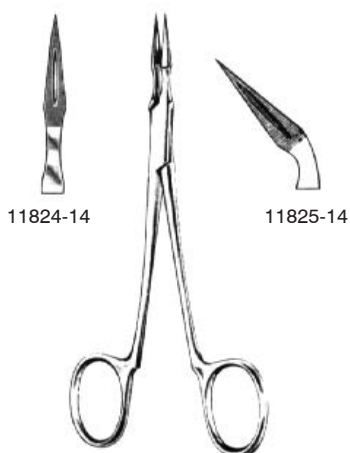

ARCHER
 11824-14
 11825-14
 14 cm, 5 1/2"



VIRTUS (RALK)
 11828-15
 15 cm, 6"

Zahnpinzetten
Dental Forceps
Pinzas dentales
Pinze dentali

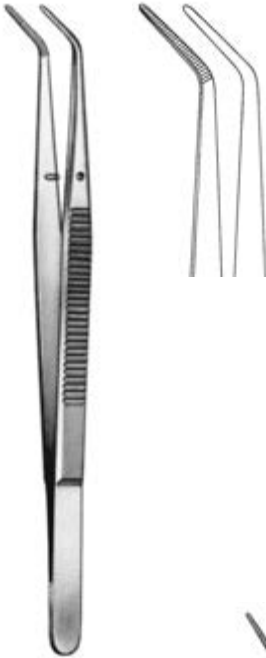

LONDON-COLLEGE
11900-01
15 cm, 6"



LONDON-COLLEGE
11901-05
15 cm, 6"

mit Sperre
with lock
con cierre
con fermo



MERIAM
11910-01
15 cm, 6"

Mikrochirurgie-Pinzetten
Microsurgery Forceps
Pinzas para microcirugía
Pinze per microchirurgia



12102-12
12 cm, 4 3/4"



12103-12
12 cm, 4 3/4"



12104-15
15 cm, 6"



12105-15
15 cm, 6"



12108-18
18 cm, 7"



12109-18
18 cm, 7"

Ultra-Light-Pinzetten
Ultra-Light-Forceps
Pinzas-Ultra-Ligera
Pinza-ultra-leggera

1,5 mm



1,5 mm



1,5 mm



1,2 mm

 $\frac{1}{2}$

12110-15
15 cm, 6"

 $\frac{1}{2}$

12110-20
20 cm, 8"

 $\frac{1}{2}$

12110-24
24 cm, 9 $\frac{1}{2}$ "

 $\frac{1}{2}$

12110-30
30 cm, 11 $\frac{3}{4}$ "

Mikrochirurgie-Pinzetten
Microsurgery Forceps
Pinzas para microcirugía
Pinze per microchirurgia

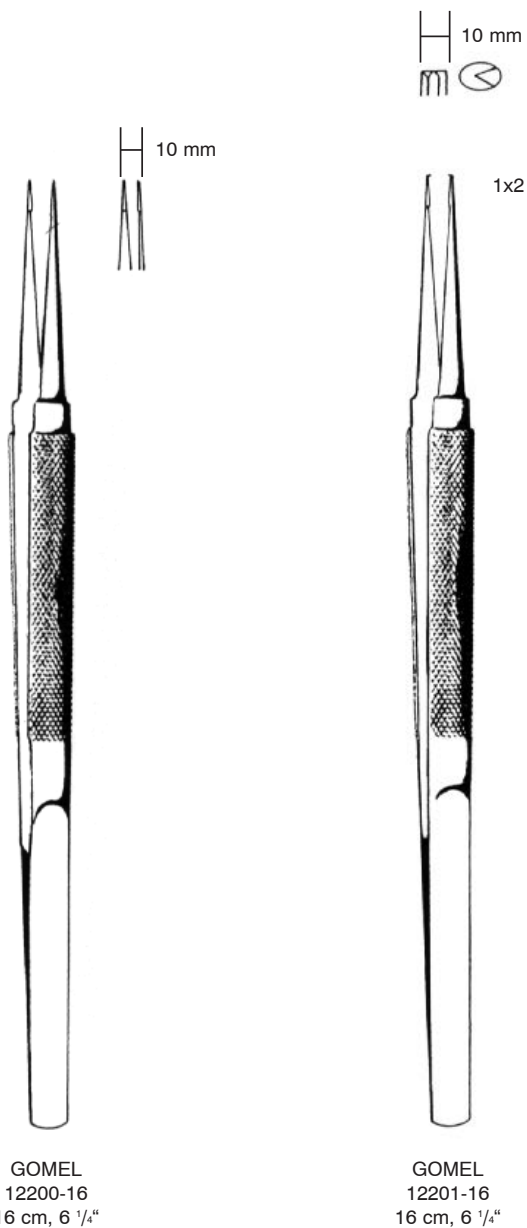

Tumorpinzetten
Tumor forceps
Pinzas para tumores
Pinze per tumori



12291-22
ø 3 mm



12293-22
ø 5 mm



YASARGIL
12295-22
ø 3 mm



HUNT
12297-22
ø 5 mm

YASARGIL
22 cm, 8 ³/₄"

22 cm, 8 ³/₄"

Atraumatische Pinzetten
Atraumatic Tissue Forceps
Pinzas atraumáticas
Pinze atraumatiche



1 mm

DE BAKEY

12302-16 16 cm, 6 1/4"
12302-20 20 cm, 8"
12302-24 24 cm, 9 1/2"



1,5 mm

DE BAKEY

12306-16 16 cm, 6 1/4"
12306-20 20 cm, 8"
12306-24 24 cm, 9 1/2"
12306-30 30 cm, 11 3/4"



2,0 mm

DE BAKEY

12308-16 16 cm, 6 1/4"
12308-20 20 cm, 8"
12308-24 24 cm, 9 1/2"
12308-30 30 cm, 11 3/4"



2,0 mm

DE BAKEY

12309-16 16 cm, 6 1/4"
12309-20 20 cm, 8"
12309-24 24 cm, 9 1/2"
12309-30 30 cm, 11 3/4"



2,7 mm

DE BAKEY

12304-16 16 cm, 6 1/4"
12304-20 20 cm, 8"
12304-24 24 cm, 9 1/2"
12304-30 30 cm, 11 3/4"



3,5 mm

DE BAKEY

12310-16 16 cm, 6 1/4"
12310-20 20 cm, 8"
12310-24 24 cm, 9 1/2"
12310-30 30 cm, 11 3/4"

Atraumatische Pinzetten
 Atraumatic Tissue Forceps
 Pinzas atraumáticas
 Pinze atraumatiche

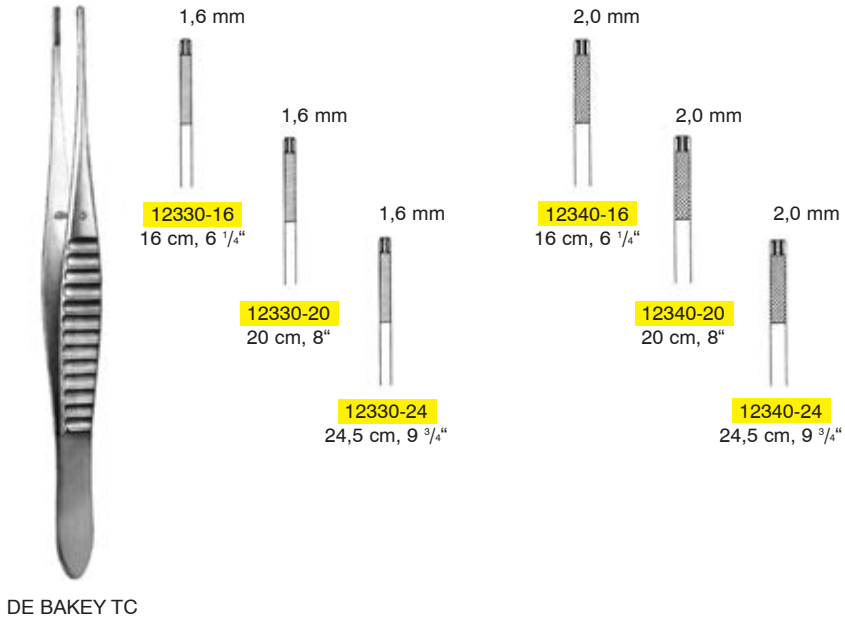
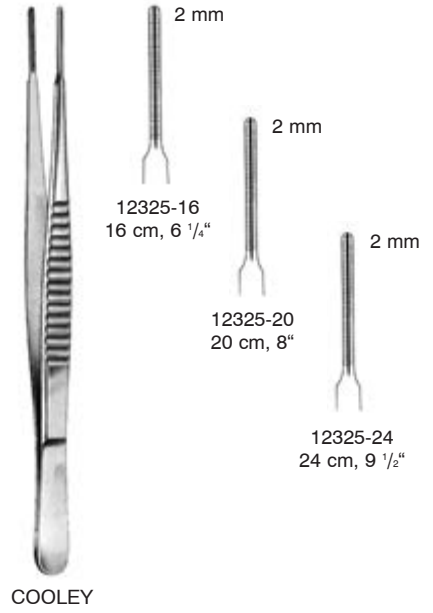
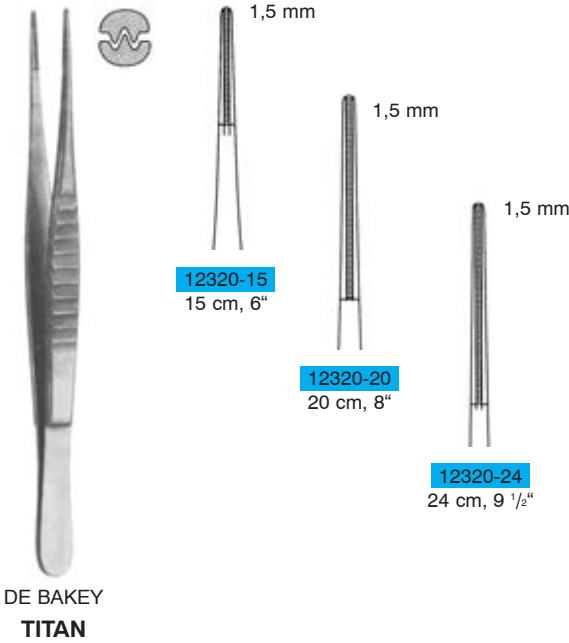

Atrauma-Bulldogklemmen
 Atrauma-Bulldog Clamps
 Clamps Atrauma Bulldog
 Pinze Atrauma Bulldog



13090-40
 40 mm / 1 1/2"

13090-45
 45 mm / 1 3/4"

13090-50
 50 mm / 2"



13091-40
 40 mm / 1 1/2"

13091-45
 45 mm / 1 3/4"

13091-50
 50 mm / 2"

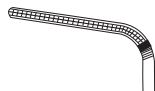

GLOVER
 13098-06
 57 mm / 2 3/8"

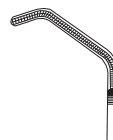

DE BAKEY
 13099-07
 73 mm / 2 3/4"

Mini-Bulldogklemmen
 Mini Bulldog Clamps
 Clamps Bulldog Mini
 Pinze Bulldog Mini

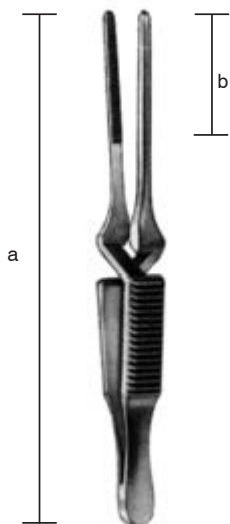

DIETHRICH

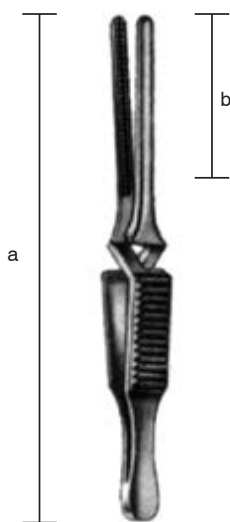
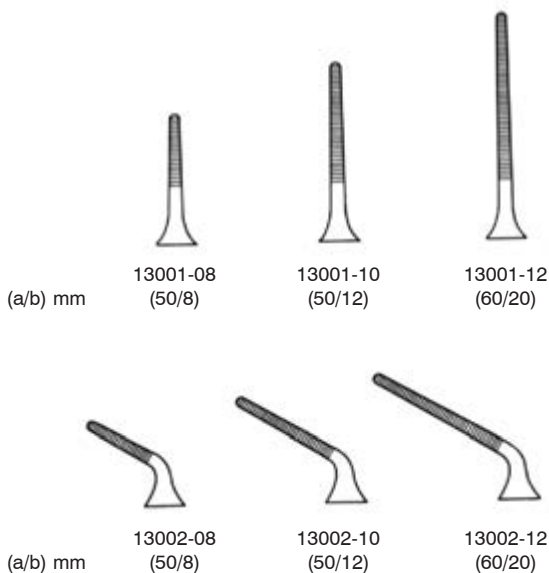

DEBAKEY-DIETHRICH

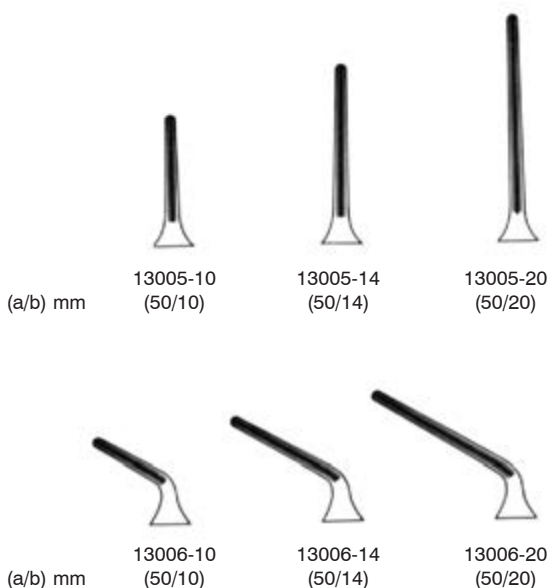

Titan-Atrauma-Bulldogklemmen
 Titanium Atrauma Bulldog Clamps
 Titan Clamp Bulldog
 Titan Pinze Bulldog

	3 cm, 1.2"	3,5 cm, 1.4"	4 cm, 1 1/2"	5 cm, 2"
Vene	13010-30	13010-35	13010-40	13010-50
Arterie	13011-30	13011-35	13011-40	13011-50

	3 cm, 1.2"	3,5 cm, 1.4"	4 cm, 1 1/2"	5 cm, 2"
Vena	13012-30	13012-35	13012-40	13012-50
Arteria	13013-30	13013-35	13013-40	13013-50

	3 cm, 1.2"	3,5 cm, 1.4"	4 cm, 1 1/2"	5 cm, 2"
Vene	13014-30	13014-35	13014-40	13014-50
Arterie	13015-30	13015-35	13015-40	13015-50

Atrauma-Bulldogklemmen
 Atrauma Bulldog Clamps
 Clamps Atrauma Bulldog
 Pinze Atrauma Bulldog



DE BAKEY

 13092-07
 7,5 cm
 3"

 13092-08
 8,5 cm
 3.4"

 13092-10
 10,5 cm
 4"

 13092-12
 12 cm
 4 3/4"

 13093-07
 7 cm
 2 3/4"

 13093-08
 8 cm
 3 1/8"

 13093-10
 10 cm
 4"

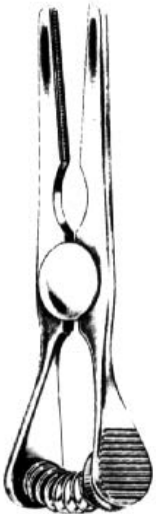
 13093-12
 11,5 cm
 4 1/2"

GLOVER

 13096-06
 6 cm
 2 1/4"

 13096-07
 7 cm
 2 3/4"

 13096-09
 9 cm
 3 1/2"

 13096-11
 11 cm
 4 3/8"

 13097-06
 5,5 cm
 2"

 13097-07
 6,5 cm
 2 1/2"

 13097-09
 8,5 cm
 3 1/4"

 13097-11
 10,5 cm
 4"

Gefäßklemmen, Bulldogklemmen, Arterienklemmen
 Hemostatic Forceps
 Pinzas hemostáticas
 Pinze serrafina, Pinze emostatiche



DIEFFENBACH
 13102-04 3,5 cm, 1.4"
 13102-05 5,5 cm, 2.2"



DIEFFENBACH
 13103-04 3,5 cm, 1.4"
 13103-05 5,5 cm, 2.2"

gerade
 straight
 recta
 rette



gebogen
 curved
 curva
 curve

JOHNS-HOPKINS

13110-50	5,0 cm, 2"	13111-50
13110-55	5,5 cm, 2.2"	13111-55
13110-65	6,5 cm, 2.6"	13111-65
13110-70	7,0 cm, 2 3/4"	13111-70
13110-75	7,5 cm, 3"	13111-75
13110-90	9,0 cm, 3 1/2"	13111-90

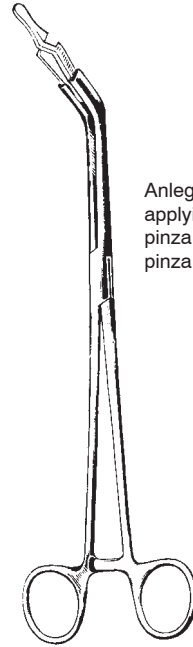

Anlegezange
 applying forceps
 pinza para poner
 pinza applicatrice

13115-00
 23 cm, 9"

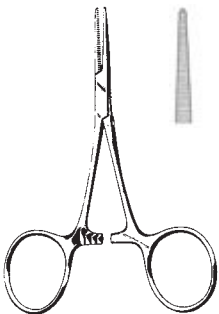

HARTMANN
 13210-10
 10 cm, 4"

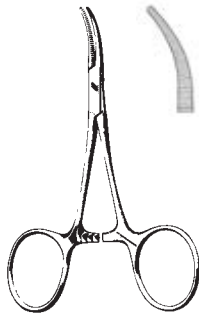

HARTMANN
 13211-10
 10 cm, 4"

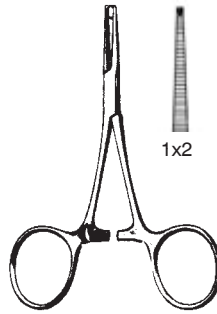

HARTMANN
 13212-10
 10 cm, 4"

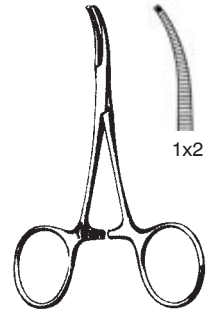

HARTMANN
 13213-10
 10 cm, 4"

Micro-HARTMANN
 13214-10
 10 cm, 4"

Micro-HARTMANN
 13215-10
 10 cm, 4"

Arterienklemmen
Hemostatic Forceps
Pinzas hemostáticas
Pinze emostatiche



TITAN — HALSTED-MOSQUITO — TITAN
13224-12 13220-12 12,5 cm, 5" 13221-12 **13225-12**
 13220-14 14,0 cm, 5 1/2" 13221-14
 13220-18 18,0 cm, 7" 13221-18
 13220-21 21,0 cm, 8 1/4" 13221-21



— HALSTED-MOSQUITO micro —
 13222-12 12,5 cm, 5" 13223-12
 JACOBSON micro
 13226-12 12,0 cm, 4 3/4" 13227-12

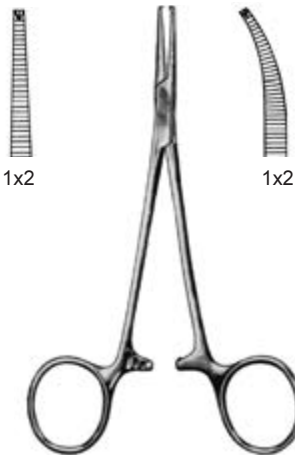

— HALSTED-MOSQUITO —
 13230-12 12,5 cm, 5" 13231-12
 13230-14 14,0 cm, 5 1/2" 13231-14
 13230-18 18,0 cm, 7" 13231-18
 13230-21 21,0 cm, 8 1/4" 13231-21

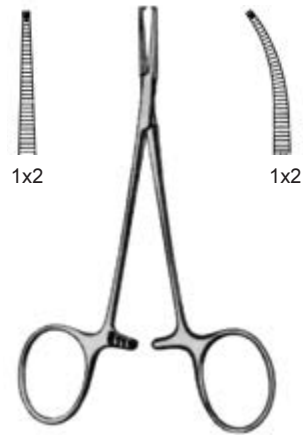

— HALSTED-MOSQUITO micro —
 13232-12 13233-12

Arterienklemmen
Hemostatic Forceps
Pinzas hemostáticas
Pinze emostatiche

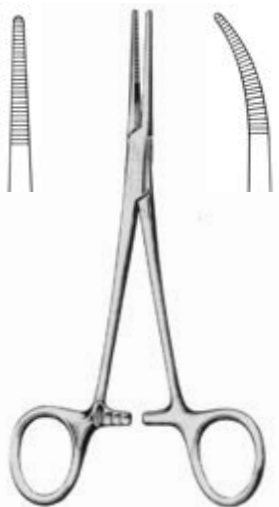

KELLY

13240-14	14 cm, 5 1/2"	13241-14
13240-18	18 cm, 7"	13241-18
13244-14	14 cm, 5 1/2"	13245-14
TITAN		TITAN

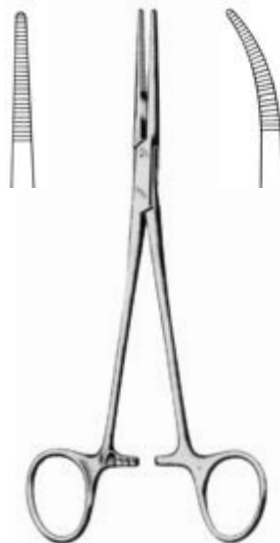

KELLY-RANKIN

13242-16	16 cm, 6 1/4"	13243-16
----------	---------------	----------

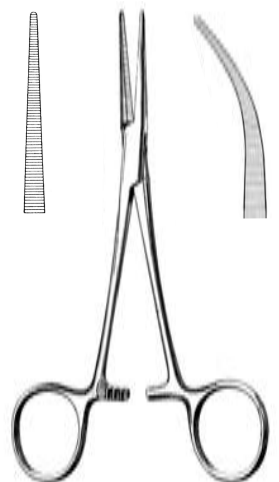

COLLER-CRILE

13256-14	14 cm, 5 1/2"	13257-14
13258-16	16 cm, 6 1/4"	13259-16



PROVIDENCE-HOSPITAL

13270-14	14 cm, 5 1/2"	13271-14
----------	---------------	----------

Arterienklemmen
 Hemostatic Forceps
 Pinzas hemostáticas
 Pinze emostatiche



CRILE
 13250-14 14 cm, 5 1/2" 13251-14
 13250-18 18 cm, 7" 13251-18
13254-14 14 cm, 5 1/2" **13255-14**
 TITAN TITAN

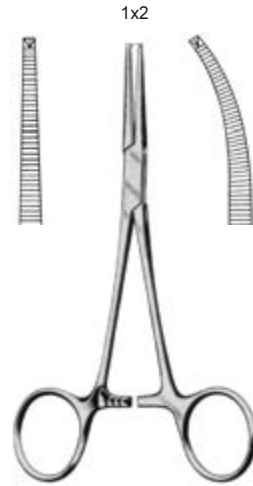

CRILE
 13260-14 14 cm, 5 1/2" 13261-14



CRILE-RANKIN
 13262-16 16 cm, 6 1/4" 13263-16

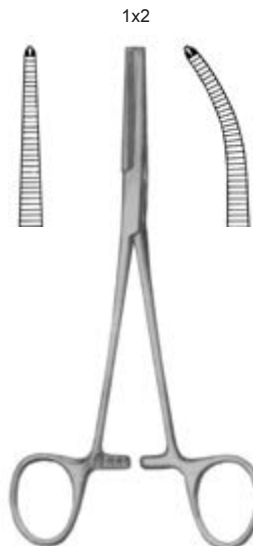

CRILE-RANKIN
 13264-16 16 cm, 6 1/4" 13265-16

Arterienklemmen
Hemostatic Forceps
Pinzas hemostáticas
Pinze emostatiche

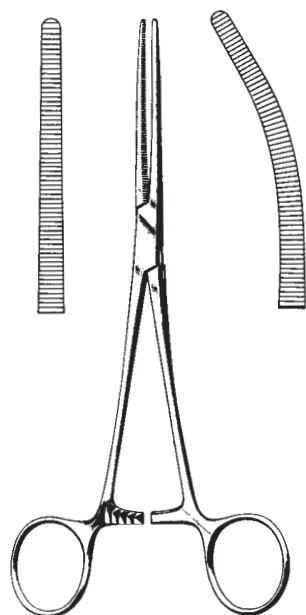

ROCHESTER-PEAN

13310-13	13 cm, 5 1/8"	13311-13
13310-14	14 cm, 5 1/2"	13311-14
13310-16	16 cm, 6 1/4"	13311-16
13310-18	18 cm, 7"	13311-18
13310-20	20 cm, 8"	13311-20
13310-22	22 cm, 8 3/4"	13311-22
13310-24	24 cm, 9 1/2"	13311-24
13310-26	26 cm, 10 1/4"	13311-26
13310-30	30 cm, 11 3/4"	13311-30

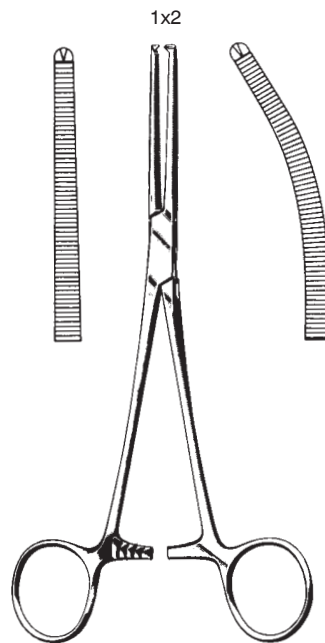

ROCHESTER-OGHSNER

13320-13	13 cm, 5 1/8"	13321-13
13320-14	14 cm, 5 1/2"	13321-14
13320-16	16 cm, 6 1/4"	13321-16
13320-18	18 cm, 7"	13321-18
13320-20	20 cm, 8"	13321-20
13320-22	22 cm, 8 3/4"	13321-22
13320-24	24 cm, 9 1/2"	13321-24
13320-26	26 cm, 10 1/4"	13321-26
13320-30	30 cm, 11 3/4"	13321-30

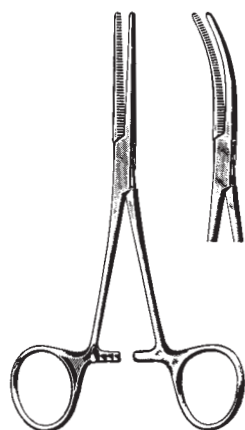

Fein
Delicate
Delicada
Fina

PEAN

13312-14	14 cm, 5 1/2"	13313-14
13312-16	16 cm, 6 1/4"	13313-16

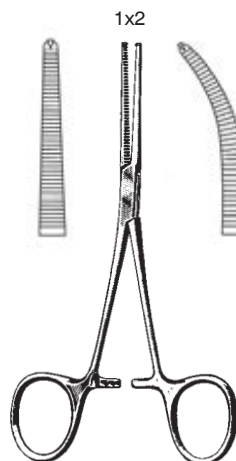

Fein
Delicate
Delicada
Fina

KOCHER

13322-14	14 cm, 5 1/2"	13323-14
13322-16	16 cm, 6 1/4"	13323-16

Arterienklemmen
Hemostatic Forceps
Pinzas hemostáticas
Pinze emostatiche



SPENCER-WELLS

13330-13	13 cm, 5"	13331-13
13330-15	15 cm, 6"	13331-15
13330-18	18 cm, 7"	13331-18
13330-20	20 cm, 8"	13331-20

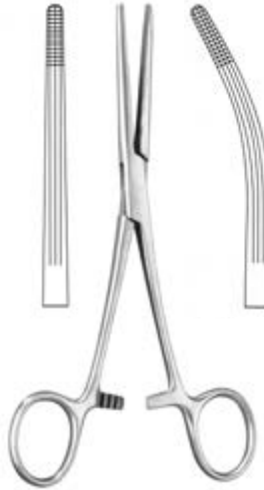

ROCHESTER-CARMALT

13340-16	16 cm, 6 1/4"	13341-16
13340-20	20 cm, 8"	13341-20

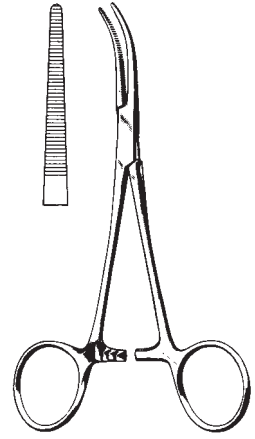

DANDY

13345-12	12 cm, 4 3/4"
13345-14	14 cm, 5 1/2"

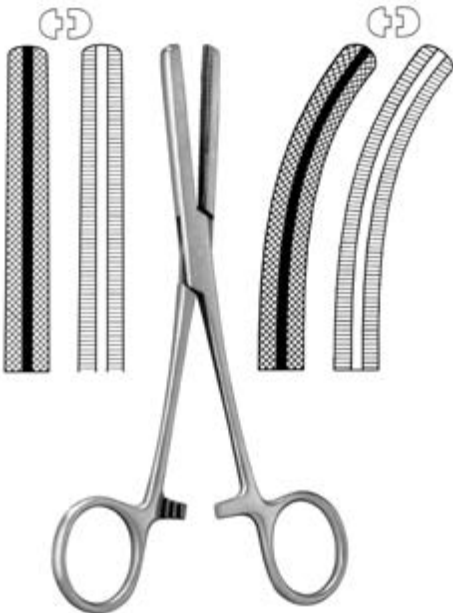

FERGUSSON

13350-16	16 cm, 6 1/4"	13351-16
13350-20	20 cm, 8"	13351-20

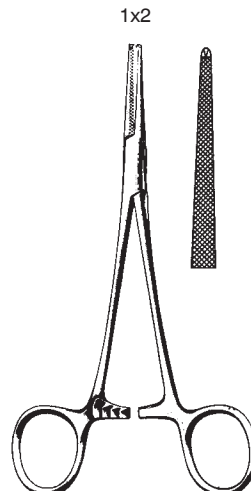

LOVELACE

13356-15	15,5 cm, 6"
----------	-------------



PENNINGTON

13358-15	15,5 cm, 6"
13358-20	20,0 cm, 8"

Fasszangen
Grasping Forceps
Pinza para agarrar órganos y tejidos
Pinze da presa



PRATT
13360-15 15 cm, 6"

MARTEL
13364-14 14 cm, 5 1/2"

WILLET MARTEL
13366-19 19 cm, 7 1/2"

PEAN
13368-14 14 cm, 5 1/2"
13368-16 16 cm, 6 1/4"



3x2
CHAPUT
13370-13
13 cm, 5 1/8"

5x6
TUFFIER
13372-13
13 cm, 5 1/8"

COLLIN
13374-14
14 cm, 5 1/2"

COLLIN
13376-16
16 cm, 6 1/4"

Organ- und Gewebefasszange, Arterienklemmen
 Organ- and Tissue Grasping Forceps, Hemostatic Forceps
 Pinza para agarrar órganos y tejidos, Pinzas hemostáticas
 Pinza per tessuti e organi, Pinze emostatiche



REDA
 Atrauma
 13377-25 - 13377-26



13377-25
 25 cm, 10"

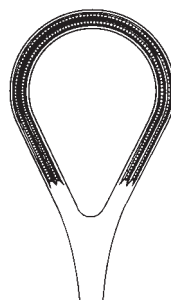

13377-26
 26 cm, 10 1/4"



LERICHE
 13380-15 15 cm, 6" 13381-15

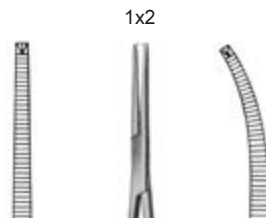

LERICHE
 13382-15 15 cm, 6" 13383-15

Arterienklemmen
 Hemostatic Forceps
 Pinzas hemostáticas
 Pinze emostatiche

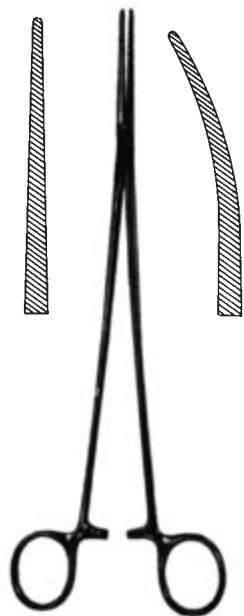

— BENGOLEA —
 13384-20 20 cm, 8" 13385-20
 13384-26 26 cm, 10 1/4" 13385-26

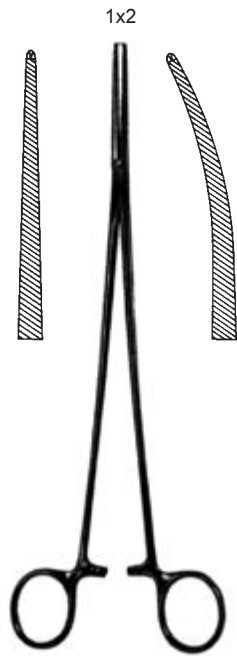

— BENGOLEA —
 13386-20 20 cm, 8" 13387-20
 13386-26 26 cm, 10 1/4" 13387-26

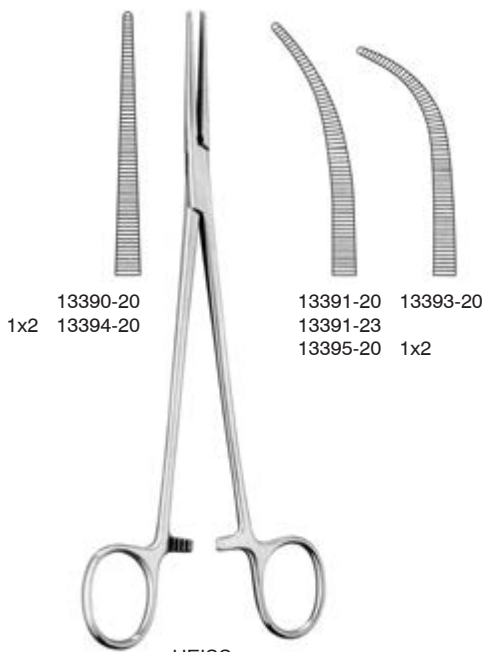

13390-20
 1x2 13394-20
 13391-20 13393-20
 13391-23
 13395-20 1x2

HEISS
 20 cm, 8"

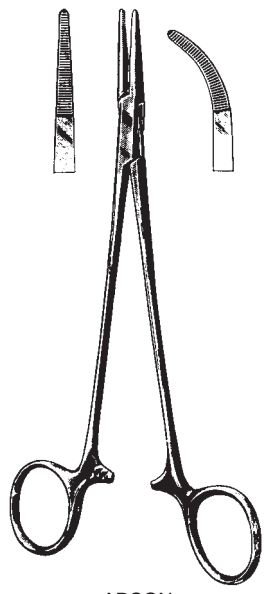

— ADSON —
 13410-18 18,5 cm, 7 1/4" 13411-18

Arterienklemmen
 Hemostatic Forceps
 Pinzas hemostáticas
 Pinze emostatiche

1x2

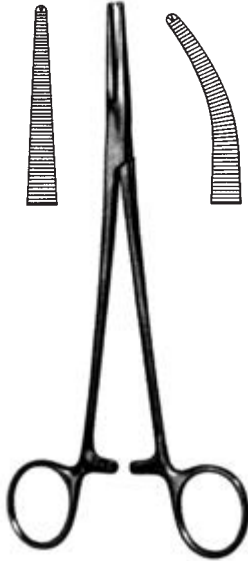

ADSON
 13412-18 18,5 cm, 7 1/4" 13413-18



FUCHSIG
 13414-20 19 cm, 7 1/2"



ADSON BABY
 13415-14 14,0 cm, 5 1/2"
 13415-18 18,5 cm, 7 1/4"



NISSEN
 13416-18 18,5 cm, 7 1/4"

Arterienklemmen
 Hemostatic Forceps
 Pinzas hemostáticas
 Pinze emostatiche



OVERHOLT-BABY
 13420-14
 14 cm, 5 1/2"



OVERHOLT-GEISSENDOERFER
 21 cm, 8 1/4"



Fig. 1
 13421-01

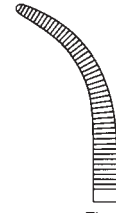

Fig. 2
 13425-02
 26 cm
 10 1/4"

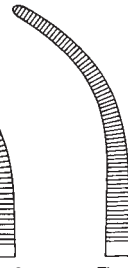

Fig. 3
 13425-03
 27 cm
 10 1/2"

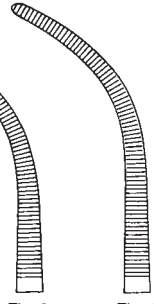

Fig. 4
 13421-04
 27,5 cm
 10,8"

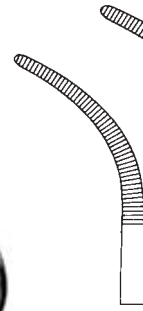

Fig. 5
 13421-05
 27 cm
 10 1/2"



Fig. 6
 13421-06
 28 cm
 11"

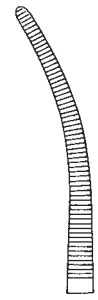

Fig. 7
 13421-07



OVERHOLT



13422-00
 21,5 cm
 8 1/2"
 Fig. 0



13422-01
 21 cm
 8 1/4"
 Fig. 1



13422-02
 22 cm
 8 3/4"
 Fig. 2



13422-03
 23 cm
 9"
 Fig. 3



13422-06
 22,5 cm
 8,9"
 Fig. 6

Arterienklemmen
 Hemostatic Forceps
 Pinzas hemostáticas
 Pinze emostatiche

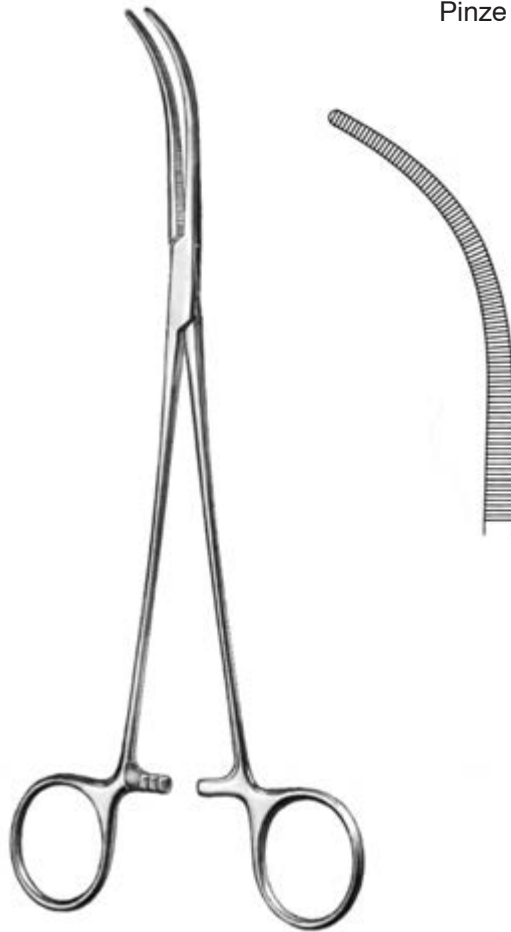

OVERHOLT-MIXTER
 13428-21
 21,5 cm, 8 1/2"



GEMINI



13431-13
 13 cm
 5 1/8"

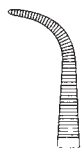

13431-16
 16 cm
 6 1/4"



13431-18
 18 cm
 7"

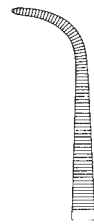

13431-20
 20 cm
 8"

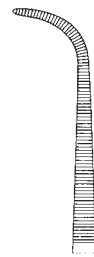

13431-23
 23 cm
 9"

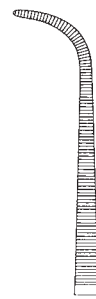

13431-25
 25 cm
 10"

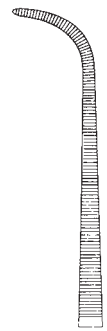

13431-28
 28 cm
 11"

Arterienklemmen
 Hemostatic Forceps
 Pinzas hemostáticas
 Pinze emostatiche

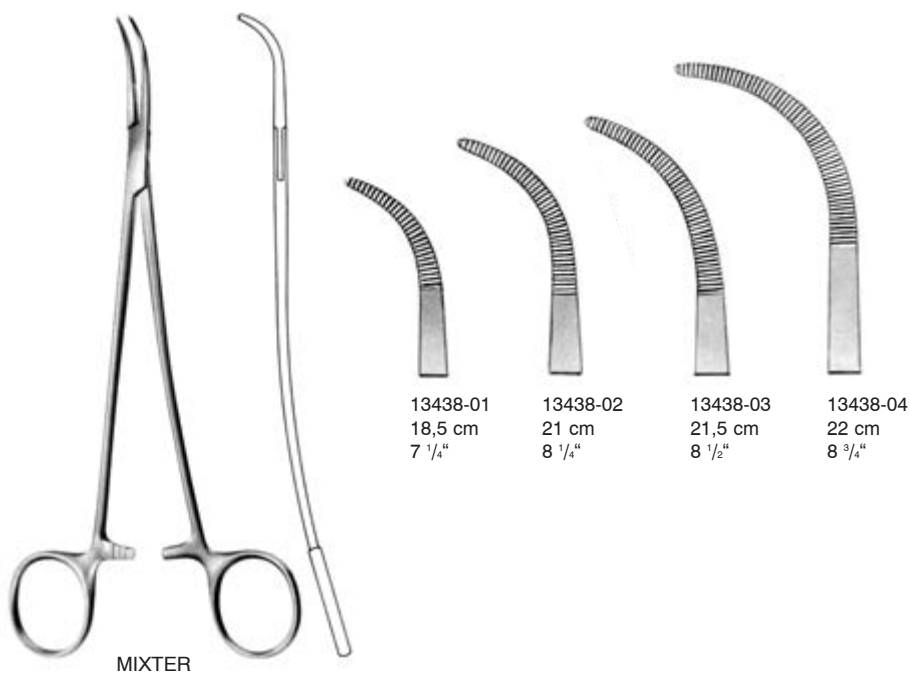

Arterienklemmen
Hemostatic Forceps
Pinzas hemostáticas
Pinze emostatiche

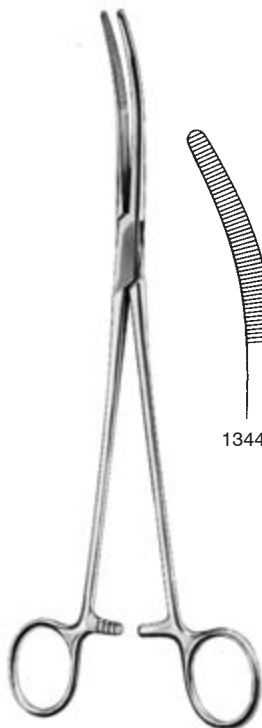

RUMEL
23 cm, 9"

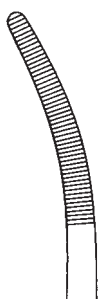

13441-01

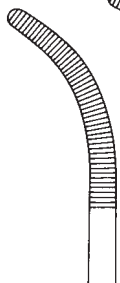

13441-02



13441-03

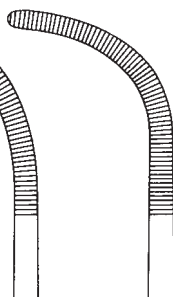

13441-04



WIKSTROEM
13447-20
20,5 cm, 8"

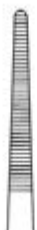

13442-21 21 cm, 8 1/4"
13442-26 26 cm, 10 1/4"

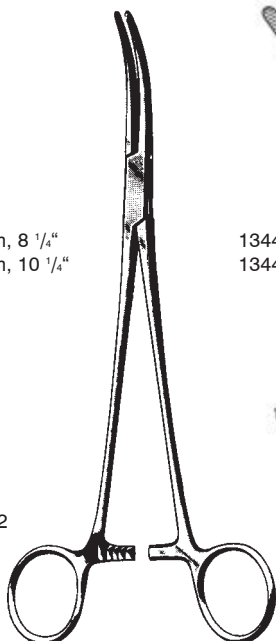

TOENNIS



13443-21 21 cm, 8 1/4"
13443-26 26 cm, 10 1/4"



13445-21 21 cm, 8 1/4"
13445-26 26 cm, 10 1/4"



13448-22 22 cm, 8 3/4" 13449-22



ROBERTS

13444-21 21 cm, 8 1/4"
13444-26 26 cm, 10 1/4"

1x2

1x2

Arterienklemmen
 Hemostatic Forceps
 Pinzas hemostáticas
 Pinze emostatiche



CRAFOORD
 13453-18 18 cm, 7"
 13453-24 24 cm, 9 1/2"



SAROT
 13450-24 24 cm, 9 1/2" 13451-24



13455-01



ZENKER
 29,5 cm, 11 1/2"



13455-02

Arterienklemmen
Hemostatic Forceps
Pinzas hemostáticas
Pinze emostatiche

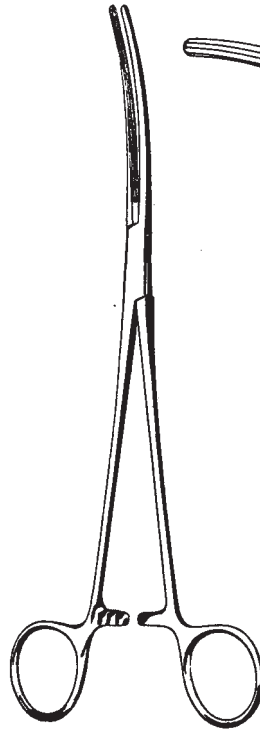

CRAFOORD-SELLORS
24 cm, 9 1/2"

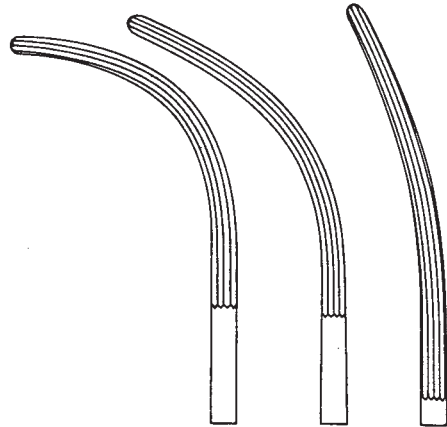

13456-01

13456-02

13456-03



LAWRENCE
13457-28 28 cm, 11"



MEEKER
13459-18 18 cm, 7"
13459-28 28 cm, 11"

Arterienklemmen
Hemostatic Forceps
Pinzas hemostáticas
Pinze emostatiche

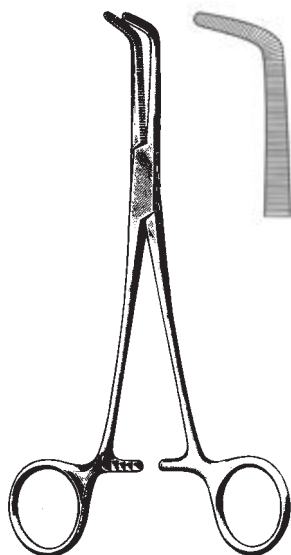

MIXTER

13471-14 14 cm, 5 1/2"
13471-16 16 cm, 6 1/4"
13471-18 18 cm, 7"
13471-23 23 cm, 9"



MIXTER

13473-22
22 cm, 8 3/4"



KANTROWITZ

13474-19 19 cm, 7 1/2"
13474-24 24 cm, 9 1/2"
13474-26 26 cm, 10 1/4"



MIXTER BABY

13475-14
14 cm, 5 1/2"

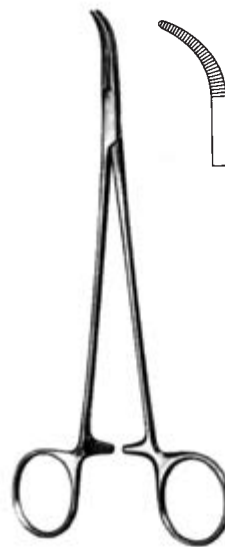

MIXTER BABY

13475-18
18 cm, 7"

Arterienklemmen
Hemostatic Forceps
Pinzas hemostáticas
Pinze emostatiche

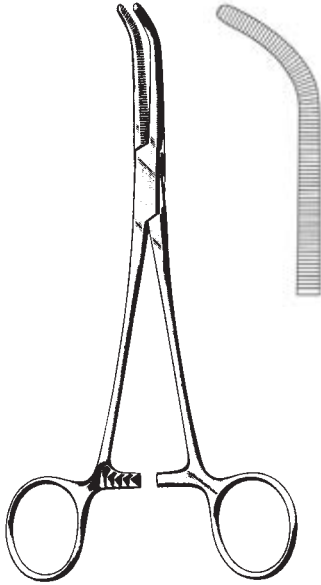

MIXTER-O'SHAUGHNESSY
13477-15 15,5 cm, 6"
13477-19 19,0 cm, 7 1/2"

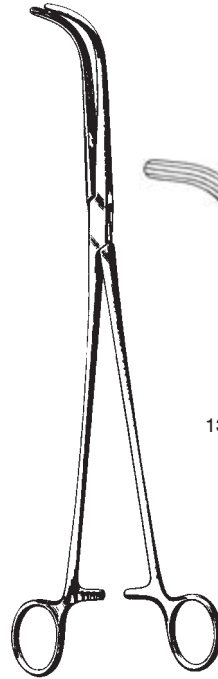

MIXTER

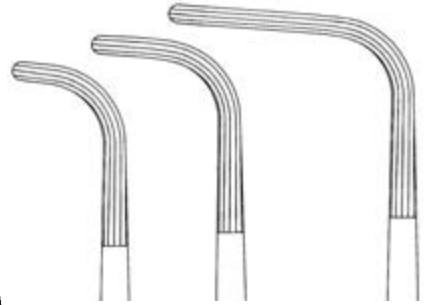

13479-22	13479-25	13479-28
22 cm	25 cm	28 cm
8 3/4"	10"	11"

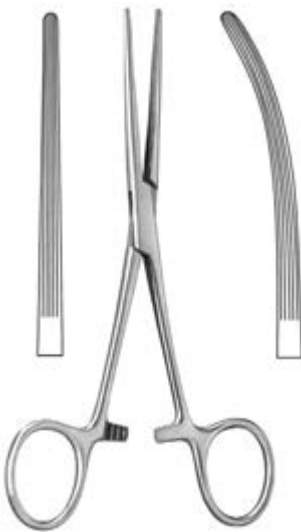

BAINBRIDGE
13480-15 15,0 cm, 6" 13481-15
13480-18 18,5 cm, 7 1/4" 13481-18

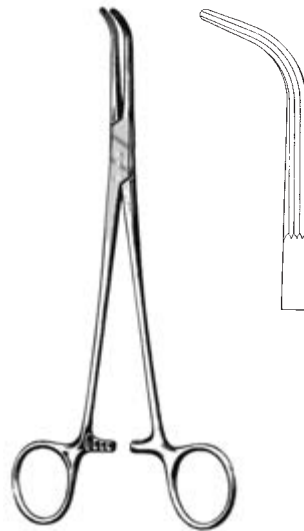

LAHEY
13491-19 19 cm, 7 1/2"

Arterienklemmen
Hemostatic Forceps
Pinzas hemostáticas
Pinze emostatiche



LAHEY
13493-23 23 cm, 9"



LOWER
13495-18 18 cm, 7"

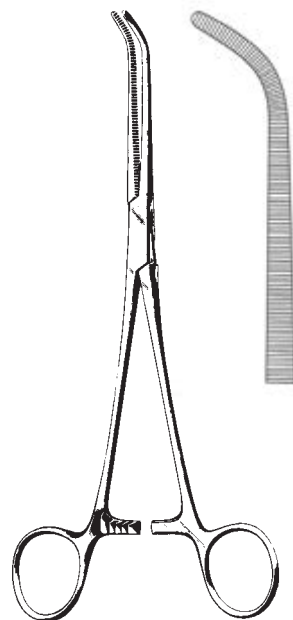

JOHNS-HOPKINS
13497-20 20 cm, 8"

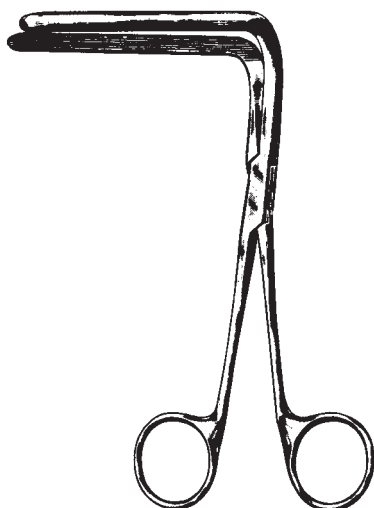

MIXTER
13499-16
16,5 cm, 6 1/2"

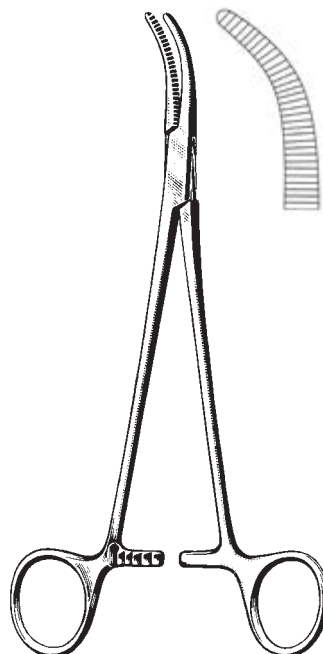

MOYNIHAN
13501-23
23 cm, 9"

Arterienklemmen
 Hemostatic Forceps
 Pinzas hemostáticas
 Pinze emostatiche



DESJARDINS
 13503-21 21 cm, 8 1/4"

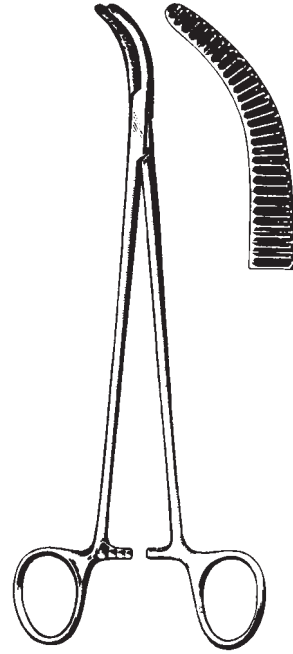

DESJARDINS
 13505-21 21 cm, 8 1/4"

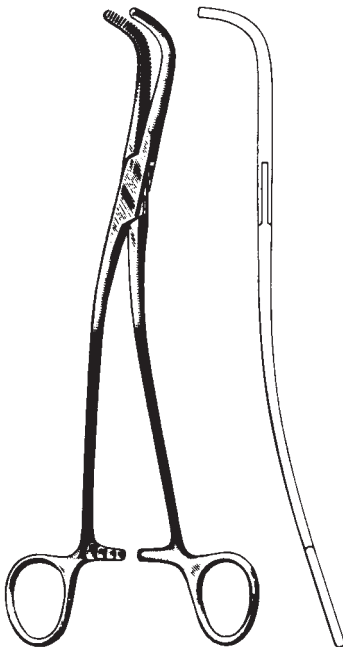

GRAY

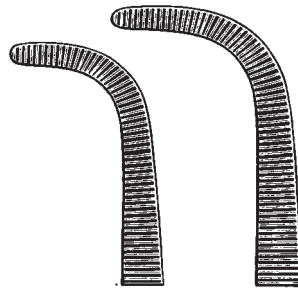

13507-22
 22 cm
 8 3/4"

13507-23
 23 cm
 9"

Arterienklemmen
 Hemostatic Forceps
 Pinzas hemostáticas
 Pinze emostatiche

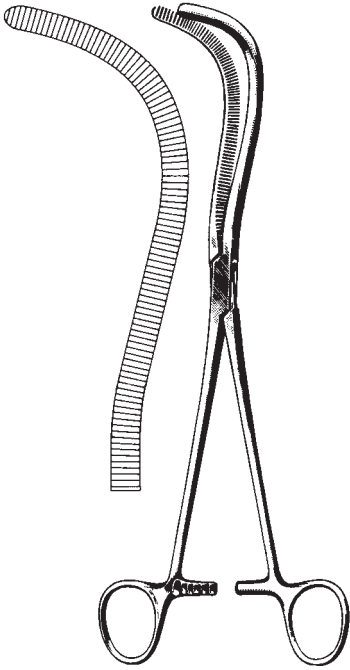

MAYO-GUYON
 13513-23
 23 cm, 9"

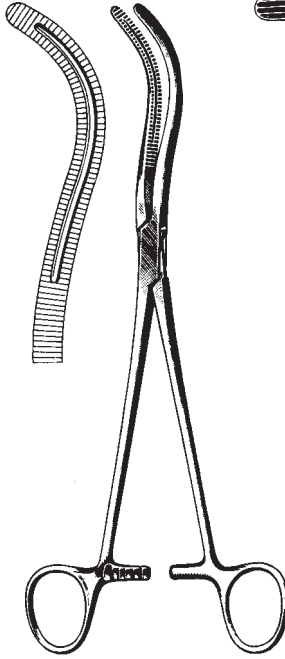

STILLE
 13515-23
 23 cm, 9"

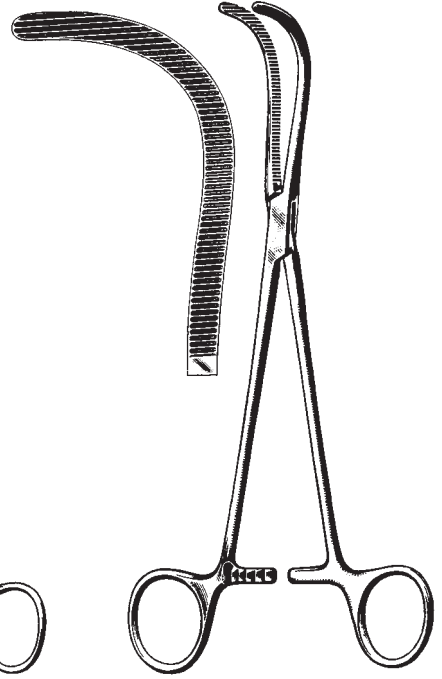

GUYON
 13517-23
 23 cm, 9"

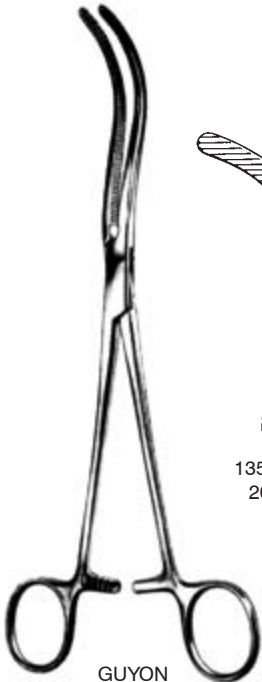

GUYON

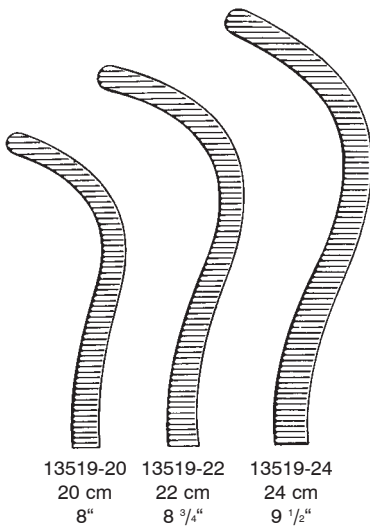

13519-20 20 cm 8"
 13519-22 22 cm 8 3/4"
 13519-24 24 cm 9 1/2"



GUYON



13520-23
 23 cm
 9"

13520-24
 24 cm
 9 1/2"

ATRAUMA

Hysterektomieklemmen
 Hysterectomy Forceps
 Pinzas para histerectomía
 Pinze per isterectomia

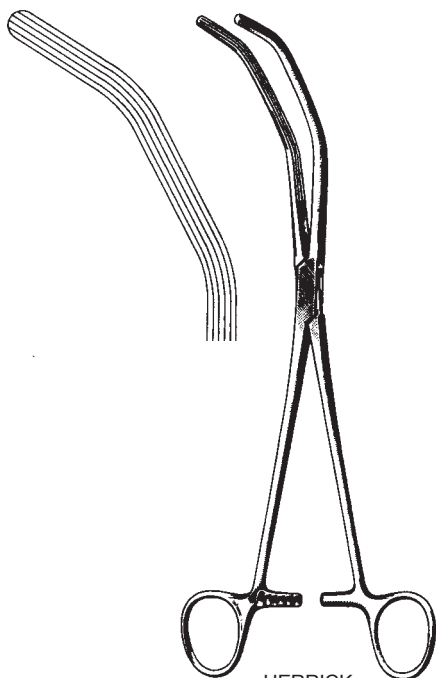

HERRICK
 13523-23
 23 cm, 9"

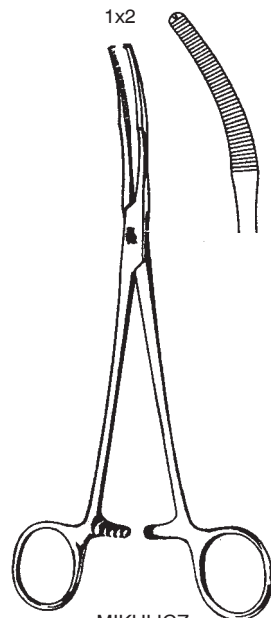

MIKULICZ
 13551-14 14 cm, 5 1/4" BABY
 13551-18 18 cm, 7"
 13551-20 20 cm, 8"

Peritoneum-Klemme
 Peritoneum Forceps
 Pinzas para peritoneo
 Pinze peritoneali

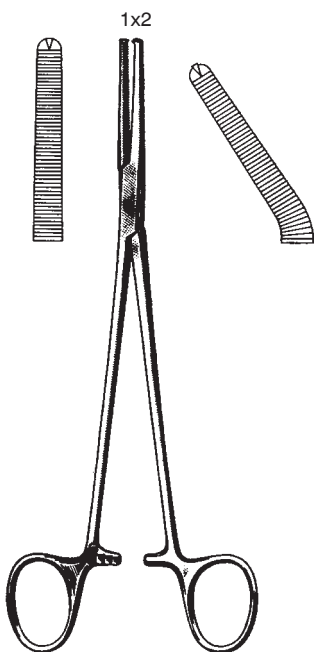

PHANEUF
 13554-21 21 cm, 8 1/4" 13555-21



MIKULICZ
 13556-24 24 cm, 9 1/2"

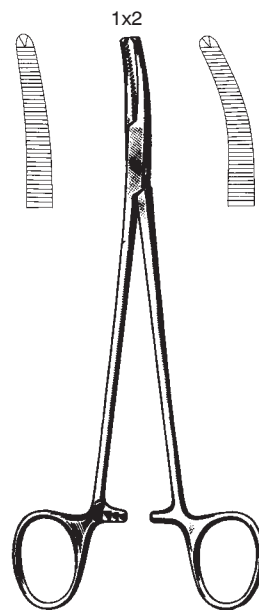

FAURE
 13561-20 20 cm, 8" 13563-20

Hysterektomieklemmen
Hysterectomy Forceps
Pinzas para histerectomía
Pinze per isterectomia



MAINGOT
13564-20 20 cm, 8"

Hysterektomieklemmen
Hysterectomy Forceps
Pinzas para histerectomía
Pinze per isterectomia



13565-20
20,5 cm, 8"



13565-25
25 cm, 10"

MAINGOT

Hysterektomieklemmen
 Hysterectomy Forceps
 Pinzas para histerectomía
 Pinze per isterectomia

1x2



WERTHEIM
 13570-23
 23,5 cm, 9 1/4"

1x2

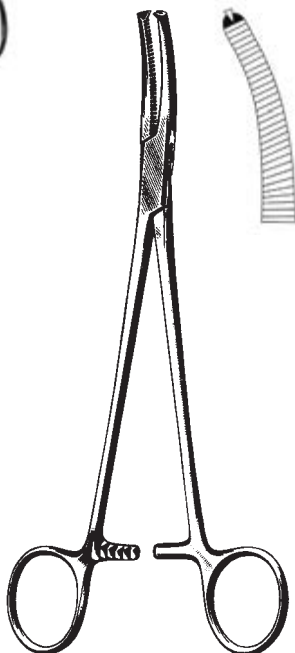

WERTHEIM
 13573-22 22 cm, 8 3/4"

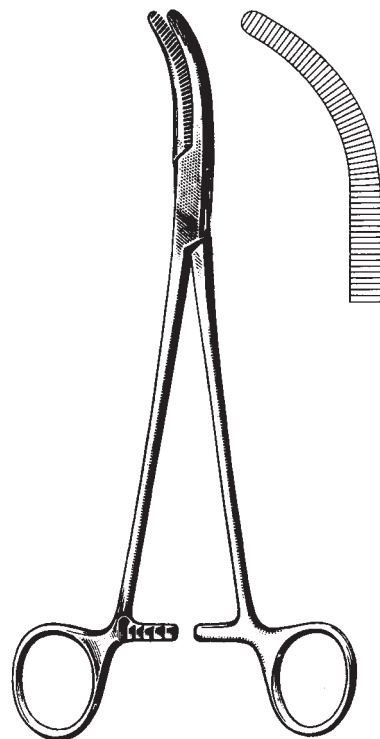

WERTHEIM
 13571-25
 25 cm, 10"

Hysterektomieklemmen
Hysterectomy Forceps
Pinzas para histerectomía
Pinze per isterectomia



SEGOND-LANDAU
13574-24
24 cm, 9 1/2"



SEGOND
13575-24
24 cm, 9 1/2"



WERTHEIM-CULLEN
13579-21 21,5 cm, 8 1/2"



Hysterektomieklemmen
 Hysterectomy Forceps
 Pinzas para histerectomía
 Pinze per isterectomia



13580-80
 80 mm, 3"
 Maul/Morso/Boca



13580-60
 60 mm, 2 1/4"
 Maul/Morso/Boca



23 cm, 9"



13591-20
 13591-23

13593-20
 13593-23



HEANEY
 20 cm, 8"

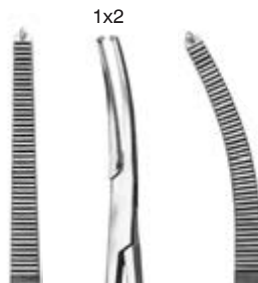

1x2

13598-24 HOLZBACH 24 cm, 9 1/2" 13599-24



Hysterektomieklemmen
 Hysterectomy Forceps
 Pinzas para histerectomía
 Pinze per isterectomia



ATRAUMA

ROGERS
 13595-10 - 13597-40



22 cm
 8 3/4"
 13595-10



21,5 cm
 8 1/2"
 13595-20



21 cm
 8 1/4"
 13595-30

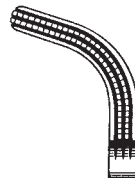

20,5 cm
 8"
 13595-40



25 cm
 10"
 13597-10



25 cm
 10"
 13597-20

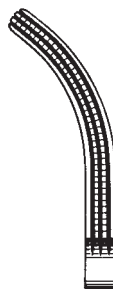

24,5 cm
 9 3/4"
 13597-30

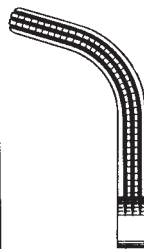

23 cm
 9"
 13597-40

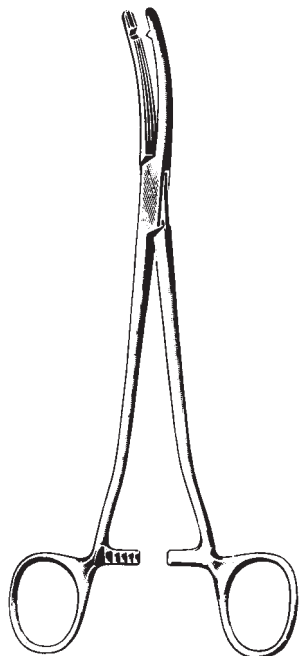

HEANY-BALLENTINE
 13600-20 - 13601-20
 20 cm, 8"



BALLENTINE
 13600-20



HEANY-BALLENTINE
 13601-20

Hysterektomieklemmen
Hysterectomy Forceps
Pinzas para histerectomía
Pinze per isterectomia



WERTHEIM
13605-26
25,5 cm, 10"

Parametriumklemmen
 Parametrium Clamps
 Pinza para parametrio
 Pinza per parametrio



REDA
 21 cm 8 1/4"



13610-21



13611-21



13612-21



13613-21

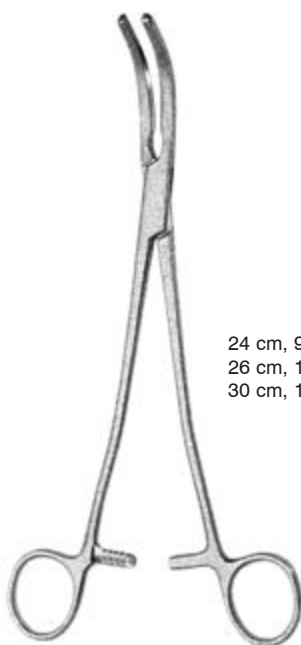

REDA



13620-24
 13620-26
 13620-30



13621-24
 13621-26
 13621-30



13622-24
 13622-26
 13622-30



13623-24
 13623-26
 13623-30

24 cm, 9 1/2"
 26 cm, 10 1/4"
 30 cm, 12"



Schlauchklemmen
 Tubing Clamps
 Pinzas cierra-tubos
 Pinze serratubi

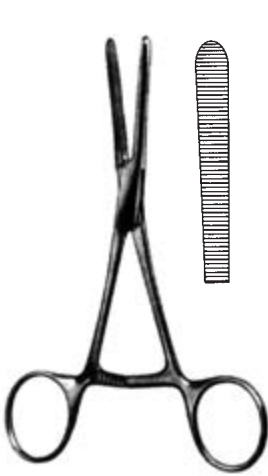

KLINIKUM BERLIN
 13702-14
 14,5 cm, 5 3/4"



13710-15
 15 cm, 6"



13710-18
 18 cm, 7"



13710-20
 20 cm, 8"



PRESBYTERIAN
 13704-16 16 cm, 6 1/4"
 13704-18 18 cm, 7"

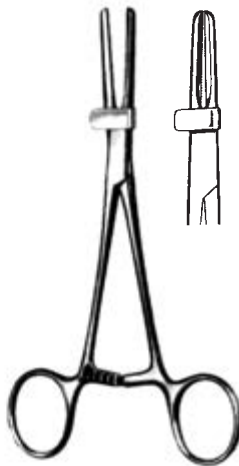

13712-15
 15 cm, 6"



13712-18
 18 cm, 7"



13712-20
 20 cm, 8"



Rollenklemme
Tube milking rollers
Pinza de rodillos
Pinze con rotelle



BÜLOW-GUNAR-HEY
13720-18 18 cm, 7"

Rollenklemme
Tube milking rollers
Pinza de rodillos
Pinze con rotelle



13730-16 16,5 cm, 6 1/2"

Tuchklemmen
Towel Forceps
Pinzas de campos
Pinze fissateli



SCHAEDDEL
15101-09
9 cm, 3 1/2"



JONES
15103-07
7 cm, 2 3/4"

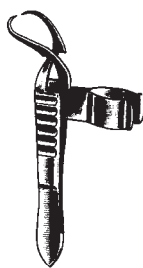

JONES-CLIP
15105-09
9 cm, 3 1/2"

15103-09
9 cm, 3 1/2"

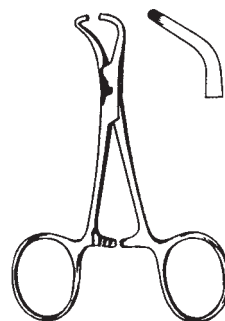

TOHUKU
15107-10 10 cm, 4"
15107-13 13 cm, 5 1/8"



PEERS
15108-14
14,5 cm, 5 3/4"

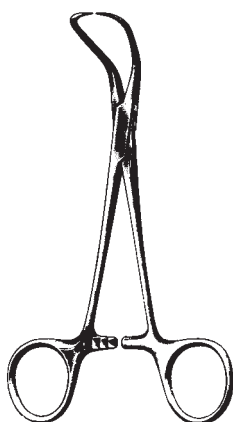

BACKHAUS
15111-09 9 cm, 3 1/2"
15111-11 11 cm, 4 3/8"
15111-13 13 cm, 5 1/8"
15111-15 15 cm, 6"



BACKHAUS-CLIP
15115-11
11 cm, 4 3/8"

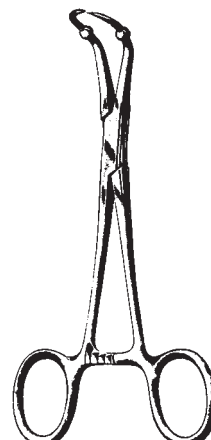

ROEDER
15117-13
13 cm, 5 1/8"

Tuchklemmen
Towel Forceps
Pinzas de campos
Pinze fissateli



LORNA
15121-11 11 cm, 4 ³/₈"
15121-13 13 cm, 5 ¹/₈"



BALL AND SOCKET
15123-11 11 cm, 4 ³/₈"
15123-13 13 cm, 5 ¹/₈"



15125-14
14,5 cm, 5 ³/₄"

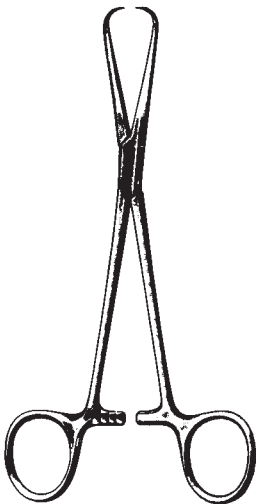

BERNHARD
15140-16
16,5 cm, 6 ¹/₂"

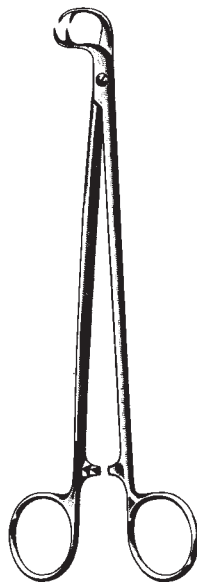

MOYNIHAN
15150-19
19 cm, 7 ¹/₂"



DOYEN
15161-18
18 cm, 7"



LANE
15164-15 15 cm, 6"
15164-20 20 cm, 8"

Tupfer- und Kornzangen
 Dressing Forceps
 Pinzas para tampones y curaciones
 Pinze per tamponi e per medicazione

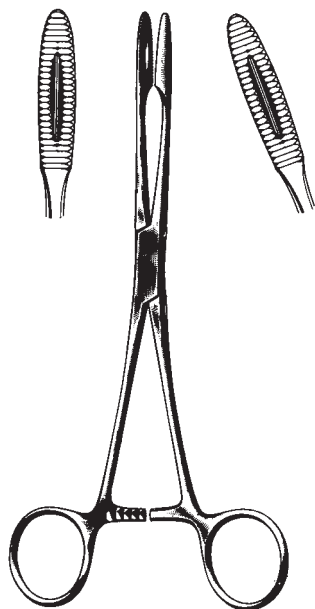

GROSS-MAIER

17110-20 20 cm, 8" 17111-20
 17110-25 25 cm, 10" 17111-25

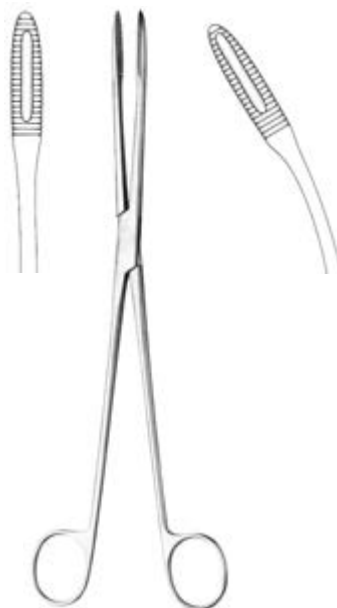

GROSS-MAIER

17112-20 20 cm, 8" 17113-20
 17112-25 25 cm, 10" 17113-25



17120-28

17121-28

SIMS-MAIER
28 cm, 11"DUPLAY
17131-21 21 cm, 8 1/4"

Tupfer- und Kornzangen
 Dressing Forceps
 Pinzas para tampones y curaciones
 Pinze per tamponi e per medicazione



17133-17 17 cm, 6 3/4"

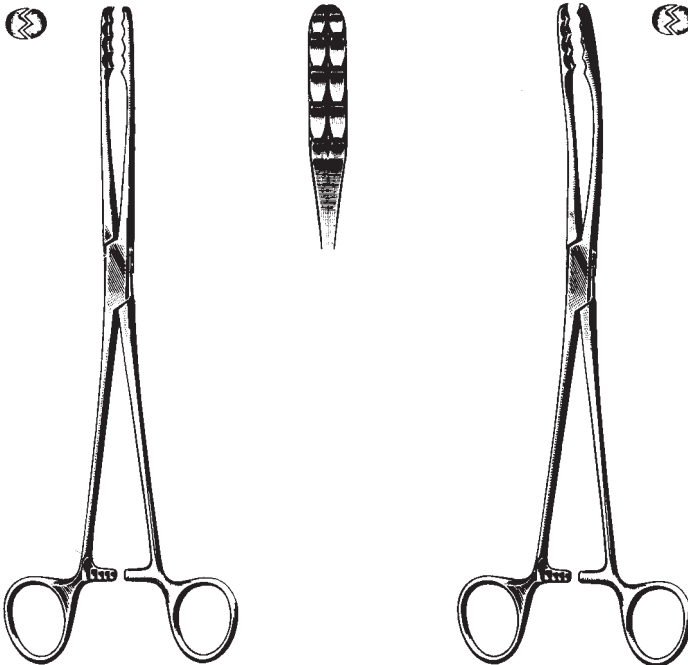

ULRICH
 17160-22 22 cm, 8 3/4"
 17160-25 25 cm, 10"

ULRICH
 17161-22 22 cm, 8 3/4"
 17161-25 25 cm, 10"

Schwammzange
Sponge Forceps
Pinzas porta-esponjas
Pinze per spugne

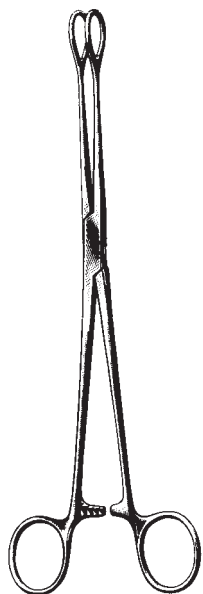

FOERSTER

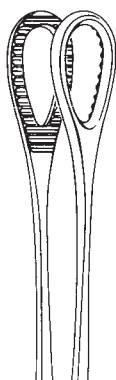

17170-18
17170-20
17170-25
17170-30

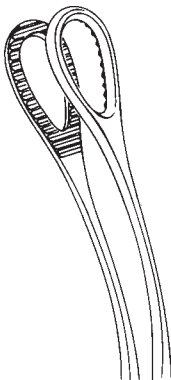

17171-18 18 cm, 7"
17171-20 20 cm, 8"
17171-25 25 cm, 10"

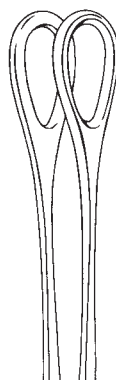

17172-18
17172-25

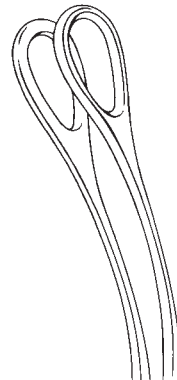

17173-18
17173-25



17174-25

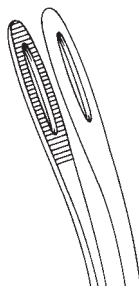

17175-25

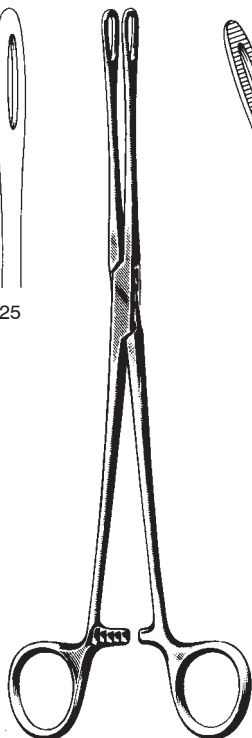

FOERSTER
25 cm, 10"



17180-18
18 cm, 7"



17180-25
25 cm, 10"

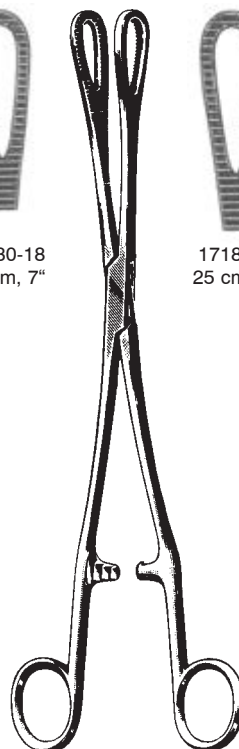

RAMPLEY

Kornzangen, Sinusklemmen
Dressing Forceps, Sinus Forceps
Pinzas para vendajes
Pinze per medicature, Pinze per seni



BRYANT
17207-13 13 cm, 5 1/8"



LISTER (Sinus)
17210-13 13 cm, 5 1/8"
17210-16 16 cm, 6 1/4"
17210-18 18 cm, 7"

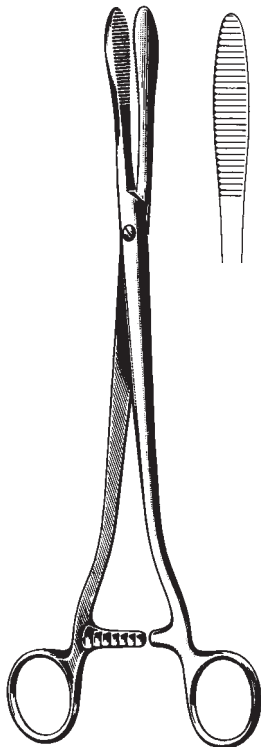

COLLIN
17220-25 25 cm, 10"



17226-25 17227-25

PELKMANN
25 cm, 10"



CHERON
17229-25 25 cm, 10"

Tamponzangen
Dressing Forceps
Pinzas para tapones
Pinze per tamponi

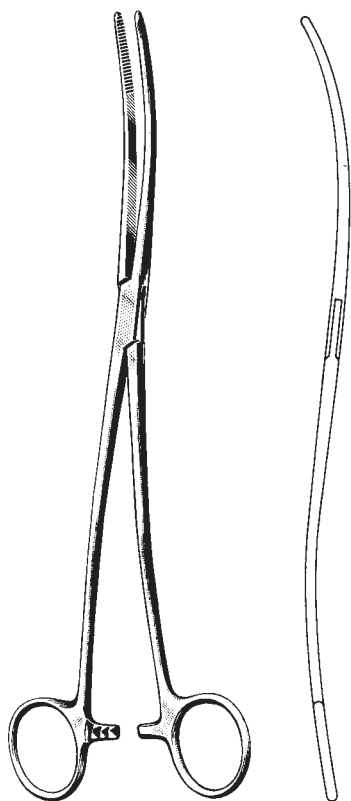

— BOZEMANN —
17230-26 17231-26
26 cm, 10 1/4"

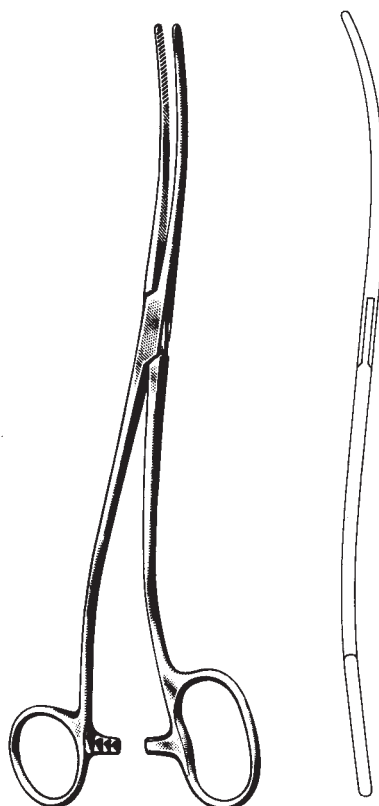

BOZEMANN-DOUGLAS
17233-26
26 cm, 10 1/4"

Wundhaken
Retractors
Separadores
Divaricatori

Satz, set, juego, serie

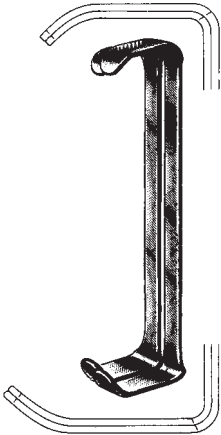

FARABEU
19102-12
12 cm, 4 3/4"

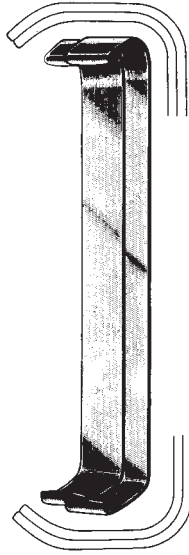

FARABEU
19102-15
15 cm, 6"



COLLIN
19104-15
15 cm, 6"

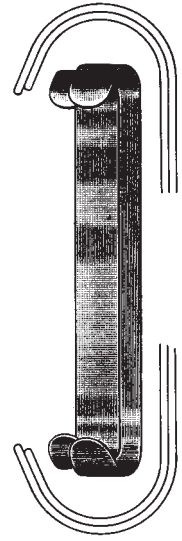

PARKER
19110-13
13,5 cm, 5 1/4"

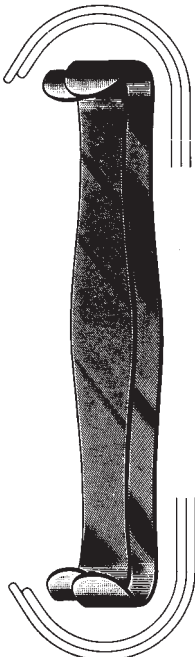

PARKER
19110-18 18 cm, 7"

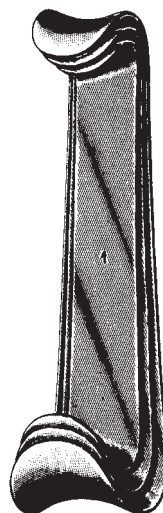

ROUX
19120-00

Fig. 1 = 24x20 mm
Fig. 2 = 29x26 mm
Fig. 3 = 35x29 mm

Fig. 1 = 30x28 mm
Fig. 2 = 36x36 mm
Fig. 3 = 38x43 mm

19120-14 Fig. 1 14 cm, 5 1/2"
19120-15 Fig. 2 15 cm, 6"
19120-17 Fig. 3 17 cm, 6 3/4"

Wundhaken
Retractors
Separadores
Divaricatori



ROUX BABY
19122-13
13 cm, 5 1/8"

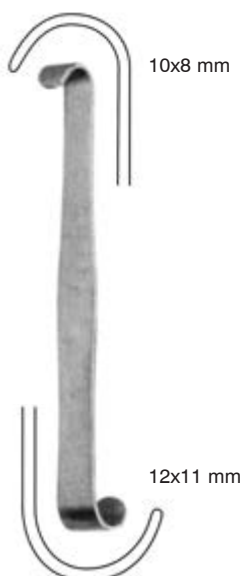

LUER
19123-11
11 cm, 4 3/8"



ROUX mini
19124-15
14 cm, 5 1/2"

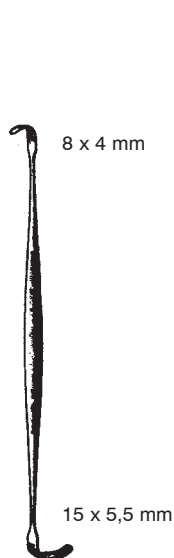

RAGNELL
19125-14
14 cm, 5 1/2"



ROSE
19126-13
13 cm, 5 1/8"



CRILE
19127-11
11,5 cm, 4 1/2"

Wundhaken
Retractors
Separadores
Divaricatori

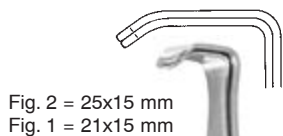
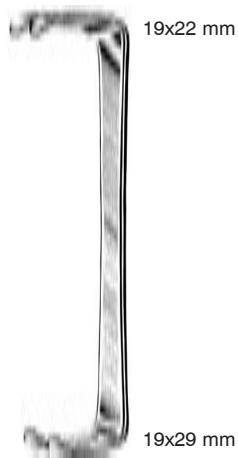

Fig. 2 = 25x15 mm
Fig. 1 = 21x15 mm

Fig. 1 = 40x15 mm
Fig. 2 = 45x15 mm



US ARMY / Parker-Langenbeck
19131-21 21 cm, 8 1/4"



19x22 mm

19x29 mm

MAYO-COLLINS
19132-15 15 cm, 6"

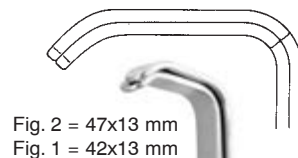

Fig. 2 = 47x13 mm
Fig. 1 = 42x13 mm

Fig. 1 = 42x26 mm
Fig. 2 = 46x26 mm



MATHIEU
19134-20 20 cm, 8"



37x40 mm

30 x 31 mm

GOELET
19135-19 19 cm, 7 1/2"

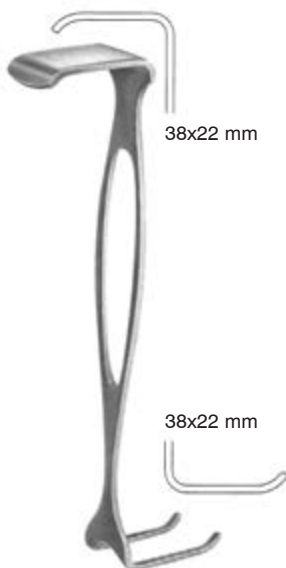

38x22 mm

38x22 mm

CZERNY
19136-20 17,5 cm, 6.9"

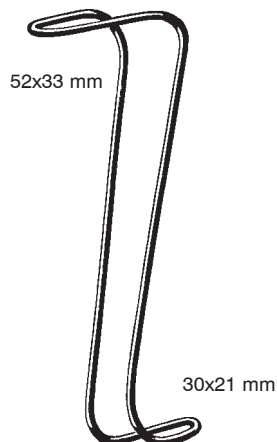

52x33 mm

30x21 mm

COLLIN-HARTMANN
19137-16 16 cm, 6 1/4"

Wundhaken
Retractors
Separadores
Divaricatori

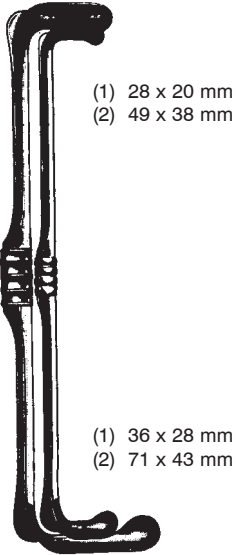

RICHARDSON-EASTMAN

- (Set) 19140-00
(1) 19140-01 26 cm, 10 1/4"
(2) 19140-02 28 cm, 11"

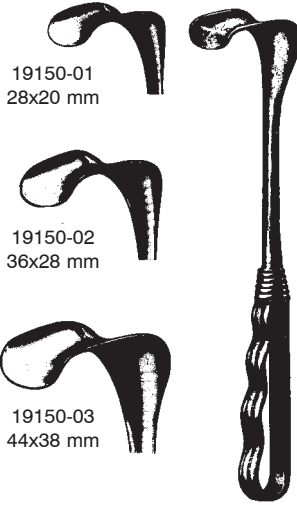

RICHARDSON

24 cm, 9 1/2"



RICHARDSON

19150-04
24 cm, 9 1/2"

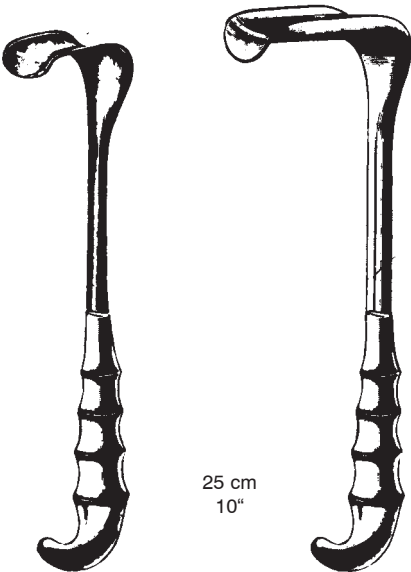

RICHARDSON GRIP

- 19152-25 20x25 mm
19152-31 25x31 mm
19152-38 38x38 mm
19152-51 19x51 mm
19152-64 41x64 mm

KELLY GRIP

- 19158-51 38x51 mm
19158-64 51x64 mm
19158-76 64x76 mm
19158-82 70x82 mm



KELLY

26 cm, 10 1/4"

Wundhaken
Retractors
Separadores
Divaricatori



19160-17



19161-17

SENN-MILLER

17 cm, 6 3/4"



HASSON

Satz, set, juego, serie

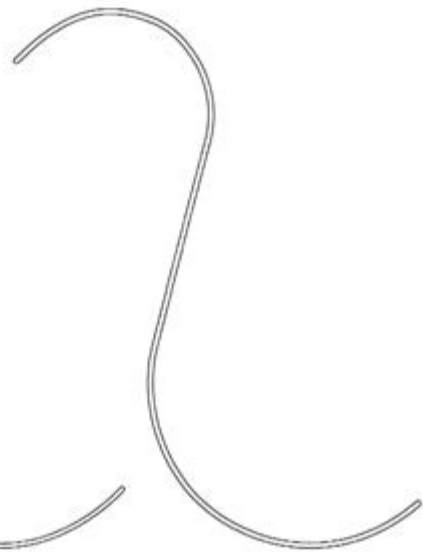
19162-10 10 mm
16 cm, 6 1/4"19162-13 13 mm
18 cm, 7"

Bauch- und Darmspatel
 Abdominal and intestinal spatulas
 Separadores, espátula intestinal y abdominal
 Divaricatori, spatole addominali e intestinali

biegsam, malleable, maleable, malleabili



RIBBON

19168-06 6x200 mm
 19168-08 8x200 mm
 19168-10 10x200 mm
 19168-12 12x200 mm
 19168-17 17x200 mm
 19168-20 20x200 mm
 19168-25 25x200 mm
 19169-25 25x250 mm



RIBBON

19170-20 20x330 mm
 19170-25 25x330 mm
 19170-32 32x330 mm
 19170-40 40x330 mm
 19170-45 45x330 mm
 19170-50 50x330 mm
 19170-65 65x330 mm
 19170-76 76x330 mm

Bauch- und Darmspatel
Abdominal and intestinal spatulas
Separadores, espátula intestinal y abdominal
Divaricatori, spatole addominali e intestinali

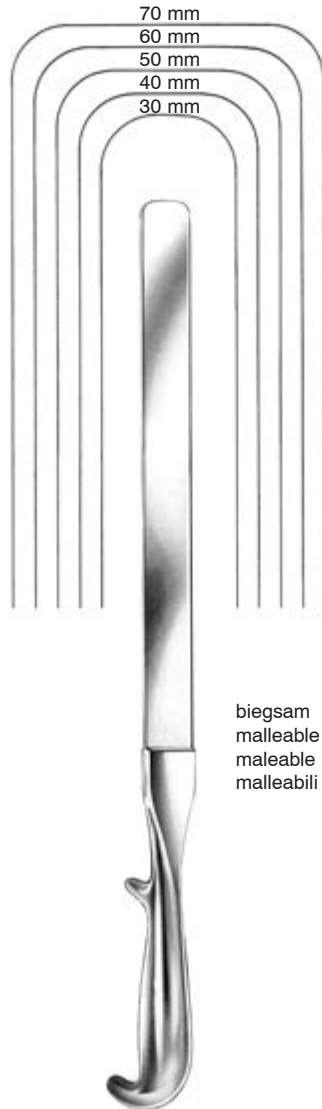

41 cm, 16"
19171-30 30 mm
19171-40 40 mm
19171-50 50 mm
19171-60 60 mm
19171-70 70 mm

Bauch- und Darmspatel
 Abdominal and intestinal spatulas
 Separadores, espátula intestinal y abdominal
 Divaricatori, spatole addominali e intestinali

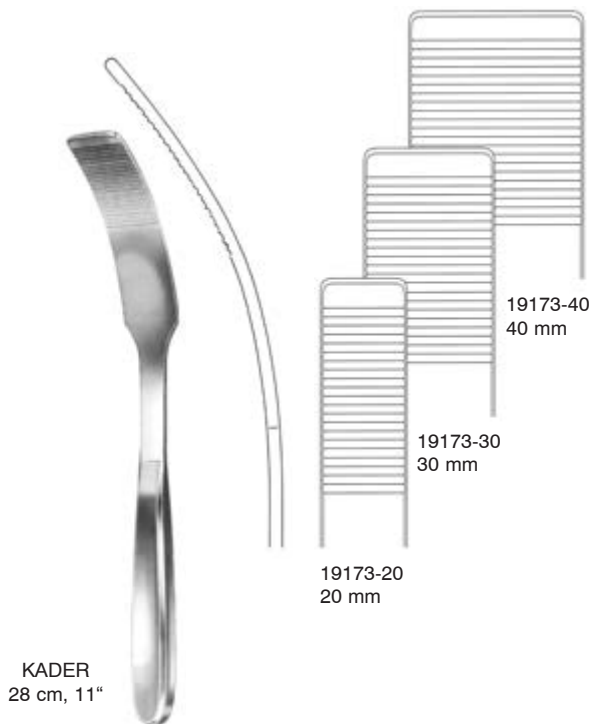

HABERER
 19174-17 17/25x200 mm
 19174-25 25/30x280 mm
 19174-37 37/45x300 mm
 19174-40 40/50x300 mm



REVERDIN
 19175-28
 28 cm, 11"

Bauch- und Darmspatel
Abdominal and intestinal spatula
Separadores, espátula intestinal y abdominal
Divaricatori, spatole addominali e intestinali

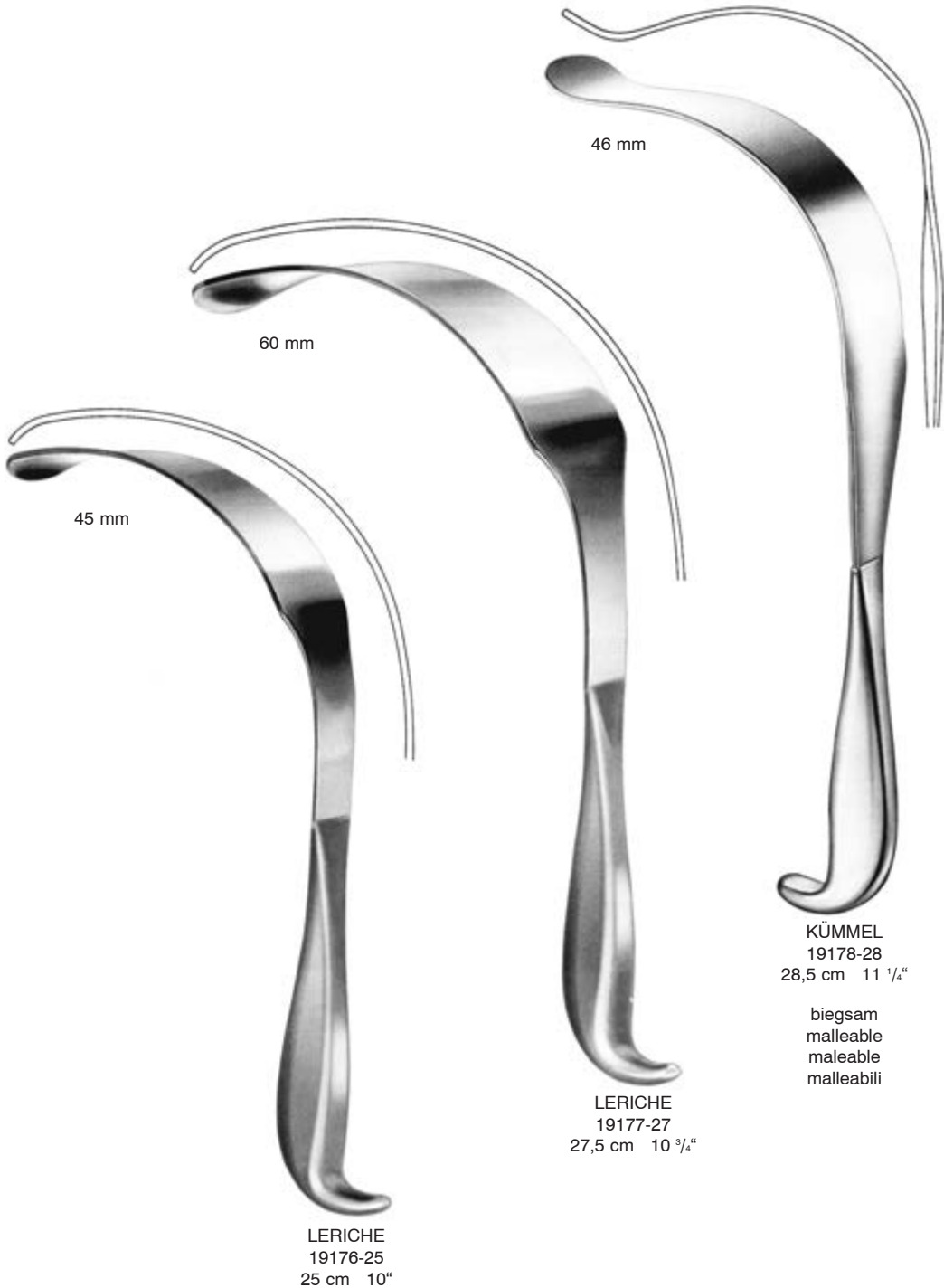

Bauchspatel
Abdominal Spatulas
Espátula abdominal
Spatola addominale



KÜMMEL
19179-28
31 cm 12 1/4"

Wundhaken
Retractors
Separadores
Divaricatori



DEAVER
19180-19
19 cm, 7 1/2"



DEAVER
19181-22
21,5 cm, 8 1/2"



DEAVER
19181-25
23 cm, 9"



DEAVER
19183-25
30 cm, 11 3/4"



DEAVER
19185-25
33 cm, 13"



DEAVER
19187-25
36 cm, 14"

Wundhaken
Retractors
Separadores
Divaricatori



38 mm

DEAVER
19187-38
30 cm, 11 ³/₄"



50 mm

DEAVER
19187-50
31 cm 12 ¹/₄"



75 mm

DEAVER
19187-75
32 cm, 12 ³/₄"



DEAVER GRIP
19189-25 25x310 mm
19189-38 38x310 mm
19189-50 50x310 mm
19189-75 75x310 mm
31 cm 12 ¹/₄"

Wundhaken
Retractors
Separadores
Divaricatori

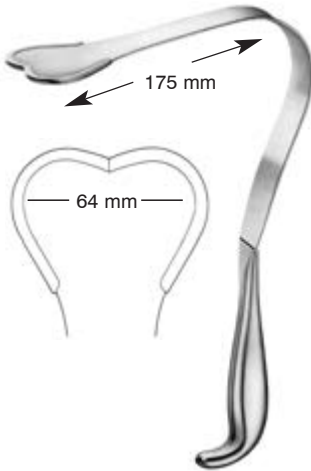

HARRINGTON-PEMBERTON
19190-64
29,5 cm 11 ³/₄"



HARRINGTON
19191-25 25x230 mm
19191-40 40x320 mm
19191-62 62x320 mm



TUFFIER
19192-23
23 cm, 9"

Wundhaken
Retractors
Separadores
Divaricatori

30°
rechts
right
a la derecha
a destra



45x48 mm

COOLEY
19195-01
24,5 cm, 9 3/4"

30°
rechts, gerieft
right serrated
a la derecha, estriado
a destra, zigrinato



45x48 mm

COOLEY
19195-02
24,5 cm, 9 3/4"

30°
links
left
a la izquierda
a sinistra



24x48 mm

COOLEY
19195-03
25,5 cm, 10"

Aortahaken
Aorta Retractors
Separadores para aorta
Divaricatori per aorta



ROSS

flexibler Schaft
flexible shaft
vástago flexible
asta flessibile



19196-01
24 cm, 9 1/2"



19196-02
24,5 cm, 9 3/4"



19196-03
25 cm, 10"



19196-04
25,5 cm, 10"



19196-05
27 cm, 10 1/2"



19196-06
25,5 cm, 10"

Hauthäkchen

Nerve and wound hooks

Ganchos y ganchitos para nervios

Uncini per nervi e divaricatori fini



GRAEFE
19210-12
scharf
sharp
agudo
acuto



GRAEFE
19211-12
stumpf
blunt
romo
smusso



12 cm, 4 3/4"



GUTHRIE
19212-01



GUTHRIE
19212-02



scharf
sharp
agudo
acuto
A



stumpf
blunt
romo
smusso
B

FRAZIER

- | | | |
|---|----------|-----------|
| A | 19214-13 | 13 cm, 5" |
| A | 19214-18 | 18 cm, 7" |
| B | 19215-13 | 13 cm, 5" |
| B | 19215-18 | 18 cm, 7" |

Hauthäkchen
 Nerve and wound hooks
 Ganchos y ganchitos para nervios
 Uncini per nervi e divaricatori fini

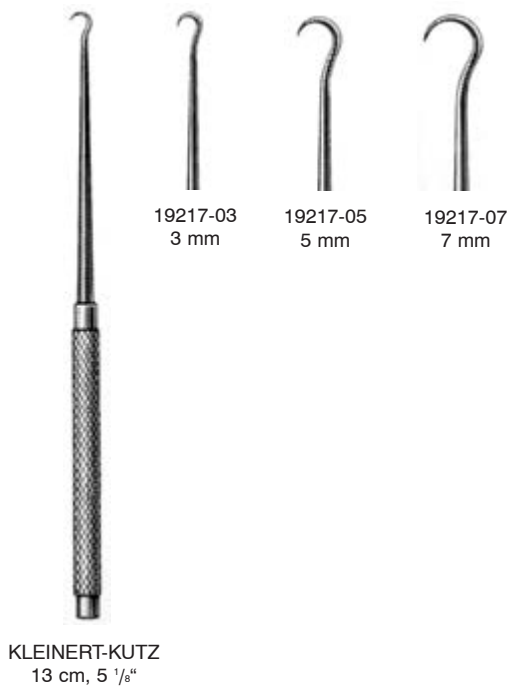
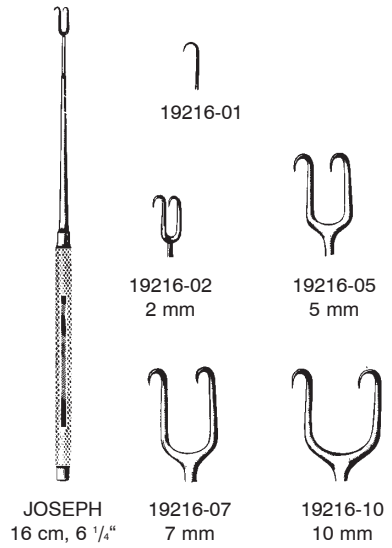

Hauthäkchen
 Nerve and wound hooks
 Ganchos y ganchitos para nervios
 Uncini per nervi e divaricatori fini

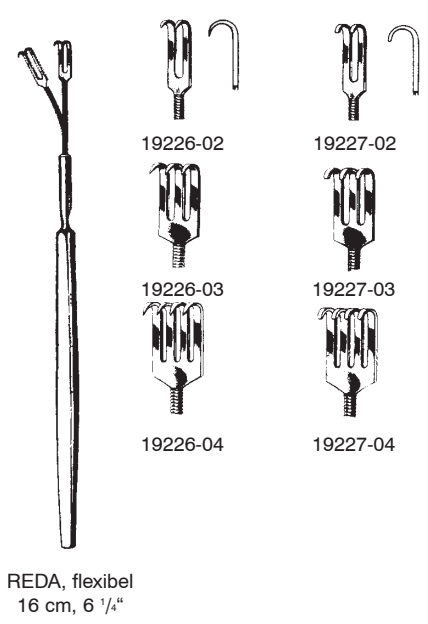
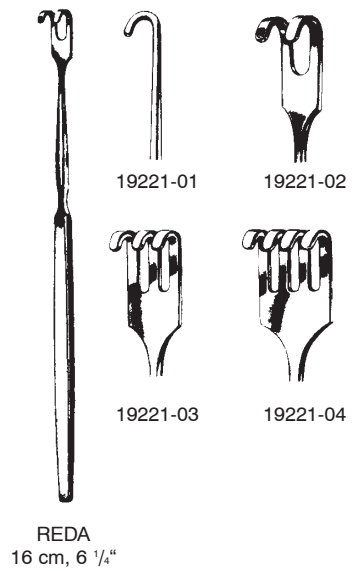
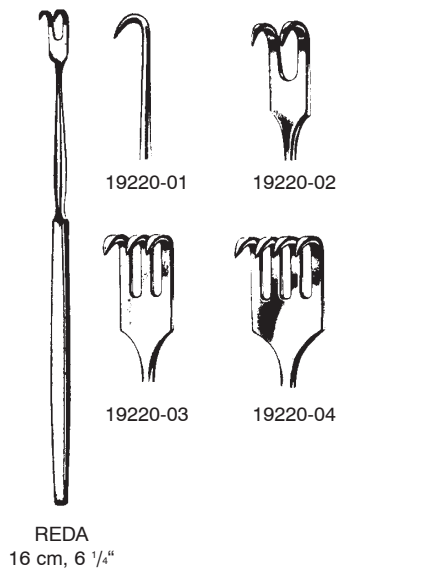

Sattelhäkchen
Saddle Hooks
Ganchos en forma de silla
Divaricatori a forma di sella



DESMARRES
16 cm, 6 1/4"



19230-12 12 mm



19230-10 10 mm



19230-14 14 mm



19230-16 16 mm



19230-18 18 mm



19231-11
11x14 mm



19231-13
13x18 mm



19231-15
15x22 mm

CUSHING
25 cm, 10"



CUSHING
20 cm, 8"



19232-08 8 mm



19232-10 10 mm



19232-12 12 mm



19232-14 14 mm



19232-16 16 mm



19232-18 18 mm

Sattelhäkchen
 Saddle Hooks
 Ganchos en forma de silla
 Divaricatori a forma di sella



CUSHING
 24 cm, 9 1/2"

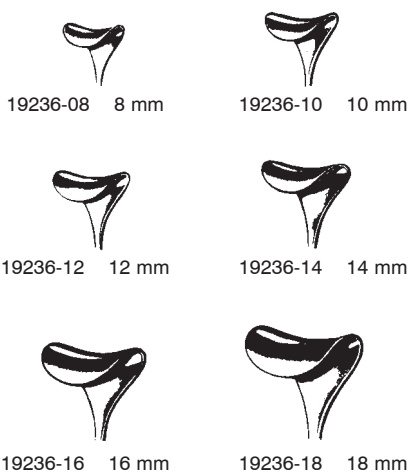

19236-08 8 mm

19236-10 10 mm

19236-12 12 mm

19236-14 14 mm

19236-16 16 mm

19236-18 18 mm



GIL-VERNET
 24 cm, 9 1/2"

biegsam
 malleable
 maleable
 malleabile



19233-08
 8 mm

19233-11
 11 mm

19233-15
 15 mm



19233-17
 17 mm

19233-20
 20 mm

19233-23
 23 mm

Wundhaken
Retractors
Separadores
Divaricatori



CUSHING
19234-20
20 cm, 8"



CUSHING
19235-21
21,5 cm, 8 1/2"



KÖNIG
18 cm, 7"



19236-01
13x13 mm



19236-02
12x16 mm



SENN-GREEN
15 cm, 6"



19240-10 10x6 mm



19240-20 20x6 mm



LANGENBECK-GREEN
16 cm, 6 1/4"



19250-16
16x6 mm



19250-24
24x6 mm



VOLKMANN
11,5 cm, 4 1/2"



19270-02



19271-02



19270-03



19271-03



19270-04



19271-04



19270-06



19271-06

Wundhaken
 Retractors
 Separadores
 Divaricatori



19280-01



19280-02



19280-03



19280-04



19280-06



scharf
 sharp
 agudo
 acuto



19281-01



19281-02



19281-03



19281-04



19281-06



stumpf
 blunt
 romo
 smusso



19282-02



19282-03



19282-04



19282-06



halbscharf
 semi-sharp
 medio romo
 mezzo smusso



VOLKMANN
 21,5 cm, 8 1/2"

Wundhaken
Retractors
Separadores
Divaricatori



19296-01



19296-02



19296-03



19296-04



19296-06

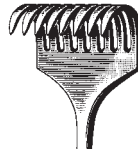

19296-08



scharf
sharp
agudo
acuto



19297-01



19297-02



19297-03



19297-04



19297-06

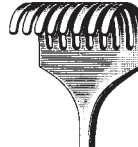

19297-08



stumpf
blunt
romo
smusso



KOCHER
22 cm, 8 ³/₄"



Wundhaken, Knochenhaken
 Retractors, Bone Retractors
 Separadores, Separadores oseos
 Divaricatori, Divaricatori per ossa



23 mm

scharf
 sharp
 agudo
 acuto

VOLKMANN
 19298-01
 22 cm 8 3/4"



23 mm

stumpf
 blunt
 romo
 smusso

VOLKMANN
 19299-01
 22 cm 8 3/4"

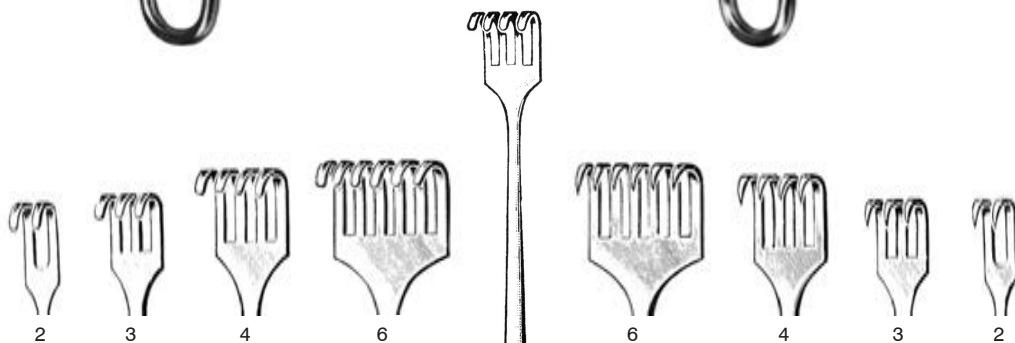

2

3

4

6

6

4

3

2

stumpf
 blunt
 romo
 smusso

19301-02 8x 8 mm
 19301-03 8x13 mm
 19301-04 8x18 mm
 19301-06 8x28 mm

scharf
 sharp
 agudo
 acuto

19300-02 8x 8 mm
 19300-03 8x13 mm
 19300-04 8x18 mm
 19300-06 8x28 mm

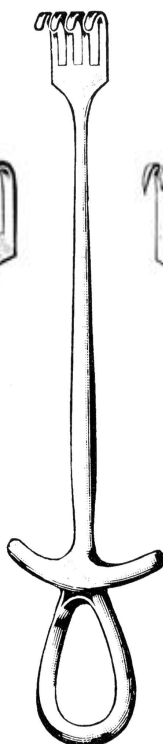

MURPHY
 19,4 cm 7 5/8"

Wundhaken
Retractors
Separadores
Divaricatori



MEYERDING
18 cm, 7"



19302-01 18x7 mm



19302-04 7x4 mm



19302-02 16x5 mm



19302-05 10x3 mm



19302-03 7x4 mm



19302-06 10x4 mm



28x6 mm



LAHEY
19304-19
19 cm, 7 1/2"



12x14 mm



LITTLE
19306-20
20 cm, 8"



19307-01



19307-02

STRANDELL-STILLE
17 cm 6 3/4"

Wundhaken
 Retractors
 Separadores
 Divaricatori

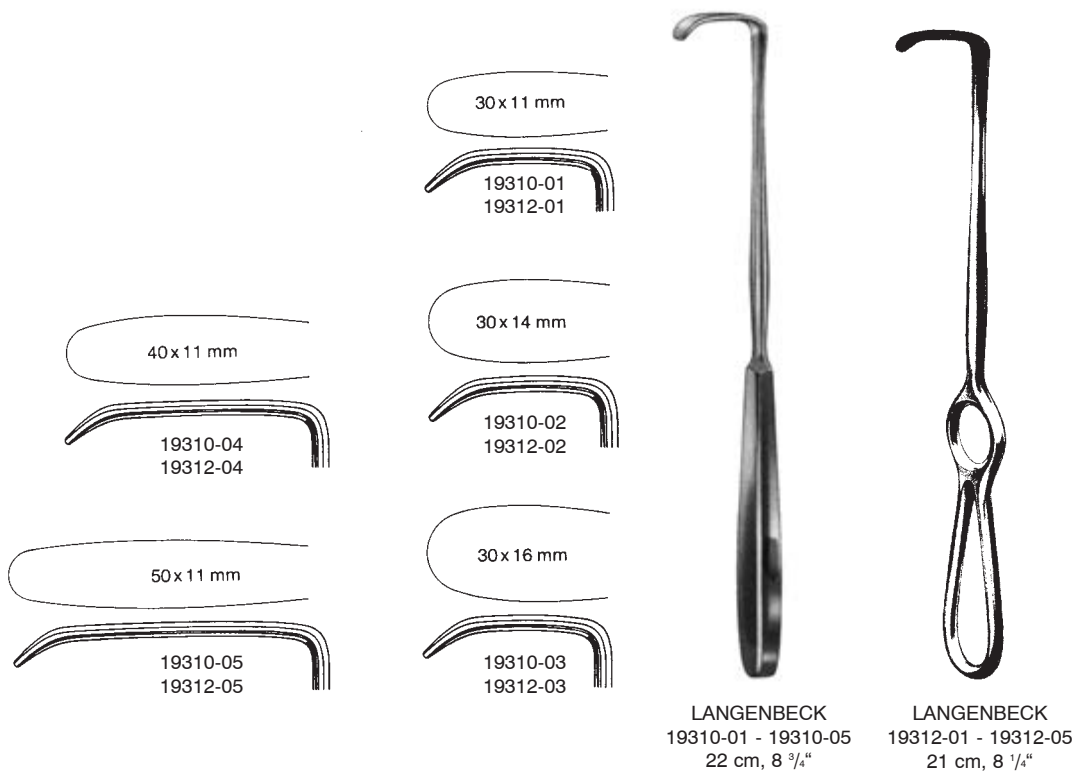

Wundhaken
Retractors
Separadores
Divaricatori

- 19315-06 25x 6 mm
- 19314-07 35x 7 mm
- 19314-10 35x10 mm
- 19314-12 80x12 mm
- 19314-14 70x14 mm
- 19314-15 35x15 mm
- 19314-16 80x16 mm
- 19314-20 60x20 mm
- 19330-40 40x12 mm
- 19330-55 55x11 mm

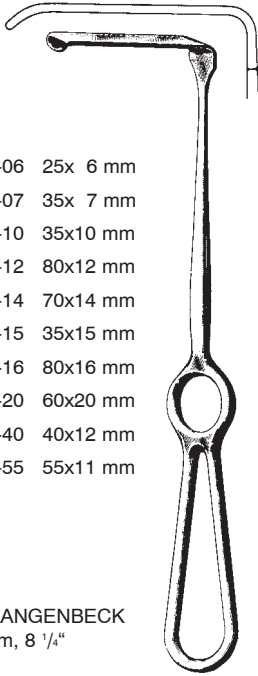

KOCHER-LANGENBECK
21 cm, 8 1/4"

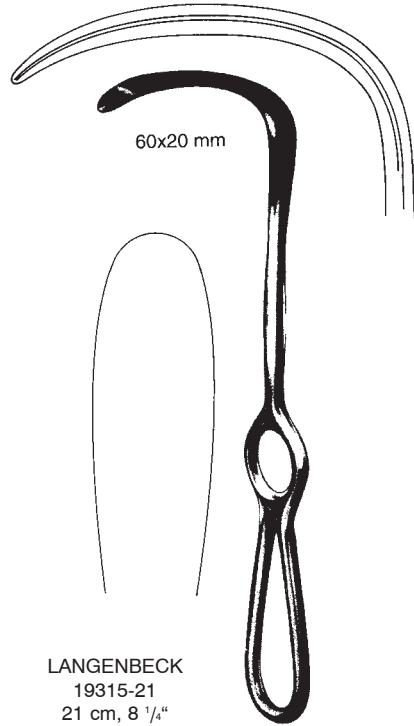

LANGENBECK
19315-21
21 cm, 8 1/4"



LANGENBECK
19317-21
21 cm, 8 1/4"

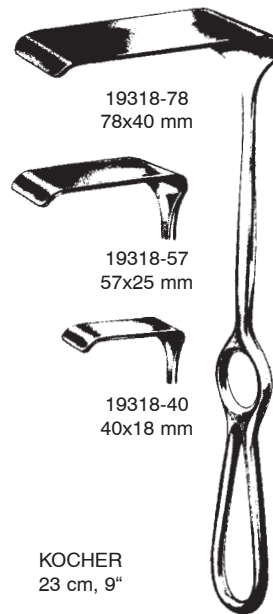

KOCHER
23 cm, 9"

Wundhaken
Retractors
Separadores
Divaricatori



19344-14
14x17 mm
21,5 cm, 8 1/2"



19344-20
20x22 mm
22 cm, 8 3/4"



19344-26
26x30 mm
23,5 cm, 9 1/4"



MIDDLEDORPF
19344-14 - 19344-26



KOCHER
19340-10 40x10 mm
19340-15 40x15 mm
19340-20 40x20 mm
22 cm, 8 3/4"

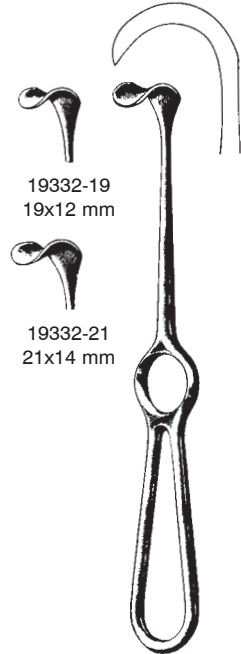

19332-19
19x12 mm

19332-21
21x14 mm

KOCHER
19332-19 - 19332-21
19 cm, 7 1/2"



MIDDLEDORPF
19345-01 45x45 mm
25,5 cm, 10"



19345-02
45x50 mm



19345-03
55x70 mm



GREEN
19348-22
22 cm, 8 3/4"

Wundhaken
Retractors
Separadores
Divaricatori

35 x 8 mm



ZENKER
19350-35
25 cm, 10"

60 x 12 mm



ZENKER
19350-60
26 cm, 10 1/4"

75 x 12 mm



ZENKER
19350-70
27,5 cm, 10.8"

Wundhaken
Retractors
Separadores
Divaricatori



ISRAEL
19364-40 40X40 mm
25 cm, 10"

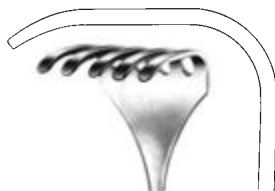

19364-50 45x50 mm



19364-60 50x60 mm

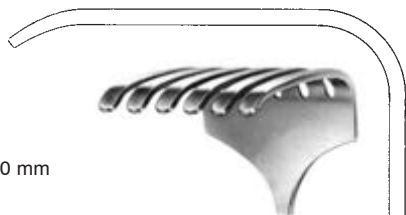

19364-70 70x70 mm



35x55 mm

OLLIER
19360-04 22,5 cm, 8.9"

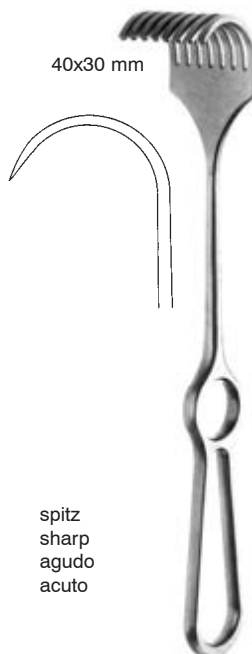

40x30 mm

spitz
sharp
agudo
acuto

stumpf
blunt
romo
smusso

KOERTE
19366-08 23,5 cm, 9 1/4" 19367-08

Wundhaken
Retractors
Separadores
Divaricatori

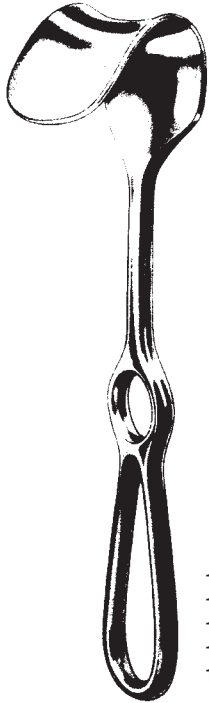

FRITSCH
19370-40 45x40 mm
19370-50 45x50 mm
19370-60 45x60 mm
19370-75 45x75 mm
19370-85 65x85 mm
24 cm, 9 1/2"



KOCHER
19372-22
70x25 mm
22,5 cm, 8.9"

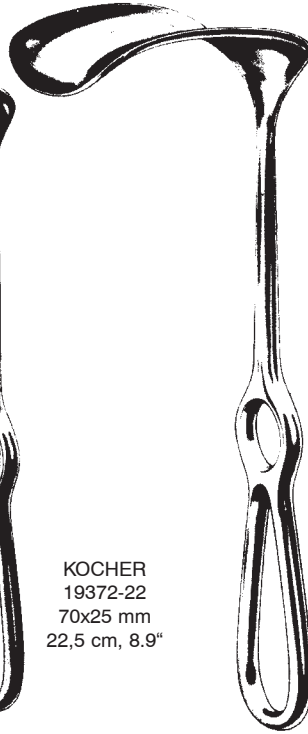

KOCHER
19374-45 80x45 mm
19374-55 80x55 mm
19374-65 80x65 mm
25 cm, 10"

50x85 mm



DOYEN
19378-25
25 cm, 10"

19382-50 90x50 mm

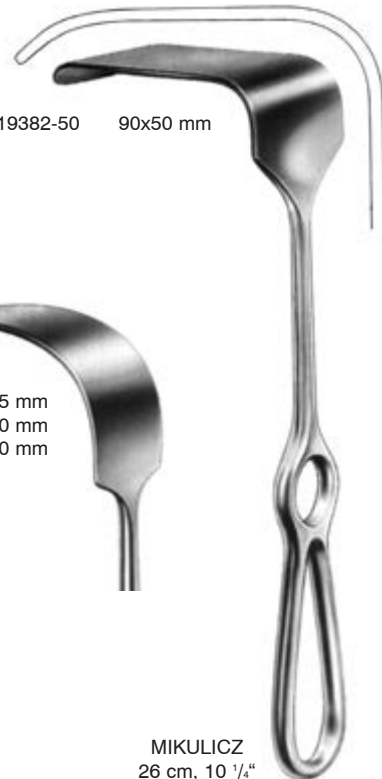

MIKULICZ
26 cm, 10 1/4"

19380-35 95x35 mm
19380-50 120x50 mm
19381-50 150x50 mm

Wundhaken
Retractors
Separadores
Divaricatori



19388-40 70x40 mm
19388-50 70x50 mm
19388-65 70x65 mm



MORRIS
24,5 cm
9 3/4"

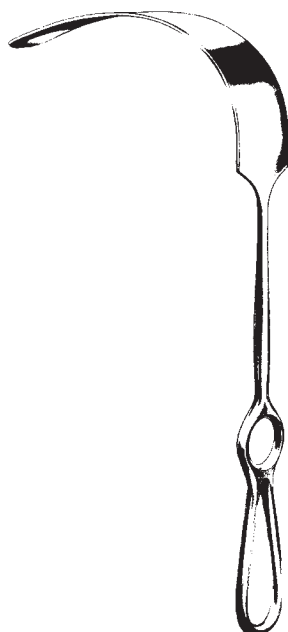

KELLY
19385-38 160x38 mm
19385-57 160x57 mm
27 cm, 10 1/2"



SIMON
19480-22 115x22 mm
19480-27 115x27 mm
28 cm, 11"

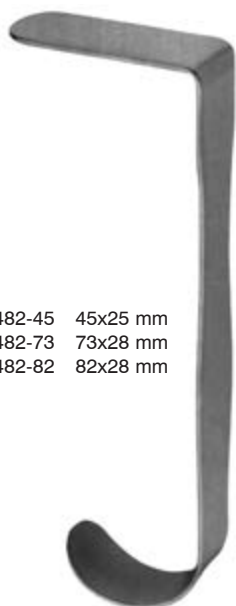

19482-45 45x25 mm
19482-73 73x28 mm
19482-82 82x28 mm

HEANEY
27 cm, 10 1/2"

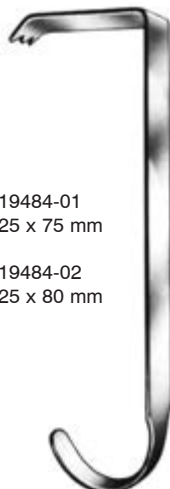

19484-01
25 x 75 mm
19484-02
25 x 80 mm

HIBBS
24 cm, 9 1/2"



125x37 mm

SAUERBRUCH
19492-25
25 cm, 10"

Pelvis-Haken
Pelvis retractor
Retractor de pelvis
Divaricatori pelvici

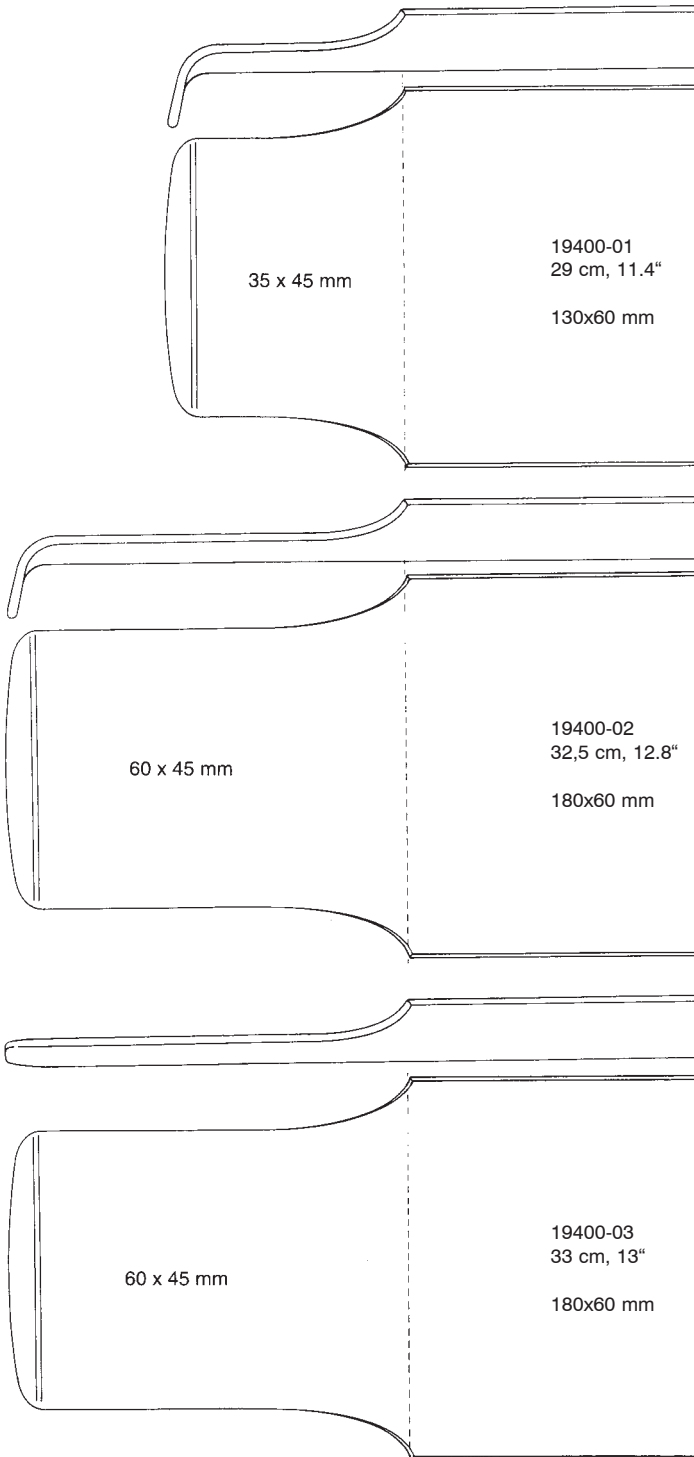

ST. MARKS
19400-01 19400-03

Wundhaken, Scapulahaken
 Retractors, Scapula Retractors
 Separadores, Separadores para escápula
 Divaricatori, Divaricatori per scapola



19490-65 115x65 mm
 19490-43 108x43 mm
 19490-22 82x22 mm

CORYLLOS (Thorax)
 24 cm, 9 1/2"



19494-45 45x15 mm
 19494-60 60x23 mm
 19494-75 75x20 mm

SAUERBRUCH
 22,5 cm, 8.9"



DAVIDSON
 19496-50 75x50 mm



DAVIDSON
 19496-90 75x90 mm

Wundhaken
Retractors
Separadores
Divaricatori

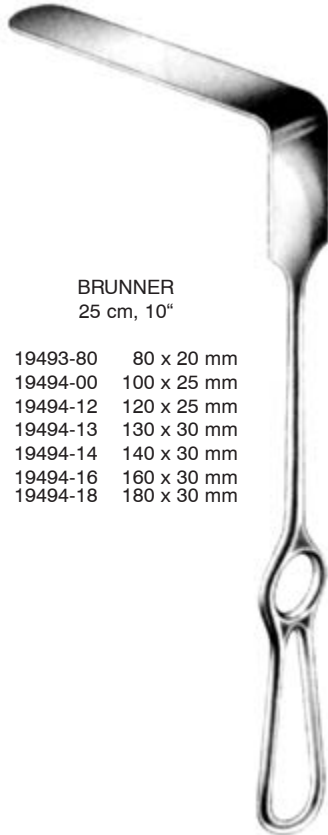

BRUNNER
25 cm, 10"

19493-80	80 x 20 mm
19494-00	100 x 25 mm
19494-12	120 x 25 mm
19494-13	130 x 30 mm
19494-14	140 x 30 mm
19494-16	160 x 30 mm
19494-18	180 x 30 mm

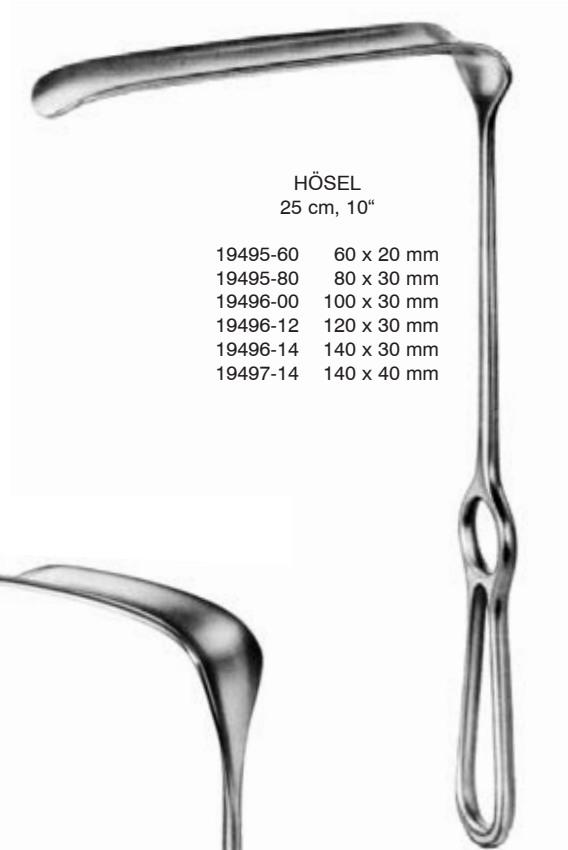

HÖSEL
25 cm, 10"

19495-60	60 x 20 mm
19495-80	80 x 30 mm
19496-00	100 x 30 mm
19496-12	120 x 30 mm
19496-14	140 x 30 mm
19497-14	140 x 40 mm



DOYEN-STILLE
25 cm, 10"

19498-01	97 x 29 mm
19498-02	101 x 31 mm
19498-03	127 x 52 mm

Wundsperrer, Kieferhöhlensperrer
 Retractors, Antrum Retractor
 Separadores, Separadores para seno maxilar
 Divaricatori, Divaricatori per seno mascellare

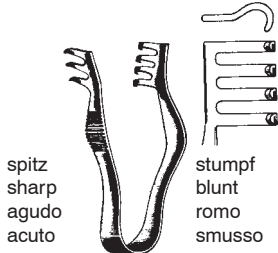

spitz
sharp
agudo
acuto

stumpf
blunt
romo
smusso

FINSEN
 19610-07 7 cm, 2 3/4" 19611-07

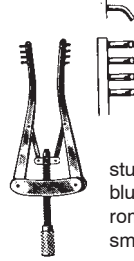

spitz
sharp
agudo
acuto

stumpf
blunt
romo
smusso

ALM
 19620-07 7 cm, 2 3/4" 19621-07
 19620-10 10 cm, 4" 19621-10



spitz
sharp
agudo
acuto

JANSSEN
 19630-10
 10 cm, 4"



stumpf
blunt
romo
smusso

JANSSEN
 19631-10
 10 cm, 4"



spitz
sharp
agudo
acuto

stumpf
blunt
romo
smusso

HOLZHEIMER
 19634-10 19635-10
 10 cm, 4"



PERKINS
 19636-14
 13 cm, 5 1/8"



PERKINS
 19637-14
 13 cm, 5 1/8"

Wundsperrer
Retractors
Separadores
Divaricatori

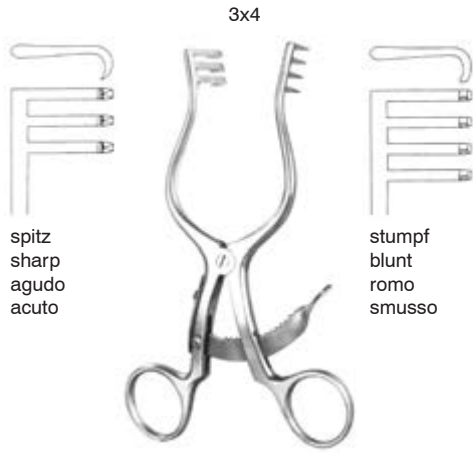

spitz
sharp
agudo
acuto

stumpf
blunt
romo
smusso

SCALP-CONTOUR
19640-14 - 19641-14
13,5 cm, 5 1/4"

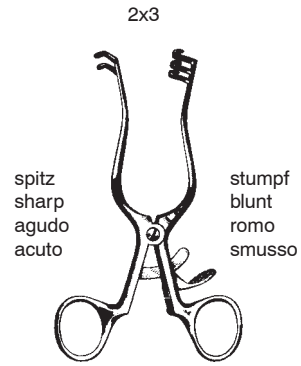

spitz
sharp
agudo
acuto

stumpf
blunt
romo
smusso

WEITLANER
19650-10 19651-10
11,5 cm, 4 1/2"

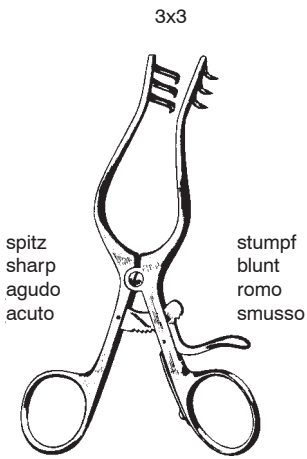

spitz
sharp
agudo
acuto

stumpf
blunt
romo
smusso

WEITLANER-WULLSTEIN
19654-13 19655-13
13 cm, 5 1/8"

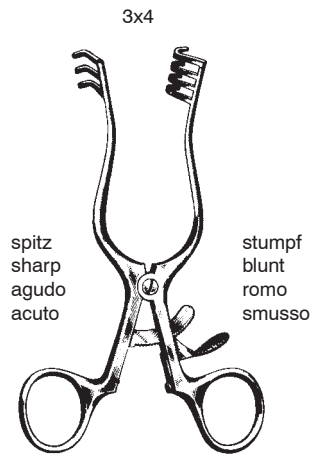

spitz
sharp
agudo
acuto

stumpf
blunt
romo
smusso

WEITLANER
19670-14 14,0 cm, 5 1/2" 19671-14
19670-16 16,5 cm, 6 1/2" 19671-16
19670-20 20,0 cm, 8" 19671-20
19670-24 24,0 cm, 9 1/2" 19671-24

Wundsperrer
Retractors
Separadores
Divaricatori

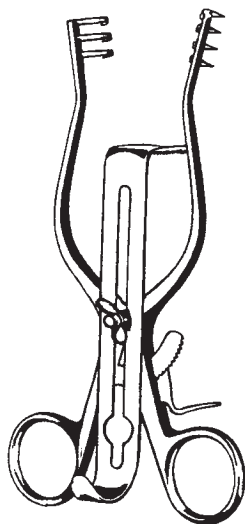

HENLEY
19675-00 - 19677-32
16,5 cm, 6 1/2"



19675-00 komplett, stumpf, 3x4 Z. und 3 Valven
19675-00 complete, blunt, 3x4 teeth and 3 blades
19675-00 completo, romo, 3x4 dientes y 3 valvas
19675-00 completo, smusso, 3x4 d. e 3 valve

19676-00 komplett, scharf, 3x4 Z. und 3 Valven
19676-00 complete, sharp, 3x4 teeth and 3 blades
19676-00 completo, agudo, 3x4 dientes y 3 valvas
19676-00 completo con retr. acuto 3x4 d. e 3 valve

19678-05 Retraktor allein, stumpf 3x4 Zähne
19678-05 Retractor only, blunt 3x4 teeth
19678-05 Separador solo, romo, 3x4 dientes
19678-05 Retrattore solo, smusso 3x4 denti

19678-06 Retraktor allein, spitz 3x4 Zähne
19678-06 Retractor only, sharp 3x4 teeth
19678-06 Separador solo, agudo, 3x4 dientes
19678-06 Retrattore solo, acuto 3x4 denti

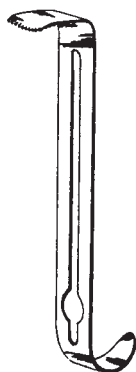

19677-19
16x19 mm
5/8" x 3/4"

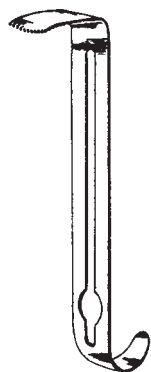

19677-25
16x25 mm
5/8" x 1"

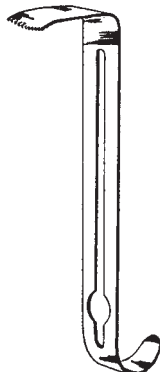

19677-32
16x32 mm
5/8" x 1 1/4"

Wundsperrer
Retractors
Separadores
Divaricatori



PLESTER
19672-11 11 cm, 4 $\frac{3}{8}$ "
stumpf - blunt - romo - smusso



PLESTER
19673-11 11 cm, 4 $\frac{3}{8}$ "
stumpf - blunt - romo - smusso



MOLLISON
19674-15 15 cm, 6"
scharf - sharp - agudo - acuto



WULLSTEIN
19675-13 13 cm, 5 $\frac{1}{8}$ "
stumpf - blunt - romo - smusso



PLESTER
19677-13 13 cm, 5 $\frac{1}{8}$ "
scharf - sharp - agudo - acuto



MAYO-ADAMS
19678-16 16,5 cm, 6 $\frac{1}{2}$ "
stumpf - blunt - romo - smusso

Wundsperrer
Retractors
Separadores
Divaricatori

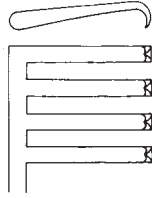
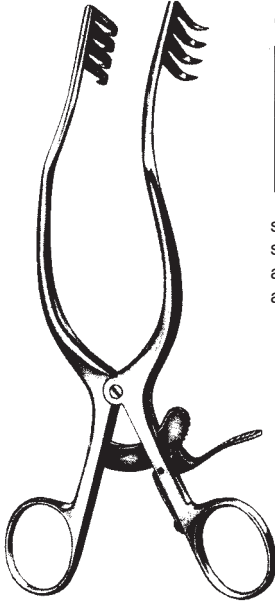

spitz
sharp
agudo
acuto

ANDERSON ADSON
19679-20 19,5 cm, 7 3/4"



stumpf
blunt
romo
smusso

NORFOLK / NORWICH
19679-22 22 cm, 8 3/4"



spitz
sharp
agudo
acuto

ADSON
19680-19 19 cm, 7 1/2" 19681-19

stumpf
blunt
romo
smusso



stumpf
blunt
romo
smusso

TRAVERS
19681-21 21,5 cm, 8 1/2"

Wundsperrer
Retractors
Separadores
Divaricatori



ADSON
19682-26 - 19683-26
26,5 cm, 10 1/2"

spitz
sharp
agudo
acuto

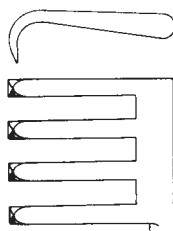

19682-26

stumpf
blunt
romo
smusso

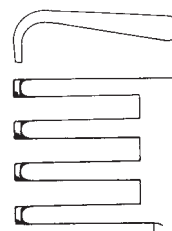

19683-26

- 19684-14 14 cm, 5 1/2"
- 19684-16 16 cm, 6 1/4"
- 19684-20 20 cm, 8"
- 19684-26 26 cm, 10 1/4"

spitz
sharp
agudo
acuto

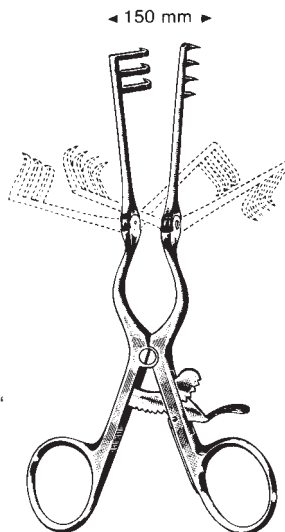

ADSON

- 19685-14 14 cm, 5 1/2"
- 19685-16 16 cm, 6 1/4"
- 19685-20 20 cm, 8"
- 19685-26 26 cm, 10 1/4"

stumpf
blunt
romo
smusso

Wundsperrer
Retractors
Separadores
Divaricatori

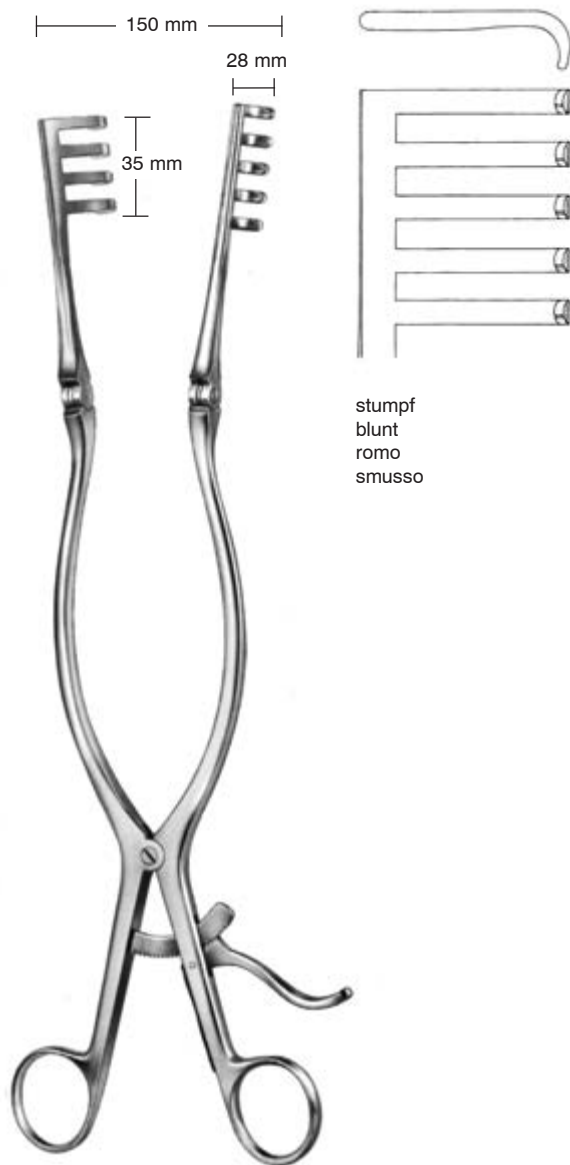

ADSON
19686-32
32 cm, 12 3/4"

Wundsperrer
Retractors
Separadores
Divaricatori



BECKMAN-ADSON
31 cm, 12 1/4"

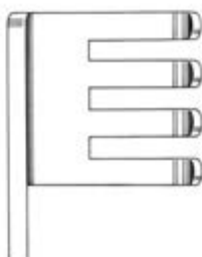

19687-01
25 x 31 mm

stumpf
blunt
romo
smusso

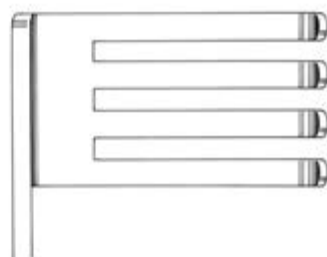

19688-01
45 x 27 mm

stumpf
blunt
romo
smusso

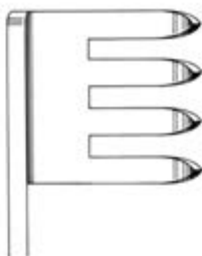

19687-02
25 x 31 mm

scharf
sharp
agudo
acuto

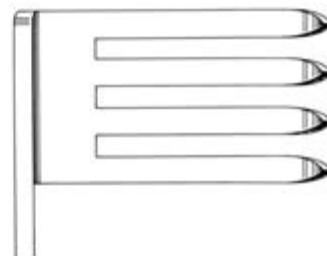

19688-02
45 x 27 mm

scharf
sharp
agudo
acuto

Wundsperrer
 Retractors
 Separadores
 Divaricatori



MARTIN
 28,5 cm, 11 1/4"

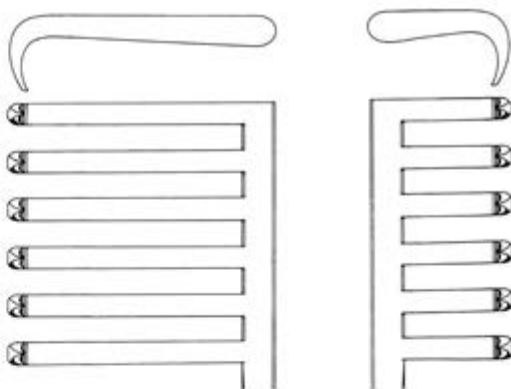

19689-01
 6x6 Zähne

scharf, lange Zähne links
 sharp, long teeth on left side
 agudo, dientes largos a la izquierda
 acuto, denti lunghe a sinistra

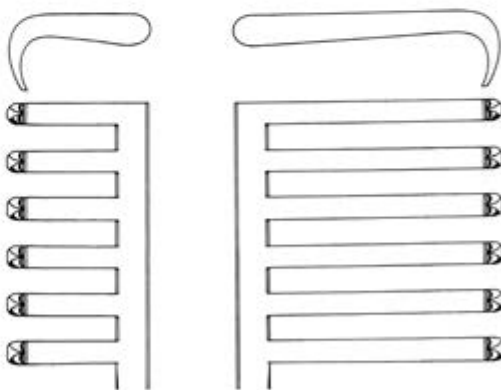

19689-02
 6x6 Zähne

scharf, lange Zähne rechts
 sharp, long teeth on right side
 agudo, dientes largos a la derecha
 acuto, denti lunghe a destra

Wundsperrer
Retractors
Separadores
Divaricatori

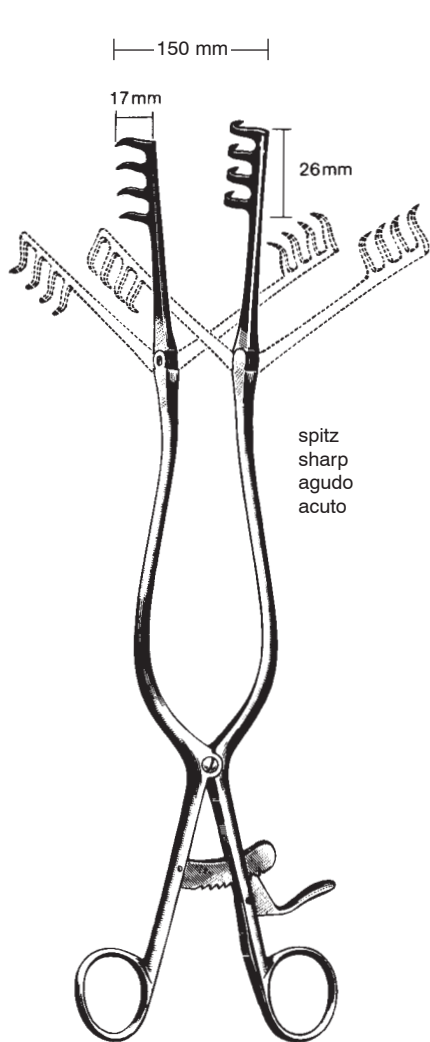

spitz
sharp
agudo
acuto

BECKMANN
19690-31
31 cm, 12 1/4"



spitz
sharp
agudo
acuto

BECKMANN-EATON
19692-32
32 cm, 12 3/4"

Wundhaken
Retractors
Separadores
Divaricatori



19694-01	20 cm, 8"	50 x 16 mm
19694-02	23 cm, 9"	75 x 25 mm
19694-03	24 cm, 9 1/2"	90 x 50 mm

MEYERDING

Hemilaminectomiespreizer
 Hemilaminectomy Retractor
 Separadores para hemilaminectomía
 Divaricatori per emilaminectomia

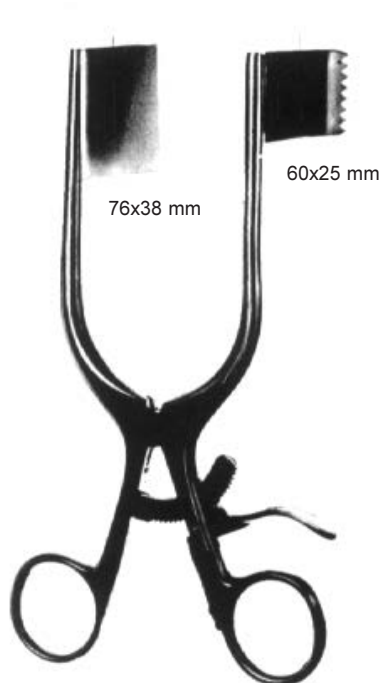

DARLING
 19696-18 18 cm, 7"

links
 left
 a la izquierda
 a sinistra

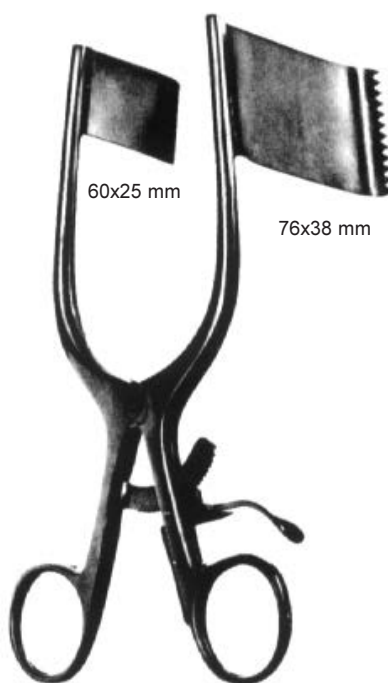

DARLING
 19698-18 18 cm, 7"

rechts
 right
 a la derecha
 a destra

Cervicalspreizer
 Cervical Retractor
 Separador cervical
 Divaricatore cervicale



CLOWARD
 25 cm, 10"

spitz
 sharp
 agudo
 acuto



19710-40	40 x 15 / 23 mm
19710-45	45 x 15 / 23 mm
19710-50	50 x 15 / 23 mm
19710-55	55 x 15 / 23 mm
19710-60	60 x 15 / 23 mm

19710-01
 Sperrer, alleine
 Retractor, only
 Retractor, suelto
 Divaricatore solo

19710-00
 Sperrer komplett mit 5 Valven spitz
 Retractor complete with 5 blades sharp
 Separador completo con 5 valvas agudas
 Divaricatore completo con 5 valve acute

Cervicalspreizer
 Cervical Retractor
 Separador cervical
 Divaricatore cervicale



CLOWARD
 25 cm, 10"

stumpf
 blunt
 romo
 smusso



19711-40	40 x 15 / 23 mm
19711-45	45 x 15 / 23 mm
19711-50	50 x 15 / 23 mm
19711-55	55 x 15 / 23 mm
19711-60	60 x 15 / 23 mm

19710-01
 Sperrer, alleine
 Retractor, only
 Retractor, suelto
 Divaricatore solo

19712-00
 Sperrer komplett mit 5 Valven stumpf
 Retractor complete with 5 blades blunt
 Separador completo con 5 valvas romas
 Divaricatore completo con 5 valve smusse

Cervicalspreizer
 Cervical Retractor
 Separador cervical
 Divaricatore cervicale

spitz
 sharp
 agudo
 acuto



- 19710-40 40 x 15 / 23 mm
- 19710-45 45 x 15 / 23 mm
- 19710-50 50 x 15 / 23 mm
- 19710-55 55 x 15 / 23 mm
- 19710-60 60 x 15 / 23 mm



CLOWARD
 16 cm, 6 1/4"

- 19711-01
 Sperrer, alleine
 Retractor, only
 Retractor, suelto
 Divaricatore solo

- 19711-00
 Sperrer komplett mit 5 Valven spitz
 Retractor complete with 5 blades sharp
 Separador completo con 5 valvas agudas
 Divaricatore completo con 5 valve acute

Cervicalspreizer
Cervical Retractor
Separador cervical
Divaricatore cervicale



CLOWARD
16 cm, 6 1/4"

stumpf
blunt
romo
smusso



19711-40	40 x 15 / 23 mm
19711-45	45 x 15 / 23 mm
19711-50	50 x 15 / 23 mm
19711-55	55 x 15 / 23 mm
19711-60	60 x 15 / 23 mm

19711-01
Sperrer, alleine
Retractor, only
Retractor, suelto
Divaricatore solo

19713-00
Sperrer komplett mit 5 Valven stumpf
Retractor complete with 5 blades blunt
Separador completo con 5 valvas romas
Divaricatore completo con 5 valve smusse

Cervicalspreizer
 Cervical Retractor
 Separador cervical
 Divaricatore cervicale

90 mm, 3 1/2"



CASPAR
 19721-15
 165 mm, 5 1/2"

Sperrer, alleine
 Retractor, only
 Retractor, suelto
 Divaricatore solo



19726-01

Blätter-Wechselpinzette
 Blade ejector
 Pinza para cambiar hojas
 Pinze per cambiare valve

19721-00
 Sperrer komplett mit 5 Valven stumpf
 Retractor complete with 5 blades blunt
 Separador completo con 5 valvas romas
 Divaricatore completo con 5 valve smusse

- 19738-45 45 x 23 mm
- 19738-50 50 x 23 mm
- 19738-55 55 x 23 mm
- 19738-60 60 x 23 mm
- 19738-65 65 x 23 mm



Lumbal-Wundspreizer
Lumbal Retractors
Separadores lumbales autoestáticos
Divaricatori autostatici lombari



19745-40
40 mm, 1 1/2"



19745-45
45 mm, 1 3/4"



19745-60
60 mm, 2 1/4"



19745-50
50 mm, 2"



19745-65
65 mm, 2 1/2"



19745-55
55 mm, 2 1/8"



19745-70
70 mm, 2 3/4"

CASPAR
19744-00
komplett mit 7 Blätter
compl. incl. 7 blades
completo con 7 valvas
complete di 7 valve

19744-17
ohne Blätter
without blades
sin valvas
senza valve

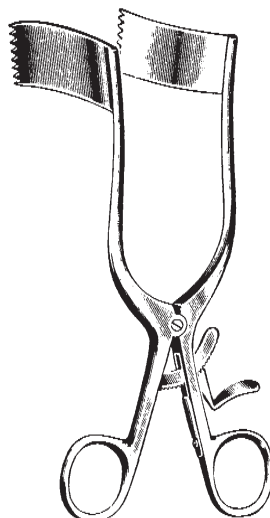

MEYERDING
17 cm, 6 3/4"

19748-01 2,5 x 3,2 cm
19748-02 2,5 x 5,4 cm
19748-03 1,9 x 6,0 cm
19748-04 2,5 x 6,0 cm

Bauchdeckenhalter
 Abdominal Retractors
 Separadores abdominales
 Divaricatori addominali

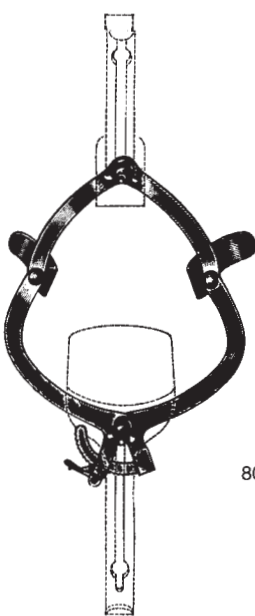

O'SULLIVAN - O'CONNOR
 19754-00
 compl.

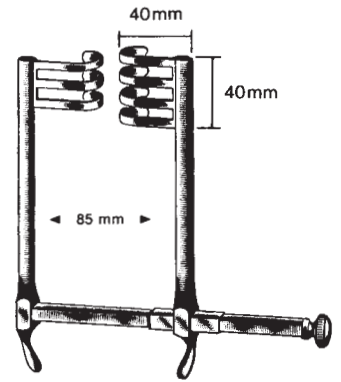
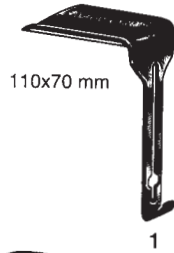

FRAZIER
 19758-85

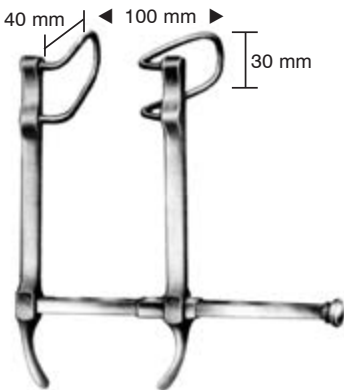

BABY GOSSET
 19759-00

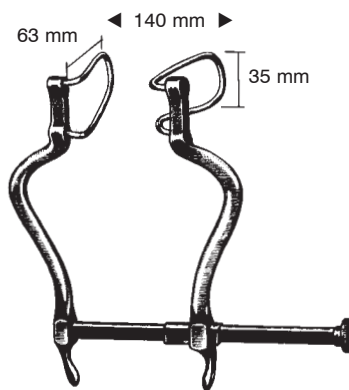

GOSSET
 19760-14

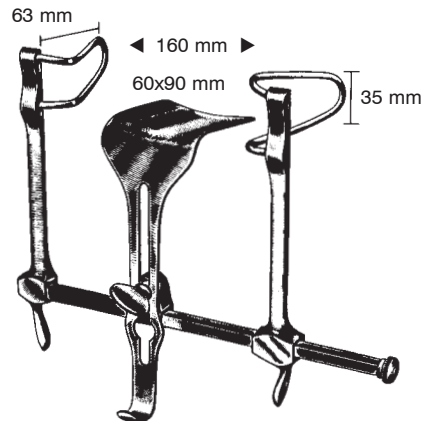

GOSSET
 19762-16

Bauchdeckenhalter
Abdominal Retractors
Separadores abdominales
Divaricatori addominali

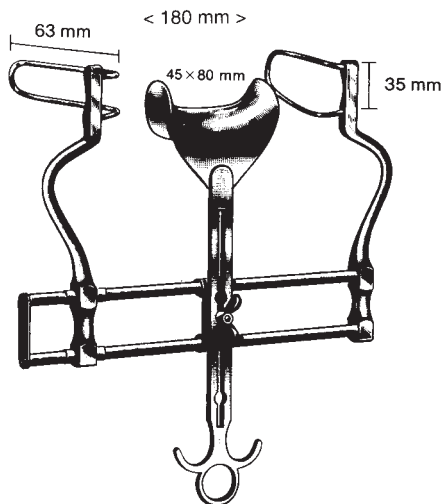

BALFOUR
19764-18
18 cm, 7"

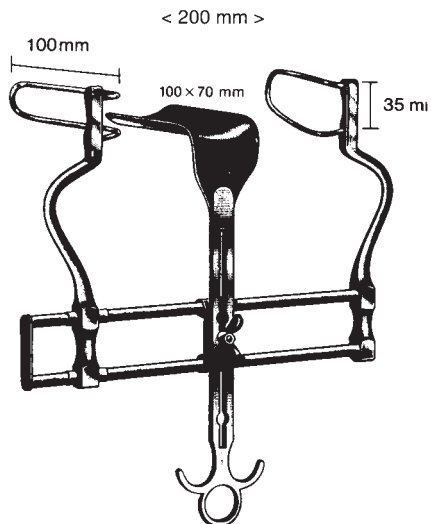

BALFOUR
19764-20
20 cm, 8"

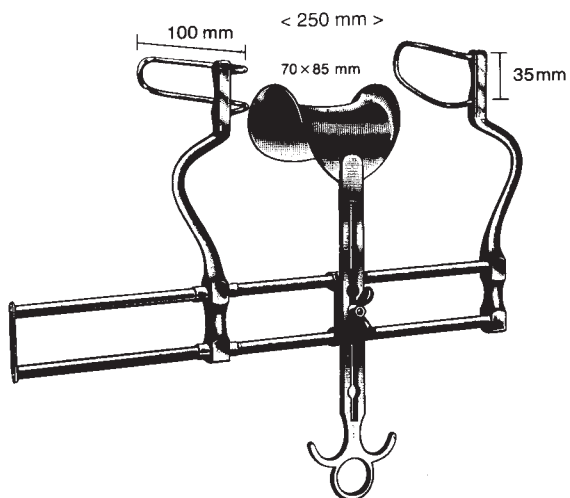

BALFOUR
19764-25
25 cm, 10"

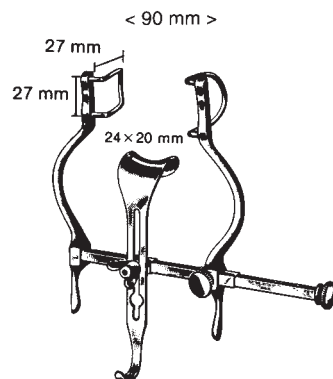

BALFOUR Baby
19766-90
9 cm, 3 1/2"

Bauchdeckenhalter
Abdominal Retractors
Separadores abdominales
Divaricatori addominali

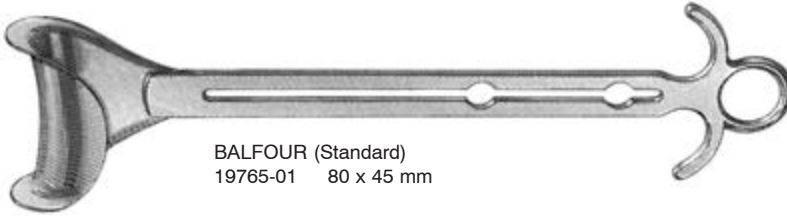

BALFOUR (Standard)
19765-01 80 x 45 mm

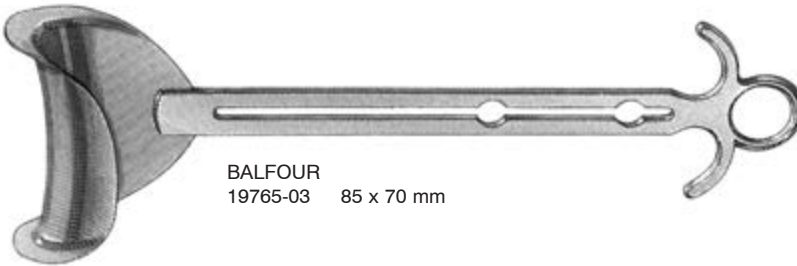

BALFOUR
19765-03 85 x 70 mm

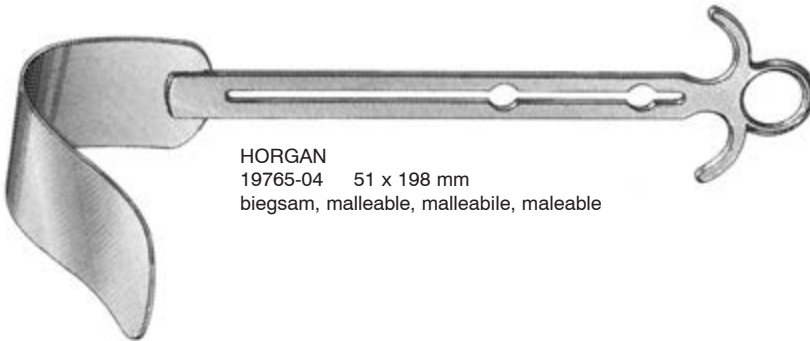

HORGAN
19765-04 51 x 198 mm
biegsam, malleable, malleabile, maleable

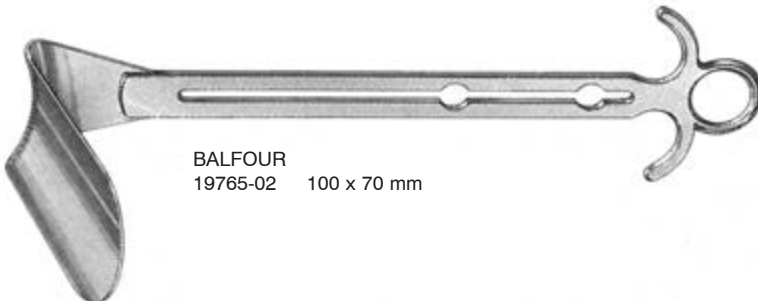

BALFOUR
19765-02 100 x 70 mm

Bauchdeckenhalter
Abdominal Retractors
Separadores abdominales
Divaricatori addominali



19767-01
Drahtvalven 5 cm (1.96") tief (Paar)
Fenestrated blades 5 cm (1.96") deep (pair)
Valvas de alambre 5 cm (1.96") profundidad (par)
Valve di filo profondità 5 cm (1.96") (paio)

19767-02
Drahtvalven 7,5 cm (2,95") tief (Paar)
Fenestrated blades 7,5 cm (2,95") deep (pair)
Valvas de alambre 7,5 cm 2,95") profundidad (par)
Valve di filo profondità 7,5 cm (2,95") (paio)



BALFOUR-US
19767-18
19767-25
komplett
complete
completo

Bauchdeckenhalter
Abdominal Retractors
Separadores abdominales
Divaricatori addominali

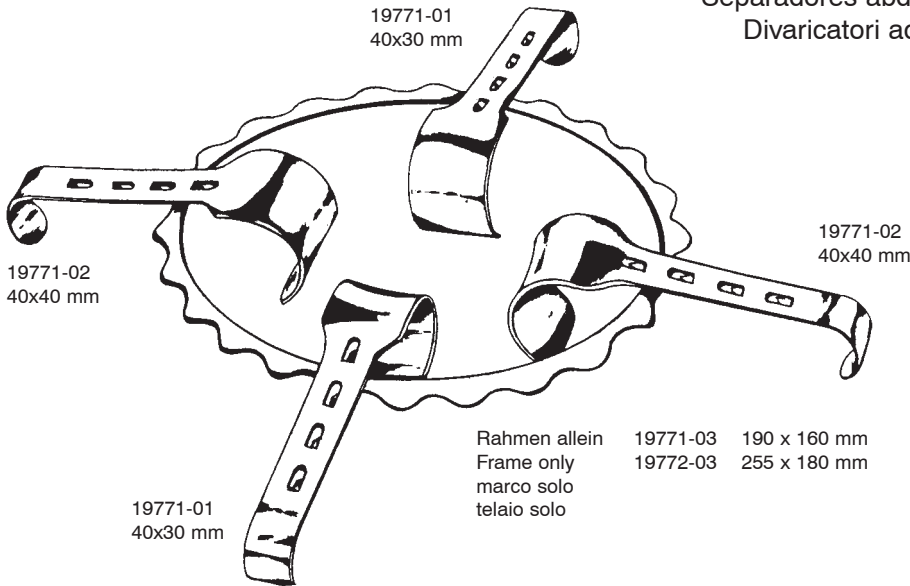

DENIS-BROWNE

19771-00 compl. Pediatric/pediatrico 190 x 160 mm
19772-00 compl. Adult/adulto 255 x 180 mm

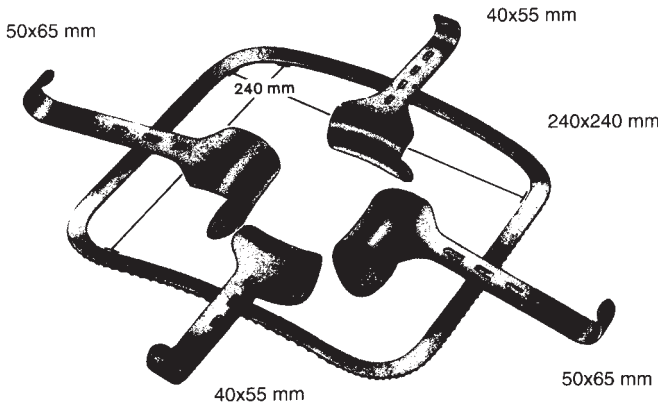

KIRSCHNER



19781-55
40 x 55 mm breit



19781-65
50 x 65 mm breit

19782-00 Kirschner Bauchdeckenhalter komplett bestehend aus:
Kirschner Abdominal Retr. complete consisting of:
Kirschner separador abdominal completo compuesto de:
Kirschner Divaricatore addominale completo, composto da:

19781-55 2 Rahmenhaken / 2 Hook-on Retr. / 2 separadores / 2 divaricatori 40 x 55 mm

19781-65 2 Rahmenhaken / 2 Hook-on Retr. / 2 separadores / 2 divaricatori 50 x 65 mm

19783-24 Rahmen fest / frame rigid / marco rigido / telaio rigido 240 x 240 mm

Bauchdeckenhalter
 Abdominal Retractors
 Separadores abdominales
 Divaricatori addominali



19780-01 + 19770-01

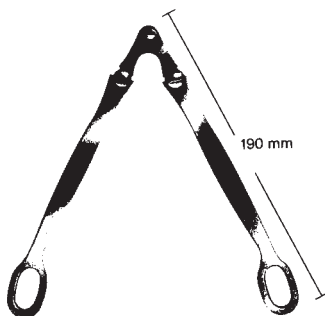

ROCHARD
 19780-01

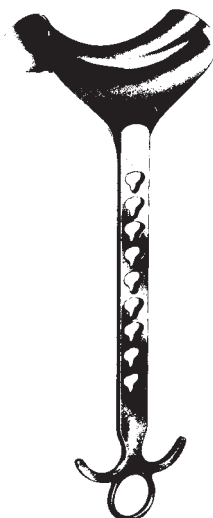

ROCHARD
 31 cm, 12 1/4"
 19770-01 48x90 mm
 19770-02 48x105 mm
 19770-03 48x120 mm
 19770-04 48x135 mm
 19770-05 48x155 mm

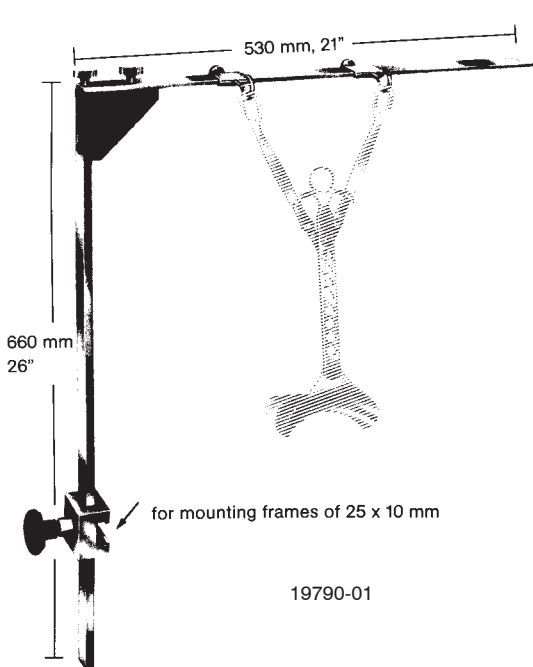

19790-01

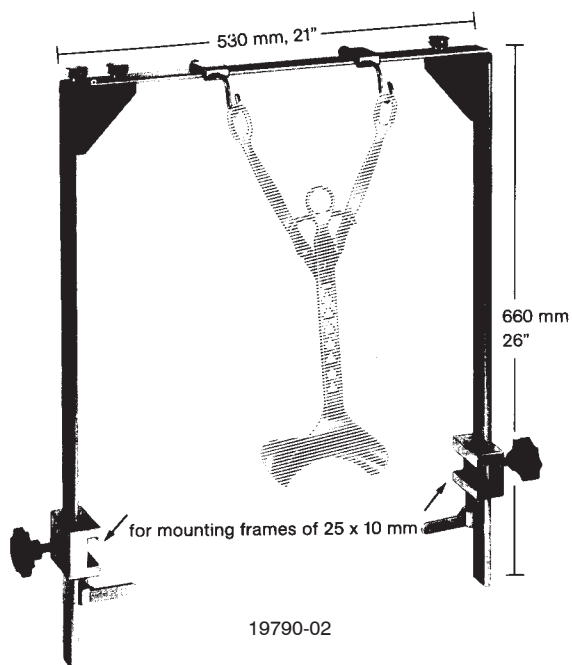

19790-02

Bauchdeckenhalter
Abdominal Retractors
Separadores abdominales
Divaricatori addominali

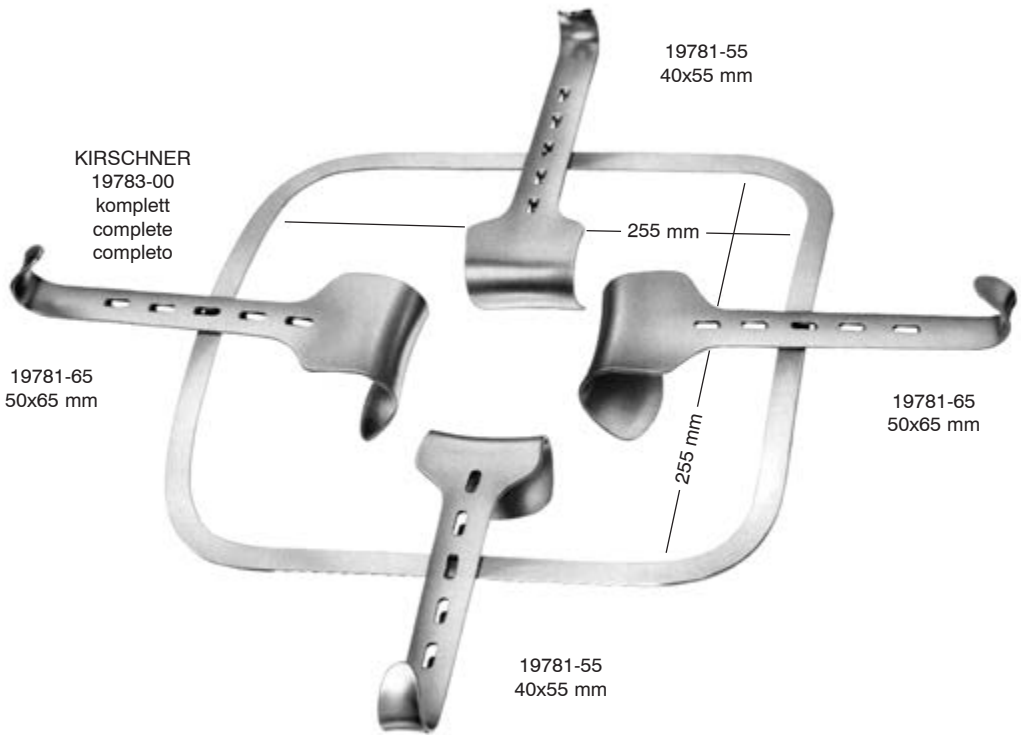

19783-01 250x250 mm
zusammenlegbarer Rahmen
folding frame
marco
telaio

Bauchdeckenhalter
 Abdominal Retractors
 Separadores abdominales
 Divaricatori addominali

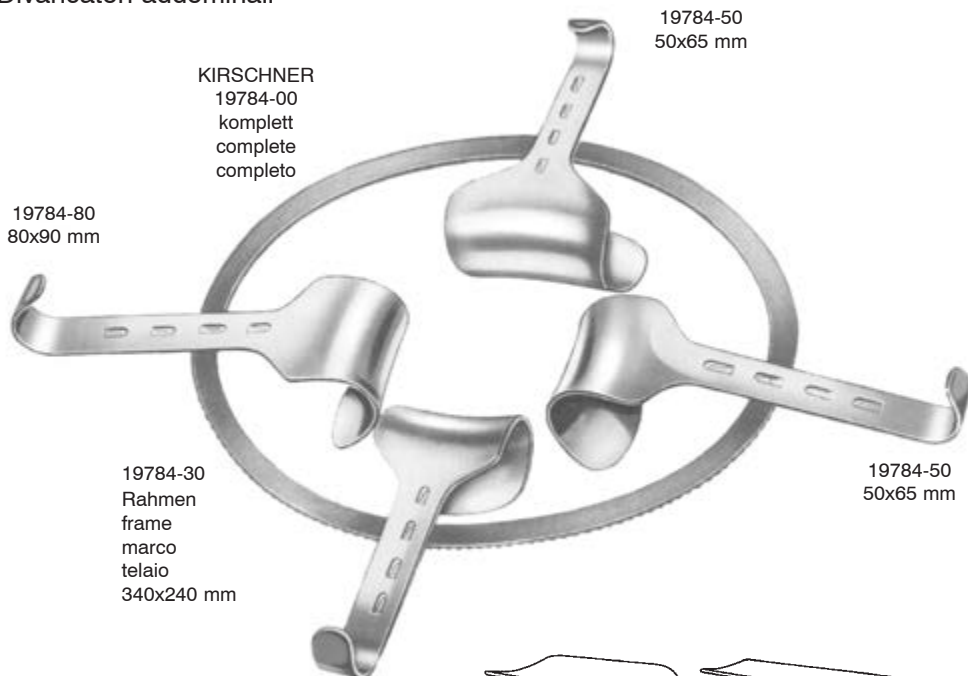

KIRSCHNER
 19784-00
 komplett
 complete
 completo

19784-50
 50x65 mm

19784-80
 80x90 mm

19784-30
 Rahmen
 frame
 marco
 telaio
 340x240 mm

19784-50
 50x65 mm

19784-50
 50x65 mm

für Darm und Blase
 for intestine and bladder
 para intestino y vejiga
 per intestino e vescica

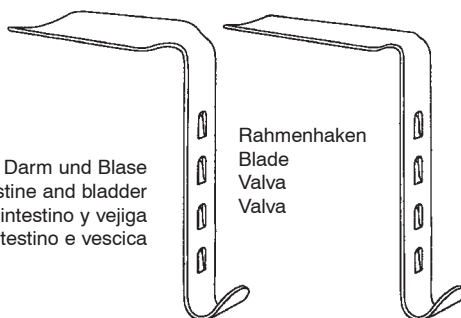

Rahmenhaken
 Blade
 Valva
 Valva

19784-98
 98x50 mm

19784-99
 105x35 mm

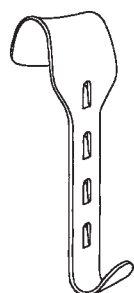

19784-40
 40x55 mm

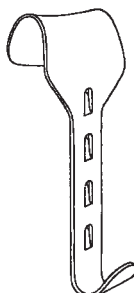

19784-50
 50x65 mm

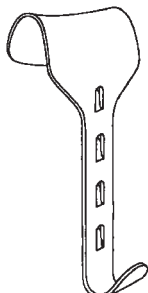

19784-60
 60x85 mm

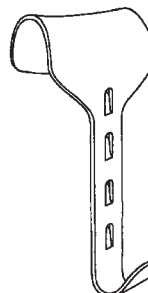

19784-78
 78x65 mm

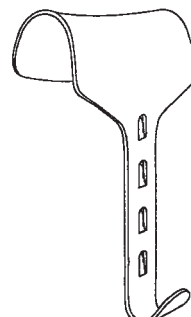

19784-80
 80x90 mm

Arm System
 Arm System
 Sistema de brazo
 Sistema braccio



19795-01

Armsystem Radius 310/420 mm komplett mit Wundhakenhalter und U-Stativ Ø 16 mm, 400 mm hoch, 400 mm breit, 170 mm tief (ohne Klemmsockel).

Arm System, radius 310/420 mm, including retractor and U-stand Ø 16 mm, 400 mm high, 400 mm wide, 170 mm deep (without clamp socket).



19795-02

Armsystem Radius 310/420 mm komplett mit Stativ, Klemmsockel und Endoskophalter Ø 8/10 mm.

Arm System, radius 310/420 mm, including stand, clamp, endoscope holder Ø 8/10 mm.



19798-01

Zweischlauchhalterung aus Aluminium
 Double tube holder made of aluminium



19798-02

Endoskophalterung Universal
 Endoscope holder Universal
 Ø 3-10 mm



19798-03

Universelle
 Wundhakenhalterung
 Universal retractor holder

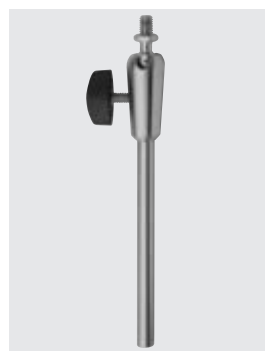

19798-04

Gelenkverlängerung
 180 mm lang mit Feststellung
 Extended articulation
 180 mm long, lockable

Arm System
 Arm System
 Sistema de brazo
 Sistema braccio



19799-03
 Leichtmetall-Klemmsockel Spannweite 35 mm, für ein Schraubstativ mit \varnothing 16 mm/M10, für Schienen 25/35 x 8/10 und Rohre \varnothing 12 - 35 mm.
 Clamp socket made of light metal, holding width 35 mm, for screw stand \varnothing 16 mm/M10, for rails 25/35 x 8/10 and tubes \varnothing 12 - 35 mm.



19799-04
 Leichtmetall-Klemmsockel Spannweite 50 mm, für ein höhenverstellbares Stativ \varnothing 16 mm, für Schienen 25/35 x 8/10 und Rohre \varnothing 12 - 35 mm.
 Clamp socket made of light metal, holding width 50 mm, for height-adjustable stand \varnothing 16 mm, for rails 25/35 x 8/10 and tubes \varnothing 12 - 35 mm.



19799-05
 Klemmsockel aus rostfreiem Stahl, für ein höhenverstellbares Stativ \varnothing 16 mm, elektrisch isoliert bis 4,5 kV AC, Spannweite 50 mm für Schienen 25/32 x 8/12 mm.
 Clamp socket made of stainless steel, for height-adjustable stand \varnothing 16 mm, electrically insulated up to 4.5 kV AC, holding width of 50 mm for rails 25/32 x 8/12 mm.



19799-06
 Leichtmetall-Klemmsockel Spannweite 50 mm, für ein Schraubstativ mit \varnothing 16 mm/M10, für Schienen 25/35 x 8/10 und Rohre \varnothing 12 - 35 mm.
 Clamp socket made of light metal, holding width 50 mm, for screw stand \varnothing 16 mm/M10, for rails 25/35 x 8/10 and tubes \varnothing 12 - 35 mm.

Bauchdeckenhalter, Wundsperrer
 Abdominal Retractors, Retractors
 Separadores abdominales, Separadores
 Divaricatori addominali, Divaricatori



DOYEN

28 cm, 11"

19800-01	48x 90 mm
19800-02	48x105 mm
19800-03	48x120 mm
19800-04	48x135 mm

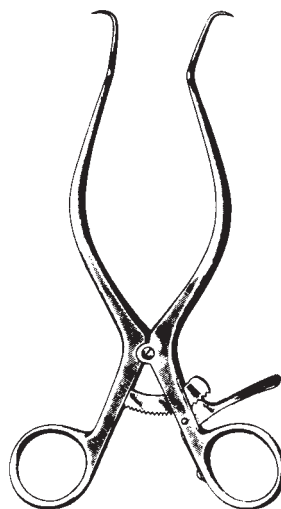

GELPI

19802-09	9 cm, 3 1/2"
19802-11	11 cm, 4 3/8"
19802-14	14 cm, 5 1/2"
19802-16	16 cm, 6 1/4"
19802-18	18 cm, 7"



DE BAKEY

19803-14
14,5 cm, 5 3/4"

Wundsperrer
Retractors
Separadores
Divaricatori

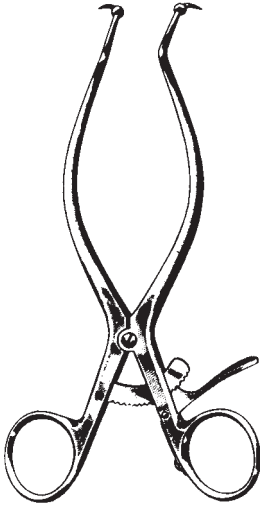

GELPI
19804-18
18 cm, 7"



JACKSON BURROWS
19805-18
18,5 cm, 7 1/4"

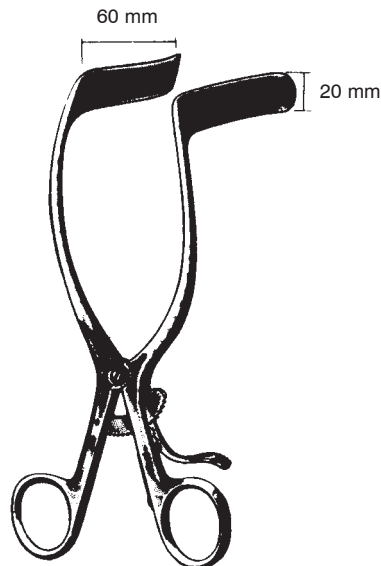

RIGBY
19806-18
18 cm, 7"

Bauchdeckenhalter
Abdominal Retractors
Separadores abdominales
Divaricatori addominali



COLLIN
19810-22
komplett
complete
completo

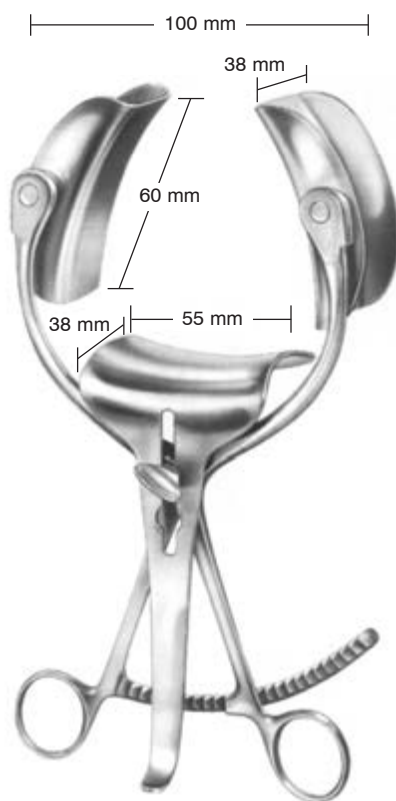

COLLIN
19812-60
komplett
complete
completo

Bauchdeckenhalter
 Abdominal Retractors
 Separadores abdominales
 Divaricatori addominali

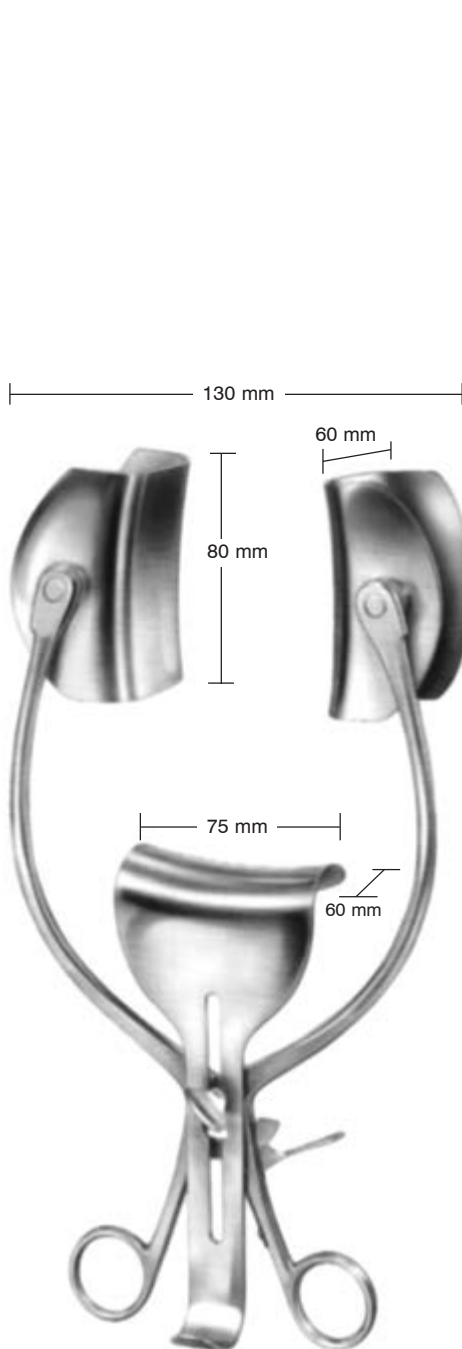

COLLIN Loktite
 19816-00 31 cm, 12 1/4"
 komplett / complete / completo

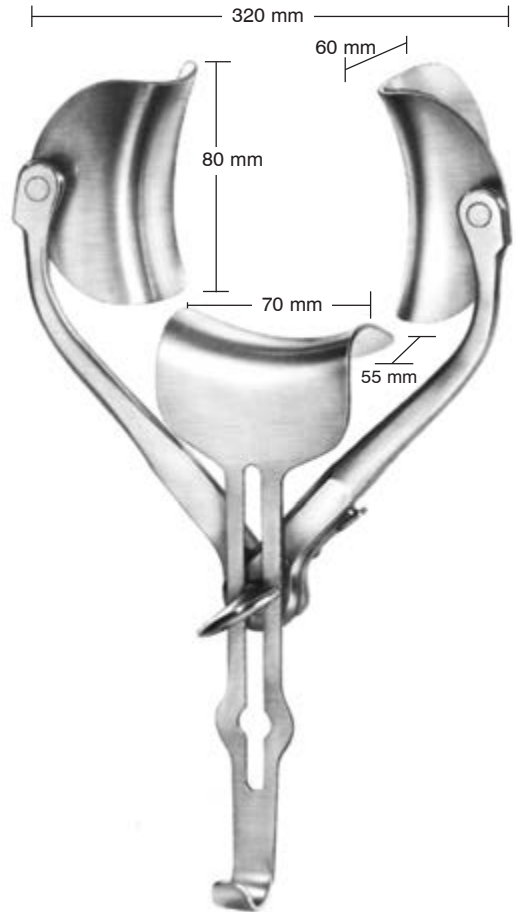

RICARD
 19813-00 30 cm, 11 3/4"
 komplett / complete / completo

Back holder Abdominal Retractor
Operation Table Set

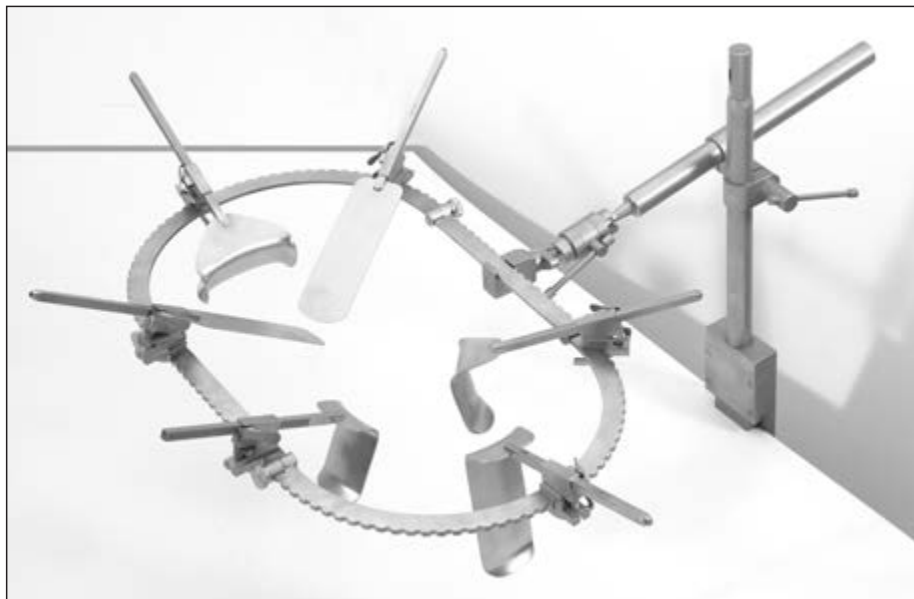

Complete Fixed Abdominal Retractor Set
Set completo divaricatore addominale con sistema di montaggio modulare

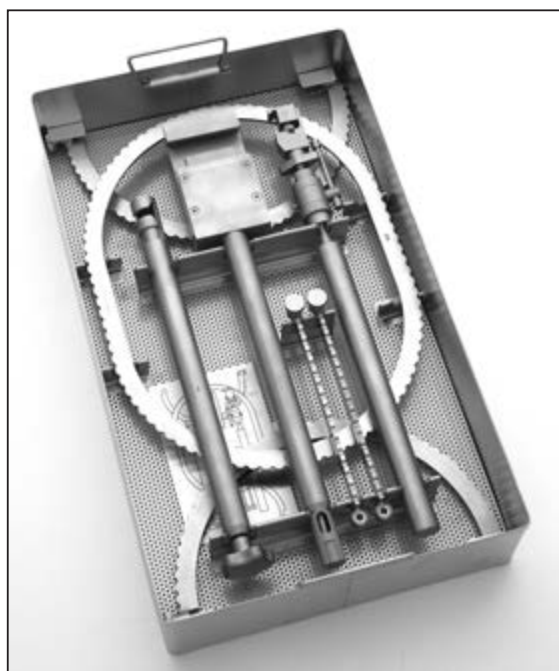

The many components of the **Back holder Abdominal Retractor Operation Table Set**

can all be neatly arranged into autoclave sized containers with diagrams that direct instrument handlers on proper placement of each component.

*A major convenience in care and maintenance
of the Retractor Set*

Sterilization Container & Baskets

Description	Product No
Table Fixation & Ring Case	19820-90
Blade & Accessories Case	19820-91

**Back holder Abdominal Retractor
Operation Table Set**

Description	Product No	Composto da	
Complete Abdominal Retractor Set	19820-99	Accoppiatore	19821-01
		Barra orizzontale	19821-02
<i>Includes</i>		Morsetto di accoppiamento	19821-04
Table Post	19821-01	Anello ovale	19820-02
Horizontal Bar	19821-02	No. 2 retrattori malleabili, 51x152 mm	19825-06
1" Post Coupling	19821-04	No. 2 Valve Kelly, dim. 51x76 mm	19822-23
Oval Ring	19820-02	Valva Kelly	19822-24
2" X 6" Malleable Retractor (2 ea)	19825-06	Valva Balfour	19823-33
2" X 3" Kelly Retractor (2 ea)	19822-23	Morsetto trasportabile con trasporto ad intervallo progressivo di 2 mm	19820-10
2" X 4" Kelly Retractor	19822-24	Morsetto articolato multidisciplinare con funzione movimento assiale orizzontale e verticale	19820-20
Balfour Retractor	19833-33	Anello ovale 266x367 mm	19820-02
Ratchet Mechanism (2 ea)	19820-10	Anello a segmento 266x495 mm	19820-03
Tilt Ratchet Mechanism (6 ea)	19820-20	Retrattore malleabile 38x152 mm	19824-06
Segmented Ring	19820-03	Retrattore malleabile 76x152 mm	19826-06
1 1/2" X 6" Malleable Retractor	19824-06	Valva Kelly, 51x127 mm	19822-25
3" x 6" Malleable Retractor	19826-06	Valva Kelly, 51x152 mm	19822-26
2" X 5" Kelly Retractor	19822-25	Barra flessibile orizzontale	19821-03
2" X 6" Kelly Retractor	19822-26	Retrattore Harrington 63x143 mm	19831-25
Horizontal Flex Bar	19821-03	Retrattore con punta Gelpi	19834-01
Harrington Retractor	19831-25		
Gelpi Retractor	19834-01		
<i>Accessories</i>		<i>Accessori:</i>	
Table Fixation & Ring Case	19820-90	Container vuoto in acciaio inox dotato con griglia interna	
Blades & Accessories Case	19820-91	Descrizione	
		Container in acciaio inox dotato di griglia interna per Accessori di fissazione, anelli e barre	19820-90
		Container in acciaio inox dotato di griglia interna per morsetti e divaricatori	19820-91



Malleable Retractors with Protective Edge



Description	Product No
1 1/2" x 6" 38 x 152 mm	19824-06
2" x 6" 51 x 152 mm	19825-06
3" x 6" 76 x 152 mm	19826-06

Specialty Retractors

Description	Product No
Balfour Retractor 2 5/8" x 3" 67 x 76 mm	19833-33
Gelpi Point Retractor	19834-01



Harrington Retractors

Description	Product No
Blade 2.5" x 5 5/8" 63 x 143 mm	19831-25

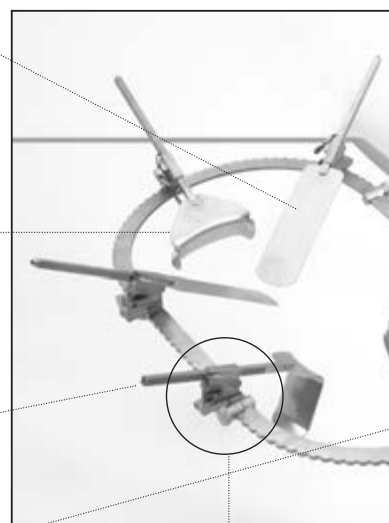

Description	Product No
Blade 2" x 1 1/2" 51 x 38 mm	19822-21
Blade 2" x 2" 51 x 51 mm	19822-22
Blade 2" x 2 1/2" 51 x 64 mm	19822-22L
Blade 2" x 3" 51 x 76 mm	19822-23
Blade 2" x 4" 51 x 102 mm	19822-24
Blade 2" x 5" 51 x 127 mm	19822-25
Blade 2" x 6" 51 x 152 mm	19822-26



Description	Product No
Blade 1" x 1 1/2" 25 x 38 mm	19822-01
Blade 1" x 2 1/2" 25 x 63 mm	19822-02

Tilt Ratchet Mechanism allows extensions or retractions along the horizontal axis and allows vertical movement of retractor blade with a second ratchet

Product No 19820-20

Table Mounting Components

Description	Product No
1" Post Coupler	19821-04

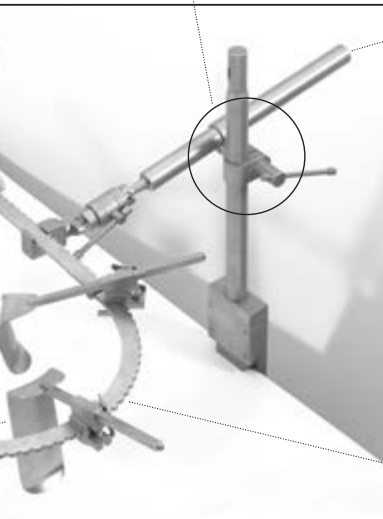

Fixed Ratchet Mechanism allows extension or retraction along the horizontal axis at 2mm intervals

Product No 19820-10

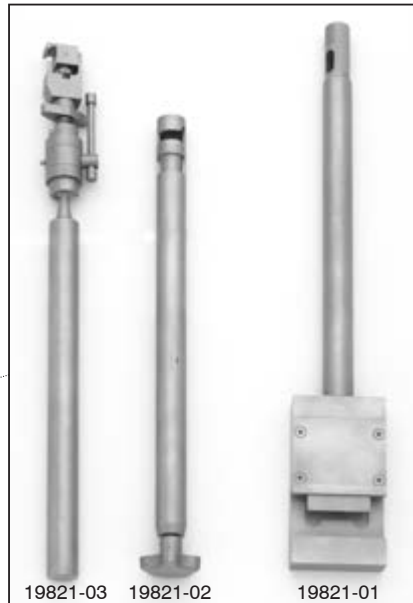

Table Mounting Components

Table Post	19821-01
Horizontal Bar	19821-02
Horizontal Flex Bar	19821-03



Retractor Rings

Description	Product No
Oval Ring 10.5 x 14.5 inch / 266 x 367 mm	19820-02
Segmented Ring 10.5 x 19.5 inch / 266 x 495 mm (Consists of one 10.5 inch Round Ring and two 8 inch straight segments)	19820-03

Laminektomiespreizer
Laminectomy Retractors
Separadores para laminectomia
Divaricatori per laminectomia



SCOVILLE-HAVERFIELD
19910-00
Rahmen allein
Frame only
Marco solo
Telaio solo



SCOVILLE
19911-00
Rahmen allein
Frame only
Marco solo
Telaio solo



SCOVILLE
50 mm, 2"
19912-50



SCOVILLE
70 mm, 2 ³/₄"
19912-70



SCOVILLE
19914-41 41 x 38 mm
19914-67 67 x 44 mm



TAYLOR
19915-48 48 x 50 mm
19915-64 64 x 50 mm
19916-64 64 x 64 mm
19916-80 80 x 57 mm



SCOVILLE
50 mm, 2"
19913-50



SCOVILLE
70 mm, 2 ³/₄"
19913-70



SCOVILLE
19917-64 64 x 25 mm
19918-64 64 x 50 mm
19918-88 88 x 25 mm

Wundhaken für plastische Chirurgie
 Retractors for plastic surgery
 Separadores para cirugía plástica
 Divaricatore per chirurgia plastica



mit Kaltlicht + Absaugung
 with cold light + aspiration
 con luz fria + aspiracion
 con luce fredda + aspirazione

TEBBETTS

19980-01	80 mm x 16 mm
19980-02	100 mm x 25 mm
19980-03	120 mm x 25 mm
19980-04	120 mm x 30 mm
19980-05	150 mm x 25 mm
19980-06	150 mm x 30 mm



FERRIERA

19960-01	80 mm x 16 mm
19960-02	100 mm x 25 mm
19960-03	120 mm x 25 mm
19960-04	120 mm x 30 mm
19960-05	150 mm x 25 mm
19960-06	150 mm x 30 mm

Wundhaken für plastische Chirurgie
 Retractors for plastic surgery
 Separadores para cirugía plástica
 Divaricatore per chirurgia plastica



BREAST
 19970-01
 31 cm, 12 1/4"



CORONAL
 19980-18
 18 cm, 7"



YANCOSKIE
 19990-18
 18 cm, 7"



FREEMAN
 19995-38 18 cm, 7"
 38 mm, 1 1/2" wide
 19995-22 18 cm, 7"
 22 mm, 7/8" wide



ANDERSON
 19998-03 12 cm, 4 3/4" 3 Zähne
 3 prongs
 3 dientes
 3 uncini
 19998-05 12 cm, 4 3/4" 5 Zähne
 5 prongs
 5 dientes
 5 uncini

Sonden
Probes, Directors
Sondas, estiletes
Sonde, specilli



2 mm ø

11,5 cm, 4 1/2" 21102-11
13,0 cm, 5 1/8" 21102-13
14,5 cm, 5 3/4" 21102-14
16,0 cm, 6 1/4" 21102-16
18,0 cm, 7" 21102-18
20,0 cm, 8" 21102-20
25,0 cm, 10" 21102-25



1 mm ø

21104-11
21104-13
21104-14
21104-16
21104-18
21104-20
21104-25



2 mm ø

21106-11
21106-13
21106-14
21106-16
21106-18
21106-20
21106-25

 21108-14
14,5 cm, 5 3/4"

 BRODIE
21109-18
18 cm
7"

13,0 cm, 5 1/8" 21110-13
14,5 cm, 5 3/4" 21110-14
16,0 cm, 6 1/4" 21110-16
18,0 cm, 7" 21110-18
20,0 cm, 8" 21110-20

 DOYEN
21111-14
14 cm
5 1/2"

 21112-14
14,5 cm
5 3/4"

 STACKE
21115-10
10,5 cm
4.1"

 NELATON
21120-16
16 cm
6 1/4"

 FISH
21121-14
14 cm, 5 1/2"
21121-18
18 cm, 7"

 WATSON-CHEYNE
21122-13
13 cm, 5 1/8"
21122-18
18 cm, 7"

Fistelsonden
Fistula Probes
Sondas para fistula
Sonde per fistole



LOCKHART-MUMMERY
21125-01
16,5 cm, 6 1/2"

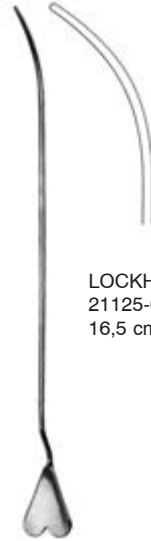

LOCKHART-MUMMERY
21125-02
16,5 cm, 6 1/2"



LOCKHART-MUMMERY
21125-03
16,5 cm, 6 1/2"



LOCKHART-MUMMERY
21125-04
16,5 cm, 6 1/2"

Krampfader-Besteck in Metalletui
 Varicose vein probe set in metal case
 Juego para várices en estuche de metal
 Astuccio per varici in scatola di metallo

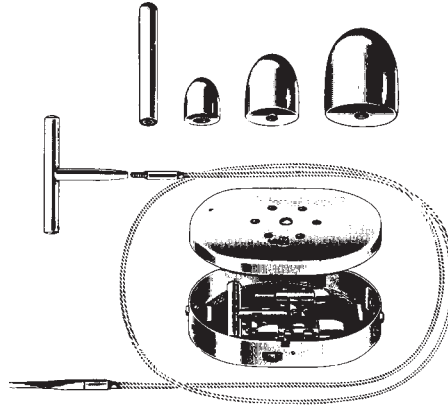

NABATOFF
 21150-00
 135x100x25 mm
 compl.

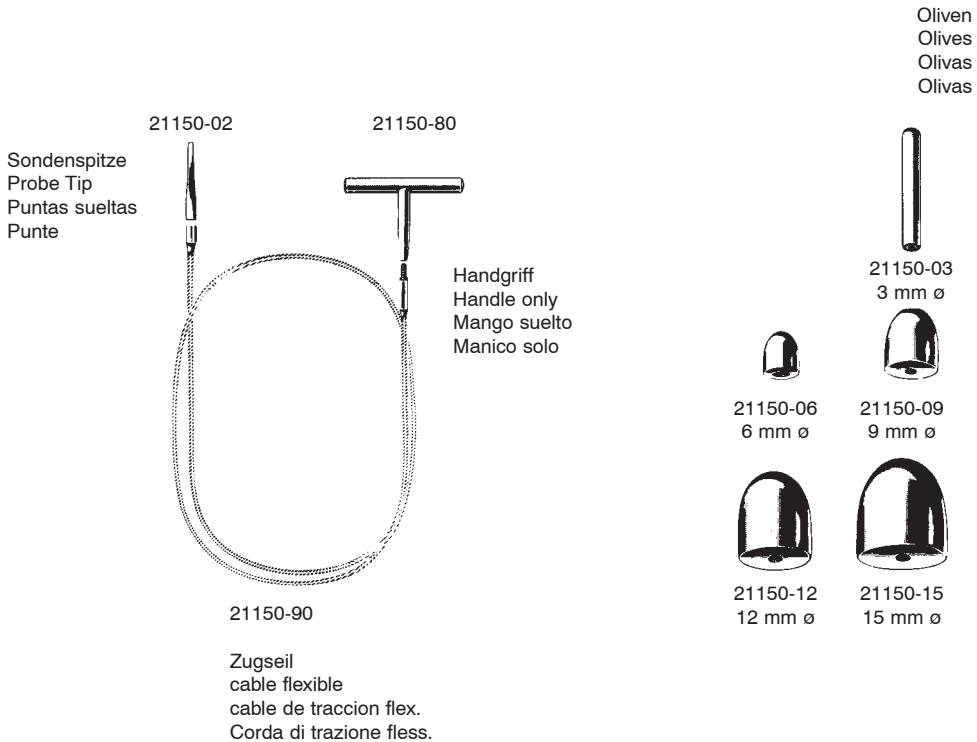



Varizeninstrumente
 Varix Instruments
 Instrumentos para varices
 Strumenti per varici



VARADY
 21154-01
 180 mm, 7"



VARADY
 21154-02
 180 mm, 7"



VARADY
 21154-03
 180 mm, 7"



VARADY
 21154-04
 175 mm, 6.9"



VARADY
 21154-05
 170 mm, 6 3/4"



VARADY
 21154-06
 170 mm, 6 3/4"

21162-12
 12 cm, 4 3/4"
 Griff
 Handle
 Mango
 Manico

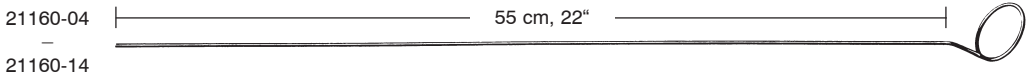

21160-04
 4 mm ø



21160-06
 6 mm ø



21160-07
 7 mm ø



21160-08
 8 mm ø



21160-10
 10 mm ø

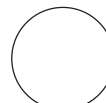

21160-12
 12 mm ø

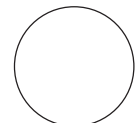

21160-14
 14 mm ø

Watteträger, Spatel
 Cotton Applicators, Spatulas
 Porta-algodones, Espátulas
 Portacotone, Spatole



FARRELL

4 3/4"	21270-12	12,0 cm
5 1/2"	21270-14	14,0 cm
6 1/2"	21270-16	16,5 cm
7"	21270-18	18,0 cm
9"	21270-23	23,0 cm



FARRELL

4 3/4"	21272-12	12,0 cm
5 1/2"	21272-14	14,0 cm
6 1/2"	21272-16	16,5 cm
7"	21272-18	18,0 cm
9"	21272-23	23,0 cm



REDA

4 3/4"	21290-12	12,0 cm
5 1/2"	21290-14	14,0 cm
6 1/4"	21290-16	16,0 cm
7"	21290-18	18,0 cm

1,5



REDA

4 3/4"	21292-12	12,0 cm
5 1/2"	21292-14	14,0 cm
6 1/2"	21292-16	16,0 cm
7"	21292-18	18,0 cm

1,5

Spatel
 Plaster spatula
 Espátula
 Spatole



21190-14
 14,5 cm, 5 3/4"



UCKERMANN
 21310-15
 15 cm, 6"

ø 3 mm



JOBSON-HORNE
 21320-12 12 cm, 4 3/4"
 21320-18 18 cm, 7"



TOBOLD
 21331-25
 25 cm, 10"

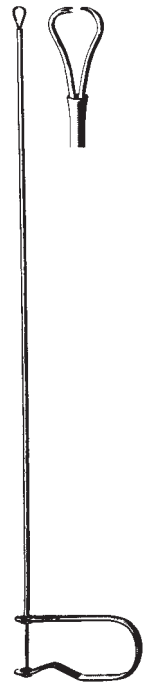

21340-45
 45 cm, 17 3/4"

Trokare
Trocars
Trócares
Trequarti

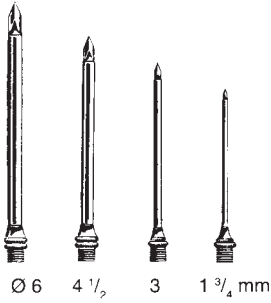

Ø 6 4 1/2 3 1 3/4 mm



UNIVERSAL
23104-00
compl.



STANDARD (NELSON)

23110-30	3,0 mm ø
23110-35	3,5 mm ø
23110-40	4,0 mm ø
23110-45	4,5 mm ø
23110-50	5,0 mm ø
23110-55	5,5 mm ø
23110-60	6,0 mm ø



PIERCE

23123-30	3,0 mm Ø
23123-40	4,0 mm Ø
23123-50	5,0 mm Ø



DOUGLAS
23125-11 3 mm Ø

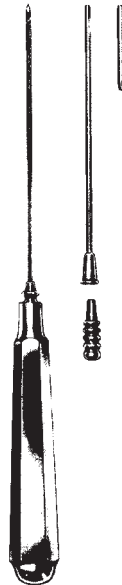

LICHTWITZ
23128-19 1,75 mm Ø

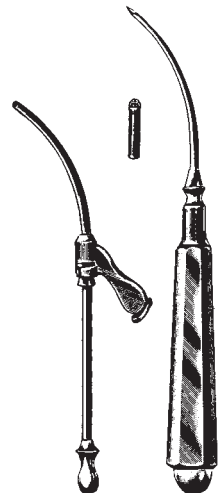

COAKLEY
23140-02 2,25 mm Ø

Trokare
Trocars
Trócares
Trequarti

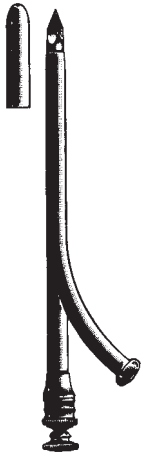

Charr./	F.G.	OCHSNER
10	23150-10	
12	23150-12	
14	23150-14	
16	23150-16	
18	23150-18	
20	23150-20	



Charr./	F.G.	NELSON	ø
25	23170-25		7,5 mm
30	23170-30		9,0 mm
33	23170-33		10,5 mm
35	23170-35		12,0 mm



SINOSKOPIE-TROKAR
8,5 cm, 3.4"

23181-40 f. Optik mit Ø 4,0 mm

Biopsiekanülen
Biopsy Needles
Agujas para biopsia
Aghi per biopsia

Nadelführer
Pudendus
Anesthésie
anestesia



IOWA
23210-00
14 cm, 5 1/2"
compl.

Pneumoperitoneum
Pneumoperitoneum
Neumoperitoneo
Pneumoperitoneo



VERRES
23250-20 2,00x100 mm
23250-40 2,00x140 mm



MENGHINI
23302-01 1,0x 35 mm
23302-02 1,0x 70 mm
23302-03 1,2x 70 mm
23302-04 1,2x100 mm
23302-05 1,4x 70 mm
23302-06 1,4x100 mm
23302-07 1,6x 70 mm
23302-08 1,8x100 mm



MENGHINI
23310-14 1,4x168 mm
23310-18 1,8x168 mm

Führungsnadeln
 Guide needles
 Aguja de Guía
 Ago guida

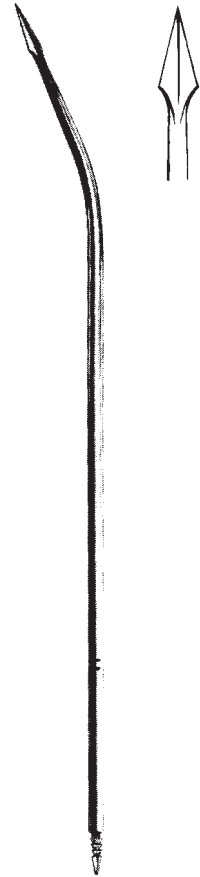
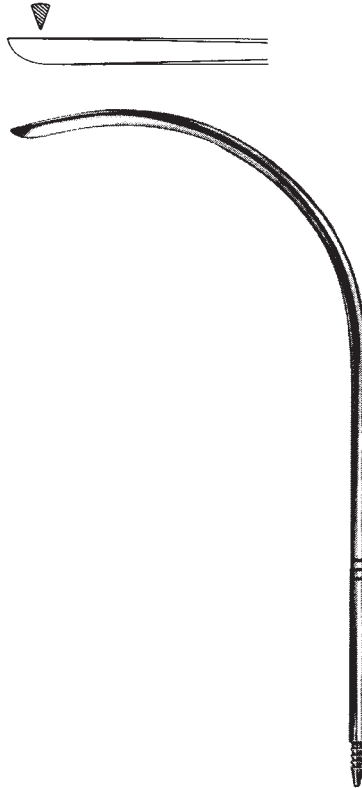
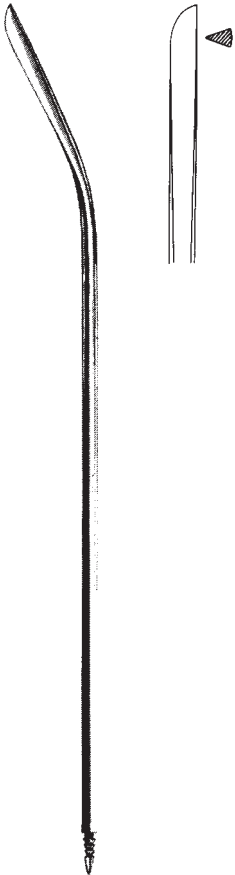

REDON
 23195-08 - 23195-18

Messerspitze, gerade
 Guide Needle, straight
 Aguja de guía, recta
 Ago guida, retta

Charr./Fr.
 8 23195-08
 10 23195-10
 12 23195-12
 14 23195-14
 16 23195-16
 18 23195-18

REDON
 23197-08 - 23197-18

Messerspitze, gebogen
 Guide Needle, curved
 Aguja de guía, curva
 Ago guida, curva

Charr./Fr.
 8 23197-08
 10 23197-10
 12 23197-12
 14 23197-14
 16 23197-16
 18 23197-18

REDON
 23198-08 - 23198-18

Lanzettspitze, gerade
 Lancet tip, straight
 Punta lanceolar, recta
 Punta lanceolata, retta

Charr./Fr.
 8 23198-08
 10 23198-10
 12 23198-12
 14 23198-14
 16 23198-16
 18 23198-18

Nadelhalter
Needle Holders
Porta-agujas
Port'aghi



DERF

25110-12 12 cm, 4 ³/₄"
25114-12 TC 12 cm, 4 ³/₄"



DERF

25120-12 12,5 cm, 5"

COLLIER

25122-12 12,5 cm, 5"



glatt
smooth
lisa
liscia

WEBSTER

25128-13 13 cm, 5 ¹/₈"
25129-13 TC 13 cm, 5 ¹/₈"

BABY-WEBSTER

25136-11 11 cm, 4 ³/₈"
25137-11 TC 11 cm, 4 ³/₈"

25138-11 TC 11 cm, 4 ³/₈"
gerieft/serrated
estriada/zigrinato



HALSEY

25130-13 25140-13
25134-13 TC 25144-13 TC
13 cm, 5 ¹/₈"



NEIVERT

25146-13 25148-13 TC
13 cm, 5 ¹/₈"



BAUMGARTNER

25150-12 25154-12 TC
12,5 cm, 5"
25150-14 25154-14 TC
14,0 cm, 5 ¹/₂"

Nadelhalter
Needle Holders
Porta-agujas
Port'aghi



CRILE-WOOD

- | | | |
|----------|-----------|-------------|
| 25160-15 | 15 cm, 6" | 25164-15 TC |
| 25160-18 | 18 cm, 7" | 25164-18 TC |
| 25160-20 | 20 cm, 8" | 25164-20 TC |
| 25160-23 | 23 cm, 9" | 25164-23 TC |



CRILE-MURRAY

- | | |
|----------|-------------|
| 25170-15 | 25174-15 TC |
| | 15 cm, 6" |



MAYO-HEGAR

- | | | |
|----------|----------------|-------------|
| 25180-12 | 12 cm, 4 3/4" | 25184-12 TC |
| 25180-14 | 14 cm, 5 1/2" | 25184-14 TC |
| 25180-16 | 16 cm, 6 1/4" | 25184-16 TC |
| 25180-18 | 18 cm, 7" | 25184-18 TC |
| 25180-20 | 20 cm, 8" | 25184-20 TC |
| 25180-24 | 24 cm, 9 1/2" | 25184-24 TC |
| 25180-26 | 26 cm, 10 1/4" | 25184-26 TC |
| 25180-30 | 30 cm, 11 3/4" | 25184-30 TC |

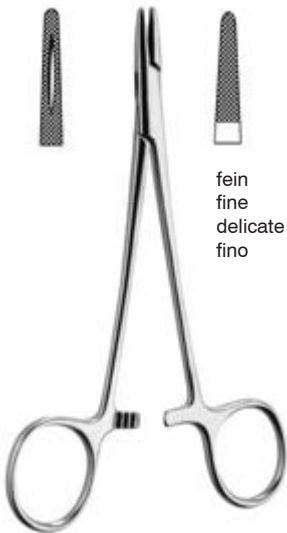

fein
fine
delicate
fino

MAYO-HEGAR

- | | | |
|----------|---------------|-------------|
| 25190-16 | 16 cm, 6 1/4" | 25194-16 TC |
| 25190-18 | 18 cm, 7" | 25194-18 TC |
| 25190-20 | 20 cm, 8" | 25194-20 TC |



BROWN

- | | |
|----------|---------------|
| 25196-13 | 13 cm, 5 1/8" |
| 25196-18 | 18 cm, 7" |

Nadelhalter
Needle Holders
Porta-agujas
Port'aghi



DE BAKAY

25214-16 TC	16 cm, 6 1/4"
25214-18 TC	18 cm, 7"
25214-20 TC	20 cm, 8"
25214-23 TC	23 cm, 9"
25214-26 TC	26 cm, 10 1/4"
25214-31 TC	31 cm, 12 1/4"



RYDER 1 mm

25224-13 TC	13 cm, 5 1/8"
25224-15 TC	15 cm, 6"
25224-18 TC	18 cm, 7"
25224-20 TC	20 cm, 8"
25224-23 TC	23 cm, 9"
25224-26 TC	26 cm, 10 1/4"

RYDER 2 mm

25225-13 TC	
25225-15 TC	
25225-18 TC	
25225-20 TC	
25225-23 TC	
25225-26 TC	

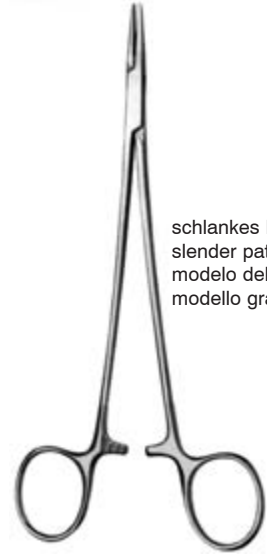

schlankes Modell
slender pattern
modelo delgado
modello gracile

MICROVASCULAR

25230-18 TC	18 cm, 7"
25230-20 TC	20 cm, 8"
25230-23 TC	23 cm, 9"



HEANEY

25241-21	21 cm, 8 1/4"
25241-26	26 cm, 10 1/4"
25245-21 TC	21 cm, 8 1/4"
25245-26 TC	26 cm, 10 1/4"

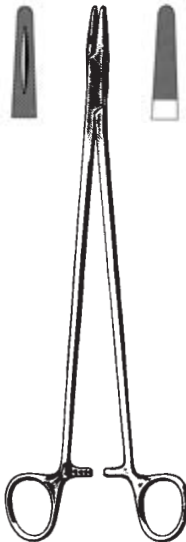

MASSON

25250-27	27 cm, 10 1/2"
25254-27 TC	27 cm, 10 1/2"



WANGENSTEEN

25260-27	27 cm, 10 1/2"
25264-27 TC	27 cm, 10 1/2"

Nadelhalter
Needle Holders
Porta-agujas
Port'aghi

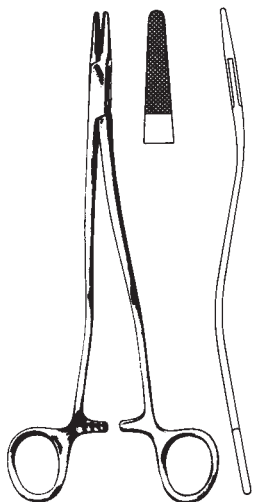

BOZEMANN

- 25285-20 TC 20 cm, 8"
- 25285-24 TC 24 cm, 9 1/2"
- 25285-26 TC 26 cm, 10 1/4"

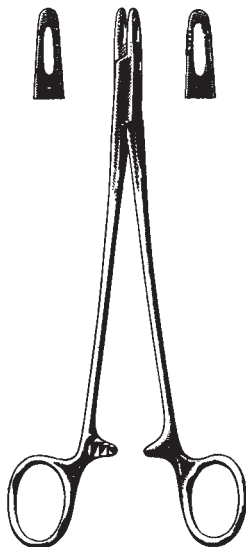

METZENBAUM

- 25290-18
18 cm, 7"

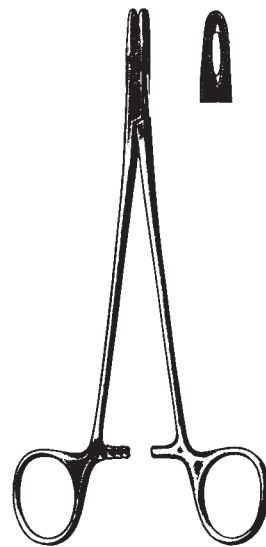

ADSON

- 25292-18
18 cm, 7"

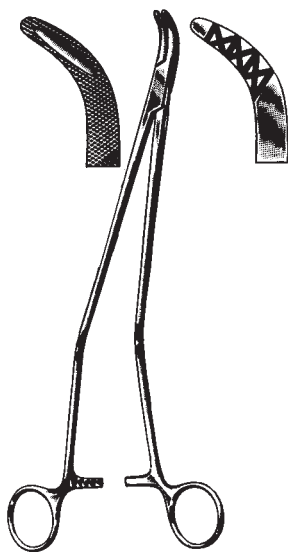

JOHNSON

- 25293-27
27 cm, 10 1/2"

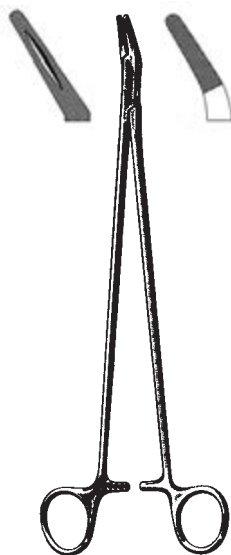

FINOCHIETTO

- 25311-20 20 cm, 8" 25315-20 TC
- 25311-27 27 cm, 10 1/2" 25315-27 TC



SAROT

- 25324-18 TC 18 cm, 7"
- 25324-26 TC 26 cm, 10 1/4"

Nadelhalter
Needle Holders
Porta-agujas
Port'aghi

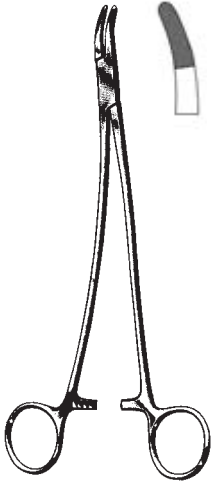

STRATTE

25330-21 21 cm, 8 1/4"
25330-23 23 cm, 9" **25334-23 TC**

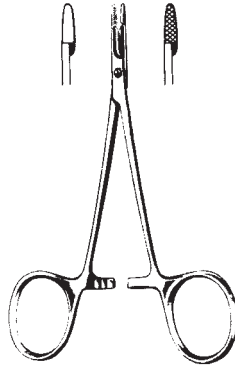

BABY-OLSEN-HEGAR

25405-12 25406-12
25408-12 TC 25407-12 TC
11,5 cm, 4 1/2"

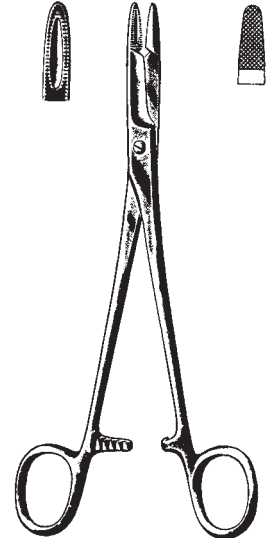

OLSEN-HEGAR

25410-14 14 cm, 5 1/2" **25414-14 TC**
25410-17 17 cm, 6 3/4" **25414-17 TC**
18 cm, 7" **25414-18 TC**



MATHIEU-OLSEN

25415-14 TC 14 cm, 5 1/2"
25415-17 TC 17 cm, 6 3/4"
25415-20 TC 20 cm, 8"

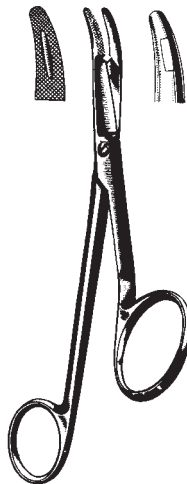

GILLIES

11 cm, 4 3/8" **25434-11 TC**
13 cm, 5 1/8" **25434-13 TC**
25430-16 16 cm, 6 1/4" **25434-16 TC**



KILNER

25436-13 13 cm, 5 1/8"
25438-13 TC 13 cm, 5 1/8"

Nadelhalter
Needle Holders
Porta-agujas
Port'aghi

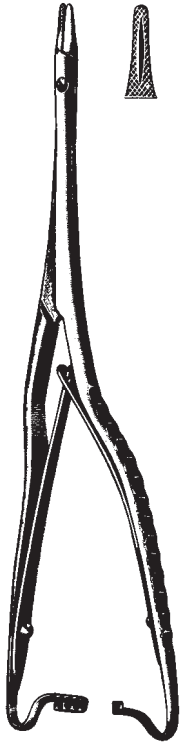

HOESEL

25446-25 25 cm, 10"
25447-25 TC 25 cm, 10"

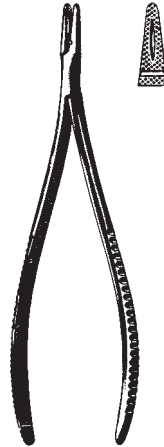

CRILE

25438-15 15 cm, 6"

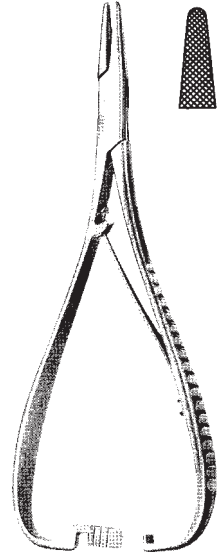

MATHIEU

25450-14 14 cm, 5 1/2" 25452-14 TC
25450-17 17 cm, 6 3/4" 25452-17 TC
25450-20 20 cm, 8" 25452-20 TC
25450-24 24 cm, 9 1/2" 25452-24 TC

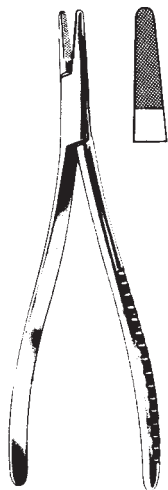

LANGENBECK

25460-18 TC 18 cm, 7"
25460-20 TC 20 cm, 8"
25460-23 TC 23 cm, 9"

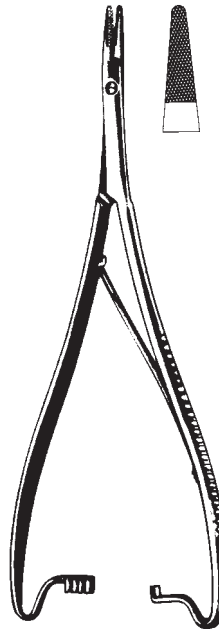

HOESEL

25465-20 TC 20 cm, 8"
25465-25 TC 25 cm, 10"



LICHTENBERG

25466-17 17 cm, 6 3/4" 25467-17 TC
25466-20 20 cm, 8" 25467-20 TC

Nadelhalter
Needle Holders
Porta-agujas
Port'aghi

Oftalmologie
Ophthalmology
Oftalmologia
Oftalmologia



STEVENS
25610-11
11 cm, 4 3/8"



STEVENS
25612-13 13 cm, 5 1/8"
25612-15 15 cm, 6"



BOYNTON
25614-12
12 cm, 4 3/4"



BOYNTON
25615-12 TC
12 cm, 4 3/4"



ARRUGA
25620-16 - 25624-16
16 cm, 6 1/4"

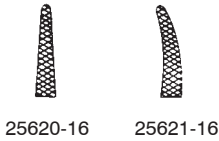

25620-16 25621-16

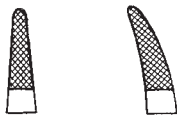

25624-16 TC 25625-16 TC



KALT-ARRUGA
25627-14
14 cm, 5 1/2"



KALT
25628-14
14 cm, 5 1/2"

Nadelhalter
Needle Holders
Porta-agujas
Port'aghi



JACOBSEN
25667-18 18 cm, 7"
25668-18 TC 18 cm, 7"
25667-21 21 cm, 8 1/4"
25668-21 TC 21 cm, 8 1/4"



CASTROVIEJO
14 cm, 5 1/2"



25670-14
glatt
smooth
lisa
liscia



25672-14
gerieft
serrated
estriada
zigrinato



25676-14 TC



25671-14
glatt
smooth
lisa
liscia



25673-14
gerieft
serrated
estriada
zigrinato



25677-14 TC



25678-09



25679-09



CASTROVIEJO-MICRO
9 cm, 3 1/2"



CASTROVIEJO
25680-13 13 cm, 5 1/8"
25684-13 TC 13 cm, 5 1/8"

Mikro-Nadelhalter
 Micro-Needle Holders
 Micro-Porta-agujas
 Micro-Port'aghi



CASTROVIEJO-STANDARD
 25678-14 14 cm, 5 1/2"



CASTROVIEJO-STANDARD
 25679-14 14 cm, 5 1/2"

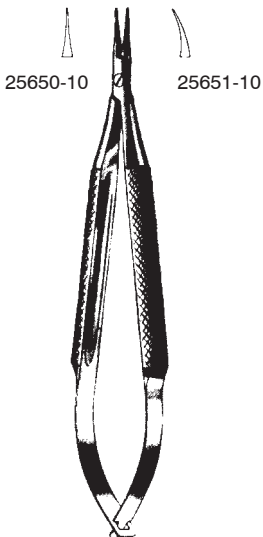

BARRAQUER
 10 cm, 4"



BARRAQUER-TROUTMAN
 10 cm, 4"

Mikro-Nadelhalter
Micro-Needle Holders
Micro-Porta-agujas
Micro-Port'aghi



BARRAQUER
13 cm, 5 1/8"

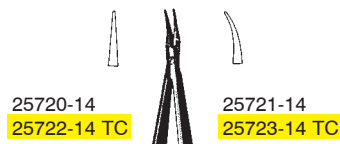

BARRAQUER
14 cm, 5 1/2"

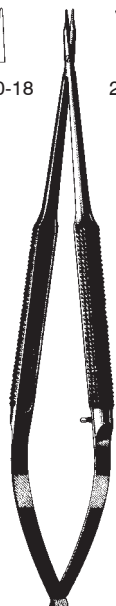

BARRAQUER
18 cm, 7"

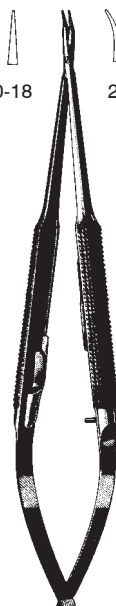
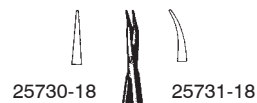

BARRAQUER
18 cm, 7"

Unterbindungsnadeln
Ligature Needles
Agujas para ligaduras
Aghi per legature



biegsam
malleable
maleable
malleabile

27109-20
20 cm, 8"

für die rechte Hand
for right hand
para la mano derecha
per la mano destra

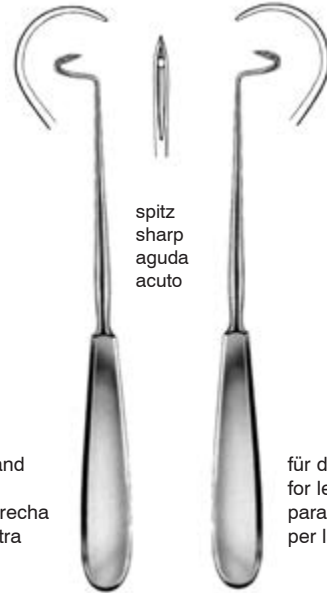

spitz
sharp
aguda
acuto

für die linke Hand
for left hand
para la mano izquierda
per la mano sinistra

DESCHAMPS

27110-21	21 cm, 8 1/4"	27111-21
27110-24	24 cm, 9 1/2"	27111-24
27110-27	27 cm, 10 1/2"	27111-27

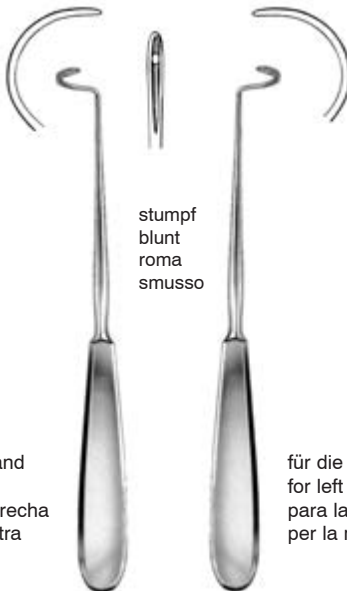

stumpf
blunt
roma
smusso

für die rechte Hand
for right hand
para la mano derecha
per la mano destra

für die linke Hand
for left hand
para la mano izquierda
per la mano sinistra

DESCHAMPS

27120-21	21 cm, 8 1/4"	27121-21
27120-24	24 cm, 9 1/2"	27121-24
27120-27	27 cm, 10 1/2"	27121-27

Unterbindungsnadeln
Ligature Needles
Agujas para ligaduras
Aghi per legature



27130-13
fein, für die rechte Hand
delicate, for right hand
fina, para la mano derecha
fino, per la mano destra

stumpf
blunt
roma
smusso

27131-13
fein, für die linke Hand
delicate, for left hand
fina, para la mano izquierda
fino, per la mano sinistra

KRONECKER
13 cm, 5 1/8"



SCHMIEDEN-DICK
27134-32 32 cm, 12 3/4"
biegsam - malleable - maleable - malleabile



stumpf
blunt
roma
smusso

27133-24
für die rechte Hand
for right hand
para la mano derecha
per la mano destra



NELSON
24,5 cm, 9 3/4"

27135-24
für die linke Hand
for left hand
para la mano izquierda
per la mano sinistra



COOPER
27139-19 19 cm, 7 1/2"

Nahtinstrumente
 Suturing Instruments
 Instrumentos para suturas
 Strumenti per suture

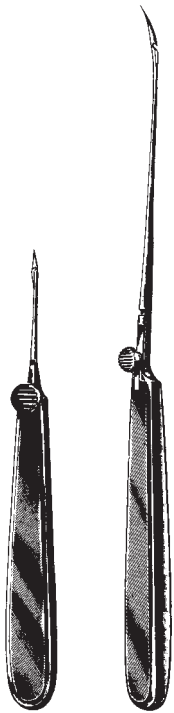

REVERDIN
 27201-15 - 27204-21



Fig. 1

- 27201-15 15 cm, 6"
- 27201-19 19 cm, 7 1/2"
- 27201-21 21 cm, 8 1/4"



Fig. 2

- 27202-15 15 cm, 6"
- 27202-19 19 cm, 7 1/2"
- 27202-21 21 cm, 8 1/4"



Fig. 3

- 27203-15 15 cm, 6"
- 27203-19 19 cm, 7 1/2"
- 27203-21 21 cm, 8 1/4"



Fig. 4

- 27204-15 15 cm, 6"
- 27204-19 19 cm, 7 1/2"
- 27204-21 21 cm, 8 1/4"



YOUNG BOOMERANG
 27240-00
 25 cm, 10"



Fig. 1
 27240-01

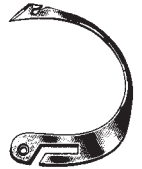

Fig. 2
 27240-02

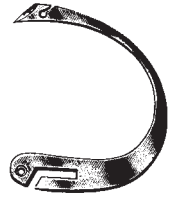
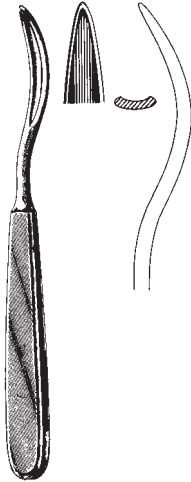
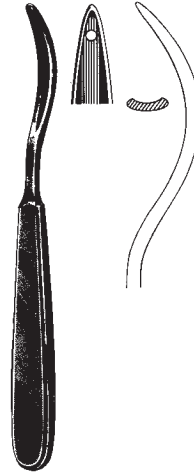

Fig. 3
 27240-03

Führungshohlsonden
Ligature Conductors
Sondas conductoras
Sonde conduttrici



SCHMIEDEN
27271-19 19 cm, 7 1/2"



SCHMIEDEN-PAYR
27273-19 19 cm, 7 1/2"

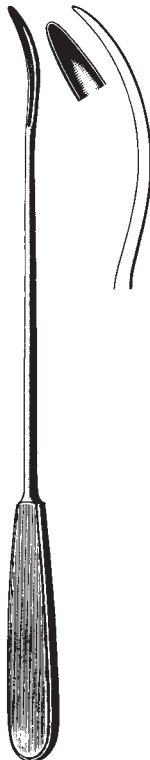

BRUNNER
27275-30 30 cm, 11 3/4"

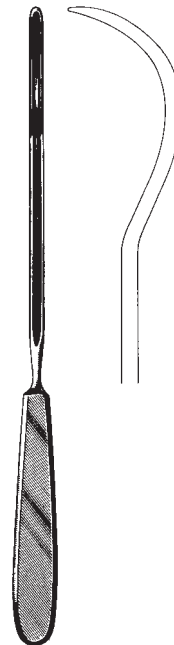

KIRSCHNER
27277-25 25,5 cm, 10"

Führungshohlsonden, Fadenfänger, Fadengabel
 Ligature Conductors, Ligature Catcher, Ligature Adjuster
 Sondas conductoras, Captador de hilos, Horquilla de hilos
 Sonde conduttrici, Portalegature, Forchetta da sutura

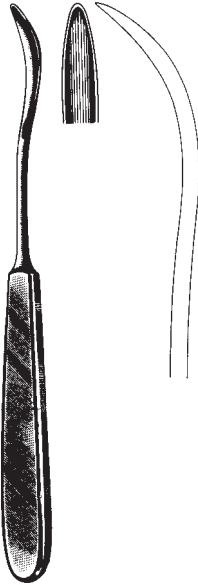

KOENIG
 27285-20
 20 cm, 8"



PAYR
 27288-22
 22 cm, 8 3/4"



PAYR
 27289-22
 22 cm, 8 3/4"

Plastik
 plastic
 plástico



BRUNNER
 27291-18 18 cm, 7"
 27291-27 27 cm, 10 1/2"



VIENNA
 27297-23
 23,5 cm, 9 1/4"



REDA
 27298-23
 23 cm, 9"

Chirurgische Nadeln
Suturing Needles
Agujas para suturas
Aghi per suture

Pack à 1 Dutzend
in packages of 1 dozen
en sobres de 1 docena
confezione 1 dozzina

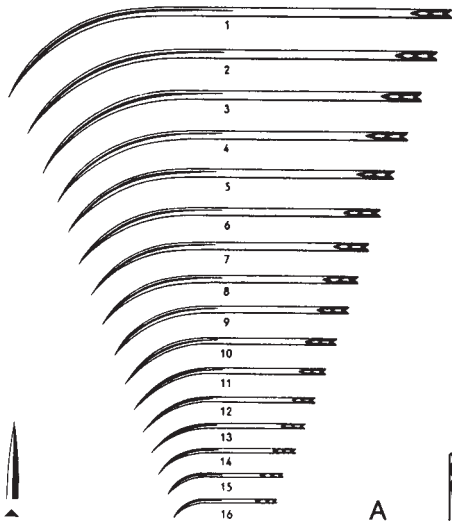

27403-01 - 27403-16

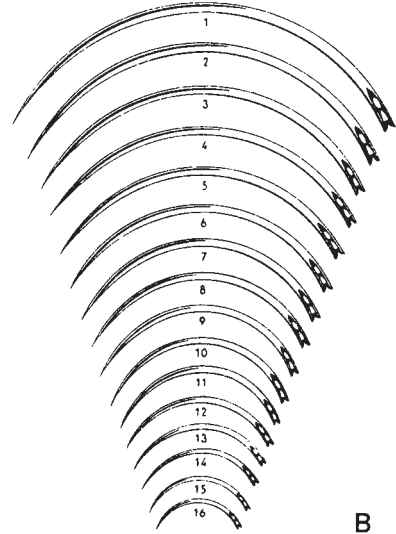

27413-01 - 27413-16

- Fig. 1 2 3 4 5 6 7 8 9 10 11 12 13 14 15 16
- A 27403-01 27403-02 27403-03 27403-04 27403-05 27403-06 27403-07 27403-08 27403-09 27403-10 27403-11 27403-12 27403-13 27403-14 27403-15 27403-16
- B 27413-01 27413-02 27413-03 27413-04 27413-05 27413-06 27413-07 27413-08 27413-09 27413-10 27413-11 27413-12 27413-13 27413-14 27413-15 27413-16
- G 27423-01 27423-02 27423-03 27423-04 27423-05 27423-06 27423-07 27423-08 27423-09 27423-10 27423-11 27423-12 27423-13 27423-14 27423-15 27423-16
- Ga 27433-01 27433-02 27433-03 27433-04 27433-05 27433-06 27433-07 27433-08 27433-09 27433-10 27433-11
- Gr 27434-01 27434-02 27434-03 27434-04 27434-05 27434-06 27434-07 27434-08 27434-09 27434-10 27434-11 27434-12 27434-13 27434-14 27434-15 27434-16

Alle Nadeln mit Öhr
all the needles with spring eye
todas las agujas con ojo a resorte
tutti gli aghi con cruna aperta

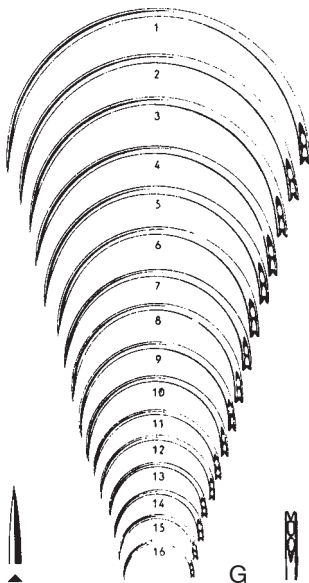

27423-01 - 27423-16

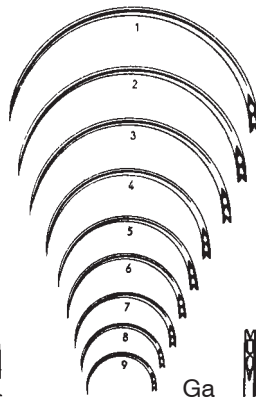

27433-01 - 27433-09

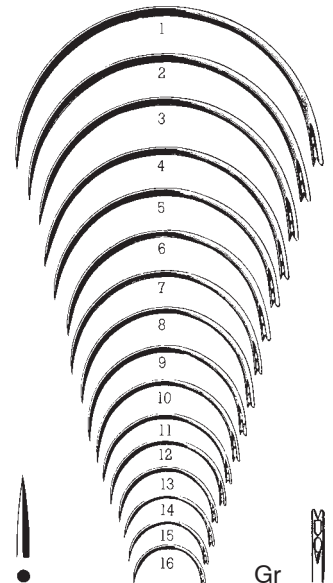

27434-01 - 27434-16

Alle Nadeln mit Öhr
 all the needles with spring eye
 todas las agujas con ojo a resorte
 tutti gli aghi con cruna aperta

Chirurgische Nadeln
 Suture needles
 Agujas para suturas
 Aghi per suture

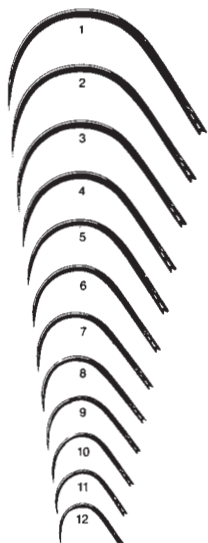

27441-01 - 27441-12

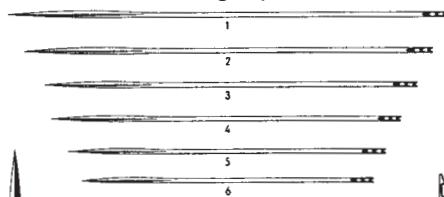
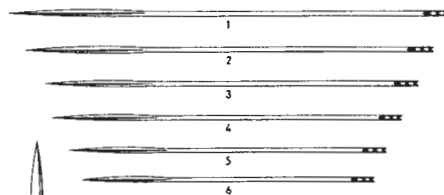
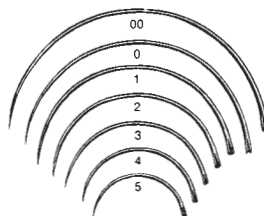
 KEITH
 27450-01 - 27450-06

 KEITH
 27452-01 - 27452-06

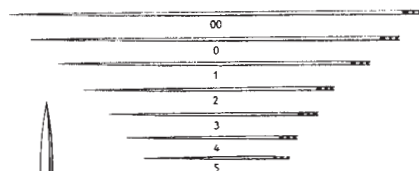
27465-20 - 27467-05 Pb

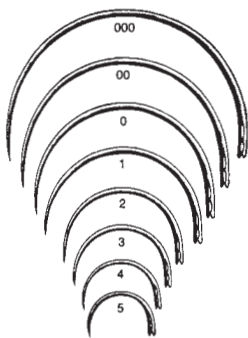

27475-20 - 27477-05 Pc



27443-30 - 27443-05

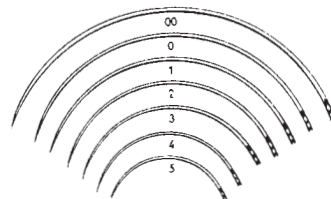

27485-20 - 27487-05 Pd

FIG.	000	00	0	1	2	3	4	5	6	7	8	9	10	11	12
KÖNIG				27441-01	27441-02	27441-03	27441-04	27441-05	27441-06	27441-07	27441-08	27441-09	27441-10	27441-11	27441-12
E	27443-30	27443-20	27443-10	27443-01	27443-02	27443-03	27443-04	27443-05							
KEITH				27450-01	27450-02	27450-03	27450-04	27450-05	27450-06						
KEITH				27452-01	27452-02	27452-03	27452-04	27452-05	27452-06						
Pb		27465-20	27465-10	27467-01	27467-02	27467-03	27467-04	27467-05							
Pc		27475-20	27475-10	27477-01	27477-02	27477-03	27477-04	27477-05							
Pd		27485-20	27485-10	27487-01	27487-02	27487-03	27487-04	27487-05							

Wundklammerpinzetten und -zangchen, Wundklammern
 Clip Applying Forceps, Suture Clips
 Pinzas aplicadoras para agrafes, Agrafes de sutura
 Pinze per applicare le agrafe, Agrafe



MICHEL
 27610-12
 12 cm, 4 3/4"



WACHENFELDT
 27612-12
 12,5 cm, 5"



WACHENFELDT
 27614-12
 12,5 cm, 5"



HEGENBARTH
 27616-12
 12,5 cm, 5"



CHILDE
 27620-18
 18 cm, 7"



MICHEL
 27630-12
 12 cm, 4 3/4"



COLLIN
 27640-13
 13 cm, 5 1/8"



RICHTER-HEATH
 27642-14
 14 cm, 5 1/2"

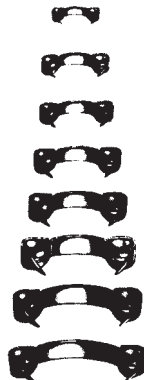

MICHEL

- MICHEL mm
- 27660-07 7,5x1,75
- 27660-11 11x2
- 27660-12 12x2,5
- 27660-14 14x3
- 27660-16 16x3
- 27660-18 18x3
- 27660-20 20x3
- 27660-22 22x3

Pack  1000
 box of 1000
 paq x 1000
 confezione x 1000

Nahtbesteck
Suture Set
Estuche para suturas
Set per sutura



STANDARD

27680-00
165 x 90 x 28 mm

Komplett in Metalletui und Plastiktasche mit 2 herausnehmbaren gelochten Einlagen mit Stegen für Instrumente

Bestehend aus:

- 1 Mathieu Nadelhalter 14 cm (5 $\frac{1}{2}$ ")
- 1 Nähseide in Alkohol
- 6 Nähnadeln sortiert
- 1 Nadeldose gelocht 65 x 42 cm
- 1 Michel Wundklammerzange
- 20 Wundklammern auf Halter
- 1 Skalpellgriff mit Klinge
- 3 Klängen auswechselbar
- 1 Schere st/sp. 13 cm (5") gerade
- 1 anat. Pinzette 11,5 cm (4 $\frac{1}{2}$ ")
- 1 Hakenpinzette 1 x 2 Z. 12 cm (4 $\frac{3}{4}$ ")
- 1 Hunter Splitterpinzette 10,5 cm (4 $\frac{1}{4}$ ")
- 1 Kocher Arterienklemme 13 cm (5")
- 1 Myrtenblattsonde 13 cm (5")

Complete in metal case with plastic pouch and 2 removable perforated trays for instruments

Contents:

- 1 Mathieu Needle Holder, 14 cm (5 $\frac{1}{2}$ ")
- 1 Flacon with sterilized silk in alcohol
- 6 Suture Needles, assorted
- 1 Needle Case, 25.6" x 16.5", perforated
- 1 Michel Suture Clip Forceps
- 20 Michel Suture Clips with Clip Holder
- 1 Scalpel Handle with Blade
- 3 Scalpel Blades, interchangeable
- 1 Scissors, straight, blunt/sharp, 13 cm (5")
- 1 Dressing Forceps, 11,5 cm (4 $\frac{1}{2}$ ")
- 1 Tissue Forceps, 12 cm (4 $\frac{3}{4}$ "), 1 x 2 teeth
- 1 Hunter Splinter Forceps, 10,5 cm (4 $\frac{1}{4}$ ")
- 1 Kocher Artery Forceps, straight, 13 cm (5"), S
- 1 Probe with myrtle leaf, 13 cm (5")

Completo en caja de metal con bolsa de plástico y 2 bandejas perforadas para los instrumentos

Contenido:

- 1 Porta-aguja de Mathieu, 14 cm (5 $\frac{1}{2}$ ")
- 1 Frasco con seda esterilizada para sutura, en alcohol
- 6 Agujas de sutura surtidas
- 1 Cajita para agujas, 65 x 42 mm, perforada
- 1 Pinza para agrafes de Michel
- 20 Agrafes de Michel, en su porta-agrafes
- 1 Mango de bisturi, con hoja intercambiable
- 3 Hojas intercambiables surtidas
- 1 Tijera, recta, roma/aguda, 13 cm (5")
- 1 Pinza de disección, 11,5 cm (4 $\frac{1}{2}$ ")
- 1 Pinza de disección, con 1 x 2 dientes, 12 cm (4 $\frac{3}{4}$ ")
- 1 Pinza para espinas de Hunter, 10,5 cm (4 $\frac{1}{4}$ ")
- 1 Pinza hemostática de Kocher, 13 cm (5"), S.
- 1 Estilete abotonado, multiforme, 13 cm (5")

Astuccio tascabile con due supporti estraibili

Contenente:

- 1 Port aghi di Mathieu 14 cm (5 $\frac{1}{2}$ ")
- 1 Set per sutura in flacone di vetro
- 6 aghi per sutura assortiti
- 1 scatola per aghi 65 x 24 perforata
- 1 pinza per sutura di Michel
- 20 Agrafe Michel ed porta agrafe
- 1 Manico da bisturi per lama intercambiabile
- 3 lame da bisturi intercambiabili
- 1 forbici rette alterne 13 cm (5")
- 1 pinze da dissezione
- 1 pinze da dissezione 1 x 2 denti
- 1 pinze di Hunter per schegge 10,5 cm (4 $\frac{1}{4}$ ")
- 1 pinze emostatiche di Kocher 13 cm (5")
- 1 specillo bottonuto 13 cm (5")

Sterilisierzangen, Abfallzange, Sterilisierklammern
 Sterilization Instruments, Waste Forceps, Safety pins
 Instrumentos para la esterilización, Pinza para desechos, Cadres de estérilizacion,
 Pinze per la sterilizzazione, Pinza per rifiuti, Spilloni p. sterilizzazione



DAVIS
 29102-16 16 cm, 6 1/4"
 29102-20 20 cm, 8"
 29102-24 24 cm, 9 1/2"



CHEATLE
 29110-27
 27 cm, 10 1/2"



UNIVERSAL
 29120-20 20 cm, 8" 29121-20
 29120-28 28 cm, 11" 29121-28



ROGGE
 29130-23
 23 cm, 9"



29140-20 20 cm, 8"
 29140-30 30 cm, 11 3/4"



SAUERBRUCH
 29145-55
 55 cm, 21.7"



BUNT
 29150-12 12 cm, 5 3/4"

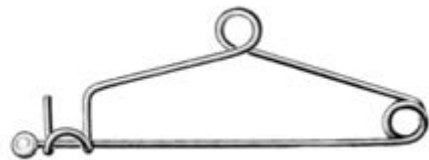

MAYO
 29152-14 14 cm, 5 1/2"

Gipsscheren
Plaster of Paris Shears
Cizallas para vendajes enyesados
Cesoie per gessi

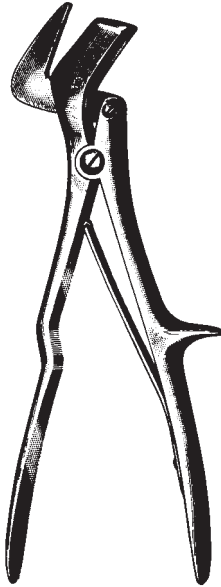

STILLE
31101-24 24 cm, 9 1/2"



STILLE
31103-23 23 cm, 9"
31103-26 26 cm, 10 1/4"
31103-37 37 cm, 14 1/2"



Gipsmesser
plaster knife
cuchillo para vendajes enyesados
coltello da gesso

WIGMORE
31120-19 19 cm, 7 1/2"

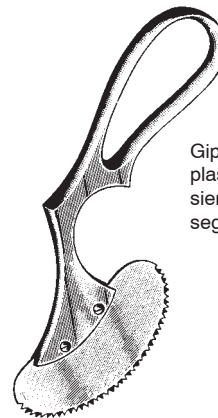

Gipsäge
plaster saw
sierra para vendajes enyesados
sega da gesso

ENGEL
31130-14 16 cm, 6 1/4"
verchromt, chrome plated

Autopsiesäge
Autopsy saw
Sierra para autopsia
Sega per autopsia

Geräuschpegel: 52 - 77 db (A)
Noise level: 52 - 77 db (A)
Nivel de ruido del aparato sólo: 52 - 77 db (A)
Livello acustico dello strumento solo: 52 - 77 db (A)

6500-24000 Schwingungen pro Minute
6500-24000 oscillations per minute
6500-24000 oscilaciones por minuto
6500-24000 oscillazioni al minute

EN 60601-1, EN 60601-1-2, IEC 60601-1, IEC 60601-1-2



31201-01 120 Volt, 500 Watt, 1,5 kg

31201-02 230 Volt, 500 Watt, 1,5 kg

31201-01 + 31201-02 inklusive, inclusive, inclusive, inclusive:

- 1x 31210-50 Ø 50mm Sägeblatt, saw blade, hoja de repuesto, lama per sega
- 1x 31210-65 Ø 65mm Sägeblatt, saw blade, hoja de repuesto, lama per sega
- 1x 31204-01 Ø 50/65mm Segment-Sägeblatt, segment saw blade, hoja de repuesto para segmento, lama per sega a segmento
- 1x 31202-16 Inbusschlüssel T-Griff, alan key with T-handle, llave hexagonal con mango de T, chiave esagonale con manico a T
- 1x 31200-95 Spritze, gefüllt mit Fett, injection filled with fat, jeringa rellena con grasa, siringa colmata con grassa
- 1x 31212-02 Paar Gabelschlüssel, pair flat wrench, pareja llave de boca, paio chiave a bocca, 11mm

Zubehör für Autopsiesäge 31201-02 und 31201-01 siehe Seite 230/14 - 230/18
Accessories for Autopsy saw 31201-02 and 31201-01 please see page 230/14 - 230/18
Accesorios para sierra para autopsia 31201-02 y 31201-01 vea la página 230/14 - 230/18
Accessorio per sega per autopsia 31201-02 e 31201-01 vedi pagina 230/14 - 230/18

31210-45	Ø 45mm	Sägeblatt, saw blade, hoja de repuesto, lama per sega
31210-50	Ø 50mm	Sägeblatt, saw blade, hoja de repuesto, lama per sega
31210-65	Ø 65mm	Sägeblatt, saw blade, hoja de repuesto, lama per sega
31204-01	Ø 50/65mm	Segment-Sägeblatt, segment saw blade, hoja de repuesto para segmento, lama per sega a segmento
31204-03	Ø 65/65mm	Segment-Sägeblatt, segment saw blade, hoja de repuesto para segmento, lama per sega a segmento
31205-08	8mm	Tiefen-Sägeblatt, deep cutting saw, hoja de sierra de profundidad, lama a taglio di profondità
31205-20	20mm	Tiefen-Sägeblatt, deep cutting saw, hoja de sierra de profundidad, lama a taglio di profondità
31203-50		Begrenzungsscheibe, limiting disc, disco de tope, disco eccentrico
31202-16		Inbusschlüssel T-Griff, alan key with T-handle, llave hexagonal con mango de T, chiave esagonale con manico a T
31200-95		Spritze gefüllt mit Fett, injection filled with fat, jeringa rellena con grasa, siringa colmata con grassa
31212-02		1 Paar Gabelschlüssel, pair flat wrench, pareja llave de boca, paio chiave a bocca, 11mm

Autopsiesäge
Autopsy saw
Sierra para autopsia
Sega per autopsia

Geräuschpegel: 52 - 77 db (A)
Noise level: 52 - 77 db (A)
Nivel de ruido del aparato sólo: 52 - 77 db (A)
Livello acustico dello strumento solo: 52 - 77 db (A)

6500-24000 Schwingungen pro Minute
6500-24000 oscillations per minute
6500-24000 oscilaciones por minuto
6500-24000 oscillazioni al minute

EN 60601-1, EN 60601-1-2, IEC 60601-1, IEC 60601-1-2



Dreikantschaft
Three-jaw chuck
Mandril de tres mordazas
Mandrino con tre ganasce



31201-11 120 Volt, 500 Watt, 1,5 kg

31201-22 230 Volt, 500 Watt, 1,5 kg

31201-11 + 31201-22 inklusive, inclusive, inclusive, inclusive:

- | | | |
|-------------|-----------|---|
| 31201-39 | 39mm | Schaft komplett, Arbor complete, Vastago completo, Asta completa |
| 1x 31210-50 | Ø 50mm | Sägeblatt, saw blade, hoja de repuesto, lama per sega |
| 1x 31210-65 | Ø 65mm | Sägeblatt, saw blade, hoja de repuesto, lama per sega |
| 1x 31204-01 | Ø 50/65mm | Segment-Sägeblatt, segment saw blade, hoja de repuesto para segmento, lama per sega a segmento |
| 1x 31202-16 | | Inbusschlüssel T-Griff, alan key with T-handle, llave hexagonal con mango de T, chiave esagonale con manico a T |
| 1x 31200-95 | | Spritze gefüllt mit Fett, injection filled with fat, jeringa rellena con grasa, siringa colmata con grassa |
| 1x 31202-14 | | Paar Gabelschlüssel, pair flat wrench, pareja llave de boca, paio chiave a bocca, 14mm |

Zubehör für Autopsiesäge 31201-22 und 31201-11 siehe Seite 230/14 - 230/18
Accessories for Autopsy saw 31201-22 and 31201-11 please see page 230/14 - 230/18
Accesorios para sierra para autopsia 31201-22 y 31201-11 vea la página 230/14 - 230/18
Accessorio per sega per autopsia 31201-22 e 31201-11 vedi pagina 230/14 - 230/18

31210-45	Ø 45mm	Sägeblatt, saw blade, hoja de repuesto, lama per sega
31210-50	Ø 50mm	Sägeblatt, saw blade, hoja de repuesto, lama per sega
31210-65	Ø 65mm	Sägeblatt, saw blade, hoja de repuesto, lama per sega
31204-01	Ø 50/65mm	Segment-Sägeblatt, segment saw blade, hoja de repuesto para segmento, lama per sega a segmento
31204-03	Ø 65/65mm	Segment-Sägeblatt, segment saw blade, hoja de repuesto para segmento, lama per sega a segmento
31205-08	8mm	Tiefen-Sägeblatt, deep cutting saw, hoja de sierra de profundidad, lama a taglio di profondità
31205-20	20mm	Tiefen-Sägeblatt, deep cutting saw, hoja de sierra de profundidad, lama a taglio di profondità
31203-50		Begrenzungsscheibe, limiting disc, disco de tope, disco eccentrico
31202-16		Inbusschlüssel T-Griff, alan key with T-handle, llave hexagonal con mango de T, chiave esagonale con manico a T
31200-95		Spritze gefüllt mit Fett, injection filled with fat, jeringa rellena con grasa, siringa colmata con grassa
31202-14		1 Paar Gabelschlüssel, pair flat wrench, pareja llave de boca, paio chiave a bocca, 14mm

Zubehör zur Autopsiesäge
Accessories for Autopsy saw
Accesorio para la sierra de autopsia
Accessori per sega per autopsia

31201-39, 39 mm

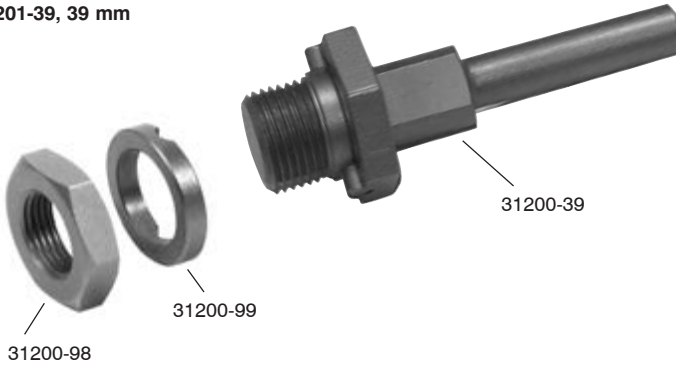

31201-58, 58 mm

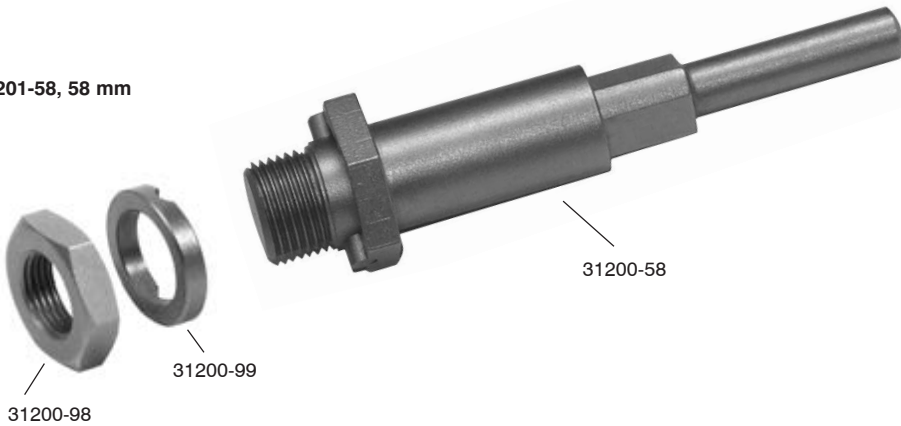

Zubehör zur Autopsiesäge
Accessories for Autopsy saw
Accesorio para la sierra de autopsia
Accessori per sega per autopsia

Set 31203-10**Set 31203-10:** 31201-39 + 31210-65**Set 31203-00:** 31201-39 + 31210-50**Set 31203-20:** 31201-58 + 31210-50**Set 31203-30:** 31201-58 + 31210-65**Set 31204-00****Set 31204-00:** 31201-39 + 31204-01**Set 31204-10:** 31201-39 + 31204-03**Set 31204-20:** 31201-58 + 31204-01**Set 31204-30:** 31201-58 + 31204-03

Zubehör zur Autopsiesäge
 Accessories for Autopsy saw
 Accesorio para la sierra de autopsia
 Accessori per sega per autopsia

Set 31205-00



Set 31205-00: 31201-39 + 31205-20

Set 31206-00: 31201-39 + 31205-08

Set 31206-10: 31201-58 + 31205-08

Set 31205-10: 31201-58 + 31205-20

Set 31210-10



Set 31210-10: 31201-39 + 31210-65 + 31203-50

Set 31210-00: 31201-58 + 31210-65 + 31203-50

Zubehör zur Autopsiesäge
Accessories for Autopsy saw
Accesorio para la sierra de autopsia
Accessori per sega per autopsia

Set 31202-00

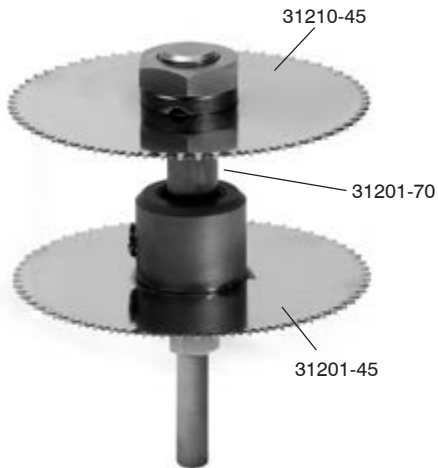

Set 31202-00: 31201-70 + 31210-45 + 31201-45

31201-70

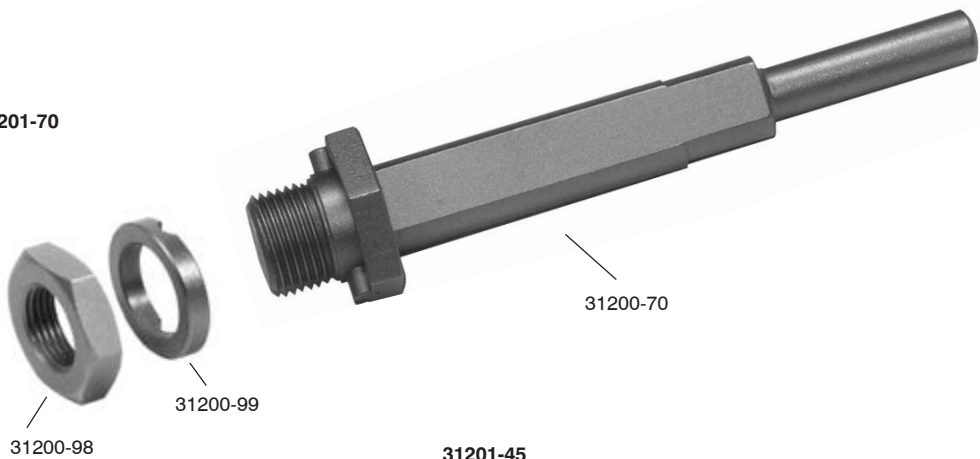

31201-45

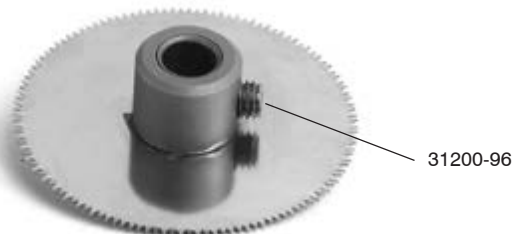

Zubehör für Autopsiesäge 31201-22 und 31201-11 siehe Seite 230/4 - 230/7
 Accessories for Autopsy saw 31201-22 and 31201-11 please see page 230/4 - 230/7
 Accesorios para sierra para autopsia 31201-22 y 31201-11 vea la página 230/4 - 230/7
 Accessorio per sega per autopsia 31201-22 e 31201-11 vedi pagina 230/4 - 230/7

31200-39	Schaft 39mm allein
31201-39	Schaft 39mm komplett
31203-00	Schaft 39mm komplett + Sägeblatt Ø 50mm
31203-10	Schaft 39mm komplett + Sägeblatt Ø 65mm
31204-00	Schaft 39mm komplett + Segmentsägeblatt 50/65mm
31204-10	Schaft 39mm komplett + Segmentsägeblatt 65/65mm
31210-10	Schaft 39mm komplett + Sägeblatt Ø 65mm + Begrenzungsscheibe
31206-00	Schaft 39mm komplett + Tiefensägeblatt 8mm
31205-00	Schaft 39mm komplett + Tiefensägeblatt 20mm
31200-58	Schaft 58mm allein
31201-58	Schaft 58mm komplett
31203-20	Schaft 58mm komplett + Sägeblatt Ø 50mm
31203-30	Schaft 58mm komplett + Sägeblatt Ø 65mm
31204-20	Schaft 58mm komplett + Segmentsägeblatt 50/65mm
31204-30	Schaft 58mm komplett + Segmentsägeblatt 65/65mm
31210-00	Schaft 58mm komplett + Sägeblatt Ø 65mm + Begrenzungsscheibe
31206-10	Schaft 58mm komplett + Tiefensägeblatt 8mm
31205-10	Schaft 58mm komplett + Tiefensägeblatt 20mm
31200-70	Schaft Doppelsäge allein
31201-70	Schaft Doppelsäge komplett
31202-00	Schaft Doppelsäge komplett + Sägeblatt Ø 45mm + verstellbares Sägeblatt Ø 45mm
31201-45	verstellbares Sägeblatt Ø 45mm komplett
31200-96	Inbusmadenschraube für verstellbares Sägeblatt Ø 45mm komplett
31200-98	Mutter für Schaft
31200-99	Sperring für Schaft
31200-39	Arbor 39mm only
31201-39	Arbor 39mm complete
31203-00	Arbor 39mm complete + saw blade Ø 50mm
31203-10	Arbor 39mm complete + saw blade Ø 65mm
31204-00	Arbor 39mm complete + segment saw blade 50/65mm
31204-10	Arbor 39mm complete + segment saw blade 65/65mm
31210-10	Arbor 39mm complete + saw blade Ø 65mm + limiting disc
31206-00	Arbor 39mm complete + deep cutting saw 8mm
31205-00	Arbor 39mm complete + deep cutting saw 20mm
31200-58	Arbor 58mm only
31201-58	Arbor 58mm complete
31203-20	Arbor 58mm complete + saw blade Ø 50mm
31203-30	Arbor 58mm complete + saw blade Ø 65mm
31204-20	Arbor 58mm complete + segment saw blade 50/65mm
31204-30	Arbor 58mm complete + segment saw blade 65/65mm
31210-00	Arbor 58mm complete + saw blade Ø 65mm + limiting disc
31206-10	Arbor 58mm complete + deep cutting saw 8mm
31205-10	Arbor 58mm complete + deep cutting saw 20mm
31200-70	Double saw only
31201-70	Double saw complete
31202-00	Double saw complete + saw blade Ø 45mm + adjustable saw blade Ø 45mm
31201-45	Adjustable saw blade Ø 45mm complete
31200-96	Allen screw for adjustable saw blade Ø 45mm complete
31200-98	Nut for arbor
31200-99	Blocking ring for arbor

Zubehör für Autopsiesäge 31201-22 und 31201-11 siehe Seite 230/4 - 230/7
Accessories for Autopsy saw 31201-22 and 31201-11 please see page 230/4 - 230/7
Accesorios para sierra para autopsia 31201-22 y 31201-11 vea la página 230/4 - 230/7
Accessorio per sega per autopsia 31201-22 e 31201-11 vedi pagina 230/4 - 230/7

31200-39	Vastago 39mm suelto
31201-39	Vastago 39mm completo
31203-00	Vastago 39mm completo + hoja de repuesto Ø 50mm
31203-10	Vastago 39mm completo + hoja de repuesto Ø 65mm
31204-00	Vastago 39mm completo + hoja de repuesto para segmento 50/65mm
31204-10	Vastago 39mm completo + hoja de repuesto para segmento 65/65mm
31210-10	Vastago 39mm completo + hoja de repuesto Ø 65mm + disco de tope
31206-00	Vastago 39mm completo + hoja de sierra de profundidad 8mm
31205-00	Vastago 39mm completo + hoja de sierra de profundidad 20mm
31200-58	Vastago 58mm suelto
31201-58	Vastago 58mm completo
31203-20	Vastago 58mm completo + hoja de repuesto Ø 50mm
31203-30	Vastago 58mm completo + hoja de repuesto Ø 65mm
31204-20	Vastago 58mm completo + hoja de repuesto para segmento 50/65mm
31204-30	Vastago 58mm completo + hoja de repuesto para segmento 65/65mm
31210-00	Vastago 58mm completo + hoja de repuesto Ø 65mm + disco de tope
31206-10	Vastago 58mm completo + hoja de sierra de profundidad 8mm
31205-10	Vastago 58mm completo + hoja de sierra de profundidad 20mm
31200-70	Doble sierra suelta
31201-70	Doble sierra completa
31202-00	Doble sierra completa + hoja de repuesto Ø 45mm + hoja de sierra ajustable Ø 45mm
31201-45	hoja de sierra ajustable Ø 45mm completa
31200-96	tornillo con hembra hexagonal para hoja de sierra ajustable Ø 45mm completa
31200-98	tuerca para vastago
31200-99	anillo de recambio para vastago
31200-39	Asta 39mm sola
31201-39	Asta 39mm completa
31203-00	Asta 39mm completa + lama per sega Ø 50mm
31203-10	Asta 39mm completa + lama per sega Ø 65mm
31204-00	Asta 39mm completa + lama per sega a segmento 50/65mm
31204-10	Asta 39mm completa + lama per sega a segmento 65/65mm
31210-10	Asta 39mm completa + lama per sega Ø 65mm + disco eccentrico
31206-00	Asta 39mm completa + lama a taglio di profondità 8mm
31205-00	Asta 39mm completa + lama a taglio di profondità 20mm
31200-58	Asta 58mm sola
31201-58	Asta 58mm completa
31203-20	Asta 58mm completa + lama per sega Ø 50mm
31203-30	Asta 58mm completa + lama per sega Ø 65mm
31204-20	Asta 58mm completa + lama per sega a segmento 50/65mm
31204-30	Asta 58mm completa + lama per sega a segmento 65/65mm
31210-00	Asta 58mm completa + lama per sega Ø 65mm + disco eccentrico
31206-10	Asta 58mm completa + lama a taglio di profondità 8mm
31205-10	Asta 58mm completa + lama a taglio di profondità 20mm
31200-70	Sega a doppia lama sola
31201-70	Sega a doppia lama completa
31202-00	Sega a doppia lama completa + lama per sega Ø 45mm + lame per sega regolabile Ø 45mm
31201-45	lame per sega regolabile Ø 45mm completa
31200-96	tornillo con hembra hexagonal para hoja de sierra ajustable Ø 45mm completa
31200-98	brugola per asta
31200-99	anello di ricambio per asta

Oszillierende Gipssäge
Oscillating Plaster Saw
Sierra oscilante p. vendajes enyesados
Sega oscillante per gessi

Geräuschpegel: 52 - 77 db (A)
Noise level: 52 - 77 db (A)
Nivel de ruido del aparato sólo: 52 - 77 db (A)
Livello acustico dello strumento solo: 52 - 77 db (A)

6500-24000 Schwingungen pro Minute
6500-24000 oscillations per minute
6500-24000 oscilaciones por minuto
6500-24000 oscillazioni al minute

EN 60601-1, EN 60601-1-2, IEC 60601-1, IEC 60601-1-2



31210-21 120 Volt, 500 Watt, 1,5 kg

31210-22 230 Volt, 500 Watt, 1,5 kg

31210-21 + 31210-22 inklusive, inclusive, inclusive, inclusive:

1x 31210-50 Ø 50mm Sägeblatt, saw blade, hoja de repuesto, lama per sega

1x 31210-65 Ø 65mm Sägeblatt, saw blade, hoja de repuesto, lama per sega

1x 31212-02 Paar Gabelschlüssel, pair flat wrench, pareja llave de boca, paio chiave a bocca, 11mm

Zubehör für oszillierende Gipssäge 31210-22 und 31210-21 siehe Seite 230/14 - 230/18
Accessories for oscillating plaster saw 31210-22 and 31210-21 please see page 230/14 - 230/18
Accesorios p. sierra oscilante p. vendajes enyesados 31210-22 y 31210-21 vea la página 230/14 - 230/18
Accessorio per sega oscillante per gessi 31210-22 e 31210-21 vedi pagina 230/14 - 230/18

- 31212-02 1 Paar Gabelschlüssel, pair flat wrench, pareja llave de boca, paio chiave a bocca, 11mm
31210-30 Koffer, case, maleta, valigia

Naturgipsverbände / bandage / vendajes enyesados / bandaggio in gesso

- 31210-45 Ø 45mm Sägeblatt, saw blade, hoja de repuesto, lama per sega
31210-50 Ø 50mm Sägeblatt, saw blade, hoja de repuesto, lama per sega
31210-65 Ø 65mm Sägeblatt, saw blade, hoja de repuesto, lama per sega
31204-01 Ø 50/65mm Segment-Sägeblatt, segment saw blade, hoja de repuesto para segmento, lama per sega a segmento
31204-03 Ø 65/65mm Segment-Sägeblatt, segment saw blade, hoja de repuesto para segmento, lama per sega a segment
31205-08 8mm Tiefen-Sägeblatt, deep cutting saw, hoja de sierra de profundidad, lama a taglio di profondità
31205-20 20mm Tiefen-Sägeblatt, deep cutting saw, hoja de sierra de profundidad, lama a taglio di profondità

synthetische Hartverbände / synthetic bandage / vendajes sinteticos / bandaggio sintetico

- 31211-45 Ø 45mm Sägeblatt, saw blade, hoja de repuesto, lama per sega
31211-50 Ø 50mm Sägeblatt, saw blade, hoja de repuesto, lama per sega
31211-65 Ø 65mm Sägeblatt, saw blade, hoja de repuesto, lama per sega
31204-02 Ø 50/65mm Segment-Sägeblatt, segment saw blade, hoja de repuesto para segmento, lama per sega a segmento
31204-04 Ø 65/65mm Segment-Sägeblatt, segment saw blade, hoja de repuesto para segmento, lama per sega a segment
31205-09 8mm Tiefen-Sägeblatt, deep cutting saw, hoja de sierra de profundidad, lama a taglio di profondità
31205-21 20mm Tiefen-Sägeblatt, deep cutting saw, hoja de sierra de profundidad, lama a taglio di profondità

PTFE synthetische Hartverbände / PTFE synthetic bandage / PTFE vendajes sinteticos / PTFE bandaggio sintetico

- 31212-50 Ø 50mm Sägeblatt, saw blade, hoja de repuesto, lama per sega
31212-65 Ø 65mm Sägeblatt, saw blade, hoja de repuesto, lama per sega

Naturgipsverbände und synthetische Hartverbände / Bandage and synthetic bandage / Vendajes enyesados y vendajes sinteticos / Bandaggio in gesso e bandaggio sintetico

- 31203-50 Begrenzungsscheibe, limiting disc, disco de tope, disco eccentrico

Oszillierende Gipssäge
Oscillating Plaster Saw
Sierra oscilante p. vendajes enyesados
Sega oscillante per gessi

Geräuschpegel: 52 - 77 db (A)
Noise level: 52 - 77 db (A)
Nivel de ruido del aparato sólo: 52 - 77 db (A)
Livello acustico dello strumento solo: 52 - 77 db (A)

10000-19000 Schwingungen pro Minute
10000-19000 oscillations per minute
10000-19000 oscilaciones por minuto
10000-19000 oscillazioni al minute

EN 60601-1, EN 60601-1-2, IEC 60601-1, IEC 60601-1-2



Blue Power

31220-21	120 Volt, 210 Watt, 1,25 kg
31220-22	230 Volt, 210 Watt, 1,25 kg

31220-21 + 31220-22 inklusive, inclusive, inclusive, inclusive:

- 1x 31210-50 Ø 50mm Sägeblatt, saw blade, hoja de repuesto, lama per sega
- 1x 31210-65 Ø 65mm Sägeblatt, saw blade, hoja de repuesto, lama per sega
- 1x 31212-02 Paar Gabelschlüssel, pair flat wrench, pareja llave de boca, paio chiave a bocca, 11mm

Zubehör für oszillierende Gipssäge 31220-22 und 31220-21 siehe Seite 231/2
Accessories for oscillating plaster saw 31220-22 and 31220-21 please see page 231/2
Accesorios p. sierra oscilante p. vendajes enyesados 31220-22 y 31220-21 vea la página 231/2
Accessorio per sega oscillante per gessi 31220-22 e 31220-21 vedi pagina 231/2

- 31212-02 1 Paar Gabelschlüssel, pair flat wrench, pareja llave de boca, paio chiave a bocca, 11mm
- 31210-30 Koffer, case, maleta, valigia
- 31220-99 Filtervlies, woven filter, filtro de vellón, filtro vello
10 Stück, 10 pieces, 10 piezas, 10 pezzi

Naturgipsverbände / bandage / vendajes enyesados / bandaggio in gesso

- 31210-45 Ø 45mm Sägeblatt, saw blade, hoja de repuesto, lama per sega
- 31210-50 Ø 50mm Sägeblatt, saw blade, hoja de repuesto, lama per sega
- 31210-65 Ø 65mm Sägeblatt, saw blade, hoja de repuesto, lama per sega
- 31204-01 Ø 50/65mm Segment-Sägeblatt, segment saw blade, hoja de repuesto para segmento, lama per sega a segmento
- 31204-03 Ø 65/65mm Segment-Sägeblatt, segment saw blade, hoja de repuesto para segmento, lama per sega a segment
- 31205-08 8mm Tiefen-Sägeblatt, deep cutting saw, hoja de sierra de profundidad, lama a taglio di profondità
- 31205-20 20mm Tiefen-Sägeblatt, deep cutting saw, hoja de sierra de profundidad, lama a taglio di profondità

synthetische Hartverbände / synthetic bandage / vendajes sinteticos / bandaggio sintetico

- 31211-45 Ø 45mm Sägeblatt, saw blade, hoja de repuesto, lama per sega
- 31211-50 Ø 50mm Sägeblatt, saw blade, hoja de repuesto, lama per sega
- 31211-65 Ø 65mm Sägeblatt, saw blade, hoja de repuesto, lama per sega
- 31204-02 Ø 50/65mm Segment-Sägeblatt, segment saw blade, hoja de repuesto para segmento, lama per sega a segmento
- 31204-04 Ø 65/65mm Segment-Sägeblatt, segment saw blade, hoja de repuesto para segmento, lama per sega a segment
- 31205-09 8mm Tiefen-Sägeblatt, deep cutting saw, hoja de sierra de profundidad, lama a taglio di profondità
- 31205-21 20mm Tiefen-Sägeblatt, deep cutting saw, hoja de sierra de profundidad, lama a taglio di profondità

PTFE synthetische Hartverbände / PTFE synthetic bandage / PTFE vendajes sinteticos / PTFE bandaggio sintetico

- 31212-50 Ø 50mm Sägeblatt, saw blade, hoja de repuesto, lama per sega
- 31212-65 Ø 65mm Sägeblatt, saw blade, hoja de repuesto, lama per sega

Naturgipsverbände und synthetische Hartverbände / Bandage and synthetic bandage / Vendajes enyesados y vendajes sinteticos / Bandaggio in gesso e bandaggio sintetico

- 31203-50 Begrenzungsscheibe, limiting disc, disco de tope, disco eccentrico

Sägeblätter
Saw blades
Hojas de repuesto
Lame per sega

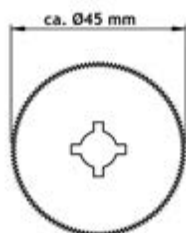

31210-45
31211-45

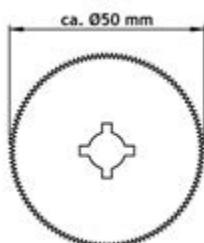

31210-50
31211-50
31212-50

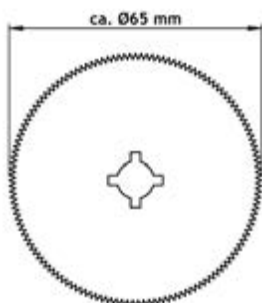

31210-65
31211-65
31212-65

Segment-Sägeblätter
Segment saw blades
Hojas de repuesto para segmento,
Lame per sega a segment

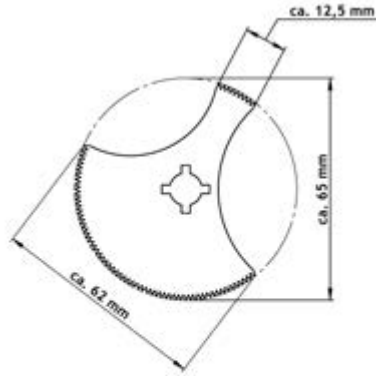

31204-01 Ø 50/65mm
31204-02 Ø 50/65mm

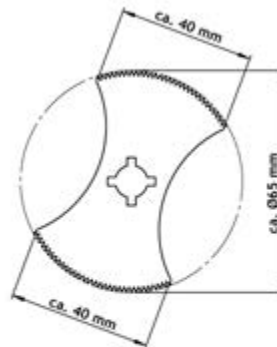
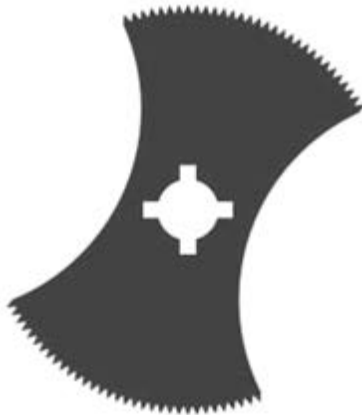

31204-03 Ø 65/65mm
31204-04 Ø 65/65mm

Tiefen-Sägeblätter
 depp cutting saw
 Hojas de sierra de profundidad,
 Lame a taglio di profondità

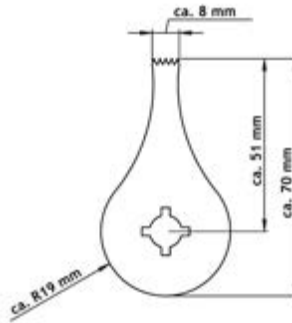

31205-08 8mm
 31205-09 8mm

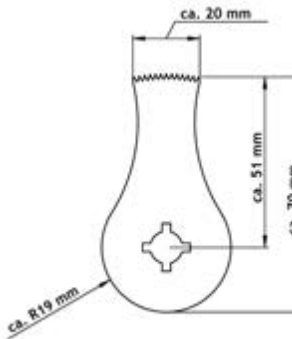

31205-20 20mm
 31205-21 20mm

Sägeblätter
Saw blades
Hojas de repuesto
Lame per sega



31203-50

Begrenzungsscheibe
Limiting disc
Disco de tope
Disco eccentrico

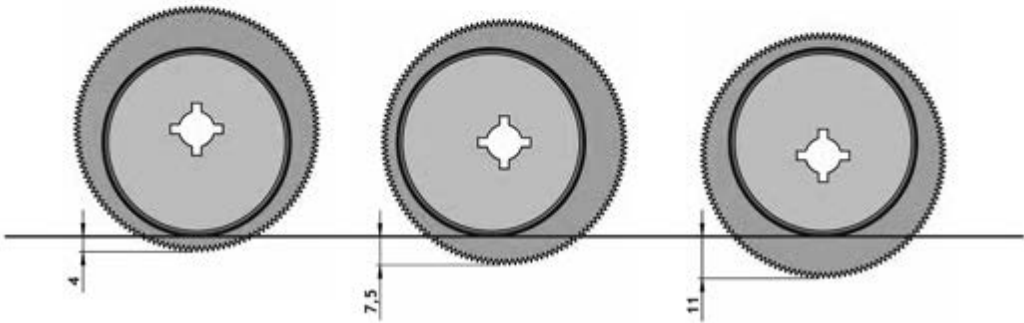

31203-50
für Sägeblatt mit Ø 65mm
for Saw blade with Ø 65mm
para hoja de sierra Ø 65mm
per lama di sega Ø 65mm

31210-65
31204-01
31204-03
31211-65
31204-02
31204-04
31212-65

Zubehör
Accessories
Accessorio
Accessori



31200-95



31202-16



31210-30



31212-02, 11 mm
31202-14, 14 mm



31220-99
10 Stück
10 pieces
10 piezas
10 pezzi

Absauganlage und Wagen ohne Gipsäge
 Hoover and carriage without plaster saw
 Aspirador y careta sin sierra
 Aspirazione e carello senza sega

31252-11 120 Volt, 500 - 1250 Watt (1250 PT), 19 kg

31252-22 230 Volt, 500 - 1200 Watt (1450 PT), 19 kg

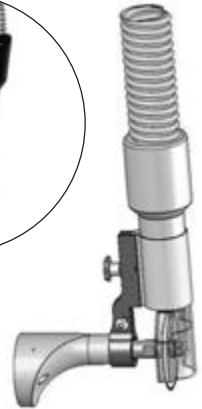

Aufgebaute Einheit
 Set-up unit

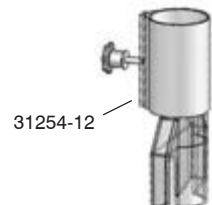
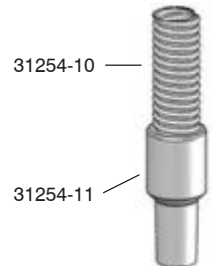

31253-00 230 Volt
 31253-11 120 Volt

Zubehör für 31252-22 und 31252-11
Accessories for 31252-22 and 31252-11
Accesorios para 31252-22 y 31252-11
Accessorio per 31252-22 e 31252-11

- 31253-00 230 Volt, Staubsauger, Hoover, aspirador, aspirapolvere
- 31253-11 120 Volt, Staubsauger, Hoover, aspirador, aspirapolvere
- 31254-10 Saugschlauch 3,3 Meter, schwarz, suction hose 3,3 meter, black, manguera de aspiracion 3,3 metros, negra, tubo di aspirazione 3,3 metri, nera
- 31254-11 Saugdüse schwarz, suction nozzle black, boquilla aspirante negra, ugello aspirante nero
- 31254-12 Saughaube kpl., suction cover cpl., cofia de aspiracion cpl., cuffia di aspirazione cpl.
- 31250-10 Set Filtertüten, set filter paper, set de filtros, set di filtros:
1x 31250-15
6x 31250-12
6x 31250-14

31250-12



Staubbeutel, Ather, antera, antera

31250-13



Motorfilter, motor filter, filtro para motor, filtro per motore

31250-14



Duftstick, flavor stick, stick de aroma, stick di effluvio

31250-15



HEPA-Filter, HEPA-Filter, filtro HEPA, filtro HEPA,

Gipsspreizer
Plaster Cast Instruments
Instrumentos para vendajes enyesados
Allargagessi

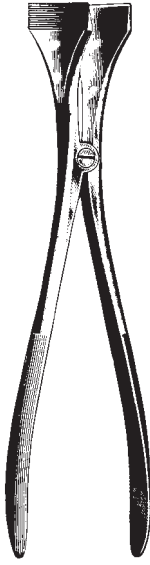

HENNIG
31350-28 28 cm, 11"

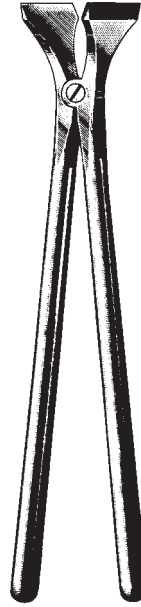

BEESON
31360-30 30 cm, 11 3/4"

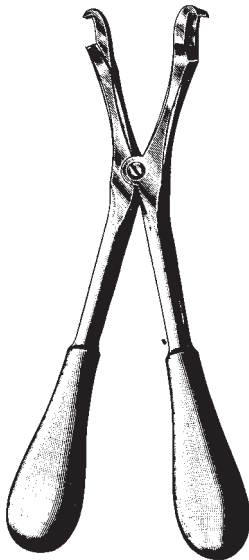

HAGLUND-STILLE
31362-28 28 cm, 11"



REDA
31366-23 23 cm, 9"

Gipsmesser, Gipsabreißzangen
Plaster Cast Instruments, Knives
Instrumentos para vendajes enyesados, Cuchillos
Allargagessi, Coltelli per Gessi, Strappagessi



HOPKINS
31370-20
20 cm, 8"



ESMARCH
31380-18
18 cm, 7"



REINER
31390-18
18 cm, 7"



WOLFF
31395-18
18 cm, 7"



WOLFF
31397-24
24 cm, 9 1/2"

Hohlmeißelzangen
 Bone Rongeurs
 Pinzas-gubias
 Pinze sgorbie

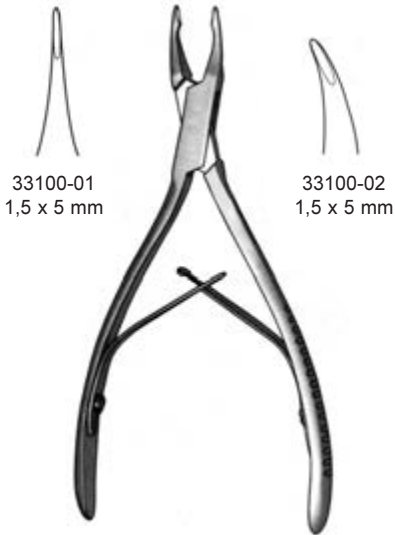

33100-01
 1,5 x 5 mm

33100-02
 1,5 x 5 mm

MICRO FRIEDMAN
 14 cm, 5 1/2"



2 mm

FRIEDMAN Mini
 33101-12 12 cm, 4 3/4"



3,5 mm

FRIEDMAN
 33101-14 14 cm, 5 1/2"

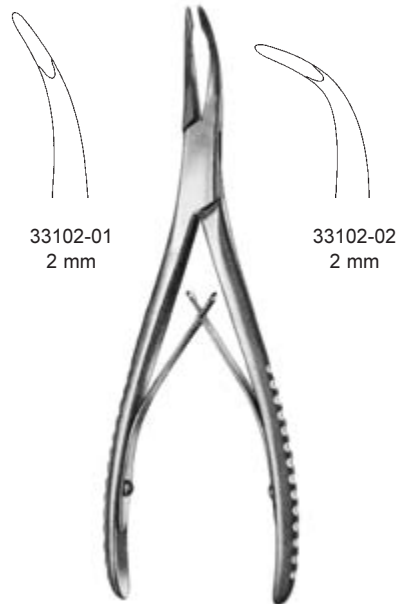

33102-01
 2 mm

33102-02
 2 mm

STELLBRINK
 17 cm, 6 3/4"

Hohlmeißelzangen
Bone Rongeurs
Pinzas-gubias
Pinze sgorbie



CLEVELAND
33103-14 14 cm, 5 1/2"

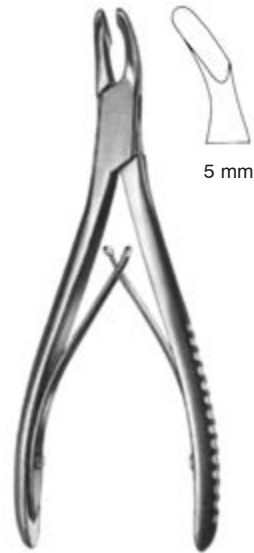

CLEVELAND
33105-17 17 cm, 6 3/4"



MEAD
33107-16 16,5 cm, 6 1/2"

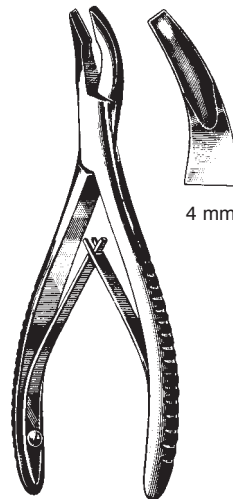

MEAD
33109-16 16,5 cm, 6 1/2"

Hohlmeißelzangen
 Bone Rongeurs
 Pinzas-gubias
 Pinze sgorbie

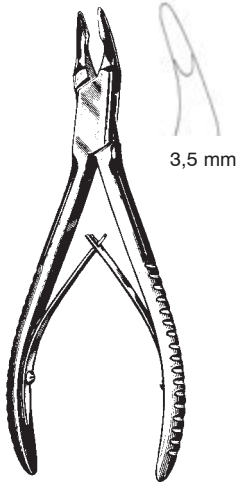

3,5 mm

BLUMENTHAL
 33115-15
 15,5 cm, 6"

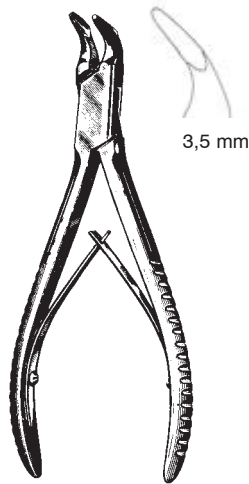

3,5 mm

BLUMENTHAL
 33117-15
 15,5 cm, 6"

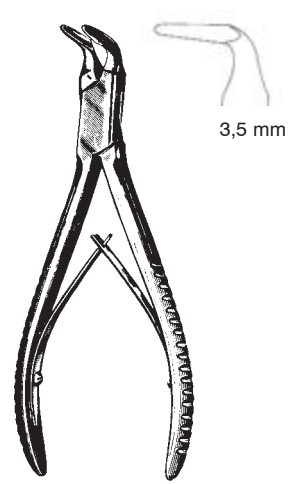

3,5 mm

BLUMENTHAL
 33119-15
 15,5 cm, 6"



4,5 mm

LUER
 33131-15
 15 cm, 5,9"



4 mm

LUER
 33133-15
 15 cm, 5,9"

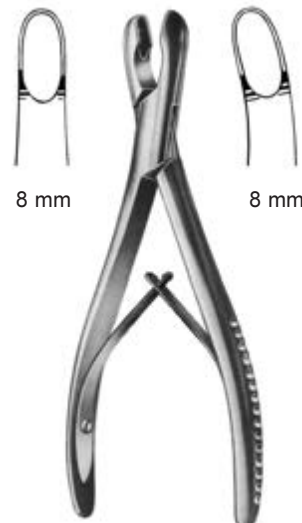

8 mm

8 mm

— LUER —
 33136-17 33137-17
 17 cm, 6 3/4"



9 mm

— ADSON —
 33142-20 33143-20
 20 cm, 7,9"

Hohlmeißelzangen
 Bone Rongeurs
 Pinzas-gubias
 Pinze sgorbie



OLIVECRONA
 33147-20
 20 cm, 7.9"



BANE-HARTMANN
 33148-18
 17,5 cm, 7"



LEMPERT
 33150-16 33151-16
 16 cm, 6 1/4"

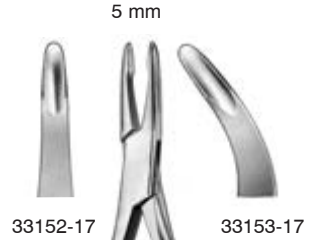

33152-17 33153-17

JANSEN
 17 cm, 6 3/4"



LEMPERT
 33154-18 33155-18
 18,5 cm, 7 1/4"



BEYER
 33156-18
 18 cm, 7"

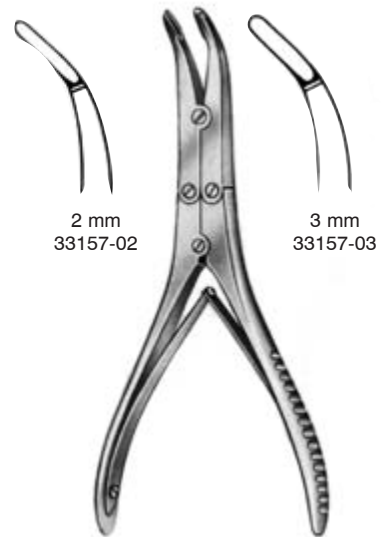

KLEINERT-KUTZ
 15 cm, 6"

Hohlmeißelzangen
 Bone Rongeurs
 Pinzas-gubias
 Pinze sgorbie



3 mm
33157-04



4 mm
33157-05



5 mm
33157-06



3 mm
33158-03



4 mm
33158-04



5 mm
33158-05



3 mm
33159-03



4 mm
33159-04



5 mm
33159-05



SMITH-PETERSEN
24 cm, 9 1/2"



BEYER
33201-18
18 cm, 7"



MAYFIELD
33202-18
18 cm, 7"



ZAUFAL-JANSEN
33205-18
18 cm, 7"



BÖHLER
33211-15 33213-15
15 cm, 6"

Hohlmeißelzangen
 Bone Rongeurs
 Pinzas-gubias
 Pinze sgorbie

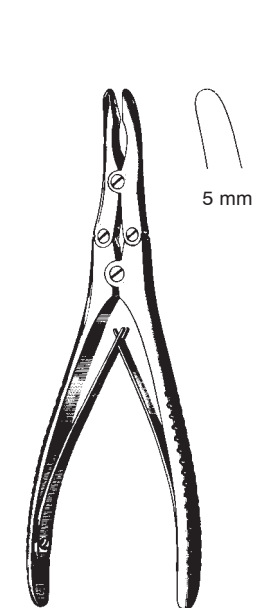

— RUSKIN —
 33216-18 33217-18
 18 cm, 7"

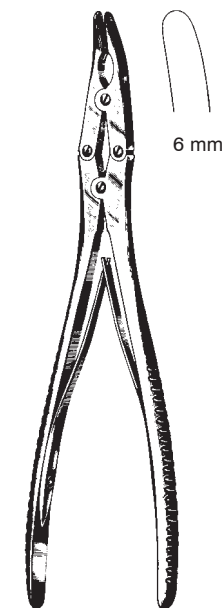

RUSKIN
 33219-23 23 cm, 9"



MARQUARDT
 33220-20 20 cm, 8"

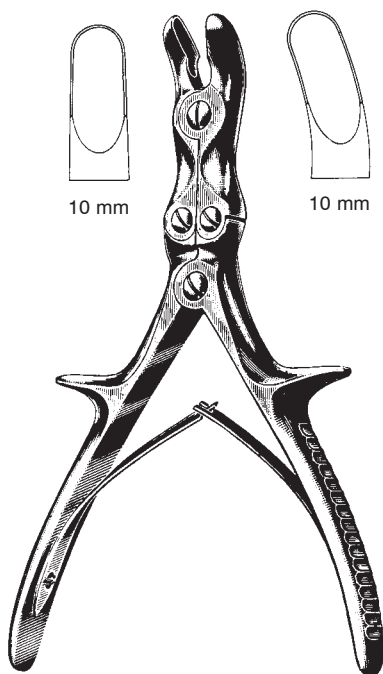

— STILLE-LUER —
 33230-22 22 cm, 8 3/4" 33231-22
 33230-26 26 cm, 10 1/4" 33231-26



STILLE-LUER
 33235-23
 23 cm, 9"



STILLE-RUSKIN
 33237-23
 23 cm, 9"

Hohlmeißelzangen
 Bone Rongeurs
 Pinzas-gubias
 Pinze scorbie

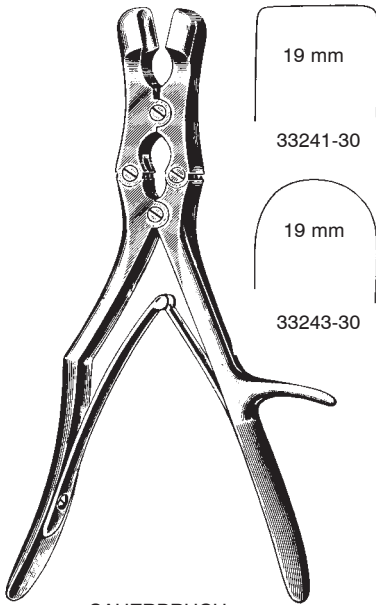

SAUERBRUCH
 30 cm, 10 3/4"

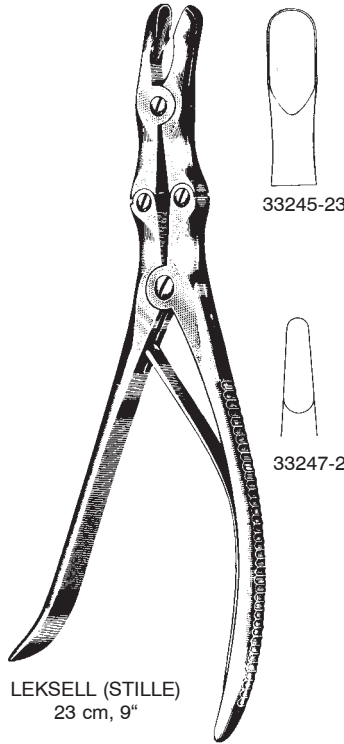
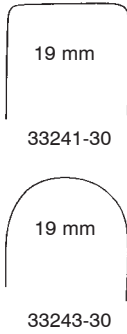

LEKSELL (STILLE)
 23 cm, 9"

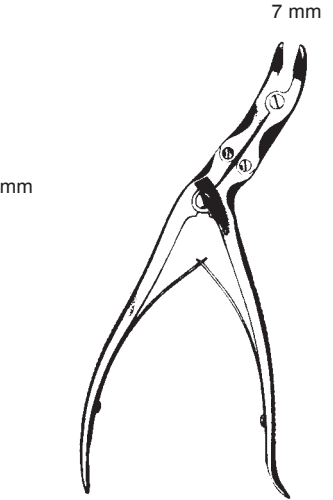

SCAGLIETTI
 33251-26 rechts right derecha a destra
 33253-26 links left izquierda a sinistra
 26 cm, 10 1/4"



ECHLIN
 33257-23 2 mm
 33258-23 4 mm
 33259-23 3 mm
 23 cm, 9"



FRYKHOLM
 33260-24
 24 cm, 9 1/2"



SEMB
 33261-22
 22,5 cm, 8.9"

Knochensplitterzangen
 Bone Cutting Forceps
 Pinzas cortantes para huesos
 Cesioie per ossa

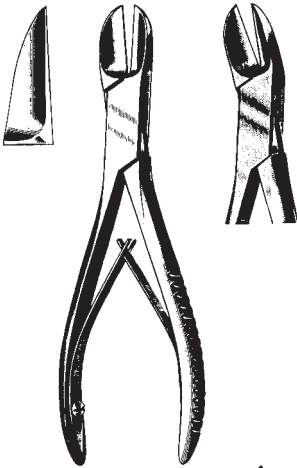

LISTON

- | | | |
|----------|---------------|----------|
| 33274-14 | 14 cm, 5 1/2" | 33275-14 |
| 33274-17 | 17 cm, 6 3/4" | 33275-17 |
| 33274-19 | 19 cm, 7 1/2" | 33275-19 |
| 33274-22 | 22 cm, 8 3/4" | 33275-22 |



BÖHLER

- | | |
|-----------|----------|
| 33280-15 | 33281-15 |
| 15 cm, 6" | |



COTTLE-KAZANJIAN

- | |
|---------------|
| 33282-19 |
| 19 cm, 7 1/2" |



MC INDOE

- | |
|---------------|
| 33283-17 |
| 17 cm, 6 3/4" |



STAMM

- | |
|-----------|
| 33284-15 |
| 15 cm, 6" |

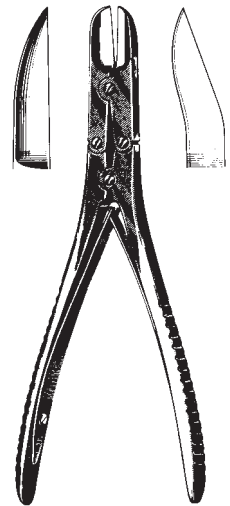

RUSKIN-LISTON

- | | |
|-----------|----------|
| 33286-18 | 33289-18 |
| 18 cm, 7" | |

Knochensplitterzangen
 Bone Cutting Forceps
 Pinzas cortantes para huesos
 Cesioie per ossa

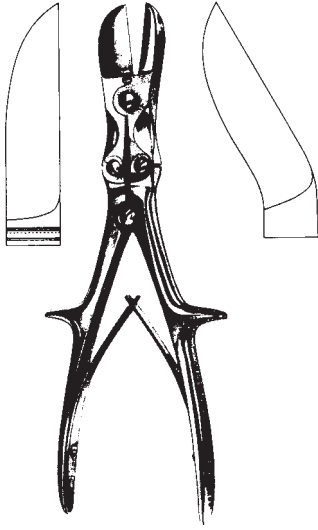

STILLE-LISTON
 33290-23 23 cm, 9" 33291-23
 33290-27 27 cm, 10 1/2" 33291-27



STILLE-LISTON
 33292-26
 26 cm, 10 1/4"

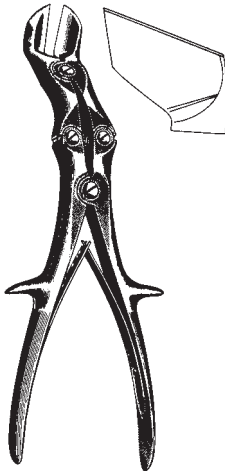

STILLE-HORSLEY
 33293-27
 27 cm, 10 1/2"

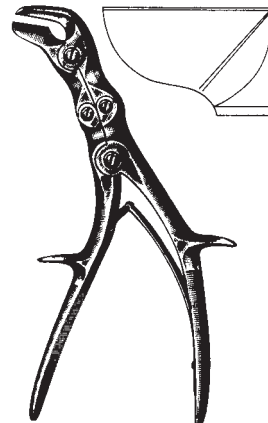

SEMB
 33295-24
 24 cm, 9 1/2"

Knochenhaltezzangen
 Bone Holding Forceps
 Pinzas para huesos
 Tenaglie per ossa

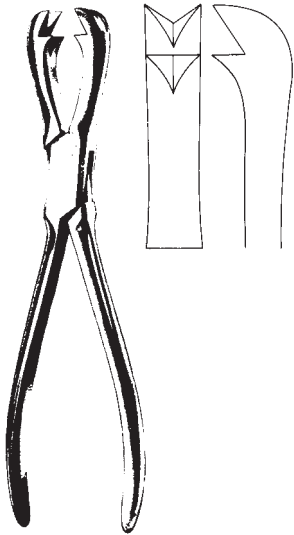

FERGUSON
 33360-21
 21 cm, 8 1/4"

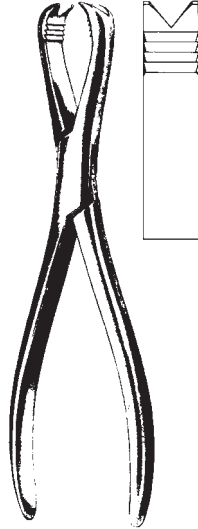

LANGENBECK
 33362-21
 21 cm, 8 1/4"

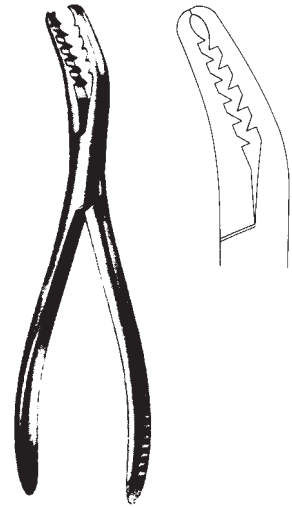

SEMB
 33365-19
 19 cm, 7 1/2"



SEMB
 33366-19
 20 cm, 8"



FARABEUF
 33366-23 23 cm, 9"
 33366-26 26 cm, 10 1/4"



FARABEUF-LAMBOTTE
 33368-26
 26 cm, 10 1/4"

Knochenhalte­zangen
Bone Holding Forceps
Pinzas para huesos
Tenaglie per ossa

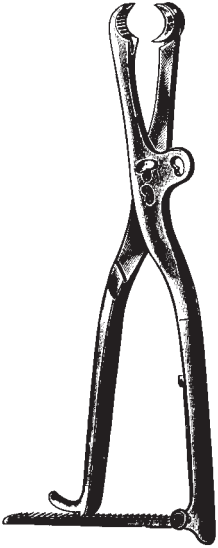

LAMBOTTE

33370-22 22 cm, 8 ³/₄"
33370-27 27 cm, 10 ¹/₂"
33370-30 30 cm, 11 ³/₄"

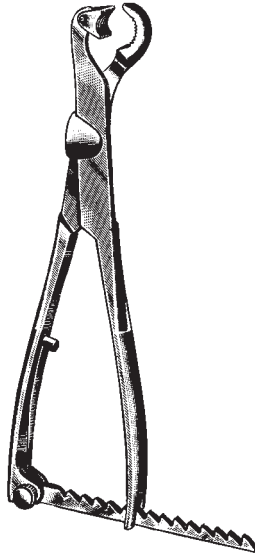

LAMBOTTE

33372-22 22 cm, 8 ³/₄"
33372-26 26 cm, 10 ¹/₄"
33372-33 33 cm, 13"

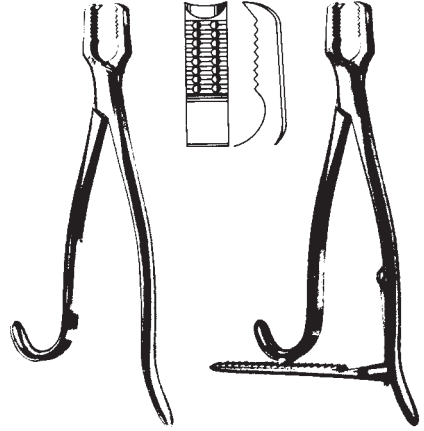

KERN

33378-15 15 cm, 6" 33380-15
33378-17 17 cm, 6 ³/₄" 33380-17
33378-21 21 cm, 8 ¹/₄" 33380-21



LANE

33382-33 33 cm, 13"
33382-45 45 cm, 17 ³/₄"

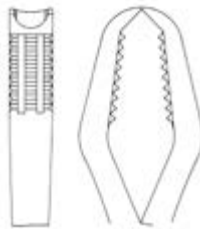

LANE

33384-33 33 cm, 13"
33384-45 45 cm, 17 ³/₄"

Knochenhaltezangen
 Bone Holding Forceps
 Pinzas para huesos
 Tenaglie per ossa

selbstzentrierend
 self-centering
 autocentrantes
 autocentranti

2,5 mm



33391-15
 15 cm, 6"

6,5 mm



33391-19
 19 cm, 7 1/2"

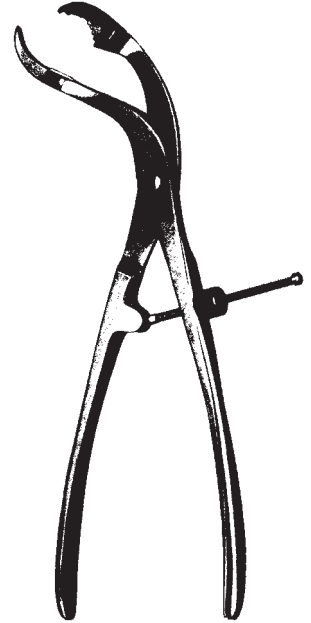

33391-15 - 33391-28

9,5 mm

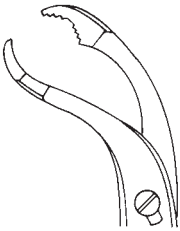

33391-24
 24 cm, 9 1/2"

10 mm

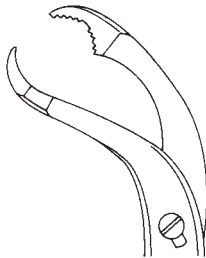

33391-26
 26 cm, 10 1/4"

11 mm

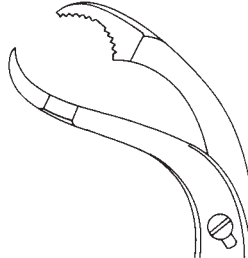

33391-28
 28 cm, 11"

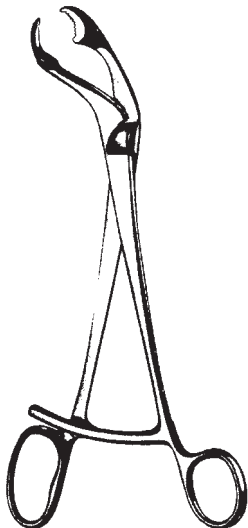

VERBRUGGE
 33395-17 - 33395-27

5 mm



33395-17
 17,5 cm, 7"

9,5 mm

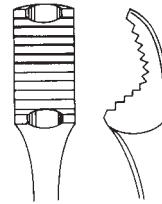

33395-25
 25 cm, 10"

10,5 mm

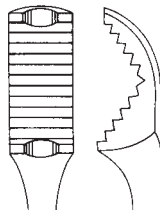

33395-26
 26 cm, 10 1/4"

12 mm

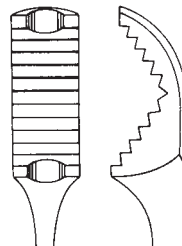

33395-27
 27 cm, 10 1/2"

Knochenhalte­zangen
Bone Holding Forceps
Pinzas para huesos
Tenaglie per ossa

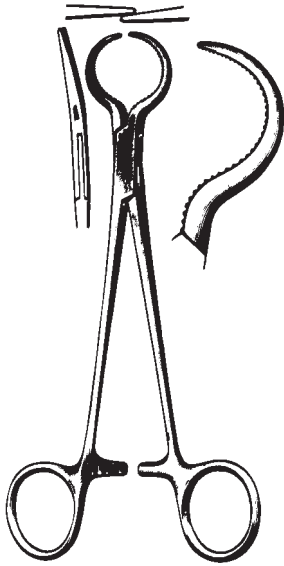

LEWIN
33402-17
17,5 cm, 7"

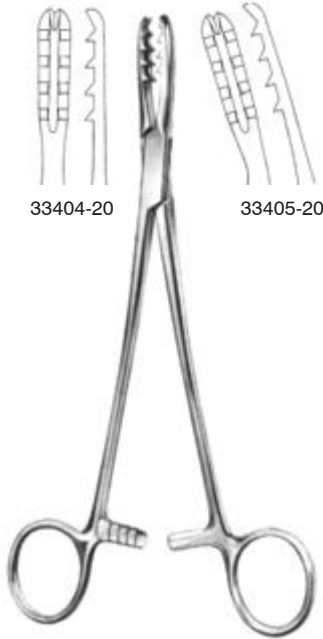

33404-20

33405-20

BIRCHER-GANSKE
20 cm, 8"



33406-20
20 cm, 8"



DINGMANN
33407-19
19 cm, 7 1/2"



REDA
33409-13
13,5 cm, 5 1/4"



MARTIN
33410-19
19 cm, 7 1/2"

Knochenhaltezangen
Bone Holding Forceps
Pinzas para huesos
Tenaglie per ossa



REDA
33412-16 - 33412-24

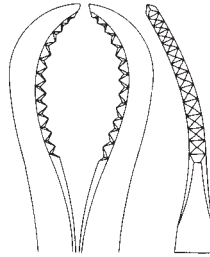

33412-16
16 cm, 6 1/4"

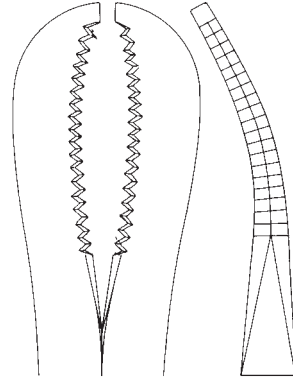

33412-24
24 cm, 9 1/2"

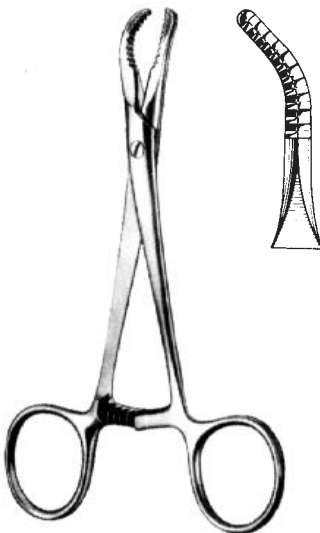

REDA
33413-14
13,5 cm, 5 1/4"



33414-21
21 cm, 8 1/4"

Knochenhalte­zangen
 Bone Holding Forceps
 Pinzas para huesos
 Tenaglie per ossa



ULRICH
 33415-23 - 33415-28

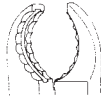

33415-23
 23 cm, 9"

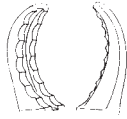

33415-25
 25 cm, 10"



33415-28
 28 cm, 11"

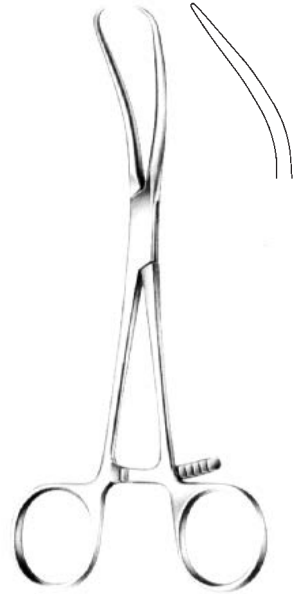

REILL
 33416-17 17 cm, 6 3/4"



PATELLA
 33417-18 18,5 cm, 7 1/4"



MEYER
 33418-17 17 cm, 6 3/4"



MEYER
 33419-20 20,5 cm, 8"

Knochenhaltezaugen, -Klammern
 Bone holding forceps, -Clamps
 Pinzas para huesos, Clamps porta-huesos
 Tenaglie per ossa, Pinze per ossa

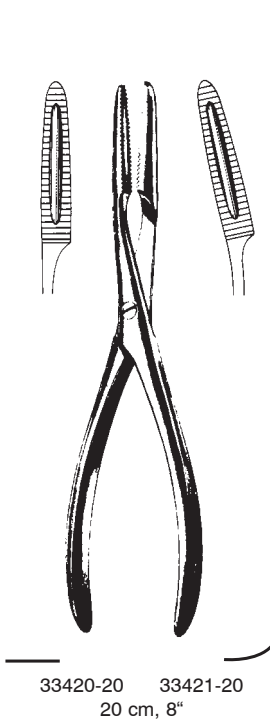

Knochenhalte­zangen, Bleihand
 Bone holding forceps, Lead Hands
 Pinzas para huesos, Manoplas de plomo
 Tenaglie per ossa, Mani di piombo

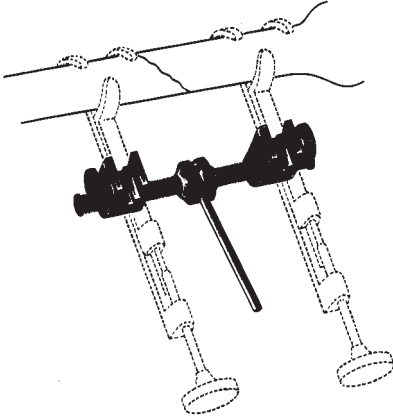

GERSTER
 33444-15



33450-01
 32 cm, 12 ³/₄"
 Erwachsen
 adult size
 p. adultos
 p. adulti

33450-02
 24 cm, 9 ¹/₂"
 Kind
 child size
 p. niños
 p. bambini

Scharfe Löffel
Bone Curettes
Cucharillas cortantes
Curette taglienti

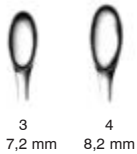
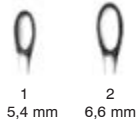

SCHEDE	Fig.	VOLKMANN
	0000	33469-96
33467-97	000	33469-97
33467-98	00	33469-98
33468-00	0	33470-00
33468-01	1	33470-01
33468-02	2	33470-02
33468-03	3	33470-03
33468-04	4	33470-04
	5	33470-05
	6	33470-06

SCHEDE
17 cm, 6 3/4"
33467-97 - 33468-04

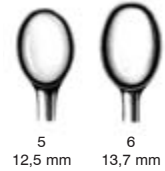

VOLKMANN
17 cm, 6 3/4"
33469-96 - 33470-06

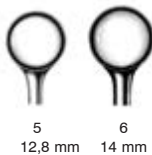

BRUNS	Fig.	SPRATT
33471-96	0000	33474-96
33471-97	000	33474-97
33471-98	00	33474-98
33472-00	0	33475-00
33472-01	1	33475-01
33472-02	2	33475-02
33472-03	3	33475-03
33472-04	4	33475-04
33472-05	5	33475-05
33472-06	6	33475-06

BRUNS
17 cm, 6 3/4"
33471-96 - 33472-06

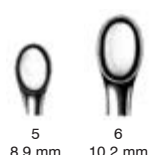
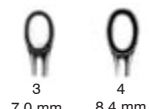
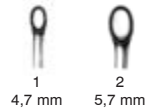
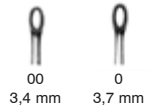
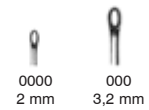

SPRATT
17 cm, 6 3/4"
33474-97 - 33475-06

Scharfe Löffel
 Bone Currettes
 Cucharillas cortantes
 Curette taglienti

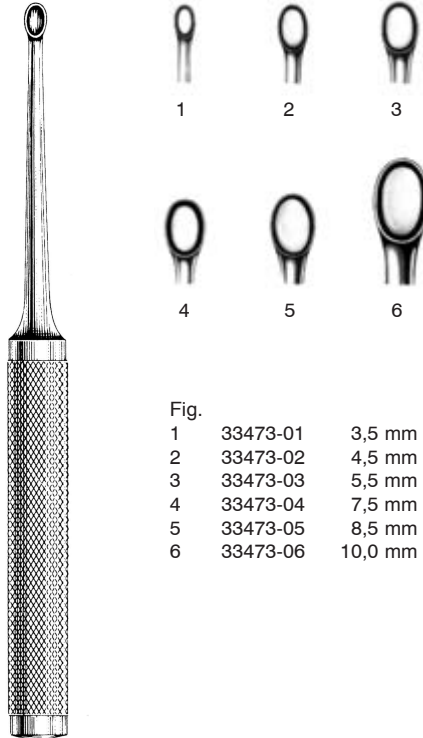

COBB
 27,9 cm 11"

Fig.		
1	33473-01	3,5 mm
2	33473-02	4,5 mm
3	33473-03	5,5 mm
4	33473-04	7,5 mm
5	33473-05	8,5 mm
6	33473-06	10,0 mm

Scharfe Löffel
Bone Currettes
Cucharillas cortantes
Curette taglienti

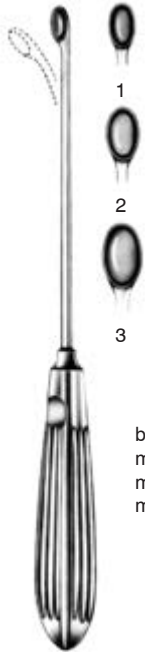

- Fig.
1 33476-01 4,8 mm
2 33476-02 5,8 mm
3 33476-03 6,8 mm

biegsam
malleable
maleable
malleabile

HALLE
21 cm, 8 1/4"

33476-01 - 33476-02



- Fig.
000 33476-98 2,8 mm
00 33476-99 3,3 mm
0 33477-00 3,7 mm
1 33477-01 4,3 mm
2 33477-02 4,8 mm
3 33477-03 5,6 mm
4 33477-04 6,1 mm
5 33477-05 6,7 mm
6 33477-06 8,8 mm

SPINAL
20 cm, 8"

33476-98 - 33477-06

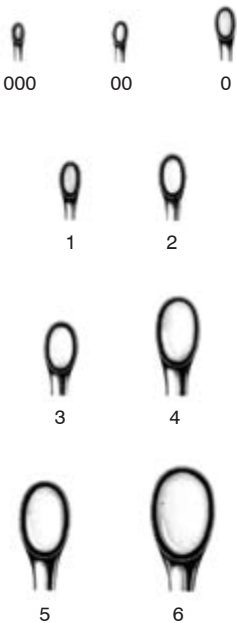

- Fig.
000 33478-98 2,8 mm
00 33478-99 3,3 mm
0 33479-00 3,7 mm
1 33479-01 4,3 mm
2 33479-02 4,8 mm
3 33479-03 5,6 mm
4 33479-04 6,1 mm
5 33479-05 6,7 mm
6 33479-06 8,8 mm



SPINAL
20 cm, 8"

33478-98 - 33479-06

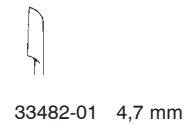

SCOVILLE
25 cm, 10"

33482-01 - 33482-03

Scharfe Löffel
Bone Currettes
Cucharillas cortantes
Curette taglianti

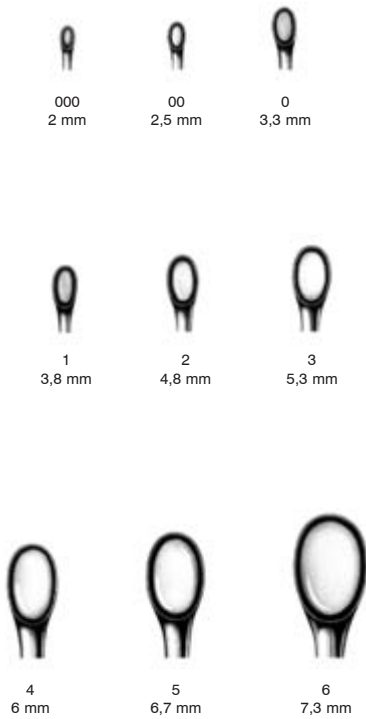

BRUNS
23 cm, 9"



BRUNS
23 cm, 9"



BRUNS
23 cm, 9"

Fig.

000	33480-97	33482-97 2,8 mm	33484-97 2,8 mm
00	33480-98	33482-98 3,3 mm	33484-98 3,3 mm
0	33481-00	33483-00 3,7 mm	33485-00 3,7 mm
1	33481-01	33483-01 4,3 mm	33485-01 4,3 mm
2	33481-02	33483-02 4,8 mm	33485-02 4,8 mm
3	33481-03	33483-03 5,6 mm	33485-03 5,6 mm
4	33481-04	33483-04 6,1 mm	33485-04 6,1 mm
5	33481-05	33483-05 6,7 mm	33485-05 6,7 mm
6	33481-06	33483-06 8,8 mm	33485-06 8,8 mm

Scharfe Löffel
Bone Curettes
Cucharillas cortantes
Curette taglienti



33485-21 21 cm, 8 1/4"
oval/rund
ovale/ronde
ovalado/redondo
ovale/rotonda



WILLIGER
17,5 cm
7"

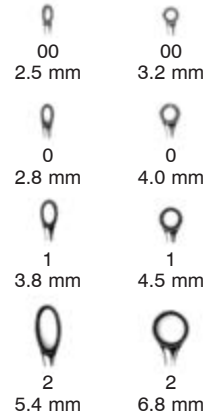

Fig. 00	33485-99	33486-99
0	33486-00	33487-00
1	33486-01	33487-01
2	33486-02	33487-02



DAUBENSPECK Fig. 00 33487-99
20 cm, 8" 0 33488-00
1 33488-01
2 33488-02



27 cm Fig. 0 33489-00
10 1/2" 1 33489-01
2 33489-02
3 33489-03



Scharfe Löffel
 Bone Currettes
 Cucharillas cortantes
 Curette taglianti



LEMPERT
 17,5 cm, 7"



0



00



000



0000



00000

Fig. 0	33490-10	3,3 mm
00	33490-20	3,0 mm
000	33490-30	2,7 mm
0000	33490-40	2,4 mm
00000	33490-50	2,0 mm



REDA
 25 cm, 10"



000
 3,6 mm



00
 4,4 mm

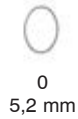

0
 5,2 mm



1
 6,8 mm



REDA
 25 cm, 10"



000
 3,6 mm



00
 4,4 mm



0
 5,2 mm

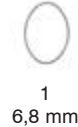

1
 6,8 mm

Fig. 000	33491-01
00	33491-02
0	33491-03
1	33491-04



BUSHE
 25 cm, 10"

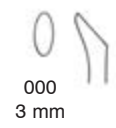

000
 3 mm



00
 4 mm



0
 5 mm

Fig. 000	33500-01
00	33500-02
0	33500-03

Fig. 000	33491-05
00	33491-06
0	33491-07
1	33491-08

Scharfe Löffel
Bone Curettes
Cucharillas cortantes
Curette taglienti

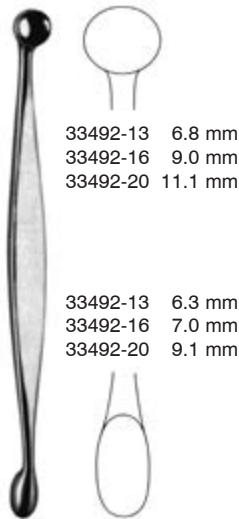

33492-13 6.8 mm
33492-16 9.0 mm
33492-20 11.1 mm

33492-13 6.3 mm
33492-16 7.0 mm
33492-20 9.1 mm

VOLKMANN

33492-13 13 cm, 5 1/8"
33492-16 16 cm, 6 1/4"
33492-20 20 cm, 8"

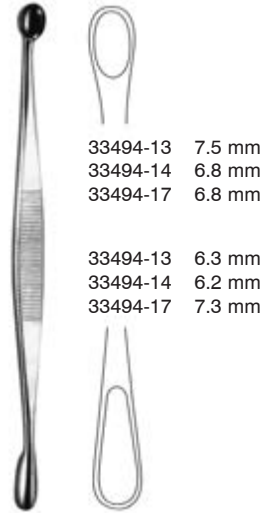

33494-13 7.5 mm
33494-14 6.8 mm
33494-17 6.8 mm

33494-13 6.3 mm
33494-14 6.2 mm
33494-17 7.3 mm

VOLKMANN

33494-13 13 cm, 5 1/8"
33494-14 14 cm, 5 1/2"
33494-17 17 cm, 6 3/4"



5.2 mm

3.5 mm

JANSE

33495-16
16 cm, 6 1/4"

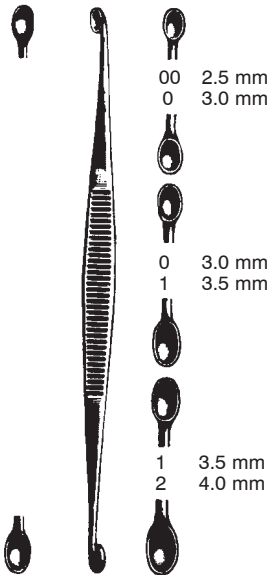

00 2.5 mm
0 3.0 mm

0 3.0 mm
1 3.5 mm

1 3.5 mm
2 4.0 mm

WILLIGER

13,5 cm, 5 1/4" Fig.
33496-00 00/0
33496-01 0/1
33496-12 1/2

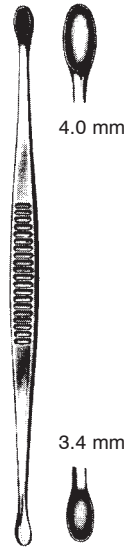

4.0 mm

3.4 mm

JACOBSON

13 cm, 5 1/8"
33497-00

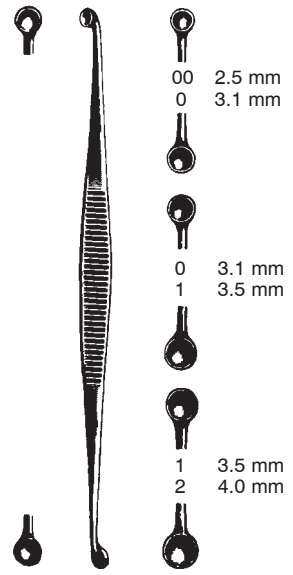

00 2.5 mm
0 3.1 mm

0 3.1 mm
1 3.5 mm

1 3.5 mm
2 4.0 mm

MARTINI

13,5 cm, 5 1/4"
33498-00
33498-01
33498-12

Stößel
Hemostats
Hemostáticos
Pistoni



CASPAR
200 mm, 8"

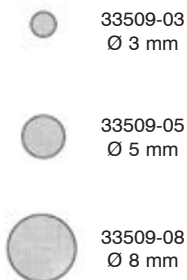

200 mm, 8"

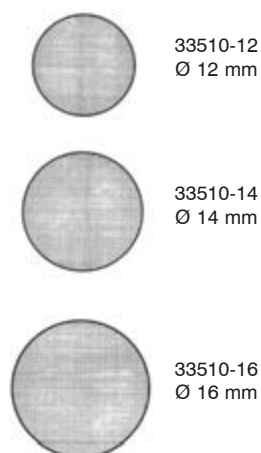

Stößel, Flachmeißel, Hohlmeißel, Osteotome
 Hemostats, Chisels, Gouges, Osteotome
 Hemostáticos, Cinceles, Gubias, Osteótomo
 Pistoni, scalpelli, sgorbie, Osteotomia

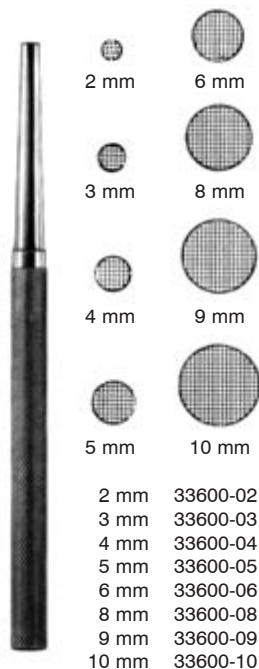

16 cm, 6 1/4"

2 mm	33600-02
3 mm	33600-03
4 mm	33600-04
5 mm	33600-05
6 mm	33600-06
8 mm	33600-08
9 mm	33600-09
10 mm	33600-10



13,5 cm, 5 1/4"

4 mm	33602-04
6 mm	33602-06
8 mm	33602-08
10 mm	33602-10
12 mm	33602-12
14 mm	33602-14
16 mm	33602-16



13,5 cm, 5 1/4"

33604-04
33604-06
33604-08
33604-10
33604-12
33604-14
33604-16



13,5 cm, 5 1/4"

33605-04
33605-06
33605-08
33605-10
33605-12
33605-14
33605-16

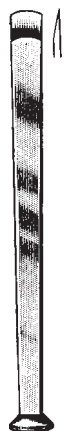
 ALEXANDER
 17 cm, 6 3/4"

33610-04	4 mm
33610-06	6 mm
33610-08	8 mm
33610-10	10 mm
33610-12	12 mm
33610-14	14 mm

 ALEXANDER
 17 cm, 6 3/4"

33611-04	4 mm
33611-06	6 mm
33611-08	8 mm
33611-10	10 mm
33611-12	12 mm
33611-14	14 mm



 PARTSCH
 13,5 cm, 5 1/4" mm 17 cm, 6 3/4"

33620-02	2	33622-02
33620-03	3	33622-03
33620-04	4	33622-04
33620-05	5	33622-05
33620-06	6	33622-06
33620-07	7	33622-07
33620-08	8	33622-08

 PARTSCH
 13,5 cm, 5 1/4" mm 17 cm, 6 3/4"

33623-02	2	33625-02
33623-03	3	33625-03
33623-04	4	33625-04
33623-05	5	33625-05
33623-06	6	33625-06
33623-07	7	33625-07
33623-08	8	33625-08

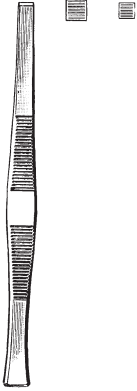
Flachmeißel, Hohlmeißel, Osteotome
 Chisels, Gouges, Osteotome
 Cinceles, Gubias, Osteótomo
 Scalpelli, sgorbie, Osteotomia



PASSOW
 12 cm, 4 3/4"
 33626-35 3,5 mm
 33626-25 2,5 mm



BRÜNING-S-LUCAS
 16 cm, 6 1/4"
 33627-04 4 mm
 33627-06 6 mm

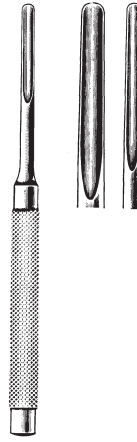

BRÜNING-S-LUCAS
 16 cm, 6 1/4"
 33628-03 3 mm
 33628-05 5 mm



STILLE
 20 cm, 8"
 33630-06 6 mm
 33630-08 8 mm
 33630-10 10 mm
 33630-12 12 mm
 33630-15 15 mm
 33630-20 20 mm
 33630-25 25 mm
 33630-30 30 mm



STILLE
 20 cm, 8"

	6 mm
	8 mm
33631-10	10 mm
33631-12	12 mm
33631-15	15 mm
33631-20	20 mm
33631-25	25 mm
33631-30	30 mm



STILLE
 20 cm, 8"

33632-06	6 mm
33632-08	8 mm
33632-10	10 mm
33632-12	12 mm
33632-15	15 mm
33632-20	20 mm
33632-25	25 mm
33632-30	30 mm



STILLE
 20 cm, 8"

33633-06	6 mm
33633-08	8 mm
33633-10	10 mm
33633-12	12 mm
33633-15	15 mm
33633-20	20 mm
33633-25	25 mm
33633-30	30 mm



STILLE
 20 cm, 8"

33634-06	6 mm
33634-08	8 mm
33634-10	10 mm
33634-12	12 mm
33634-15	15 mm
33634-20	20 mm
33634-25	25 mm
33634-30	30 mm

Osteotome, Hohlmeißel
 Osteotome, Gouges
 Osteótomo, Gubias
 Osteotomia, sgorbie

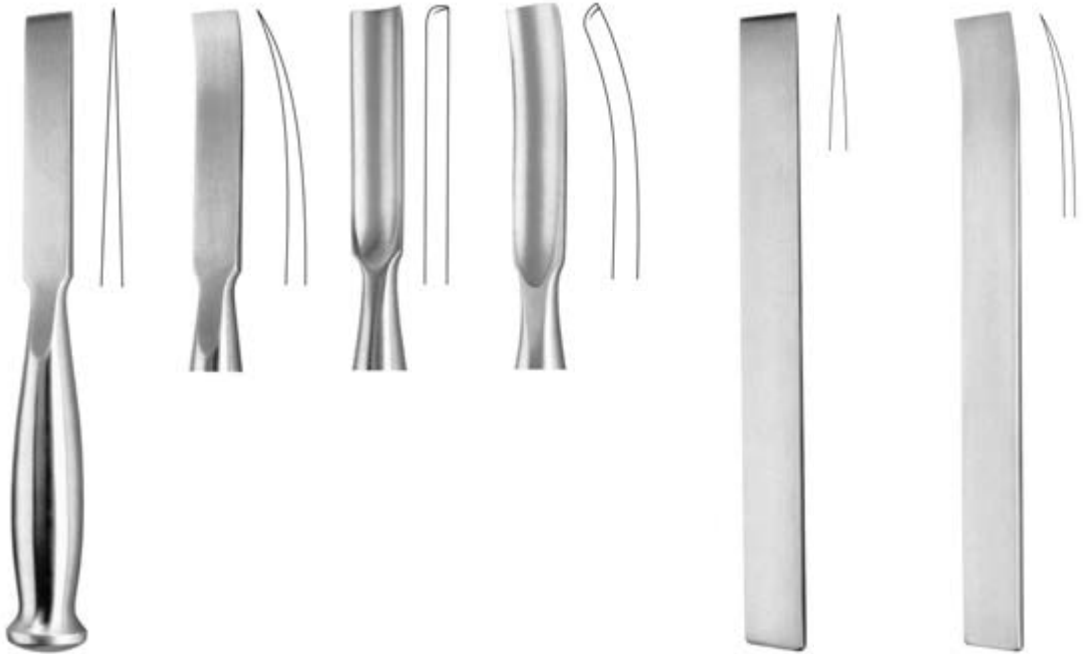

SMITH-PETERSEN
 20 cm, 8"

6 mm	33644-06	33645-06	33647-06	
9 mm	33644-09	33645-09	33647-09	33649-09
13 mm	33644-13	33645-13		
14 mm			33647-14	33649-14
16 mm	33644-16	33645-16	33647-16	33649-16
19 mm	33644-19	33645-19	33647-19	33649-19
25 mm	33644-25	33645-25	33647-25	33649-25
32 mm	33644-32	33645-32	33647-32	33649-32

LAMBOTTE
 24 cm, 9 1/2" 23 cm, 9"

33650-04	4 mm	33651-04
33650-06	6 mm	33651-06
33650-08	8 mm	33651-08
33650-10	10 mm	33651-10
33650-13	13 mm	33651-13
33650-16	16 mm	33651-16
33650-18	18 mm	33651-18
33650-20	20 mm	33651-20
33650-25	25 mm	33651-25
33650-30	30 mm	33651-30
33650-38	38 mm	33651-38
33650-44	44 mm	33651-44
33650-50	50 mm	33651-50

Osteotome, Hohlmeißel
 Osteotome, Chisels, Gouges
 Osteótomo, Cinceles, Gubias
 Osteotomia, Scalpelli, sgorbie

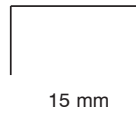
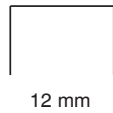

12,5 cm, 5"	mm	17 cm, 6 3/4"
33654-02	2	33652-02
33654-03	3	33652-03
33654-04	4	33652-04
33654-06	6	33652-06
33654-08	8	33652-08
33654-10	10	33652-10
33654-12	12	33652-12
33654-15	15	33652-15

MINI-LAMBOTTE

8 mm



COBB
 28 cm, 11"
 33656-28

8 mm



COBB
 28 cm, 11"
 33657-28

8 mm



COBB
 28 cm, 11"
 33658-28

8 mm



COBB
 28 cm, 11"
 33659-28

mit Ferrozellgriff
 with Ferrozell-Handle
 con mango de Ferrozell
 con manico di Ferrozell

Osteotome und Hohlmeißel mit Ferrozell-Griff
 Osteotome and Gouges with Ferrozell-Handle
 Osteótomo, Gubias con mango de Ferrozell
 Osteotomo, con manico di Ferrozell



LEXER
 22 cm, 8 3/4"

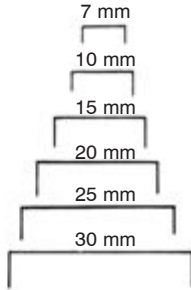

33660-07	7 mm	33661-07
33660-10	10 mm	33661-10
33660-15	15 mm	33661-15
33660-20	20 mm	33661-20
33660-25	25 mm	33661-25
33660-30	30 mm	33661-30

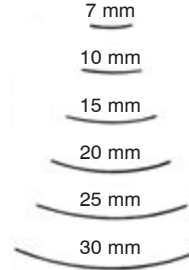

LEXER
 22 cm, 8 3/4"



LEXER MINI
 18 cm, 7"

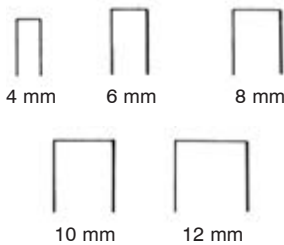

33664-04	4 mm	33665-04
33664-06	6 mm	33665-06
33664-08	8 mm	33665-08
33664-10	10 mm	33665-10
33664-12	12 mm	33665-12

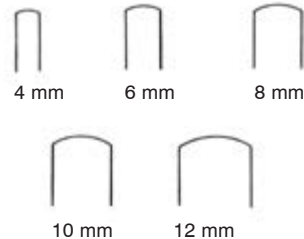

LEXER MINI
 18 cm, 7"

Flachmeißel, Hohlmeißel
 Chisels, Gouges
 Cinceles, Gubias
 Scalpelli, sgorbie



20 mm



16 mm

mit Ferrozellgriff
 with Ferrozell-Handle
 con mango de Ferrozell
 con manico di Ferrozell

33665-24
 24,5 cm, 9 3/4"

33665-26
 26,5 cm, 10 1/2"



9 mm



mit NOVOTEX-Griff
 with Novotex-Handle
 con mango de Novotex
 con manico di Novotex

ZIELKE 23 cm, 9"
 33665-55 5,5 mm
 33665-90 9,0 mm

22 cm, 8 3/4"
 33666-22

—	25 cm, 10"	⌒
33669-05	5 mm	33670-05
33669-10	10 mm	33670-10
33669-15	15 mm	33670-15

Osteotome, Flachmeißel, Hohlmeißel
 Osteotome, Chisels, Gouges
 Osteótomo, Cinceles, Gubias
 Osteotomia, Scalpelli, Sgorbie

HOKE

14 cm, 5 1/2"

33668-03	3 mm
33668-05	5 mm
33668-06	6 mm
33668-08	8 mm
33668-09	9 mm
33668-13	13 mm
33668-16	16 mm
33668-19	19 mm

HIBBS

24 cm, 9 1/2"

33670-06	6 mm
33670-09	9 mm
33670-13	13 mm
33670-16	16 mm
33670-19	19 mm
33670-25	25 mm
33670-32	32 mm

HIBBS

24 cm, 9 1/2"

33671-06	6 mm
33671-09	9 mm
33671-13	13 mm
33671-16	16 mm
33671-19	19 mm
33671-25	25 mm
33671-32	32 mm

HIBBS

24 cm, 9 1/2"

33672-06	6 mm
33672-09	9 mm
33672-13	13 mm
33672-16	16 mm
33672-19	19 mm
33672-25	25 mm
33672-32	32 mm

HIBBS

24 cm, 9 1/2"

33673-06	6 mm
33673-09	9 mm
33673-13	13 mm
33673-16	16 mm
33673-19	19 mm
33673-25	25 mm
33673-32	32 mm

HIBBS

24 cm, 9 1/2"

33675-06	6 mm
33675-09	9 mm
33675-13	13 mm
33675-16	16 mm
33675-19	19 mm
33675-25	25 mm
33675-32	32 mm

Meißel
Chisels
Cinceles
Scalpelli

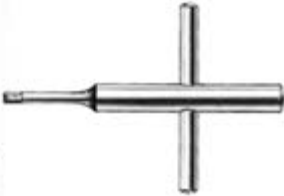

33676-02
9 cm, 3 1/2"
Spannschlüssel
Key
Llave
Clé
Chiave



5 mm
33676-05
8,5 mm, 3.4"



10 mm
33676-10
8,5 mm, 3.4"



16 mm
33676-16
8,5 mm, 3.4"

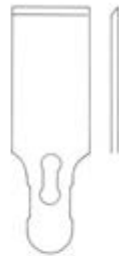

25 mm
33676-25
8,5 mm, 3.4"

Meißelklingen
auswechselbar
Chisel blades
interchangeable
Hojas de cincel
intercambiables
Lame intercambiabili

33676-01
18,5 cm, 7 1/4"
Griff allein
Handle only
Mango suelto
Manico solo



5 mm
33677-05
8,5 mm, 3.4"



10 mm
33677-10
8,5 mm, 3.4"



16 mm
33677-16
8,5 mm, 3.4"

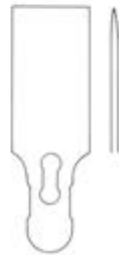

25 mm
33677-25
8,5 mm, 3.4"

Osteotomklingen
auswechselbar
Osteotome blades
interchangeable
Hojas de osteótomo
intercambiables
Lame per osteotomia
intercambiabili

Sternummeißel, Osteotom, Schädelspalter, Rachiottom, Muskelhaken
 Sternum Chisel, Osteotome, Skull breaker, Rachiottom, Muscle hooks
 Cinceles de esternón, Osteotomo, Cincel rompe-cráneo, Raquiótomos, Ganchos musculare
 Scalpello per sterno, Osteotomo, Divisore per cranio, Rachiottomi, Uncino per muscoli

23 mm



LEBSCHKE
 33678-24
 24,5 cm, 9 3/4"



33679-13
 13 cm, 5 1/8"



33680-22
 14 cm, 5 1/2"



33682-22
 22 cm, 8 3/4"



19902-10
 10 cm, 4"



19903-00

Medizinlöffel, Meißel, Sektionsnadeln
 Medicine Spoon, Chisels, Post mortem needles
 Cuchara graduada, Cinceles, Agujas para autopsia
 Cucchiaino per medicinali, Scalpelli, Aghi per autopsia



89146-20 20 cc
 110 x 20 mm

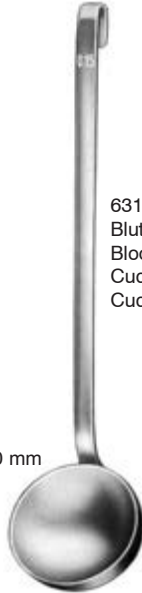

Ø 90 mm

63174-00
 Blutschöpfer, 150 ccm
 Blood scoop, 9 cu. inches
 Cucharra p / sangre
 Cucchiaino per sangue

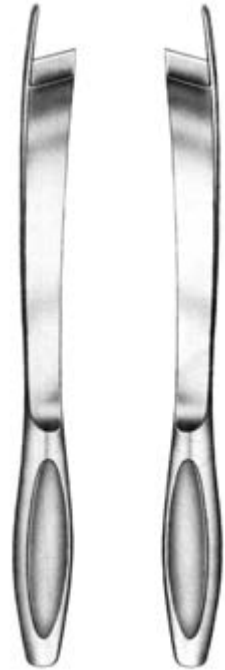

BRUNETTI
 28,5 cm, 11 1/4"
 33682-01 33682-02
 links rechts
 left right
 izquierdo derecho
 sinistra destra

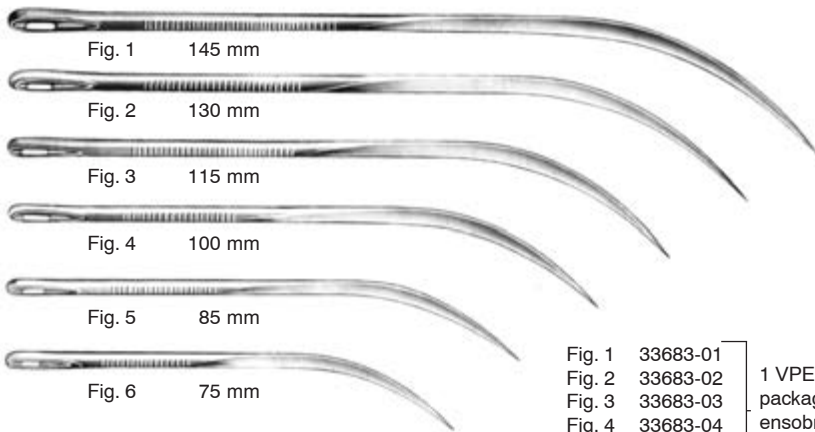

Fig. 1 145 mm

Fig. 2 130 mm

Fig. 3 115 mm

Fig. 4 100 mm

Fig. 5 85 mm

Fig. 6 75 mm

Fig. 1	33683-01	1 VPE = 12 Stk. package of 12 ensobres de 12 confezione di 12
Fig. 2	33683-02	
Fig. 3	33683-03	
Fig. 4	33683-04	
Fig. 5	33683-05	
Fig. 6	33683-06	

Obduktionsbesteck
Post Mortem Set
Estuches para Autopsia
Astucci per Autopsia



33684-00

Kleines Besteck, Holzetui, enthaltend:

- 4 Skalpelle
- 1 Knorpelmesser
- 1 Inzisionsschere, 13 cm (5 1/8")
- 1 Anatomische Pinzette, 13 cm (5 1/8")
- 1 Amputationssäge Charrière
- 1 Hammer
- 1 Meißel
- 2 doppelte Muskelhaken
- 2 doppelte Tubuli
- 2 Knopfsonden, 13 cm (5 1/8")
- 3 Wundnadeln

Small set, wooden case, containing:

- 4 Dissecting Knives
- 1 Cartilage Knife
- 1 Incision Scissors, 13 cm (5 1/8")
- 1 Dissecting Forceps, 13 cm (5 1/8")
- 1 Amputation Saw Charrière
- 1 Mallet
- 1 Chisel
- 2 Retractors, double ended
- 2 Blow pipes, double
- 2 Probes, 13 cm (5 1/8")
- 3 Suture Needles

Modelo pequeño, estuche de madera, conteniendo:

- 4 Escalpelos
- 1 Cuchillo para cartilago
- 1 Tijera de incision, 13 cm (5 1/8")
- 1 Pinza para disección, 13 cm (5 1/8")
- 1 Sierra de amputación Charrière
- 1 Martillo
- 1 Escoplo
- 2 Separadores de 2 gárfios, dobles
- 2 Tubos insufladores, dobles
- 2 Estiletos olivares, 13 cm (5 1/8")
- 3 Agujas para sutura

Modelo piccolo, astuccio di legno, composto da:

- 4 Bisturi
- 1 Coltello per cartilagine
- 1 Forbice per incisione, 13 cm (5 1/8")
- 1 Pinza anatomica, 13 cm (5 1/8")
- 1 Sega per amputazione, Charrière
- 1 Martello
- 1 Scalpello
- 2 Divaricatori con 2 ganci, doppi
- 2 Tubi inalatori, doppi
- 2 Specilli bottonuti, doppi, 13 cm (5 1/8")
- 3 Aghi per sutura

Hämmer
Mallets
Martillos
Martelli

Ø 25 mm



GERZOG
18 cm, 7"
33686-25 250 g

Ø 38 mm

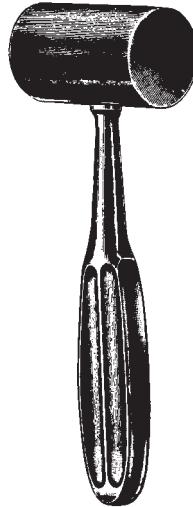

KIRK
19 cm, 7 1/2"
33687-75 750 g

Ø 34 mm

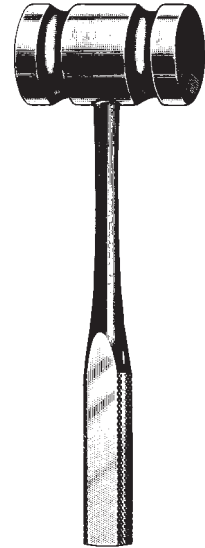

26,5 cm, 10 1/2"
33688-45 450 g
33689-90 900 g

Ø 30 mm

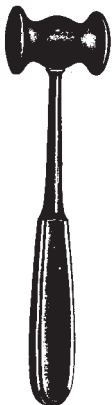

COLLIN
20 cm, 8"
33690-22 220 g

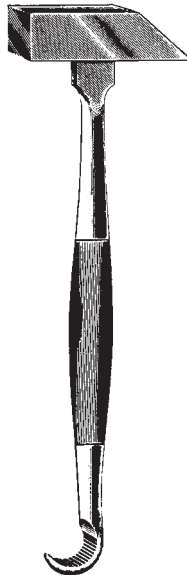

33699-00
23,5 cm, 9 1/4"
480 g

Ø 25 mm



33694-01 18,5 cm, 7 1/4"
33694-03 Ersatzbacken
Nylon Caps
Tapas de repuesto
Placche di ricambio

135 g

Hämmer
Mallets
Martillos
Martelli



WILLIGER
24 cm, 9 1/2"
33691-34 340 g

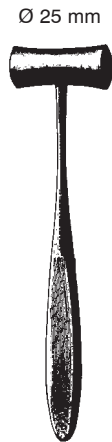

LUCAE
19 cm, 7 1/2"
33692-26 260 g

massiv, mit auswechselbaren Ferrozellbacken
solid, with interchangeable Ferrozell jaws
macizo, con tapas intercambiables de Ferrozell
solido, con placche intercambiabili in Ferrozell



33693-33
Paar Ersatzbacken
Pair spare jaws
par de tapas de repuesto
Coppia di placche di ricambio

33693-34
Satz Ringe
Set rings
juego de anillos
Set anelli

MEAD
17 cm, 6 3/4"
33693-32 320 g

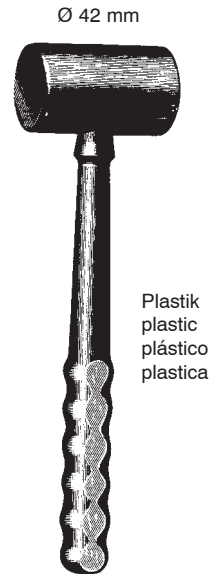

26 cm, 10 1/4"
33695-40 400 g



QUISLING
33696-75



PARTSCH
33698-98
18 cm, 7"
199 g



33699-17
26,5 cm, 10 1/2"
530 g

Hämmer
Mallets
Martillos
Martelli

Ø 30 mm



33700-01-01
Ersatzbacken
Nylon Caps
Tapas de repuesto
Placche di ricambio

24,5 cm, 9 3/4" 215 g
33700-01

Ø 10 mm

Ø 23 mm



Kopf aus Implantatwerkstoff
Head made of material used for implants
Cabeza de material de implantación
Testa in materiale per impianti

23 cm, 9" 350 g
33700-02

Ø 45 mm



BERGMANN
24 cm, 9 1/2" 300 g
33700-03

Ø 30 mm



BERGMANN
23 cm, 9" 300 g
33700-04

Hämmer
Bone Hammers and Mallets
Martillos y mazos
Martelli

Ø 30 mm



COTTLE
18 cm, 7" 240 g
33700-05

Ø 40 mm



HEATH
18 cm, 7" 700 g
33700-06

Ø 40 mm



OMBREDANNE
25 cm, 10" 700 g
33700-07

Ø 27 mm



HAJEK
21 cm, 8 1/4" 140 g
33700-08

Raspatorien
 Periosteal
 Periostótomos
 Periostotomi

12,5 mm



FARABEU
 33702-15
 15 cm, 5.9"

12,5 mm



FARABEU
 33703-15
 15 cm, 5.9"

11 mm



FARABEU-COLLIN
 33704-01
 15,5 cm, 6"

11 mm

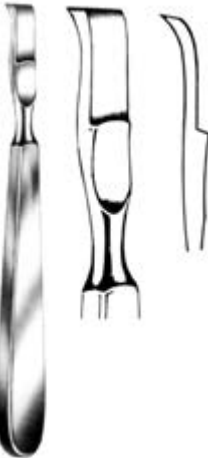

FARABEU-COLLIN
 33704-02
 15,5 cm, 6"



LAMBOTTE
 21 cm, 8 1/4"
 33705-05 5 mm
 33705-10 10 mm
 33705-15 15 mm
 33705-20 20 mm
 33705-25 25 mm

18 mm



SEDILLOT
 18 cm, 7"
 33706-18

Elevatoren, Raspatorien
 Elevatoren, Periosteal
 Elevadores, Periostótomos
 Elevatori, Periostotomi

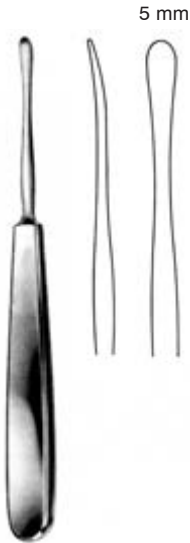

SEBILEAU
 17,5 cm, 7"
 33707-17

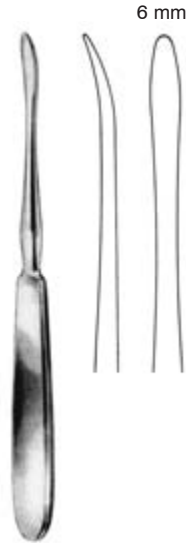

QUERVAIN
 19,5 cm, 7 3/4"
 33708-19

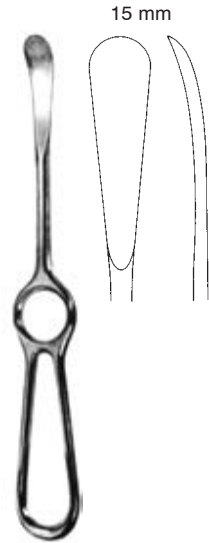

SEDILLOT
 21 cm, 8 1/4"
 33709-21



LANGENBECK
 19 cm, 7 1/2"
 33710-19



LANGENBECK
 18 cm, 7"
 33711-18



LANGENBECK
 20 cm, 8"
 33711-20 8 mm
 33711-21 10 mm

Raspatorien, Elevatoren
 Raspatories, Elevators
 Periostótomos, Elevadores
 Periostotomi, Elevatori

4 mm



WILLIGER
 33711-16
 16 cm, 6 1/4"

6,5 mm



WILLIGER
 33712-16
 16 cm, 6 1/4"

5 mm



WILLIGER
 33713-16
 16 cm, 6 1/4"

5,5 mm



WILLIGER
 33713-17
 17 cm, 6 3/4"

5 mm

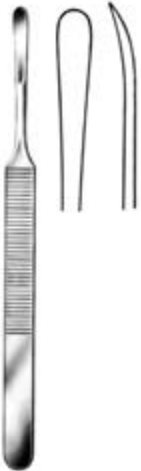

KÖNIG
 33714-15
 15,5 cm, 6"

12 mm

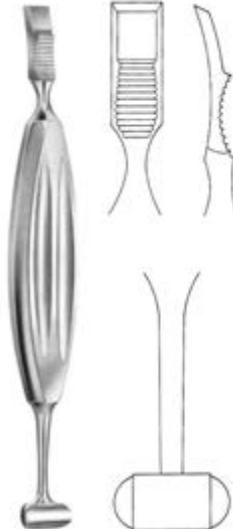

ALEXANDER
 33715-20
 21 cm, 8 1/4"



MOLT
 33716-18
 18 cm, 7"

Raspatorien, Elevatoren, Saugdissektor
 Raspatories, Elevators, Suction dissector
 Periostótomos, Elevadores, Disector con aspirador
 Periostotomi, Elevatori, Dissetto aspiratore



SELDIN
 33717-19-01
 19,5 cm 7 3/4"

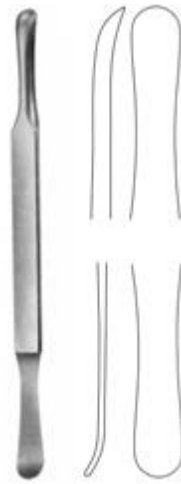

SELDIN
 33717-19-02
 19,5 cm 7 3/4"



JOSEPH
 33718-16
 16 cm, 6 1/4"



FOMON
 33719-17
 17 cm, 6 3/4"



BOIES
 33720-19
 19 cm, 7 1/2"



GORNEY
 33720-21
 21 cm, 8 1/4"

Raspatorien, Elevatoren
 Periosteal Elevators
 Periostótomos, Elevadores
 Periostotomi, Elevatori

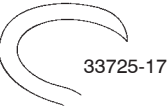
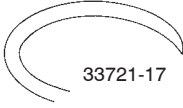

L

DOYEN
 17 cm, 6 3/4"

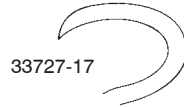
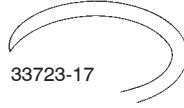

R

DOYEN
 17 cm, 6 3/4"



33728-24



33729-24

DOYEN
 24 cm 9 1/2"



SEMB

12 mm



33729-01
 17,5 cm
 7"

12 mm



33729-02
 21 cm
 8 1/4"

12 mm



33729-03
 17,5 cm
 7"

13 mm



33729-04
 21 cm
 8 1/4"

15 mm



33729-05
 20,5 cm
 8"

15 mm



33729-06
 20,5 cm
 8"



33729-07
 22,5 cm
 8.9"

Elevatoren, Raspatoren
Elevators, Raspatories
Elevadores, Periostótomos
Elevatori, Periostotomi



MATSON-ALEXANDER
33731-22
22 cm, 8 3/4"



MATSON
33733-22
22 cm, 8 3/4"



33740-19
19 cm, 7 1/2"



33741-18
18,5 cm, 7 1/4"

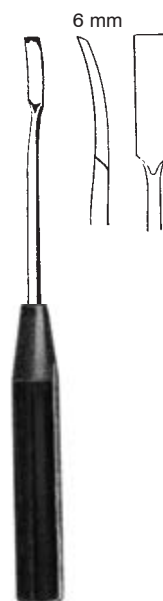

33742-18
18,5 cm, 7 1/4"



33743-18
18,5 cm, 7 1/4"

mit Ferrozellgriff
with Ferrozell-Handle
con mango de Ferrozell
con manico di Ferrozell

Elevatoren, Raspatoren
 Elevators, Raspatories
 Elevadores, Periostótomos
 Elevatori, Periostotomi

mit Ferrozellgriff
 with Ferrozell-Handle
 con mango de Ferrozell
 con manico di Ferrozell

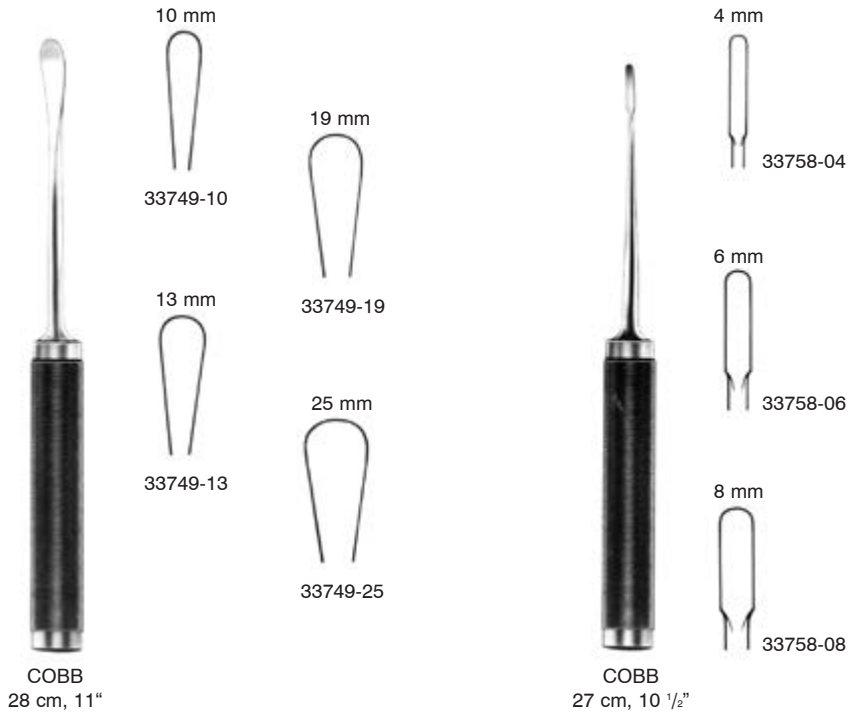
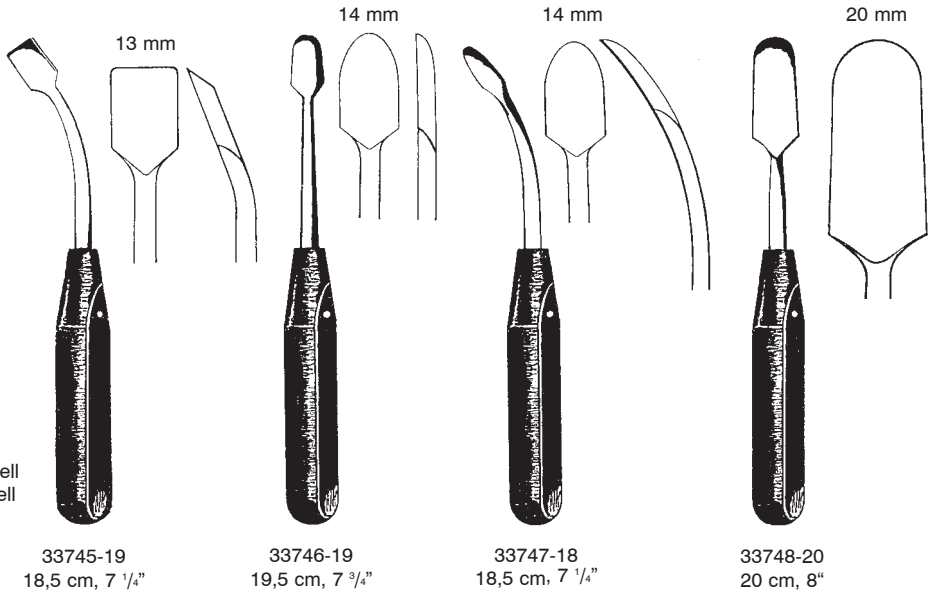

Elevatoren
Elevators
Elevadores
Elevatori

scharf
sharp
cortante
tagliente



SAYRE
17 cm, 6 $\frac{3}{4}$ "
33758-01

stumpf
blunt
romo
smusso



SAYRE
17 cm, 6 $\frac{3}{4}$ "
33758-02

Raspatoren, Knochenheber, Dissektor
 Raspatories, Bone Levers, Dissectors
 Periostótomes para huesos, Disectores
 Periostotomi, Elevatori per ossa, Dissettori

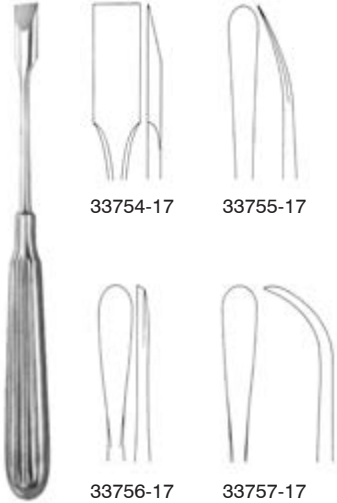

33754-17

33755-17

33756-17

33757-17

ADSON
 17 cm, 6 3/4"

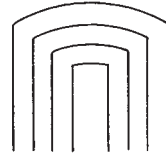

33759-06 6 mm
 33759-12 12 mm
 33759-19 19 mm
 33759-25 25 mm

KEY

33759-06 - 33759-25
 19 cm, 7 1/2"



CHANDLER

33763-01 19,0 cm 7 1/2"
 33763-02 20,3 cm 8"
 33763-03 22,9 cm 9"
 33763-04 25,4 cm 10"

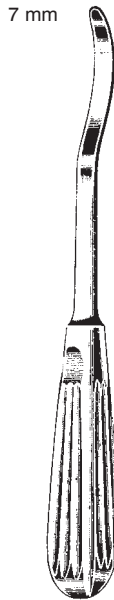

CREGO

33760-01
 20 cm, 8"



33760-02

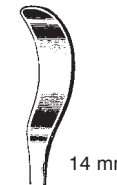

33760-03

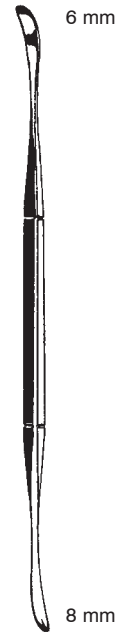

ALDERDYCE

33761-21
 21 cm, 8 1/4"

Elevatoren, Dissektor, Knochenhebel
 Elevators, Dissectors, Bone Levers
 Elevadores para huesos, Disectores
 Elevatori, Dissettori, Elevatori per ossa

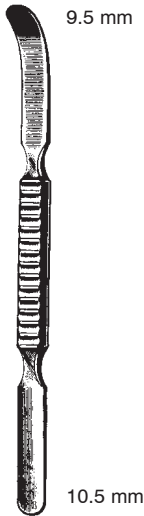

WATSON-CHEYNE
 33765-17
 17,5 cm, 7"

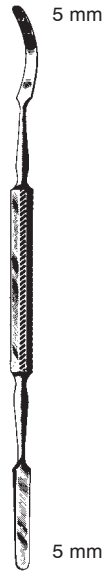

MC DONALD
 33767-19
 19 cm, 7 1/2"



MURPHY-LANE
 33769-30
 30 cm, 11 3/4"



BENNETT
 33771-71
 26 cm, 10 1/4"

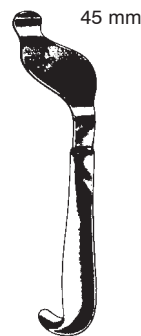

BENNETT
 33771-73
 26 cm, 10 1/4"

Knochenheber
Bone Levers
Elevadores para huesos
Elevatori per ossa

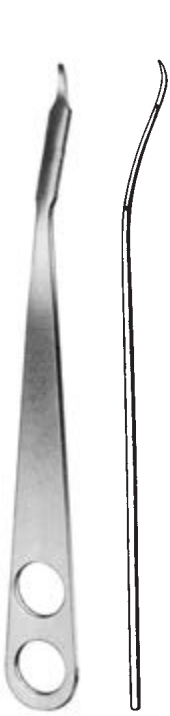

HOHMANN
33801-08 8 mm
33801-12 12 mm

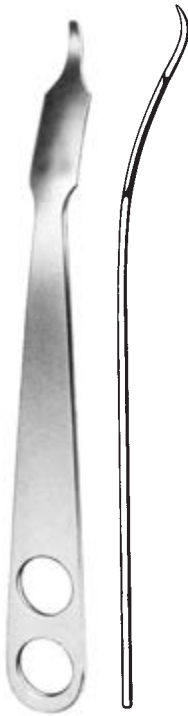

HOHMANN
33801-18
18 mm, 3/4"

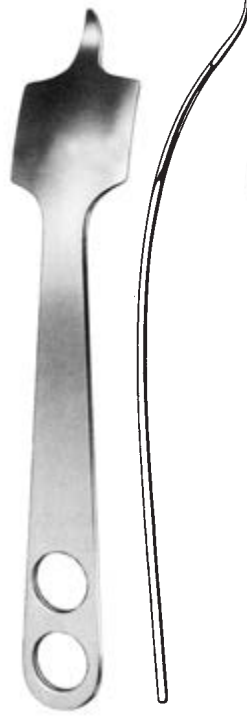

HOHMANN
33801-43
43 mm, 1 3/4"



HOHMANN
33801-70
70 mm, 2 3/4"

4,5 mm



KÖNIG
33802-01
15 cm, 6"

4,5 mm



KÖNIG
33802-02
15 cm, 6"

2,8 mm



33802-14
14 cm, 5 1/2"

5 mm



33803-05
15 cm, 6"

7 mm



33803-07
15 cm, 6"

Knochenhebel
Bone Levers
Elevadores para huesos
Elevatori per ossa



HOHMANN
33803-43 43 mm

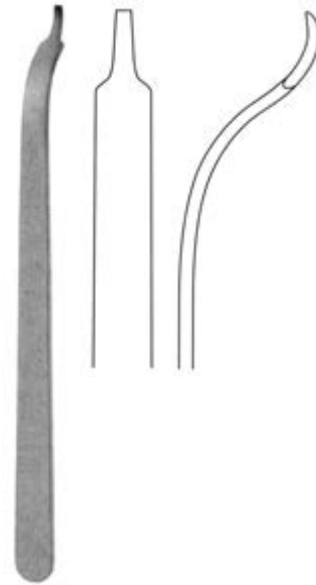

BUCK-GRAMCKO
33804-15 7,5 mm



HOHMANN
33805-22 22 mm



HOHMANN
33805-33 33 mm



HOHMANN
33807-24 24 mm



HOHMANN
33809-22 22 mm

Knochenhebel
 Bone Levers
 Elevadores para huesos
 Elevatori per ossa

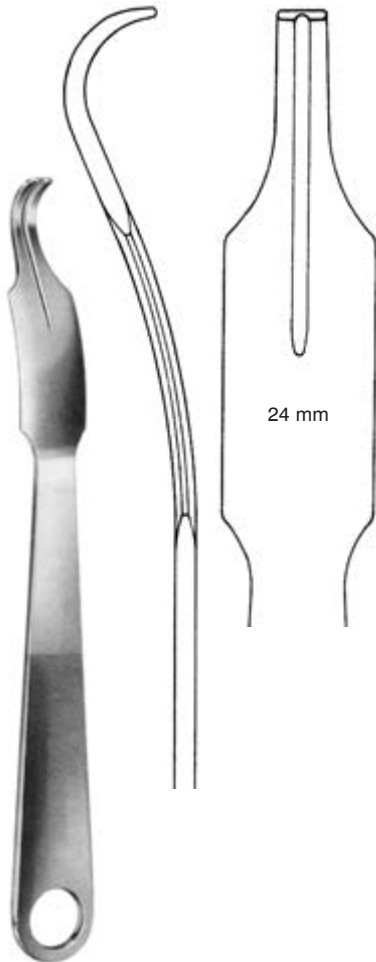

LANGE-HOHMANN
 33810-24
 25 cm, 10"



HOHMANN mini
 16 cm, 6 1/4"

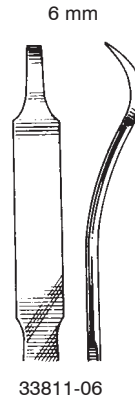

33811-06

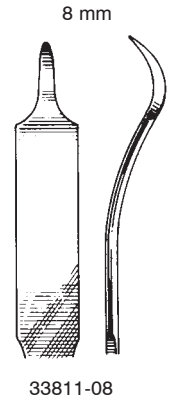

33811-08

Knochenhebel
Bone Levers
Elevadores para huesos
Elevatori per ossa

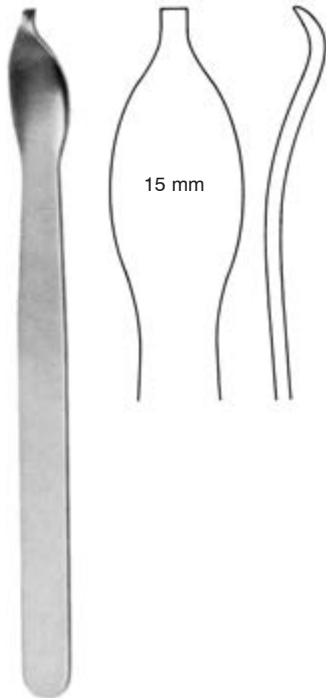

33812-16
16 cm, 6 1/4"

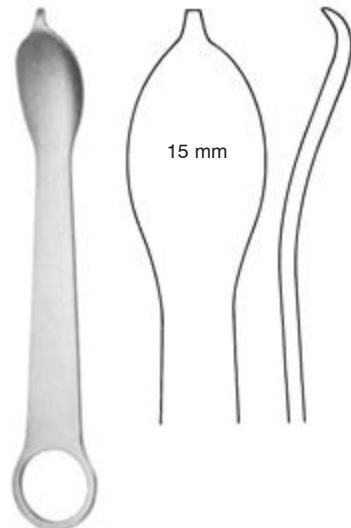

33813-12
12 cm, 4 3/4"

Knochenheber
Bone Levers
Elevadores para huesos
Elevatori per ossa

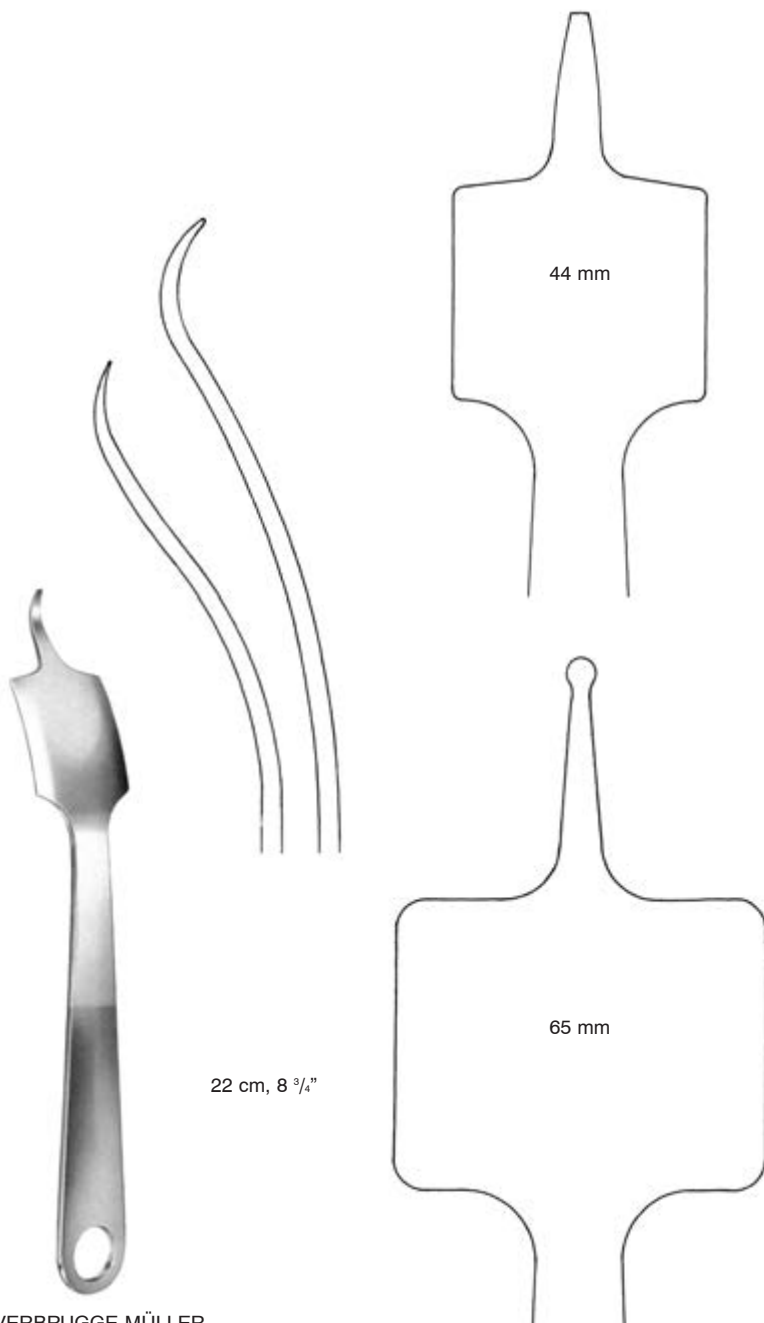

VERBRUGGE-MÜLLER
33814-44 24,0 cm, 9 1/2"
33814-65 25,5 cm, 10"

Knochenhebel
Bone Levers
Elevadores para huesos
Elevatori per ossa



BLOUNT
33823-26
26 cm, 10 1/4"



BLOUNT
33825-26
26 cm, 10 1/4"

Retraktor, Knochenheber, Meniskushaken
 Retractor, Bone Levers, Meniscus Retractors
 Separador, Elevadores p. huesos, Separadores para menisco
 Divaricatori, Elevatori per ossa, Divaricatori per il menisco

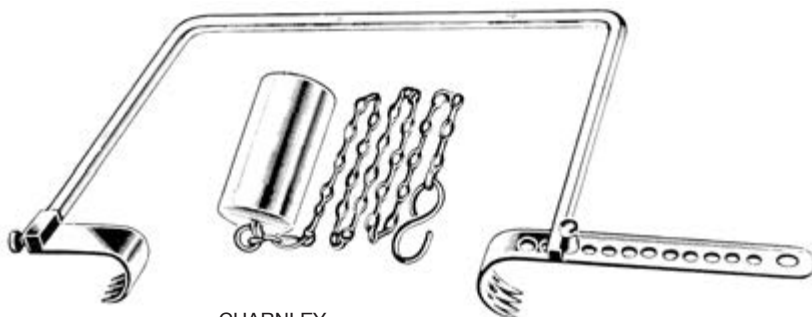

CHARNLEY
 33826-00

33826-01 spitz, gerieft
 pointed tip, serrated
 punta aguda, dentada
 punta acuta, zigrinata

33826-02 stumpf, gerieft
 blunt tip, serrated
 punta roma, dentada
 punta smussa, zigrinata

33826-03 stumpf, glatt
 blunt tip, smooth
 punta roma, lisa
 punta smussa, liscia



AUFRANC-COBRA
 26 cm 10 1/4"



BLOUNT
 33827-17
 17,5 cm 7"

Knochenhebel
Bone Levers
Elevadores p. huesos
Elevatori per ossa



LANE TRETOWAN
33828-21
21,5 cm 8 1/2"



LANE
33829-25
25,5 cm 10"



BRISTOW
33830-23
23 cm 9"

Knochenheber, Meniskushaken
 Bone Levers, Meniscus Retractors
 Elevadores p. huesos, Separadores para menisco
 Elevatori per ossa, Divaricatori per il menisco



TAYLOR
 16,5 cm, 6 1/2"
 33831-16 75x30 mm
 33833-16 100x30 mm



SMILLIE
 14 cm, 5 1/2"
 12 x 13 mm
 33832-01



SMILLIE
 14 cm, 5 1/2"
 52 x 13 mm
 33832-02



32 x 19 mm
 33832-03

48 x 19 mm
 33832-04

57 x 19 mm
 33832-05

SMILLIE
 14 cm, 5 1/2"

Sehenschäler, Sehnenfaßpinzette, Sehnenhaltezange, Sehnenfaßinstrumente
 Tendon seizing instruments
 Instrumentos para coger tendones
 Enucleatore di tendine, Strumenti per afferrare tendini



SMILLIE
 33910-17
 17 cm, 6 3/4"

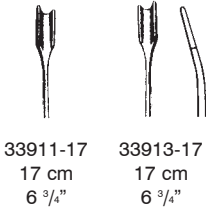

33911-17 17 cm 6 3/4"
 33913-17 17 cm 6 3/4"

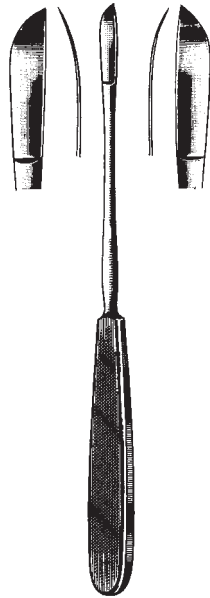

NEFF
 33921-22 - 33923-22
 22 cm, 8 3/4"



33950-01 3 mm
 33950-02 4 mm
 33950-03 5 mm
 33950-04 6 mm
 33950-05 7 mm
 BUNELL
 33950-01 - 33950-05
 15 cm, 6"



LARSEN
 33960-15 - 33960-55
 10 cm, 4"

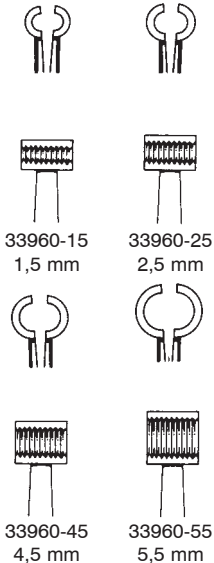

33960-15 1,5 mm
 33960-25 2,5 mm
 33960-45 4,5 mm
 33960-55 5,5 mm



JACKSON
 33961-15
 15 cm, 6"

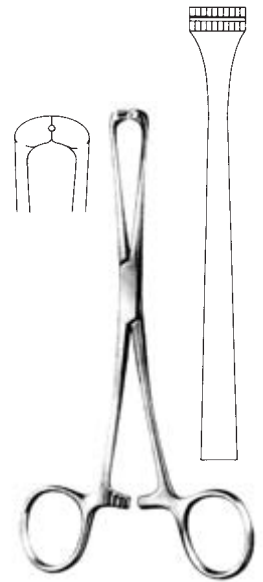

STEINMANN
 33962-16
 16 cm, 6 1/4"

Sehnenfaßinstrumente, Sehnenführer
 Tendon seizing instruments, Tendon passing instr.
 Instrumentos para coger tendones, Instrumento p. el tunel del tendon
 Strumenti per afferrare tendini



33963-12
 12 cm, 4 3/4"



BRAND
 33964-15 - 33964-24



33964-15
 15 cm, 6"



33964-19
 19 cm, 7 1/2"



33964-24
 24 cm, 9 1/2"



BRAND
 33965-15 15 cm, 6"
 33965-19 19 cm, 7 1/2"
 33965-24 24 cm, 9 1/2"



CAROLL
 33966-11
 11 cm, 4 3/8"



33966-15 15 cm, 6" 33967-15

Sehnenfassinstrumente, Sehnenstripper, Knochenfeilen, Raspeln
 Tendon seizing instruments, Tendon Strippers, Bone Files, Rasps
 Instrumentos para coger tendones, Enucleadores de tendones, Limas, Escofinas
 Strumenti per afferrare tendini, Scollatendini, Lime per ossa, Raspe



KLEINERT-KUTZ
 33967-20
 20 cm, 8"



ø 3 mm
 33968-30
 30 cm, 11 3/4"

ø 6 mm
 33968-60
 50 cm, 19 1/2"

BRAND



biegsam
 malleable
 maleable
 malleabile

BUNELL
 33969-18 18 cm, 7"
 33969-23 23 cm, 9"



biegsamer Schaft
 flexible shaft
 vastago maleabile
 camicia flessibile

BUNELL 23 cm
 33970-01 ø 4,0 mm
 33970-02 ø 4,5 mm
 33970-03 ø 5,5 mm



33971-24
 24,5 cm, 9 3/4"



33972-22
 22 cm, 8 3/4"



PUTTI
 33973-27
 27 cm, 10 1/2"



PUTTI
 33975-30
 30 cm, 11 3/4"

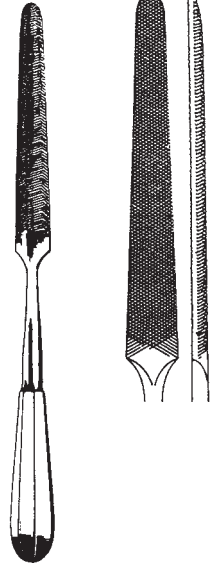

33977-28
 28 cm, 11"

Komprimeter
 Pneumatic Tourniquet
 Torniquete neumático
 Apparecchio di compressione



34101-01
compl.

Gerät zur Erzeugung von Blutleere in den Gliedmaßen
 Compression Apparatus for producing blood vacuum in limbs
 Aparato de compresión para producir el vacío de sangre en los miembros
 Vacuometro per determinare vuoti di sangue nelle membra

34101-02

Pumpe
 Air Pump
 Bomba de aire
 Pompa di aria

34101-03

Manometer
 Manometer
 Manómetro
 Manometro

34101-04

Oberarmmanschette
 Cuff for upper arm
 Brazalete (brazo)
 Bracciale
 34101-06 incl.

34101-05

Oberschenkelmanschette
 Cuff (leg)
 Brazalete (pierna)
 Cosciale
 34101-07 incl.

34101-06

Polster für Oberarmmanschette 46 x 6 cm (18" x 2.4")
 Bandage cuff for arm 46 x 6 cm (18" x 2.4")
 Colchon para brazalete para brazo 46 x 6 cm (18" x 2.4")
 Bracciale per braccio superiore 46 x 6 cm (18" x 2.4")

34101-07

Polster für Oberschenkelmanschette 55 x 10 cm (21 1/2 x 10")
 Bandage cuff for leg 55 x 10 cm (21 1/2 x 10")
 Colchon para brazalete para el femur 55 x 10 cm (21 1/2 x 10")
 Bracciale per coscia superiore 55 x 10 cm (21 1/2 x 10")

Amputations- und Resektionssägen
 Amputation and Resection Saws
 Sierras para amputación y resección
 Seghe per amputazione e resezione

Staubinde
 Compression bandage
 Vendaje de compresión
 Benda per compressione
 5 m lang / long
 6 cm breit / wide



ESMARCH
 34105-01

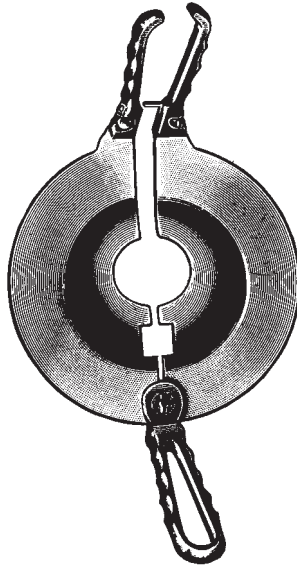

PERCY
 34110-00



CHARRIERE
 34112-00
 35 cm, 13 3/4"

34112-01
 12 mm

Ersatzsägeblätter
 Spare saw blades
 Hojas de sierra de
 repuesto
 Lame di ricambio

34112-02
 15 mm

Ersatzsägeblätter
 Spare saw blades
 Hojas de sierra de
 repuesto
 Lame di ricambio

komplett mit 2 Blättern
 complete with 2 blades
 completo con 2 hojas
 completa con 2 lame



mit 3 Sägeblätter
 4 - 6 - 8 mm
 with 3 spare blade
 con 3 hojas de repuesto
 con 3 lame di ricambio

BIER
 34114-39
 40,5 cm, 16"



CHARRIERE
 34116-30
 30 cm, 11 3/4"

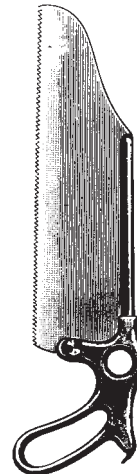

SATTERLEE
 34118-31
 31 cm, 12 1/4"

34118-99
 Sägeblatt
 blade
 hoja
 lama



LANGENBECK
 34120-23
 23 cm, 9"

Nagelausreibzange, Fingerringsägen
 Fcps. f. tearing out finger nails, Finger Ring Saws
 Pinzas para arrancar uñas, Sierras para abrir anillos
 Pinze per lacerazione delle unghie, Seghe per anelli

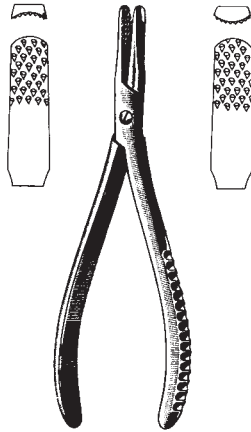

RADOLF

- 34161-13 13,5 cm, 5 1/4" 3 mm
- 34162-13 13,5 cm, 5 1/4" 6 mm

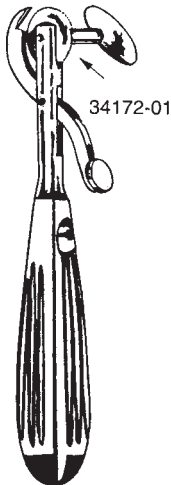

WALTON
 34172-00
 16 cm, 6 1/4"

Sägeblatt
 Saw blade
 Hoja de sierra
 Lama di ricambio

34172-01



REDA
 34175-00
 17 cm, 6 3/4"

Sägeblatt
 Saw blade
 Hoja de sierra
 Lama di ricambio

34175-01

Bohrapparate, Bohrlochzange
 Bone Hand Drills, Forceps for Bone Hole
 Perforador de mano, Pinza de guía
 Perforatori a mano, Pinza per perforazione

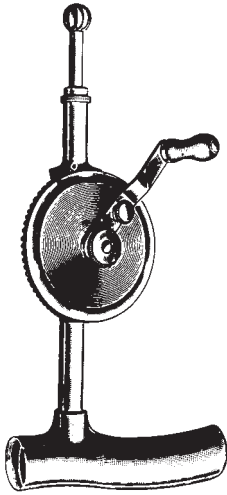

STILLE
 34210-20 20 cm, 8"
 compl. incl. 34212-25 - 34214-16

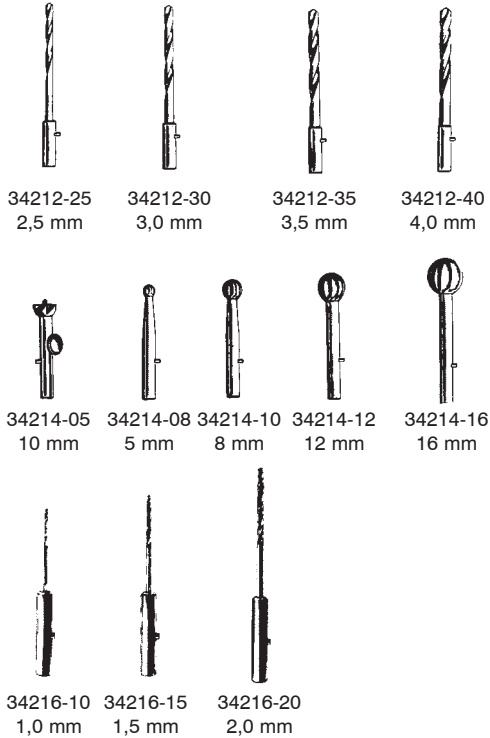

34212-25 2,5 mm 34212-30 3,0 mm 34212-35 3,5 mm 34212-40 4,0 mm

34214-05 10 mm 34214-08 5 mm 34214-10 8 mm 34214-12 12 mm 34214-16 16 mm

34216-10 1,0 mm 34216-15 1,5 mm 34216-20 2,0 mm

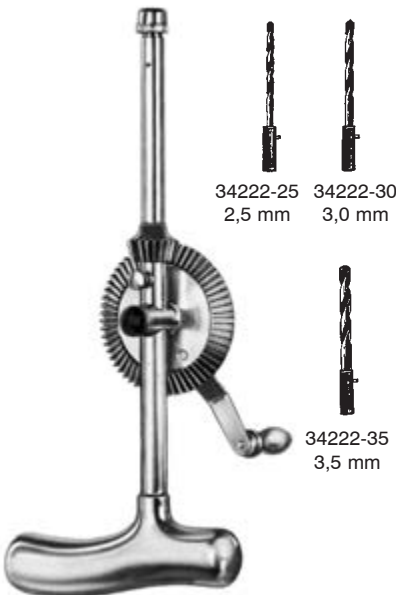

STILLE-SHERMAN
 34220-24 24 cm, 9 1/2"
 compl. incl. 34222-25 - 34222-35

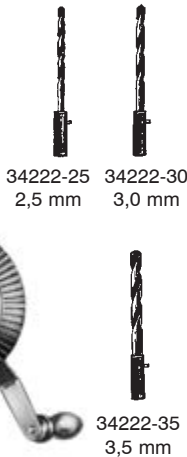

34232-00
 Ø 3,2 mm



MOORE
 34230-28 28 cm, 11"
 compl. incl. 34232-00

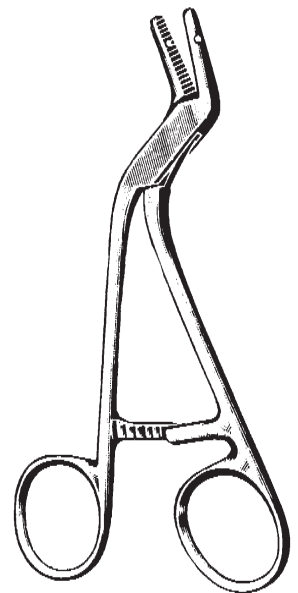

ADSON
 34231-15
 15 cm, 6"

Bohrapparate
Bone Hand Drills
Perforador de mano
Perforatori a mano



34241-00
Griff allein
Handle only
Mango solo
Manico solo

HUDSON

34240-27 27 cm, 10 1/2"
compl. incl. 34242-09, -14, -16, -22,
34246-00



34242-09
9 mm



34242-14
14 mm



34242-16
16 mm



34242-22
22 mm



ø 2 mm
34243-02



CUSHING
34244-10
34244-14
34244-16



ERRICO
34244-17
ø 16 mm



MC KENZIE
34248-00
ø 13 mm



34246-00
Verlängerungsstück
Extension piece
Pieza alargadera
Giunto di prolungamento



KIRSCHNER
34250-00 compl.



34252-00



34270-01
Schlüssel
Wrench
Llave
Chiave

BUNELL
34270-00 16 cm, 6 1/4"

Bohrapparat 16 cm (6 1/4"), längsdurchbohrt mit Dreibackenspannfutter und Schlüssel, Spannweite bis 4 mm
Hand drill, 16 cm (6 1/4"), longitudinally bored, with three-jaw-chuck and key, opening up to 4 mm

Perforador manual, 16 cm (6 1/4"), taladrado longitudinalmente, con mandril de tres mordazas y llave, abriendo hasta 4 mm
Perforatore a mano, 16 cm (6 1/4"), con perforazione assiale, con mandrino a tre ganasce e chiave, apertura fino a 4 mm di D.

Bohrapparate, Handgriffe
 Bone Hand Drills, Handles
 Perforador de mano
 Perforatori a mano, manici



RALK
34280-00



REDA
34290-00



34295-00



34296-00

Spannschlüssel allein
 Key only
 Llave suelta
 Chiave solo

Handgriff mit Jacobs-
 spannfutter und Spann-
 schlüssel bis 3,6 mm
 Handle with Jacobs chuck
 and key to 3,6 mm
 Mango con cierre Jacobs,
 de 3 mordazas y llave a
 3,6 mm
 Manico con mandrino di
 Jacobs e chiave a 3,6 mm

Bohrapparat mit Leichtmetallgehäuse, mit Dreibackenspannfutter und Schlüssel, Spannweite bis D. 6,35 mm
 Hand drill with light metal case, with three-jaw-chuck and key, opening up to D. 6,35 mm
 Perforador manual con caja de aluminio, con mandril de tres mordazas y llave, abriendo hasta 6,35 mm de D.
 Perforatore a mano con cassa in metallo leggero, con mandrino a tre ganasce e chiave, apertura fino a 6,35 mm di D.

Handbohrapparat mit umstellbarem Handgriff, mit Jacobs Dreibackenspannfutter und Schlüssel
 Hand drill with adjustable handle, with Jacobs three-jaw-chuck and wrench
 Perforador de mano en T con cierre Jacobs de 3 mordazas y llave de ajuste
 Perforatore a mano con manico regolabile, con mandrino a tre ganasce di Jacobs e chiave



34296-05

T-Handgriff, verriegelbares schlüsselloses Dreibackenspannfutter, rostfrei
 T-handle, keyless locking chuck
 Mango en T, mordaza sin llave, inox.
 Chiave a T con mandrino a tre ganasce inox



34296-10

Handgriff, Dreibackenspannfutter, inkl. Spannschlüssel rostfrei
 Handle with chuck, including key
 Mango, mordaza incluyendo llave, inox.
 Mandrino a tre ganasce con manico recto completo di chiave di arresto inox



34296-15

"Hudson" T-Handgriff, Schnellkupplung
 Hudson T-handle with fast gripping chuck
 Mango en T, acople rápido
 Hudson: mandrino con manico a T
 Ganasce con raccordo rapido



34296-20

Schnellkupplungs T-Handgriff, groß
 T-handle with fast gripping chuck, large
 Mango en T, acople rápido, grande
 Mandrino a T manico grande
 Raccordo rapido

Schnellkupplungs-Handgriffe
Handles with quick-action chuck
Mangos de acople rápido
Manici con attachi rapidi



34296-25
Schnellkupplungs-T-Handgriff
T-Handle, quick-action
Mango en T, acople rápido
Mandrino a T con raccordo rapido



34296-30
Schnellkupplungs-Handgriff
groß mit Hartgewebegriff
Handle, quick-action, large,
handle made of very hard fibre
Mango de acople rápido,
grande, de material extraduro
Mandrino grande rapido con
manico a fibre dure



34296-35
Schnellkupplungs-Handgriff
mit Hartgewebegriff
Handle, quick-action,
made of very hard fibre
Mango de acople rápido,
de material extra-duro
Mandrino medio rapido con
manico a fibre dure



34296-40
Mini Schnellkupplungs-Handgriff
für „Dental“-Anschluß
Mini-Handle, quick-action,
"dental"
Mini-Mango de acople rápido
"dental"
Mini mandrino-rapido con
impugnatura cilindrica con
attacco dentale

Bohrer
Drill bits
Taladros
Perforatore



Ø		
1,0 mm	56 mm	34320-10
1,5 mm	70 mm	34320-15
2,0 mm	85 mm	34320-20
2,5 mm	95 mm	34320-25
2,7 mm	100 mm	34320-27
3,0 mm	100 mm	34320-30
3,2 mm	106 mm	34320-32
3,5 mm	112 mm	34320-35
4,0 mm	119 mm	34320-40
4,5 mm	126 mm	34320-45
5,0 mm	132 mm	34320-50
6,0 mm	139 mm	34320-60
7,0 mm	156 mm	34320-70

Spiralbohrer mit Glattschaft
Twist Drills with round end
Taladros espirales con vástago redondo
Perforatore elicoidale



Ø		
1,0 mm	180 mm	34321-10
1,5 mm	180 mm	34321-15
2,0 mm	180 mm	34321-20
2,5 mm	180 mm	34321-25
2,7 mm	180 mm	34321-27
3,0 mm	180 mm	34321-30
3,2 mm	180 mm	34321-32
3,5 mm	180 mm	34321-35
4,0 mm	180 mm	34321-40
4,5 mm	180 mm	34321-45
5,0 mm	180 mm	34321-50
6,0 mm	180 mm	34321-60
6,5 mm	180 mm	34321-65
7,0 mm	180 mm	34321-70
8,0 mm	180 mm	34321-80
9,0 mm	180 mm	34321-90
10,0 mm	180 mm	34322-00

Spiralbohrer mit Glattschaft langes Modell
Twist Drills, long typ
Taladros espirales, largos
Perforatore elicoidale, modello lungo



Ø		
1,1 mm	60 mm	34322-11
1,5 mm	85 mm	34322-15
2,0 mm	100 mm	34322-20
2,5 mm	110 mm	34322-25
2,7 mm	100 mm	34322-27
3,2 mm	145 mm	34322-32
3,5 mm	110 mm	34322-35
4,5 mm	145 mm	34322-45

Spiralbohrer mit Schnellkupplungs-Ansatz
Twist Drills, quick-action
Taladros espirales, acople rápido
Perforatore elicoidale con attacco rapido

Pfrieme, Reibahle
 Awl, Reamer
 Escariadores
 Lesine, Punteruoli



34392-14
 14 cm, 5 1/2"



PERTHES
 34393-18
 18 cm, 7"

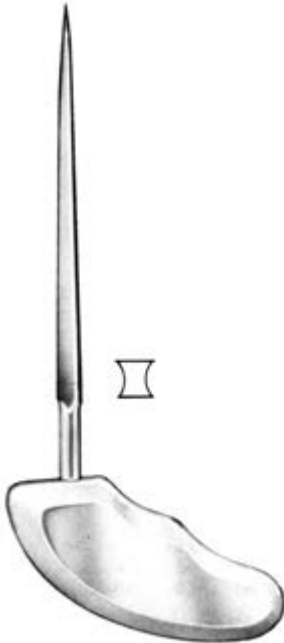

PERTHES
 34393-21
 21 cm, 8 1/4"

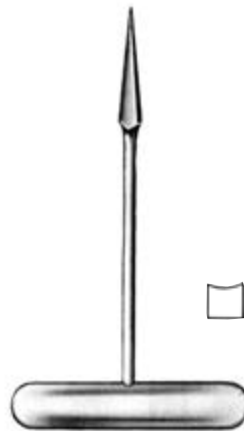

34394-14
 14 cm, 5 1/2"

Faßpinzette, Bohrdrahtspender
Grasping forceps, Support for sterilisation
Pinzas para coger, Soporte de esterilización
Pinze per afferrare, Supporto per la sterilizzazione



34439-00

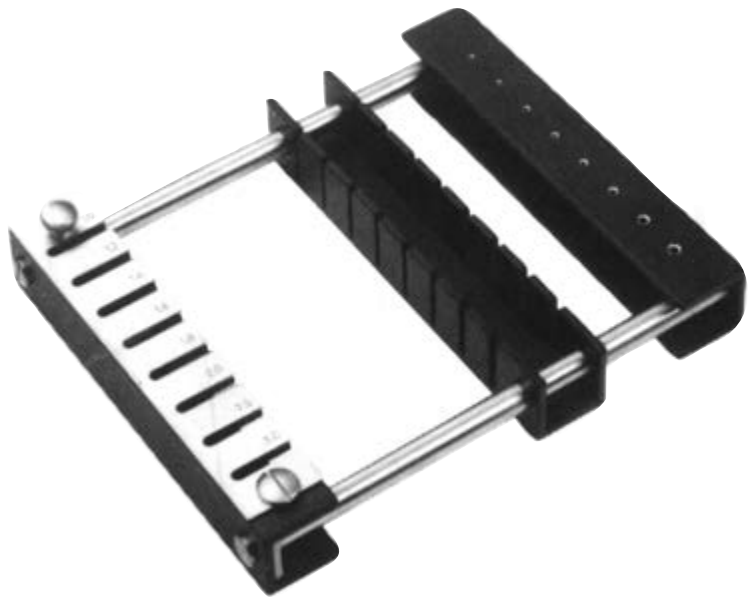

Bohrdrahtspender für Kirschner-Drähte
Support for sterilisation of Kirschner wires
Soporte de esterilización p. alambres de Kirschner
Supporto per la sterilizzazione dei fili di Kirschner

34440-01 bis 15 cm – up to 15 cm (6") – hasta 15 cm – fino a 15 cm
34440-02 bis 31 cm – up to 31 cm (12 1/4") – hasta 31 cm – fino a 31 cm
34440-03 bis 10 cm – up to 10 cm (4") – hasta 10 cm – fino a 10 cm

Bohrdrähte
Drill Wires
Alambres
Perforatori filiformi

lieferbar in Packungen à 10 Stück
available in packages of 10 pieces
disponible en paquets de 10 unidades
disponibili solo in confezioni da 10 pezzi

Trokarspitze / Trocar point
Punta trocar / Punte trequarti

Ø	10 cm, 4"	15 cm, 6"	31 cm, 12 1/4"
0,8	34401-08	34402-08	34403-08
1,0	34401-10	34402-10	34403-10
1,1	34401-11	34402-11	34403-11
1,2	34401-12	34402-12	34403-12
1,3	34401-13	34402-13	34403-13
1,4	34401-14	34402-14	34403-14
1,5	34401-15	34402-15	34403-15
1,6	34401-16	34402-16	34403-16
1,7	34401-17	34402-17	34403-17
1,8	34401-18	34402-18	34403-18
1,9	34401-19	34402-19	34403-19
2,0	34401-20	34402-20	34403-20
2,2	34401-22	34402-22	34403-22
2,3	34401-23	34402-23	34403-23
2,4	34401-24	34402-24	34403-24
2,5	34401-25	34402-25	34403-25
2,8	34401-28	34402-28	34403-28
3,0	34401-30	34402-30	34403-30

Kirschner
mit rundem Ende / with round shaft
con extremo redondo / con extremo rotondo

Trokarspitze / Trocar point
Punta trocar / Punte trequarti

Ø	10 cm, 4"	15 cm, 6"	31 cm, 12 1/4"
0,8	34404-08	34405-08	34406-08
0,9	34404-09	34405-09	34406-09
1,0	34404-10	34405-10	34406-10
1,1	34404-11	34405-11	34406-11
1,2	34404-12	34405-12	34406-12
1,3	34404-13	34405-13	34406-13
1,4	34404-14	34405-14	34406-14
1,5	34404-15	34405-15	34406-15
1,6	34404-16	34405-16	34406-16
1,7	34404-17	34405-17	34406-17
1,8	34404-18	34405-18	34406-18
1,9	34404-19	34405-19	34406-19
2,0	34404-20	34405-20	34406-20
2,2	34404-22	34405-22	34406-22
2,3	34404-23	34405-23	34406-23
2,4	34404-24	34405-24	34406-24
2,5	34404-25	34405-25	34406-25
2,8	34404-28	34405-28	34406-28
3,0	34404-30	34405-30	34406-30

Kirschner
mit flachem Ende / with flat shaft
con extremo plano / con extremo piatto

Trokarspitze / Trocar point
Punta trocar / Punte trequarti

Ø	10 cm, 4"	15 cm, 6"	31 cm, 12 1/4"
0,8	34407-08	34408-08	34409-08
0,9	34407-09	34408-09	34409-09
1,0	34407-10	34408-10	34409-10
1,1	34407-11	34408-11	34409-11
1,2	34407-12	34408-12	34409-12
1,3	34407-13	34408-13	34409-13
1,4	34407-14	34408-14	34409-14
1,5	34407-15	34408-15	34409-15
1,6	34407-16	34408-16	34409-16
1,7	34407-17	34408-17	34409-17
1,8	34407-18	34408-18	34409-18
1,9	34407-19	34408-19	34409-19
2,0	34407-20	34408-20	34409-20
2,2	34407-22	34408-22	34409-22
2,3	34407-23	34408-23	34409-23
2,4	34407-24	34408-24	34409-24
2,5	34407-25	34408-25	34409-25
2,8	34407-28	34408-28	34409-28
3,0	34407-30	34408-30	34409-30

Kirschner
Trokarende / Trocar shaft
Punta trocar / Punte trequarti Bilaterali

Lanzenspitze / Lance point
Punta lanceolar / Punte lanceolata

Ø	31 cm, 12 1/4"
0,8	34410-08
0,9	34410-09
1,0	34410-10
1,1	34410-11
1,2	34410-12
1,3	34410-13
1,4	34410-14
1,5	34410-15
1,6	34410-16
1,7	34410-17
1,8	34410-18
1,9	34410-19
2,0	34410-20
2,2	34410-22
2,3	34410-23
2,4	34410-24
2,5	34410-25
2,8	34410-28
3,0	34410-30

Kirschner
mit flachem Ende / with flat shaft
con extremo plano / con extremo piatto

lieferbar in Packungen à 10 Stück
available in packages of 10 pieces
disponible en paquets de 10 unidades
disponibili solo in confezioni da 10 pezzi

Bohrdrähte, Knochennägel
Drill Wires, Fracture pins
Alambres, Clavos para huesos
Perforatori filiformi, Chiodi per ossa

Lanzenspitze / Lance point
Punta lanceolar / Punta lanceolata



Ø	31 cm, 12 1/4"
0,8	34411-08
0,9	34411-09
1,0	34411-10
1,1	34411-11
1,2	34411-12
1,3	34411-13
1,4	34411-14
1,5	34411-15
1,6	34411-16
1,7	34411-17
1,8	34411-18
1,9	34411-19
2,0	34411-20
2,2	34411-22
2,3	34411-23
2,4	34411-24
2,5	34411-25
2,8	34411-28
3,0	34411-30

Trokarspitze / Trocar point
Punta trocar / Punta trequarti



	Ø	Ø	Ø	Ø	Ø
	3,5 mm	4,0 mm	4,5 mm	5,0 mm	6,0 mm
8 cm, 3 1/8"	34412-08	34413-08	34415-08	34417-08	34419-08
10 cm, 4"	34412-10	34413-10	34415-10	34417-10	34419-10
12 cm, 4 3/4"	34412-12	34413-12	34415-12	34417-12	34419-12
14 cm, 5 1/2"	34412-14	34413-14	34415-14	34417-14	34419-14
16 cm, 6 1/4"	34412-16	34413-16	34415-16	34417-16	34419-16
18 cm, 7"	34412-18	34413-18	34415-18	34417-18	34419-18
20 cm, 8"	34412-20	34413-20	34415-20	34417-20	34419-20
22 cm, 8 3/4"	34412-22	34413-22	34415-22	34417-22	34419-22
23 cm, 9"	34412-23	34413-23	34415-23	34417-23	34419-23
24 cm, 9 1/2"	34412-24	34413-24	34415-24	34417-24	34419-24
26 cm, 10 1/4"	34412-26	34413-26	34415-26	34417-26	34419-26
28 cm, 11"	34412-28	34413-28	34415-28	34417-28	34419-28
30 cm, 11 3/4"	34412-30	34413-30	34415-30	34417-30	34419-30

Kirschner
mit rundem Ende / with round shaft
con extremo redondo / con extremo rotondo

Steinmann
mit rundem Ende / with round shaft
con extremo redondo / con extremo rotondo

Trokarspitze / Trocar point
Punta trocar / Punta trequarti



	Ø	Ø	Ø	Ø	Ø
	3,5 mm	4,0 mm	4,5 mm	5,0 mm	6,0 mm
8 cm, 3 1/8"	34420-08	34421-08	34423-08	34425-08	34427-08
10 cm, 4"	34420-10	34421-10	34423-10	34425-10	34427-10
12 cm, 4 3/4"	34420-12	34421-12	34423-12	34425-12	34427-12
14 cm, 5 1/2"	34420-14	34421-14	34423-14	34425-14	34427-14
16 cm, 6 1/4"	34420-16	34421-16	34423-16	34425-16	34427-16
18 cm, 7"	34420-18	34421-18	34423-18	34425-18	34427-18
20 cm, 8"	34420-20	34421-20	34423-20	34425-20	34427-20
22 cm, 8 3/4"	34420-22	34421-22	34423-22	34425-22	34427-22
23 cm, 9"	34420-23	34421-23	34423-23	34425-23	34427-23
24 cm, 9 1/2"	34420-24	34421-24	34423-24	34425-24	34427-24
26 cm, 10 1/4"	34420-26	34421-26	34423-26	34425-26	34427-26
28 cm, 11"	34420-28	34421-28	34423-28	34425-28	34427-28
30 cm, 11 3/4"	34420-30	34421-30	34423-30	34425-30	34427-30

Steinmann
Trokarende / Trocar shaft
Punta trocar / Punta trequarti Bilateralis

Knochennägel
Fracture pins
Clavos para huesos
Chiodi per ossa

lieferbar in Packungen à 10 Stück
available in packages of 10 pieces
disponible en paquets de 10 unidades
disponibili solo in confezioni da 10 pezzi

Trokarspitze / Trocar point
Punta trocar / Punta trequarti



	Ø	Ø	Ø	Ø	Ø
	3,5 mm	4,0 mm	4,5 mm	5,0 mm	6,0 mm
8 cm, 3 1/8"	34428-08	34429-08	34431-08	34433-08	34435-08
10 cm, 4"	34428-10	34429-10	34431-10	34433-10	34435-10
12 cm, 4 3/4"	34428-12	34429-12	34431-12	34433-12	34435-12
14 cm, 5 1/2"	34428-14	34429-14	34431-14	34433-14	34435-14
16 cm, 6 1/4"	34428-16	34429-16	34431-16	34433-16	34435-16
18 cm, 7"	34428-18	34429-18	34431-18	34433-18	34435-18
20 cm, 8"	34428-20	34429-20	34431-20	34433-20	34435-20
22 cm, 8 3/4"	34428-22	34429-22	34431-22	34433-22	34435-22
23 cm, 9"	34428-23	34429-23	34431-23	34433-23	34435-23
24 cm, 9 1/2"	34428-24	34429-24	34431-24	34433-24	34435-24
26 cm, 10 1/4"	34428-26	34429-26	34431-26	34433-26	34435-26
28 cm, 11"	34428-28	34429-28	34431-28	34433-28	34435-28
30 cm, 11 3/4"	34428-30	34429-30	34431-30	34433-30	34435-30

Steinmann
mit 3-kant-Ende / with triangular end
con extremo triangular / con estremo triangolare

Trokarspitze / Trocar point
Punta trocar / Punta trequarti

mit Gewinde
threaded Wires
con rosca
con filetto



	Ø	15 cm, 6"	18 cm, 7"	20 cm, 8"	23 cm, 9"	25 cm, 10"	31 cm, 12 1/4"
1,6	34436-16	34437-16	34438-16	34439-16	34440-16	34441-16	
1,8	34436-18	34437-18	34438-18	34439-18	34440-18	34441-18	
2,0	34436-20	34437-20	34438-20	34439-20	34440-20	34441-20	
2,5	34436-25	34437-25	34438-25	34439-25	34440-25	34441-25	
2,8	34436-28	34437-28	34438-28	34439-28	34440-28	34441-28	
3,0	34436-30	34437-30	34438-30	34439-30	34440-30	34441-30	

mit rundem Ende / with round shaft
con extremo redondo / con estremo rotondo

lieferbar in Packungen à 10 Stück
 available in packages of 10 pieces
 disponible en paquets de 10 unidades
 disponibili solo in confezioni da 10 pezzi

Knochennägel
 Fracture pins
 Clavos para huesos
 Chiodi per ossa

Trokarspitze / Trocar point
 Punta trocar / Punta trequarti

mit Gewinde
 threaded Wires
 con rosca
 con filetto



Ø	15 cm, 6"	18 cm, 7"	20 cm, 8"	23 cm, 9"	25 cm, 10"	31 cm, 12 1/4"
1,6	34442-16	34443-16	34444-16	34445-16	34446-16	34447-16
1,8	34442-18	34443-18	34444-18	34445-18	34446-18	34447-18
2,0	34442-20	34443-20	34444-20	34445-20	34446-20	34447-20
2,5	34442-25	34443-25	34444-25	34445-25	34446-25	34447-25
2,8	34442-28	34443-28	34444-28	34445-28	34446-28	34447-28
3,0	34442-30	34443-30	34444-30	34445-30	34446-30	34447-30

Trokarende / Trocar shaft
 Punta trocar / Punta trequarti

Bohrdrahtspender
 K-Wire Dispenser
 Dispensador para brocas filiformes
 Distributore per fili

12 cm, 4 3/4"



17 cm, 6 3/4"



33 cm, 13"



34450-08 0,8 mm
 34450-10 1,0 mm
 34450-12 1,2 mm
 34450-14 1,4 mm
 34450-15 1,5 mm
 34450-16 1,6 mm
 34450-18 1,8 mm
 34450-20 2,0 mm
 34450-22 2,2 mm
 34450-25 2,5 mm
 34450-30 3,0 mm

34460-08 0,8 mm
 34460-10 1,0 mm
 34460-12 1,2 mm
 34460-14 1,4 mm
 34460-15 1,5 mm
 34460-16 1,6 mm
 34460-20 2,0 mm
 34460-22 2,2 mm
 34460-25 2,5 mm
 34460-30 3,0 mm

34470-08 0,8 mm
 34470-10 1,0 mm
 34470-12 1,2 mm
 34470-14 1,4 mm
 34470-15 1,5 mm
 34470-16 1,6 mm
 34470-20 2,0 mm
 34470-22 2,2 mm
 34470-25 2,5 mm
 34470-30 3,0 mm

Fingerschützer, Drahtgeflecht
Finger Protectors, Wire gauze
Dedales, Gasa metálica
Proteggidita, maglia metallica per estensione



34480-01



34480-02



34480-03

LANGENBECK
34480-01 - 34480-03



34492-01
klein / small / pequeño / stretto

34492-02
mittel / medium / mediano / medio

34492-03
groß / large / grande / grande

34492-01 - 34492-03

sterilisierbar
sterilizable
esterilizabile
sterilizzabile

Extensionsbügel
 Extension Bows
 Estribos para extensión
 Archi per estensione

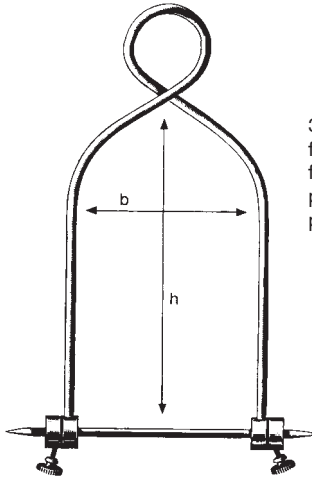

34502-16
 für Arm
 for arm
 para brazo
 per braccio

16 x 9 cm
 6 1/4" x 3 1/2"

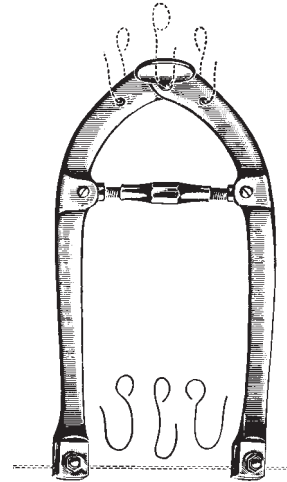

KIRSCHNER

BÖHLER

34502-15 21 x 15 cm 8 1/4" x 6"
 34502-21 21 x 11 cm 8 1/4" x 4 3/8"
 für Oberschenkel und Knie
 for thigh and knee
 para femur y rodilla
 per femore e ginocchio

34514-18 40 - 140 mm x 115 mm mit 3 Zughaken
 with 3 hooks
 con 3 ganchos
 con 3 ganci per trazione

34514-27 60 - 220 mm x 175 mm mit 3 Zughaken
 with 3 hooks
 con 3 ganchos
 con 3 ganci per trazione

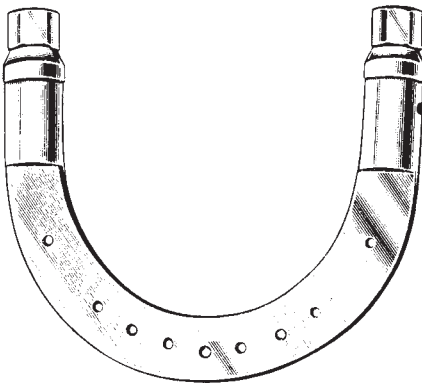

KIRSCHNER

34515-09 9,5 x 7,0 cm 3 3/4" x 2 3/4"
 34515-10 9,5 x 11,0 cm 3 3/4" x 4 3/8"
 34515-11 10,5 x 10,0 cm 4.1" x 4"
 34515-12 12,0 x 12,0 cm 4 3/4" x 4 3/4"
 34515-13 13,5 x 13,0 cm 5 1/4" x 5 1/8"
 34515-15 15,5 x 15,5 cm 6" x 6"
 34515-20 20,0 x 15,5 cm 8" x 6"

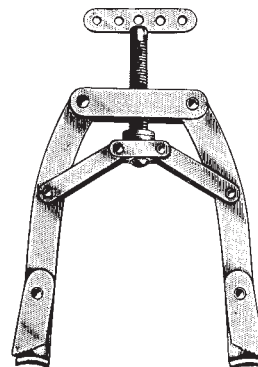

KIRSCHNER U.S.

34518-01
 mittel, medium, mediano, max. 130 mm (5 1/8")
 34518-02
 groß, large, grande, grande, max. 185 mm (7 1/4")

34518-03
 extra groß, large extra long, muy grande, max. 220 mm (8 3/4")

Spannschlüssel, Zughaken
Tightening wrench, hooks
Llave tensora, ganchos
Chiave, ganci per trazione



34515-01

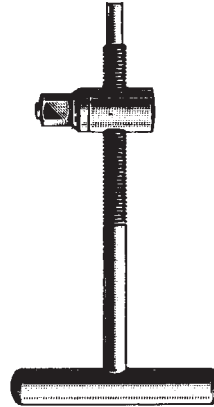

34515-02

KIRSCHNER
34519-01KIRSCHNER
34519-02

Knochendraht
Bone wire
Hilos para huesos
Filo per ossa



weich, in Ringen zu 10 m (32,8 Feet)
soft, in coils of 10 m (32,8 Feet)
blando, de 10 m (32,8 Feet)
morbido, 10 m (32,8 Feet)

Material:
nichtrostender Implantatstahl
nach DIN 17443 (ISO 5832/1)

	mm Ø
34520-02	0,2
34520-03	0,3
34520-04	0,4
34520-05	0,5
34520-06	0,6
34520-07	0,7
34520-08	0,8
34520-09	0,9
34520-10	1,0
34520-12	1,2
34520-15	1,5

Drahtumföhrungsnadeln, Drahtspanninstrumente
 Bone wire guides, Bone wire tighteners
 Agujas pasa-hilos, Tensor cierra-hilos
 Aghi passafili, Strumenti tendifili



DEMEL

27 cm, 10 1/2"

Fig. 1 34528-01

Fig. 2 34528-02

Fig. 3 34528-03

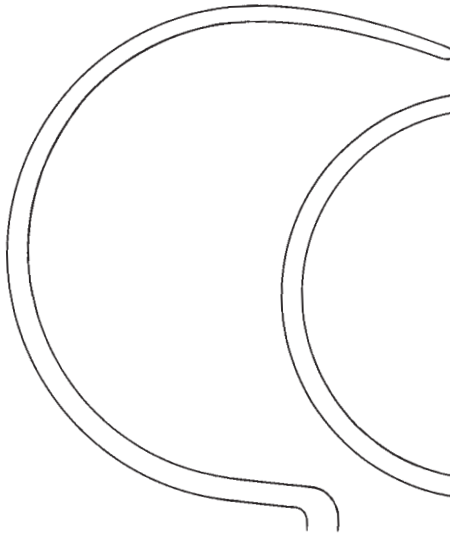

Fig. 1

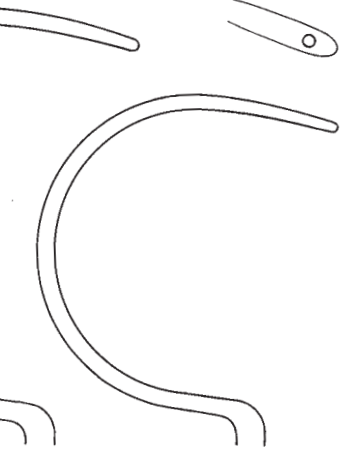

Fig. 2

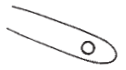
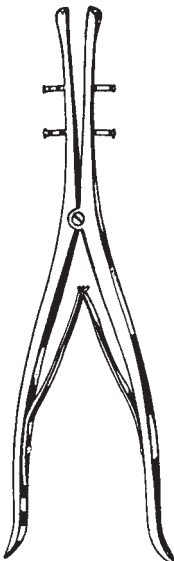
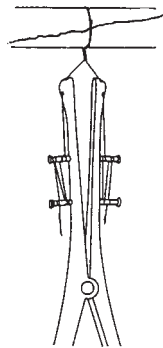

Fig. 3



DEMEL

34530-28 28 cm, 11"



LOUTE

34531-21 21 cm, 8 1/4"

Flachzangen, Faßzangen
 Flat Nose Pliers, Seizing Forceps
 Alicates planos, Pinzas para coger alambres
 Tenaglie piatte, Tenaglie per afferrare



17 cm, 6 3/4"
 34533-17



GRIP
 18 cm, 7"
 34534-18



34534-15
 15 cm, 6"



34535-16
 16 cm, 6 1/4"

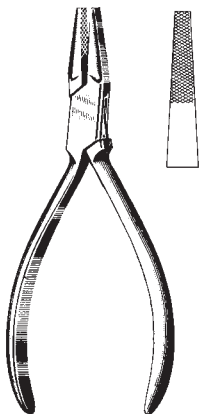

34536-14
 14 cm, 5 1/2"



34537-19
 19 cm, 7 1/2"

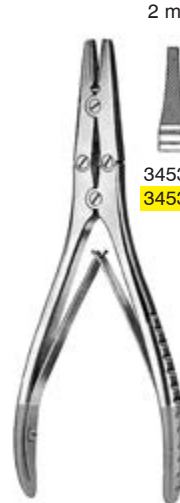

18 cm, 7"

2 mm

4 mm

6 mm



34538-01

34539-01 TC



34538-02

34539-02 TC



34538-03

34539-03 TC

Flachzangen, Drahtkneifzangen
Flat Nose Pliers, Wire cutting Pliers
Alicates planos, Alicates para cortar alambres
Tenaglie piatte, Tenaglie tagliafili



34540-01



34540-02



17 cm, 6 3/4"

34540-16
16 cm, 6 1/4"
soft wire 2,0 mm34540-18
18 cm, 7"34540-19
18 cm, 7"34540-20
20 cm, 8"

Drahtkneifzangen
Wire cutting Pliers
Alicates para cortar alambres
Tenaglie tagliafili



34541-23 TC 23 cm, 9"

soft wire 3,0 mm
hard wire 2,2 mm

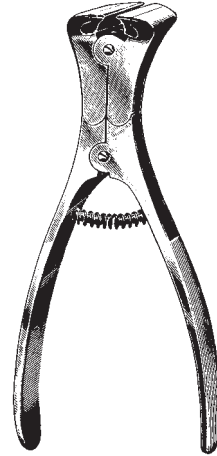

34542-15 TC 15 cm, 6"

Soft wire 2,0 mm
hard wire 1,5 mm



34543-23 TC 23 cm, 9"

Soft wire 3,5 mm
hard wire 2,5 mm



34544-18 TC 18 cm, 7"

Soft wire 2,5 mm
hard wire 1,5 mm

Drahtkneifzangen, Drahtfaßzangen
 Wire Cutting Pliers, Wire Seizing Forceps
 Alicates para cortar alambres, Pinzas para coger alambres
 Tronchese taglienti, Tenaglie per afferrare i fili



für harten Draht bis
2,2 mm Ø
for hard wires up to
2,2 mm Ø
para hilos duros
hasta 2,2 mm Ø
per fili duri a
2,2 mm Ø

für weichen Draht bis
2,5 mm Ø
for soft wires up to
2,5 mm Ø
para hilos blandos
hasta 2,5 mm Ø
per fili dolci fino a
2,5 mm Ø

34545-22 TC 22 cm, 8 3/4"

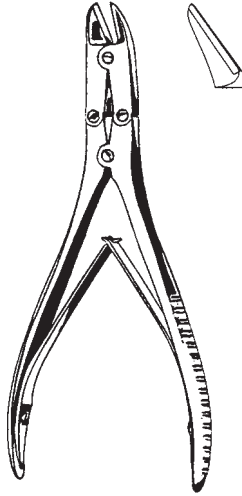

für harten Draht bis 1,6 mm Ø
for hard wires up to 1,6 mm Ø
para hilos duros hasta 1,6 mm Ø
per fili duri a 1,6 mm Ø

für weichen Draht bis 2,0 mm Ø
for soft wires up to 2,0 mm Ø
para hilos blandos hasta 2,0 mm Ø
per fili dolci fino a 2,0 mm Ø

34546-16 TC 16 cm, 6 1/4"
34546-18 TC 18 cm, 7"

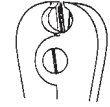

für weichen Draht bis
2,0 mm Ø
for soft wires up to
2,0 mm Ø
para hilos blandos
hasta 2,0 mm Ø
per fili dolci fino a
2,0 mm Ø

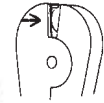

für harten Draht bis
1,6 mm Ø
for hard wires up to
1,6 mm Ø
para hilos duros
hasta 1,6 mm Ø
per fili duri a
1,6 mm Ø

34548-18 TC 18 cm, 7"



soft wire 1,5 mm
hard wire 1,0 mm

34549-14 TC 14 cm, 5 1/2"



34550-13 13 cm, 5 1/8"
34550-18 18 cm, 7"

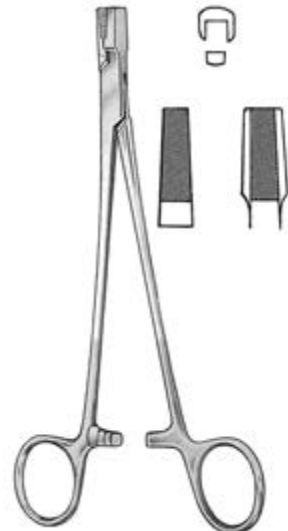

34551-17 TC 17 cm, 6 3/4"

Drahtzangen
 Wire Twisting Forceps
 Pinzas para torcer hilos
 Pinza torcifili



CORWIN-HEGAR
 34552-16 TC 16 cm, 6 1/4"



BERRY
 34556-18 TC 18 cm, 7"



MAYO-HABERISSER

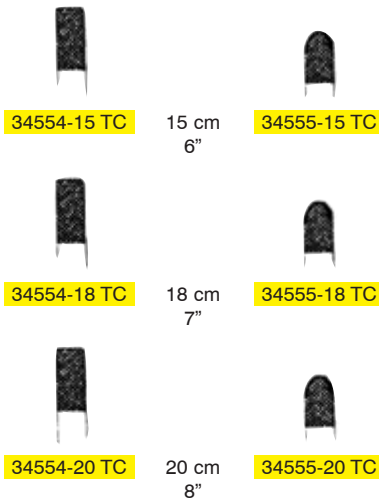

Drahtkneifzange
Pin cutter
Alicates para cortar clavos
Ghigliottina per tagliare fili fino



34557-22 22 cm, 8 ³/₄"
34557-25 25 cm, 10"
34557-30 30 cm, 11 ³/₄"



34558-32 32 cm, 12 ¹/₂"

bis 2.2 mm
up to 2.2 mm
hasta 2.2 mm
a 2.2 mm



bis 6 mm
up to 6 mm
hasta 6 mm
a 6 mm

34559-47 TC 47 cm, 18 ¹/₂"



bis 6.5 mm
up to 6.5 mm
hasta 6.5 mm
a 6.5 mm

34560-57 TC 57 cm 22 ¹/₂"

Drahtkneifzange
 Wire Cutter
 Alicate para alambre
 Tronchese tagliafili

HERCULES
34547-23 TC 23 cm / 9"

für Bohrdrähte bis max. 3 mm Ø
 über 40% Kraftersparnis durch Spezialmechanik
 auswechselbare Hartmetallschneiden
 auswechselbare Gummibacken
 komplett sterilisierbar

for drill wires of max 3 mm Ø
 over 40% less power required by special mechanic
 exchangeable TC-blades
 exchangeable rubber jaws
 full sterilisable

para taladros filiformes de max. 3 mm Ø
 reducción de la fuerza manual en más de un 40%
 placas de tungsteno intercambiables
 bocas de goma intercambiables
 complemente esterilizable

con riduzione di forza più del 40%
 Per fili perforatori fino a 3 mm
 Placche taglienti al TC intercambiabili
 Ganasce in gomma intercambiabili
 Completamente sterilizzabili

Ersatzteilsets
 Spare Part Sets
 Juegos de recambios
 Set per parti di ricambio

34547-01

1 Paar Hartmetallschneiden / 2 Paar Schrauben / 1 Inbusschlüssel
 1 pair of TC-blades / 2 pairs of screws / 1 Allen key
 1 par de placas de tungsteno / 2 pares de tornillos / 1 llave hexagonal
 1 Paio di placche TC / 2 Paio di viti da fissaggio / 1 chiave esagonale

34547-03

1 Paar Gummibacken / 1 Paar Schrauben
 1 pair of rubber jaws / 1 pair of screws
 1 par de bocas de goma / 1 par de tornillos
 1 Paio di ganasce in gomma / 1 Paio di viti da fissaggio

Drahtkneifzange
Wire Cutter
Alicate para alambre
Tronchese tagliafilii



HERCULES

34547-28 TC 28 cm / 11"

für Bohrdrähte ab 2,5 - 4,0 mm
über 40% Kraftersparnis durch Spezialmechanik
auswechselbare Hartmetallschneiden
auswechselbare Gummibacken
komplett sterilisierbar

for drill wires of 2.5 - 4.0 mm
over 40% less power required by special mechanic
exchangeable TC-blades
exchangeable rubber jaws
full sterilisable

para taladros filiformes de 2,5 - 4,0 mm
reducción de la fuerza manual en más de un 40%
placas de tungsteno intercambiables
bocas de goma intercambiables
complemente esterilizable

con riduzione di forza più del 40%
Per fili perforatori fino a 2,5 - 4,0 mm
Placche taglienti al TC intercambiabili
Ganasce in gomma intercambiabili
Completamente sterilizzabili

Ersatzteilsets
Spare Part Sets
Juegos de recambios
Set per parti di ricambio



34547-02

1 Paar Hartmetallschneiden / 2 Paar Schrauben / 1 Inbusschlüssel
1 pair of TC-blades / 2 pairs of screws / 1 Allen key
1 par de placas de tungsteno / 2 pares de tornillos / 1 llave hexagonal
1 Paio di placche TC / 2 Paio di viti da fissaggio / 1 chiave esagonale



34547-03

1 Paar Gummibacken / 1 Paar Schrauben
1 pair of rubber jaws / 1 pair of screws
1 par de bocas de goma / 1 par de tornillos
1 Paio ganasce in gomma / 1 Paio di viti da fissaggio

Drahtkneifzange
Wire Cutter
Alicate para alambre
Tronchese tagliafili

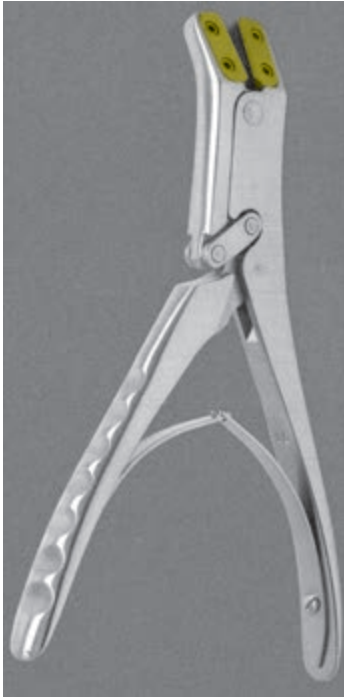

für Rechtshänder / for right-handers /
para la mano derecha / per mano destra

HERCULES

35548-18 TC 18 cm / 7"

für Bohrdrähte bis max. Ø 2,2 mm
über 40% Kraftersparnis durch Spezialmechanik, auswechselbare
Hartmetallschneiden
auswechselbare Gummibacken
komplett sterilisierbar

for drill wires of max 0 2.2 mm
over 40% less power required by special mechanic
exchangeable TC-blades
exchangeable rubber jaws
full sterilisable

para taladros filiformes de max. Ø 2,2 mm
reducción de la fuerza manual en más de un 40%
placas de tungsteno intercambiables
bocas de goma intercambiables
complemente esterilizable

con riduzione di forza più del 40%
Per fili perforatori da 2,2 mm
Utilizzabile a scelta per mano sinistra e destra
Placche taglienti al TC intercambiabili
Ganasce in gomma intercambiabili
Completamente sterilizzabili



Ersatzteilsets
Spare Part Sets
Juegos de recambios
Set per parti di ricambio



35547-01
1 Paar Hartmetallschneiden / 2 Paar Schrauben / 1 Inbusschlüssel
1 pair of TC-blades / 2 pairs of screws / 1 Allen key
1 par de placas de tungsteno / 2 pares de tornillos / 1 llave hexagonal
1 Paio di placche TC / 2 Paio di viti da fissaggio / 1 chiave esagonale



34547-03
1 Paar Gummibacken / 1 Paar Schrauben
1 pair of rubber jaws / 1 pair of screws
1 par de bocas de goma / 1 par de tornillos
1 Palo ganasce in gomma / 1 Paio di viti da fissaggio



Instrumentarium für Ender und Küntscher Nägel
 Instruments for ender and Küntscher Nails
 Instrumental para Clavos Ender y Küntscher
 Strumentario per chiodi di Ender e Küntscher

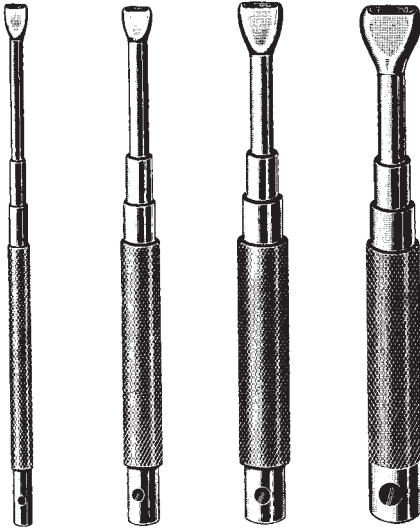

34562-24	34562-32	34562-48	34562-64
f./p. Ø 2,4 mm	3,2 mm	4,8 mm	6,4 mm

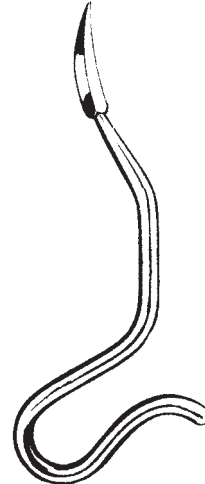

KÜNTSCHER	26 cm, 10 1/4"
34570-01	8 mm
34570-02	10 mm

Ein- und Ausschlaginstrumente für Ender-Nägel
 Driver-extractors for Ender nails
 Impactores-Extractores para clavos de Ender
 Impattatore-Estrattore per chiodi di Ender

Vorbohrer zum Öffnen der Markhöhle
 Reamers for medullary cave
 Perforadores para la cavidad medular
 Alesatore per l'apertura del midollo



KÜNTSCHER
 34573-35 35 cm, 13 3/4"
 Aufreiber für Oberschenkel
 Reamer for femur
 Perforador para fémur
 Alesatore per femore



mm Ø	L = 60 cm, 23 3/4"
3,5	34583-60
4,0	34584-60
5,0	34585-60

Führungsspieße
 Guide pins
 Guía-conductora para clavos medulares
 Guida conduttrice



für Nägel for nails para clavos per chiodi
Ø 6-8 mm 34588-01
Ø 9-12 mm 34588-02
Ø 12-17 mm 34588-03

KUENTSCHER 19 cm, 7 1/2"
 Fertigschläger
 Nail impactors
 Impactor final
 Impattatore finale

Instrumentarium für Küntscher Nägel
 Instruments for Küntscher Nails
 Instrumental para Clavos Küntscher
 Strumentario per chiodi di Küntscher



34590-01



34590-02

KÜNTSCHER

34590-00 63 cm, 24 3/4"

komplett mit 2 Haken 34590-01/02

complete with 2 hooks 34590-01/02

completo con 2 ganchos 34590-01/02

completo con 2 ganci 34590-01/02

Extraktor

Nail extractor

Aparato extractor

Estrattore



Extraktionshaken

Extraction hooks

Ganchos extractores

Gancio d'estrazione

34596-29 29 cm 11.4"

34596-37 37 cm 14.5"

34596-42 42 cm 16.5"

34596-49 49 cm 19.3"



Markraumborher

Intramedullary drills

Perforadores medulares

Perforatore intramidollare

Ø

6,0 mm 34597-06

7,0 mm 34597-07

8,0 mm 34597-08

9,0 mm 34597-09

10,0 mm 34597-10

11,0 mm 34597-11

12,0 mm 34597-12

13,0 mm 34597-13

14,0 mm 34597-14

15,0 mm 34597-15

16,0 mm 34597-16

17,0 mm 34597-17

18,0 mm 34597-18

19,0 mm 34597-19

20,0 mm 34597-20

Instrumentarium für Küntscher Nägel
Instruments for Küntscher Nails
Instrumental para Clavos Küntscher
Strumentario per chiodi di Küntscher



Einschläger / Nail Inserter
Introducer clavos / Impattore
34612-00



Impactor
34613-00



BENDER
34615-00

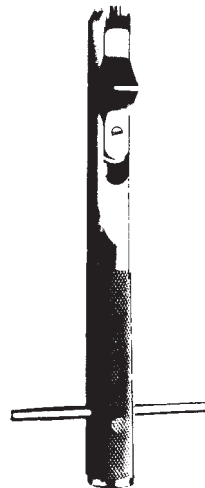

Impactor-Extractor
Impattore-Estrattore
34617-00



Schraubenzieher
Screw Drivers
Destornilladores
Cacciaviti

6 mm



LANE
34620-25 25 cm, 10"

3,5 mm



34624-01



34624-02



WILLIAMS
24 cm, 9 1/2"



34624-03



34624-04



mit Ferrozellgriff
with Ferrozell handle
con mango de Ferrozell
con manico di Ferrozell



34628-01
25 cm, 10"



34628-02
25 cm, 10"



34629-01
25 cm, 10"



1,5 mm

34628-15
20 cm, 8"



2,5 mm

34628-25
25 cm, 10"



3,5 mm

34628-35
25 cm, 10"

Schraubenzieher
Screw Drivers
Destornilladores
Cacciaviti



LANE
34632-25 25 cm, 10"
Kreuzschlitzschraubenzieher
Screwdriver for cross slotted head
Destornillador para tornillos con ranura en cruz
Cacciavite a croce

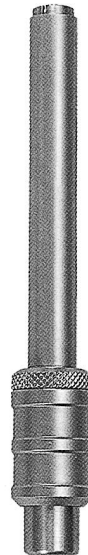

Schraubenhaltehülse für Sechskantschrauben
Screw holder
Vaina para tornillos
Guaina per viti esagonali
34634-35 3,5 mm

Haltezangen, Biegehebel
 Holding Forceps, Bender
 Pinzas para sostener placas y tornillos, Palanca
 Pinza portaplacca, leva piegaplacche

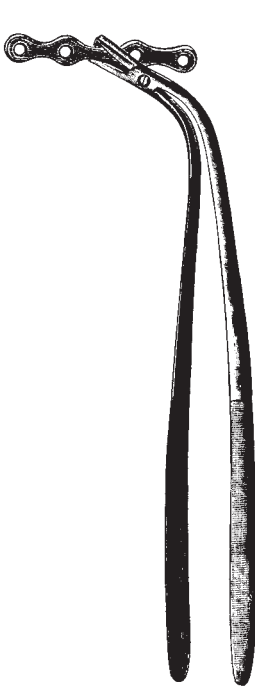

LANE
 34637-23 23 cm, 9"

Knochenplatten-Haltezange
 Plate Holding Forceps
 Pinza para sostener placas
 Pinza portaplacche



LANE
 34639-22 22 cm, 8 3/4"

Schraubenhalte-
 zange
 Screw Holding
 Forceps
 Pinza para sostener
 tornillos
 Pinza portaviti

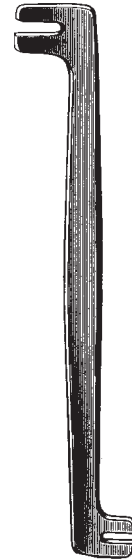

LANE
 34640-18 18 cm, 7"

Biegehebel f. Knochenplatten
 Plate Bender
 Palanca para doblar placas
 Leva piegaplacche

Anlegezangen, Silberklammern
 Applying Fcps. Clips
 Pinzas aplicadoras, Grapas
 Pinza per applicare, Agrafes

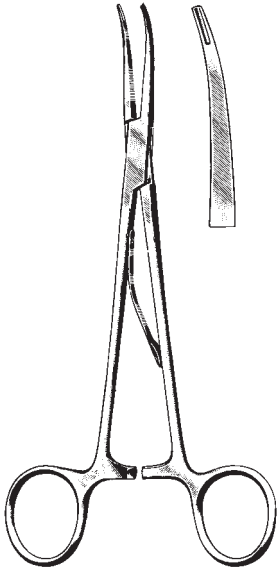

McKENZIE

41011-15 15 cm, 6"
 41011-19 19 cm, 7 1/2"

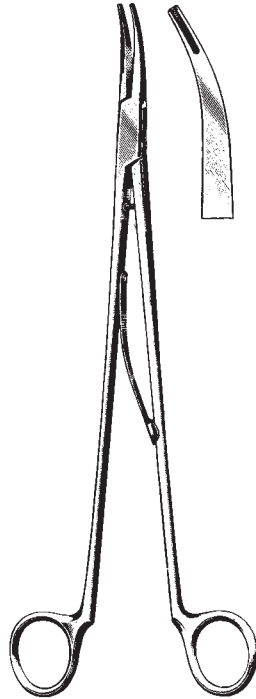

SMITHWICK

41015-23 23 cm, 9"
 41015-26 26 cm, 10 1/4"

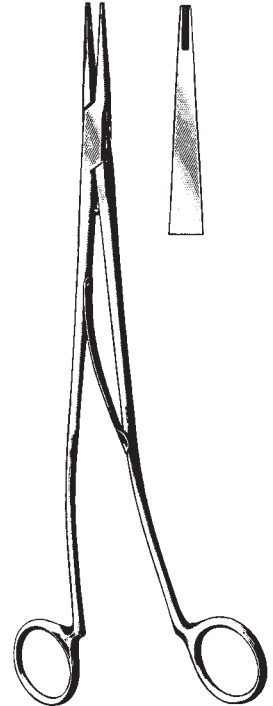

SWEET

41017-23 23 cm, 9"
 41017-26 26 cm, 10 1/4"



OLIVECRONA-TOENNIS
 41019-14

41020-00
 148 x 40 x 6 mm

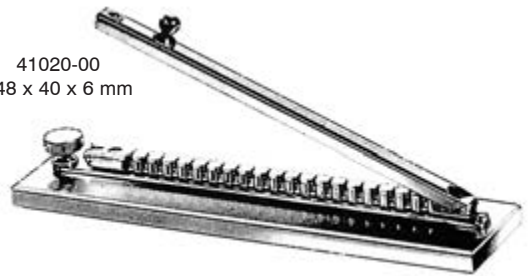

41021-00
 (100 pcs.)



Schädelhalter, Kopfhautklammer, Anlegezange
 Cervical Traction Tongs, Clips, Applying Forceps
 Pinzas de tracción craneal, Clips, Pinza para aplicar clips
 Pinze per trazione craniale, Pinza per applicare

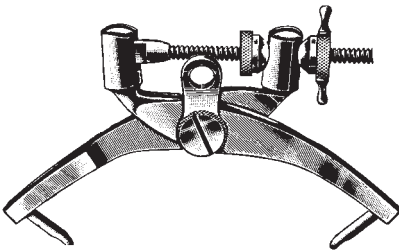

CRUTCHFIELD
41025-01



CRUTCHFIELD
41025-02



41026-35
3,5 mm Ø



41026-50
5 mm Ø

Stainless steel
Acciaio inox



RANEY
41027-00



RANEY
41028-00 16 cm, 6 1/4"

Nervhaken, Durahaken
 Nerve Hooks, Dura Hooks
 Ganchos para nervios y para dura-madre
 Uncini per nervi e per dura-madre



DANDY
 41051-20
 20 cm, 8"



DANDY
 41052-20
 20 cm, 8"



DANDY
 41053-20
 20 cm, 8"



CRILE
 41054-20
 20 cm, 8"

Fig. 1



CUSHING
 41056-18 18 cm, 7"
 41056-28 28 cm, 11"

Fig. 2



CUSHING
 41058-18 18 cm, 7"
 41058-28 28 cm, 11"

Nervhaken, Durahaken
Nerve Hooks, Dura Hooks
Ganchos para nervios y para dura-madre
Unicini per nervi e per dura-madre



GRAHAM
41061-16
16,5 cm, 6 1/2"



SACHS
41064-16
18,5 cm, 7 1/4"



ADSON
41068-20
20 cm, 8"



ADSON
41069-20
20 cm, 8"



SMITHWICK
41070-29
29 cm, 11.4"

Nervwurzelhaken
 Nerve Root Retractors
 Separadores de raiz de nervios
 Uncini per le radici dei nervi

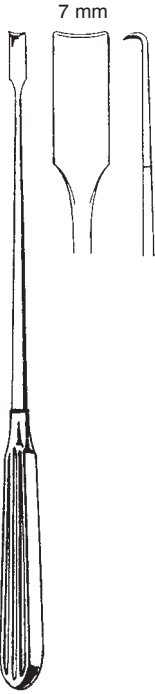

SCOVILLE
 41074-23
 23 cm, 9"

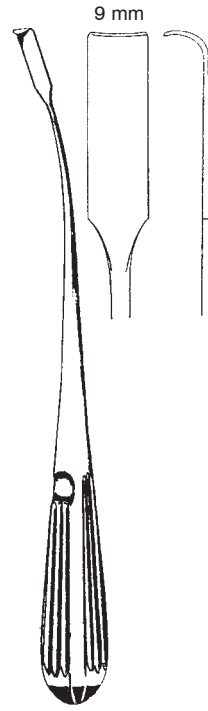

HOLSHER
 41075-24
 24 cm, 9 1/2"

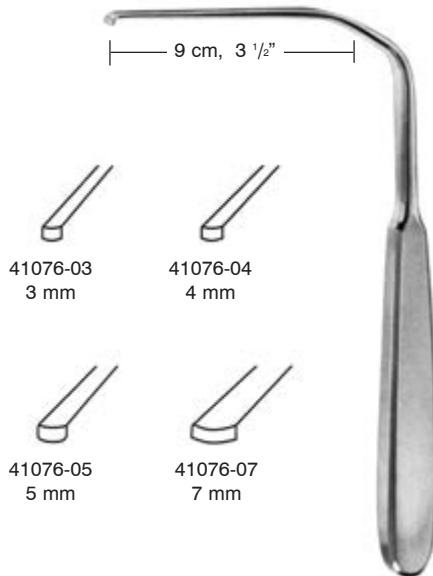

HESS
 17,5 cm, 7"

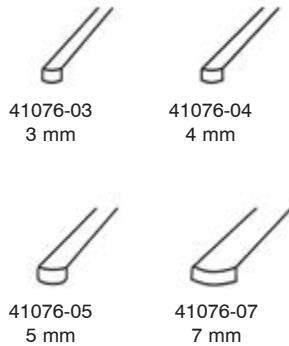

Nervwurzelhaken
Nerve Root Retractors
Separadores de raiz de nervios
Uncini per le radici dei nervi

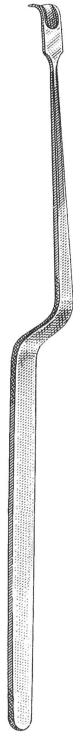

D'ERRICO
41078-23
23 cm, 9"



LOVE
41079-21
21 cm, 8 1/4"

Nervwurzelhaken, Galeahaken
 Nerve Root Retractors, Galea Hooks
 Separadores de raiz de nervios, Gancho para galea
 Uncini per le radici dei nervi, Uncini galea

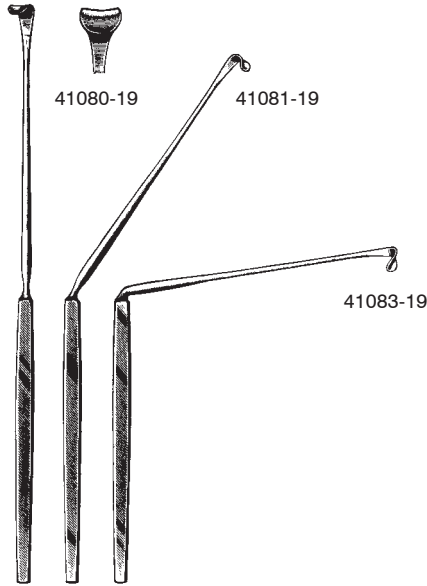

LOVE
 41080-19 – 41083-19
 19 cm, 7 1/2"

SCOVILLE
 41085-20
 20 cm, 8"



DeMARTEL
 41090-33
 33 cm, 13"



YASARGIL
 41091-31
 31 cm, 12 1/4"

Galeahaken
 Galea Hooks
 Gancho p/galea
 Gancio p/galea

Ø 7 mm

4 mm



YASARGIL
 41091-41
 41 cm, 16"

Ø 9 mm

6 mm

Schädelstanze
Cranial Punch
Pinzas sacabocado craneal
Pinza per craniotomia



CONE
41097-22
22,5 cm 9"

Drahtsägen, Schädelzange, Dura Dissektoren
 Wire Saws, Skull Punches, Dura Dissectors
 Sierras de hilo, Pinzas sacabocado craneal, Elevadores para la duramadre
 Fili sega, Pinza per craniotomia, Scollatori per duramadre

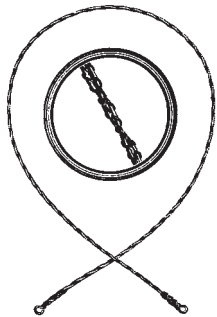

OLIVECRONA	cm
41092-30	30, 11 3/4"
41092-40	40, 15 3/4"
41092-50	50, 19 3/4"
41092-60	60, 23 3/4"
41092-70	70, 27 1/2"

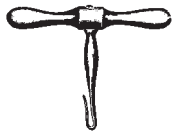

GIGLI
 41094-00
 Drahtsägen-Handgriff
 Wire Saw Handle
 Mango de gancho
 Manico con uncino



DeVILBISS
 41096-21
 21 cm, 8 1/4"

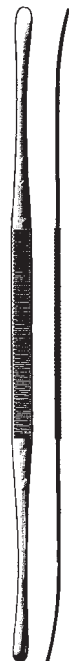

TOENNIS
 41141-25
 25 cm, 10"

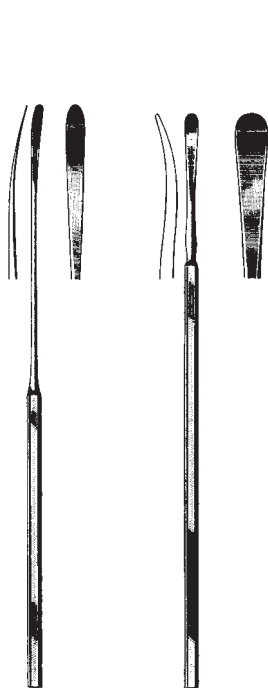

SACHS	SACHS
41143-21	41145-21
21 cm, 8 1/4"	21 cm, 8 1/4"

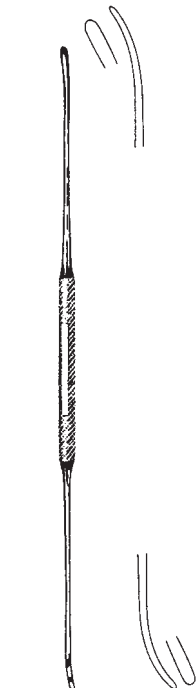

OLIVECRONA
41146-18 18 cm, 7"
41146-24 24 cm, 9 1/2"

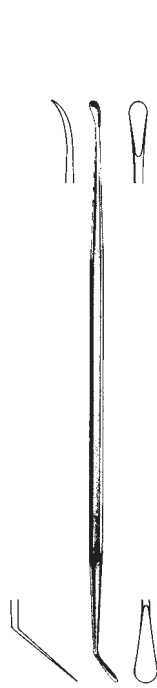

MILLIGAN
41147-21 21 cm, 8 1/4"

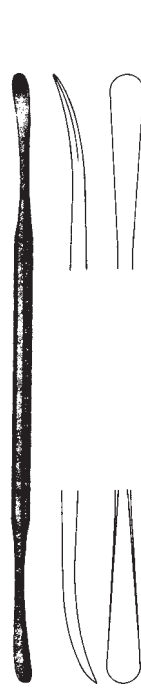

41149-22 22 cm, 8 3/4"

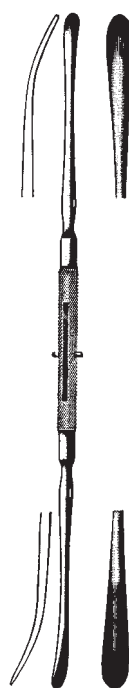

DAVIS
41151-24 24 cm, 9 1/2"

Dura Dissektoren
Dura Dissectors
Elevadores
Scollatori

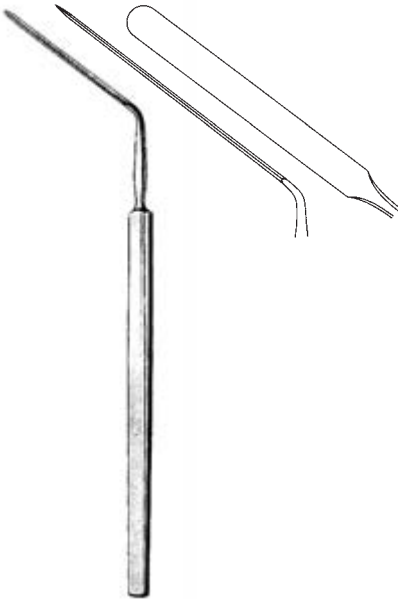

HORSLEY
41155-20
20 cm, 8"



WOODSON
41156-18
18 cm, 7"



FRAZIER
41158-01
15 cm, 6"



HOEN
41158-02
15 cm, 6"

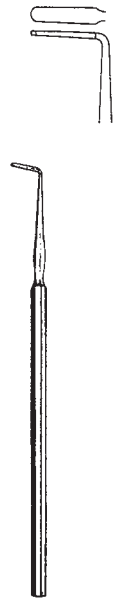

HOEN
41158-03
15 cm, 6"



PENFIELD
41161-01
17,5 cm, 6.9"



PENFIELD
41161-02
19,5 cm, 7 3/4"



PENFIELD
41161-03
19,5 cm, 7 3/4"



PENFIELD
41161-04
21,5 cm, 8 1/2"



PENFIELD
41161-05
29 cm 11.4"

Hypophyse Pinzetten, Küretten
 Hypophyseal Forceps, Curette
 Pinzas para hipófisis, Curetas
 Pinze per ipofisi, Curette



ADSON
 41210-23
 23 cm, 9°



ADSON
 41211-23
 23 cm, 9°



ADSON
 41213-23
 23 cm, 9°



RAY
 41221-00
 19 cm, 7 1/2°



RAY
 41222-00
 19 cm, 7 1/2°



RAY
 41223-00
 19 cm, 7 1/2°



RAY
 41224-00
 19 cm, 7 1/2°

Gefäß-Messer, Haken, Sonden
 Vessel-Knives, Hooks, Probes
 Bisturies, Ganchos, Sondas
 Bisturi, Uncino, Sonde

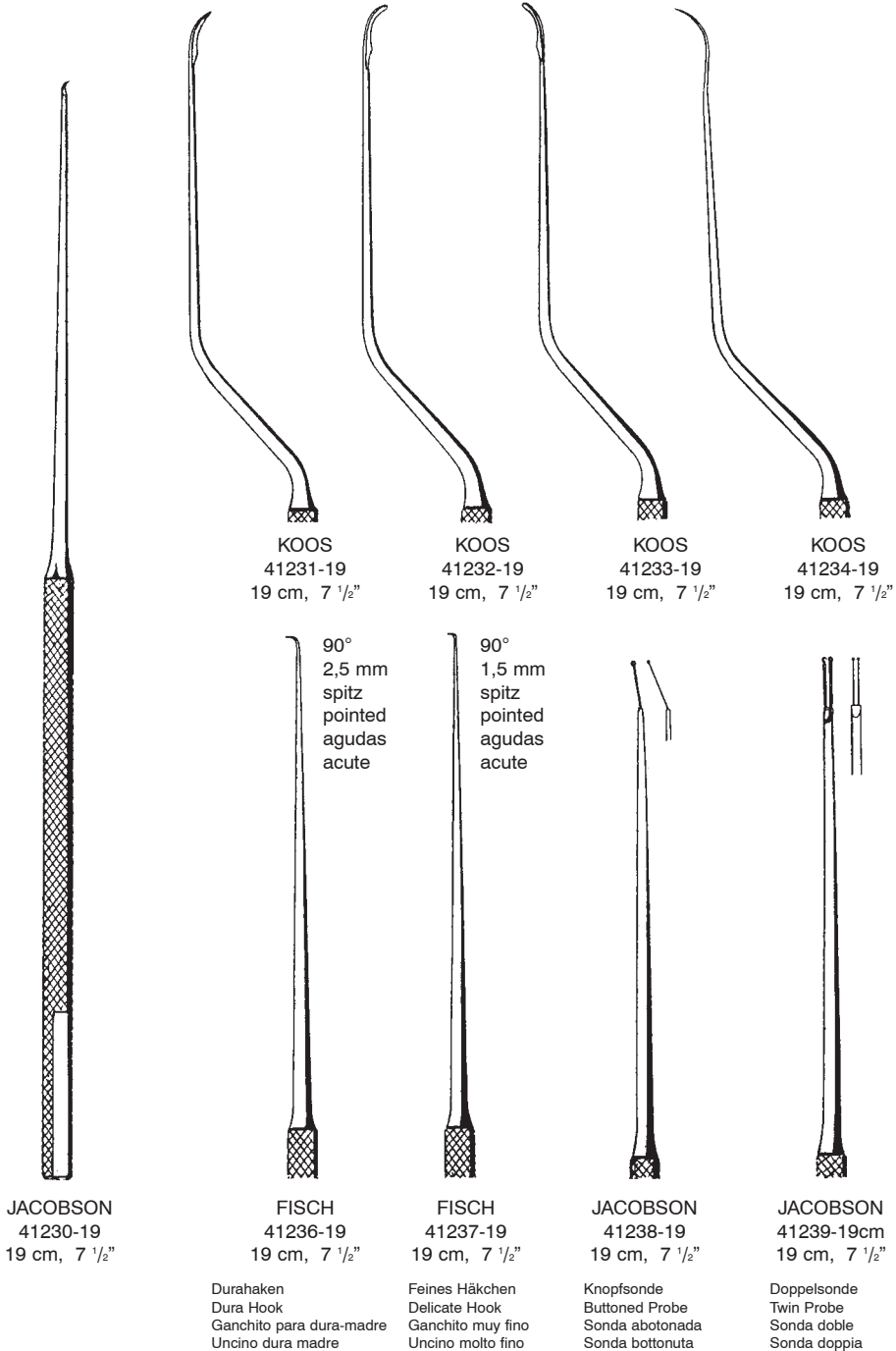

Nervhäkchen, Hirnspatel, Saugrohre

Nerve Hooks, Brain Spatulas, Suction Tubes

Ganchos para nervios, Espatulas cerebrales, Tubos de aspiración

Uncini per nervi, Spatole cerebrali, Tubi aspirazioni



KRAYENBÜHL
41242-19
19 cm, 7 1/2"



KRAYENBÜHL
41243-19
19 cm, 7 1/2"



KRAYENBÜHL
41244-19
19 cm, 7 1/2"



KRAYENBÜHL
41245-19
19 cm, 7 1/2"

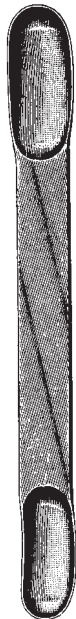

CUSHING
18 cm, 7"

41250-11 8x10 mm
41250-15 13x15 mm
41250-18 16x18 mm

konkav
concave
cóncavo
concavi

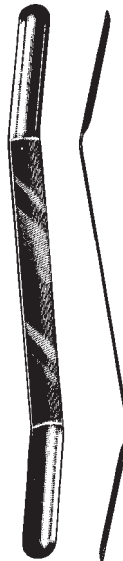

OLIVECRONA

18 cm, 7" mm
41253-07 7/ 9
41253-11 11/13
41253-15 15/18
41253-18 18/22



BARON

41299-03 3FR 1,0 mm
41299-05 5FR 1,6 mm
41299-07 7FR 2,3 mm

Hirnspatel, Saugrohre, Punktionskanüle
 Brain Spatulas, Suction Tubes, Puncture Cannulas
 Espatulas cerebrales, Tubos de aspiración, Tubo de punción
 Spatole cerebrali, Tubi aspirazioni, cannula per punzione



biegsam
 malleable
 maleable
 malleabile

DAVIS 18 cm, 7"

41254-06	6 mm, 1/4"
41254-10	9 mm, 3/8"
41254-13	13 mm, 1/2"
41254-16	16 mm, 5/8"
41254-19	19 mm, 3/4"
41254-25	25 mm, 1"
41254-32	32 mm, 1 1/4"
41254-38	38 mm, 1 1/2"



ADSON

41290-21
 21 cm, 8 1/4"
 ø 4 mm



isoliert
 isolated
 isolada
 isolato

FERGUSON

41294-40
 18 cm, 7"
 ø 4 mm, 90°

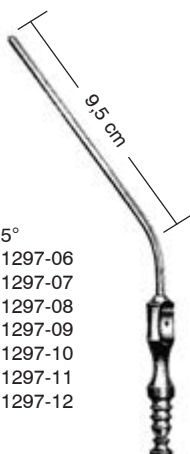

Charr.	↗	
F.G.	30°	75°
6	41295-06	41297-06
7	41295-07	41297-07
8	41295-08	41297-08
9	41295-09	41297-09
10	41295-10	41297-10
11	41295-11	41297-11
12	41295-12	41297-12
15	41295-15	

FRAZIER / FERGUSON
 41295-06 – 41297-12
 19 cm, 7 1/2"



FRAZIER / FERGUSON
 41298-12
 12 cm, 4 3/4" / 3 mm

Saugrohre
Suction Tubes
Tubos de aspiración
Tubi aspirazioni

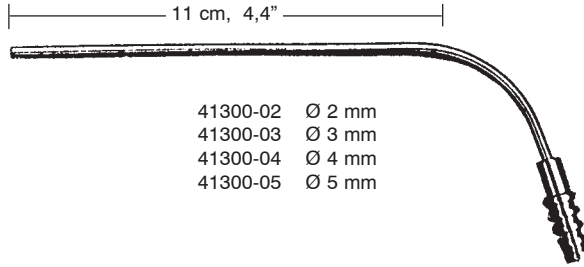

41300-02 Ø 2 mm
41300-03 Ø 3 mm
41300-04 Ø 4 mm
41300-05 Ø 5 mm

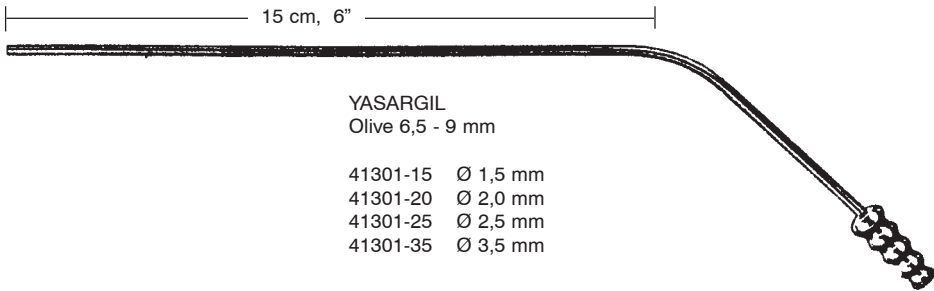

YASARGIL
Olive 6,5 - 9 mm

41301-15 Ø 1,5 mm
41301-20 Ø 2,0 mm
41301-25 Ø 2,5 mm
41301-35 Ø 3,5 mm

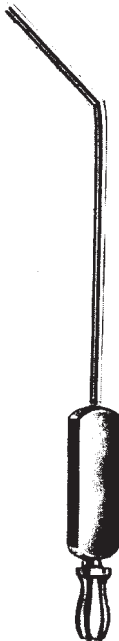

ZÖLLNER
41302-02



0,5 mm Ø 41306-05
0,7 mm Ø 41306-07
0,9 mm Ø 41306-09
1,2 mm Ø 41306-12

Kanüle für Sauggriff für ZÖLLNER und WULLSTEIN
Tip for Suction Handle for ZÖLLNER and WULLSTEIN
Cánula para mango t ZÖLLNER y WULLSTEIN
Cannula per manico di aspirazione t ZÖLLNER e WULLSTEIN

Saugrohre
Suction Tubes
Tubos de aspiración
Tubi aspirazioni

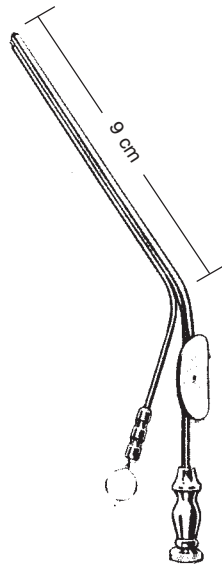

HOUSE

9 cm, 3 1/2"

41303-09	Ø 0,9 x 0,7 mm
41303-12	Ø 1,2 x 0,9 mm
41303-15	Ø 1,5 x 1,2 mm
41303-18	Ø 1,8 x 1,8 mm
41303-25	Ø 2,5 x 2,0 mm
41303-30	Ø 3,0 x 2,0 mm
41303-45	Ø 4,5 x 2,0 mm

Saugrohre, Saugkanülen
 Suction Tubes, Suction Cannulae
 Tubos de aspiración, Cánulas para aspiración
 Tubi aspirazioni, Cannule per aspirazione



Sauggriff
 Suction Handle
 Mango de aspiración
 Manico per aspirazione

WULLSTEIN
 41307-00



Kanüle für Sauggriff
 Tip for Suction Handle
 Cánula para mango
 Cannula per manico di aspirazione

ROSEN
 10 cm, 4"

0,5 mm Ø	41305-05	1,2 mm Ø	41305-12
0,6 mm Ø	41305-06	1,5 mm Ø	41305-15
0,7 mm Ø	41305-07	1,8 mm Ø	41305-18
0,8 mm Ø	41305-08	2,0 mm Ø	41305-20
0,9 mm Ø	41305-09	2,5 mm Ø	41305-25
1,0 mm Ø	41305-10	3,0 mm Ø	41305-30



Charr. 6 41304-06
 Charr. 8 41304-08
 Charr. 10 41304-10

PLESTER
 30°



biegsam
 malleable
 maleable
 malleabile

SCHMID
 15 cm, 6"

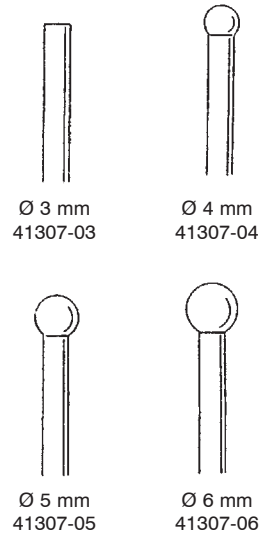

Wirbelkörperspreizer
Lamina Spreaders
Separadores para cuerpos vertebrales
Divaricatori per corpi vertebrali

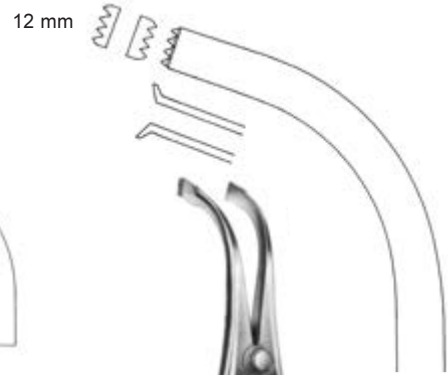

CLOWARD
41401-16
16 cm, 6 1/4"



INGE
41405-17
17 cm, 6 3/4"



INGE
41405-27
27 cm, 10 1/2"



19 mm

CLOWARD
41406-01
12,5 cm, 5"

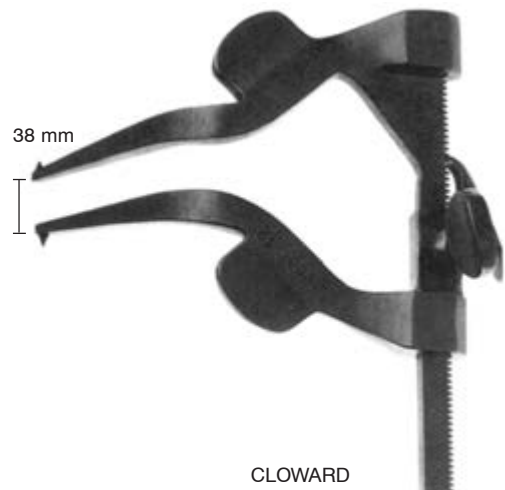

38 mm

CLOWARD
41406-02
7,6 cm, 3"

Laminektomie Zangen
 Laminectomy Rongeurs
 Pinzas cortantes para laminectomia
 Pinze taglienti per laminectomia

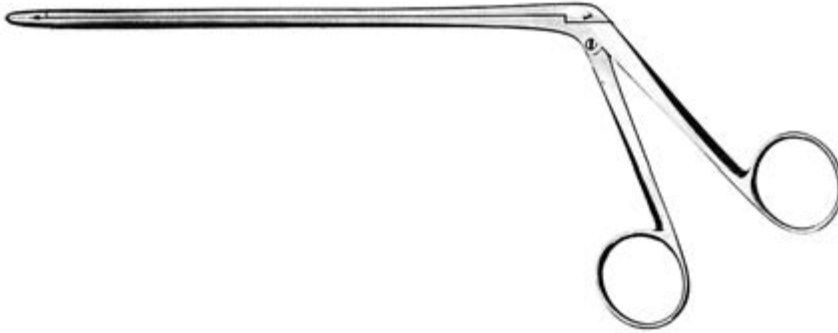

CUSHING

2 mm



2x10 mm L
 41420-01 12,5 cm
 41421-01 15,0 cm
 41422-01 18,0 cm

2x10 mm/45° L
 41420-02 12,5 cm
 41421-02 15,0 cm
 41422-02 18,0 cm

2x10 mm/45° L
 41420-03 12,5 cm
 41421-03 15,0 cm
 41422-03 18,0 cm

LOVE-GRUENWALD

3 mm

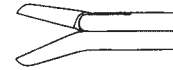

3x10 mm L
 41430-01 12,5 cm
 41431-01 15,0 cm
 41432-01 18,0 cm

3x10 mm/45° L
 41430-02 12,5 cm
 41431-02 15,0 cm
 41432-02 18,0 cm

3x10 mm/45° L
 41430-03 12,5 cm
 41431-03 15,0 cm
 41432-03 18,0 cm

SPURLING

4 mm

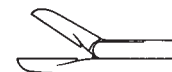

4x10 mm L
 41440-01 12,5 cm
 41441-01 15,0 cm
 41442-01 18,0 cm

4x10 mm/45° L
 41440-02 12,5 cm
 41441-02 15,0 cm
 41442-02 18,0 cm

4x10 mm/45° L
 41440-03 12,5 cm
 41441-03 15,0 cm
 41442-03 18,0 cm

Laminektomie Zangen
Laminectomy Rongeurs
Pinzas cortantes para laminectomia
Pinze taglienti per laminectomia

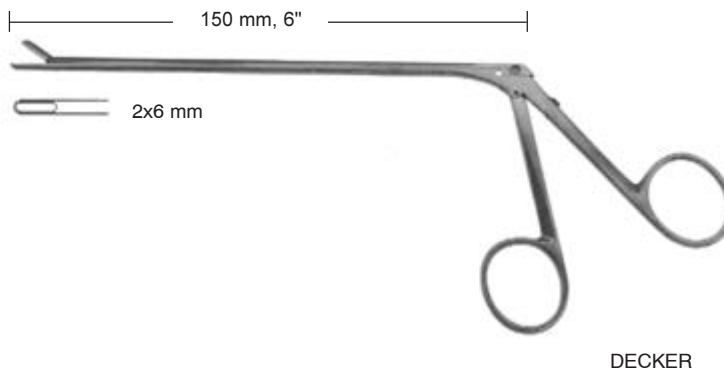
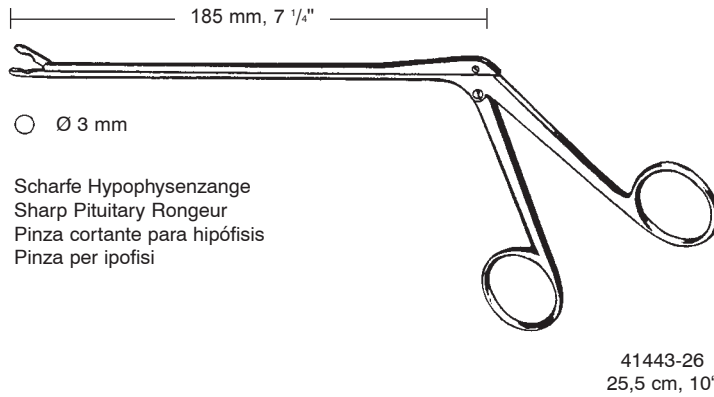

Laminektomie Zangen
Laminectomy Rongeurs
Pinzas cortantes para laminectomia
Pinze taglianti per laminectomia

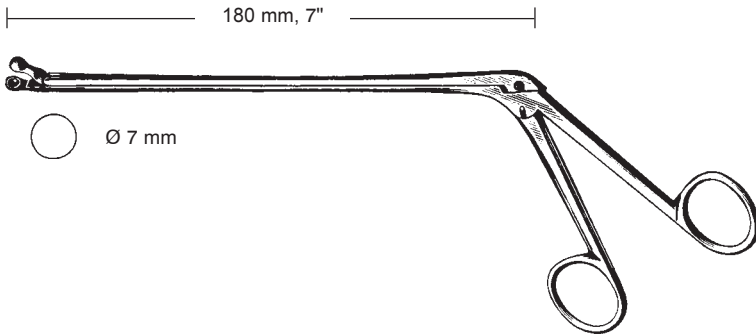

OLDBERG
41445-25
25 cm, 9.8"



PEAPOD
41446-00

Laminektomie Zangen
Laminectomy Rongeurs
Pinzas cortantes para laminectomia
Pinze taglienti per laminectomia

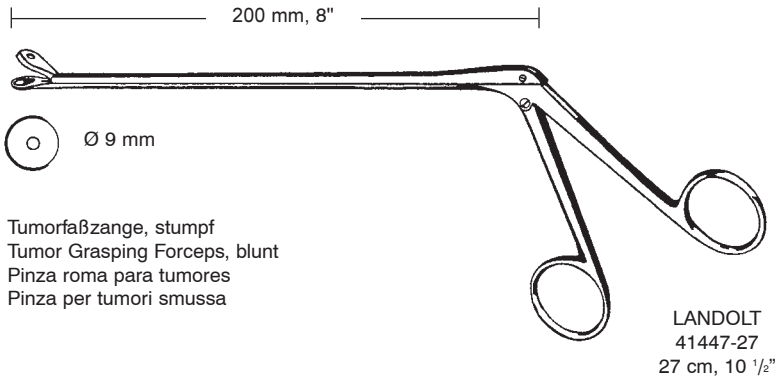



Laminektomie Zangen
 Laminectomy Rongeurs
 Pinzas cortantes para laminectomia
 Pinze taglienti per laminectomia

150 mm, 6"



SCHLESINGER
 41448-02 2 x 10 mm
 41448-03 3 x 10 mm
 41448-04 4 x 10 mm

150 mm, 6"

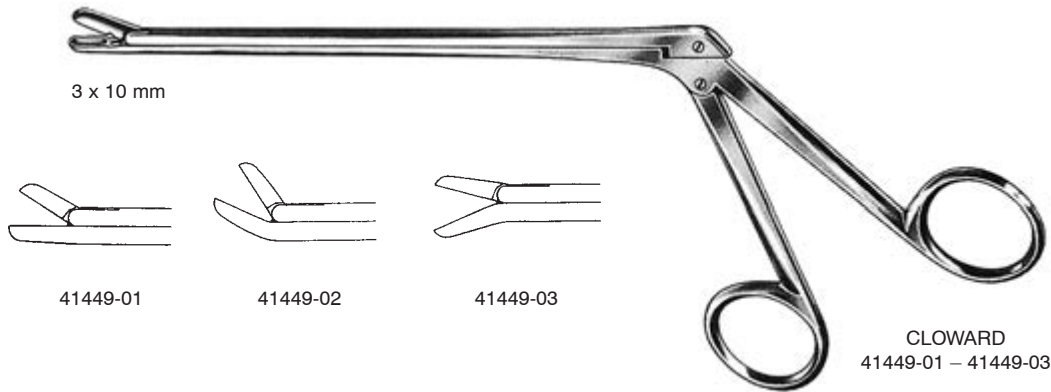





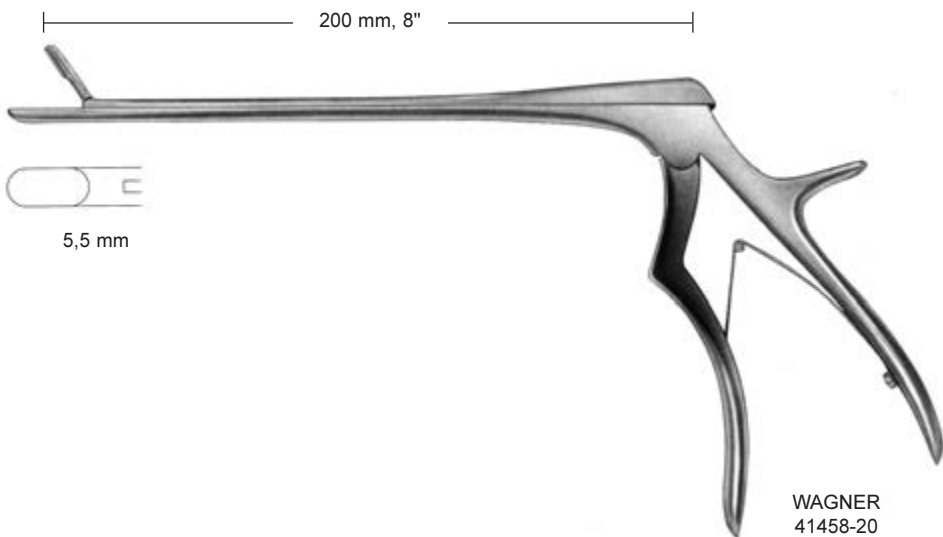
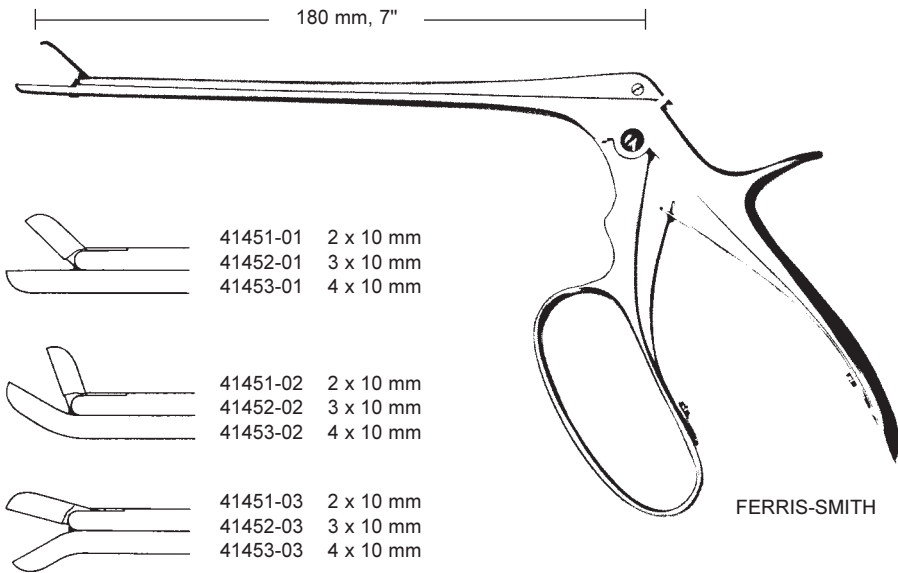

CLOWARD
 41449-01 – 41449-03

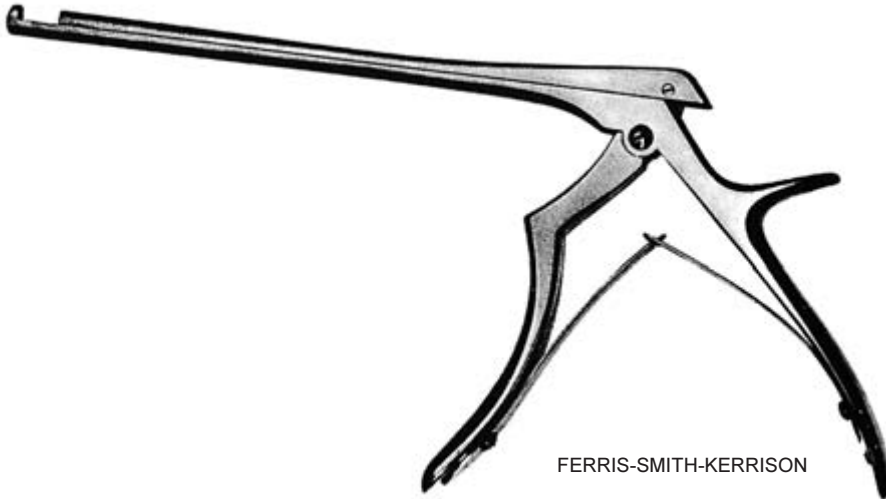
Laminektomie Zangen
 Laminectomy Rongeurs
 Pinzas cortantes para laminectomia
 Pinze taglienti per laminectomia



Bandscheibenstanzen
 Intervertebral Disc Rongeurs
 Pinzas sacabocado para discos intervertebrales
 Pinze taglianti per dischi intervertebrali

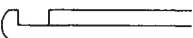
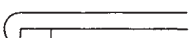
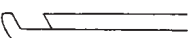
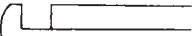
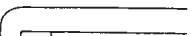
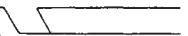
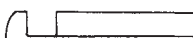
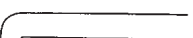

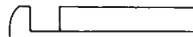
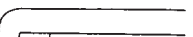
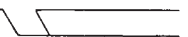
	90°	90°	40°
18 cm, 7" 20 cm, 8"	 41510-01 1 mm 41513-01 1 mm	 41511-01 1 mm 41514-01 1 mm	 41512-01 1 mm 41515-01 1 mm
18 cm, 7" 20 cm, 8"	 41510-02 2 mm 41513-02 2 mm	 41511-02 2 mm 41514-02 2 mm	 41512-02 2 mm 41515-02 2 mm
18 cm, 7" 20 cm, 8"	 41510-03 3 mm 41513-03 3 mm	 41511-03 3 mm 41514-03 3 mm	 41512-03 3 mm 41515-03 3 mm
18 cm, 7" 20 cm, 8"	 41510-04 4 mm 41513-04 4 mm	 41511-04 4 mm 41514-04 4 mm	 41512-04 4 mm 41515-04 4 mm
18 cm, 7" 20 cm, 8"	 41510-05 5 mm 41513-05 5 mm	 41511-05 5 mm 41514-05 5 mm	 41512-05 5 mm 41515-05 5 mm

auch lieferbar mit Dünnpfuß
 also available with thin foot plate
 tambien disponible con lámina de punzonar estrecha
 anche disponibile con morso sottile

Bandscheibenstanzen
Intervertebral Disc Rongeurs
Pinzas sacabocado para discos intervertebrales
Pinze taglianti per dischi intervertebrali

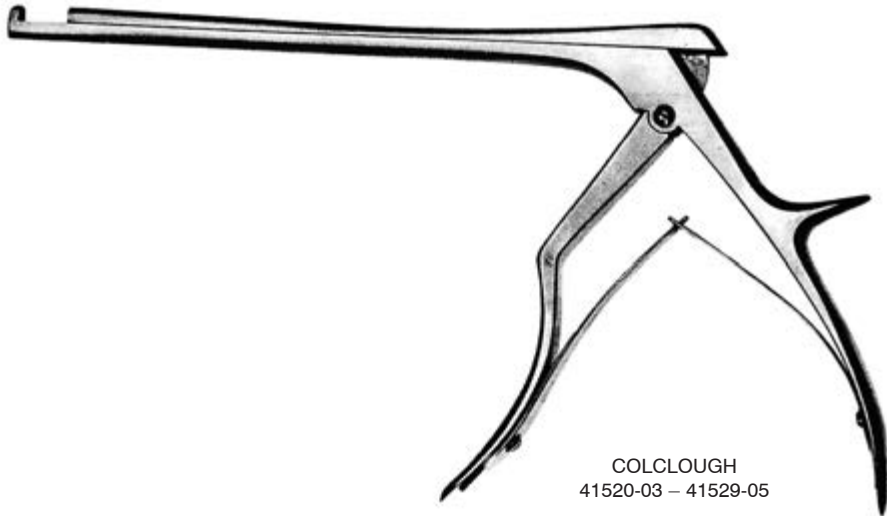

COLCLOUGH
41520-03 – 41529-05

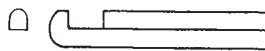

3 mm
41520-03 15 cm, 6"
41522-03 20 cm, 8"



5 mm
41520-05 15 cm, 6"
41522-05 20 cm, 8"

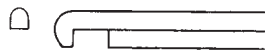

3 mm
41524-03 15 cm, 6"
41526-03 20 cm, 8"



5 mm
41524-05 15 cm, 6"
41526-05 20 cm, 8"



3 mm
41527-03 15 cm, 6"
41529-03 20 cm, 8"



5 mm
41527-05 15 cm, 6"
41529-05 20 cm, 8"

Zerlegbare Stanzen
 Detachable punches
 Pinzas cortantes desmontables
 Pinze taglienti e smontabili



FERRIS-SMITH-KERRISON
 18 cm, 7"

90°



41540-02 2 mm

41540-03 3 mm

41540-04 4 mm

41540-05 5 mm

130°



41542-02 2 mm

41542-03 3 mm

41542-04 4 mm

41542-05 5 mm

YASARGIL – Aneurysmen – Gefäß – Clips
YASARGIL – Aneurysm – Vessel – Clips
YASARGIL – Clips para aneurisma
YASARGIL – Clips per aneurisma

aus hochwertigem Implantat-Stahl antimagnetisch
in high quality Implant steel antimagnetic
de acero inoxidable para implantes de alta calidad, antimagnético
Prodotto in acciaio di alta qualità, antimagnetico

Features of the Clip

SERIAL-NUMBER

Each clip is coded with an individual serial number – marked by laser technology –
The serial number guarantees a detailed follow-up of

- the whole production process
- the closure force
- from raw material to the final product

These informations are registered in our company for the period of 10 years.

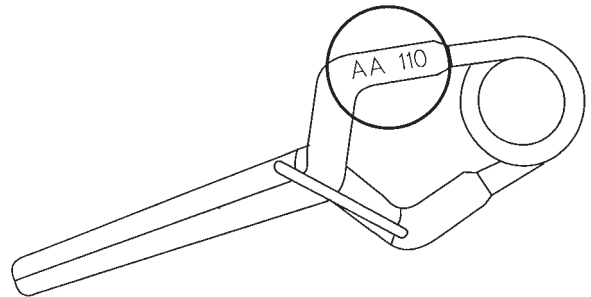

PACKING – LABELING

Each clip is individually packaged in a transparent box made of resistant plastic.
Special wishes of customers regarding the packaging will be considered by us. This will be marked on an internal instruction.

The transparent box is marked with a label in order to assure a quick and sure identification of the clip.

On the label you can find the following data:

- catalogue number
- Product description
- Illustration
- Closing force in g
- Tolerance range of closing force
- Blade length
- Maximum opening
- Blade geometry
- Serial number
- Jaw profile
- Material description
- Lot number
- the notes "NOT STERILE"
- WARNING

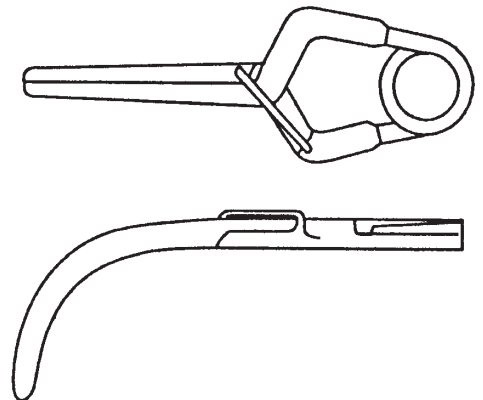

YASARGIL – Aneurysmen – Gefäß – Clips

YASARGIL – Aneurysm – Vessel – Clips

YASARGIL – Clips para aneurisma

YASARGIL – Clips per aneurisma

aus hochwertigem Implantat-Stahl antimagnetisch
in high quality Implant steel antimagnetic
de acero inoxidable para implantes de alta calidad, antimagnético
Prodotto in acciaio di alta qualità, antimagnetico

Features of the Clip

JAW-PROFILE

The rounded, pyramid-like structure is stamped into the jaw through a special step in production and prevents sharp edged which could perforate an aneurysm

No edges or burrs through additional rounding of structures that border the clip outer side because of this, real atraumatic application of the clip

Increased surface area due to the pyramid-like design of the jaws inner surface the cross-like structure of the inner jaws pyramid surface doubles the tissue-holding area.

The applied pressure distributes itself evenly over the length of the jaw.

The convex closure of the clip assures an atraumatic and secure closure of the aneurysm.

Sliding of the clip is prevented.

SPRING-DESIGN

The spring size, wich is different in the Standard and Mini clips, ist the same within the same type of the Clip.

Through this, the highest degree of a secure fit is ensured by the clip applier (clip/clip applier fit)

LINK-DESIGN

Laser welded

The link ensures the precise guidance of the jaws and a "soft" opening of the clip during the whole spreading process.

The contact surface of the jaws are guided symmetrically in an exact way "over the whole lenth" this fact guarantees an aditional stability of the clip.

No over-stress of the material because the design of the link limits the maximum opening width.

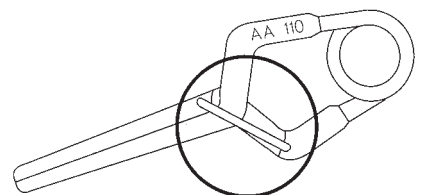
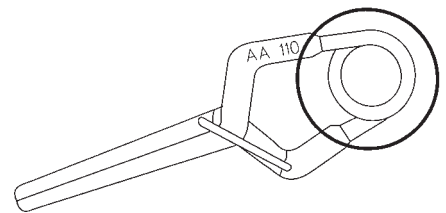
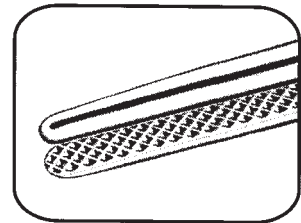
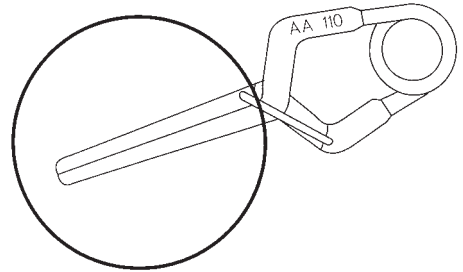

YASARGIL – Aneurysmen – Gefäß – Clips
 YASARGIL – Aneurysm – Vessel – Clips
 YASARGIL – Clips para aneurisma
 YASARGIL – Clips per aneurisma

aus hochwertigem Implantat-Stahl antimagnetisch
 in high quality Implant steel antimagnetic
 de acero inoxidable para implantes de alta calidad, antimagnético
 Prodotto in acciaio di alta qualità, antimagnetico

Features of the Clip

CLOSING-FORCE

The closing force is measured at one third of the jaw length and an opening of 0,5 mm.

The final quality control of the clip is effected by a microprocessor-controlled measuring equipment.

The closing force is indicated exactly within a certain tolerance.

By the help of a special software program we assure that before the clip passes the final quality control its closure force is fixed. As a consequence we exclude any kind of manipulation.

All relevant technical data are stored during the control procedure and printed on the label.

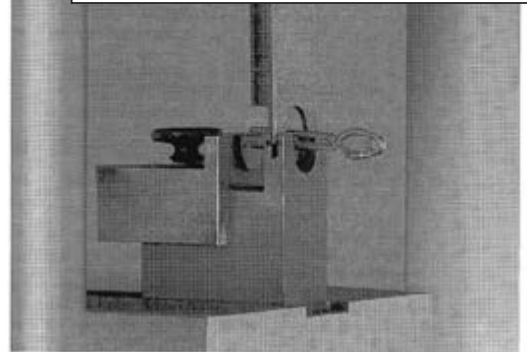
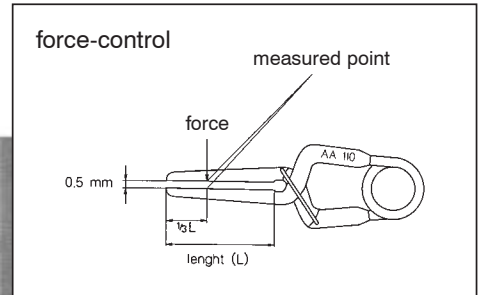

Material and Quality Assurance

According to DIN 17445, implant steel is used in the production of our Aneurysm Clip

- High stability characteristics
- Excellent tissue compatibility
- Secure closure of blood vessels
- Antimagnetic
- Ideally suited as implantation material
- Security against over straining



YASARGIL – Aneurysmen – Gefäß – Clips
 YASARGIL – Aneurysm – Vessel – Clips
 YASARGIL – Clips para aneurisma
 YASARGIL – Clips per aneurisma

aus hochwertigem Implantat-Stahl antimagnetisch
 in high quality Implant steel antimagnetic
 de acero inoxidable para implantes de alta calidad, antimagnético
 Prodotto in acciaio di alta qualità, antimagnetico

YASARGIL-STANDARD für permanenten Verschluss
 YASARGIL-STANDARD for permanent closure
 YASARGIL-STANDARD para cierre permanente
 YASARGIL-STANDARD con chiusura permanente

Standard

Cat. Nr.	41600-62	41600-70	41600-78	41600-92	41601-10	41601-11
	41600-62 T	41600-70 T	41600-78 T	41600-92 T	41601-10 T	41601-11 T
max. opening	6,2 mm	7,0 mm	7,8 mm	9,2 mm	10,6 mm	11,4 mm
Force	150 gms	180 gms	180 gms	200 gms	200 gms	200 gms
	41601-13	41602-60	41602-68	41602-75	41602-87	41603-55
	41601-13 T	41602-60 T	41602-68 T	41602-75 T	41602-87 T	41603-55 T
	13,3 mm	6,0 mm	6,8 mm	7,5 mm	8,7 mm	5,5 mm
	200 gms	150 gms	180 gms	180 gms	200 gms	150 gms
	41603-61	41603-65	41603-74	41604-54	41604-58	41604-62
	41603-61 T	41603-65 T	41603-74 T	41604-54 T	41604-58 T	41604-62 T
	6,1 mm	6,5 mm	7,4 mm	5,4 mm	5,8 mm	6,2 mm
	180 gms	180 gms	200 gms	180 gms	180 gms	200 gms
	41604-79	41604-87	41604-87	41604-87	41604-87	41604-87
	41604-79 T	41604-87 T	41604-87 T	41604-87 T	41604-87 T	41604-87 T
	7,9 mm	8,7 mm	8,7 mm	8,7 mm	8,7 mm	8,7 mm
	200 gms	200 gms	200 gms	200 gms	200 gms	200 gms

YASARGIL – Aneurysmen – Gefäß – Clips

YASARGIL – Aneurysm – Vessel – Clips

YASARGIL – Clips para aneurisma

YASARGIL – Clips per aneurisma

aus hochwertigem Implantat-Stahl antimagnetisch
in high quality Implant steel antimagnetic
de acero inoxidable para implantes de alta calidad, antimagnético
Prodotto in acciaio di alta qualità, antimagnetico

YASARGIL-STANDARD für permanenten Verschluss

YASARGIL-STANDARD for permanent closure

YASARGIL-STANDARD para cierre permanente

YASARGIL-STANDARD con chiusura permanente

Standard

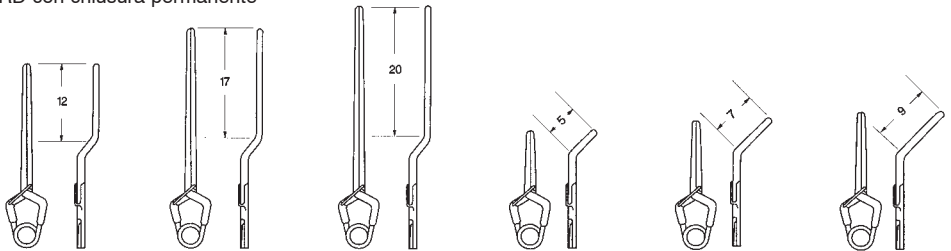

Cat. Nr.	41605-10	41605-12	41605-13	41606-62	41606-65	41606-78
	41605-10 T	41605-12 T	41605-13 T	41606-62-T	41606-65 T	41606-78 T
max. opening	10,2 mm	11,9 mm	13,0 mm	6,2 mm	6,5 mm	7,8 mm
Force	200 gms	180 gms	180 gms	200 gms	200 gms	200 gms

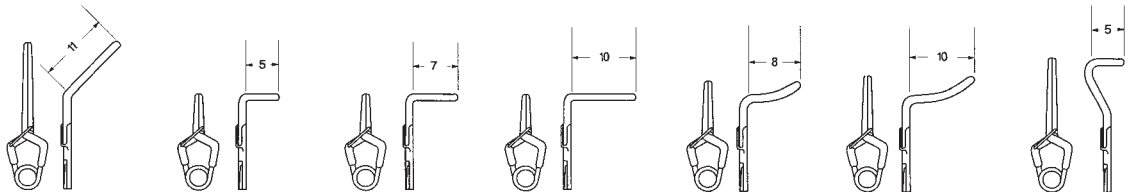

	41606-84	41607-56	41607-57	41607-58	41607-59	41607-60	41607-72
	41606-84 T	41607-56 T	41607-57 T	41607-58 T	41607-59 T	41607-60 T	41607-72 T
	8,4 mm	5,6 mm	5,6 mm	5,6 mm	5,4 mm	5,6 mm	7,2 mm
	200 gms	200 gms	200 gms	200 gms	200 gms	200 gms	200 gms

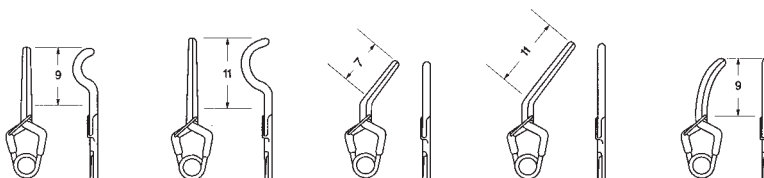

	41607-73	41607-82	41608-57	41608-80	41609-70
	41607-73 T	41607-82 T	41608-57 T	41608-80 T	41609-70 T
	7,2 mm	8,2 mm	5,7 mm	8,0 mm	7,0 mm
	200 gms	200 gms	200 gms	200 gms	200 gms

YASARGIL – Aneurysmen – Gefäß – Clips
 YASARGIL – Aneurysm – Vessel – Clips
 YASARGIL – Clips para aneurisma
 YASARGIL – Clips per aneurisma

aus hochwertigem Implantat-Stahl antimagnetisch
 in high quality Implant steel antimagnetic
 de acero inoxidable para implantes de alta calidad, antimagnético
 Prodotto in acciaio di alta qualità, antimagnetico

YASARGIL-STANDARD für temporären Verschluss
 YASARGIL-STANDARD for temporary closure
 YASARGIL-STANDARD para cierre temporal
 YASARGIL-STANDARD con chiusura temporanea

Standard

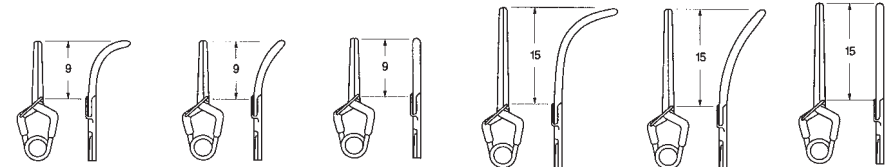

Cat. Nr.	41610-61 41610-61 T	41610-68 41610-68 T	41610-70 41610-70 T	41611-74 41611-74 T	41611-87 41611-87 T	41611-92 41611-92 T
max. opening	6,1 mm	6,8 mm	7,0 mm	7,4 mm	8,7 mm	9,2 mm
Force	70 gms	70 gms	70 gms	70 gms	70 gms	70 gms

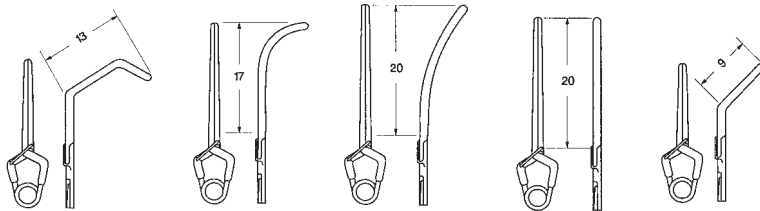

41612-07 41612-07 T	41612-09 41612-09 T	41612-11 41612-11 T	41612-12 41612-12 T	41612-62 41612-62 T
7,5 mm	9,9 mm	11,0 mm	11,4 mm	6,2 mm
90 gms	90 gms	90 gms	90 gms	70 gms

YASARGIL – Aneurysmen – Gefäß – Clips

YASARGIL – Aneurysm – Vessel – Clips

YASARGIL – Clips para aneurisma

YASARGIL – Clips per aneurisma

aus hochwertigem Implantat-Stahl antimagnetisch
in high quality Implant steel antimagnetic
de acero inoxidable para implantes de alta calidad, antimagnético
Prodotto in acciaio di alta qualità, antimagnetico

YASARGIL-STANDARD für permanenten Verschluss

YASARGIL-STANDARD for permanent closure

YASARGIL-STANDARD para cierre permanente

YASARGIL-STANDARD con chiusura permanente

Standard

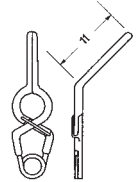
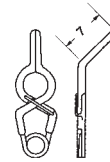
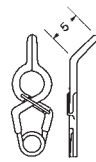
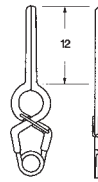
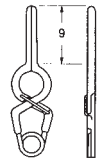
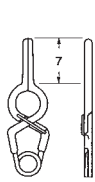

Cat. Nr.

41613-74

41613-74 T

max. opening
Force

7,4 mm
150 gms

41613-84

41613-84 T

8,4 mm
150 gms

41613-96

41613-96 T

9,6 mm
180 gms

41614-58

41614-58 T

5,8 mm
150 gms

41614-65

41614-65 T

6,5 mm
150 gms

41614-72

41614-72 T

7,2 mm
180 gms

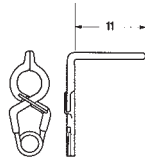
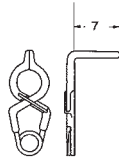
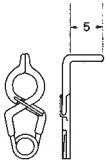

41615-49

41615-49 T

4,9 mm
150 gms

41615-50

41615-50 T

4,9 mm
150 gms

41615-51

41615-51 T

4,9 mm
180 gms

YASARGIL – Aneurysmen – Gefäß – Clips
 YASARGIL – Aneurysm – Vessel – Clips
 YASARGIL – Clips para aneurisma
 YASARGIL – Clips per aneurisma

aus hochwertigem Implantat-Stahl antimagnetisch
 in high quality Implant steel antimagnetic
 de acero inoxidable para implantes de alta calidad, antimagnético
 Prodotto in acciaio di alta qualità, antimagnetico

YASARGIL-STANDARD für permanenten Verschluss
 YASARGIL-STANDARD for permanent closure
 YASARGIL-STANDARD para cierre permanente
 YASARGIL-STANDARD con chiusura permanente

Standard

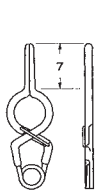

41616-79
41616-79 T

max. opening
 Force

7,9 mm
 150 gms

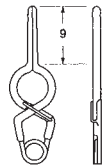

41616-91
41616-91 T

9,1 mm
 150 gms

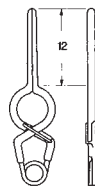

41617-10
41617-10 T

10,3 mm
 180 gms

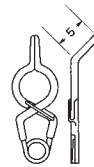

41617-65
41617-65 T

6,5 mm
 150 gms

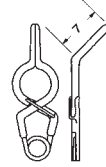

41617-72
41617-72 T

7,2 mm
 150 gms

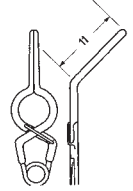

41617-78
41617-78 T

7,8 mm
 180 gms

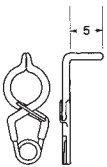

41618-55
41618-55 T

5,5 mm
 150 gms

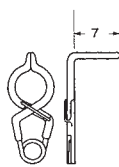

41618-56
41618-56 T

5,5 mm
 150 gms

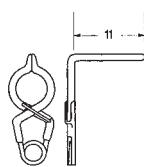

41618-57
41618-57 T

5,5 mm
 180 gms

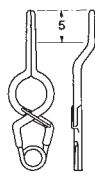

41618-79
41618-79 T

7,9 mm
 150 gms

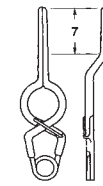

41618-88
41618-88 T

8,8 mm
 150 gms

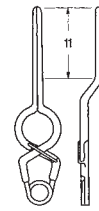

41619-00
41619-00 T

10,0 mm
 180 gms



YASARGIL – Aneurysmen – Gefäß – Clips
 YASARGIL – Aneurysm – Vessel – Clips
 YASARGIL – Clips para aneurisma
 YASARGIL – Clips per aneurisma

aus hochwertigem Implantat-Stahl antimagnetisch
 in high quality Implant steel antimagnetic
 de acero inoxidable para implantes de alta calidad, antimagnético
 Prodotto in acciaio di alta qualità, antimagnetico

YASARGIL-STANDARD für permanenten Verschluss
 YASARGIL-STANDARD for permanent closure
 YASARGIL-STANDARD para cierre permanente
 YASARGIL-STANDARD con chiusura permanente

Standard

Cat. Nr.	41620-58	41620-59	41620-60	41620-61	41620-62	41620-63
	41620-58 T	41620-59 T	41620-60 T	41620-61 T	41620-62 T	41620-63 T
max. opening	5,8 mm	5,8 mm	5,8 mm	5,8 mm	5,8 mm	5,8 mm
Force	150 gms	150 gms	150 gms	150 gms	150 gms	150 gms
	41620-70	41620-78	41620-88	41621-58	41621-62	41622-58
	41620-70 T	41620-78 T	41620-88 T	41621-58 T	41621-62 T	41622-58 T
	7,0 mm	7,8 mm	8,8 mm	5,8 mm	6,2 mm	5,8 mm
	150 gms	150 gms	150 gms	150 gms	150 gms	150 gms
	41623-56	41624-56	41625-56	41626-56		
	41623-56 T	41624-56 T	41625-56 T	41626-56 T		
	5,6 mm	5,6 mm	5,6 mm	5,6 mm		
	150 gms	150 gms	150 gms	150 gms		

YASARGIL – Aneurysmen – Gefäß – Clips
 YASARGIL – Aneurysm – Vessel – Clips
 YASARGIL – Clips para aneurisma
 YASARGIL – Clips per aneurisma

aus hochwertigem Implantat-Stahl antimagnetisch
 in high quality Implant steel antimagnetic
 de acero inoxidable para implantes de alta calidad, antimagnético
 Prodotto in acciaio di alta qualità, antimagnetico

YASARGIL-STANDARD für permanenten Verschluss
 YASARGIL-STANDARD for permanent closure
 YASARGIL-STANDARD para cierre permanente
 YASARGIL-STANDARD con chiusura permanente

Mini

Cat. Nr.	41627-33	41627-40	41628-33	41628-40	41628-46	41629-32
	41627-33 T	41627-40 T	41628-33 T	41628-40 T	41628-46 T	41629-32 T
max. opening	3,3 mm	4,0 mm	3,3 mm	4,0 mm	4,6 mm	3,2 mm
Force	110 gms	110 gms	110 gms	110 gms	110 gms	110 gms

41629-38	41630-36	41630-38	41631-36	41631-40	41631-44	41632-36
41629-38 T	41630-36 T	41630-38 T	41631-36 T	41631-40 T	41631-44 T	41632-36 T
3,8 mm	3,6 mm	3,8 mm	3,6 mm	4,0 mm	4,4 mm	3,6 mm
110 gms	110 gms	110 gms	110 gms	110 gms	110 gms	110 gms

41633-35	41633-40	41634-35	41634-60	41634-70	41635-57	41636-45
41633-35 T	41633-40 T	41634-35 T	41634-60 T	41634-70 T	41635-57 T	41636-45 T
3,5 mm	4,0 mm	3,5 mm	6,0 mm	7,0 mm	5,7 mm	4,5 mm
110 gms	110 gms	130 gms	130 gms	130 gms	130 gms	130 gms



YASARGIL – Aneurysmen – Gefäß – Clips

YASARGIL – Aneurysm – Vessel – Clips

YASARGIL – Clips para aneurisma

YASARGIL – Clips per aneurisma

aus hochwertigem Implantat-Stahl antimagnetisch
 in high quality Implant steel antimagnetic
 de acero inoxidable para implantes de alta calidad, antimagnético
 Prodotto in acciaio di alta qualità, antimagnetico

YASARGIL-STANDARD für temporären Verschuß

YASARGIL-STANDARD for temporary closure

YASARGIL-STANDARD para cierre temporal

YASARGIL-STANDARD con chiusura temporanea

Mini

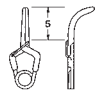
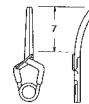

Cat. Nr.	41637-33 41637-33 T	41637-40 41637-40 T	41638-38 41638-38 T	41638-46 41638-46 T	41639-44 41639-44 T	41640-40 41640-40 T
max. opening	3,3 mm	4,0 mm	3,8 mm	4,6 mm	4,4 mm	4,0 mm
Force	50 gms	50 gms	50 gms	70 gms	70 gms	70 gms

Anlegezange mit Rundgriff – FLEXIBEL – mit und ohne drehbarem Maulteil
 Applying forceps with round shaft – FLEXIBLE – with and without Rotation
 Pinzas de aplicación con mango redondo – FLEXIBLE – con y sin rotación
 Posa clips con manico rotonda guaina FLESSIBILE cover sistema rotante ed non rotante

Länge		
Length		
Largo		
Lunghezza	MINI	STANDARD
70 mm	41641-07	41643-07
90 mm	41641-09	41643-09
110 mm	41641-11	41643-11

nicht drehbar
 non rotating
 sin rotación
 non rotante

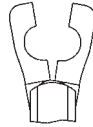

Länge		
Length		
Largo		
Lunghezza	MINI	STANDARD
70 mm	41642-07	41644-07
90 mm	41642-09	41644-09
110 mm	41642-11	41644-11

drehbar
 rotating
 rotante
 rotante

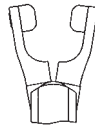

drehbar
 rotating
 rotante
 rotante

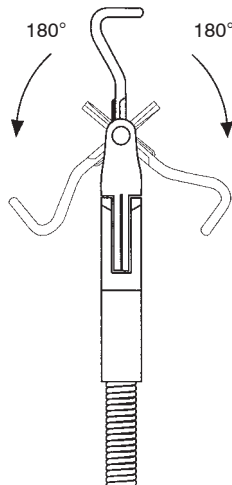

Beispiel für Drehmechanismus
 Example for Rotation
 Ejemplo de la rotación
 Esempio della rotazione

Clips drehbar im Maul
 Clips rotabile in jaw
 Clips rotabile en la boca
 Clips rotabile nel morso

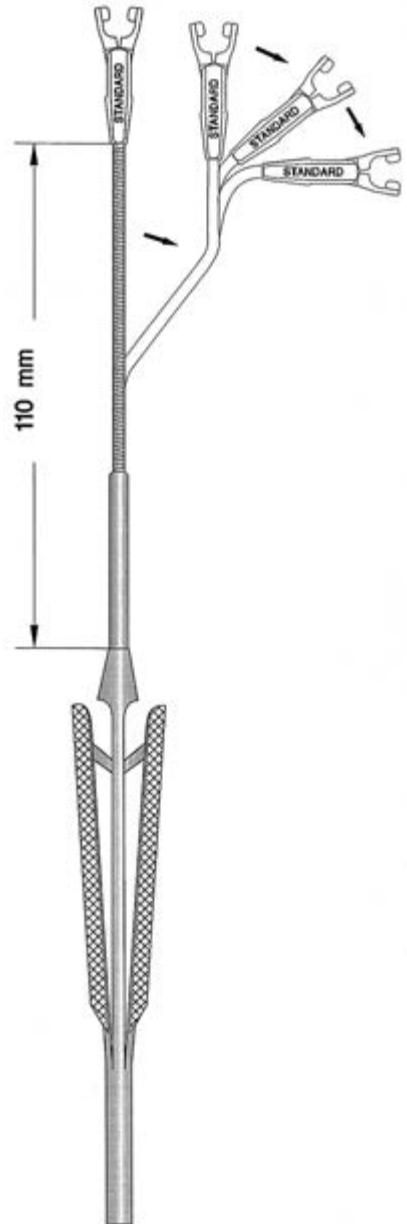

41641-07 - 41644-11

Anlegezange mit Rundgriff – starr – mit und ohne drehbarem Maulteil
 Applying forceps with round shaft – rigid – with and without Rotation
 Pinzas de aplicación con mango redondo – rigido – con y sin rotación
 Posa clips con manico rotonda guaina rigida cover sistema rotante ed non rotante

Länge			nicht drehbar
Length			non rotating
Largo			sin rotación
Lunghezza	MINI	STANDARD	non rotante
70 mm	41645-07	41647-07	
90 mm	41645-09	41647-09	
110 mm	41645-11	41647-11	

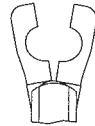

Länge			drehbar
Length			rotating
Largo			rotante
Lunghezza	MINI	STANDARD	rotante
70 mm	41646-07	41648-07	
90 mm	41646-09	41648-09	
110 mm	41646-11	41648-11	

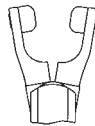

drehbar
rotating
rotante
rotante

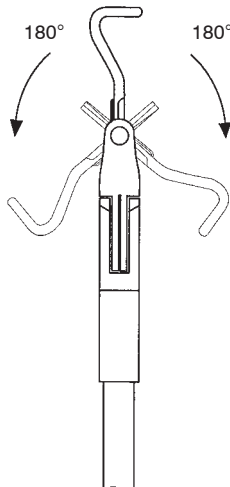

Beispiel für Drehmechanismus
 Example for Rotation
 Ejemplo de la rotación
 Esempio della rotazione

Clips drehbar im Maul
 Clips rotabile in jaw
 Clips rotabile en la boca
 Clips rotabile nel morso

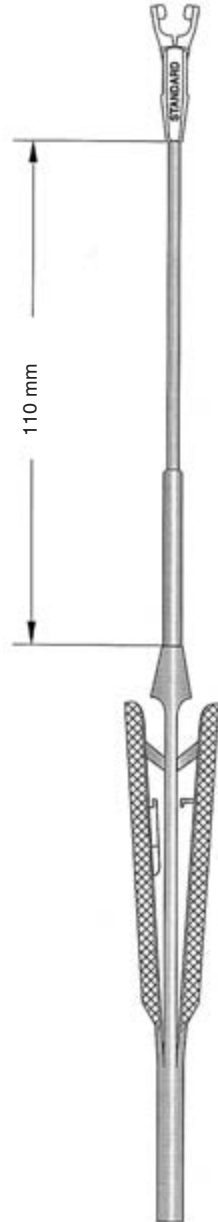

41645-07 - 41648-11

Anlegezange mit Rundgriff – starr – mit und ohne drehbarem Maulteil
 Applying forceps with round shaft – rigid – with and without Rotation
 Pinzas de aplicación con mango redondo – rigido – con y sin rotación
 Posa clips con manico rotonda guaina rigida cover sistema rotante ed non rotante

Länge		
Length		
Largo		
Lunghezza	MINI	STANDARD
70 mm	41649-07	41651-07
90 mm	41649-09	41651-09
110 mm	41649-11	41651-11

nicht drehbar
 non rotating
 sin rotación
 non rotante

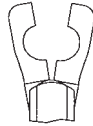

Länge		
Length		
Largo		
Lunghezza	MINI	STANDARD
70 mm	41650-07	41652-07
90 mm	41650-09	41652-09
110 mm	41650-11	41652-11

drehbar
 rotating
 rotante
 rotante

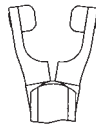

drehbar
 rotating
 rotante
 rotante

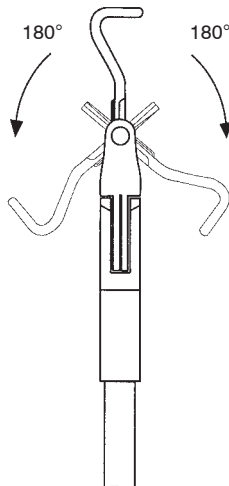

Beispiel für Drehmechanismus
 Example for Rotation
 Ejemplo de la rotación
 Esempio della rotazione

Clips drehbar im Maul
 Clips rotabile in jaw
 Clips rotabile en la boca
 Clips rotabile nel morso

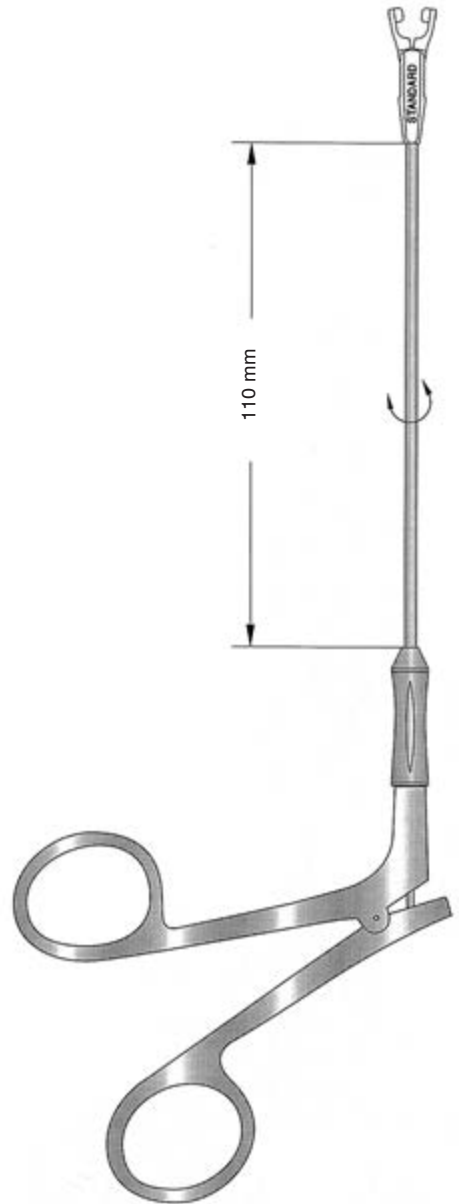

41649-07 - 41652-11

Anlegezange – mit und ohne drehbarem Maulteil
 Applying Forceps – with and without Rotation
 Pinzas de aplicación, con y sin rotación
 Pinza posa clips, con ed senza rotazione

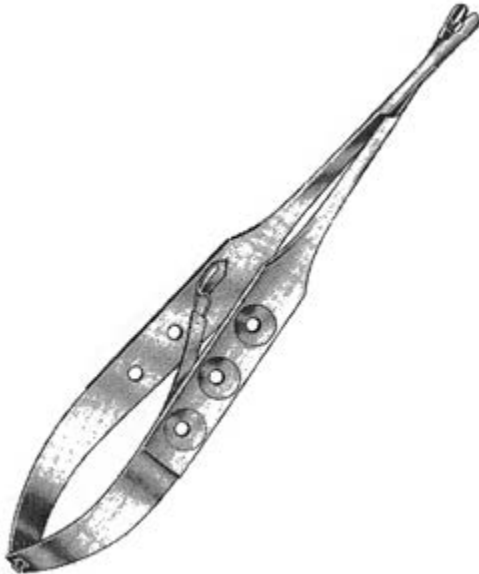

MINI	41653-18	
STANDARD	41654-18	
MINI	41655-18	drehbar / rotating rotante / rotante
STANDARD	41656-18	drehbar / rotating rotante / rotante

Anlegezange gerade, mit Sperre, Länge 18 cm, 7"
 Applying Forceps straight, with Ratchet, Length 18 cm, 7"
 Pinza de aplicación, con cremallera, 18 cm, 7"
 Posa clips, retta con bloccaggio lunghezza 18 cm, 7"





Länge			
Length			
Largo			
Lunghezza	17 cm, 6 ³ / ₄ "	21 cm, 8 ¹ / ₄ "	23 cm, 9"
MINI	41657-17	41657-21	41657-23
STANDARD	41658-17	41658-21	41658-23
MINI	41659-17	41659-21	41659-23
	drehbar / rotating / rotante / rotante		
STANDARD	41660-17	41660-21	41660-23
	drehbar / rotating / rotante / rotante		

Clips drehbar im Maul
 Clips rotabile in jaw
 Clips rotabile en la boca
 Clips rotabile nel morso

Anlegezange bayonett, mit Sperre
 Applying Forceps bajonett, with Ratchet
 Pinza de aplicación bayoneta, con cremallera
 Posa clips a baionetta con bloccaggio

Gefäßclips nach BIEMER
 BIEMER Vessel Clips
 Clips para vasos de BIEMER
 Clips per vasi secondo BIEMER

	Maulöffnung Opening	Maullänge Length of jaws	Schließkraft Closing Force
 41661-40	Apertura de la boca Apertura del morso 4,0 mm	Largo de la boca Lunghezza del morso 6,0 mm	Fuerza del cierre Forza di chiusura 30 - 40 g (0,29 - 0,39 N)
 41661-50	5,0 mm	9,0 mm	30 - 40 g (0,29 - 0,39 N)
 41662-50	5,0 mm	9,0 mm	20 - 25 g (0,20 - 0,25 N)

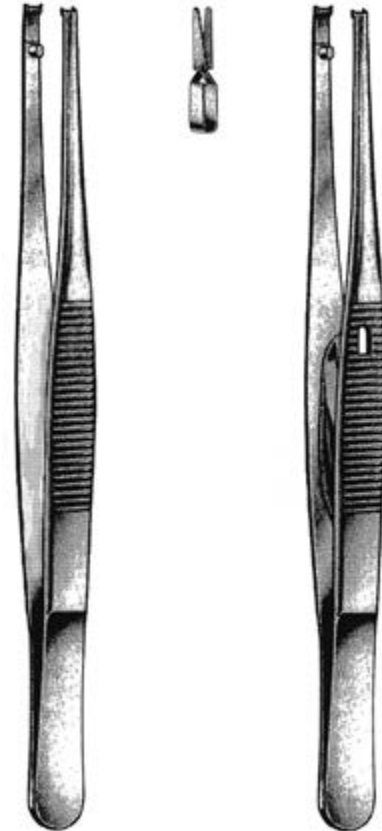

für temporären Gebrauch

gekennzeichnet durch gelb eingefärbte Federenden für Gefäße mit einem Durchmesser 0,5 - 2,0 mm

Maulinnenflächen schräg gerieft für schonendes, sicheres Festhalten der Gefäße

Der fest eingestellte Schließdruck gewährt risikofreie Anwendung

for temporary occlusion

(identified by yellow coloured spring ends) for vessel diam. 0,5 - 2,0 mm

Blade gripping surface with oblique serrations for save but careful gripping of vessels

No risk due to rigidly fixed pressure measure

para uso temporal

clips marcados con baño dorado en los resortes, para vasos con un diámetro de 0,5 - 2,0 mm

El interior de las quijadas viene con estrias finas para un agarre seguro y cuidadoso de los vasos

Debido a la calibración exacta de la fuerza de cierre se ofrece una aplicación sin riesgo

per chiusura temporanea

per vasi con Diametro 0,5 - 2,0 mm

La chiusura regolata garantisce nessun rischio

BIEMER
41663-01

Anlegepinzette ohne Schloß,
für Mikro-Gefäßclips
41661-40 - 41662-50
und
Approximatoren
41667-30 - 41670-50
und
41672-01 - 41672-04

Applying forceps without lock.
for vessel clips
41661-40 - 41662-50
and
Aproximators
41667-30 - 41670-50
and
41672-01 - 41672-04

BIEMER
41663-02

Anlegepinzette mit Schloß,
für Mikro-Gefäßclips
41661-40 - 41662-50
und
Approximatoren
41667-30 - 41670-50
und
41672-01 - 41672-04

Applying forceps with lock.
for vessel clips
41661-40 - 41662-50
and
Aproximators
41667-30 - 41670-50
and
41672-01 - 41672-04

Gefäßclips nach MEHDORN
MEHDORN Vessel Clips
Clips para vasos de MEHDORN
Clips secondo MEHDORN

für temporären Gebrauch

gekennzeichnet durch gelb eingefärbte Federenden für Gefäße mit einem Durchmesser 0,5 - 1,5 mm

Maulinnenflächen schräg gerieft für schonendes, sicheres Festhalten der Gefäße

Der fest eingestellte Schließdruck gewährt risikofreie Anwendung

for temporary occlusion

(identified by yellow coloured spring ends) for vessel diam. 0,5 - 1,5 mm

Blade gripping surface with oblique serrations for save but careful gripping of vessels

No risk due to rigidly fixed pressure measure

Beispiele für die variable Position des Clips
Ejemplo para la variedad de la aplicación del clip
Esempio: posizioni variabili delle clips

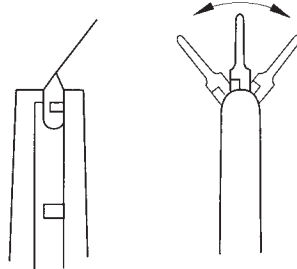

para uso temporal

clips marcados con baño dorado en los resortes, para vasos con un diámetro de 0,5 - 1,5 mm

El interior de las quijadas viene con estrias finas para un agarre seguro y cuidadoso de los vasos





Debido a la calibración exacta de la fuerza de cierre se ofrece una aplicación sin riesgo

per chiusura temporanea

per vasi con Diametro 0,5 - 1,5 mm

La chiusura regolata garantisce nessun rischio

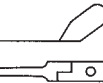

	Maullänge Length of jaws Largo de la boca Lunghezza del morso	Schließkraft Closing Force Fuerza del cierre Forza di chiusura	MEHDORN 41666-00
	41664-10 4 x 1,0 mm	10 - 15 g (0,10 - 0,15 N)	Anlegepinzette für Mikro-Gefäßclips 41664-10 - 41665-14
	41664-14 4 x 1,4 mm	15 - 20 g (0,15 - 0,20 N)	Applying Forceps for vessel clips 41664-10 - 41665-14
	41665-10 6 x 1,0 mm	10 - 15 g (0,10 - 0,15 N)	Pinza de aplicación para micro-clips 41664-10 - 41665-14
	41665-14 6 x 1,4 mm	15 - 20 g (0,15 - 0,20 N)	Pinza posa clips per microvasi 41664-10 - 41665-14

Approximatoren nach Biemer-Müller
 Approximators Biemer-Müller
 Aproximadores de Biemer-Müller
 Approssimatore secondo Biemer-Müller

für temporären Gebrauch

gekennzeichnet durch gelb eingefärbte Federenden für Gefäße mit einem Durchmesser 0,5 - 2,0 mm
 Maulinnenflächen schräg gerieft für schonendes, sicheres Festhalten der Gefäße
 Der fest eingestellte Schließdruck gewährt risikofreie Anwendung

for temporary occlusion

(identified by yellow coloured spring ends) for vessel diam. 0,5 - 2,0 mm
 Blade gripping surface with oblique serrations for save but careful gripping of vessels
 No risk due to rigidly fixed pressure measure

para uso temporal

clips marcados con baño dorado en los resortes, para vasos con un diámetro de 0,5 - 2,0 mm
 El interior de las quijadas viene con estrias finas para un agarre seguro y cuidadoso de los vasos
 Debido a la calibración exacta de la fuerza de cierre se ofrece una aplicación sin riesgo

per chiusura temporanea

per vasi con Diametro 0,5 - 2,0 mm
 La chiusura regolata garantisce nessun rischio

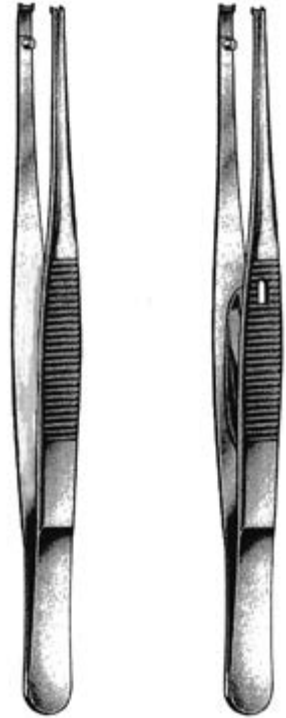

	Maulöffnung Opening	Maullänge Length of jaws	Schließkraft Closing Force		
	Apertura de la boca	Largo de la boca	Fuerza del cierre		
	Apertura del morso	Lunghezza del morso	Forza di chiusura		
	3,0 mm	4,5 mm	30 - 40 g (0,29 - 0,39 N)	BIEMER 41663-01	BIEMER 41663-02
	5,0 mm	9,0 mm	30 - 40 g (0,29 - 0,39 N)	Anlegepinzette ohne Schloß, für Mikro-Gefäßclips 41661-40 - 41662-50 und Approximatoren 41667-30 - 41670-50 und 41672-01 - 41672-04	Anlegepinzette mit Schloß, für Mikro-Gefäßclips 41661-40 - 41662-50 und Approximatoren 41667-30 - 41670-50 und 41672-01 - 41672-04
	5,0 mm	9,0 mm	30 - 40 g (0,20 - 0,25 N)	Applying forceps without lock. for vessel clips 41661-40 - 41662-50 and Aproximadors 41667-30 - 41670-50 and 41672-01 - 41672-04	Applying forceps with lock. for vessel clips 41661-40 - 41662-50 and Aproximadors 41667-30 - 41670-50 and 41672-01 - 41672-04
	5,0 mm	9,0 mm	30 - 40 g (0,20 - 0,25 N)		
	5,0 mm	9,0 mm	30 - 40 g (0,20 - 0,25 N)		

Approximatoren nach Müller
Müller Approximators
Aproximadores de Müller
Aprossimatore secondo Müller

für temporären Gebrauch

gekennzeichnet durch gelb eingefärbte Federenden für Gefäße mit einem Durchmesser 0,5 - 2,0 mm
Maulinnenflächen schräg gerieft für schonendes, sicheres Festhalten der Gefäße
Der fest eingestellte Schließdruck gewährt risikofreie Anwendung

for temporary occlusion

(identified by yellow coloured spring ends) for vessel diam. 0,5 - 2,0 mm
Blade gripping surface with oblique serrations for save but careful gripping of vessels
No risk due to rigidly fixed pressure measure

para uso temporal

clips marcados con baño dorado en los resortes, para vasos con un diámetro de 0,5 - 2,0 mm
El interior de las quijadas viene con estrías finas para un agarre seguro y cuidadoso de los vasos
Debido a la calibración exacta de la fuerza de cierre se ofrece una aplicación sin riesgo

per chiusura temporanea

per vasi con Diametro 0,5 - 2,0 mm
La chiusura regolata garantisce nessun rischio

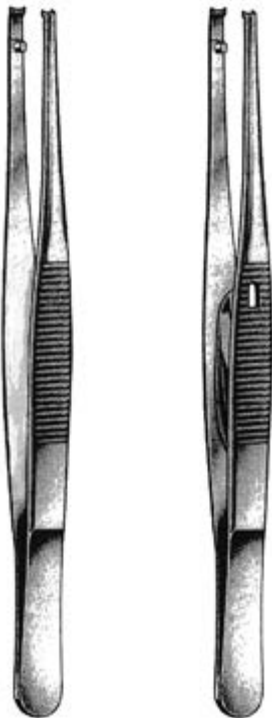

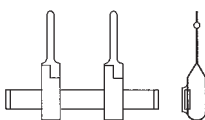
	Ø Diameter	Schließkraft Closing Force Fuerza del cierre Forza di chiusura
41672-01	1,0 mm	25 - 30 g (0,25 - 0,29 N)
41672-02	2,0 mm	25 - 30 g (0,25 - 0,29 N)
41672-03	3,0 mm	25 - 30 g (0,25 - 0,29 N)
41672-04	4,0 mm	25 - 30 g (0,25 - 0,29 N)

BIEMER
41663-01

Anlegepinzette ohne
Schloß,
für Mikro-Gefäßclips
41661-40 - 41662-50
und
Approximatoren
41667-30 - 41670-50
und
41672-01 - 41672-04

Applying forceps without
lock.
for vessel clips
41661-40 - 41662-50
and
Aproximadores
41667-30 - 41670-50
and
41672-01 - 41672-04

BIEMER
41663-02

Anlegepinzette mit
Schloß,
für Mikro-Gefäßclips
41661-40 - 41662-50
und
Approximatoren
41667-30 - 41670-50
und
41672-01 - 41672-04

Applying forceps with
lock.
for vessel clips
41661-40 - 41662-50
and
Aproximadores
41667-30 - 41670-50
and
41672-01 - 41672-04

Gefäßclips nach Müller
 Müller Vessel Clips
 Clips para vasos de Müller
 Clip secondo Müller

für temporären Gebrauch

Maulinnenflächen pyramidenförmig für schonendes, sicheres Festhalten der Gefäße

Der fest eingestellte Schließdruck gewährt risikofreie Anwendung

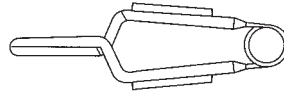

41674-50

Schließkraft
 Closing Force
 Fuerza del cierre
 Forza di chiusura

50 g

for temporary occlusion

Blade gripping surface with pyramid-like impressions for save but careful gripping of vessels

No risk due to rigidly fixed pressure measure

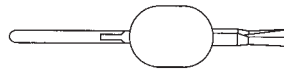

41674-80

80 g

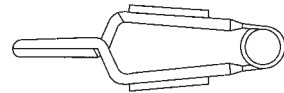

41675-50

50 g

para uso temporal

El interior de las quijadas viene en forma de pirámide para un agarre seguro y cuidadoso de los vasos.

Debido a la calibración exacta de la fuerza de cierre se ofrece una aplicación sin riesgo.

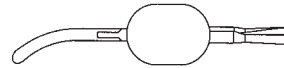

41675-80

80 g

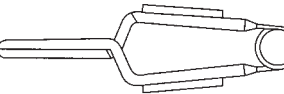

41676-50

50 g

per uso temporaneo

Morso interno con forma piramidale per garantire una chiusura sicura del vaso

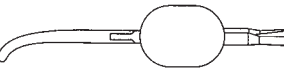

41676-80

80 g

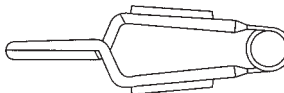

41677-50

50 g

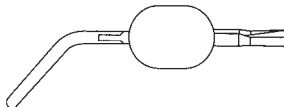

41677-80

80 g

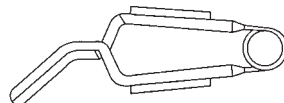

41678-50

50 g

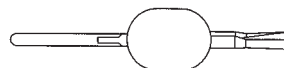

41678-80

80 g

Approximator nach Biemer
 Biemer Approximator
 Aproximadores de Biemer
 Approssimatore secondo Biemer

für Mikro-Gefäßanastomosen im oberflächlichen Bereich

Maulinnenflächen schräg gerieft für schonendes, sicheres Festhalten der Gefäße

Der fest eingestellte Schließdruck gewährt risikofreie Anwendung

Der Abstand zwischen den Clips ist durch einfaches Verschieben einzustellen und wird durch Verkanten fixiert

for micro vessel anastomosis in the superficial range

Blade gripping surface with oblique serrations for save but careful gripping of vessels

No risk due to rigidly fixed pressure measure

Adjustable distance between the clips and automatic fixation by tilting

para micro-anastomosis en la superficie

El interior de la quijada viene con estrias finas para un agarre seguro y cuidadoso de los vasos.

Debido a la calibración exacta de la fuerza de cierre se ofrece una aplicación sin riesgo.

El espacio entre los clips se logra fácilmente por el desplazamiento.

per micro vasi anastomosi sulla parte della superficie

Parte interna del morso è leggermente striata obliqua per ottenere la presa sulla superficie del vaso.

La chiusura regolata garantisce nessun rischio.

Lo scorrimento delle due clips viene regolato con semplice movimento che consente una chiusura ottimale.



BIEMER
 41680-00

Anlegepinzette für Gefäß-
 Approximator nach BIEMER

Applying forceps for BIEMER
 vessel approximator

Pinza de aplicación para
 aproximadores de BIEMER

Pinza posa clips per vasi
 approssimatori secondo
 BIEMER

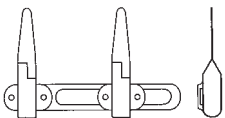

41679-25

Schließkraft
 Closing Force
 Fuerza de cierre
 Forza di chiusura

25 - 30 g
 (0,25 - 0,29 N)

LEYLA Retraktor System
 LEYLA Retractor System
 Separador de sistema LEYLA
 LEYLA Sistema di fissaggio



YASARGIL

- 41801-01 Hirnspatelhalter, flexibel, für 1 flachen Spatel, komplett, bestehend aus:
 brain retractor, flexible, for 1 flat spatula, complete, consisting of:
 separador autoretentivo, flexible, para espátula con 1 brazo flexible, completo, compuesto de:
 divaricatore autostatico, flessibile, per spatole piatte, con 1 braccio flessibile, completo, composto da:
- 41810-10 flexibler Spannarm
 flexible arm
 brazo flexible
 braccio flessibile
- 41826-26 Fixiervorrichtung für 1 flexiblen Spannarm
 fixation base for 1 flexible arm
 fijador para 1 brazo flexible
 fissatore per 1 braccio al braccio rigido
- 41830-30 Spatelhalter für flache Spatel
 support for flat brain spatula
 soporte para espátulas cerebrales planas
 sostegno per spatole piatte



YASARGIL

- 41802-02 Hirnspatelhalter, flexibel für 2 flache Spatel, komplett, bestehend aus:
 brain retractor, flexible, for 2 flat spatulas, complete, consisting of:
 separador autoretentivo, flexible, para 2 espátulas planas con 2 brazos flexibles, completo, compuesto de:
 divaricatore autostatico, flessibile, per spatole piatte, con 2 bracci flessibili, completo, composto da:
- 41810-10 flexibler Spannarm (2x)
 flexible arm (2x)
 brazo flexible (2x)
 braccio flessibile (2x)
- 41822-22 Fixiervorrichtung für 2 flexible Spannarme
 fixation base for 2 flexible arms
 fijador para 2 brazos
 fissatore per 2 bracci al cranio
- 41830-30 Spatelhalter für flache Spatel (2x)
 support for flat brain spatula (2x)
 soporte para espátulas cerebrales planas (2x)
 sostegno per spatole piatte (2x)

LEYLA Retraktor System
 LEYLA Retractor System
 Separador de sistema LEYLA
 LEYLA Sistema di fissaggio

41821-21

Fixiervorrichtung für 1 flexiblen Spannarm zum Festschrauben an Rohrteilen bis \varnothing 16 mm

Fixation base for mounting on bars up to \varnothing 16 mm, for 1 flexible arm

Fijador para 1 brazo flexible, para atornillar a tubos hasta 16 mm

Fissatore per 1 braccio al braccio rigido



41822-22

Fixiervorrichtung für 2 flexible Spannarme zum Festschrauben am Schädel

Fixation base for skull mounting, holding 2 flexible arms

Fijador para 2 brazos flexibles, para atornillar al cráneo

Fissatore per 2 bracci al cranio



41826-26

Fixiervorrichtung für 1 flexiblen Spannarm zum Festschrauben am Schädel

Fixation base for skull mounting, holding 1 flexible arm

Fijador para 1 brazos flexibles, para atornillar al cráneo

Fissatore per 1 braccio al cranio



41830-30

Spatelhalter für flache Hirnspatula zur Befestigung am Spannarm

Support for flat brain spatula

Soporte para espátulas cerebrales planas para fijación al brazo flexible

Sostegno per spatole piatte



41832-32

Halter für Hirnspatula mit rundem Schaft bis \varnothing 5,5 mm zur Befestigung am Spannarm

Support for brain spatula with round shaft

Soporte para espátulas cerebrales con mango redondo hasta \varnothing 5,5 mm para fijación al brazo flexible

Sostegno flessibile per spatola cerebrale



LEYLA Retraktor System
 LEYLA Retractor System
 Separador de sistema LEYLA
 LEYLA Sistema di fissaggio



YASARGIL

41810-10

flexibler Spannarm, allein
 flexible arm, only
 brazo flexible, suelto
 braccio flessibile, solo

YASARGIL

41803-01

Ohrspekulahalter, komplett, bestehend aus:
 ear specula holder, complete, consisting of:
 soporte para espejos auriculares completo,
 compuesto de:
 sostegno per specolo auricolare, completo
 composto da:

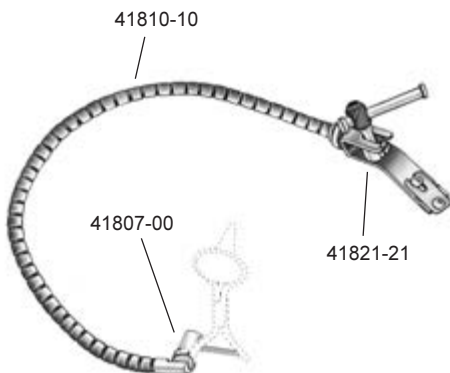

41810-10

flexibler Spannarm
 flexible arm, only
 brazo flexible, suelto
 braccio flessibile, solo

41821-21

Fixiervorrichtung zum Befestigen an Rohrteilen
 bis Ø 16 mm
 clamp for fixation on bars up to Ø 16 mm
 fijador para 1 brazo flexible, para atornillar a
 tubos hasta 16 mm
 fissatore al braccio rigido Ø 16 mm

41807-00

Ohrtrichterhalter, allein
 ear specula holder, only
 soporte para espejos auriculares, suelto
 sostegno per specolo auricolare

LEYLA Retraktor System
 LEYLA Retractor System
 Separador de sistema LEYLA
 LEYLA Sistema di fissaggio

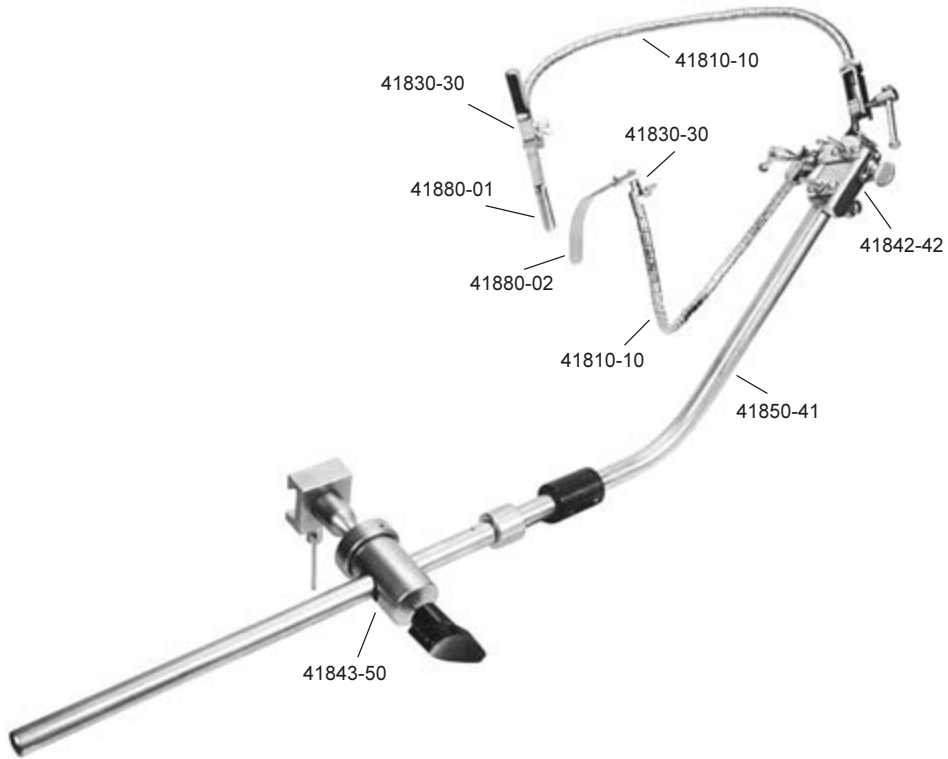

41802-00 LEYLA-Retraktor-System zum Fixieren am OP-Tisch komplett, bestehend aus:
 LEYLA Self-Retraining Retractor for fixation to operating table, complete, consisting of:
 Separador LEYLA para fijacion a la mesa de operaciones, completo, compuesto de:
 LEYLA Sistema di fissaggio al tavolo operatorio, composto da:

- | | | | |
|----------|--|----------|---|
| 41843-50 | Kugelgelenkkloben (1x)
ball and socket joint (1x)
articulacion esferica (1x)
giunto per fissare (1x) | 41830-30 | Spatelhalter für flache Spatel (2x)
support for flat brain spatula (2x)
soporte para espátulas cerebrales planas (2x)
sostegno per spatole piatte (2x) |
| 41850-41 | starrer Haltearm (1x)
rigid holding rod (1x)
brazo de fijación rígido (1x)
braccio di fissaggio rigido (1x) | 41880-01 | CUSHING Hirnspatel (1x)
CUSHING brain spatula (1x)
CUSHING espatula para cerebro (1x)
CUSHING spatola cerebrale (1x) |
| 41842-42 | Kupplungskopf (1x)
coupling head (1x)
cabeza de acoplamiento (1x)
giunto per combinare (1x) | 41880-02 | CUSHING Hirnspatel (1x)
CUSHING brain spatula (1x)
CUSHING espatula para cerebro (1x)
CUSHING spatola cerebrale (1x) |
| 41810-10 | flexibler Spannarm (2x)
flexible arm, only (2x)
brazo flexible, suelto (2x)
braccio flessibile, solo (2x) | | |

LEYLA Retraktor System
 LEYLA Retractor System
 Separador de sistema LEYLA
 LEYLA Sistema di fissaggio



- 41843-50 Kugelgelenkkloben
 zum Befestigen an der OP-
 Tischschiene und zur Aufnahme
 des Haltearms 41850-41
-
- ball and socket joint
 for fixation of holding rod 41850-41
 at the operating table
-
- articulacion esferica, para sujetar el
 brazo de soporte rigido sobre la
 mesa de operaciones 9 x 32 mm
-
- giunto per fissare il braccio,
 articolato 9 x 32 mm



- 41850-41 starrer Haltearm, auseinandernehmbar, zur Fixation im
 Kugelgelenkkloben 41843-50 und zur wahlweisen
 Aufnahme der Kupplungsköpfe 41842-42, 41842-44 und
 41842-46
-
- holding rod, detachable, for fixation in ball and socket
 joint 41843-50 and to hold a desired coupling head
 41842-42, 41842-44 or 41842-46
-
- brazo de soporte rigido, desmontable, para fijacion a la
 articulacion esferica 41843-50 y opcionalmente a las
 cabezas 41842-42, 41842-44 y 41842-46
-
- braccio di sostegno rigido, per fissaggio al giunto
 41843-50 e dei giunti 41842-42, 41842-44 e 41842-46



- 41842-42 Kupplungskopf, zur Aufnahme von
 max. 5 flexiblen Spannarmen
 41810-10
-
- coupling head to hold 5 flexible
 arms 41810-10
-
- cabeza de acoplamiento para fijar
 hasta 5 brazos flexibles
-
- giunto per combinare 5 bracci



- 41842-44 Kupplungskopf, drehbar, zur Aufnahme von 1 flexiblen
 Spannarm 41810-10
-
- coupling head, turnable, to hold 1 flexible arm 41810-10
-
- acoplamiento, girable y se puede fijar en todas las
 posturas para sujetar un brazo flexible 41810-10
-
- giunto per combinare, rotabile, per sostegno del braccio
 41810-10

- 41842-46 Kupplungskopf, seitlich offen zur Aufnahme von 1
 flexiblen Spannarm 41810-10
-
- coupling head, lateral open, to hold 1 flexible arm
 41810-10
-
- acoplamiento, abierto al lado, para un brazo flexible
 41810-10
-
- giunto per fissare il braccio, per 41810-10

Hirnspatel
Brain Spatulas
Espátula Cerebral
Spatole Cerebrali



HEIFETZ
200 mm
8"

	Breite	Gesamtlänge
	width	total length
	ancho	largo total
	larghezza	lunghezza totale

41860-14	14 mm	200 mm
41860-17	17 mm	200 mm
41860-20	20 mm	200 mm



biegsam
malleable
maleable
malleabili



HEIFETZ
155 mm
6"

	Breite	Gesamtlänge
	width	total length
	ancho	largo total
	larghezza	lunghezza totale

41870-08	8 mm	155 mm
41870-11	11 mm	155 mm
41870-14	14 mm	155 mm
41870-17	17 mm	155 mm

	Breite	Gesamtlänge
	width	total length
	ancho	largo total
	larghezza	lunghezza totale

41880-01	9 mm	200 mm
41880-02	12 mm	200 mm
41880-03	12 mm	250 mm



biegsam
malleable
maleable
malleabili

CUSHING
200 mm, 8"

Lidsperrer
Eye Specula
Blefaróstatos
Blefarostati

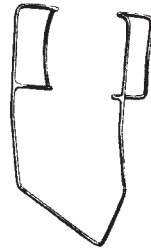

BARRAQUER (Colibri)

43101-03 3 cm, 1.2" für Kinder / children / niños / bambini
43101-04 4 cm, 1.6" für Erwachsene / adults / adultos / adulti



BOWMAN

43104-07
7 cm, 2 3/4"

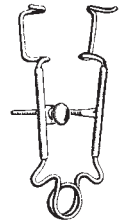

CRITCHETT

43105-06
7 cm, 2 3/4"

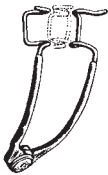

SMITH
43106-05
5 cm, 2"

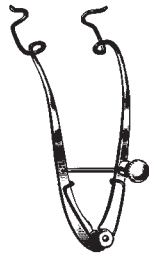

CLARK
43107-08
8 cm, 3 1/8"



GRAEFE

43109-07 7 cm, 2 3/4"
43109-09 9 cm, 3 1/2"



WEEK
43110-08
8 cm, 3 1/8"

rechts
right
a la derecha
destro

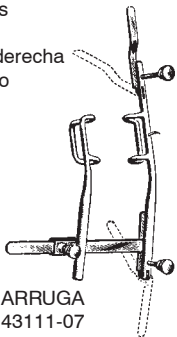

ARRUGA
43111-07
7 cm, 2 3/4"

links
left
a la izquierda
sinistro

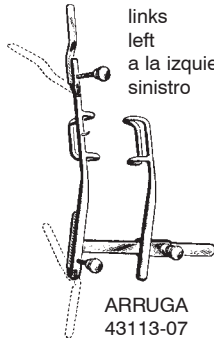

ARRUGA
43113-07
7 cm, 2 3/4"



MURDOCK
43115-05
5 cm, 2"

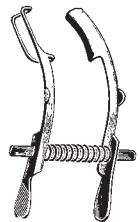

MELLINGER-AXENFELD
43121-07
7 cm, 2 3/4"

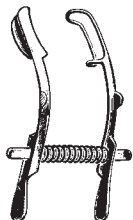

MELLINGER-AXENFELD
43123-07
7 cm, 2 3/4"

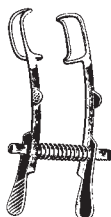

MELLINGER
43125-05 5 cm, 2"
43125-07 7 cm, 2 3/4"



LISTER-BURCH
43127-08
8 cm, 3 1/8"

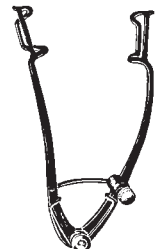

WILLIAMS
43128-08
8 cm, 3 1/8"

Lidsperrer, Lidplatte, Starmesser
 Eye Specula, Lid Plate, Cataract Knives
 Blefaróstatos, Placa para párpados, cuchillos para cataratas
 Blefarostati, Placca per palpebre, coltelli per cataratta

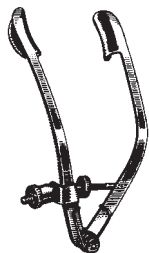

LANCASTER
 43129-07
 7 cm, 2 3/4"



ZIEGLER
 43130-07
 7 cm, 2 3/4"



CASTROVIEJO
 43132-08
 8 cm, 3 1/8"

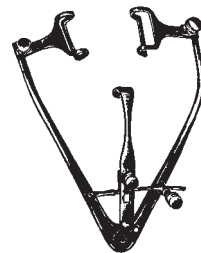

PARK
 43133-08
 8 cm, 3 1/8"



MUELLER
 43135-07
 7 cm, 2 3/4"



STEVENSON
 43139-07
 7 cm, 2 3/4"



LIEBERMAN
 43140-08
 8 cm 3 1/8"



LIEBERMAN
 43141-08
 8 cm 3 1/8"



JAEGER
 43150-11
 11 cm, 4 3/8"



GRAEFE
 43170-00 - 43170-03
 13 cm, 5 1/8"



43170-00



43170-01



43170-02



43170-03



DEUTSCHMANN
 43172-13
 13 cm, 5 1/8"

Lanzenmesser, Diszisionsmesser, Irismesser, Diszisionsmesser
 Cataract knife, keratome, Iris knife, discision knife
 Cuchillos lanceolares y Cuchillos de discisión
 Cheratom, bisturi p. capsule, bisturi corneale

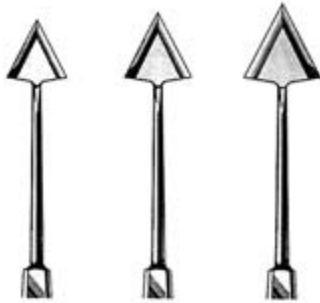
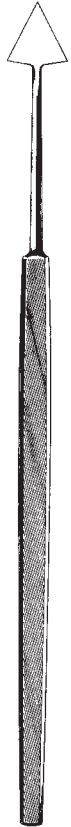

JAEGER
 43180-01 Fig. 1 13 cm, 5 1/8"
 43180-02 Fig. 2 13 cm, 5 1/8"
 43180-03 Fig. 3 13 cm, 5 1/8"



JAEGER 45°
 43181-01 Fig. 1
 43181-02 Fig. 2
 43181-03 Fig. 3



BERENS
 43183-13
 13 cm, 5 1/8"



CASTROVIEJO
 43185-13 13 cm
 4 x 13 mm



GRAEFE
 43187-13
 13 cm, 5 1/8"

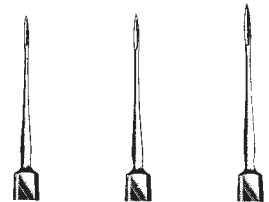

KNAPP
 43202-01 Fig. 1 13 cm, 5 1/8"
 43202-02 Fig. 2 13 cm, 5 1/8"
 43202-03 Fig. 3 13 cm, 5 1/8"

43180-01 - 43181-03



ZIEGLER
 43210-01 5 mm
 Fig. 1
 13 cm, 5 1/8"



ZIEGLER
 43210-02 6 mm
 Fig. 2
 13 cm, 5 1/8"



ZIEGLER
 43210-03 7 mm
 Fig. 3
 13 cm, 5 1/8"



DEAN
 43213-12
 12,5 cm, 5"

Hornhautmesser, Hornhautschaber, Dissektor, Sklerotom, Goniotomiemesser
 Corneal Scarifier, -dissector, sclerotome, goniotomy knife
 Cuchillos para cornea, legtras corneales, esclerótomos
 Spatole p. corneale, dissettoe corneale, sclerotomo, coltello per goniotomia



WHEELER
43218-12
12 cm, 4 3/4"



ZIEGLER
43221-11
11 cm, 4 3/8"
3,5 mm



TOOK
43228-12
12 cm, 4 3/4"



GILL
43231-12
12 cm, 4 3/4"



ELSCHNIG
43233-13
13 cm, 5 1/8"



PATON
43245-12
12 cm, 4 3/4"



LUNDSGAARD
43251-12
12 cm, 4 3/4"



GUYTON-
LUNDSGAARD
43253-12



BARKAN
43256-12



SCHEIE
43258-12



BURCH
43262-12



PAUFIQUE
43271-11



BARRAQUER
43273-13

Diszisionsnadeln, Fremdkörpernadeln, Fremdkörperhohlmeißel
 Discision Needles, Foreign-Body Instruments
 Aguja de discisión, Instrumental para cuerpos extraños
 Aghi per discisione, strumenti per corpi estranei



43304-12



43305-12

BOWMAN
43308-12BOWMAN
43309-12

43310-13

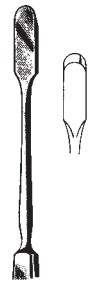

43311-13

LEVINSON
43314-13FRANCIS
43321-12DAVIS
43325-13LA FORCE
43327-12DIX
43330-13ELLIS
43331-11WALTON
43332-12
1,4 mmWALTON
43334-12
1,4 mmALVIS
43336-12GREEN
43340-13ROLLET
43342-12

Schielhaken, Tenotomiehaken, Extraktionshaken, Tränenackhäkchen
 Strabismus hook, lens hook, extraction hook
 Ganchos para estrabismo, - cristalino, extracción
 Uncino per il strabismo, uncino p. cristallino, protettori, uncini per l'iride



Fig. 1
 GRAEFE
 43351-01
 13 cm, 5 1/8"



Fig. 2
 GRAEFE
 43351-02
 14 cm, 5 1/2"



Fig. 3
 GRAEFE
 43351-03
 15 cm, 6"



JAMESON
 43353-13



GREEN
 43355-13



STEVENS
 43357-13



Fig. 1
 ARRUGA
 43363-01



Fig. 2
 ARRUGA
 43363-02



O'CONNOR
 43370-12



WIENER
 43372-13



WIENER
 43373-13



ROLLET
 43376-13



KNAPP
 43377-13



GRAEFE
 43380-13



GRAEFE
 43381-13



GRAEFE
 43383-13



BECKER
 43386-13

Implantations Instrumente
 Instruments for Implantation
 Instrumentos para implantaciòn
 Strumenti per impianto

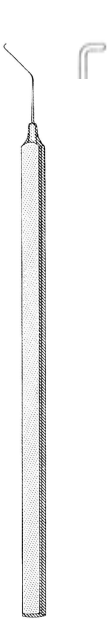

CLAYMAN
 43387-02
 11,5 cm 4 1/2"



SINSKEY
 43388-02
 11,4 cm 4 1/2"



SINSKEY
 43389-02
 12 cm 4 3/4"

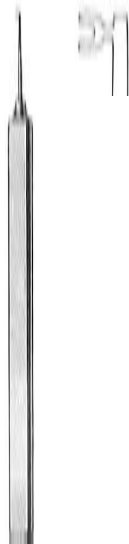

KUGLEN
 43390-05
 11,7 cm 4 5/8"

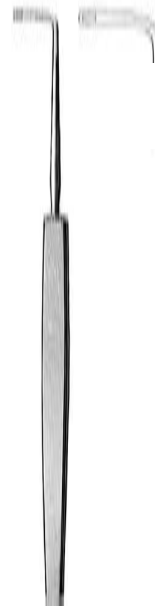

GASS
 43391-13
 14,6 cm 5 3/4"

Küretten und Löffel für Chalazion und Star
 Scoops and Curettes for Chalazio, Cataract, and Exenteration
 Curetas y cucharillas para chalazión, catarata y exenteración
 Curette e cucchiari per calazio, cateratta e palpebre

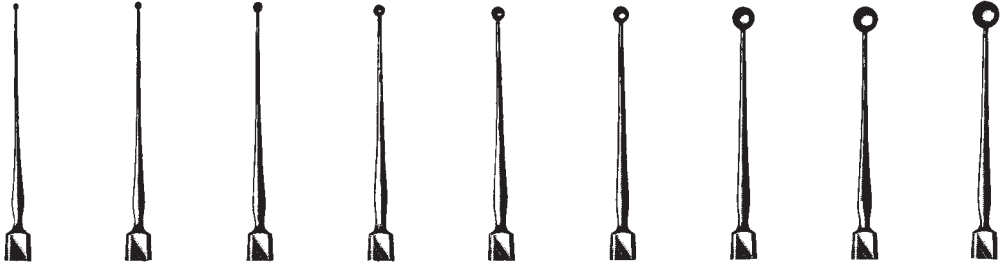

MEYHOEFER

	43402-05	43402-10	43402-15	43402-18	43402-20	43402-25	43402-35	43402-40	43402-45
Ø mm	0,5	1,0	1,5	1,8	2,0	2,5	3,5	4,0	4,5

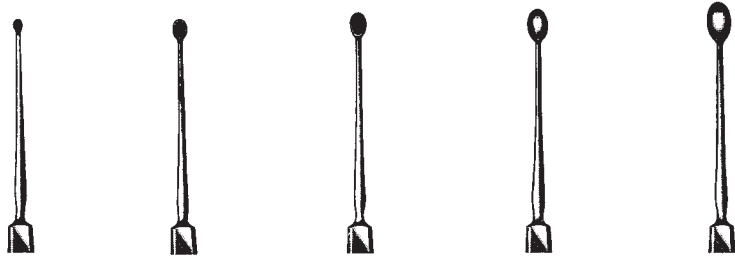

	HEBRA	HEBRA	HEBRA	HEBRA	HEBRA
	43404-10	43404-20	43404-24	43404-30	43404-35
Ø mm	1,0	2,0	2,5	3,0	3,5



AXENFELD
43407-13



GRAEFE
43410-01



GRAEFE
43410-02



DAVIEL
43412-01
3 mm



DAVIEL
43412-02
4 mm

Starlöffel, Exenterationslöffel, Drahtschlingen, Starschlingen, Irisspatel, Enukleationslöffel, Wundlöffel
 Cataract Spoon, Exenteration Scoops, Lens Scoops, Spatulas, Protectores
 Cucharillas para Catarata-, exenteración, Asas, Espátulas, Protectores
 Cucchiaino per cataratta- esenterazione, Anse, Spatole, Protettori



KNAPP
43414-02



BUNGE
43420-01



BUNGE
43420-02



BUNGE
43420-03



LANG
43424-13



WEBER
43441-01
Fig. 1



43441-02
Fig. 2



SNELLEN
43443-13



WILDER
43445-13
Fig. 1



43447-13
Fig. 2



ARLT



43449-01

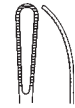

43449-02

Cautery
Cauter
Cauterio

Iris
Iride



WECKER
43461-13



WECKER
43462-13



WELLS
43482-20



ARRUGA
43485-13



WADSWORTH-TODD
43487-14

Zyklodialysespatel, Fremdkörperinstrumente
 Cyclodialysis Spatula, Foreign Body Instruments
 Espátulas para ciclodialísis, Instrumentos para cuerpos extraños
 Spatole per ciclodialisi, Strumenti per corpi estranei



BANGERTER



43501-06
6 mm

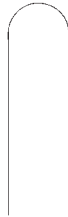

43501-10
10 mm



43501-12
12 mm



43511-13 - 43517-09



CASTROVIEJO
43511-13
1,2 x 10 mm



CASTROVIEJO
43513-14
1,5 x 15 mm



ELSCHNIG
43515-14
1,2 x 12 mm



CASTROVIEJO
43517-09
0,8 x 15 mm

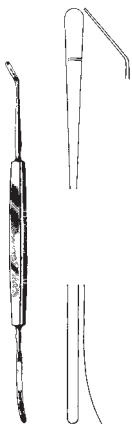

CASTROVIEJO
43521-12
12 cm, 4 3/4"

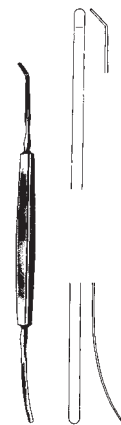

WHEELER
43523-12
12 cm, 4 3/4"



HIRSCHMAN
43524-10
12,5 cm, 5"



CASTROVIEJO
43525-05 0,50 mm
43525-07 0,75 mm
43525-10 1,00 mm



BECHERT
43526-12
12,5 cm, 5"

Fremdkörperinstrumente, Meßzirkel, Kapselstanze

Foreign- Body Instruments, Markers, Corneoscleral punch

Instrumental para cuerpos extraños, Compás de la cápsula, Pinza para capsuloiridectom

Strumenti per corpi estranei, Marcatori, Pinza per capsula



DIX
43542-12



DIX
43544-12



DIX
43546-13



DIX
43548-13



CASTROVIEJO
43583-07 0-20 mm
7 cm, 2 3/4"



CONNIN-AMSLER
43589-13



HOLTH
43593-09
9 cm, 3 1/2"

Tränenkanaldilatatoren, Sonden
 Lachrymal Dilators-, Probes
 Diladores, Estiletos para canal lacrimal
 Dilatori e Specilli per canale lacrimale



WILDER
43602-01



WILDER
43602-02



WILDER
43602-03



Fig. ZIEGLER
 1/2 43605-12
 3/4 43605-34
 5/6 43605-56



CASTROVIEJO
43608-12

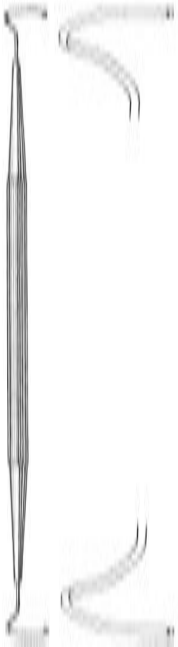

WORST
43609-14
14,9 cm 5 7/8"

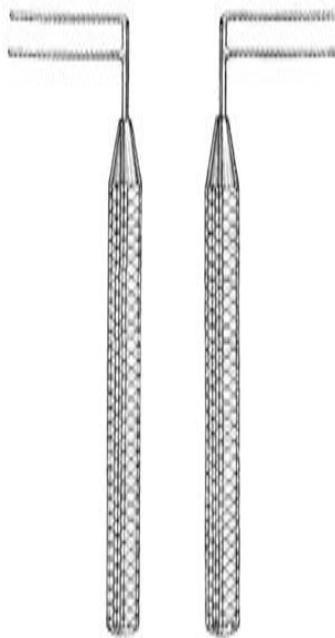

HARMS
43610-01 43610-02
4,8 cm 1 7/8"

geknöpft



rostfrei
 stainless steel
 acero inoxidable
 acciaio inossidabile

Fig.	BOWMAN	Ø mm
0000/000	43613-00	0,6/0,7
00/0	43614-00	0,7/0,8
0/1	43614-01	0,8/0,9
1/2	43614-12	0,9/1,1
2/3	43614-23	1,1/1,3
3/4	43614-34	1,3/1,4
4/5	43614-45	1,4/1,5
5/6	43614-56	1,5/1,6
6/7	43614-67	1,6/1,8
7/8	43614-78	1,8/1,9

Iris Pinzetten
 Iris Forceps
 Pinzas para iris
 Pinze per iride



GRAEFE
 43802-07
 7 cm (2 3/4")/1 mm

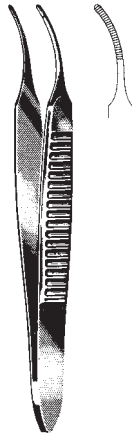

GRAEFE
 43803-07
 7 cm (2 3/4")/1 mm

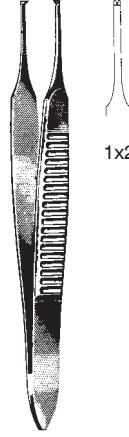

GRAEFE
 43804-07
 7 cm (2 3/4")/1 mm

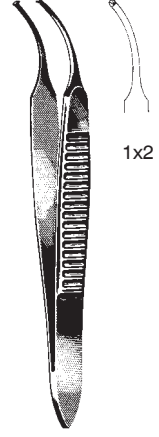

GRAEFE
 43805-07
 7 cm (2 3/4")/1 mm



GRAEFE
 43810-10
 10 cm
 4"



GRAEFE
 43811-10
 10 cm
 4"



GRAEFE
 43813-10
 10 cm
 4"



GRAEFE
 43820-10
 10 cm
 4"

1x2



GRAEFE
 43821-10
 10 cm
 4"

1x2



GRAEFE
 43823-10
 10 cm
 4"

1x2

Iris Pinzetten
Iris Forceps
Pinzas para iris
Pinze per iride



STEVENS
43830-10
10,5 cm, 4.1"



STEVENS
43833-10
10,5 cm
4.1"

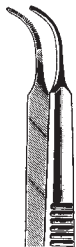

STEVENS
43833-10
10,5 cm
4.1"



STEVENS
43840-10
10,5 cm
4.1"



STEVENS
43841-10
10,5 cm
4.1"



STEVENS
43843-10
10,5 cm
4.1"

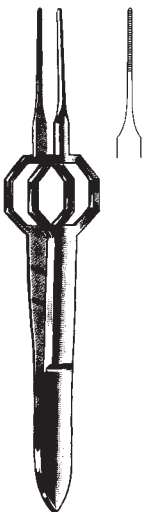

FOERSTER
43850-08
8,5 cm, 3.4"

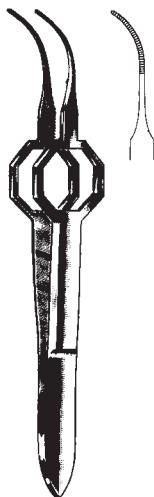

FOERSTER
43851-08
8,5 cm, 3.4"

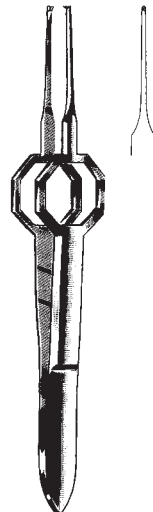

FOERSTER
43852-08
8,5 cm, 3.4"

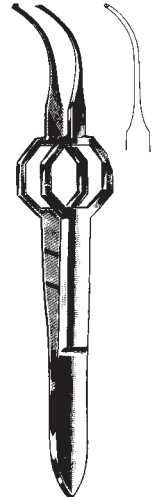

FOERSTER
43853-08
8,5 cm, 3.4"

Iris Pinzetten
Iris Forceps
Pinzas para iris
Pinze per iride

seitliche Zähne
lateral teeth
dientes laterales
denti laterali

Zähne abwärts
teeth below
dientes abajo
denti in basso

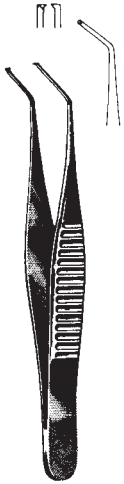

HESS
43855-07
7 cm (2 3/4")/
0,3 mm

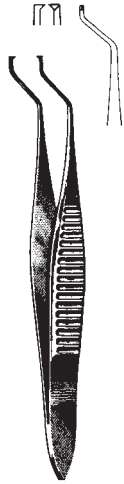

HESS
43857-07
7 cm (2 3/4")/
0,3 mm



GILL
43861-07
7,5 cm (3")/
0,3 mm



GILL-HESS
43863-07
7,5 cm (3")/
0,3 mm



GILL-HESS
43865-07
7,5 cm (3")/
0,3 mm

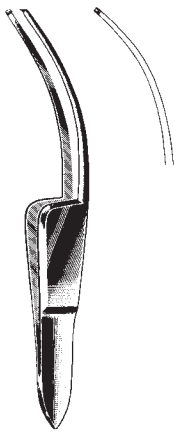

FISCHER
43869-07
7 cm (2 3/4")



BARRAQUER-KATZIN
43881-07
7 cm (2 3/4")/0,4 mm



TROUTMAN (Colibri)
43883-07
7 cm (2 3/4")/0,12 mm



BARRAQUER (Colibri)
43885-07
7 cm (2 3/4")/0,12 mm



BARRAQUER (Colibri)
43887-07
7 cm (2 3/4")/0,12 mm

Fixierpinzette, Strabismus-Pinzetten
 Fixation forceps, Strabismus-Forceps
 Pinza para fijación, Pinzas para estrabismo
 Pinza per fissatrice, Pinze per strabismo



1x2

KIRBY-ARTHUR
 43891-09 9 cm, 3 1/2"
 0,2 mm



McCULLOUGH
 43902-09
 9,5 cm, 3 3/4"



McCULLOUGH
 43903-09
 9,5 cm, 3 3/4"

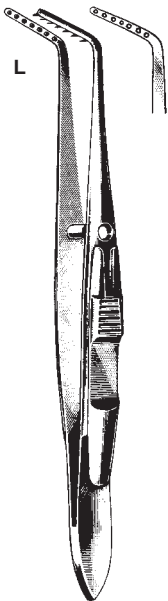

JAMESON
 43907-10
 10 cm, 4"

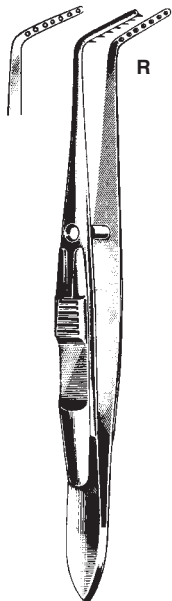

JAMESON
 43909-10
 10 cm, 4"



BONACCOLTO
 43914-10
 10 cm, 4"/1,7 mm



BONACCOLTO
 43916-10
 10 cm, 4"/1,2 mm



BONACCOLTO
 43920-11
 11 cm, 4 3/8"

Strabismus-Pinzetten, Iris-Pinzetten
 Strabismus-Forceps, Iris Forceps
 Pinzas para estrabismo, Pinzas para iris
 Pinze per strabismo, Pinze per iride



DASTOOR
 43924-11
 11 cm, 4 $\frac{3}{8}$ "



DASTOOR
 43926-11
 11 cm, 4 $\frac{3}{8}$ "



BISHOP-HARMAN
 43940-05 8,5 cm, 3.4"
 0,5 mm



BISHOP-HARMAN
 43940-08 8,5 cm, 3.4"
 0,8 mm



BISHOP-HARMAN
 43942-05 8,5 cm, 3.4"
 0,5 mm



BISHOP-HARMAN
 43942-08 8,5 cm, 3.4"
 0,8 mm

1x2

1x2

Iris Pinzetten, Nahtpinzetten, Muskelpinzetten
 Iris, Suture forceps, Muscle Forceps
 Pinzas para iris, Pinza para sutura, Pinzas musculares
 Pinze per iride, Pinza per sutura, muscolari

mit Führungsstift
 with guide pin
 con perno guida
 con perno di guida

ohne Führungsstift
 without guide pin
 sin perno guida
 senza perno di guida



MOD. BONN
 43944-07
 7 cm, 2 3/4"
 0,12 mm



MOD. BONN
 43946-07
 7 cm, 2 3/4"
 0,12 mm



MOD. BONN
 43948-10
 10 cm, 4"
 0,12 mm



MOD. TÜBINGEN
 43950-10
 10 cm, 4"



MOD. BONN
 43952-10
 10 cm, 4"/0,12 mm



MOD. TÜBINGEN
 43953-10
 10 cm, 4"

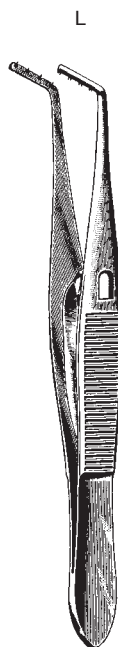

L

PRINCE
 43955-10
 10 cm, 4"

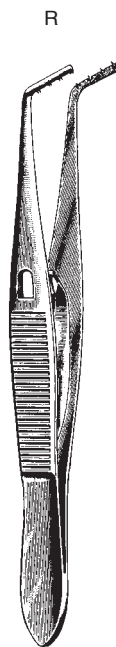

R

PRINCE
 43956-10
 10 cm, 4"



Muskelpinzetten, Fixationspinzetten
 Muscule Forceps, Fixation Forceps
 Pinzas musculares, Pinzas para fijación
 Pinze muscolari, Pinze per fissaggio

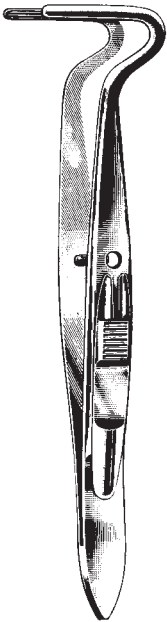

BERKE
 44015-20 - 44015-27
 10 cm, 4"

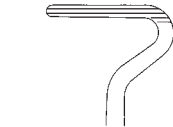

44015-20

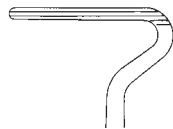

44015-27



1x2

TROUTMAN
 44017-08 8,5 cm, 3.4"
 0,8 mm



ELSCHNIG
 44046-11
 11 cm, 4 3/8"



GRAEFE
 44050-11 - 44052-11
 11 cm, 4 3/8"



44050-11



44052-11
 mit Sperre
 with catch
 con cierre
 c. cremagliera



LESTER
 44054-09
 9 cm, 3 1/2"

Fixierpinzetten, Kapselpinzette
 Fixation forceps, capsular forceps
 Pinzas para fijación, Pinzas capsulares
 Pinze fissatrici, Pinze per capsulari

1x1



CASTROVIEJO
 44066-09
 9 cm, 3 1/2"

1x1



CASTROVIEJO
 44067-09
 9 cm, 3 1/2"

2x2



CASTROVIEJO
 44068-09
 9 cm, 3 1/2"

2x2



CASTROVIEJO
 44069-09
 9 cm, 3 1/2"



BARRAQUER
 44074-10
 10 cm, 4"

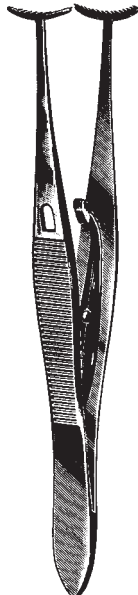

GREEN
 44076-05 - 44078-10
 10 cm, 4"



44076-05 44076-10
 5 mm 10 mm

ohne Sperre
 without catch
 sin cierre
 senza cremagliera



44078-05 44078-10
 5 mm 10 mm

mit Sperre
 with catch
 con cierre
 con cremagliera



GILL-ARRUGA
 44101-07
 7,5 cm, 3"

Kapselpinzetten
 Capsular Forceps
 Pinzas capsulares
 Pinze capsulare



TERSON
 44103-09
 9 cm, 3 1/2"



KALT
 44106-10
 10 cm, 4"



ELSCHNIG
 44109-10
 10 cm, 4"



ARRUGA
 44111-10
 10 cm, 4"



ARRUGA
 44114-10
 10 cm, 4"



CASTROVIEJO
 44115-10
 10 cm, 4"



SCHWEIGGER
 44117-10
 10 cm, 4"



SCHWEIGGER
 44119-10
 10 cm, 4"



ELSCHNIG
 44121-10
 10 cm, 4"

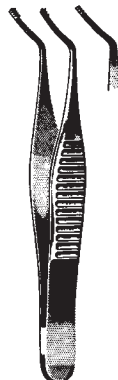

HESS
 44125-06
 6 cm, 2.4"



HESS
 44127-06
 6,5 cm, 2.6"

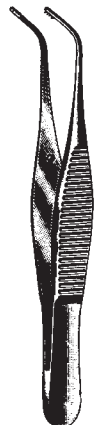

FUCHS
 44129-07
 7 cm, 2 3/4"

Nahtpinzetten, Fadenpinzetten
 Suture Forceps, Tying Forceps
 Pinzas para suturas y hilo
 Pinze per sutura, Pinze per filo

1x2



CASTROVIEJO

10 cm, 4"

- 44150-01 0,12 mm
- 44150-03 0,30 mm
- 44150-05 0,50 mm
- 44150-10 1,00 mm
- 44150-15 1,50 mm

1x2



CASTROVIEJO

10 cm, 4"

- 44151-05
- 44151-10
- 44151-15

Zahn
tooth
diente
dente



MOORFIELD

44164-10
10 cm, 4"

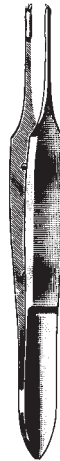

St. MARTIN

44166-07
7 cm, 2 3/4"



Mod. TÜBINGEN

44181-10
10 cm, 4"

1x2



PAUFIQUE

44190-08
8,5 cm, 3.4"



PAUFIQUE

44202-08
8,5 cm, 3.4"



McPHERSON

44210-10
10 cm, 4"



McPHERSON

44220-10
10 cm, 4"

Pinzetten für Chalazion und Trachom
 Forceps for Chalazion and Trachoma
 Pinzas de chalazión y para tracoma
 Pinze per calazio e per trichiasi



AYER
 44240-09
 9 cm, 3 1/2"



AYER
 44242-09
 9 cm, 3 1/2"



LAMBERT
 44246-09
 9 cm, 3 1/2"

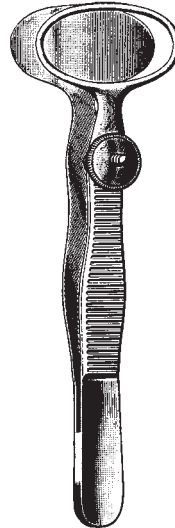

DESMARRES
 44254-09 - 44258-09
 9 cm, 3 1/2"

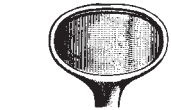

44254-09 20 mm
 Fig. 1

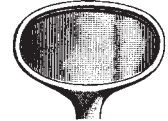

44256-09 24 mm
 Fig. 2

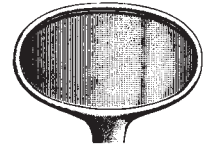

44258-09 32 mm
 Fig. 3

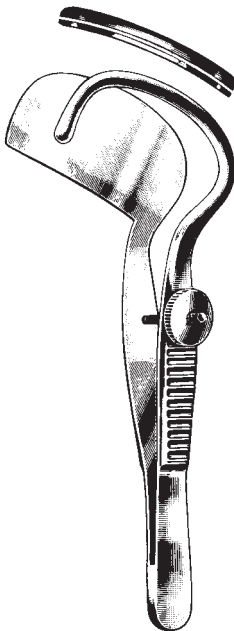

SNELLEN
 44265-10 10 cm, 4"

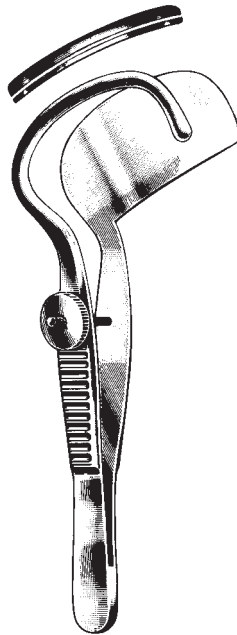

SNELLEN
 44267-10 10 cm, 4"

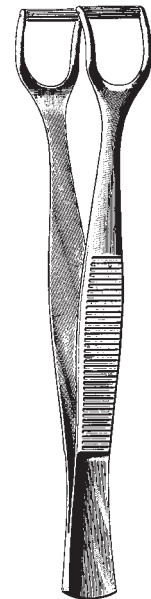

KNAPP-LUER
 44274-11 11 cm, 4 3/8"

Augenkanülen
 Eye Cannulas
 Cánulas oculares
 Cannule oculistiche



LACRIMAL
 44300-00 23 gauge



LACRIMAL
 44301-00 23 gauge



McIntyre
 44310-00 23 gauge



McIntyre
 44311-00 23 gauge



Air Injection
 44320-00 27 gauge
 44330-00 30 gauge



JENSEN
 44340-00 23 gauge
 44350-00 25 gauge

Spül- und Saugkanülen, Augenkanülen
Irrigation and Aspiration Cannulas, Eye Cannulas
Cánulas de irrigación y aspiración, Cánulas oculares
Cannule per irrigazione ed aspirazione, Cannule oculistiche

**BISHOP-HARMON**

44370-00 komplett / complete

44371-00 Silikonball / silicone bulb

44372-00 Adapter / adaptor

44373-00 19 gauge Kanüle / cannula

44374-00 21 gauge Kanüle / cannula

Augenkanülen, Tonometer
 Eye Cannulas, Tonometer
 Cánulas oculares, Tonómetro
 Cannule oculistiche, Tonometro



SHEETS
44380-00

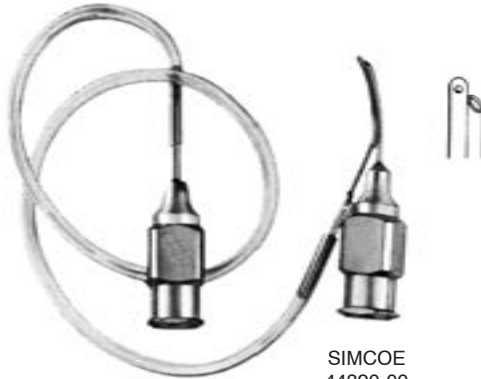

SIMCOE
44390-00

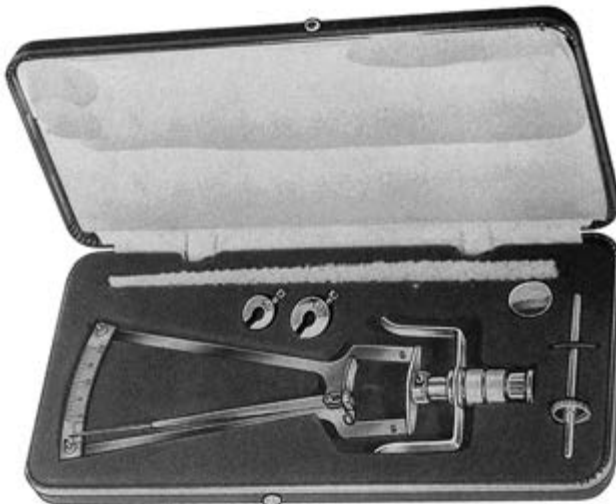

	SCHIOETZ	
	44404-00	44406-00
Skala	gerade	schräg
scale	straight	oblique
escala	recta	oblícua
scala	retta	obliqua

44404-00 G	geeicht
44406-00 G	calibrated
	calibrado
	calibrato

Augenmagnet, Cilienpinzetten
Eye Magnet, Cilia Forceps
Imàn para cuerpos extraños, Pinzas depilatorias
Calamita per corpi estranei, Pinze depilatorie



REDA
44408-00



BEER
44420-09
9 cm, 3 1/2"

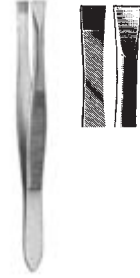

DOUGLAS
44422-09
9 cm, 3 1/2"



LITTAUER
44424-08
8,5 cm, 3.4"



BARRAQUER
44425-10
10,5 cm, 4.1"



REDA
44426-09
9 cm, 3 1/2"

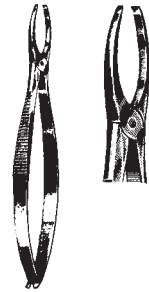

GRADLE
44428-09
9,5 cm, 3 3/4"





Ohrspekula
Ear Specula
Espéculos auriculares
Specoli auricolari



POLTIZER
45009-00
Set = 3

Innen Ø
○ = 2,0 mm
45009-02

○ = 3,0 mm
45009-03

○ = 4,0 mm
45009-04



HARTMANN
45010-00
Set = 4

Innen Ø
○ = 2,0 mm
45010-20

○ = 3,0 mm
45010-30

○ = 4,5 mm
45010-45

○ = 5,5 mm
45010-55

○ = 6,5 mm
45010-65

○ = 7,5 mm
45010-75



HARTMANN
45011-00
Set 3-7 mm

schwarz
black
negro
nero

Innen Ø
○ = 2,0 mm
45011-03

○ = 3,5 mm
45011-04

○ = 5,0 mm
45011-05

○ = 6,5 mm
45011-07

○ = 7,5 mm
45011-08



TOYNBEE
45012-00
Set = 3

Innen Ø
○ = 4,0 mm
45012-40

○ = 5,5 mm
45012-55

○ = 6,5 mm
45012-65

○ = 7,5 mm
45012-75



GRUBER, rund
45014-00
Set = 4

Innen Ø
○ = 4,5 mm
45014-45

○ = 5,5 mm
45014-55

○ = 6,5 mm
45014-65

○ = 7,5 mm
45014-75



GRUBER, oval
45015-00
Set = 3

Innen Ø
○ = 4,5 mm
45015-45

○ = 5,5 mm
45015-55

○ = 6,5 mm
45015-65

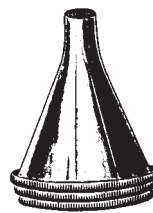

BOUCHERON
45018-00
Set = 4

Innen Ø
○ = 5,0 mm
45018-50

○ = 6,0 mm
45018-60

○ = 7,0 mm
45018-70

○ = 8,0 mm
45018-80

Ohrspekula
Ear Specula
Espéculos auriculares
Specoli auricolari

○
45020-01
Ø 3 mm

○
45020-02
Ø 4 mm

○
45020-03
Ø 5 mm

○
45020-04
Ø 6 mm

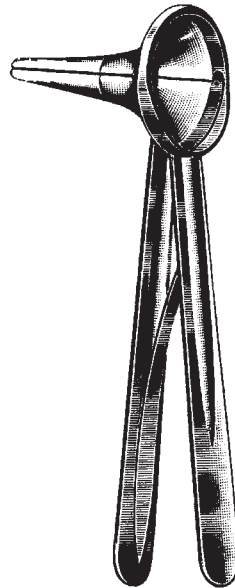

RICHNAU-HOLMGREN

Ohrspekula
Ear Specula
Espéculos auriculares
Specoli auricolari

6,5 mm



45030-06

7,5 mm



45030-07

8,2 mm



45030-08

10 mm



45030-10

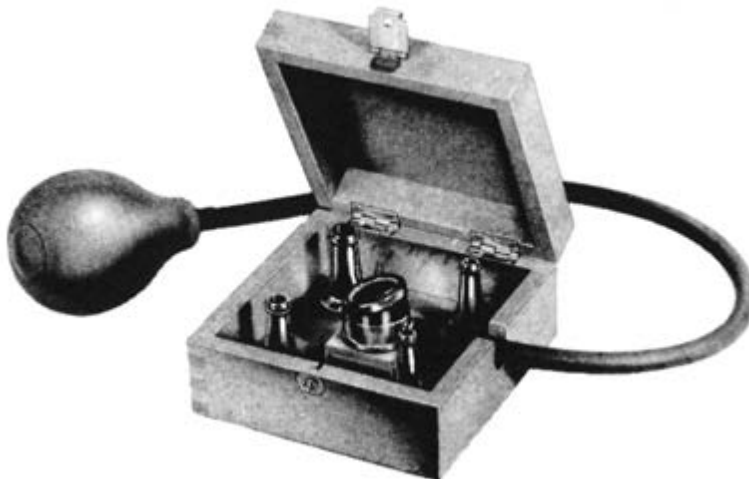

BRUENINGS
45030-04

45030-04

Komplett bestehend aus:
4 Spekula, Saugkammer mit
Gebläse, Holzetui

Complete consisting of:
4 specula, suction head and rubber
tube with bulb, wooden case

Compuesto de:
4 espéculos, cámara de aspiración,
insuflador de goma, en estuche de
madera

Composta da:
4 specoli, camera aspirante con
soffiatrice, scatola di legno

Ersatzteile / spare parts /
repuestos / pezzi di ricambio

45036-09

Lupe / Magnification glass /
lupa / lente d'ingrandimento

45036-10

Saugpumpe / rubber ball /
pera de goma / soffiatrice di gomma

Ohrspekula
Ear Specula
Espéculos auriculares
Specoli auricolari



6,5 mm Ø



45036-06



7 mm Ø



45036-07



8 mm Ø



45036-08

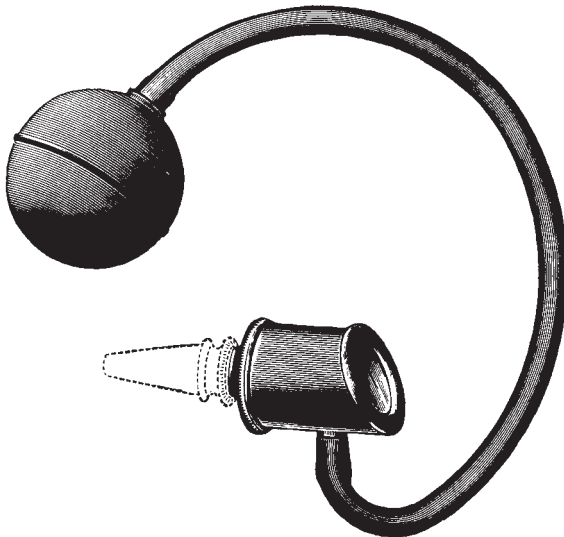

SIEGLE
45036-03

45036-03

Komplett bestehend aus:
Ohrspekulum, 3 Spekula, 1 Gebläse

Complete consisting of:
Ear Specula, 1 rubber tube with bulb

Compuesto de:
Otoscopio con 3 espéculos, insuflador y tubo

Composta da:
Otoscopio con 3 specoli e 1 insufflatore con tubo

Stimmgabeln
Tuning Forks
Diapasones
Diapason

ALU

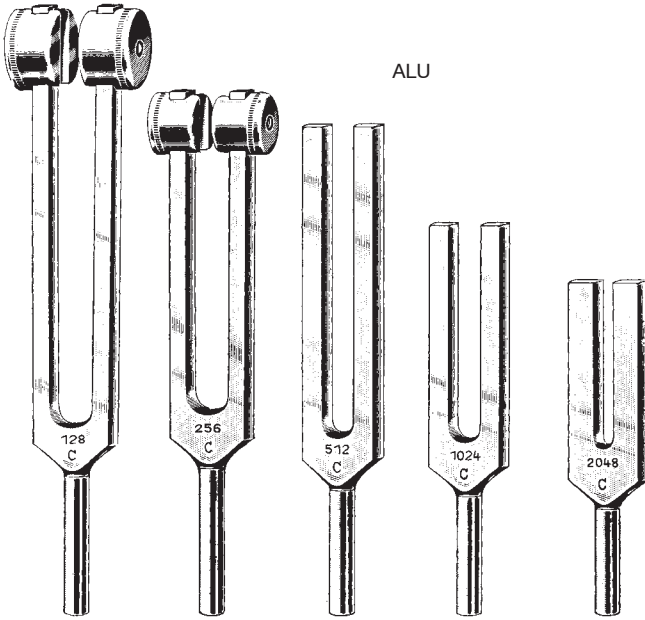

45060-01
C 128

45060-02
C¹ 256

45060-03
C² 512

45060-04
C³ 1024

45060-05
C⁴ 2048

45061-00
compl.

STAINLESS

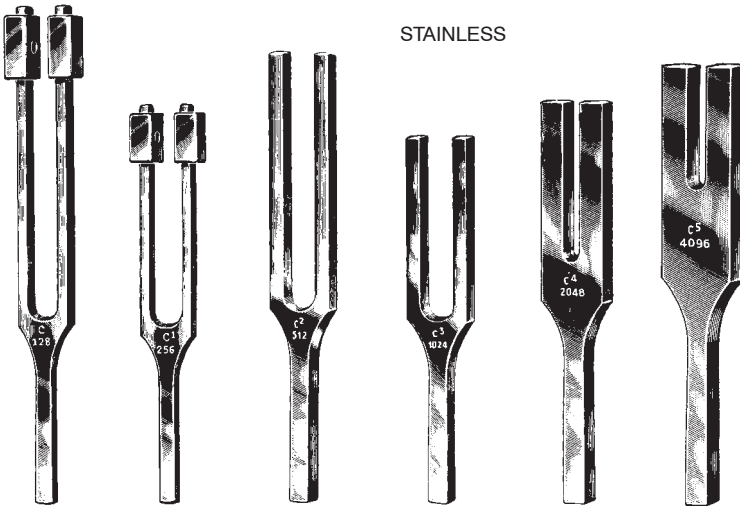

45070-01
C 128

45070-02
C¹ 256

45070-03
C² 512

45070-04
C³ 1024

45070-05
C⁴ 2048

45070-06
C⁵ 4096

HARTMANN

45071-00
compl.

Stimmgabeln
Tuning Forks
Diapasones
Diapason



45072-01
a¹ 440



LUCAE
45073-01 C 128
45073-02 C¹ 256
45073-03 C² 512
45073-04 C³ 1024
45073-05 C⁴ 2048
45073-06 C⁵ 4096



LUCAE
45074-01
C 128



45075-00

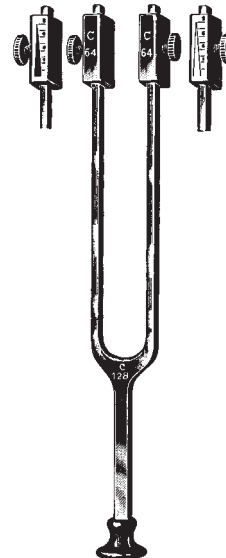

RYDEL-SEIFFERT
45076-01 C 128 / C 64

Lärmtrommel, Pulverbläser
 Noise Apparatus, Powder Blowers
 Ensordecedor, Lanzapolvero
 Assorditore, Insoffiatori per polvere



BARANY
 45080-00

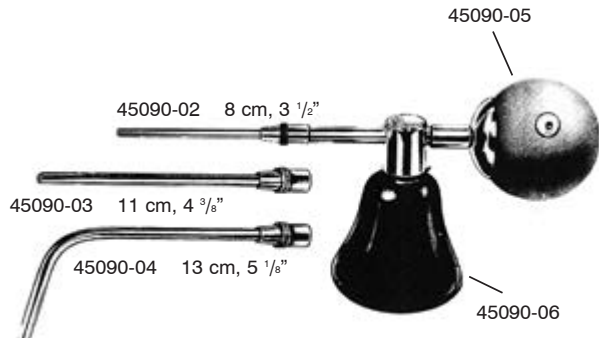

KABIERSKE
 45090-00 30 ccm
 komplett mit 3 Kanülen und Gummiball
 complete with 3 cannulas and rubber bulb
 completo con 3 cánulas y pera de goma
 completo con 3 cannule e pera di gomma

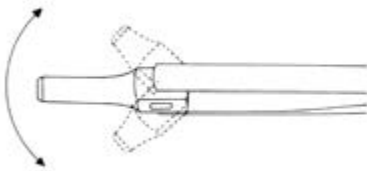

UNIVERSAL
 45090-08

Komplett mit beweglicher Düse,
 Schraubflasche 30 ccm und Halbgebläse
 complete with movable tube, screw bottle
 30 ccm and rubber bulb
 completo con tubo móvil botella con rosca
 30 ccm y pera de goma
 completo con tubo mobile, bottiglia con
 filettatura 30 ccm e pera di insufflazione



Luftdusche, Ohrspritze
 Air Bag, Ear Syringe
 Insuflador de aire, Jeringa
 Insoffiatore d'aria, Siringa Auricolare

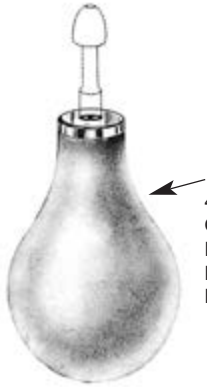

45091-02
 Gummibirne alleine
 Rubber bulb only
 Pera de goma, sola
 Pera di gomma, sola

POLITZER
 45091-00 Set
 incl.
 45091-03
 45091-15
 45091-17
 45091-22

POLITZER
 45091-01 Set
 incl.
 45091-03
 45091-04
 45091-15
 45091-17
 45091-22

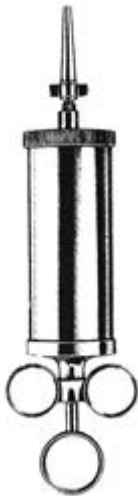

45091-03

45091-04
4 mm Ø45091-15
15 mm Ø45091-17
17 mm Ø45091-22
22 mm Ø

ml REINER
 50 45096-50
 75 45096-75
 100 45097-10
 150 45097-15



45097-01

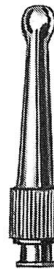

45097-02



45097-03

Spritze, Küretten
 Syringe, Curettes
 Jeringa, Curetas
 Siringa, Curette



45098-01 1 ml
 45098-02 2 ml
 45098-05 5 ml
 45098-10 10 ml
 45098-20 20 ml
 45098-50 50 ml

45099-01 1 ml
 45099-02 2 ml
 45099-05 5 ml
 45099-10 10 ml
 45099-20 20 ml
 45099-50 50 ml

	Innen Ø	1.5 mm	1.9 mm	2.5 mm	2.7 mm	3.4 mm	4.0 mm	4.5 mm
Küretten Curettes Curetas Curette								
		Fig. 00	0	1	2	3	4	5
stumpf blunt romas smusse		45109-00	45110-00	45110-01	45110-02	45110-03	45110-04	45110-05
scharf sharp cortantes taglianti		45111-00	45112-00	45112-01	45112-02	45112-03	45112-04	45112-05
stumpf blunt romas smusse		45114-00	45115-00	45115-01	45115-02	45115-03	45115-04	45115-05
scharf sharp cortantes taglianti		45116-00	45117-00	45117-01	45117-02	45117-03	45117-04	45117-05

BUCK

14,5 cm, 5 3/4"

Ohrkatheter, Parazentese Nadeln, Ohrmesser
 Catheters, Paracentesis Needles, Ear Knives
 Cateteres, agujas para paracentesis, Cuchillos auriculares
 Cateteri, Aghi per paracentesi, Coltelli auricolari

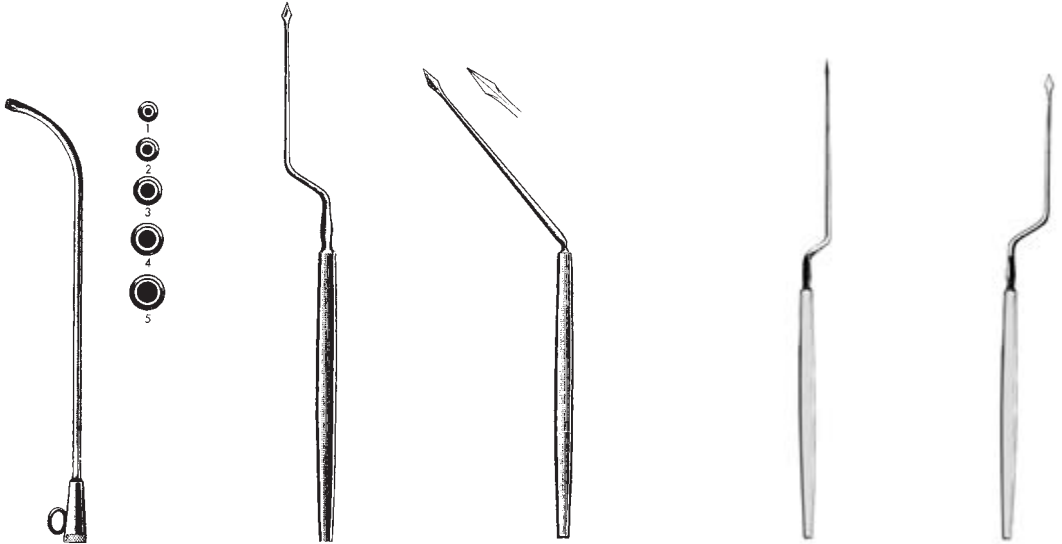

Fig. HARTMANN

- | | | |
|---|----------|--------|
| 1 | 45133-01 | 3,5 mm |
| 2 | 45133-02 | 4,0 mm |
| 3 | 45133-03 | 4,5 mm |
| 4 | 45133-04 | 5,0 mm |
| 5 | 45133-05 | 6,0 mm |

POLTZER
 45150-18
 18 cm, 7"

POLTZER
 45151-16
 16,5 cm, 6 1/2"

LUCAE
 45152-01
 18 cm, 7"

LUCAE
 45152-02
 18 cm, 7"

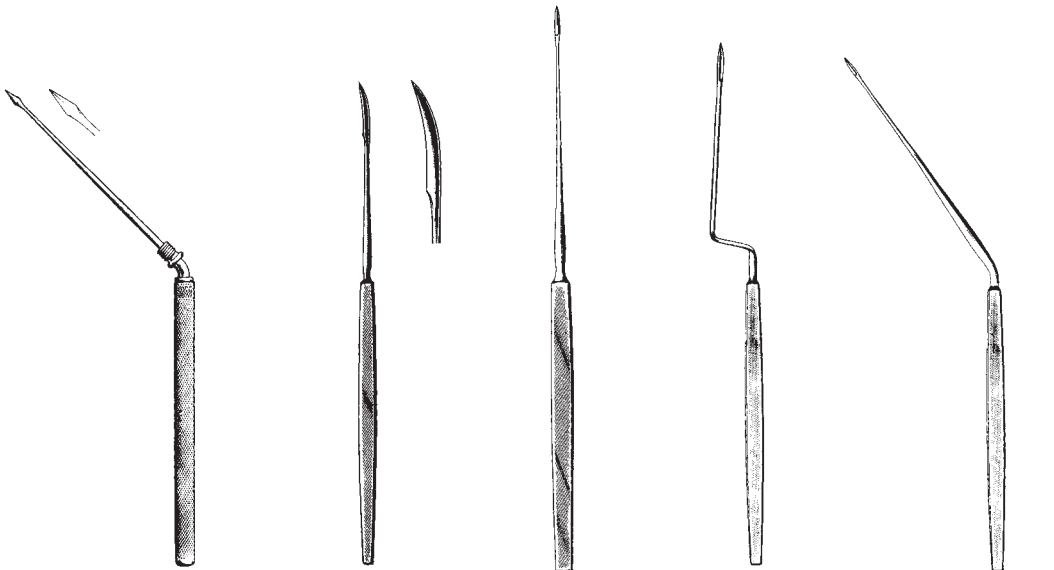

POLTZER
 45153-16
 16 cm, 6 1/2"

POLTZER
 45160-15
 15 cm, 6"

SEXTON
 45162-18
 18 cm, 7"

SEXTON
 45164-17
 17 cm, 6 3/4"

SEXTON
 45165-17
 17 cm, 6 3/4"

Löffel, Schlingen, Häkchen
 Ear spoons, Loops, Hooklets
 Cucharas, Asas, Ganchitos
 Cucchiai, Anse, Uncinetti

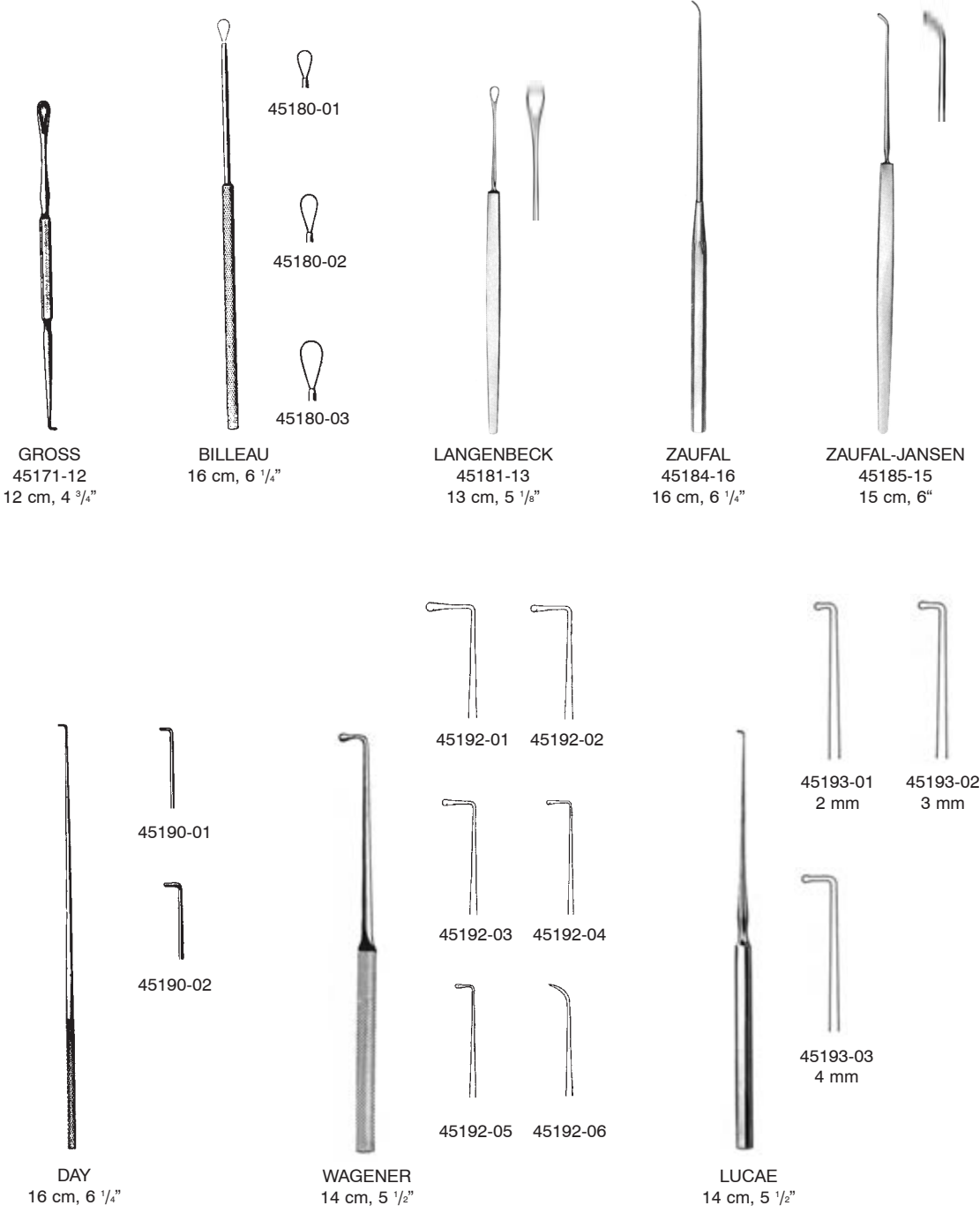

GROSS
 45171-12
 12 cm, 4 3/4"

BILLEAU
 16 cm, 6 1/4"

LANGENBECK
 45181-13
 13 cm, 5 1/8"

ZAUFAL
 45184-16
 16 cm, 6 1/4"

ZAUFAL-JANSEN
 45185-15
 15 cm, 6"

45180-01

45180-02

45180-03

45190-01

45190-02

45192-01

45192-02

45192-03

45192-04

45192-05

45192-06

45193-01
 2 mm

45193-02
 3 mm

45193-03
 4 mm

DAY
 16 cm, 6 1/4"

WAGENER
 14 cm, 5 1/2"

LUCAE
 14 cm, 5 1/2"

Schlingen, Pinzetten
 Loops, Dressing Forceps
 Asas, Pinzas
 Anse, Pinze



SHAPLEIGH
 13 cm, 5 1/8"

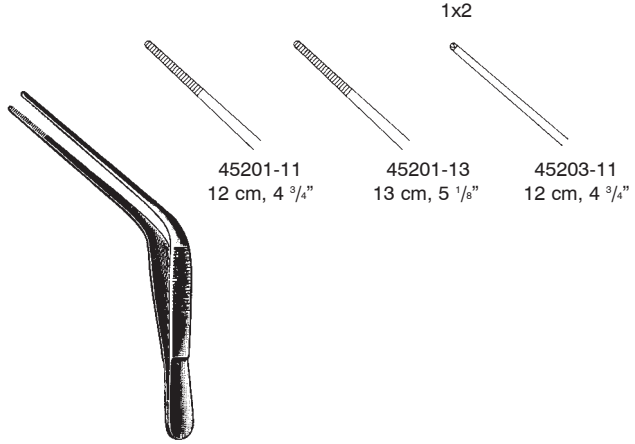

WILDE (TROELTSCH)



LUCAE
 45206-14
 14 cm, 5 1/2"



LUCAE
 16 cm, 6 1/4"



COTTLE
 45208-14
 14 cm, 5 1/2"

Polypenschnürer, Ohrzängchen
Snares, Ear Forceps
Cierra-nudos, Pinzas auriculares
Serranodi, Pinze auricolari



KRAUSE
45220-16
16 cm, 6 1/4"



WILDE
45222-17
17 cm, 6 3/4"



45225-02
doz./doc./dozz.
0,2 mm

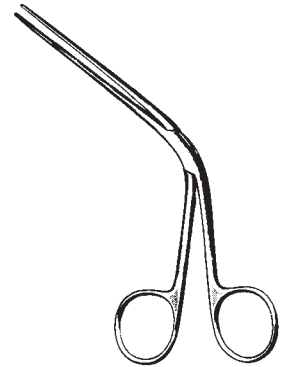

TILLEY
45243-14
14 cm, 5 1/2"



LITTAUER
45245-12
12 cm, 4 3/4"

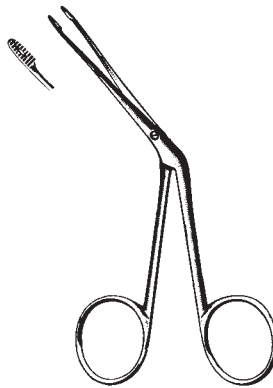

HARTMANN
45246-12
12 cm, 4 3/4"

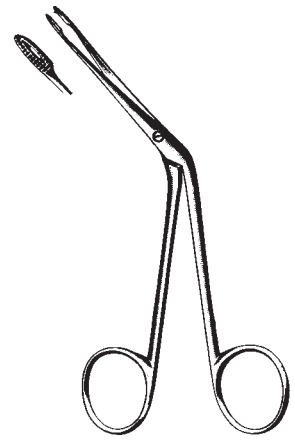

HARTMANN
45246-14
14 cm, 5 1/2"

Fremdkörperheber, Fremdkörperzängchen
 Foreign Body Levers, Ear Polypus Forceps
 Elevadores para cuerpos extraños, Pinzas para pólipos
 Leve per corpi estranei, Pinze per polipi



QUIRE
 45251-10
 10 cm, 4"

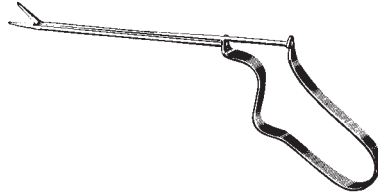

BUCK
 45253-11
 11 cm, 4 3/8"

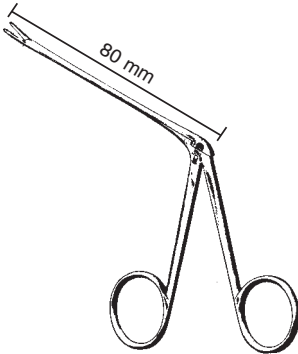

45255-08 - 45275-08



HARTMANN-WULLSTEIN
 45255-08
 8,5 cm, 3.4"

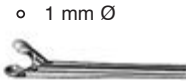

o 1 mm Ø
 HARTMANN-WULLSTEIN
 45257-08
 8,5 cm, 3.4"



HARTMANN
 45261-08 8,5 cm, 3.4"
 45261-14 14,0 cm, 5 1/2"
 45261-16 16,0 cm, 6 1/4"



HARTMANN
 45263-08 8,5 cm, 3.4"
 45263-14 14,0 cm, 5 1/2"



HARTMANN
 45265-08
 8,5 cm, 3.4"



Ø mm HARTMANN
 2,0 45267-20 8,5 cm, 3.4"
 2,5 45267-25 8,5 cm, 3.4"
 3,0 45267-30 8,5 cm, 3.4"



○ 3 mm Ø
 HARTMANN
 45269-30
 8,5 cm, 3.4"



STRUEMPEL
 45271-08 8,5 cm, 3.4"
 2,5x5 mm



HARTMANN
 45273-08
 8,5 cm, 3.4"



○ 2 mm Ø
 HARTMANN-HOFFMANN
 45275-08
 8,5 cm, 3.4"

Mikro-Ohrscheren, Mikro-Ohrzangchen
 Micro Ear Scissors, Micro Ear Forceps
 Tijeras auriculares micro, Pinzas auriculares micro
 Forbici auricolari micro, Pinze auricolari micro

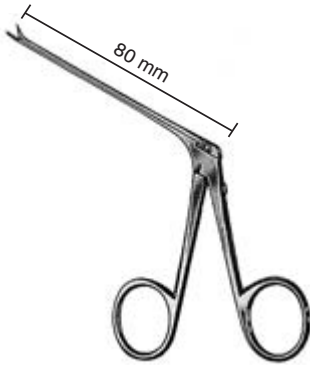

45310-40 - 45322-70



A
 BELLUCCI
 45310-40
 micro mini
 4 mm



A
 BELLUCCI
 45312-55
 micro standard
 5,5 mm



D
 BELLUCCI
 45313-55
 micro standard
 5,5 mm



B
 BELLUCCI
 45315-55
 micro standard
 5,5 mm



C
 BELLUCCI
 45317-55
 micro standard
 5,5 mm



A
 SHEA
 45320-70
 7,0 mm



C
 SHEA
 45321-70
 7,0 mm



B
 SHEA
 45322-70
 7,0 mm

- A:** gerade / straight / recta / retta
- B:** rechts / right / derecha / destra
- C:** links / left / izquierda / sinistra
- D:** aufgebogen / curved up / curva in alto / curva hacia arriba
- E:** nach unten gebogen / curved down / curva in basso / curva hacia abajo



45350-40 - 45360-35



A
 45350-40
 4 mm



A
 45350-70
 7 mm



A
 45352-40
 4 mm



C
 45353-60
 6 mm



B
 45355-60
 6 mm



D
 45357-40
 4 mm



E
 45359-40
 4 mm



A
 45360-35
 3,5 mm

Mikro-Ohrzängchen, Hammerkopfstanze

Micro Ear Forceps, Malleus punch

Pinzas auriculares micro, Pinza saca-bocadas para cabeza de martillo

Pinze auricolari micro, Pinze taglianti per testa del martelletto taglio a scalpello

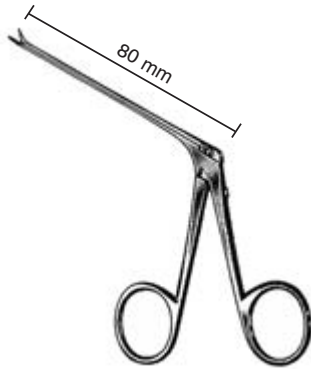

45362-45 - 45383-30



A
45362-45
4,5 mm



C
45363-45
4,5 mm



B
45365-45
4,5 mm

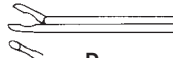

D
45367-50
5,0 mm



E
45369-50
5,0 mm

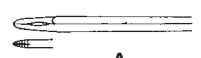

A
GREVEN
45370-50
5,0 mm



McGEE
45371-40
0,8x4,0 mm



COS
45373-30
1,8x0,8x3,0 mm



JUERS
45375-60
6,0 mm

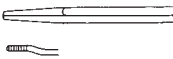

JUERS
45377-60
6,0 mm



C
HAUGH
45381-30
45° 3 mm



B
HAUGH
45383-30
45° 3 mm

A: gerade / straight / recta / retta

B: rechts / right / derecha / destra

C: links / left / izquierda / sinistra

D: aufgebogen / curved up / curva in alto / curva hacia arriba

E: nach unten gebogen / curved down / curva in basso / curva hacia abajo

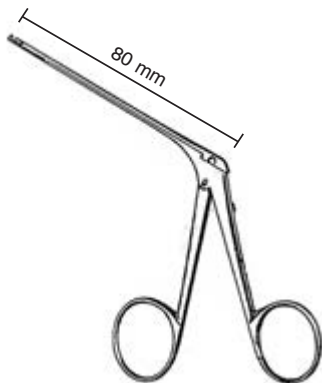

DIETER
45385-01 - 45387-02

micro ø 1,3 mm

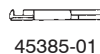

45385-01

aufwärts
upward
arriba
in alto

mini ø 1,8 mm

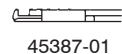

45387-01

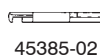

45385-02

abwärts
downward
abajo
in basso

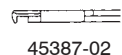

45387-02

Mikro-Ohrzängchen
Micro Ear Forceps
Pinzas auriculares micro
Pinze auricolari micro



45390-35
0,8 x 3,5 mm



45390-50
1 x 5 mm



45391-35
0,8 x 3,5 mm



45392-35
0,8 x 3,5 mm



45393-50
1 x 5 mm



45394-50
1 x 5 mm

Mikro-Ohrzängchen
 Micro Ear Forceps
 Pinzas auriculares micro
 Pinze auricolari micro



WULLSTEIN



45400-01
 0,9 x 1 mm



45400-02
 0,8 x 1,3 mm



45400-03
 1 mm



45401-25
 1,7 x 2,5 mm



45402-10
 0,9 x 1 mm



45403-13
 0,8 x 1,3 mm



45404-13
 0,8 x 1,3 mm

Mikro-Ohrscheren
Micro Ear Scissors
Tijeras auriculares micro
Forbici auricolari micro



WULLSTEIN



45410-01



45411-01



45412-01



45413-01



45414-01

Messer
Knives
Cuchillos
Coltelli



SCHUKNECHT
45701-01
16 cm, 6 1/4"



SCHUKNECHT
45701-02
16 cm, 6 1/4"



SCHUKNECHT
45703-15
15,5 cm, 6"



WULLSTEIN
45704-15
15,5 cm, 6"



TABB
45705-15
15,5 cm, 6"



PLESTER
45706-35
15,5 cm, 6"



45709-10
Ø 1,0 mm



45709-14
Ø 1,4 mm



45709-16
Ø 1,6 mm



45709-20
Ø 2,0 mm



45709-26
Ø 2,6 mm



45709-28
Ø 2,8 mm



45709-30
Ø 3,0 mm



ROSEN
45709-10 - 45709-30
16 cm, 6 1/4"

Nadeln und Häkchen
 Needles and Hooks
 Aguja y Ganchos
 Aghi e uncini



16 cm
 6 1/4"



BARBARA
 45710-15



BARBARA
 45711-15



BARBARA
 45713-15



BARBARA
 45715-17



25°
 SHAMBAUGH



45°
 SHAMBAUGH



90°
 SHAMBAUGH



BARBARA
 45725-05=0,5 mm
 45725-10=1,0 mm

mm
 0,3
 0,6
 1,0
 1,2
 1,5
 2,0
 2,5

45720-03
 45720-06
 45720-10

45722-03
 45722-06
 45722-10
 45722-12
 45722-15
 45722-20
 45722-25

45724-03
 45724-06
 45724-10
 45724-12
 45724-15
 45724-20
 45724-25



45730-03 - 45747-10
 15,5 cm, 6"



mm
 0,3
 0,6
 1,0

90°
 45730-03
 45730-06
 45730-10



90°
 45732-03
 45732-06
 45732-10



mm
 0,5
 1,0

McGEE
 45733-05
 45733-10



McGEE
 45735-05
 45735-10



BARBARA
 45736-15
 15,5 cm, 6"



ROSEN

45737-15
 15,5 cm, 6"



mm

0,3
 0,6
 1,0

25°
 45741-03
 45741-06
 45741-10



25°
 45743-03
 45743-06
 45743-10



45°
 45745-03
 45745-06
 45745-10



45°
 45747-03
 45747-06
 45747-10

Dissektoren, Küretten, Elevatoren, Mikro-Meßsonde
 Dissectors, Curettes, Elevators, Micro measuring rod
 Disectores, Curetas, Elevadores, Sonda para medir
 Dissettori, Curette, Elevatori, Sonda auricolare per misurare

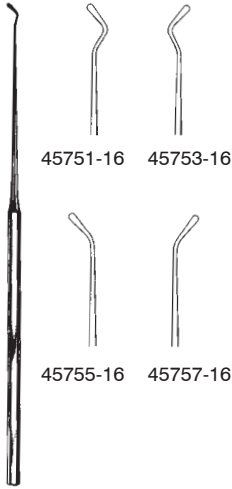

45751-16 45753-16
 45755-16 45757-16

FISCH
 45751-16 - 45757-16
 16 cm, 6 1/4"

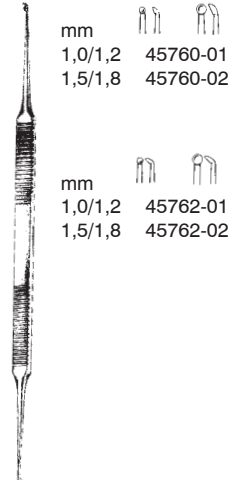

mm
 1,0/1,2 45760-01
 1,5/1,8 45760-02
 mm
 1,0/1,2 45762-01
 1,5/1,8 45762-02

HOUSE
 45760-01 - 45762-02
 15 cm, 6"

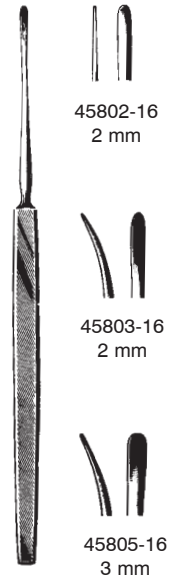

45802-16
 2 mm
 45803-16
 2 mm
 45805-16
 3 mm
 LEMPERT
 45802-16 - 45805-16
 16 cm, 6 1/4"

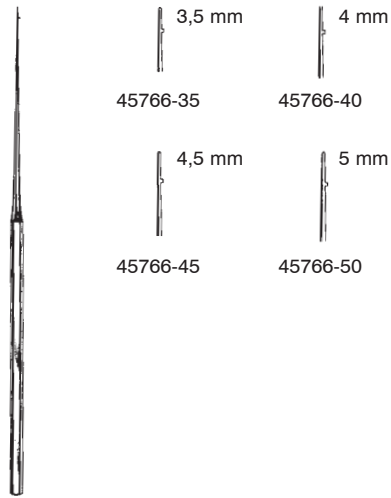

3,5 mm 4 mm
 45766-35 45766-40
 4,5 mm 5 mm
 45766-45 45766-50

HOUSE
 45766-35 - 45766-50
 16 cm, 6 1/4"



6 mm
 LEMPERT
 45807-20
 20,5 cm, 8"

Nasenspekula
Nasal Specula
Espéculos nasales
Specoli nasali



THUDICHUM
47050-01 - 47050-07

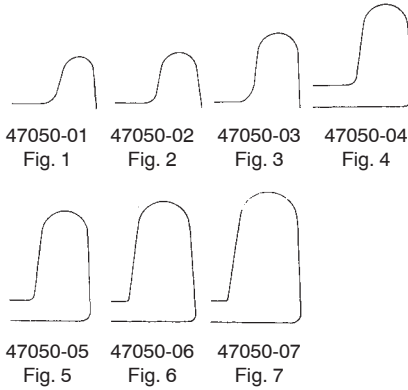

VOLTOLINI
47060-01 - 47060-03

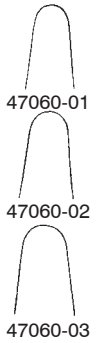

HARTMANN-HALLE
47102-01 - 47102-03
15 cm, 6"

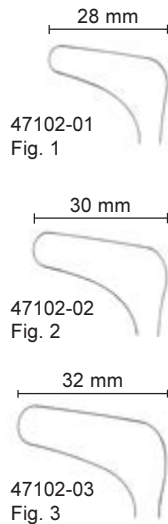

leichtes Modell
lightweight
mod. ligero
mod. leggero

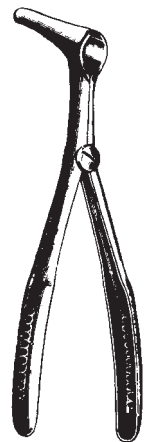
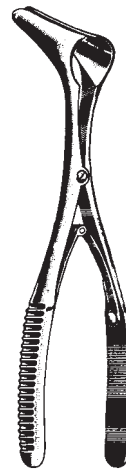

	Mod. WIEN	
Baby, bébé	47112-01	25 mm
Kind, child, niño, bamb.	47112-02	30 mm
Erwachs., Adult, adulto	47112-03	35 mm

Mod. WIEN
47113-03

Nasenspekula
Nasal Specula
Espéculos nasales
Specoli nasali



HARTMANN
16 cm, 6 1/4"

30 mm

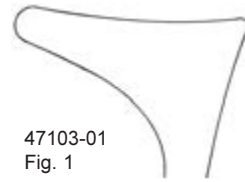

47103-01
Fig. 1

33 mm

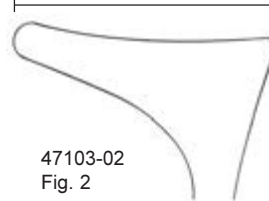

47103-02
Fig. 2

35 mm

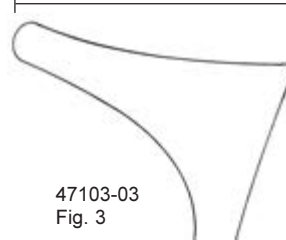

47103-03
Fig. 3

Nasenspekula, Kehlkopfspiegel
 Nasal Specula, Laryngeal Mirrors
 Espéculos nasales, espejos laríngeos
 Specoli nasali, Specchi laringei

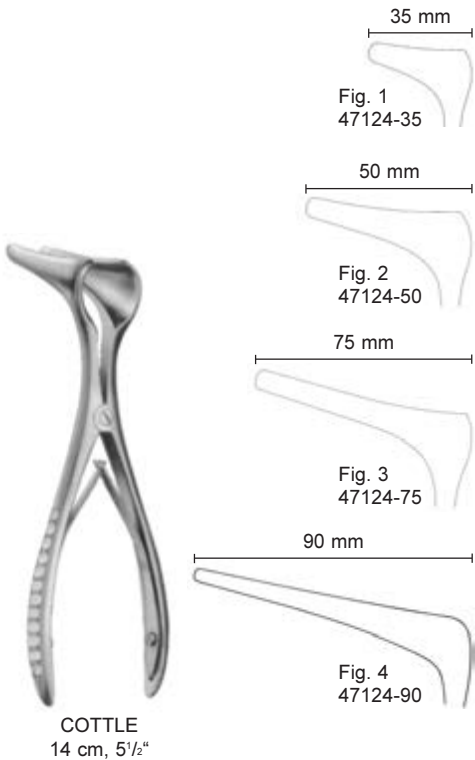
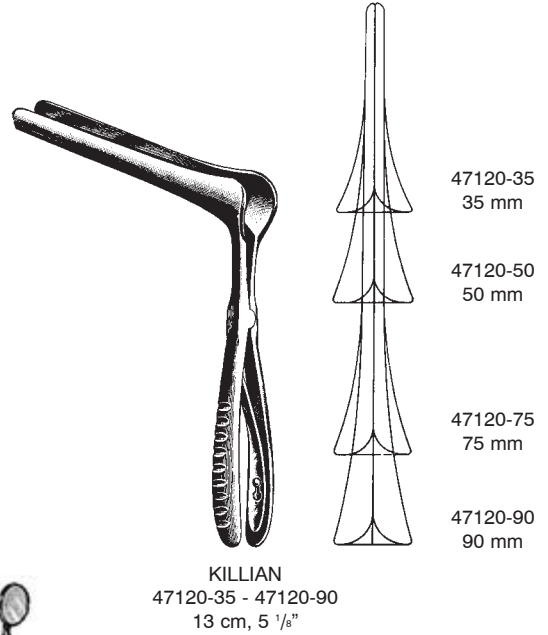
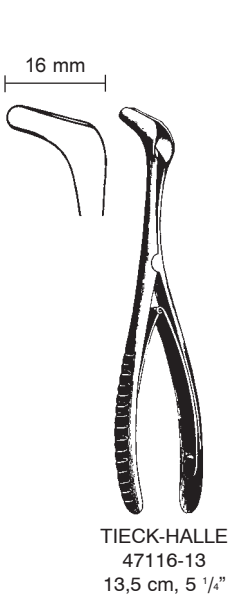

Nasenpinzetten, Polypenzange
 Ear Dressing Forceps, Ear Polypus Forceps
 Pinzas auriculares, Pinzas para pólipos
 Pinze auricolari, Pinze per polipi

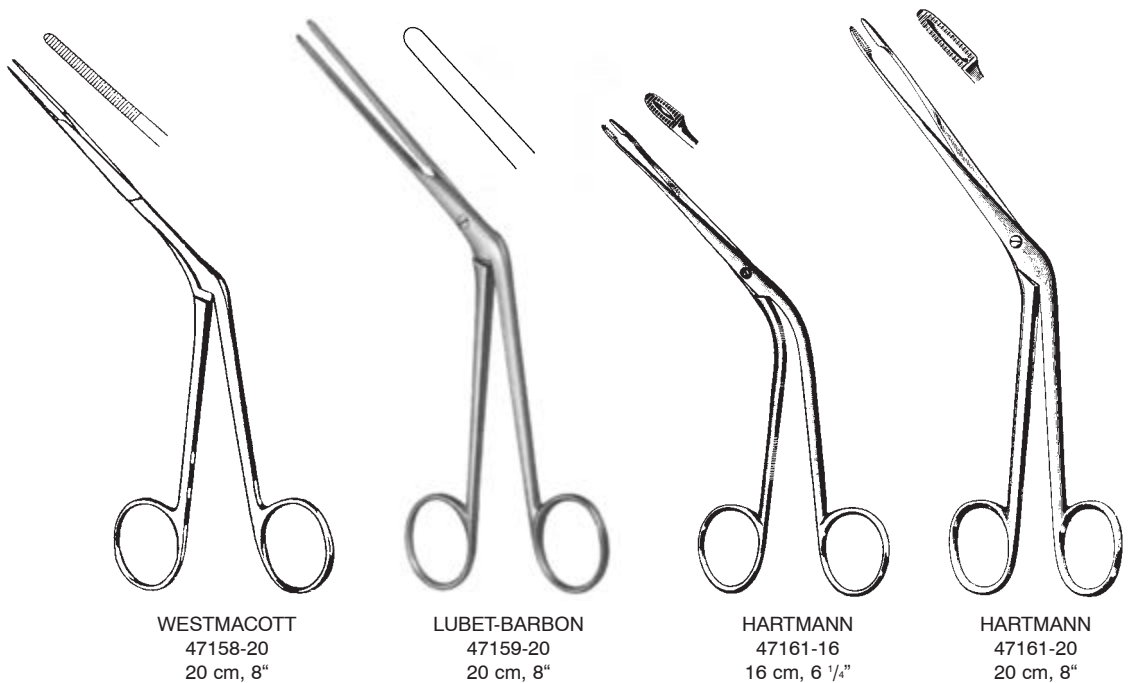
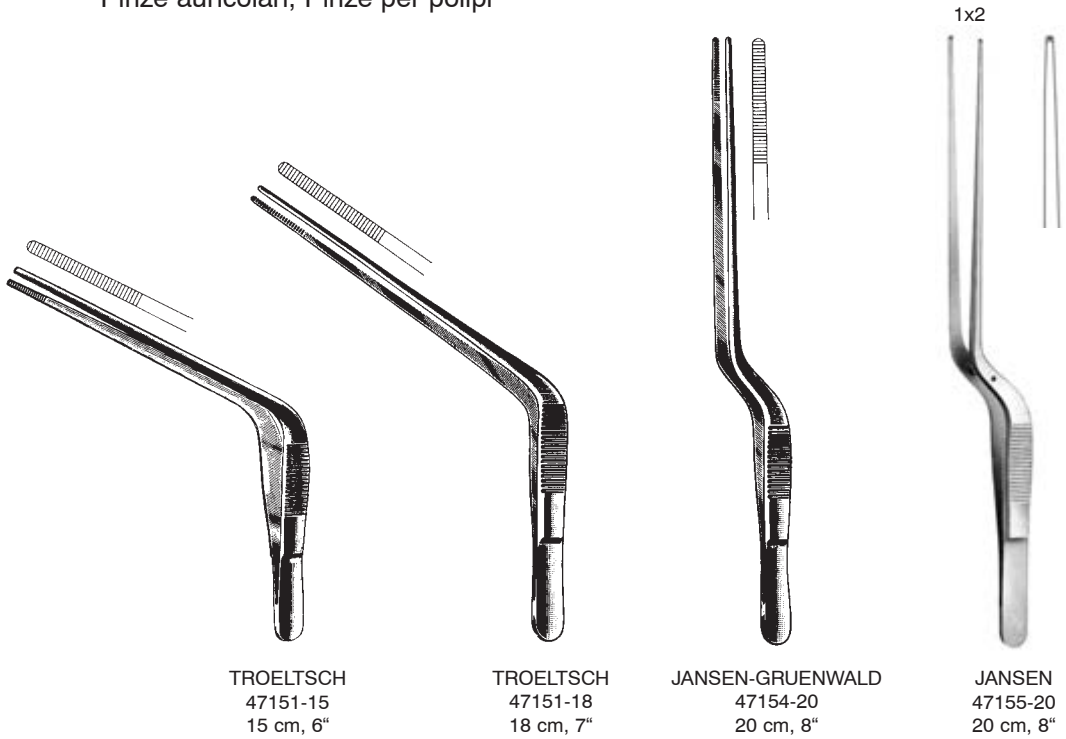

Polypenzangen, Septumzangen
 Nasal Polypus and Septum Forceps
 Pinzas para pólipos y para el tabique nasal
 Pinze per polipi, Pinze per il setto nasale

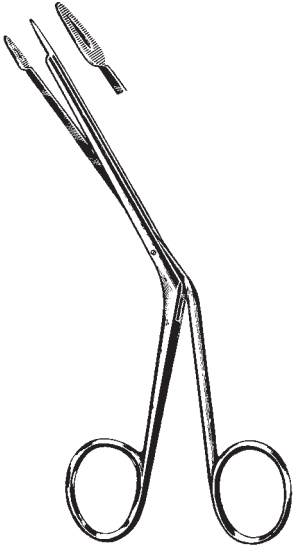

LITTAUER
 47167-18
 18 cm, 7"



HEYMANN-KNIGHT
 47169-18
 18 cm, 7"

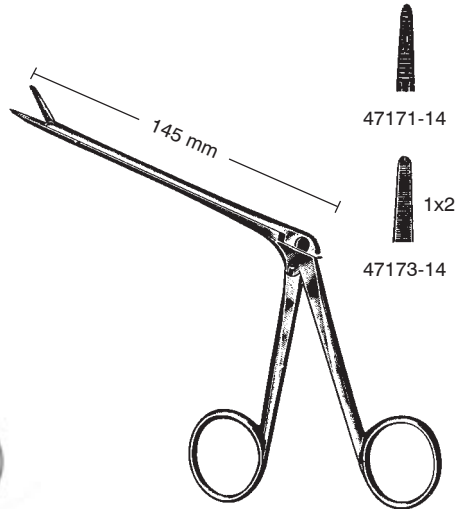

NOYES
 47171-14 - 47173-14
 14,5 cm, 5 3/4"

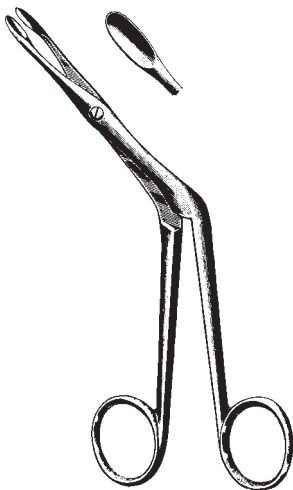

HEYMANN
 47181-18
 18 cm, 7"



KNIGHT
 47185-18
 18 cm, 7"



BRUENINGS
 47191-01 - 47191-04
 19 cm, 7 1/2"

Scharfe Nasenzangen, Septumzangen
 Nasal Cutting Forceps, Septum Forceps
 Pinzas cortantes nasales y para el tabique nasal
 Pinze taglienti nasali, Pinze per il setto nasale



GRAIG
 47192-16
 18 cm, 7"

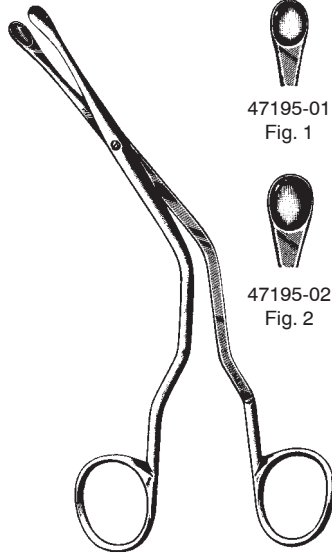

LUC
 47195-01 - 47195-05
 19 cm, 7 1/2"

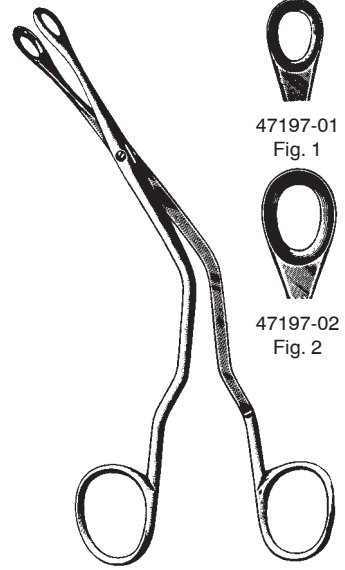

LUC
 47197-01 - 47197-02
 19 cm, 7 1/2"

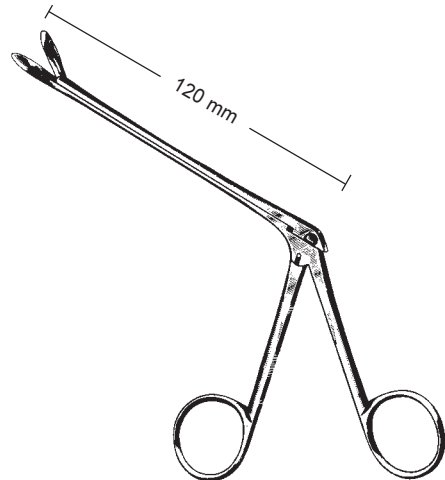
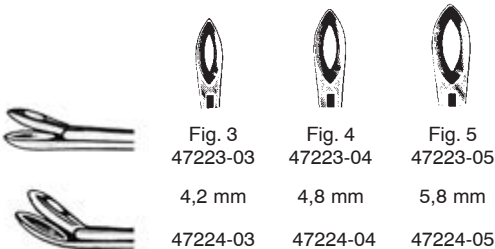
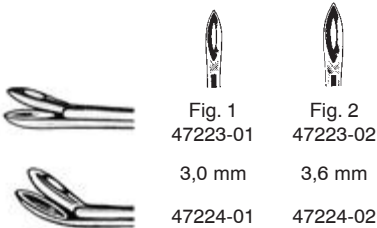

WEIL-BLAKESLEY
 47223-01 - 47224-05

Scharfe Nasenzangen
 Nasal Cutting Forceps
 Pinzas cortantes nasales
 Pinze taglianti nasali

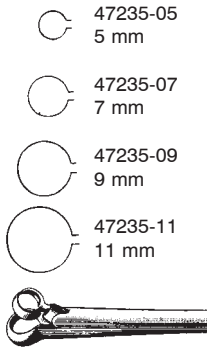

HARTMANN

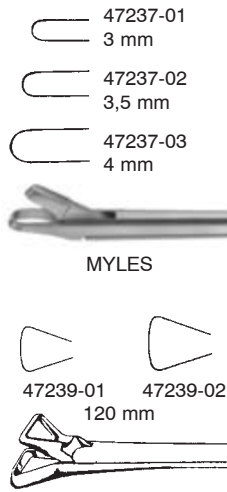

MYLES

SCHMEDEN

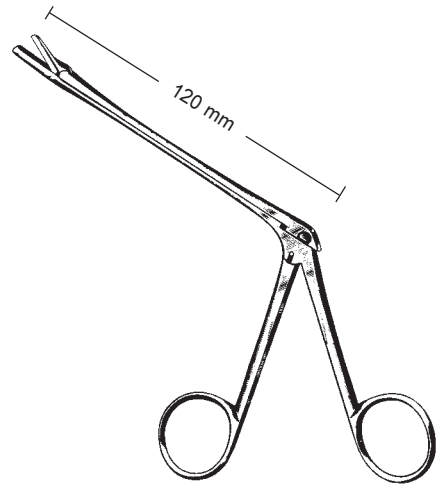

STRUYCKEN
47240-19

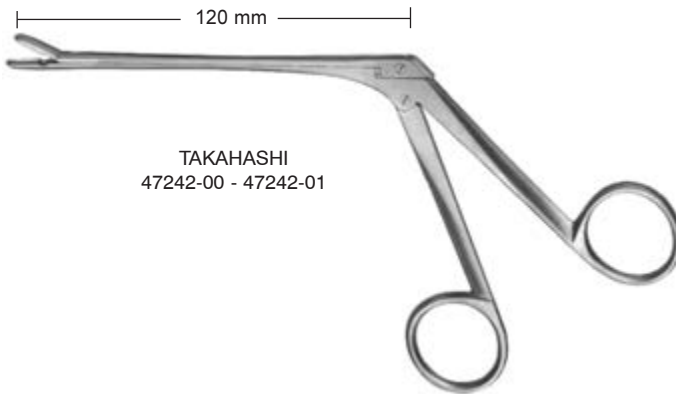

TAKAHASHI
47242-00 - 47242-01

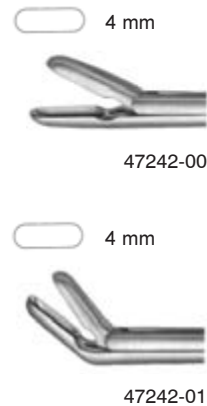

47242-01

Scharfe Nasenzangen, Septumzange, Kieferhöhlenstanze
 Nasal Cutting Forceps, Septum Forceps, Antrum Punch Forceps
 Pinzas cortantes nasales, Pinza para magullar tabique, Pinzas cortantes para maxilares
 Pinze taglianti nasali, Pinza per ammaccare il setto, Pinze taglianti per seno mascellare



RUBIN
 47251-21
 21 cm, 8 1/4"

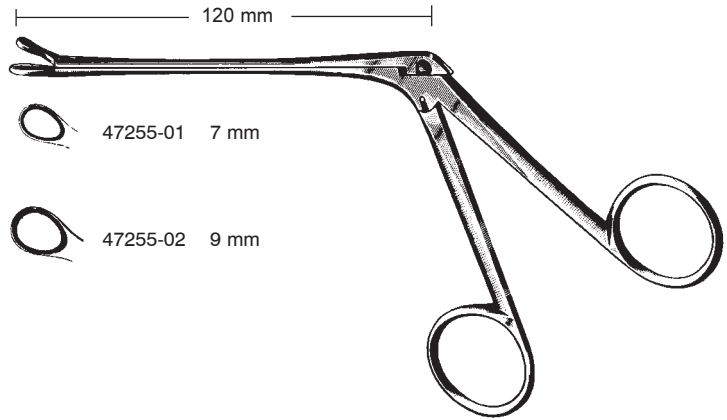

WATSON-WILLIAMS
 47255-01



CAPLAN
 47256-20
 20 cm, 8"



KERRISON
 3x3 mm 47303-03
 4x4 mm 47303-04
 5x5 mm 47303-05
 6x6 mm 47303-06
 17 cm, 6 3/4"

Kieferhöhlenstanze, Nasenschere
 Antrum Punch Forceps, nasal scissors
 Pinzas cortantes para maxilares, tijera nasal
 Pinze sfenoidali, forbici nasali



47304-01 5x3,5 mm

47304-03 5x4 mm



47304-02 5x3,5 mm

47304-04 5x4 mm



HAJEK-KOFLER
 47304-01 - 47304-04

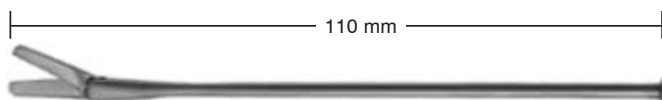

47305-02
 rechts gebogen
 right curved
 curva a la derecha
 curva a destra



47305-03
 links gebogen
 left curved
 curva a la izquierda
 curva a sinistra



47305-01
 gerade
 straight
 recta
 retta

Knochenstanze, Septumzangen

Punches, Septum Forceps

Pinzas osteótomos, Pinzas para el tabique nasal

Pinze osteotomi, Pinze per il setto nasale

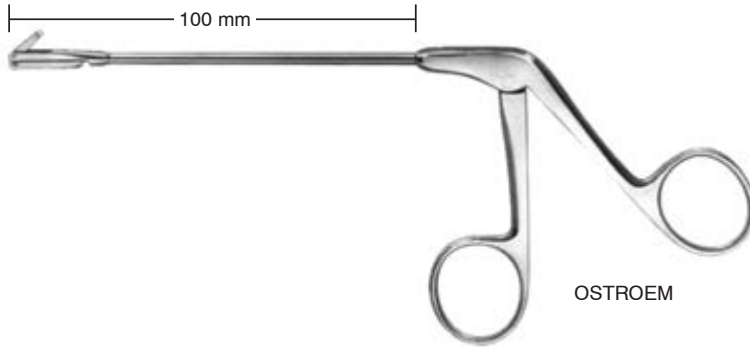

47315-00
2 mm
oben schneidend
up cutting
cortante por arriba
tagliente in alto



47316-00
2 mm
rechts schneidend
right cutting
cortante a la derecha
tagliente a destra



47317-00
2 mm
links schneidend
left cutting
cortante a la izquierda
tagliente a sinistra



CITELLI
47311-10 1,0 mm
47311-25 2,5 mm
47311-30 3,0 mm



MIDDLETON-JANSEN
47323-19
19 cm, 7 1/2"



MIDDLETON-JANSEN
47325-19
19 cm, 7 1/2"

Kieferhöhlenstanze, Sinuskopie-Zangen
 Antrum Punch Forceps, Sinuscopy forceps
 Pinzas cortantes para maxilares, Pinzas para senoscopia
 Pinze sfenoidali per seno mascellare, Pinze per sinuscopia



HAJEK-KOFLER
 47316-16
 3,5 mm

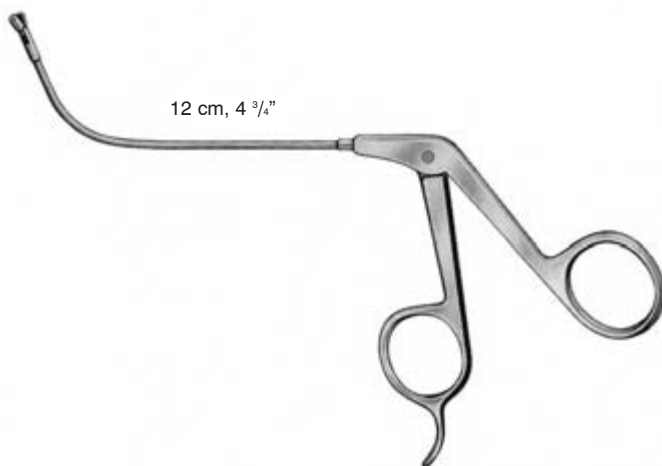

12 cm, 4 3/4"

Maul		horizontal öffnend	vertikal öffnend
jaw		horizontal cutting	vertical cutting
boca		abierta horizontal	abierta vertical
morso		apertura orizzontale	apertura verticale
65°	○ 3 mm rund	47317-65	47318-65
70°	◌	47317-70	47318-70
90°	◌ } oval	47317-90	47318-90
110°	◌	47317-11	47318-11

Zirkular Stanze
Circular Forceps
Pinza circular
Pinza circolare



47319-35 3,5 mm
47319-45 4,5 mm

Spülkanülen, Stirnhöhlendilatator
 cannulas, Frontal sinus bougies
 cánulas, Dilatador para el seno
 cannulas, Dilatatore per seno frontale

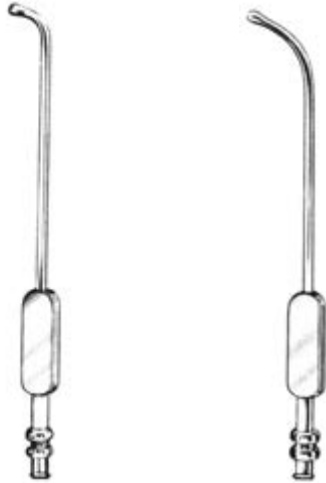

EICKEN (KILLIAN)
 14,5 cm, 5 ³/₄"
 Ø

47331-20	2,0 mm	47332-20
47331-25	2,5 mm	47332-25
47331-30	3,0 mm	47332-30
47331-40	4,0 mm	47332-40



Ø mm RITTER-HALLE
 2,5 47342-25
 3,0 47342-30
 4,0 47342-40

Kiefer- und Stirnhöhlen-Spülkanülen, Saugraspatorium
Antrum and Frontal Sinus Wash Cannulas, Suction Raspatory
Cànulas lavadoras para seno maxilar y seno frontal, Legra de succión
Cannule per seno mascellare e seno frontale, Raspatorio con aspiratore



KILLIAN
Ø 1,5 mm
47345-15



GUILEN
19 cm, 7 1/2"
47347-20

Polypenschnürer
Nasal Polypus Snares
Polipótomos
Serranodi



KRAUSE-VOSS
47350-26
26 cm, 10 1/4"



KRAUSE
47351-26
26 cm, 10 1/4"

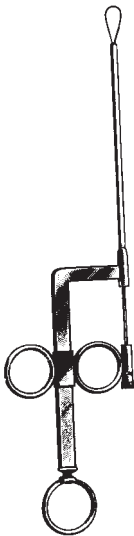

WILDE
47352-24
24 cm, 9 1/2"



Bündel mit 12 Stück
Bundle with 12 pieces
12 piezas atados
confezione di 12 pezzi

47355-03 0,3 mm

Nasenmesser
Nasal Knives
Bisturies nasales
Coltelli nasali



JOSEPH
47370-16 - 47373-16
16 cm, 6 1/4"



47370-16 47371-16
stumpf, blunt,
romos, smussi



47372-16 47373-16
spitz, pointed,
agudos, acuti



FREER
47374-16
16,5 cm, 6 1/2"



FREER
47375-19
19 cm, 7 1/2"



JOSEPH
47375-16
16,5 cm, 6 1/2"

Nasenplastik- und Operationsmesser, Sichelmesser, Küretten
 Rhinoplastic and Nasal Knives, Septum Sickle Knives, Curettes
 Bisturries para plastica y operaciones de la nariz, Bisturries para el tabique nasal, Curetas
 Bisturi per la plastica ed operazioni nasali, coltelli per setto, Curette

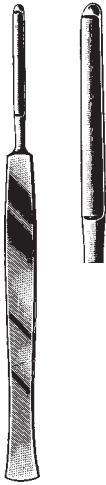

JOSEPH
47376-16
16 cm, 6 1/4"

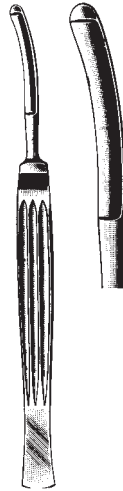

CONVERSE
47379-16
16 cm, 6 1/4"



COTTLE
47380-15
15 cm, 6"



COTTLE
47382-15
15 cm, 6"



JOSEPH
47384-15
15 cm, 6"



JOSEPH
47385-15
15 cm, 6"



REDA
19 cm, 7 1/2"



47386-01
spitz
pointed
agudo
acuto



47386-02
stumpf
blunt
romo
smusso



ANTRUM
19 cm, 7 1/2"



47387-01
vorwärts schneidend
forward cutting
corte hacia adelante
taglio in avanti



47387-02
rückwärts schneidend
backward cutting
corte hacia atras
taglio retrograde

Schwingmesser
 Septum Swivel Knives
 Bisturies para el tabique nasal
 Coltelli per setto



BALLENGER
 47390-03 - 47392-05
 20 cm, 8"



47390-03
 3 mm



47390-04
 4 mm



47390-05
 5 mm



47392-03
 3 mm



47392-04
 4 mm



47392-05
 5 mm

Septum Elevatoren
 Septum Elevators
 Elevadores para el tabique
 Elevatori per setto

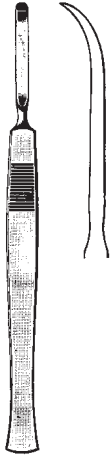

McKENTY
 47410-04 - 47410-05
 15 cm, 6"



47410-04
 4 mm

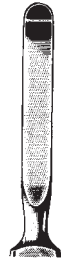

47410-05
 5 mm



HALLE
 47410-16
 16.5 cm, 6 1/2"



JOSEPH
 47411-16
 16 cm, 6 1/4"

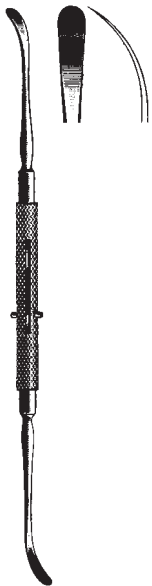

ROGER
 47413-19
 19 cm, 7 1/2"



MASING
 47414-21
 22 cm, 8 3/4"



FREER
 47415-18
 18 cm, 7"



FREER
 47417-19
 19 cm, 7 1/2"

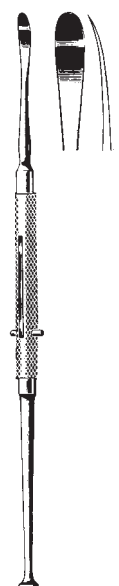

FREER
 47419-19
 19 cm, 7 1/2"

Septum Elevatoren
 Septum Elevators
 Elevadores para el tabique
 Elevatori per setto



KILLIAN
 47420-01
 18,5 cm, 7 1/4"



PIERCE
 47420-02
 21 cm, 8 1/4"



SINUS
 47420-03
 18 cm, 7"



PENNINGTON
 47420-04
 21 cm, 8 1/4"



McKENTY
 47420-20
 22 cm, 8 3/4"



HOWARTH
 47421-21
 21,5 cm, 8 1/2"

Septum Elevatoren
 Septum Elevators
 Elevadores para el tabique
 Elevatori per setto



COTTLE
 47421-23
 23 cm, 9"



COTTLE JOSEPH
 47422-22
 22 cm, 8 3/4"



COTTLE
 47423-22
 22 cm, 8 3/4"

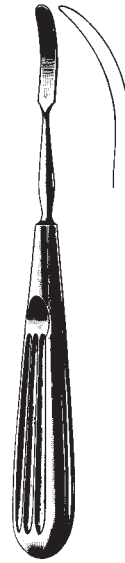

COTTLE
 47424-16
 16 cm, 6 1/4"



COTTLE
 47425-19
 19 cm, 7 1/2"



KILLIAN
 47426-22
 22 cm, 8 3/4"



HAJEK-BALLENGER
 47428-21
 22 cm, 8 3/4"



BALLENGER
 47430-22
 22 cm, 8 3/4"



FREER
 47450-04
 15 cm, 6"



FREER
 47451-04
 15 cm, 6"

Osteotome, Knorpelquetscher
 Osteotomes, Cartilage crusher
 Osteótomos, Macha cadera
 Osteotomi, Tritacartilagine

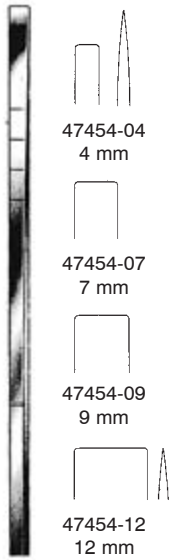

COTTLE
 47454-04 - 47454-12
 18 cm, 7"



COTTLE
 47455-06
 18 cm, 7"

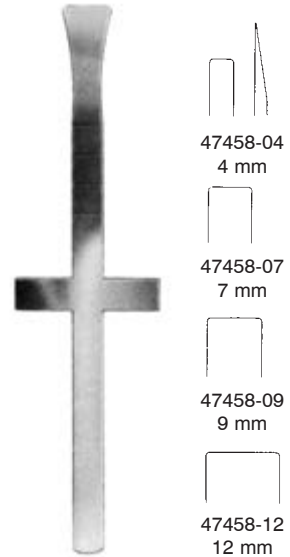

COTTLE
 47458-04 - 47458-12
 18 cm, 7"

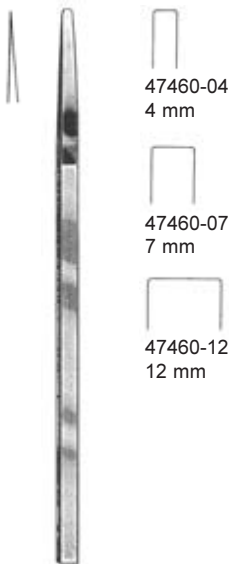

COTTLE
 18 cm, 7"

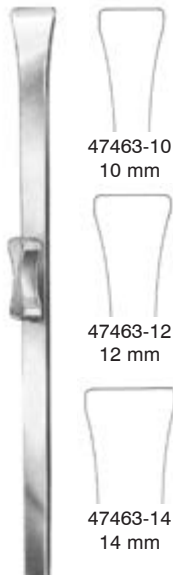

RUBIN
 18,5 cm, 7 1/4"



COTTLE
 Knorpelquetscher
 47461-00

Osteotome, Septum Meißel
 Osteotomes, Rhinoplastic Chisels
 Osteótomos, Cinceles para la plàstica nasal
 Osteotomi, Scalpelli per plastica nasale



FOMON
 47470-04 - 47470-07
 17 cm, 6 3/4"

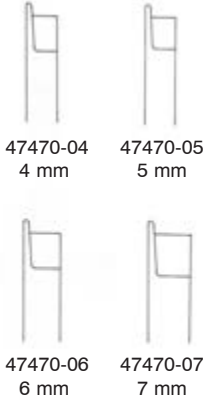

47470-04
 4 mm

47470-05
 5 mm

47470-06
 6 mm

47470-07
 7 mm



SHEEHAN
 47471-07 - 47471-12
 16 cm, 6 3/4"

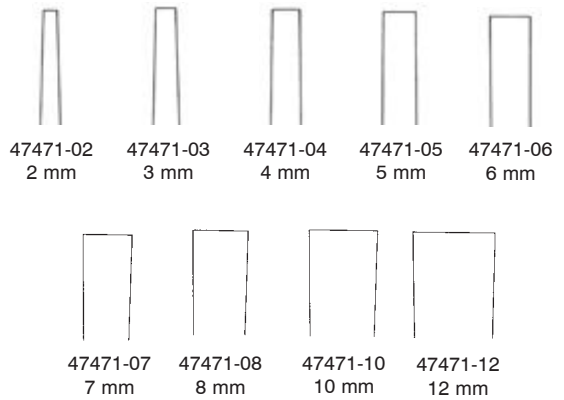

47471-02
 2 mm

47471-03
 3 mm

47471-04
 4 mm

47471-05
 5 mm

47471-06
 6 mm

47471-07
 7 mm

47471-08
 8 mm

47471-10
 10 mm

47471-12
 12 mm



CINELLI
 47472-10 - 47472-16
 16 cm, 6 1/4"

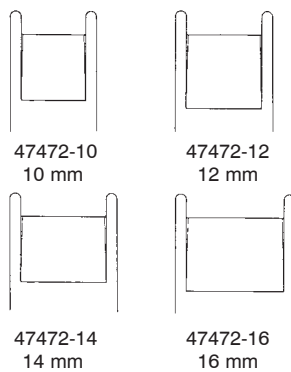

47472-10
 10 mm

47472-12
 12 mm

47472-14
 14 mm

47472-16
 16 mm

Septum Meißel, Osteotom
 Rhinoplastic Chisels, Osteotom
 Cinceles para la plástica nasal, Osteotóm
 Scalpelli per plastica nasale, Osteotom

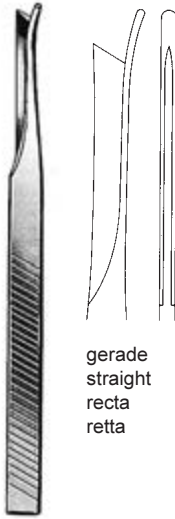

gerade
 straight
 recta
 retta

SILVER
 47473-01
 18 cm, 7"

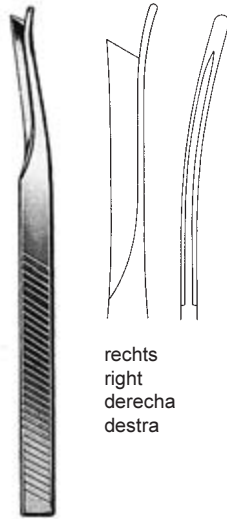

rechts
 right
 derecha
 destra

SILVER
 47473-02
 18 cm, 7"

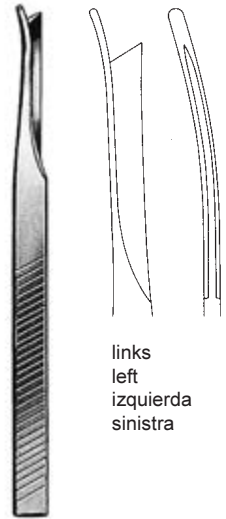

links
 left
 izquierda
 sinistra

SILVER
 47473-03
 18 cm, 7"



47474-01
 rechts
 right
 derecha
 destra

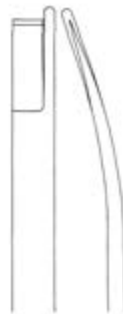

47474-02
 links
 left
 izquierda
 sinistra



47474-03
 gerade
 straight
 recta
 retta

NEIVERT-ANDERSON
 47474-01 - 47474-03
 20,5 cm, 8" 7 mm

Septum-Hohlmeißel, Osteotom
 Septum Gouges, Osteotom
 Gubias para tabique nasal, Osteótom
 Sgorbie per il setto nasale, Osteotom



KILLIAN
 47481-05
 16 cm, 6 1/4"



KILLIAN-CLAUS
 47482-05
 17 cm, 6 3/4"



mm	HAJEK
4	47484-04
6	47484-06
8	47484-08
	16 cm, 6 1/4"



WEST
 47486-16
 16 cm, 6 1/4"



WEST
 47487-16
 16 cm, 6 1/4"

6 mm



FREER
 47489-16
 16 cm, 6 1/4"



Knochenfeile, Nasenraspeln
 Bone File, Nasal Rasps
 Limas para hueso, Escofinas nasales
 Lime per ossa, Raspa nasale



JOSEPH
 47502-16
 16 cm, 6 1/4"



MALTZ
 47504-18
 18 cm, 7"



WIENER
 47507-17 - 47507-19
 18 cm, 7"

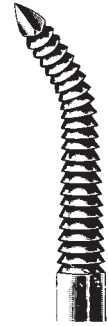

47507-17



47507-19

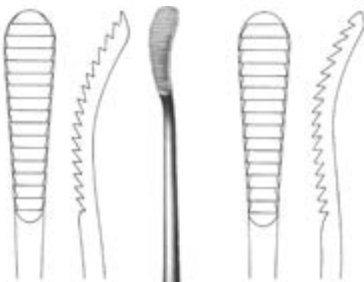

AUFRICHT
 47511-21 21 cm, 8 1/4" 47513-21

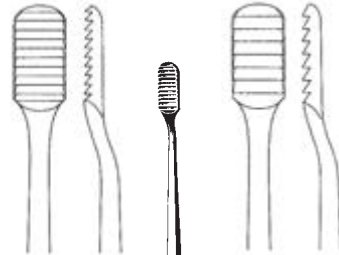

JOSEPH (LEWIS)
 47514-16 18 cm, 7" 47516-16



Nasenraspeln
 Nasal Rasps
 Escofinas nasales
 Raspa nasale

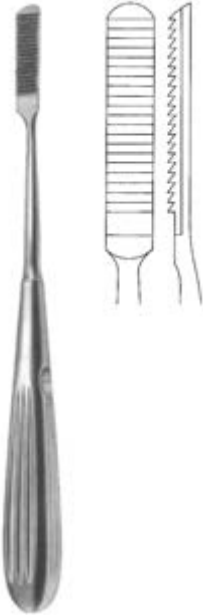

MALTZ (COTTLE)
 47518-21
 21 cm, 8 1/4"

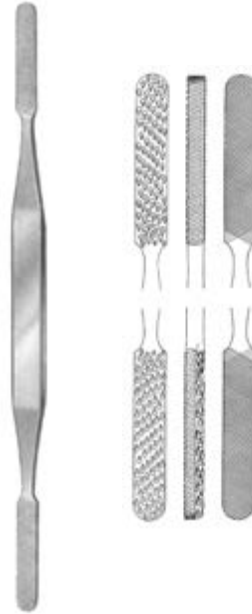

FOMON
 47520-21
 21 cm, 8 1/4"



MILLER
 18 cm, 7"



47521-01

5 mm



47521-02

4,3 mm



47521-03

5 mm

Nasenraspeln
Nasal Rasps
Escofinas nasales
Raspa nasale



1



3



5



7



9



2



4

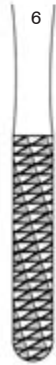

6



8



10

FOMON

47522-01 - 47522-09 TC
20 cm, 8"

Fig. 1/2

47522-01 TC

Fig. 3/4

47522-04 TC

Fig. 5/6

47522-05 TC

Fig. 7/8

47522-07 TC

Fig. 9/10

47522-09 TC

Nasenraspeln, Nasensägen
 Nasal Rasps, Nasal Saws
 Escofinas nasales, Sierras nasales
 Raspa nasale, Seghe nasale



PEET
 47523-01 —
 47523-02 —
 19 cm, 7 1/2"



GALLAHER
 47526-16 - 47529-16
 16 cm, 6 1/4"



Fig. 1
 47526-16



Fig. 2
 47527-16

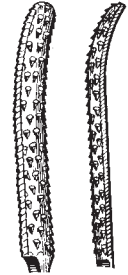

Fig. 3
 47529-16



JOSEPH
 47535-01 47535-02
 17 cm, 6 3/4"



47533-19
 gerade
 straight
 recta
 retta



47532-19
 links
 left
 izquierda
 sinistra



47534-19
 rechts
 right
 derecha
 destra

JOSEPH
 19 cm, 7 1/2"

Nasenhaken
Nasal retractor
Retradores nasales
Retrattori nasali



COTTLE
47540-16
16 cm, 6 1/4"



MASING
47541-14
14 cm, 5 1/2"



AUFRICT
47542-12
12 cm, 4 3/4"



AUFRICT
47551-16
16 cm, 6 1/4"



AUFRICT
47551-16L
16 cm, 6 1/4"



MASING-NEIVERT
47552-16
16 cm, 6 1/4"

Nasenhaken, Hauthäkchen
 Nasal retractor
 Retractores nasales, Ganchos para la piel
 Retrattori nasali, uncini nasali

10 x 12 mm



COTTLE
 47553-15
 15 cm, 6"

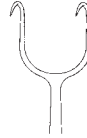

47554-01

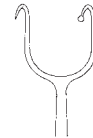

47554-02

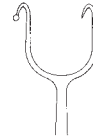

47554-03

COTTLE
 14,5 cm, 5 3/4"

3 x 11 mm



KILNER
 47555-08
 8 cm, 3 1/8"

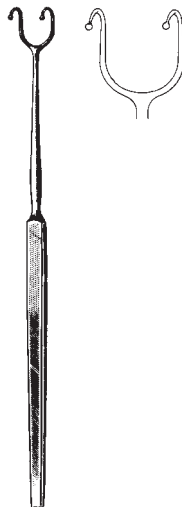

FOMON
 47556-16
 16 cm, 6 1/4"



FOMON
 47557-17
 17 cm, 6 3/4"

Hauthäkchen, Columella Pinzette
 Retractor, Columnella forceps
 Ganchos para la piel, Pinza para columella
 Uncini, Pinzetta columella



FREER
 47558-15
 15 cm, 6"



COTTLE-NEIVERT
 47559-20
 20 cm, 8"



GILLIES
 18 cm, 7"



Fig. 1
 47560-18



Fig. 2
 47562-18



LANGE
 47563-22
 23 cm, 9"



COTTLE
 47564-16
 16 cm, 6 1/4"



COTTLE
 47565-10
 10 cm, 4"

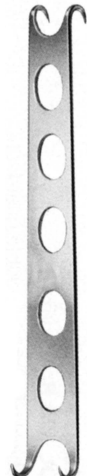

CONVERSE
 47566-12
 12 cm, 4 3/4"

Septumrichtzangen, Küretten
 Septum Straightening Forceps, Curettes
 Pinza para enderezar el tabique nasal, curetas
 Pinza per la plastica nasale, Curette



ASCH
 47571-23
 23 cm, 9"



WALSHAM
 47572-23 - 47575-23
 23 cm, 9"



47572-23
 gerade
 straight
 recta
 retta

47573-23
 links
 left
 izquierda
 a sinistra

47575-23
 rechts
 right
 derecha
 a destra

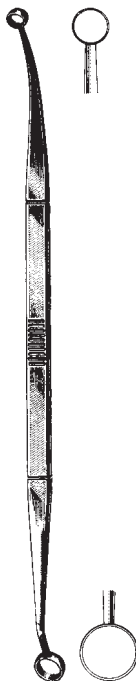

FAULKNER
 47601-21
 21 cm, 8 1/4"



COAKLEY
 47607-01 - 47607-06
 17 cm, 6 3/4"



47607-01
 Fig. 1



47607-02
 Fig. 2



47607-03
 Fig. 3



47607-04
 Fig. 4



47607-05
 Fig. 5



47607-06
 Fig. 6

Ringmesser
Adenoid Currettes
Cuchillos para vegetaciones adenoides
Coltelli per vegetazioni adenoide

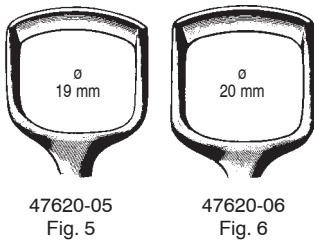
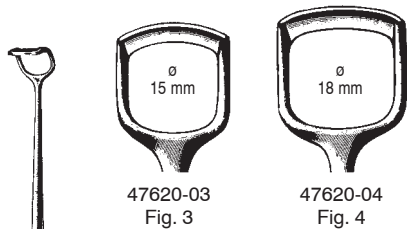
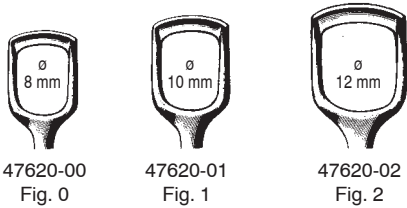

BECKMANN
47620-01 - 47620-06
22 cm, 8 3/4"



St. CLAIR-THOMSON
47636-01 - 47636-04
21 cm, 8 1/4"

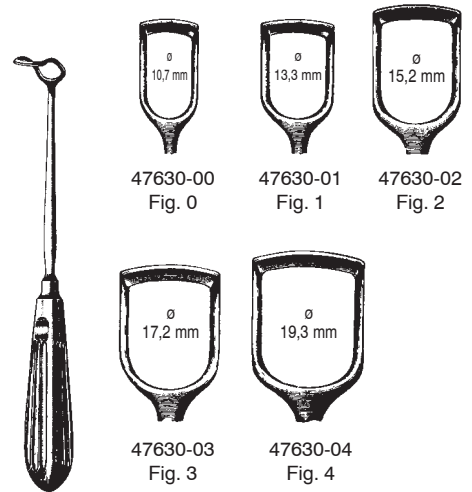

BARNHILL
47630-01 - 47630-04
21 cm, 8 1/4"

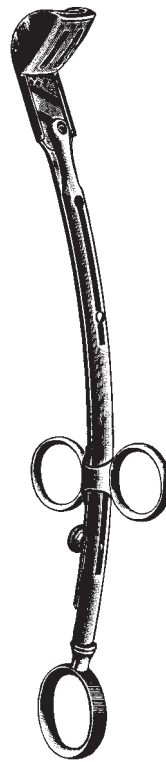

LAFORCE
47641-01 - 47641-03
25 cm, 10"

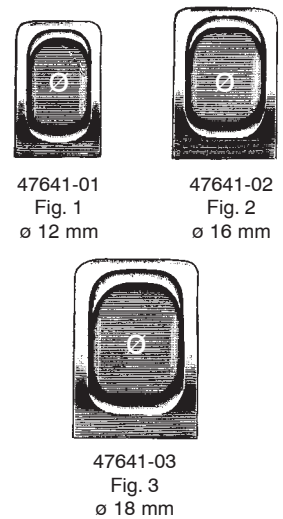

Ersatzklingen allein, gelocht
Spare blades, perforated
Hojas de repuesto, perforadas
Lame di ricambio, forate

Fig. 1 47642-01
Fig. 2 47642-02
Fig. 3 47642-03

Zungenspatel, Wangen- und Lippenhalter
 Tongue Depressors, Cheek and Lip Retractors
 Baja-lenguas, Separadores para labios y mejillas
 Abbassalingua, Divaricatori per guance e labbra

Holz
 wood
 madera
 legno



49102-16
 16 cm, 6 1/4"
 Pack. à 100

21,7 mm



MAYO
 49103-17
 17 cm, 6 3/4"

21,4 mm



KROENIG
 49104-15
 15 cm, 6"

23 mm



FRENZEL
 49105-16
 16,5 cm, 6 1/2"

13 mm

16 mm



49106-01
 14,5 cm, 5 3/4"

15 mm



49106-02
 14,5 cm, 5 3/4"

15 mm



BRUENINGS
 49107-19
 19 cm, 7 1/2"

19 mm

20 mm



CAWOOD-MINNESOTA
 49108-15
 15 cm, 6"

20 mm

23 mm



BUCHWALD
 49109-19
 19 cm, 7 1/2"

19 mm

Zungendrucker
Tongue Depressors
Baja-lenguas
Abassalingua



MORITZ-SCHMIDT
49110-19
19 cm, 7 1/2"

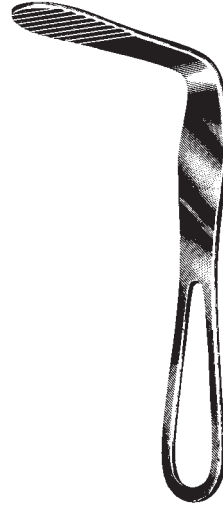

HARTMANN
49111-15
15 cm, 6"



49115-01
Fig. 1
14 cm, 5 1/2"



49115-02
Fig. 2
15 cm, 6"

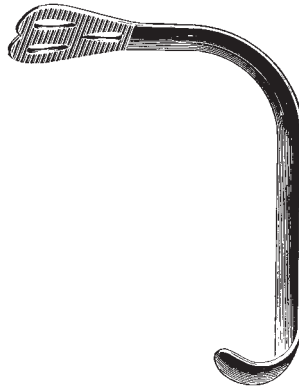

WIEDER
49115-01 - 49115-02



ANDREW
49117-11
11 cm, 4 3/8"

Zungendrucker, Wangen- und Lippenhalter, Zungenzangen
 Tongue Depressor, Cheek and Lip Retractor, Tongue Holding Forceps
 Baja-lenguas, Separadores para labios y mejillas, Pinza tira-lenguas
 Abassalingua, Divaricatori per guance e labbra, Pinza tiralingua

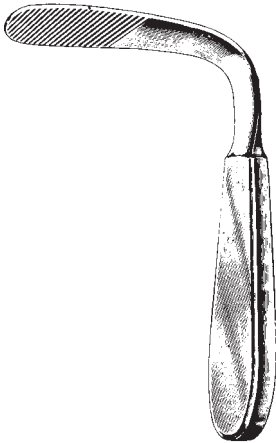

TOBOLD
 49119-14
 14,5 cm, 5 3/4"

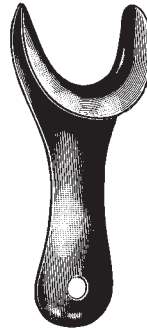

49230-11
 11 cm, 4 3/8"



STERNBERG
 49231-12 12 cm, 4 3/4"
 49231-14 14 cm, 5 1/2"
 49231-16 16 cm, 6 1/4"



49235-19
 19 cm, 7 1/2"

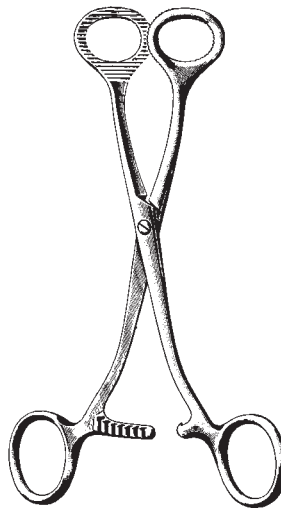

COLLIN
 49250-16 16 cm, 6 1/4"
 49250-18 18 cm, 7"

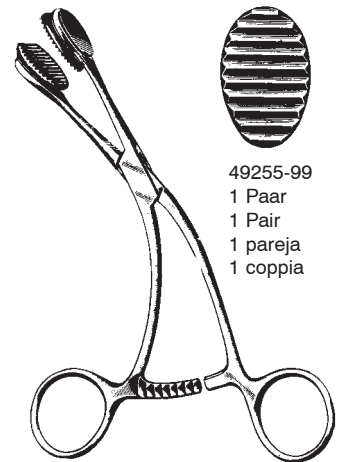

YOUNG
 49255-16
 16 cm, 6 1/4"



49255-99
 1 Paar
 1 Pair
 1 pareja
 1 coppia

Mundsperrer
Mouth Gags
Abre-Bocas
Apribocca

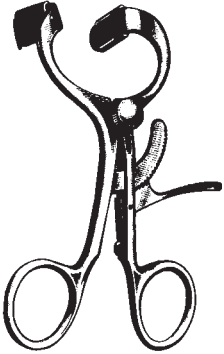

DOYEN-JANSEN (MOLT)
49265-12
12 cm, 4 $\frac{3}{4}$ "

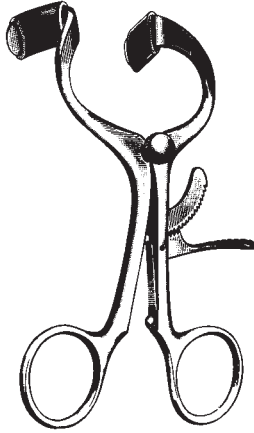

DOYEN-JANSEN (MOLT)
49265-14
14 cm, 5 $\frac{1}{2}$ "

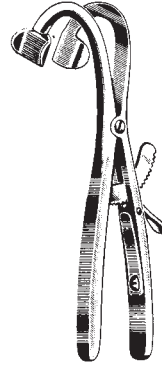

DENHART
49267-12
12 cm, 4 $\frac{3}{4}$ "

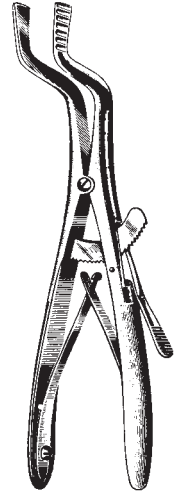

ROSER-KOENIG
49270-16 16 cm, 6 $\frac{1}{4}$ "
49270-19 19 cm, 7 $\frac{1}{2}$ "

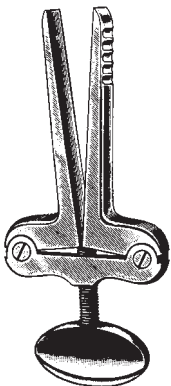

HEISTER
49272-13
13 cm, 5 $\frac{1}{8}$ "

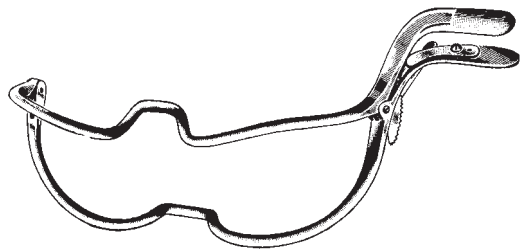

JENNINGS
49274-09 9 cm, 3 $\frac{1}{2}$ "
49274-11 11 cm, 4 $\frac{3}{8}$ "
49274-13 13 cm, 5 $\frac{1}{8}$ "
49274-15 15 cm, 6"

Zungenspatel, Mundsperrer
 Tongue depressor, Mouth Gags
 Baja-lengua, Abrebocas
 Abbassalingua, Apribocca



linke Seite
 left side
 izquierda
 lato sinistro



rechte Seite
 right side
 derecha
 lato destro

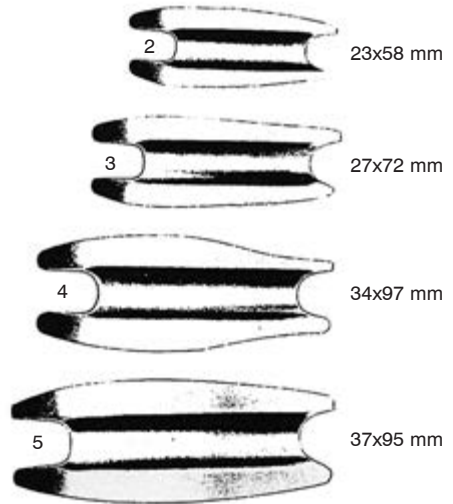

2 23x58 mm

3 27x72 mm

4 34x97 mm

5 37x95 mm

RING

- | | | |
|----------|--------|----------|
| 49287-02 | Fig. 2 | 49288-02 |
| 49287-03 | Fig. 3 | 49288-03 |
| 49287-04 | Fig. 4 | 49288-04 |
| 49287-05 | Fig. 5 | 49288-05 |

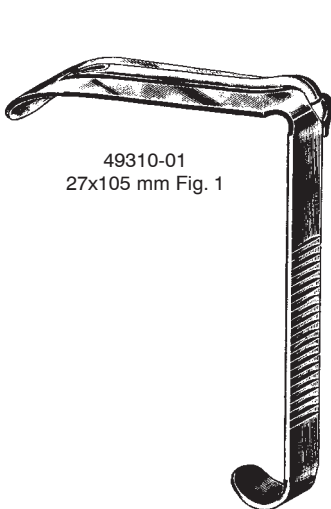

49310-01
 27x105 mm Fig. 1

DAVIS-BOYLE
 49310-00
 compl.



49310-02
 25x90 mm Fig. 2



49310-03
 25x75 mm Fig. 3



49310-04
 22x60 mm Fig. 4



49310-05
 20x25 mm Fig. 5

49310-08 Silikoneinlagen/Silicone pads
 inserto de silicona/inserto in silicone

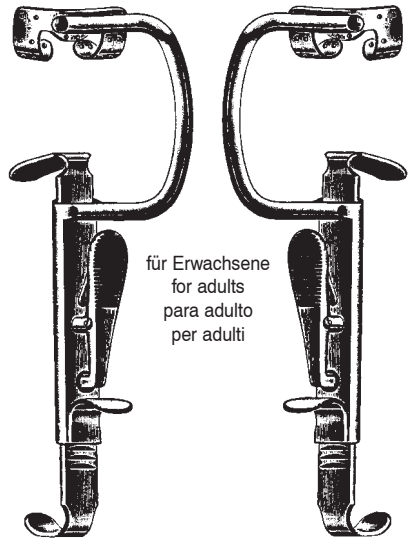

für Erwachsene
 for adults
 para adulto
 per adulti

49310-10
 Sperrer allein, links
 Gag only, left
 Abre-boca suelta, izquierda
 Apribocca solo, sinistra

49310-12
 Sperrer allein, rechts
 Gag only, right
 Abre-boca suelta, derecha
 Apribocca solo, destra

Mundsperrer
Mouth Gags
Abre-Bocas
Apribocca



49315-10
Sperrer allein
Gag only
Abre-boca solo
Apribocca solo



49315-01
37 x 80 mm
Fig. 1



49315-02
32 x 75 mm
Fig. 2



49315-03
28 x 65 mm
Fig. 3

KILNER-DOUGHTY

49315-00
komplett
complete
completo

49317-00 DINGMANN, complete
mit 3 auswechselbaren Zungendrucker,
2 seitliche Wangenhaken und 2 Zahnhaken

with 3 interchangeable tongue depressors,
2 rotating cheek holders
2 movable tooth hooks and thread guide

con 3 baja lenguas intercambiables,
2 valvas giratorias p. los labios,
2 ganchos graduables

con 3 depressori intercambiabili,
2 valve laterali rotative
2 uncini a denti movibile



1 24x62 mm
49317-01



2 28x65 mm
49317-02



3 31x75 mm
49317-03



DINGMANN
49317-10
Sperrer allein, Gag only
Abre-boca solo, Apribocca solo

Mundsperrer
Mouth Gag
Abre-bocas
Apribocca

49320-20
Silikon-Schlauch
Silicon Tubing
tubo de silicona
tubo in silicone

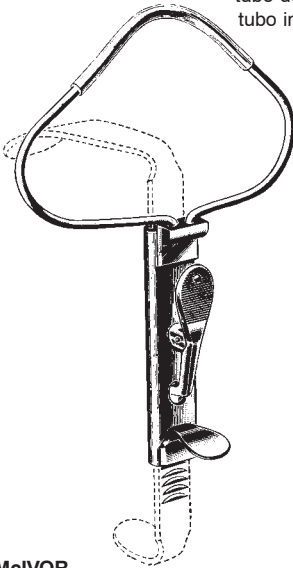

McIVOR
49320-00
compl.

49320-10

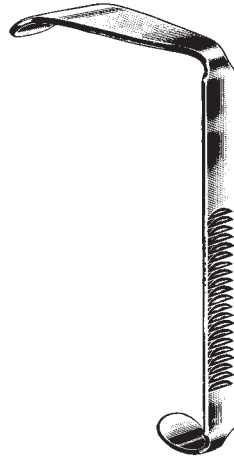

49320-01
27x95 mm Fig. 1



49320-02
22x85 mm Fig. 2



49320-03
22x70 mm Fig. 3



DAVIS-MEYER
49340-00

Zungenspatel
Tongue blades
Baja-lenguas
Abbassalingua

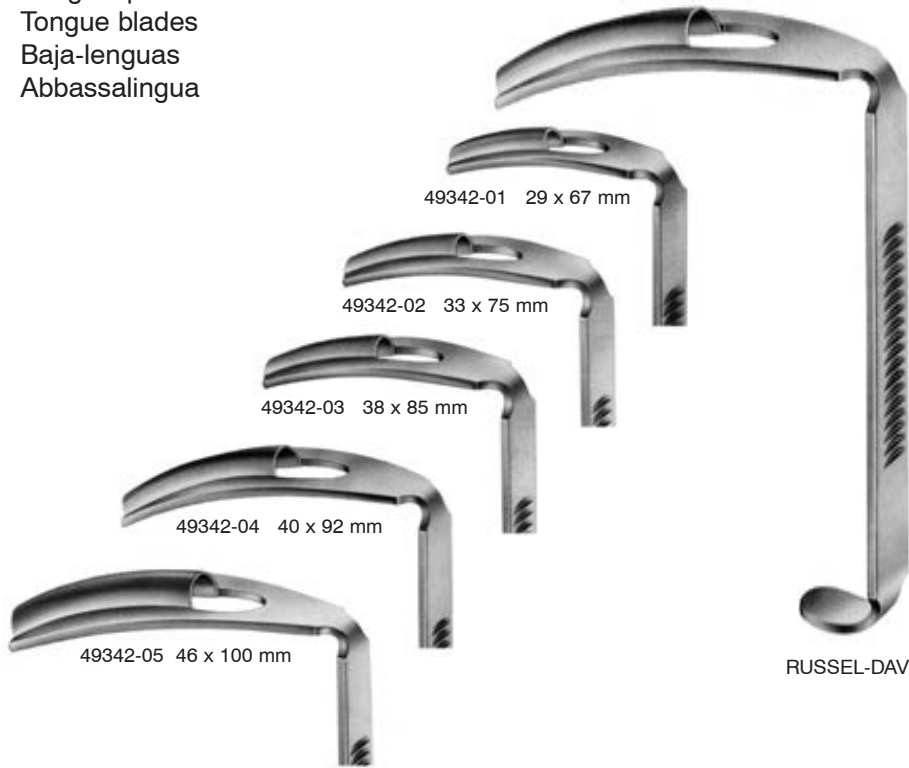

RUSSEL-DAVIS

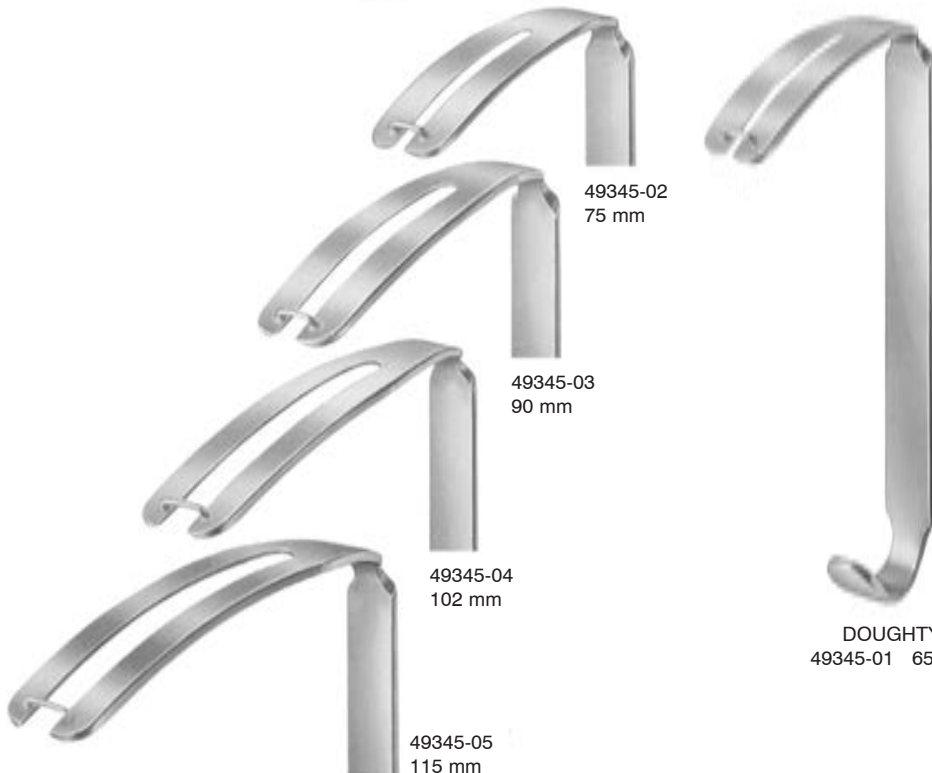
DOUGHTY
49345-01 65 mm

Mundkeil, Bruststütze, Repositionszange
 Oral wedges, Chest support, Disimpaction forceps
 Abreboca, Soporte de pecho, Pinzas para reposiciones
 Apribocca, Supporto per petto, Pinze per riposizione

Holz
 wood
 madera
 legno



MAUNDER
 49360-10



NEGUS
 49400-01



links
 left side
 izquierda
 lato sinistro

ROWE

- 49501-22 22,5 cm, 8.9"
- 49501-23 23,5 cm, 9 1/4"
- 49501-24 24,0 cm, 9 1/2"

- Baby, baby, bebé, lattante
- Kind, child, niño, bambino
- Erwachs., adult, adulto



rechts
 right side
 derecha
 lato destro

ROWE

- 49503-22 22,5 cm, 8.9"
- 49503-23 23,5 cm, 9 1/4"
- 49503-24 24,0 cm, 9 1/2"

Wundhaken für Mund-Kiefer-Gesicht
 Retractors for Mouth-, Jaw- and Face Surgery
 Separadores para cirugía plástica
 Divaricatori per chirurgia plastica



49605-07
25x7 mm

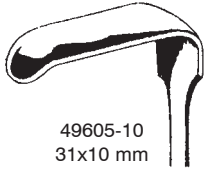

49605-10
31x10 mm

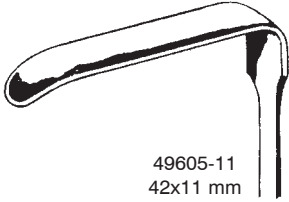

49605-11
42x11 mm

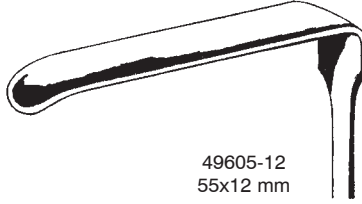

49605-12
55x12 mm

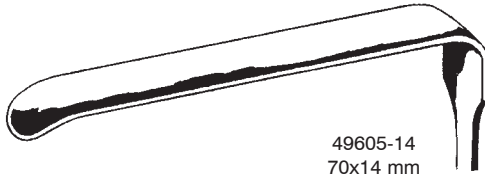

49605-14
70x14 mm

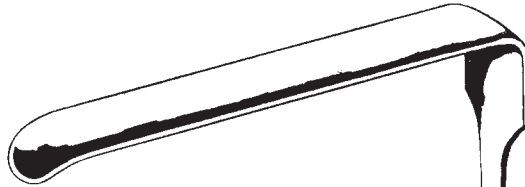

49605-16
80x16 mm



OBWEGESER
49605-07 - 49605-16
22 cm, 8 3/4"

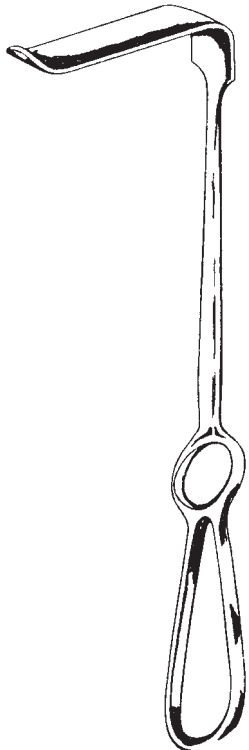

OBWEGESER
49610-12 - 49610-16
22 cm, 8 3/4"

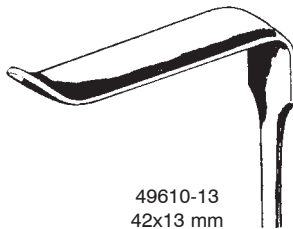

49610-13
42x13 mm

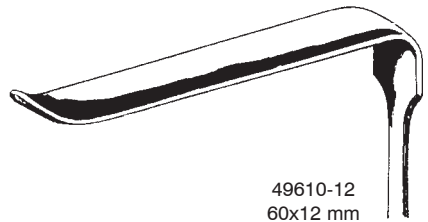

49610-12
60x12 mm

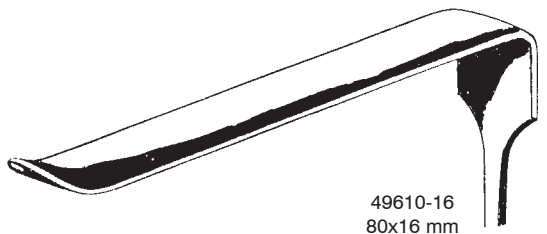

49610-16
80x16 mm

Wundhaken für Mund-Kiefer-Gesicht
Retractors for Mouth-, Jaw- and Face Surgery
Separadores para cirugía plástica
Divaricatori per chirurgia plastica

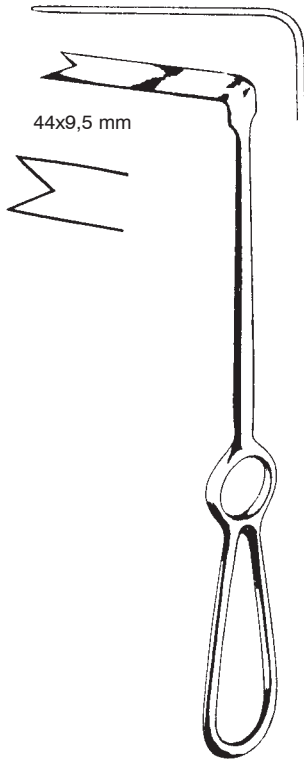

SPINA-NASALIS
49613-10
22 cm, 8 3/4"

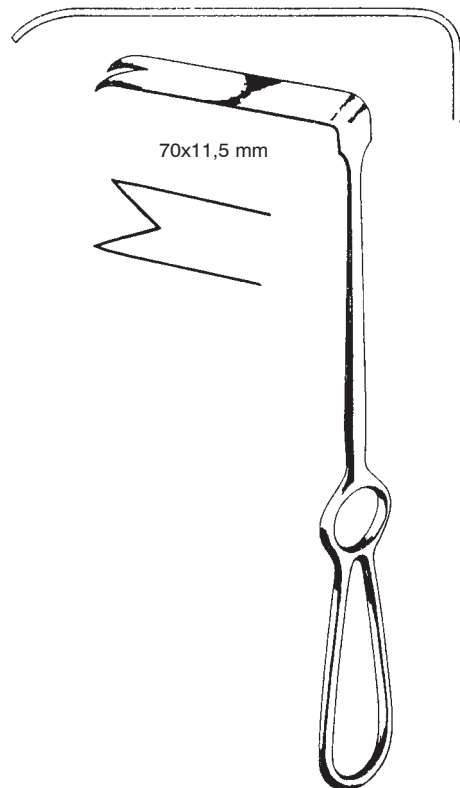

RAMUS
49615-12
22 cm, 8 3/4"

Wundhaken für Mund-Kiefer-Gesicht, Raspatorien
 Retractors for Mouth-, Jaw- and Face Surgery, Periosteal Elevators
 Separadores para cirugía plástica, Periostótomos
 Divaricatori per chirurgia plastica, Periostotomi

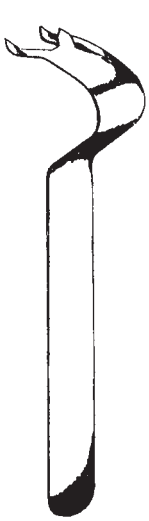

OBWEGESER
 49620-15
 15,5 cm, 6"

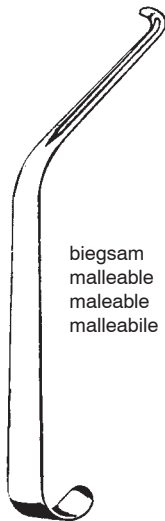

OBWEGESER
 49623-16
 16 cm, 6 1/4"

biegsam
 malleable
 maleable
 malleabile



OBWEGESER
 49627-01
 21 cm, 8 1/4"

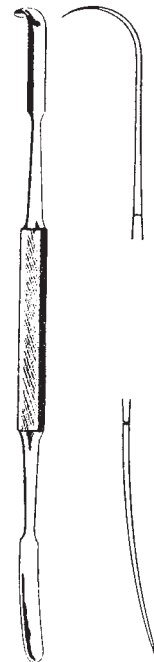

OBWEGESER
 49630-02
 20,5 cm, 8"

Drahtbogen
Wire Pushers
Empujadores de alambres
Posizionatori per filo



ERICH
49631-00
20,5 cm, 8"

Raspatorien
 Periosteal Elevators
 Periostótomos
 Periostotomi

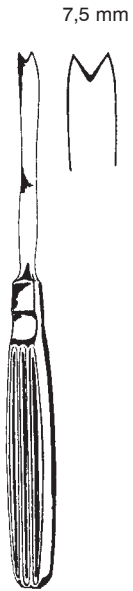

OBWEGESER
 49635-18
 17,5 cm, 7"



OBWEGESER
 49640-05 - 49640-09
 20 cm, 8"

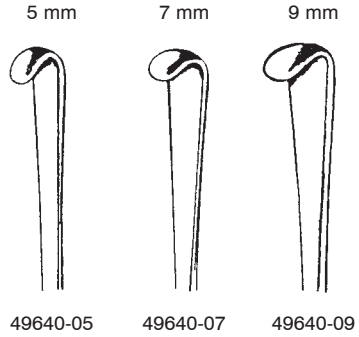

5 mm 7 mm 9 mm
 49640-05 49640-07 49640-09



OBWEGESER
 49650-06 - 49650-11
 17,5 cm, 7"



49650-06



49650-07



49650-09



49650-11

Elevator, Osteotom, Ahle
 Elevator, Osteotome, Awls
 Elevadores, Osteotomos, Agujas
 Elevatori, Osteotomo, Aghi



DINGMAN
 49660-18
 18 cm, 7"



OBWEGESER
 49665-24
 23,5 cm, 9 1/4"



Vorderrandstripper
 Anterior Border Stripper
 Separador para el borde anterior
 Separatore per il bordo anteriore

HARGIS
 49670-19
 19 cm, 7 1/2"



Spreizzange
 Ramus Separator
 Pinza para separar la rama
 Pinza per separare il ramo

SMITH
 49670-20
 23,5 cm, 9 1/4"

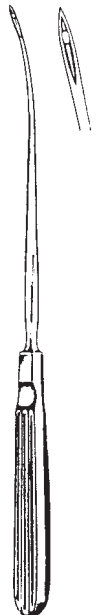

OBWEGESER
 49670-23
 23 cm, 9"

Intraorale Retraktoren
 Intra Oral Retractors
 Separadores intra orales
 Retrattori intraorali

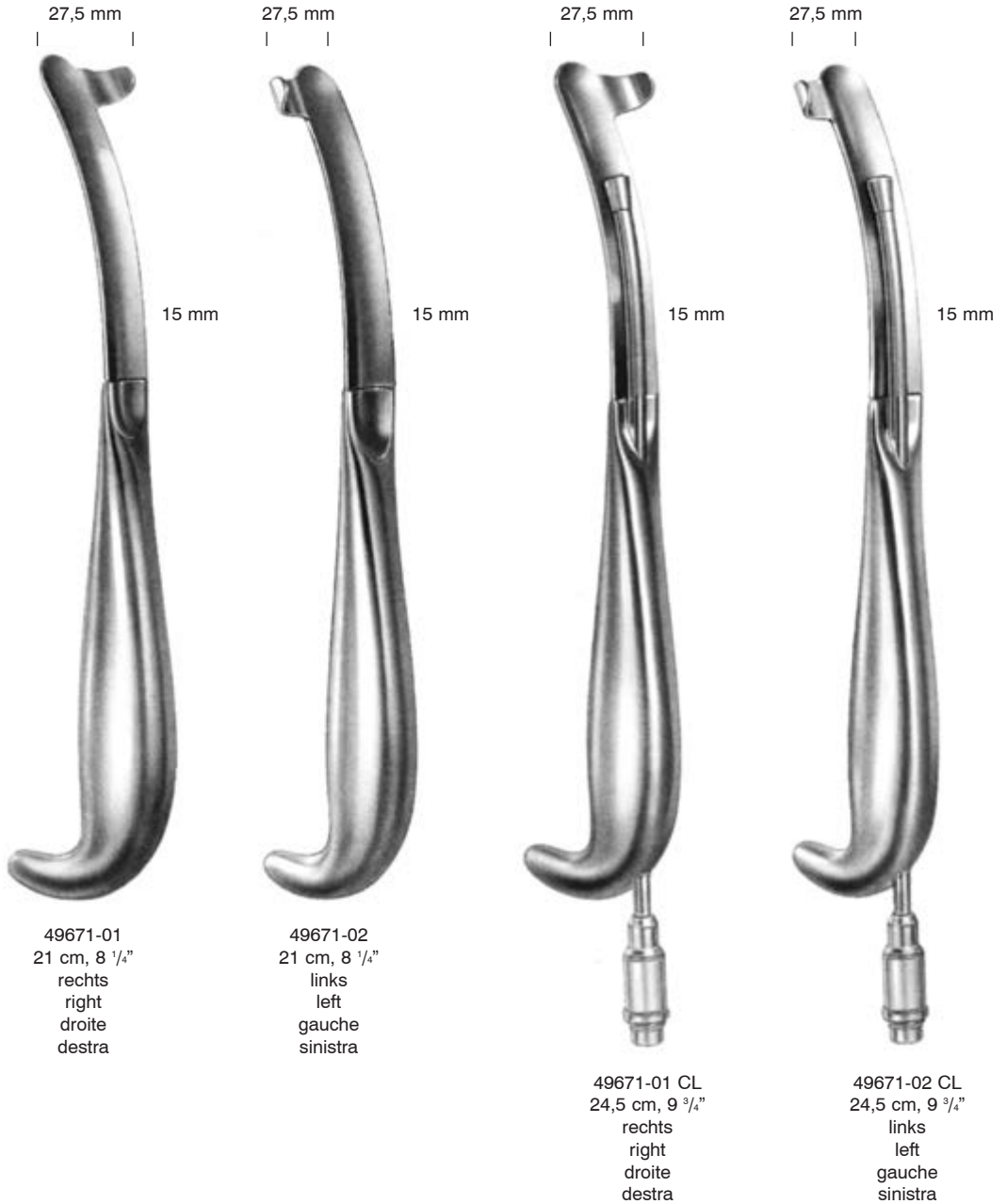

Raspatorien
Periosteal Elevators
Legras
Elevatori per periostio



HARGIS
23 cm, 9"



49673-01
6,5 mm
rechts
right
derecha
destra



49673-02
9 mm
rechts
right
derecha
destra



49673-03
6,5 mm
links
left
izquierda
sinistra



49673-04
9 mm
links
left
izquierda
sinistra

Ahle, Haken, Elevator
 Awls, Retractors for Mouth-, Jaw- and Face Surgery
 Aguja, Separadores para cirugía plástica
 Aghi, Divaricatori per chirurgia plastica



OBWEGESER
 49675-18
 18 cm, 7"



19 cm, 7 1/2"

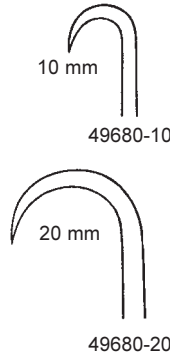

10 mm

49680-10

20 mm

49680-20



DINGMAN
 49685-21
 21 cm, 8 1/4"

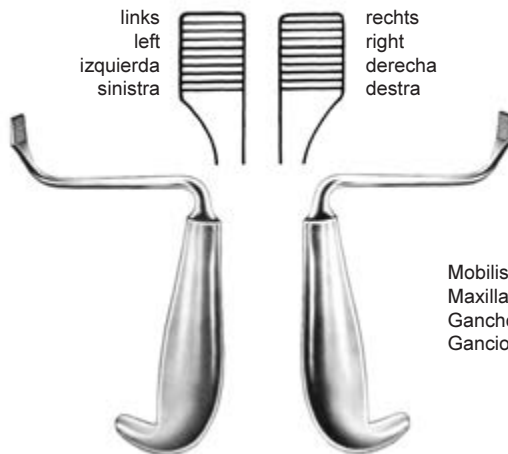

links
 left
 izquierda
 sinistra

rechts
 right
 derecha
 destra

Mobilisierhaken
 Maxillary Mobilizer
 Gancho para movilización
 Gancio per mobilizzare

TESSIER
 49691-15 15 cm, 6"

TESSIER
 49692-15 15 cm, 6"

Intraorale Retraktoren
Intra Oral Retractors
Separadores intra orales
Retrattori intraorali



49694-25
25 cm, 9 ³/₄"
12,5 / 27 mm

49694-25 CL
28 cm, 11"
12,5 / 27 mm

Sagittalspreizer
Sagittal Split Separators
Separadores sagitales
Separatori sagittali



rechts
right
derecha
destra



SMITH
49695-01
18,5 cm, 7 1/4"
9 mm

links
left
izquierda
sinistra



SMITH
49695-02
18,5 cm, 7 1/4"
9 mm

Unterkieferkörperhaken
Mandibular Body Retractor
Separador para el cuerpo mandibular
Separatore per il corpo mandibolare

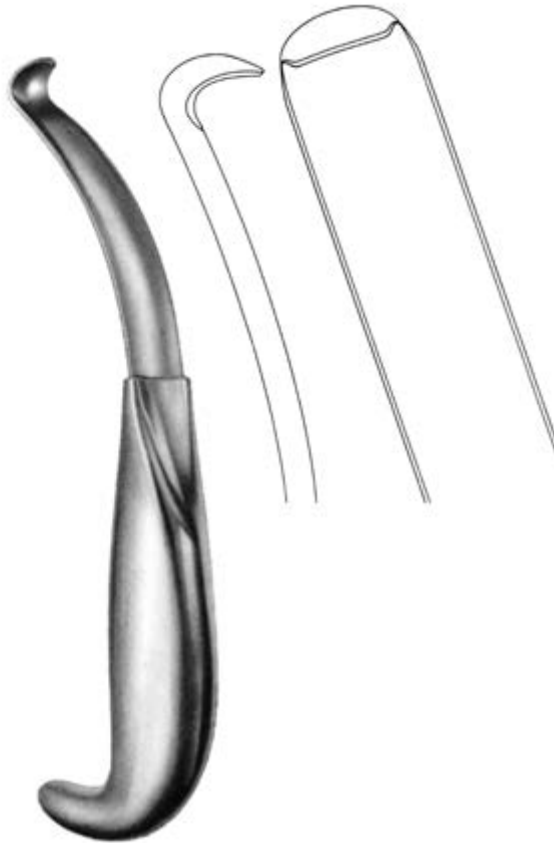

HARGIS
49696-18
18 cm, 7"

Osteotome
Osteotome
Osteótomos
Osteotomi



49700-01
21,5 cm, 8 1/2"



49700-02
21,5 cm, 8 1/2"

Blattosteotom
Blade Osteotomes
Osteótomos de hoja
Osteotomo a lama



OBWEGESER
22 cm, 8 3/4"



49705-08
8 mm



49705-12
12 mm



49705-16
16 mm



49705-20
20 mm

Osteotome
 Osteotome
 Osteótomos
 Osteotomi

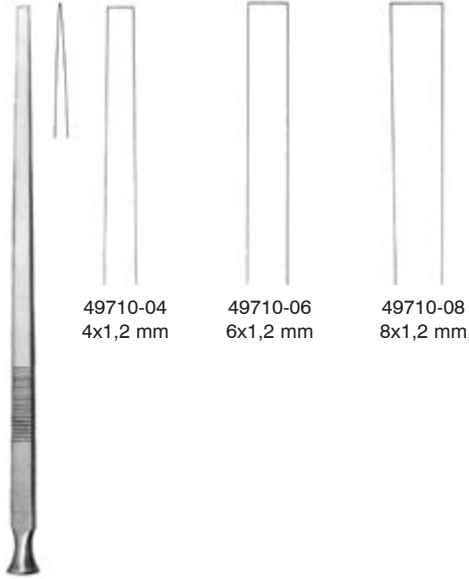

49710-04
 4x1,2 mm

49710-06
 6x1,2 mm

49710-08
 8x1,2 mm

EPKER
 18 cm, 7"

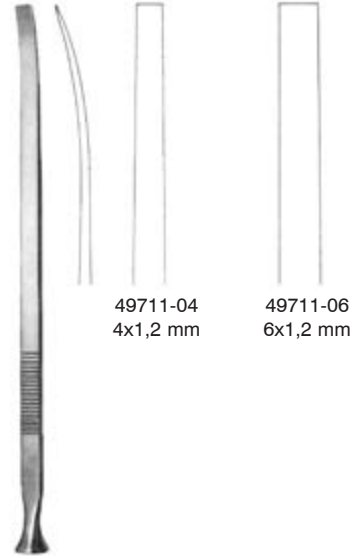

49711-04
 4x1,2 mm

49711-06
 6x1,2 mm

EPKER
 18 cm, 7"

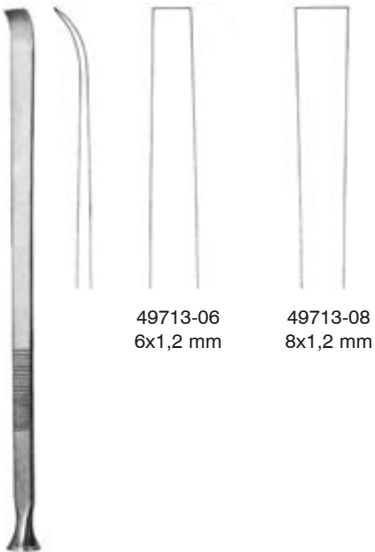

49713-06
 6x1,2 mm

49713-08
 8x1,2 mm

EPKER
 18 cm, 7"

Wundhaken, Tonsillen-Elevatoren, Tamponstopfer
 Retractors, Tonsil-Elevators, Gauze packer
 Separadores, Elevadores para amígdalas, Tamponeador
 Divaricatori, Elevatori, Tamponatore

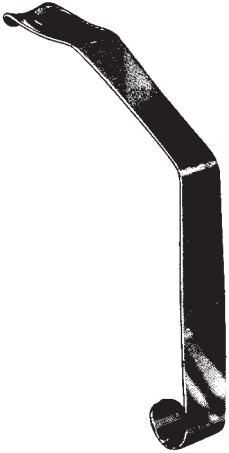

LOVE 15 cm, 6"
 51103-18 18 mm
 51103-20 20 mm
 51103-22 22 mm



HOFER
 51109-24
 24 cm, 9 1/2"



NAGER
 51111-23
 23 cm, 9"



HURD
 51131-22
 22 cm, 8 1/4"



LOPEZ-REINKE
 51133-23
 23 cm, 9"



YANKAUER
 51134-21
 21 cm, 8 1/4"



51135-01



51135-02



HENKE
 23 cm, 9"



CARPENTER
 51139-25
 25 cm, 10"



CARPENTER
 51143-24
 24 cm, 9 1/2"



LUNIATSCHEK
 51151-19
 19 cm, 7 1/2"

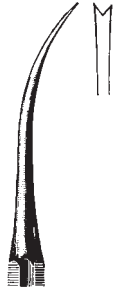

Tonsillen-Nadeln, Tonsillen-Messer

Tonsil Needles, Tonsil-Knives

Agujas para suturas de amígdalas, Bisturios para amígdalas

Aghi per tonsille, Coltelli per tonsille

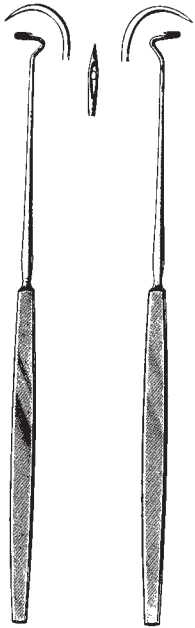

DUPUY-WEISS
51165-22 51167-22
22 cm, 8 3/4"



CLAUS
51168-23
23 cm, 9"



CLAUS-EICKEN
51169-23
23 cm, 9"



NAGER
51170-24
24 cm, 9 1/2"



FISHER
51171-22
22,5 , 9"



ABRAHAM
51172-19
19 cm, 7 1/2"



ABRAHAM
51173-21
21 cm, 8 1/4"



CANFIELD
51174-21
21 cm, 8 1/4"



BRUENINGS
51177-23
23 cm, 9"



DOUGLAS
51178-21
21 cm, 8 1/4"



DOUGLAS
51179-17
17 cm, 6 3/4"

Tonsillenzange
 Tonsil Seizing Forceps
 Pinzas para coger las amígdalas
 Pinze per tonsille

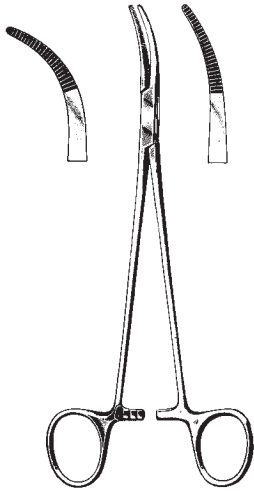

19 cm, 7 1/2"
 SAWTELL SCHNIDT
 51181-19 51183-19

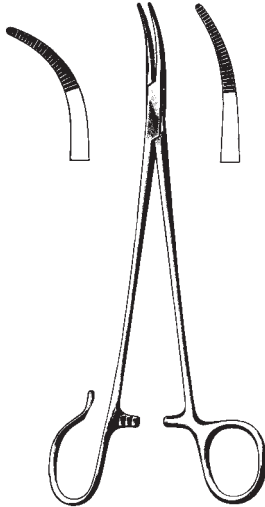

19 cm, 7 1/2"
 SAWTELL SCHNIDT
 51185-19 51187-19

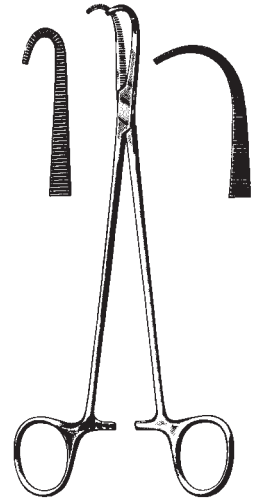

19 cm, 7 1/2"
 NEGUS NEGUS
 51191-19 51193-19

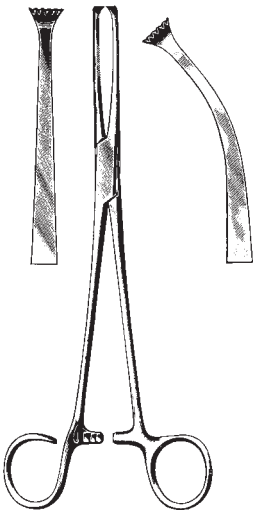

19 cm, 7 1/2"
 COLVER
 51202-19 51203-19

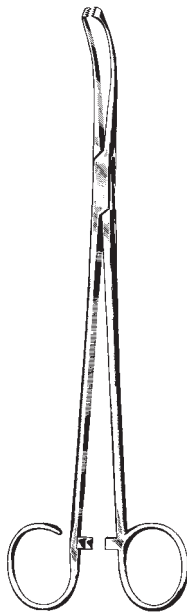

WHITE
 51205-18 18 cm, 7"
 51205-23 23 cm, 9"

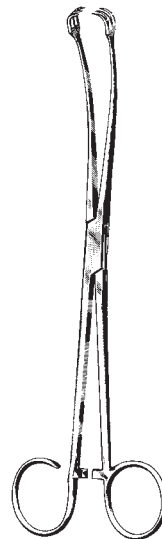

BALLENGER
 51207-21
 21,5 cm, 8 1/2"

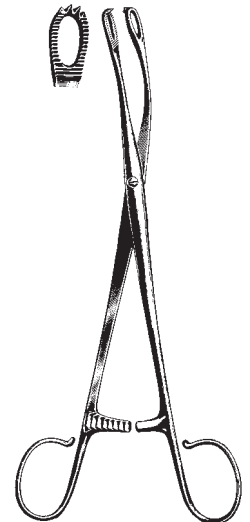

BLOHMKE
 51209-20
 20 cm, 8"

Tonsillen-Zangen u. -Pinzetten, Tonsillen-Kompressoren, Tonsillen-Schnürer
 Tonsil-Forceps, Tonsil-Snares
 Pinzas, Compresores para amígdalas, Cierra-nudos para amígdalas
 Pinze, Compressori per tonsille, Serranodi per tonsille



ABRAHAM
 51210-20
 20 cm, 8"

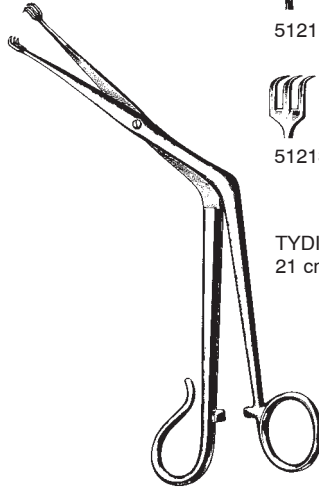

51211-21



51213-21

TYDING
 21 cm, 8 1/4"

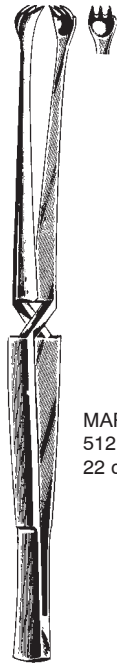

MARSCHIK
 51219-22
 22 cm, 8 3/4"



EVES
 51250-28
 28 cm, 11"



EVES
 51252-28
 28 cm, 11"



BRUENINGS
 51256-28
 28 cm, 11"

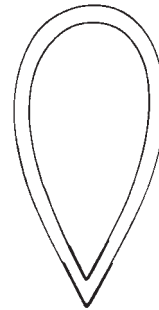

51257-40 40 mm
 51257-50 50 mm
 Pack of 100 pcs



51259-03 0,3 mm
 51259-04 0,4 mm
 51259-05 0,5 mm
 Pack of 12 pcs

Tonsillotom
Tonsillectomes
Amigdalótomos
Tonsillotomi

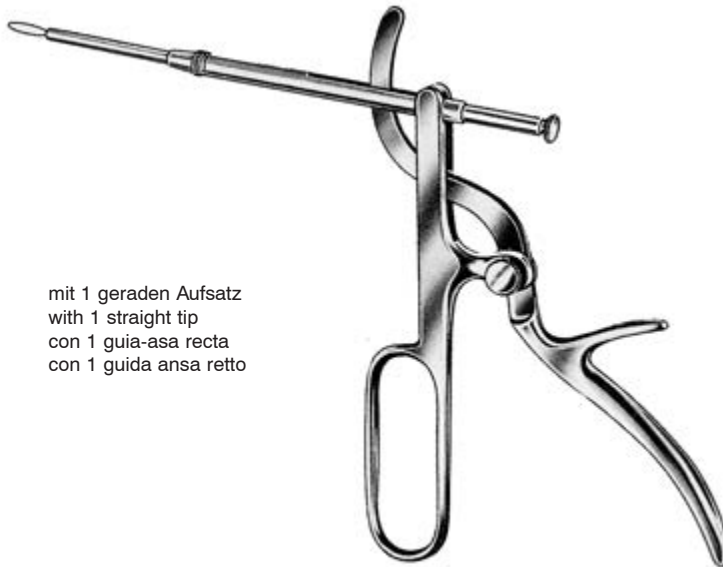

mit 1 geraden Aufsatz
with 1 straight tip
con 1 guida-asa recta
con 1 guida ansa retto

TYDING
51260-00

Tonsillotom, Spritzen, Septum Nadeln
 Tonsillectomes, Syringes, Septum needles
 Amigdalótomos, Jeringas, Septum aguja
 Tonsillotomi, Siringhe, Septum aghi

Aufsatz allein
 blade only
 hoja sola
 lama sola

51270-01

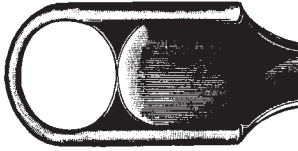

1

51270-02

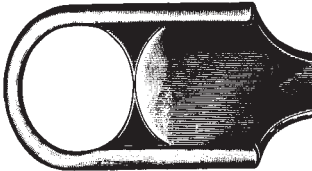

2

51270-03

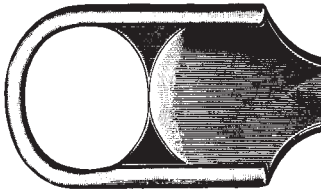

3

51270-04
 Handgriff allein
 Handle only
 mango para
 manipolo solo

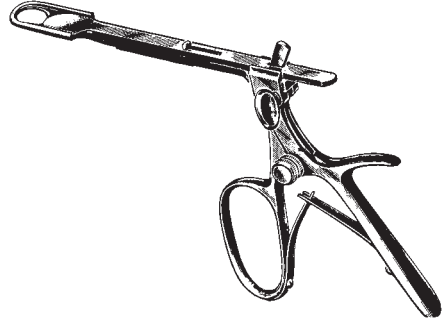

SLUDER-BALLENGER
 51270-00
 mit 3 Aufsätzen
 with 3 blades
 con 3 hojas
 con 3 lame

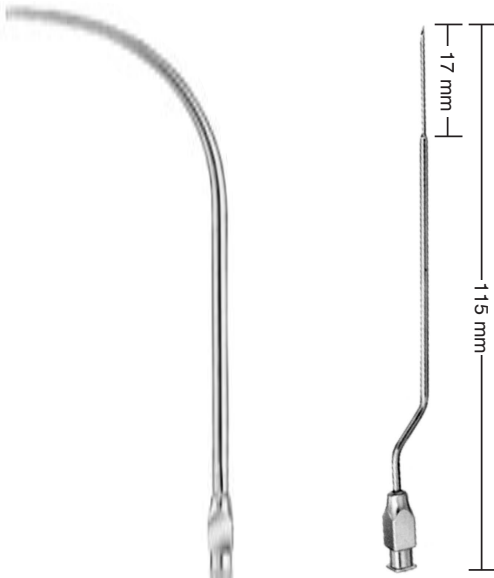

51291-00
 2,5 mm Ø

51293-00
 0,8 mm Ø

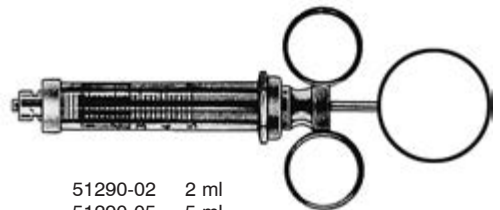

51290-02 2 ml
 51290-05 5 ml
 51290-10 10 ml
 51290-20 20 ml



51292-00



51293-45
 45°



51293-90
 90°

Septum-Schere, Kehlkopfpolypenzangen, Deckelhalter
 Septum-Scissors, Laryngeal Polypus Forceps, Epiglottis Retractor
 Tijeras para septo, Pinzas para pólipos laríngeos, Depresor para epiglottis
 Forbice per il setto nasale, Pinze per polipi laringei, Depressore per epiglottide



KILLIAN
 53102-20
 20 cm, 8"



53101-22



53103-22



JACKSON
 53101-22 - 53103-22
 22 cm, 8 3/4"

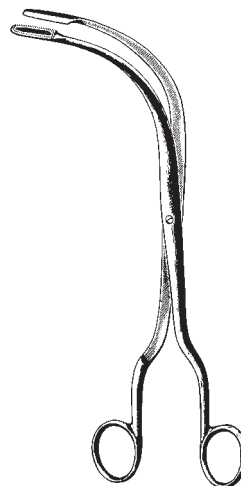

FRAENKEL
 53111-18
 18 cm, 7"

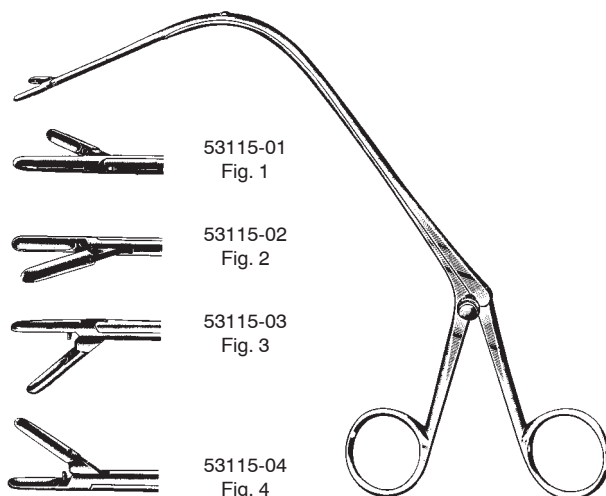

JURASZ
 53115-01 - 53115-04
 23 cm, 9"



53115-01
 Fig. 1



53115-02
 Fig. 2



53115-03
 Fig. 3



53115-04
 Fig. 4



REICHERT
 53121-24
 24 cm, 9 1/2"

Universalgriffe, Verlängerungsrohre, Aufsätze
 Universal Handles, Interchangeable Tips, Tubes
 Mangos universales y Tubos de extension, Puntas
 Manici universali e Tubi di prolungamento, Terminale laringeo

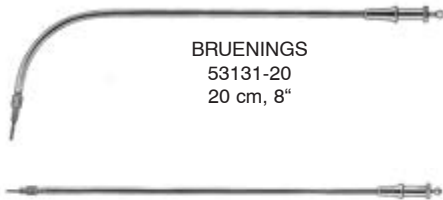

BRUENINGS
 53131-20
 20 cm, 8"



HUBER
 53130-00

- | | | | |
|----------|----------------|----------|----------------|
| 53132-20 | 20 cm, 8" | 53132-50 | 50 cm, 19 3/4" |
| 53132-30 | 30 cm, 11 3/4" | 53132-60 | 60 cm, 23 1/2" |
| 53132-40 | 40 cm, 15 3/4" | | |



FRAENKEL
 53150-00



SEIFERT
 53152-00



FRAENKEL
 53154-00



SCHEINMANN
 53155-00



SCHEINMANN
 53157-00

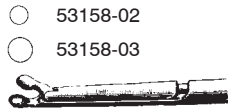

○ 53158-02
 ○ 53158-03
 BRUENINGS
 53158-02 - 53158-03

○ 53160-02

○ 53160-03



BRUENINGS
 53160-02 - 53160-03



LANGE
 53162-00

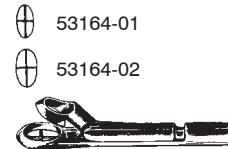

⊕ 53164-01
 ⊕ 53164-02
 KRAUSE
 53164-01 - 53164-02



KRAUSE
 53166-00



SCHUMACHER
 53170-00



BARACANI
 53175-00

⊕ 53177-01

⊕ 53177-02



CORDES
 53177-01 - 53177-02

Broncho-Oesophagoskopiezangen, Kehlkopfspiegel, Griffe
 Broncho-Esophagscopy Forceps, Laryngeal Mirrors, Handles
 Pinzas para bronco-esofagoscopia, Espejos laringeos, Mangos
 Pinze per bronco-esofagoscopia, Specchi laringei, Manici

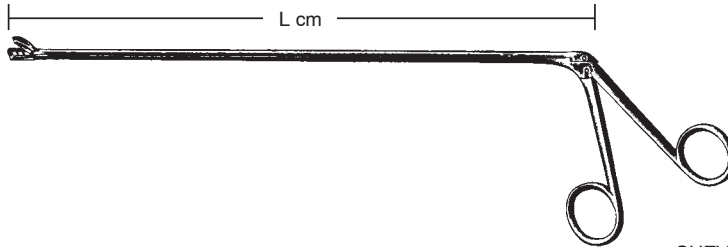

CHEVALIER-JACKSON
 53230-01 - 53260-08



cm	Fig. 1	Fig. 2	Fig. 3	Fig. 4	Fig. 5	Fig. 6	Fig. 7	Fig. 8
30 / 11 $\frac{3}{4}$ "	53230-01	53230-02	53230-03	53230-04	53230-05	53230-06	53230-07	53230-08
40 / 15 $\frac{3}{4}$ "	53240-01	53240-02	53240-03	53240-04	53240-05	53240-06	53240-07	53240-08
50 / 19 $\frac{3}{4}$ "	53250-01	53250-02	53250-03	53250-04	53250-05	53250-06	53250-07	53250-08
60 / 23 $\frac{1}{2}$ "	53260-01	53260-02	53260-03	53260-04	53260-05	53260-06	53260-07	53260-08

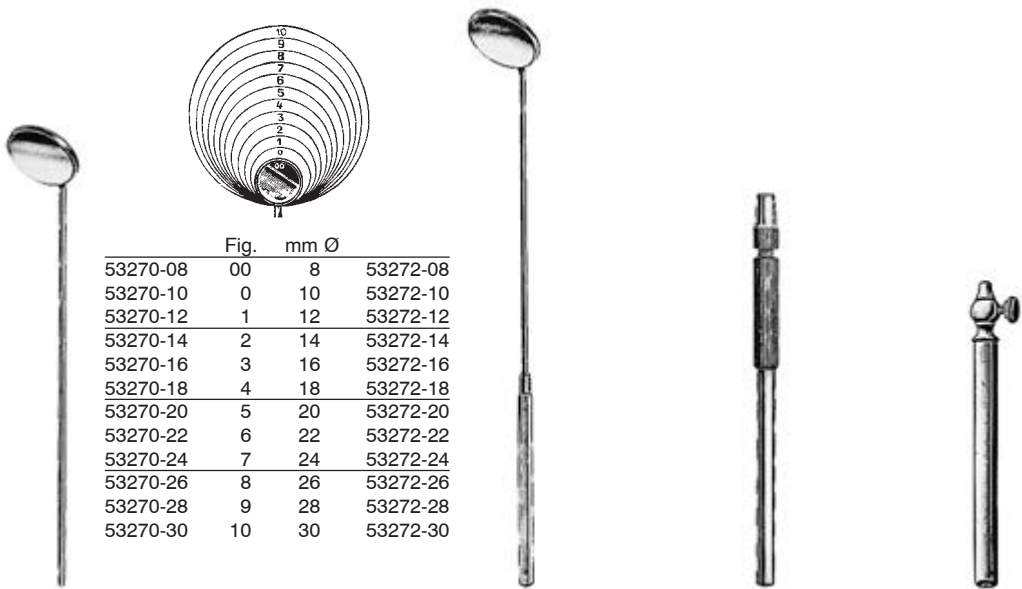

	Fig.	mm Ø	
53270-08	00	8	53272-08
53270-10	0	10	53272-10
53270-12	1	12	53272-12
53270-14	2	14	53272-14
53270-16	3	16	53272-16
53270-18	4	18	53272-18
53270-20	5	20	53272-20
53270-22	6	22	53272-22
53270-24	7	24	53272-24
53270-26	8	26	53272-26
53270-28	9	28	53272-28
53270-30	10	30	53272-30

53270-08 - 53270-30

53272-08 - 53272-30

53274-12

53276-10

Mikro-Rohrschaftzangen
 Micro Laryngeal Forceps
 Pinzas para la micro-cirugía de la laringe
 Pinze ad asta tubolare per microchirurgia

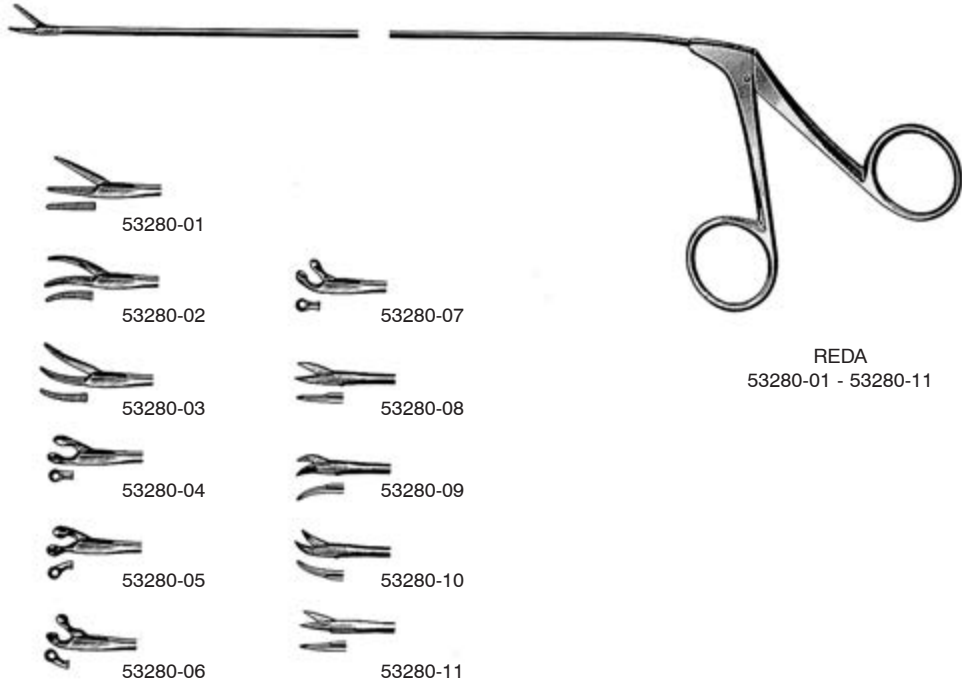

REDA
 53280-01 - 53280-11

REDA Mikro-Rohrschaftzangen 22 cm (8 3/4")

- 53280-01 gerieftes Maul, gerade 1,5 x 10 mm
- 53280-02 gerieftes Maul, links gebogen 1,5 x 8,5 mm
- 53280-03 gerieftes Maul, rechts gebogen 1,5 x 8,5 mm
- 53280-04 Löffelmaul, gerade 2,5 mm
- 53280-05 Löffelmaul, links abgewinkelt 2,5 mm
- 53280-06 Löffelmaul, rechts abgewinkelt 2,5 mm
- 53280-07 Löffelmaul, aufwärts abgewinkelt 2,5 mm
- 53280-08 Schere, gerade, vertikal
- 53280-09 Schere, links gebogen
- 53280-10 Schere, rechts gebogen
- 53280-11 Schere, horizontal schneidend, gerade

REDA Micro-Laryngeal Forceps 22 cm (8 3/4")

- 53280-01 Grasping tip, straight, serrated, 1,5 x 10 mm
- 53280-02 Grasping tip, curved to left, serrated, 1,5 x 8,5 mm
- 53280-03 Grasping tip, curved to right, serrated, 1,5 x 8,5 mm
- 53280-04 Cup forceps, straight, 2,5 mm
- 53280-05 Cup forceps, angled to left, 2,5 mm
- 53280-06 Cup forceps, angled to right, 2,5 mm
- 53280-07 Cup forceps, angled up, 2,5 mm
- 53280-08 Scissors, straight, vertical
- 53280-09 Scissors, curved to left
- 53280-10 Scissors, curved to right
- 53280-11 Scissors, straight, horizontal

REDA Pinza microlaringea 22 cm (8 3/4")

- 53280-01 boca estriada recta 1,5 x 10 mm
- 53280-02 boca estriada curva a la izquierda 1,5 x 8,5 mm
- 53280-03 boca estriada curva a la derecha 1,5 x 8,5 mm
- 53280-04 boca redonda cortante recta 2,5 mm Ø
- 53280-05 boca redonda cortante angulada al la izquierda 2,5 mm Ø
- 53280-06 boca redonda cortante angulada a la derecha 2,5 mm Ø
- 53280-07 boca redonda cortante angulada hacia arriba 2,5 mm Ø
- 53280-08 Tijera recta corte vertical
- 53280-09 Tijera curva a la izquierda
- 53280-10 Tijera curva a la derecha
- 53280-11 Tijera recta corte horizontal

REDA Pinze ad asta tubolare per microchirurgia 22 cm (8 3/4")

- 53280-01 morsi zigrinati, retti, 1,5 x 10 mm
- 53280-02 morsi zigrinati, curvi a sinistra, 1,5 x 8,5 mm
- 53280-03 morsi zigrinati, curvi a destra, 1,5 x 8,5 mm
- 53280-04 morsi a forma di cucchiaino rotondo retto, 2,5 mm
- 53280-05 morsi a forma di cucchiaino rotondo angolati a sinistra, 2,5 mm
- 53280-06 morsi a forma di cucchiaino rotondo angolati a destra, 2,5 mm
- 53280-07 morsi a forma di cucchiaino rotondo angolati in alto, 2,5 mm
- 53280-08 forbici, rette, taglio verticale
- 53280-09 forbici, curve a sinistra
- 53280-10 forbici, curve a destra
- 53280-11 forbici, rette, taglio orizzontale

Instrumente für Laryngoskopie
 Instruments for Laryngology
 Instrumentos Laringoscopia
 Strumenti per la Laringoscopia

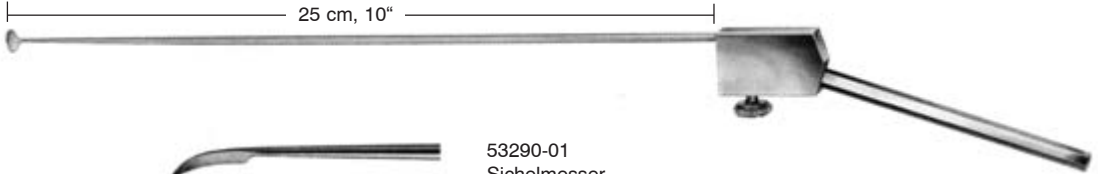

53290-01
 Sichelmesser
 micro-laryngeal sickle
 microlaringeo cuchillo de hoz
 Coltello falcato



53290-02
 Schälmesser, quer, oval
 micro-laryngeal separador oval, horizontal
 microlaringeo separador ovalado, horizontal
 Seperatore ovale verticale



53290-03
 Schälmesser, längs, oval
 micro-laryngeal separador oval, vertical
 microlaringeo separador ovalado, vertical
 Seperatore ovale orizzontale



53290-04
 Schälmesser, 45° abgewinkelt
 micro-laryngeal round cutting knife, 45° angled
 microlaringeo cuchillo para cortes redondos, 45° angulado
 Seperatore angolato 45°



53290-05
 Häkchen, 90° gebogen stumpf
 micro-laryngeal hook 90° angled, blunt
 microlaringeo ganchito 90° angulado, romo
 Uncino angolato 90° smusso



53290-06
 Häkchen, 30° retrograd gebogen
 micro-laryngeal probe, 30° backwards curved blunt with button
 microlaringeo ganchito, 30° curvo retrogrado
 Uncino angolato retrogrado 30°



53290-07
 Fadengabel
 micro-laryngeal ligatore adjuster
 microlaringeo horquilla de hilos
 Forchetta da sutura

53290-08
 Handgriff für Stabinstrumente
 Handle for microlaryngeal instruments
 Mango para microlaringeos instrumentos
 Manico per strumenti microlaringei



Tracheal Dilatoren, Trachealhaken, Tracheal-Wundspreizer

Trachea Dilators, Trachea hooks, Tracheal Retractors

Dilatadores para la tráquea, Ganchos para traqueotomía, Retractor traqueal

Dilatatori per tracheotomia, Ganci per tracheotomia, Divaricatori tracheali

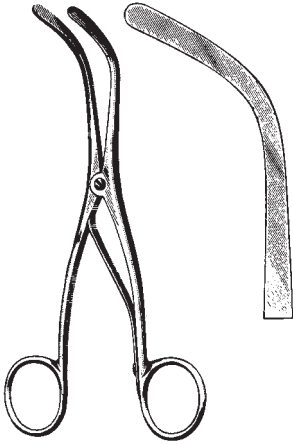

TROUSSEAU-BABY
55111-13 13 cm, 5 1/8"

TROUSSEAU
55111-14 14 cm, 5 1/2"

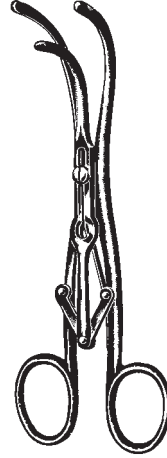

LABORDE
55113-14
14 cm, 5 1/2"



BOSE
55115-07
7 cm, 2 3/4"



JACKSON
55116-15
15 cm, 6"



JACKSON
55117-17
17 cm, 6 3/4"

Trachealhaken, Kanüle
 Trachea Hooks, Tubes
 Ganchos para traqueotomía, Cánula
 Ganci per tracheotomia, Cannule



ITERSON
 55118-16 - 55119-16
 16 cm, 6 1/4"



NEWS
 55120-15
 15 cm, 6"

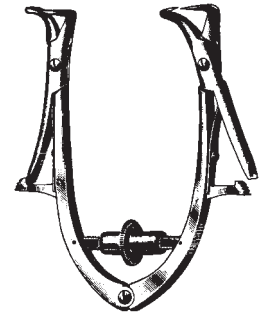

FRIEDMANN
 71351-10 10 cm, 4"
 71351-15 15 cm, 6"

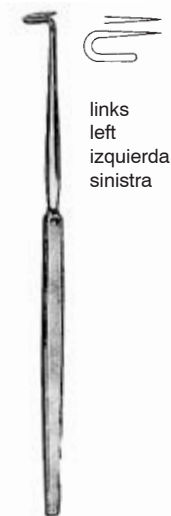

BOSE
 55122-16
 16 cm, 6 1/4"

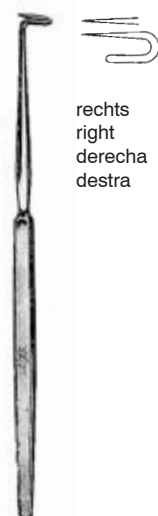

BOSE
 55124-16
 16 cm, 6 1/4"



WAGENER-MOSHER
 55151-05 5 mm
 55151-07 7 mm
 55151-09 9 mm



Tracheal-Kanülen, Schilddrüsenhaken, Sonde, Kropffabzange, Muskelklemme
 Tracheal Tubes, Thyroid Gland Retractor, Directors-Enucleators, Goitre Seizing Forceps, Muscular Clamp
 Cánulas traqueales, Separador para la glándula tiroidea, Sondas,
 Pinza para coger el bocio, Pinza-clamp para músculos
 Cannule tracheali, Divaricatori per la tiroide, Sonde, Pinze per gozzo, Pinza muscolare

LUER

Neusilber
 German silver
 alpaca
 argentone



CHEVALIER-JACKSON

Neusilber
 German silver
 alpaca
 argentone

Fig.	Ø mm	Länge des Außenrohrs Length of outer tube Largo de la cánula exterior Lunghezza del tubo esterno
0	4	45 mm
1	5	50 mm
2	6	55 mm
3	7	60 mm
4	8	65 mm
5	9	70 mm
6	10	75 mm
7	11	80 mm
8	12	85 mm
9	13	90 mm

55220-04
55220-05
55220-06
55220-07
55220-08
55220-09
55220-10
55220-11
55220-12
55220-13

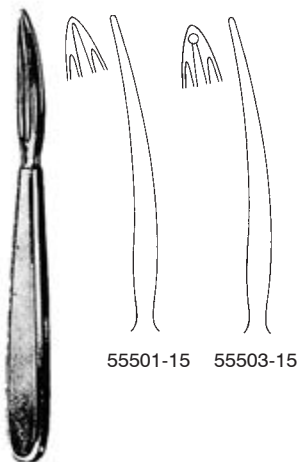
55240-04
55240-05
55240-06
55240-07
55240-08
55240-09
55240-10
55240-11
55240-12
55240-13

KOCHER

55501-15 - 55503-15
 15 cm, 6"

SCHOENBORN

55511-21
 21 cm, 8 1/4"

LAHEY

55520-15 15 cm, 6"
 55520-20 20 cm, 8"

MASTIN

55523-17
 17 cm, 6 3/4"

Rippenscheren
Rib Shears
Costótomos
Costotomi



COLLIN
57102-23
23 cm, 9"



57105-22
22 cm, 8 3/4"



GLUCK
57107-22
22 cm, 8 3/4"

mit ziehendem Schnitt
with eccentric sliding blade
con hoja de retroacción
con lama di retroazione



STILLE
57111-21
21 cm, 8 1/4"



CORYLLOS
57125-35
35 cm, 13 3/4"

CORYLLOS
57123-35
35 cm, 13 3/4"

Rippenscheren, Sternumscheren
Rib Shears, Sternum Scissors
Costótomos, Tijeras de esternón
Costotomi, Forbici per sterno



BETHUNE
57126-34
34 cm, 13 1/2"



SAUERBRUCH
57131-26
26 cm, 10 1/4"



GIERTZ-STILLE
57137-27
27 cm, 10 1/2"



SCHUMACHER
57138-21
21 cm, 8 1/4"



SAUERBRUCH-FREY
57141-36
36 cm, 14.2"

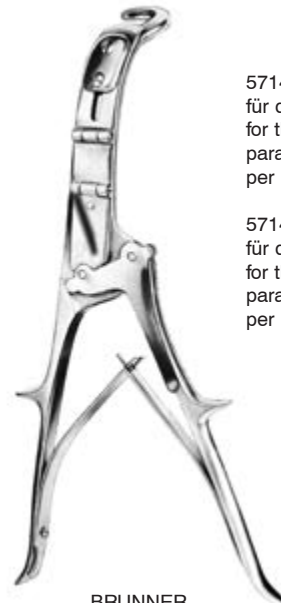

BRUNNER
57146-28 - 57147-28
28 cm, 11"

57146-28
für die rechte Hand
for the right hand
para la mano derecha
per la mano destra

57147-28
für die linke Hand
for the left hand
para la mano izquierda
per la mano sinistra

Rippensperrer
Rib Spreaders
Separadores costales
Divaricatori costali

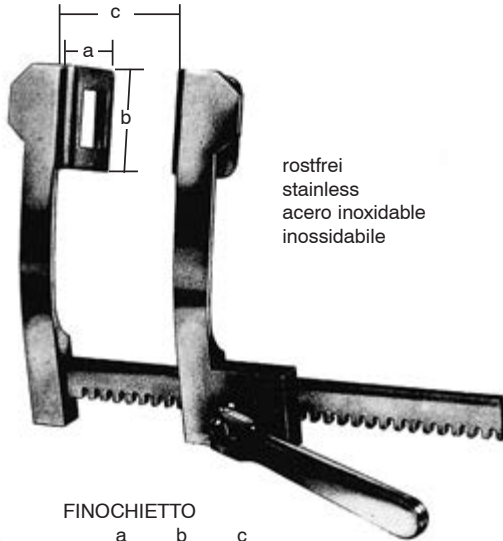

rostfrei
stainless
acero inoxidable
inossidabile

FINOCHIETTO

	a	b	c
	mm	mm	mm
57210-16	38	44	160
57210-20	52	62	200
57210-25	65	85	250

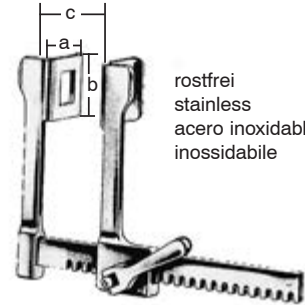

rostfrei
stainless
acero inoxidable
inossidabile

FINOCHIETTO-BABY

	a	b	c
	mm	mm	mm
57214-75	18	20	75

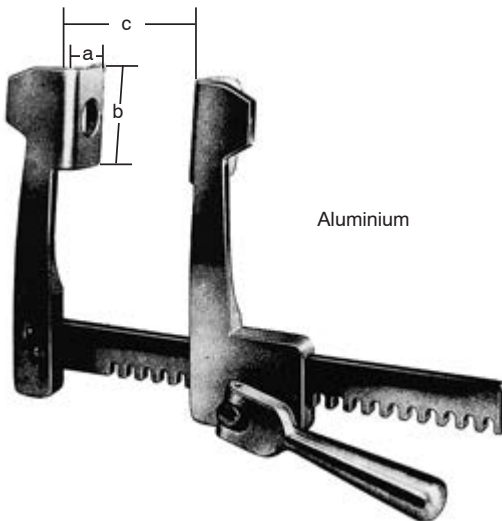

Aluminium

FINOCHIETTO

	a	b	c
	mm	mm	mm
57230-13	38	44	135
57230-17	52	62	175
57230-18	85	65	175

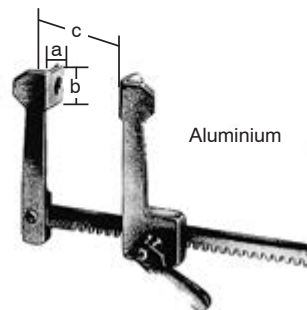

Aluminium

FINOCHIETTO-BABY

	a	b	c
	mm	mm	mm
57234-75	15	15	75

Rippensperrer
Rib Spreaders
Separadores costales
Divaricatori costali

FINOCHIETTO-BURFORD			
	a	b	c
	mm	mm	mm
57236-20	65	62	200
	47	62	
57236-25	65	62	250
	47	62	
57236-30	65	62	300
	47	52	



rostfrei
stainless
acero inoxidable
inossidabile

Erwachsene
Adult Size
para adultos
per adulti

FINOCHIETTO-BURFORD			
	a	b	c
	mm	mm	mm
57242-20	47	62	200
	65	62	
57242-25	47	62	250
	65	62	
57242-30	47	62	300
	65	62	



Aluminium

Kinder
Child Size
para niños
per bambini

FINOCHIETTO-BURFORD			
	a	b	c
	mm	mm	mm
57244-13	34	42	135
	48	42	



Aluminium

Rippensperrer
Rib Spreaders
Separadores costales
Divaricatori costali

FINOCHIETTO			
	a	b	c
	mm	mm	mm
57245-13	14	14	120

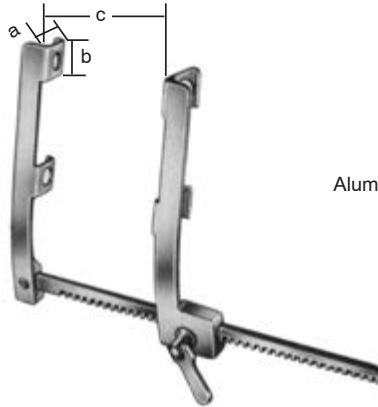

Aluminium

MORSE			
	a	b	c
	mm	mm	mm
57246-16	17	22	160

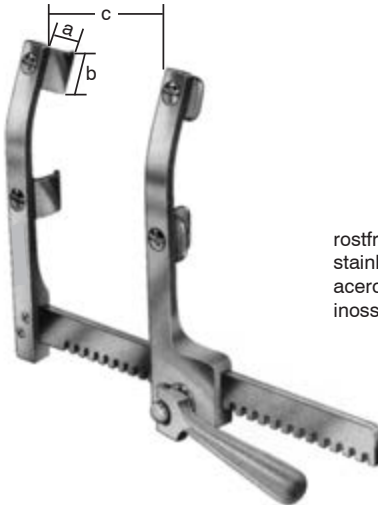

rostfrei
stainless
acero inoxidable
inossidabile

MORSE-FAVALORO			
	a	b	c
	mm	mm	mm
57246-21	19	27	210



rostfrei
stainless
acero inoxidable
inossidabile

Rippensperrer
Rib Spreaders
Separadores costales
Divaricatori costali

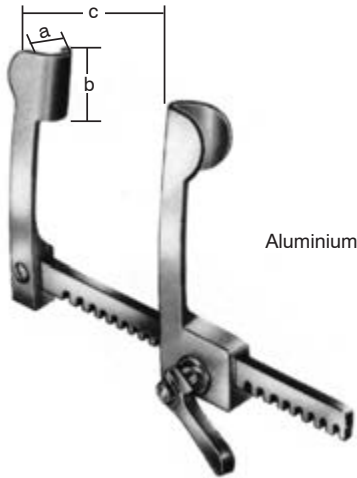

Aluminium

COOLEY-NEONATAL

	a	b	c
	mm	mm	mm
57247-95	12	16	95

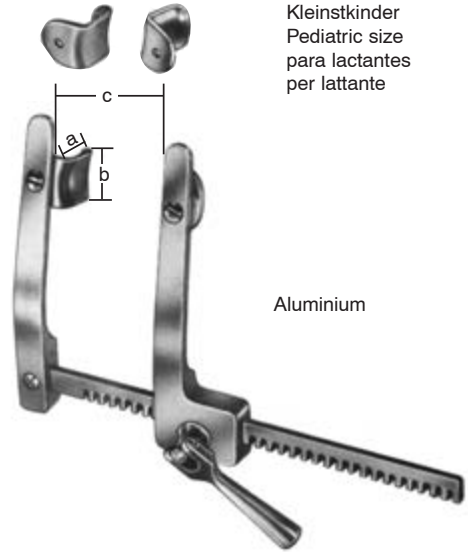

Kleinstkinder
Pediatric size
para lactantes
per lattante

Aluminium

COOLEY

	a	b	c
	mm	mm	mm
57249-01	10	14	90

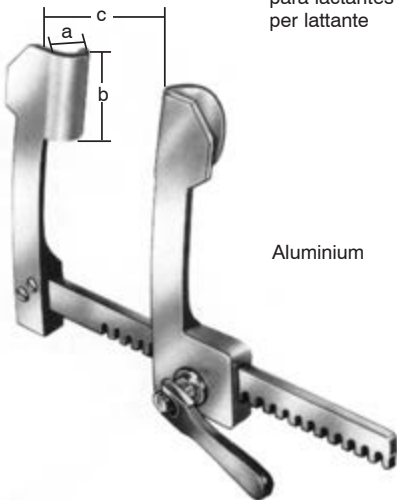

Kleinstkinder
Pediatric size
para lactantes
per lattante

Aluminium

COOLEY

	a	b	c
	mm	mm	mm
57248-14	15	30	140

Rippensperrer
 Rib Spreaders
 Separadores costales
 Divaricatori costali

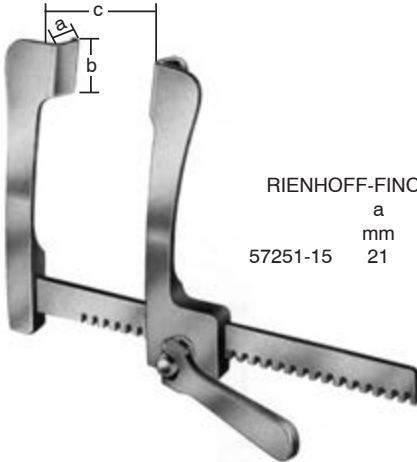

	a	b	c
	mm	mm	mm
57251-15	21	26	150

rostfrei
 stainless
 acero inoxidable
 inossidabile

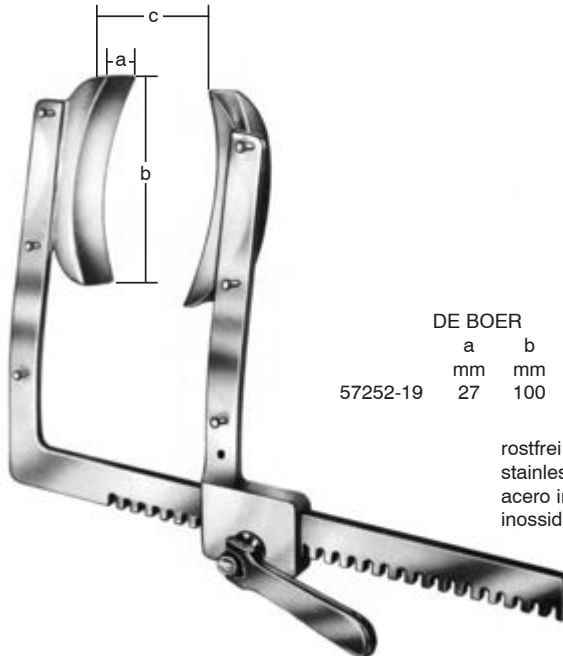

	a	b	c
	mm	mm	mm
57252-19	27	100	190

rostfrei
 stainless
 acero inoxidable
 inossidabile

Rippensperrer
Rib Spreaders
Separadores costales
Divaricatori costali

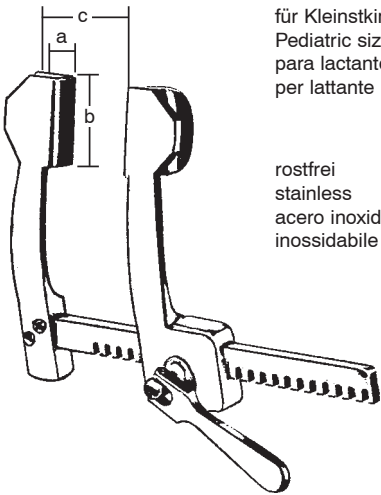

für Kleinstkinder
Pediatric size
para lactantes
per lattante

rostfrei
stainless
acero inoxidable
inossidabile

COOLEY

	a	b	c
	mm	mm	mm
57260-02	16	30	105
57260-03	21	44	150

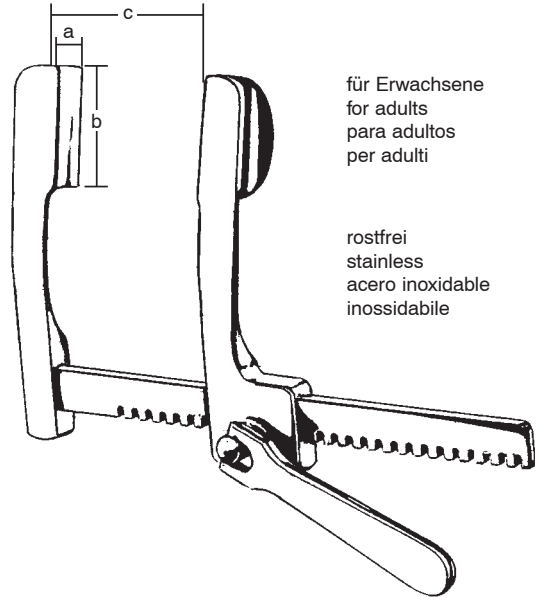

für Erwachsene
for adults
para adultos
per adulti

rostfrei
stainless
acero inoxidable
inossidabile

COOLEY

	a	b	c
	mm	mm	mm
57260-04	37	49	200



rostfrei
stainless
acero inoxidable
inossidabile

HAIGHT

	a	b	c	h
	mm	mm	mm	mm
57260-06	30	30	90	65
57260-09	30	30	90	90



rostfrei
stainless
acero inoxidable
inossidabile

TUFFIER

	a	b	c
	mm	mm	mm
57264-16	50	45	165

Sternum-Sperrer
Sternum Retractors

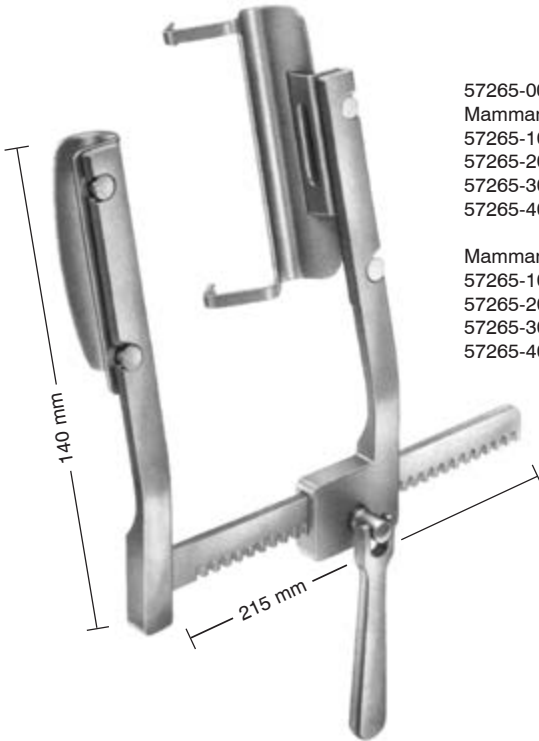

57265-00

Mammaria Sperrer, komplett bestehend aus:

57265-10 Sperrer allein

57265-20 Mammariablatt, komplett mit Aufnahmeblatt links und rechts

57265-30 1 Paar Sternumblätter 30x100 mm

57265-40 1 Paar Sternumblätter 40x100 mm

Mammaria spreader, complete consisting of:

57265-10 Retractor only

57265-20 Mammariablade complete with holding blades left and right

57265-30 1 pair of sternum blades 30x100 mm

57265-40 1 pair of sternum blades 40x100 mm



57265-20

Mammariablatt, komplett
Mammariablade, complete



57265-30

Sternumblätter 30x100 mm
Sternum blades 30x100 mm



57265-40

Sternumblätter 40x100 mm
Sternum blades 40x100 mm

Laminektomie-Sperrer
Laminectomy-Retractor
Separadores para laminectomía
Divaricatori Laminectomia

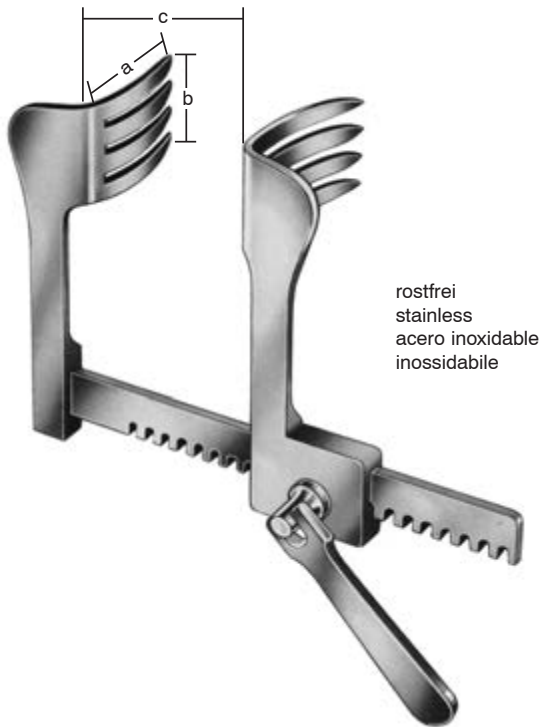

CHERRY

	a	b	c
	mm	mm	mm
57266-13	44	70	135

Thoraxsperrer
Thoracic retractor
Separador torácico
Divaricatore per il torace



MERCEDES compl.
57270-00

57270-80
Sperrer allein
Retractor only
Separador solo
Divaricatore solo

rostfrei
stainless
acero inoxidable
inossidabile

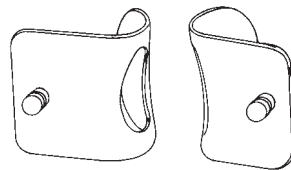

57270-65
42x65 mm

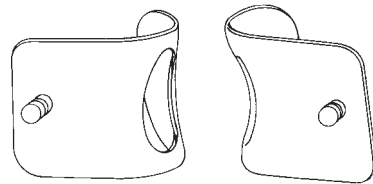

57270-75
75x75 mm

Rippenkontraktoren
 Rib Contractors
 Aproximadores para costillas
 Approssimatori costali



SELLORS
 57280-19
 20 cm, 8"



BAILEY-BABY
 57283-14
 14 cm, 5 1/2"



BAILEY
 57284-16
 16 cm, 6 1/4"

kurze Klauen
 short claws
 garras cortas
 pinze corte



BAILEY-GIBBON
 57286-16
 16 cm, 6 1/4"

lange Klauen
 long claws
 garras largas
 pinze lunghe

Lungenspatel
Lung Spatulas
Espátulas pulmonares
Spatole per polmone



57288-30
30 cm, 11 ³/₄"

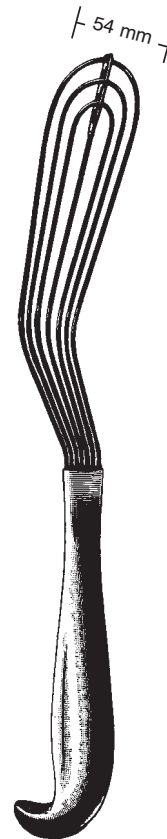

ALLISON
57289-32
32 cm, 12 ³/₄"

Lungenfaßzange, Bronchusklemmen
 Lung Grasping Forceps, Bronchus Forceps
 Pinzas para coger el pulmón, Pinzas clamps bronquiales
 Pinze per afferrare il polmone, Pinze per bronchi

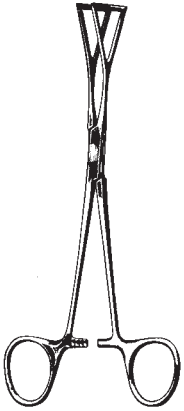

LOVELACE
 57290-20
 20 cm, 8"

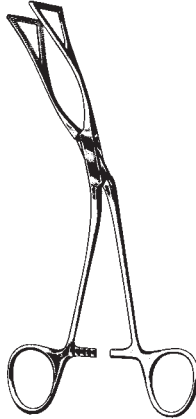

LOVELACE
 57291-20
 20 cm, 8"



HARRINGTON
 57301-30
 30,5 cm, 12"

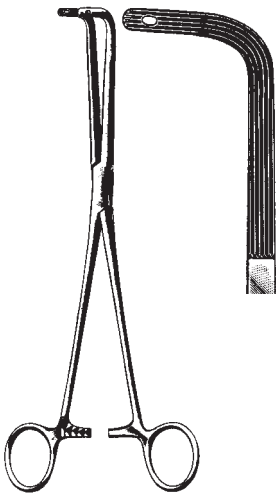

FINOCIETTO
 57307-24
 24 cm, 9 1/2"

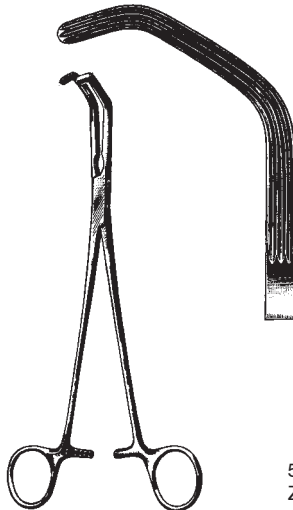

PRICE-THOMAS
 57309-22
 22 cm, 8 3/4"

57311-22
 Zähne links
 tooth left
 dientes izquierda
 denti sinistro



PRICE-THOMAS
 22 cm, 8 3/4"

57313-22
 Zähne rechts
 tooth right
 dientes derecha
 denti destro

Bronchusklemmen, Gefäßklemmen
 Bronchus Forceps, Blood Vessel Clamps
 Pinzas clamps bronquiales, Pinzas-clamps para vasos
 Pinze per bronchi, Pinze cardiovascolari

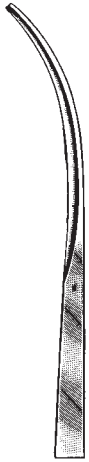

57321-23

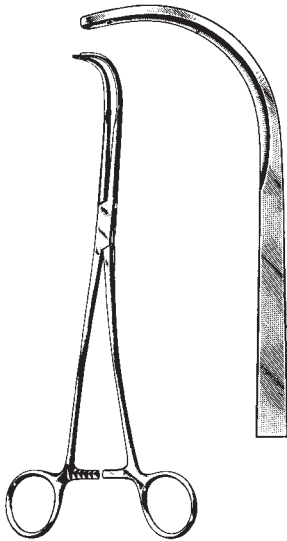

SEMB
 23 cm, 9"

57323-23

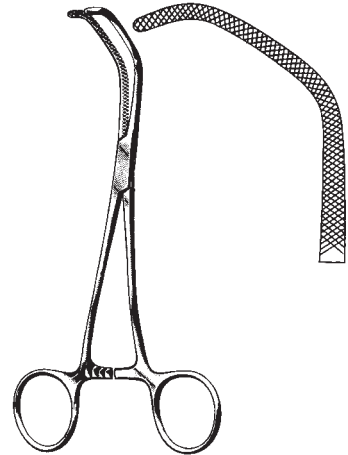

SATINSKY
 57325-15
 15 cm, 6"

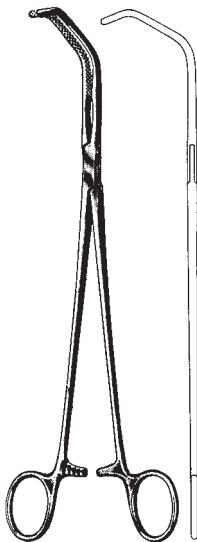

SATINSKY
 57327-26 - 57329-26
 26 cm, 10 1/4"

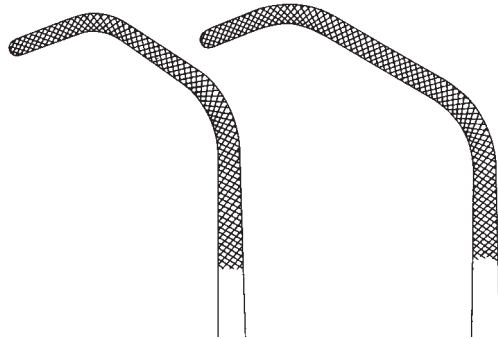
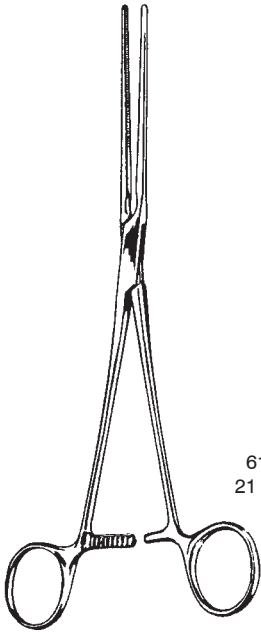

Fig. 1 57327-26

Fig. 2 57329-26

Coarctations-Klemmen
 Coarctation clamps
 Pinzas clamps para coartación
 Pinza per coartazione



POTTS
 61000-21 - 61000-22



61000-21
 21 cm, 8 1/4"



61000-22
 22 cm, 8 3/4"

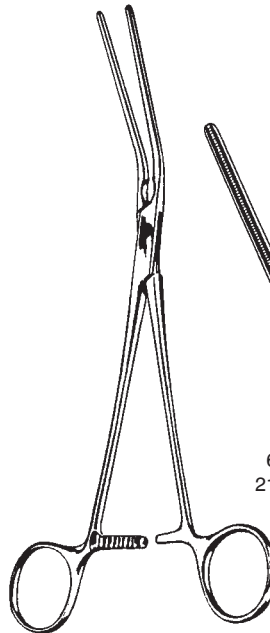

POTTS
 61001-21 - 61001-22



61001-21
 21 cm, 8 1/4"

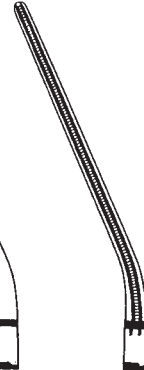

61001-22
 22 cm, 8 3/4"

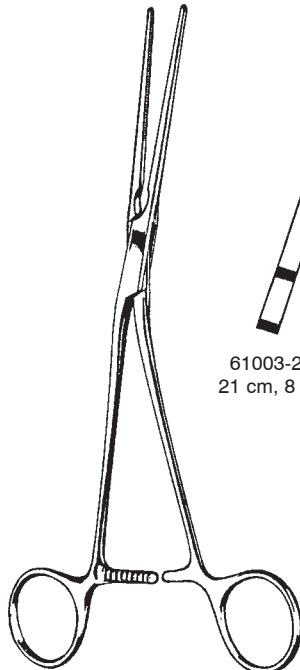

POTTS
 61003-21 - 61003-22



61003-21
 21 cm, 8 1/4"

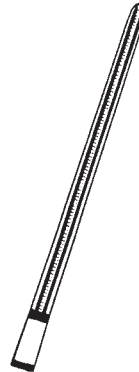

61003-22
 22 cm, 8 3/4"



Atrauma

Anastomosen-Klemmen, Präparier- und Ligaturklemmen
Anastomosis clamps, Dissecting and ligature forceps
Pinzas clamps para anastomosis, Pinzas para preparaciones y ligaduras
Pinze per anastomosi, Pinze per preparazioni e legature

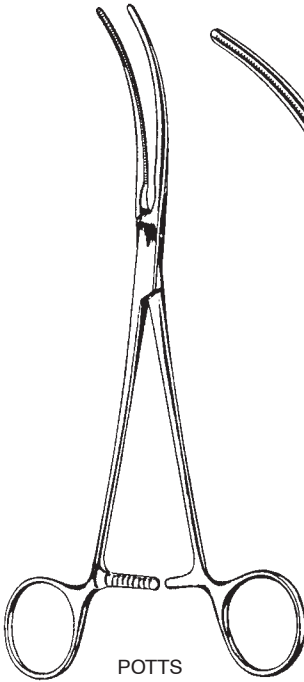

POTTS
61005-22
22 cm, 8 3/4"

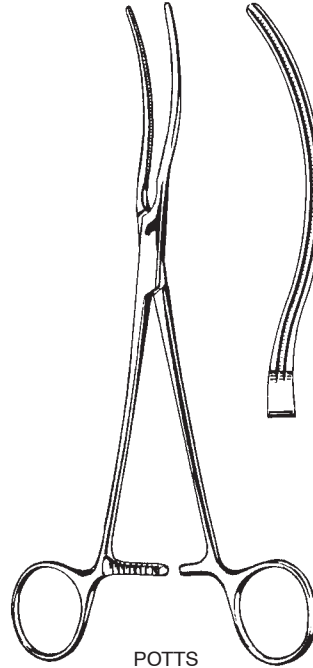

POTTS
61007-22
22 cm, 8 3/4"

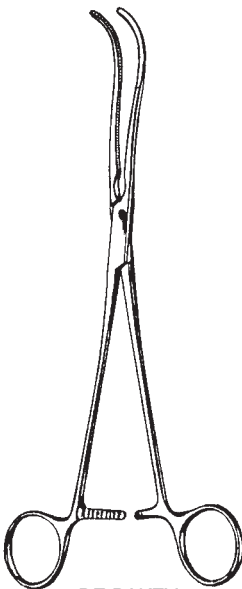

DE BAKEY
61008-19 - 61008-23



61008-19
19 cm, 7 1/2"



61008-23
23 cm, 9"

Peripheral-Gefäßklemmen
 Peripheral vascular clamps
 Pinzas-clamps para vasos periféricos
 Pinze vascolari periferici

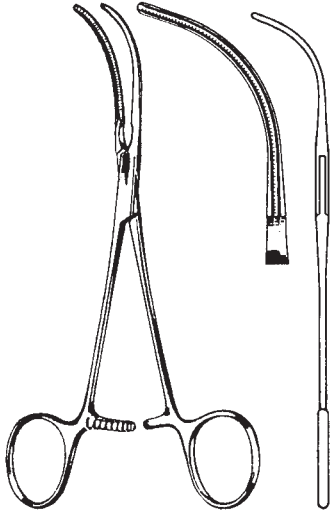

DE BAKEY
 61009-16
 16 cm, 6 1/4"



DALE
 61010-18
 18 cm, 7"

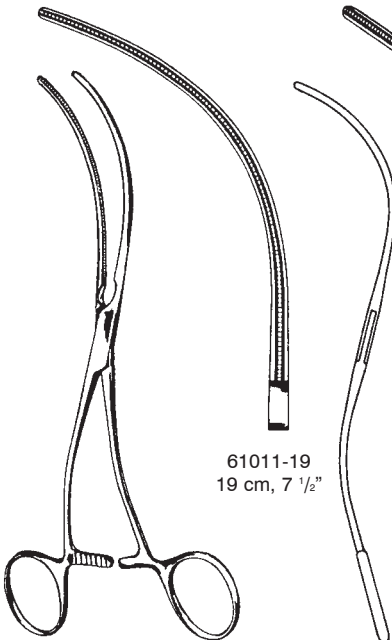

61011-19
 19 cm, 7 1/2"

DE BAKEY
 61011-19 - 61011-20

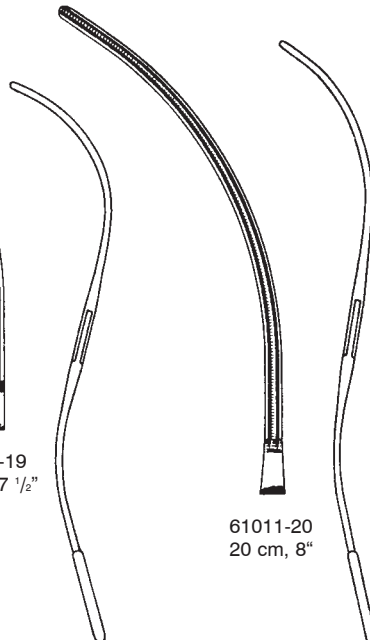

61011-20
 20 cm, 8"

Atrauma

Peripheral-Gefäßklemmen
Peripheral vascular clamps
Pinzas-clamps para vasos periféricos
Pinze vascolari periferici

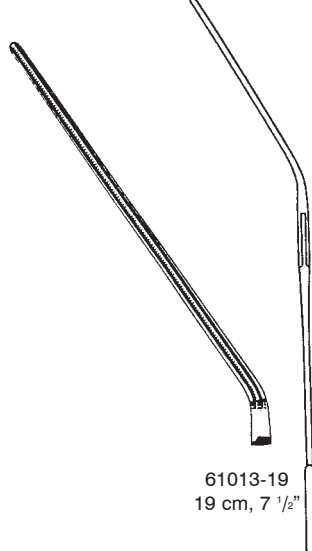
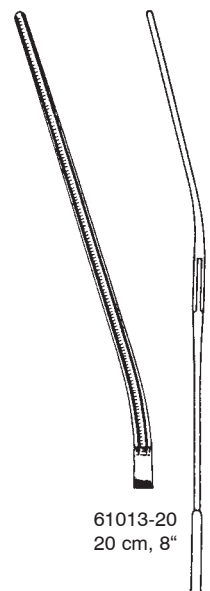

DALE

61012-17
17,5 cm, 7"61012-18
18 cm, 7"61012-19
18,5 cm, 7 1/4"LELAND-JONES
61013-18 - 61013-2061013-18
18 cm, 7"61013-19
19 cm, 7 1/2"61013-20
20 cm, 8"

Mehrzweck-Gefäßklemme
Multi Purpose Vascular Clamps
Pinzas vasculares de usos multiples
Pinze vascolari universali

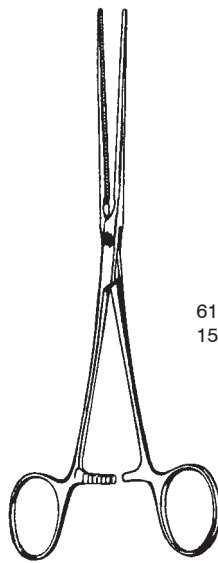

BAINBRIDGE
61014-15 - 61014-18



61014-15
15 cm, 6"



61014-18
18 cm, 7"

Atrauma

Mehrzweck-Gefäßklemme
Multi Purpose Vascular Clamps
Pinzas vasculares de usos multiples
Pinze vascolari universali

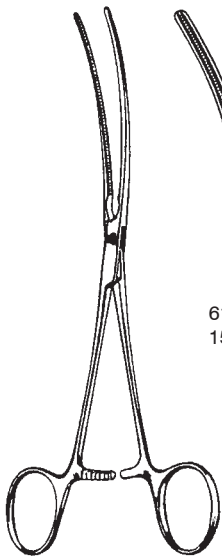

61015-15
15 cm, 6"

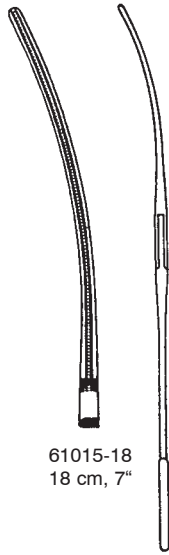

61015-18
18 cm, 7"

BAINBRIDGE
61015-15 - 61015-18

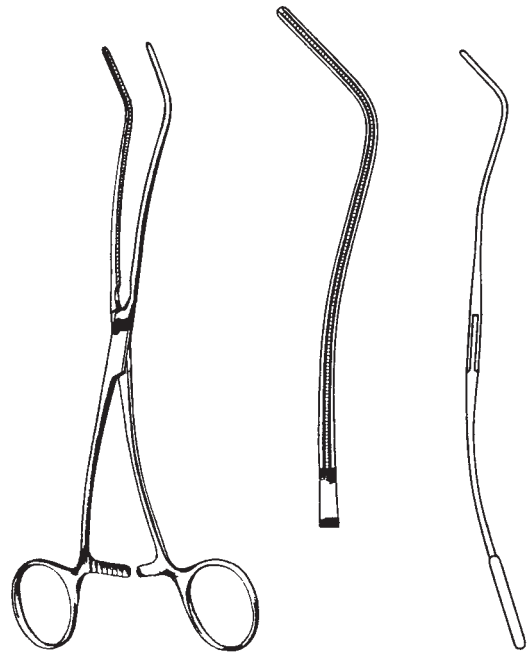

DE BAKEY
61016-20
20 cm, 8"

Aorta-Aneurysmaklemmen
Aortic aneurysm clamps
Pinzas-clamps para aneurisma de la aorta
Pinze per aneurisma aorta

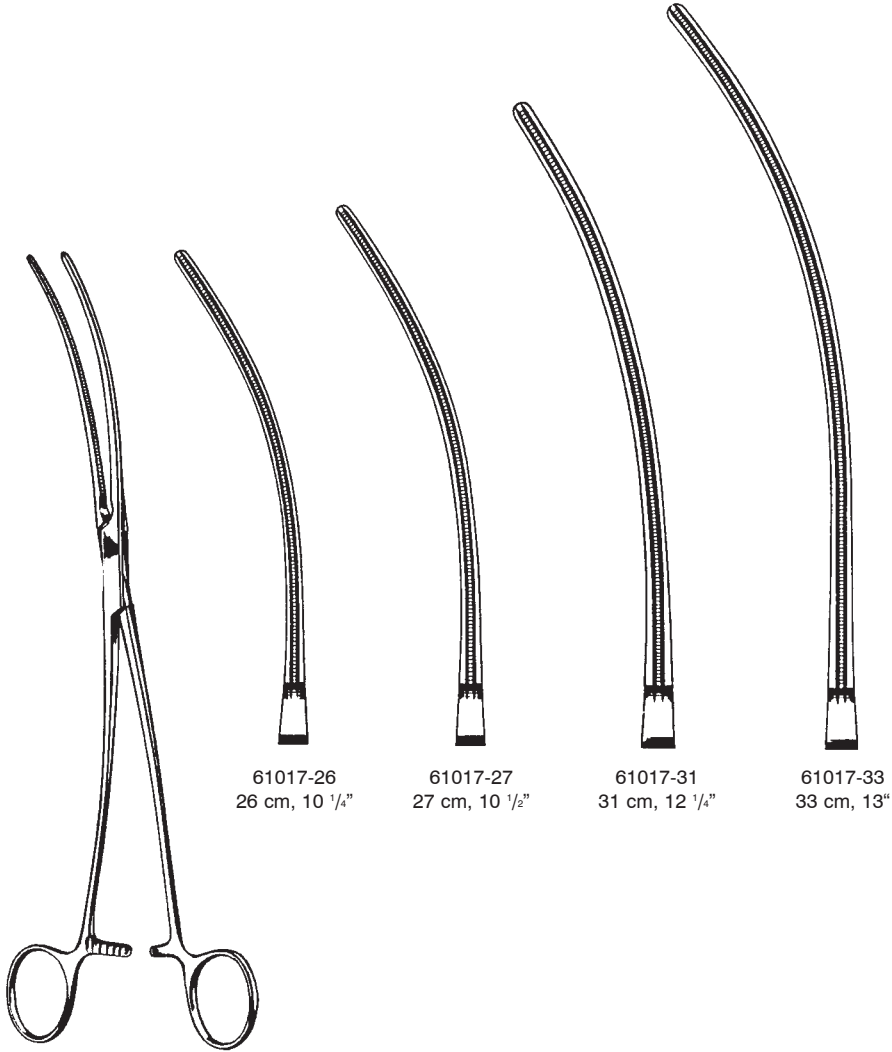

61017-26
26 cm, 10 1/4"

61017-27
27 cm, 10 1/2"

61017-31
31 cm, 12 1/4"

61017-33
33 cm, 13"

DE BAKEY
61017-26 - 61017-33

Atrauma

Aorta-Aneurysmaklemmen
Aortic aneurysm clamps
Pinzas-clamps para aneurisma de la aorta
Pinze per aneurisma aorta



DE BAKEY
61018-28
28 cm, 11"

Aorta-Aneurysmaklemmen
Aortic aneurysm clamps
Pinzas-clamps para aneurisma de la aorta
Pinze per aneurisma aorta

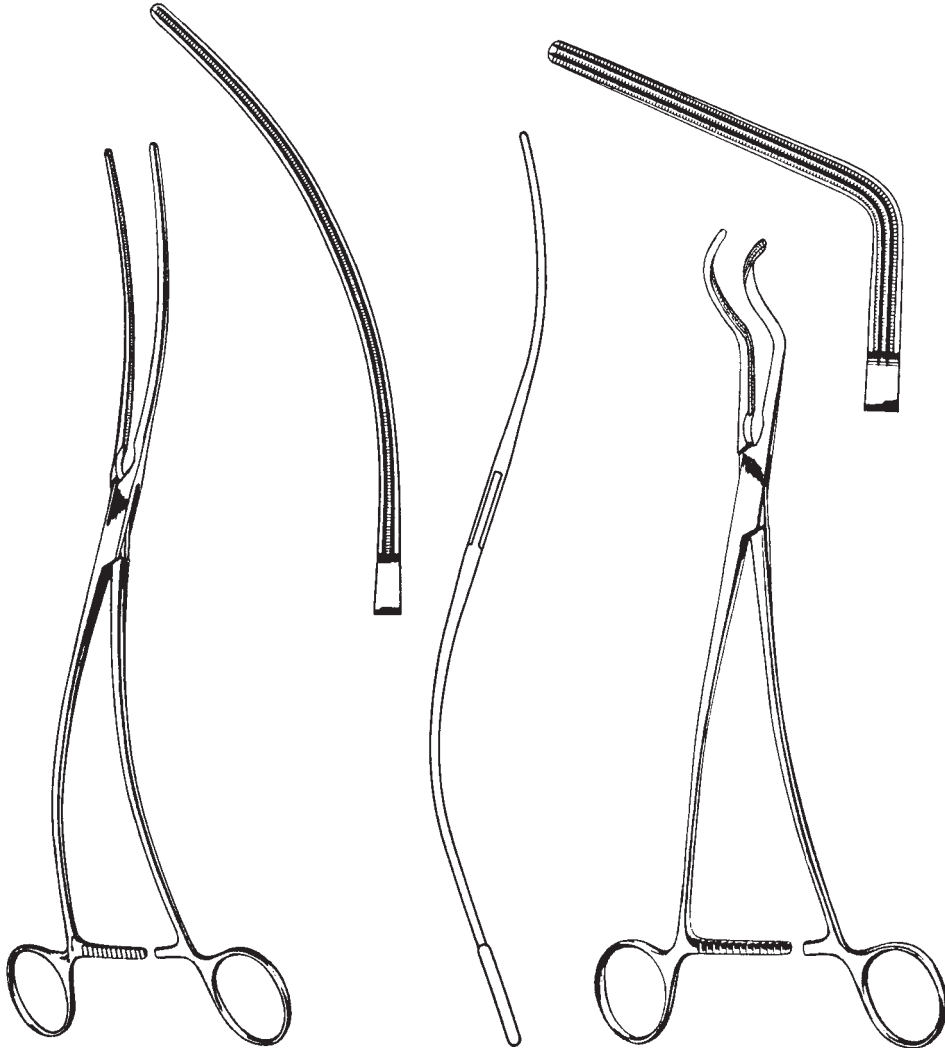

DE BAKEY
61019-30
30 cm, 11 ³/₄"

DE BAKEY
61020-27
27 cm, 10 ¹/₂"

Atrauma

Präparier- und Ligaturklemme
Dissecting- and Ligature clamp
Pinzas clamps para disección, ligaduras
Pinze per dissezione, legature

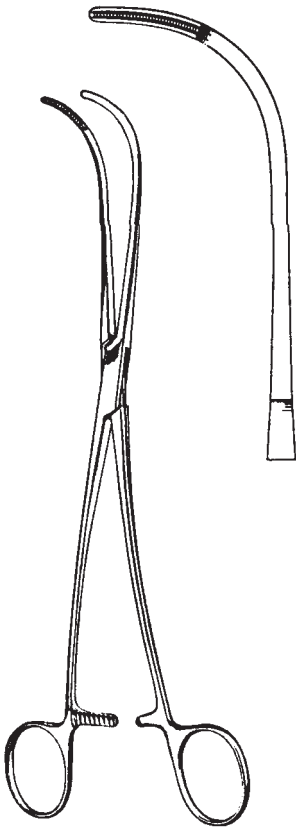

DE BAKEY
61021-24
24 cm, 9 1/2"



61022-01
25 cm, 10"

61022-02
24,5 cm, 9 3/4"

DE BAKEY-RUMEL

Ligaturklemmen
Ligature clamps
Pinzas clamps para ligaduras
Pinze per legature

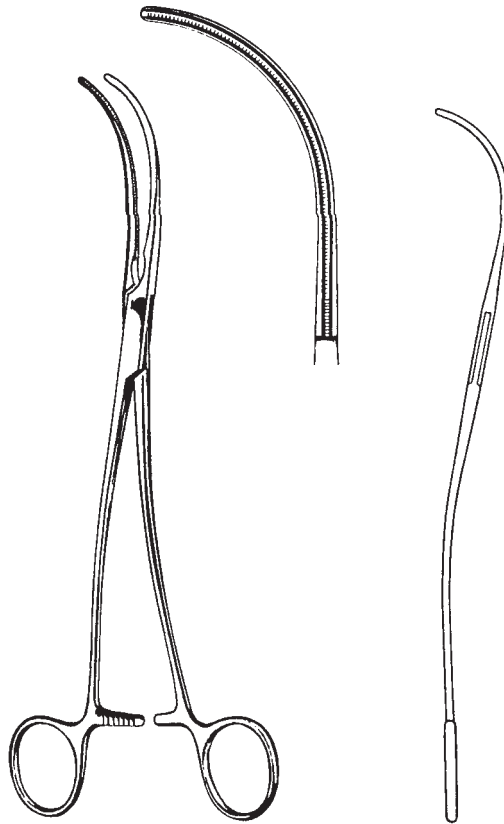

DE BAKEY
61022-24
24 cm, 9 1/2"

Atrauma

Präparier- und Ligaturklemmen
Dissecting- and Ligature clamps
Pinza para disección y ligatura
Pinze per dissezione e legature



DE BAKEY-MIXTER
61022-28
28,5 cm, 11 1/4"

Ligaturklemme
Ligature clamp
Pinzas clamps para ligaduras
Pinze per legature

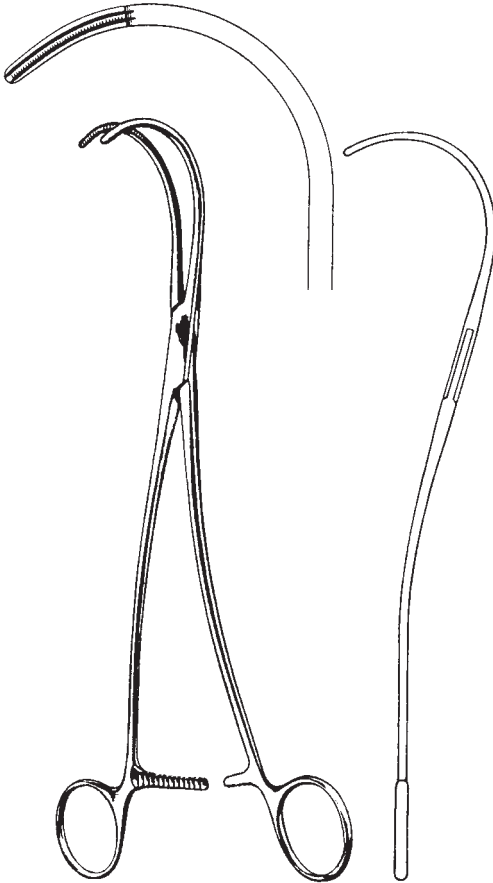

DE BAKEY
61023-25
25 cm, 10"

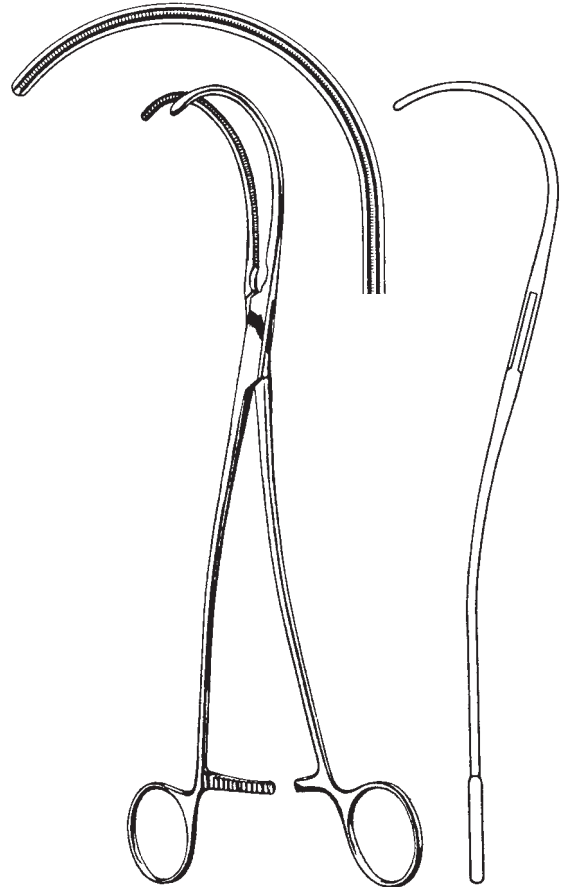

DE BAKEY
61023-26
26 cm, 10 1/4"

Atrauma

Aortaklemmen
Aortic clamps
Pinzas-clamps para la aorta
Pinze per aorta

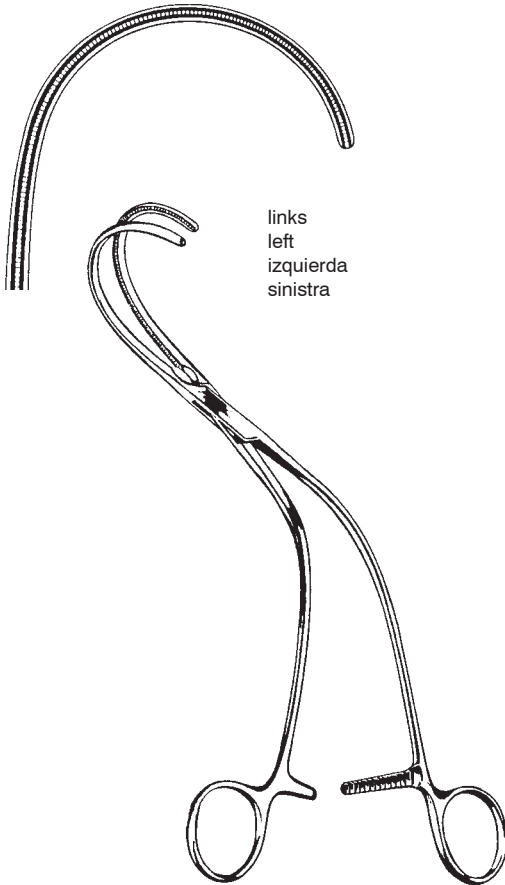

links
left
izquierda
sinistra

WEBER
61024-01
26 cm, 10 1/4"

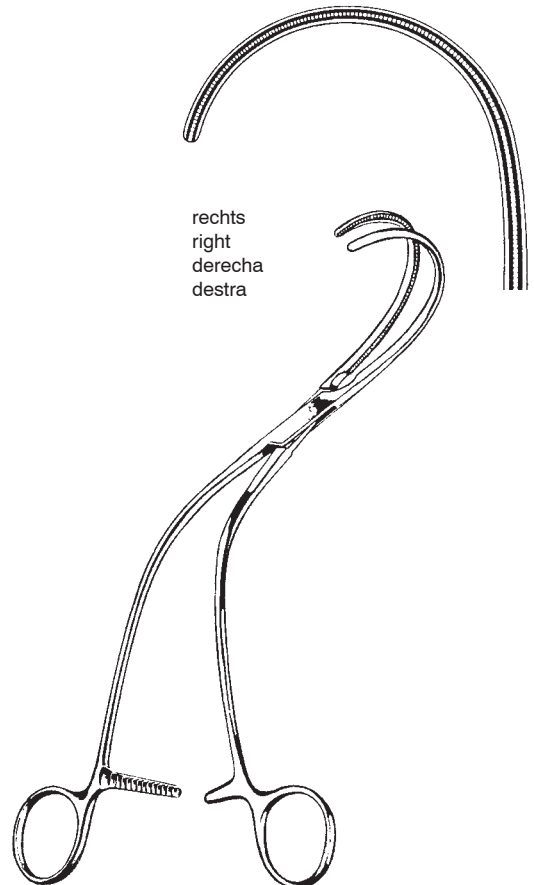

rechts
right
derecha
destra

WEBER
61024-02
26 cm, 10 1/4"

Aortaklemmen
Aortic clamps
Pinzas-clamps para la aorta
Pinze per aorta



WYLIE
61024-24
24 cm, 9 1/2"

Atrauma

Aortaklemmen
Aortic clamps
Pinzas-clamps para la aorta
Pinze per aorta



WYLIE
61024-27
27 cm, 10 1/2"

Tangentialklemmen
 Tangential occlusion clamps
 Pinzas-clamps para oclusión tangencial
 Pinze per occlusione tangenziale

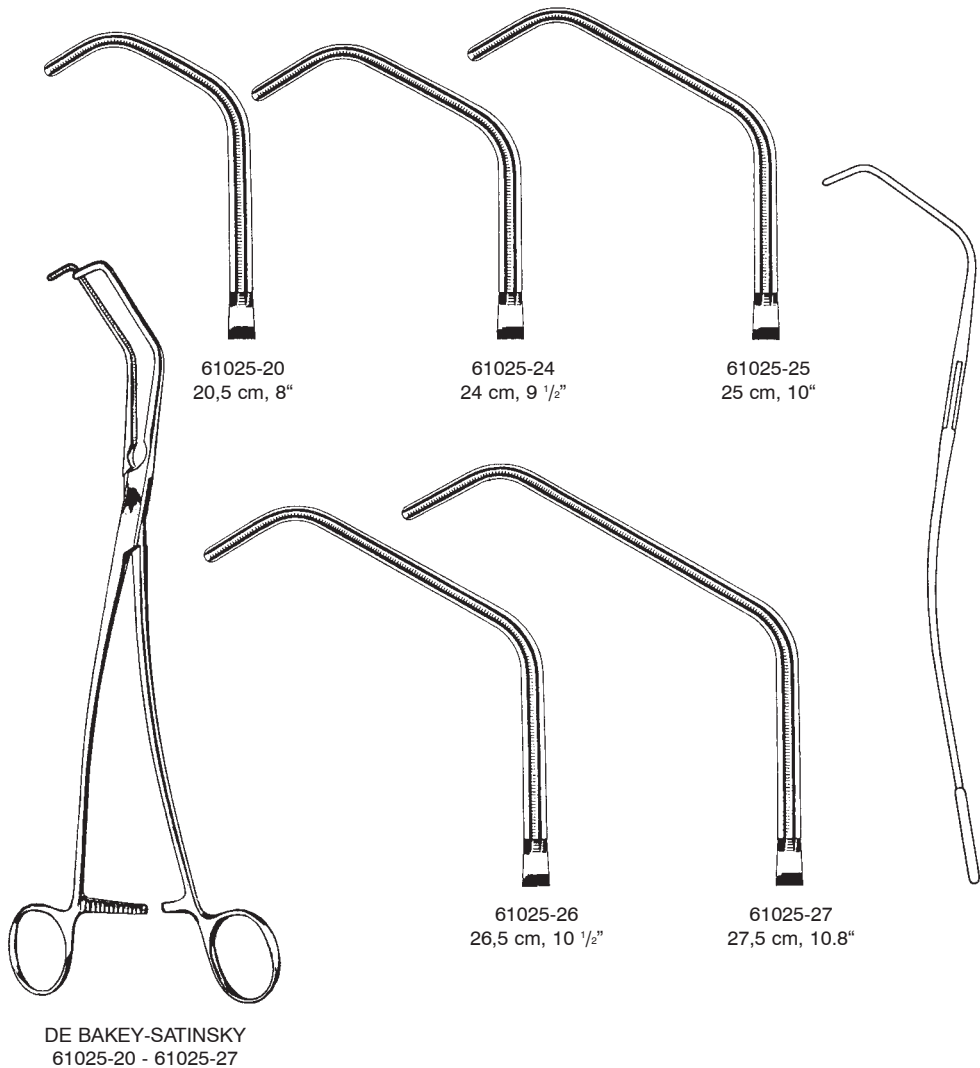

Atrauma

Aurikelklemmen
Auricle clamps
Pinza-clamps auriculares
Pinza auricula



HARKEN
61026-01 - 61026-04



61026-01
24 cm, 9 1/2"

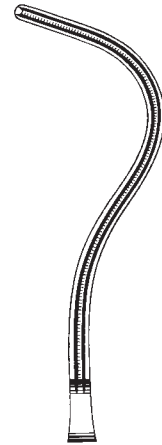

61026-02
24 cm, 9 1/2"

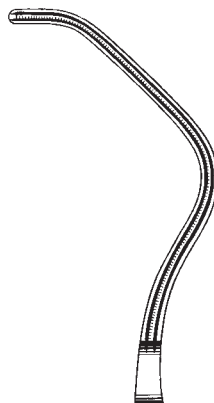

61026-03
24 cm, 9 1/2"



61026-04
24 cm, 9 1/2"

Bronchusklemmen
 Bronchus clamp
 Pinzas-clamps bronquiales
 Pinze per bronchi

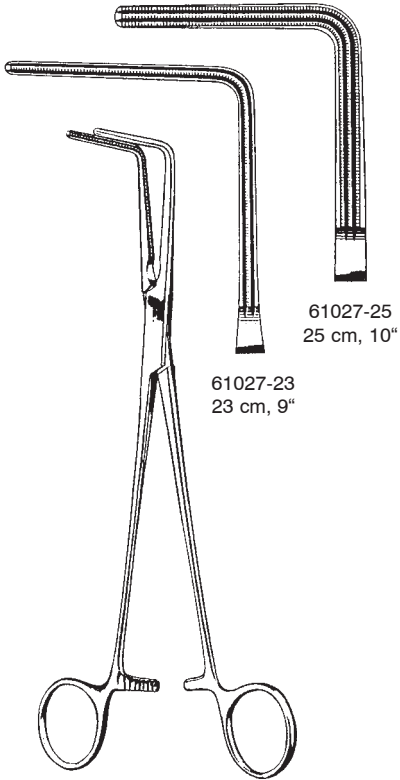

LEES
 61027-23 - 61027-25

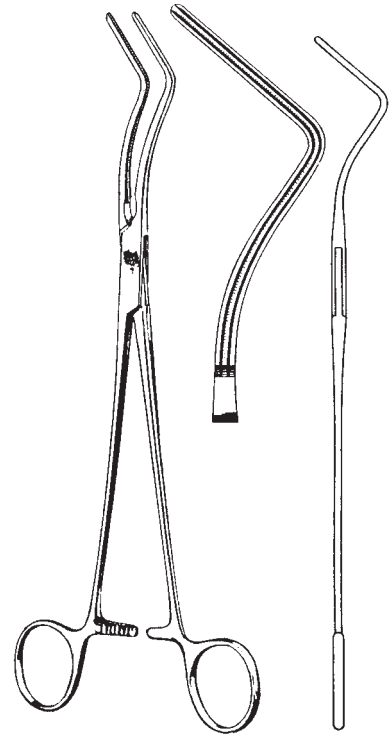

LEES
 61029-25
 25 cm, 10"

Atrauma

Aorta-Anastomosenklemmen
Aortic anastomosis Clamps
Pinzas-clamps para anastomosis
Pinze anastomosi aorta

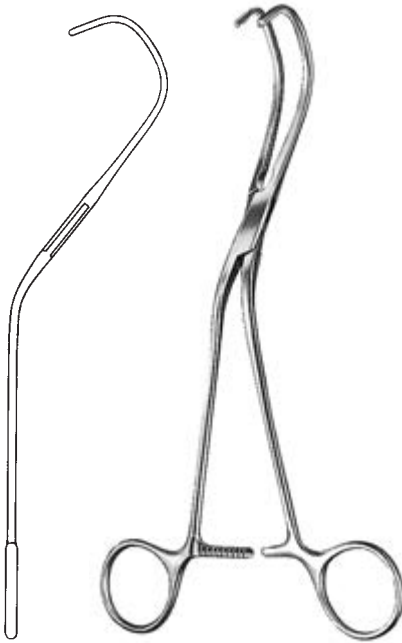

LAMBERT-KAY
21 cm, 8 1/4"
61030-21 - 61030-22



61030-22

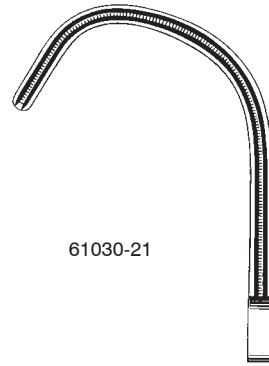

61030-21

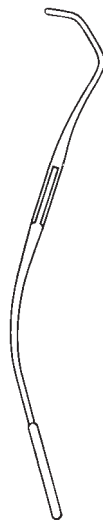

DE BAKEY
61031-17
17 cm, 6 3/4"

Aorta- und Aneurysmaklemme
 Aortic- and Aneurysm Clamps
 Pinzas aórticas y para aneurisma
 Pinze per aorta e per aneurisma

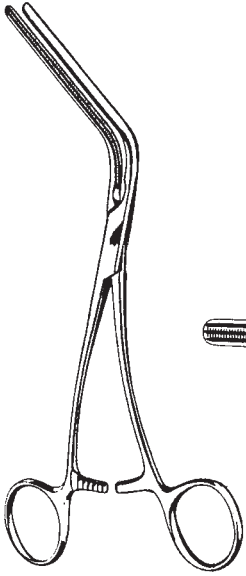

MORRIS-DE BAKEY
 61032-18 - 61032-25

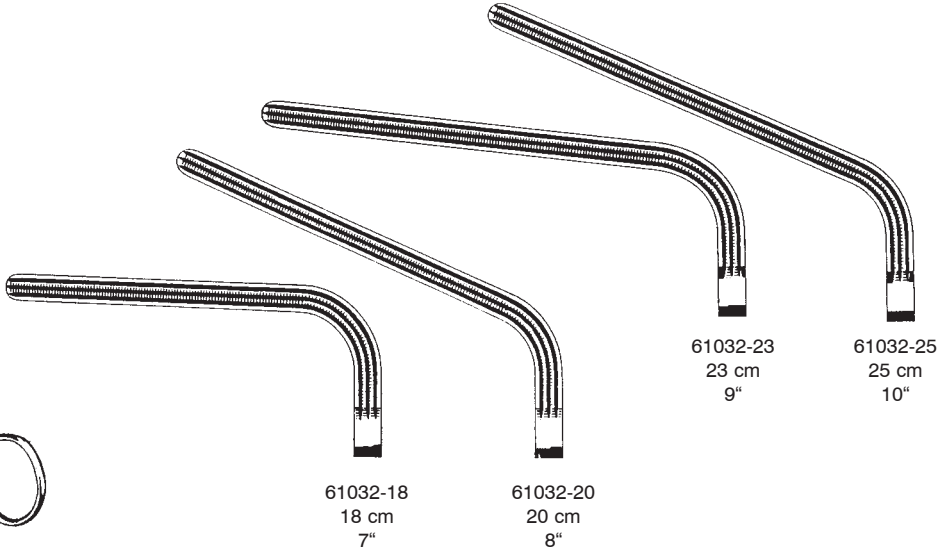

DE BAKEY-BAHNSON
 61033-23 - 61033-25

Atrauma

Mehrzweck-Gefäßklemme
 Multi purpose Vascular Clamps
 Pinzas vasculares de usos multiples
 Pinze vascolari universali

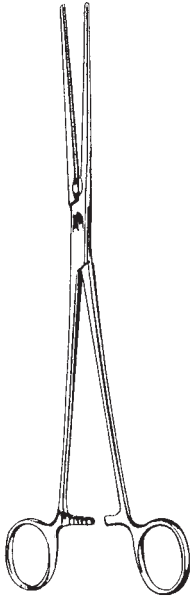

DE BAKEY
 61034-21 - 61034-31



61034-21
 21,5 cm
 8 1/2"



61034-23
 23 cm
 9"



61034-27
 27 cm
 10 1/2"



61034-31
 31,5 cm
 12 1/2"

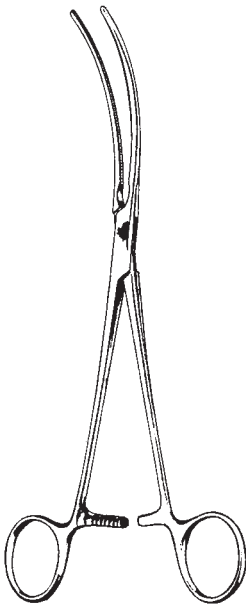

DE BAKEY
 61035-21 - 61035-31



61035-21
 21,5 cm
 8 1/2"



61035-23
 23 cm
 9"



61035-27
 27 cm
 10 1/2"



61035-31
 31 cm
 12 1/4"

Mehrzweck-Gefäßklemme
 Multi purpose Vascular Clamps
 Pinzas vasculares de usos multiples
 Pinze vascolari universali

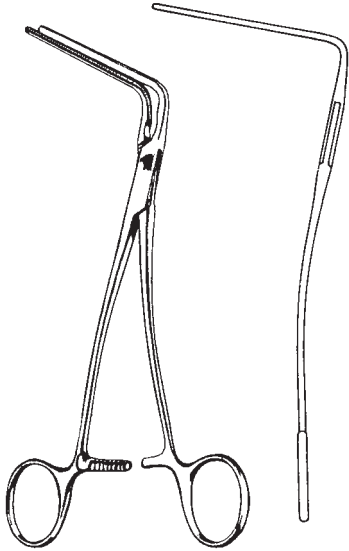

DE BAKEY
 61036-18 - 61036-27

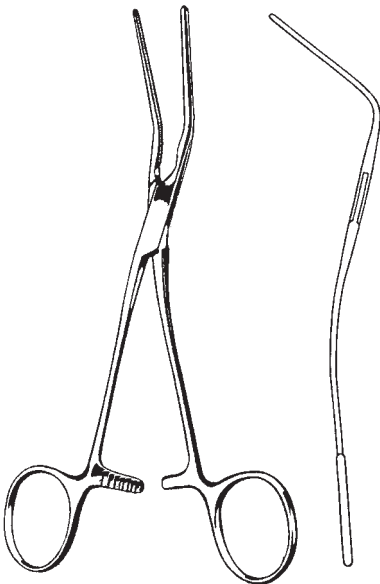
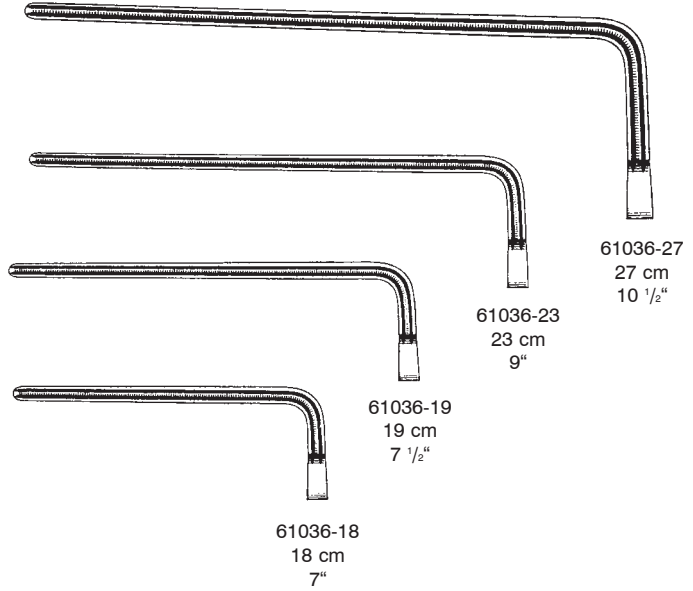

DE BAKEY
 61037-20 - 61037-29

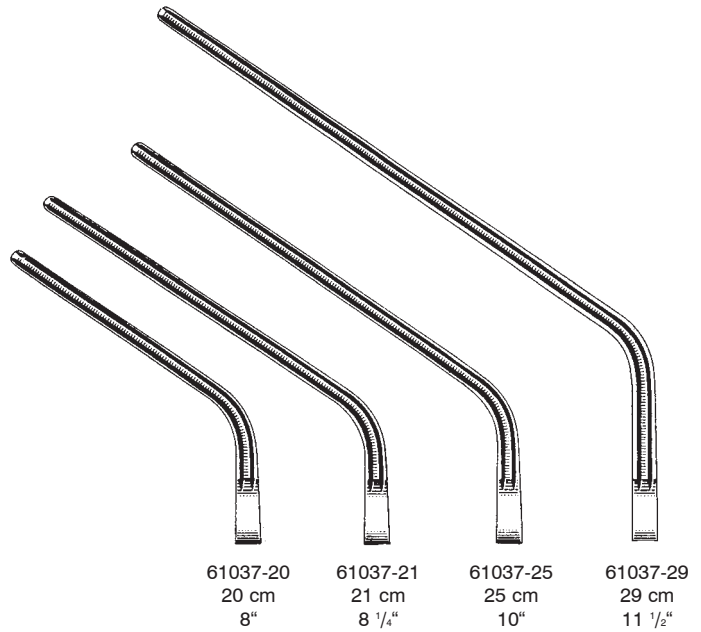

Atrauma

Arterienklemmen
Hemostatic forceps
Pinzas hemostáticas
Pinze emostatiche

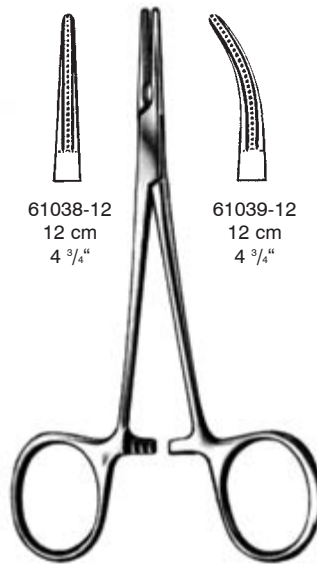

61038-12
12 cm
4 3/4"

61039-12
12 cm
4 3/4"

DE BAKEY-MOSQUITO
61038-12 - 61039-12

Mehrzweck-Gefäßklemme
 Multi purpose Vascular Clamps
 Pinzas vasculares de usos multiples
 Pinze vascolari universali

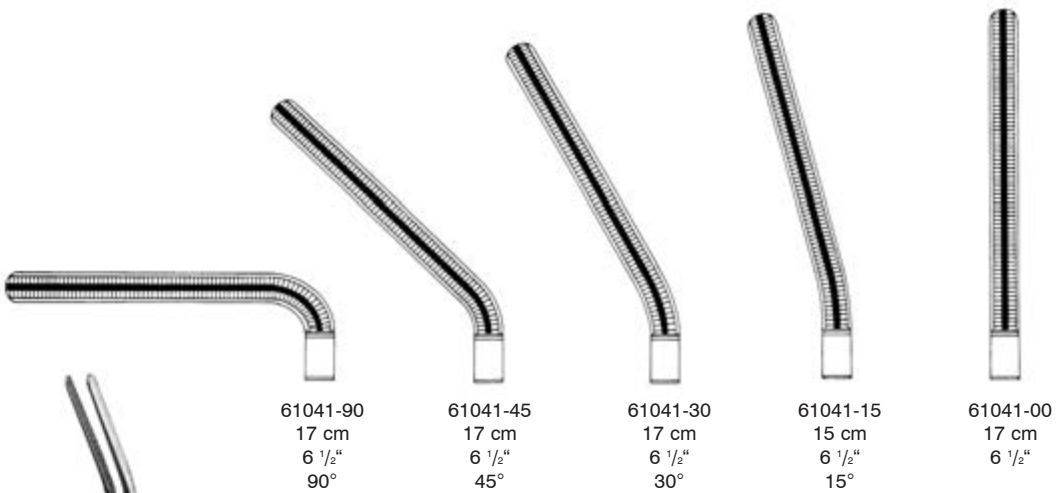
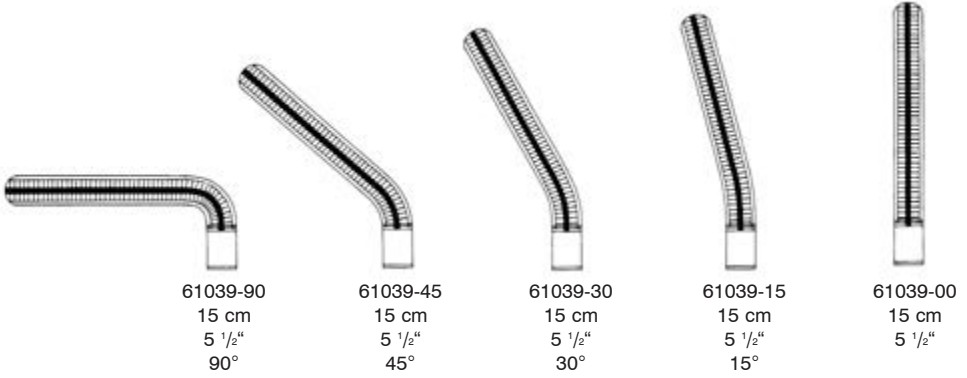

DARDIK

Aortaklemme, Katheterklemme
 Aortic Clamps, Catheter Clamps
 Pinzas-clamps para aorta, Pinzas para catéteres
 Pinze per aorta, Pinze per cateteri

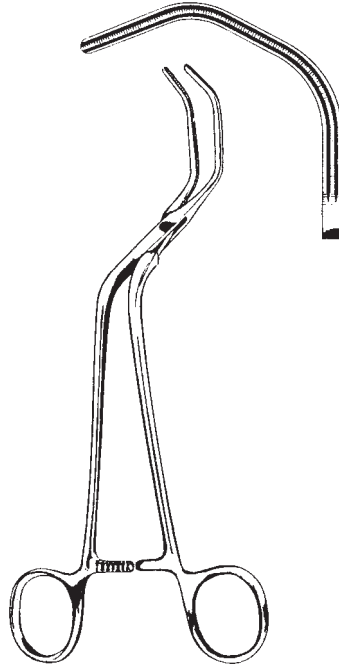

DIETRICH
 61040-21 21 cm, 8 1/4"

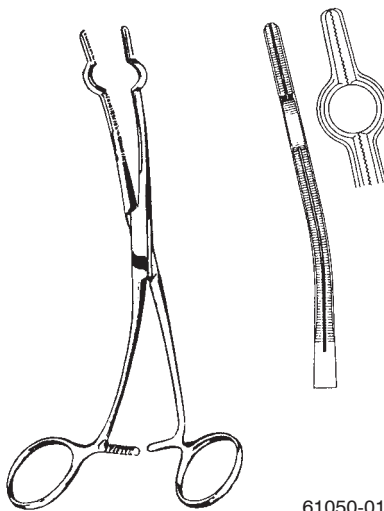

COOLEY
 61050-01 - 61050-07

Charrière (French)	Länge Length Largo Lungo cm		
24	16	6 1/4"	61050-01
26	16	6 1/4"	61050-02
28	20	8"	61050-03
30	20	8"	61050-04
32	20	8"	61050-05
36	20	8"	61050-07

61050-01 - 61050-02
 für Kinder
 for children
 para niños
 per bambini

61050-03 - 61050-07
 für Erwachsene
 for adults
 para adultos
 per adulti

Atrauma

Carotis-Shuntklemmen
Carotid Shunt Clamps
Pinzas para shunt carótido
Pinze per carotide



JAVID
61045-18
17,5 cm, 6.9"



JAVID
61046-19
18 cm, 7"

Arterienklemmen
Haemostatic Forceps
Pinzas hemostáticas
Pinze emostatiche

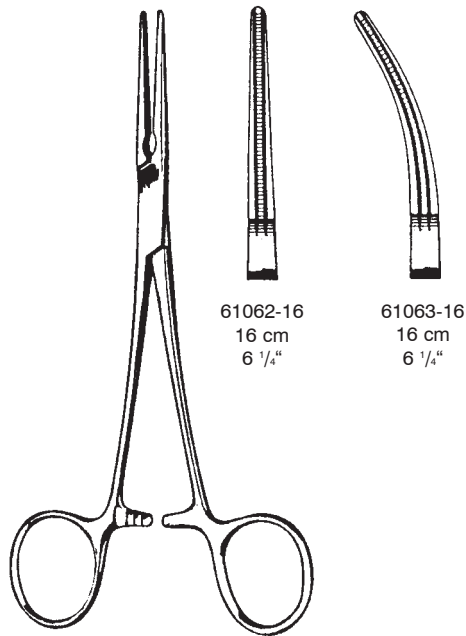

DE BAKEY-RANKIN
61062-16 - 61063-16

Atrauma

Arterienklemmen
Haemostatic Forceps
Pinzas hemostáticas
Pinze emostatiche

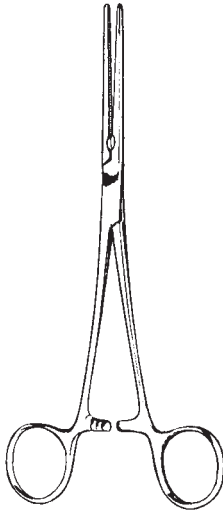

DE BAKEY-PEAN
61138-14 - 61138-20



61138-14
14 cm
5 1/2"



61138-16
16 cm
6 1/4"



61138-18
18 cm
7"



61138-20
20 cm
8"

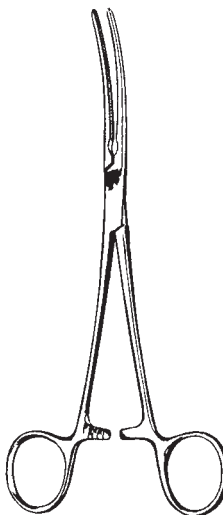

DE BAKEY-PEAN
61139-14 - 61139-20



61139-14
14 cm
5 1/2"



61139-16
16 cm
6 1/4"



61139-18
18 cm
7"



61139-20
20 cm
8"

Mehrzweck-Gefäßklemmen
 Multi purpose Vascular Clamps
 Pinzas vasculares de usos múltiples
 Pinze vascolari universali

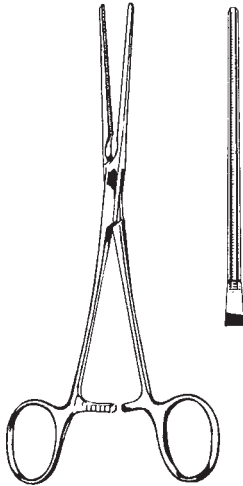

DE BAKEY
 61140-17
 17 cm, 6 ³/₄"

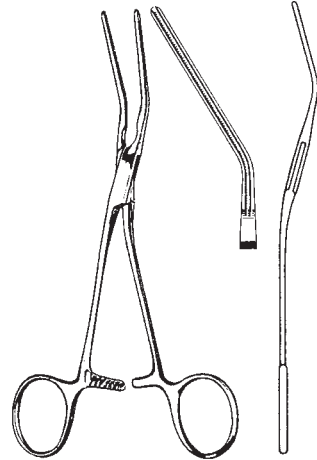

DE BAKEY
 61141-16
 16 cm, 6 ¹/₄"

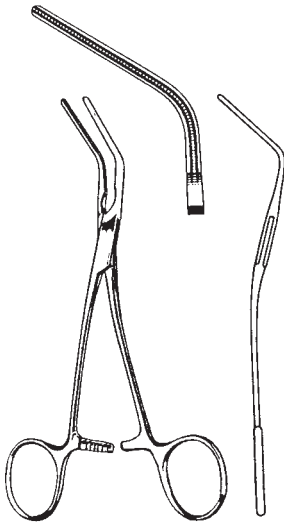

DE BAKEY
 61143-15
 15 cm, 6"

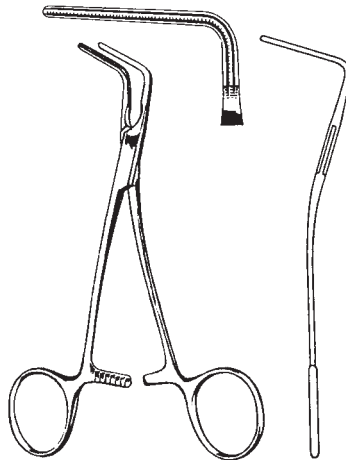

DE BAKEY
 61145-15
 15 cm, 6"

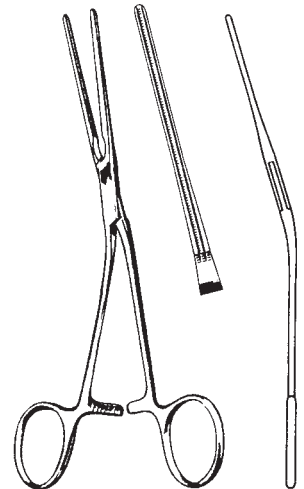

DE BAKEY
 61147-17
 17 cm, 6 ³/₄"

Atrauma

Mehrzweck-Gefäßklemmen, Anastomosenklemmen
 Multi purpose Vascular Clamps, Anastomosis Clamps
 Pinzas vasculares de usos múltiples, Pinzas para anastomosis
 Pinze vascolari universali, Pinze per anastomosi

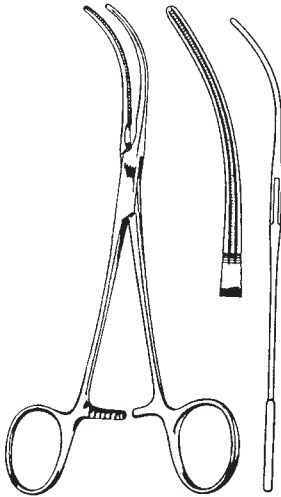

GLOVER
 61149-17
 17 cm, 6 3/4"

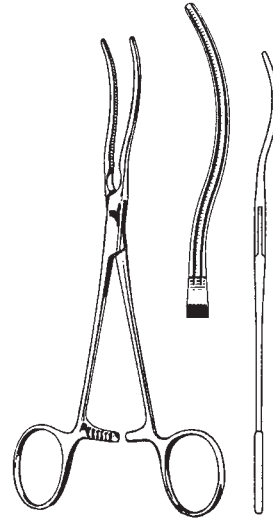

GLOVER
 61151-17
 17 cm, 6 3/4"

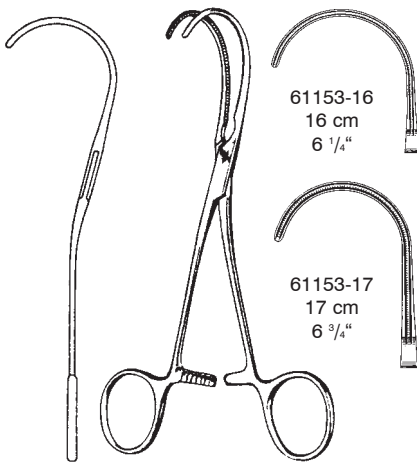

DE BAKEY
 61153-16 - 61153-17

61153-16
 16 cm
 6 1/4"

61153-17
 17 cm
 6 3/4"

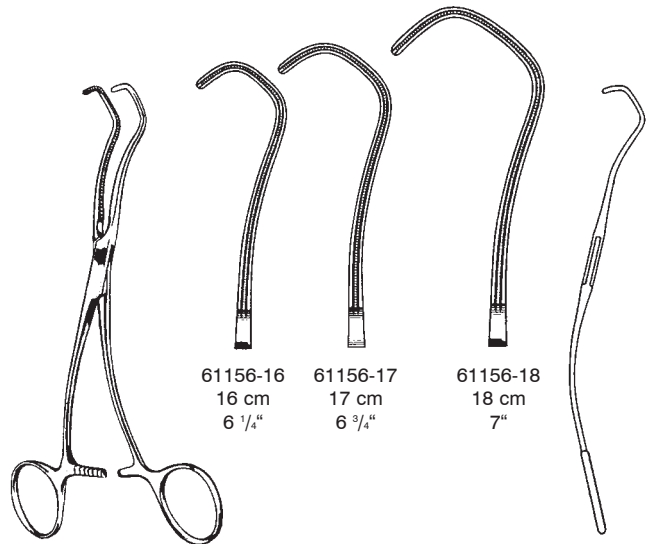

DERRA
 61156-16 - 61156-18

61156-16
 16 cm
 6 1/4"

61156-17
 17 cm
 6 3/4"

61156-18
 18 cm
 7"

Anastomosenklemmen, Kinder-Gefäßklemmen
 Anastomosis Clamps, Pediatric Vascular Clamps
 Pinzas para anastomosis, Pinzas vasculares pediátricas
 Pinze per anastomosi, Pinze vascolari pediatriche

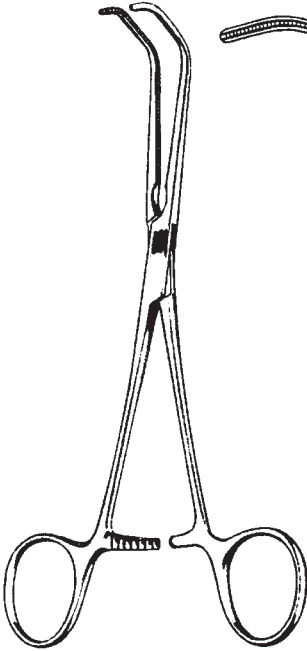

DE BAKEY-BECK
 61157-17 17 cm, 6 $\frac{3}{4}$ "

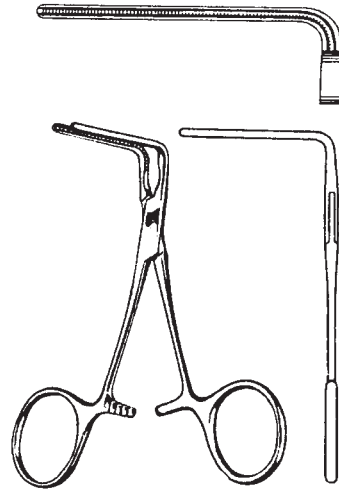

DE BAKEY
 61158-10 10 cm, 4"

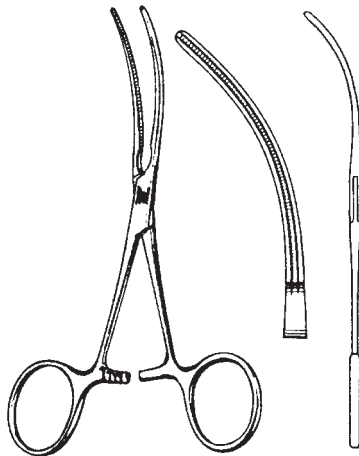

DE BAKEY
 61158-11 11 cm, 4 $\frac{3}{8}$ "

Atrauma

Kinder-Gefäßklemmen, Profundaklemmen
Pediatric Vascular Clamps, Profunda Clamps
Pinzas vasculares pediátricas, Pinzas para la profunda
Pinze vascolari pediatriche, Pinze profunda

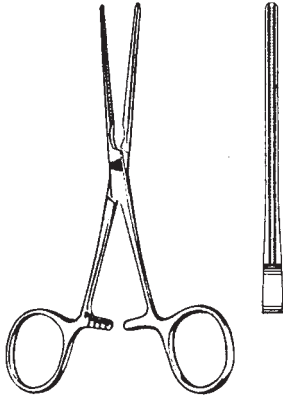

DE BAKEY
61158-12 12 cm, 4 ³/₄"

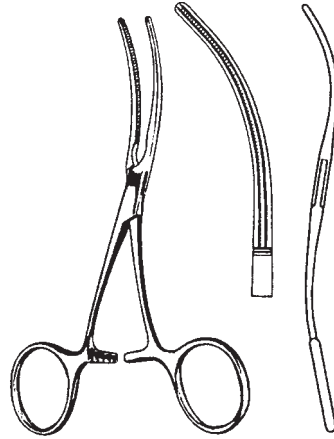

DE BAKEY
61159-12 11,5 cm, 4 ¹/₂"

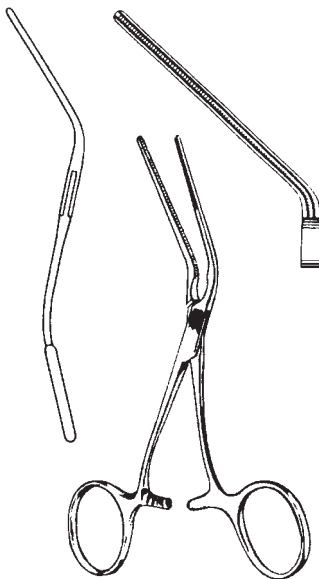

DE BAKEY
61159-13 13 cm, 5 ¹/₈"

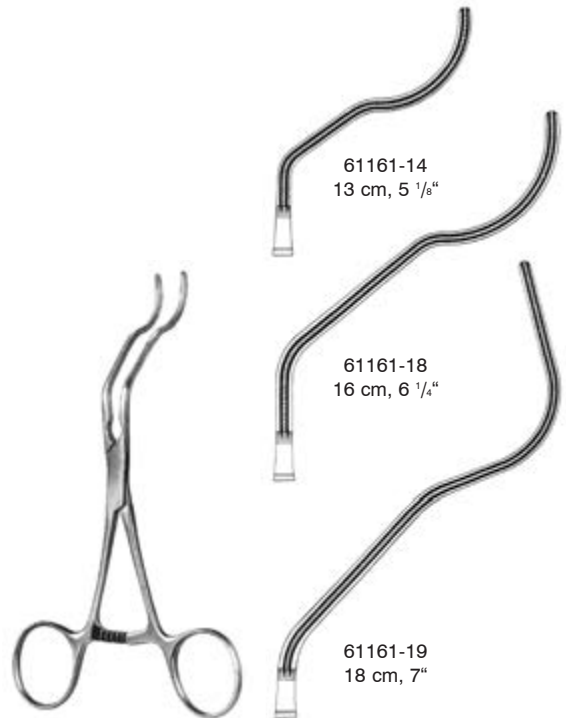

GREGORY

61161-14
13 cm, 5 ¹/₈"

61161-18
16 cm, 6 ¹/₈"

61161-19
18 cm, 7"

Mehrzweck-Gefäßklemmen
 Multi purpose Vascular Clamps
 Pinzas vasculares de usos múltiples
 Pinze vascolari universali

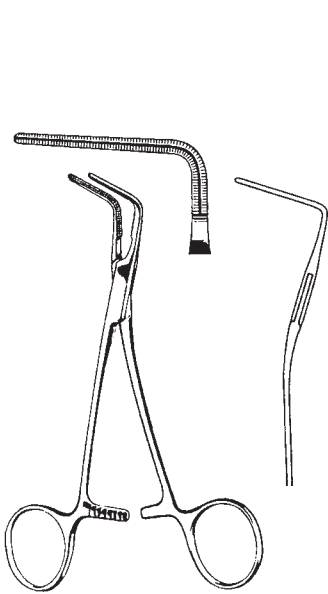

COOLEY
 61172-15
 15 cm, 6"

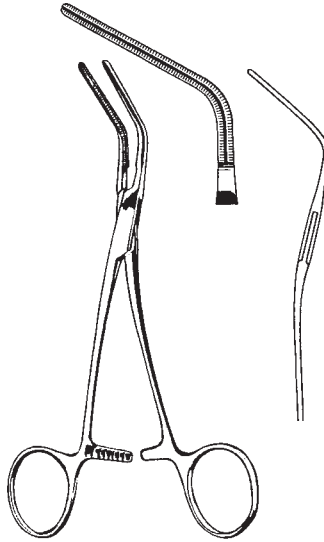

COOLEY
 61173-16
 15,5 cm, 6"

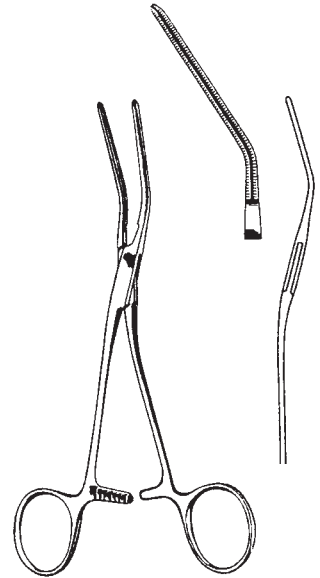

COOLEY
 61174-17
 17 cm, 6 3/4"

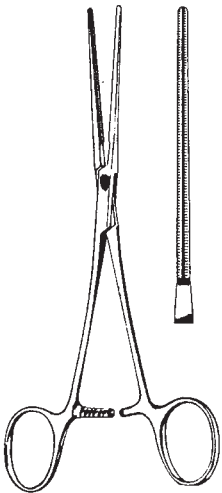

COOLEY
 61175-17
 17 cm, 6 3/4"

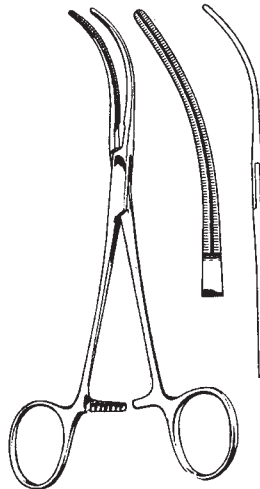

COOLEY
 61176-17
 17 cm, 6 3/4"

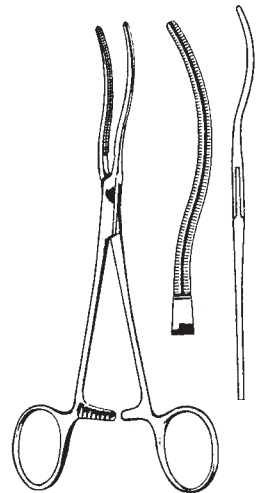

COOLEY
 61177-17
 17 cm, 6 3/4"

Atrauma

Anastomosenklemmen
Anastomosis Clamps
Pinzas para anastomosis
Pinze per anastomosi



COOLEY-DERRA
61178-16 - 61179-18



61178-16
16 cm
6 1/4"



61178-17
17 cm
6 3/4"



61179-18
18 cm
7"



61187-17
17 cm
6 3/4"

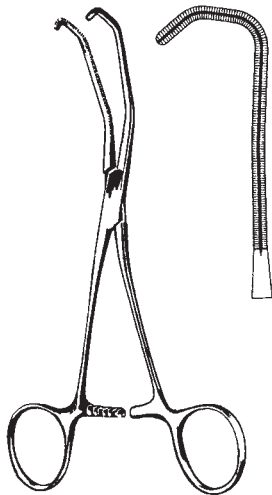

COOLEY
61180-17
17 cm, 6 3/4"



COOLEY
61187-16 - 61187-17

61187-16
16 cm
6 1/4"

Anastomosenklemmen, Mehrzweck-Gefäßklemme

Anastomosis Clamp, Multi purpose Vascular Clamps

Pinza clamp para iliac y anastomosis, Pinzas vasculares de usos multiples

Pinze anastomosi, Pinze vascolari universali

Carotisklemme
Carotid Clamp
Pinza para carótida
Pinza per carotis



COOLEY
61188-20 20 cm, 8"

Iliacaklemme
Iliac Clamp
Pinza para iliaca
Pinza iliaca

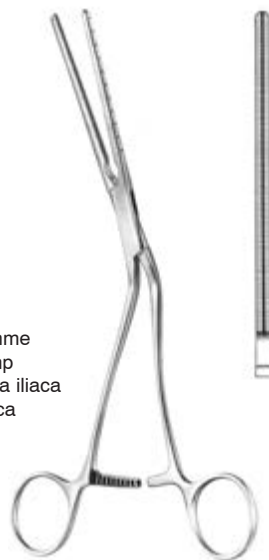

COOLEY
61189-21 21 cm, 8 1/4"



BECK
61190-17 17 cm, 6 3/4"



COOLEY
61191-16 16 cm, 6 1/4"



COOLEY
61192-17 17 cm, 6 3/4"

Atrauma

Anastomosenklemmen
Anastomosis Clamp
Pinza clamp para iliac y anastomosis
Pinze anastomosi

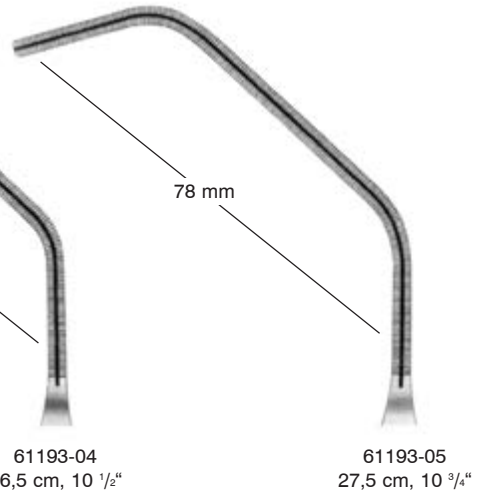
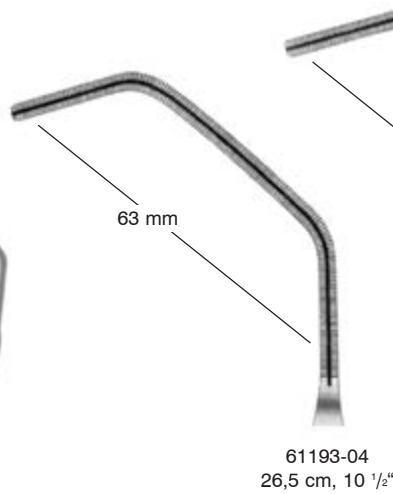
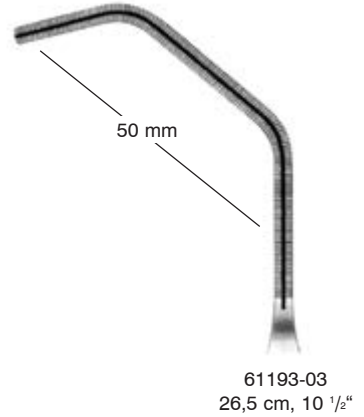
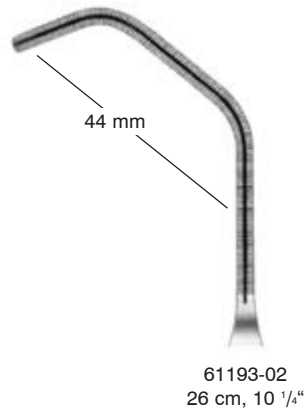
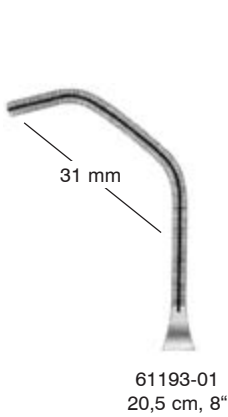

COOLEY

Mehrzweck-Gefäßklemme
Multi purpose Vascular Clamps
Pinzas vasculares de usos multiples
Pinze vascolari universali

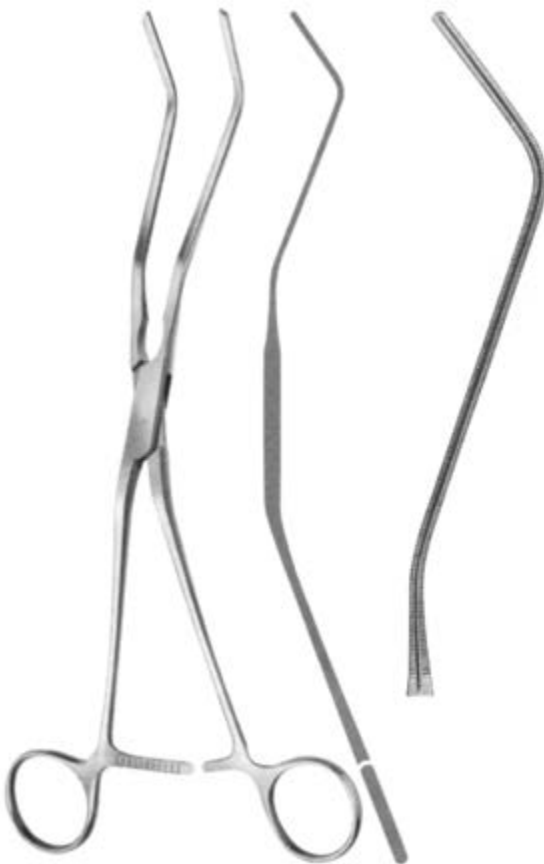

COOLEY
61194-26 26 cm, 10 ³/₄"



COOLEY
61195-28 28,5 cm, 11 ¹/₄"

Atrauma

Aortaklemme
Aortic Clamps
Pinzas aórticas
Pinze per aorta



COOLEY
61195-32 32 cm, 12 3/4"

Anastomosenklemmen
Anastomosis Clamp
Pinza clamp para iliac y anastomosis
Pinze anastomosi



COOLEY
61196-26 26 cm, 10 1/4"

Kinder-Aortaklemme
 Pediatric Aortic Clamps
 Pinza aórticas pediátricas
 Pinze per aorta pediatriche

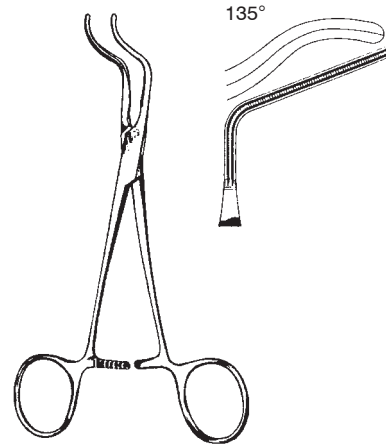

SUBRAMANIAN-MINIATURE
 61259-15 15,5 cm, 6"

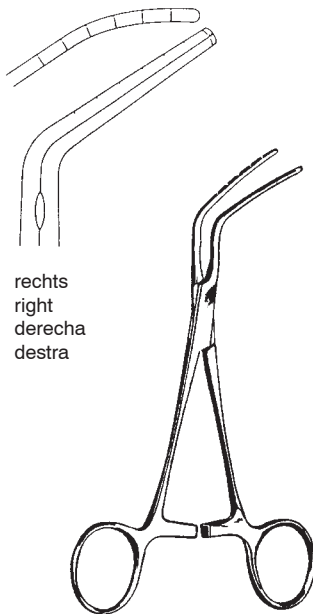

rechts
 right
 derecha
 destra

SUBRAMANIAN
 61261-16 16 cm, 6 1/4"

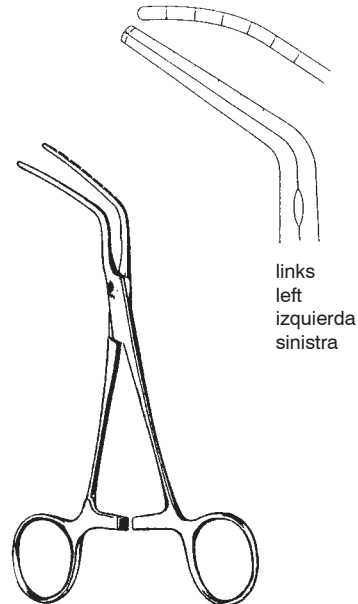

links
 left
 izquierda
 sinistra

SUBRAMANIAN
 61263-16 16 cm, 6 1/4"

Kinder-Gefäßklemmen
 Pediatric Vascular Clamps
 Pinzas vasculares pediátricas
 Pinze vascolari pediatriche

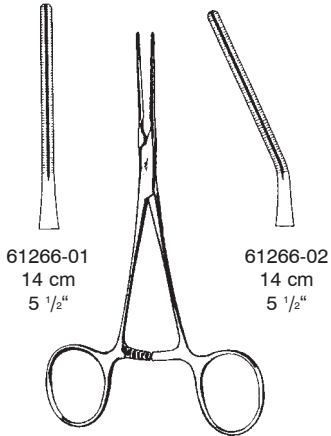

COOLEY
 61266-01 - 61266-02
 14 cm, 5 1/2"

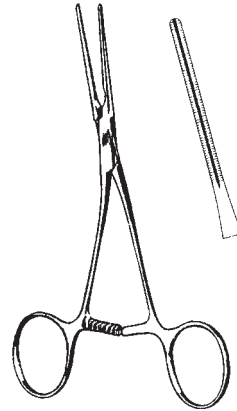

COOLEY
 61266-03 14 cm, 5 1/2"

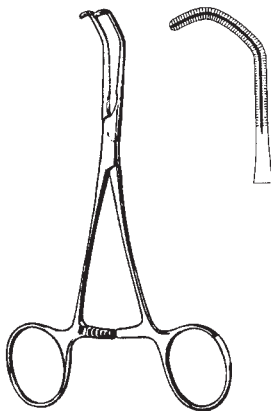

COOLEY
 61266-04 14 cm, 5 1/2"

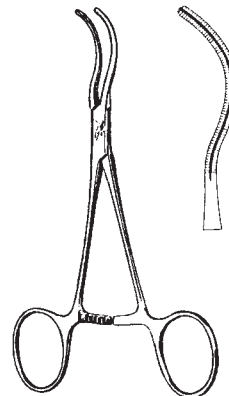

COOLEY
 61266-05 14 cm, 5 1/2"

Atrauma

Kinder-Gefäßklemmen
 Pediatric Vascular Clamps
 Pinzas vasculares pediátricas
 Pinze vascolari pediatriche

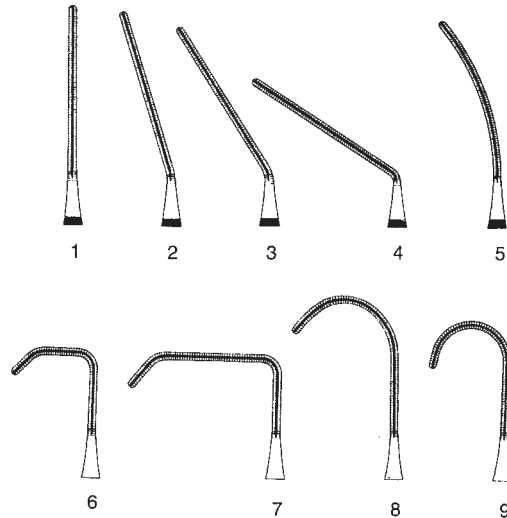
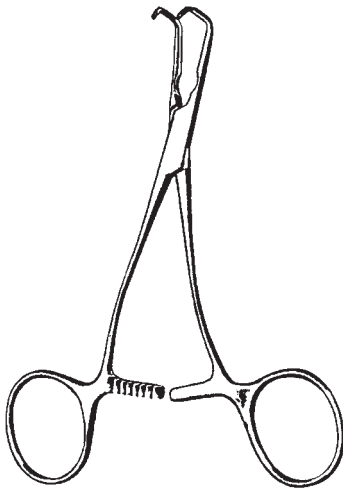

Fig.	gerade straight rectas rette
1	61372-01 14 cm, 5 1/2"
2	61372-02 14 cm, 5 1/2"
3	61372-03 14 cm, 5 1/2"
4	61372-04 13 cm, 5 1/8"
5	61372-05 14 cm, 5 1/2"
6	61372-06 13 cm, 5 1/8"
7	61372-07 13 cm, 5 1/8"
8	61372-08 14 cm, 5 1/2"
9	61372-09 13,5 cm, 5 1/4"



Fig.	stark abgewinkelt strongly angled ramas anguladas forte angolata
1	61373-01 14 cm, 5 1/2"
2	61373-02 14 cm, 5 1/2"
3	61373-03 14 cm, 5 1/2"
4	61373-04 13 cm, 5 1/8"
5	61373-05 14 cm, 5 1/2"
6	61373-06 13 cm, 5 1/8"
7	61373-07 13 cm, 5 1/8"
8	61373-08 14 cm, 5 1/2"
9	61373-09 13,5 cm, 5 1/4"

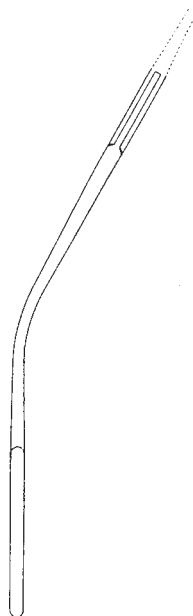

Fig.	abgewinkelt angled acodadas angolate
1	61374-01 14 cm, 5 1/2"
2	61374-02 14 cm, 5 1/2"
3	61374-03 14 cm, 5 1/2"
4	61374-04 13 cm, 5 1/8"
5	61374-05 14 cm, 5 1/2"
6	61374-06 13 cm, 5 1/8"
7	61374-07 13 cm, 5 1/8"
8	61374-08 14 cm, 5 1/2"
9	61374-09 13,5 cm, 5 1/4"



Clipanlegezangen für die offene Chirurgie 25° aufgebogen
 Clip Appliers for open Surgery 25° upcurved
 Pinza applicadora de clips para cirugía abierta con ángulo de 25°
 Pinza applicatore clips per chirurgia aperto, curvo in alto 25°



15 cm, 6"

Horizon

61460-15 Small gelb / yellow / jaune/ amarillo/ giallo
 61461-15 Medium blau / blue / bleu / azul / blu

SLS Clips

61464-15 Micro weiss / white / blanc / blanco / bianco
 61465-15 Small gelb / yellow / jaune/ amarillo/ giallo
 61466-15 Small medium lila / lilac / lilas / lila / lilla
 61467-15 Medium blau / blue / bleu / azul / blu

Ethicon

61470-15 Small blau / blue / bleu / azul / blu
 61471-15 Medium weiss / white / blanc / blanco / bianco

Pilling

61481-15 Small gelb / yellow / jaune / amarillo / giallo
 61482-15 Medium blau / blue / bleu / azul / blu

Horizon

61460-19 Small gelb / yellow / jaune / amarillo / giallo
 61461-19 Medium blau / blue / bleu / azul / blu
 61462-19 Medium Large grün / green / verde / verde
 61463-19 Large orange / naranja / arancione

SLS Clips

61464-19 Micro weiss / white / blanc / blanco / bianco
 61465-19 Small gelb / yellow/ jaune / amarillo / giallo
 61466-19 Small medium lila / lilac / lilas / lila / lilla
 61467-19 Medium blau / blue / bleu / azul / blu
 61468-19 Medium Large grün / green / verde / verde
 61469-19 Large orange / naranja / arancione

Ethicon

61470-19 Small blau / blue / bleu / azul / blu
 61471-19 Medium weiss / white / blanc / blanco / bianco
 61472-19 Medium Large grün / green / verde / verde
 61473-19 Large gelb / yellow / jaune / amarillo / giallo

Pilling

61481-19 Small gelb / yellow / jaune / amarillo / giallo
 61482-19 Medium blau / blue / bleu / azul / blu
 61484-19 Medium Large grün / green / verde / verde
 61483-19 Large orange / naranja / arancione



19 cm, 7 1/2"

Clipanlegezangen für die offene Chirurgie 25° aufgebogen
Clip Appliers for open Surgery 25° upcurved
Pinza aplicadora de clips para cirugía abierta con ángulo de 25°
Pinza applicatore clips per chirurgia aperto, curvo in alto 25°

Horizon

61461-28 Medium blau / blue / bleu / azul / blu
61462-28 Medium Large grün / green / verde / verde
61463-28 Large orange / naranja / arancione

SLS Clips

61464-28 Micro weiss / white / blanco / bianco
61465-28 Small gelb / yellow / jaune / amarillo / giallo
61466-28 Small medium lila / lilac / lilas / lila / lilla
61467-28 Medium blau / blue / bleu / azul / blu
61468-28 Medium Large grün / green / verde / verde
61469-28 Large orange / naranja / arancione

Ethicon

61471-28 Medium weiss / white / blanco / bianco
61472-28 Medium Large grün / green / verde / verde
61473-28 Large gelb / yellow / jaune / amarillo / giallo

Pilling

61482-28 Medium blau / blue / bleu / azul / blu
61484-28 Medium Large grün / green / verde / verde
61483-28 Large orange / naranja / arancione



28 cm, 11"

Kinder-Gefäßklemmen
 Pediatric Vascular Clamps
 Pinzas vasculares pediátricas
 Pinze vascolari pediatriche

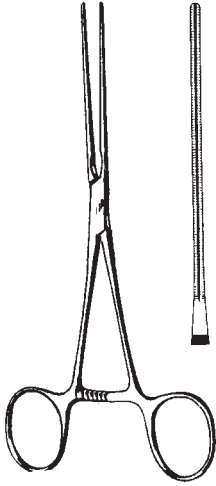

61488-16
 16,5 cm, 6 1/2"

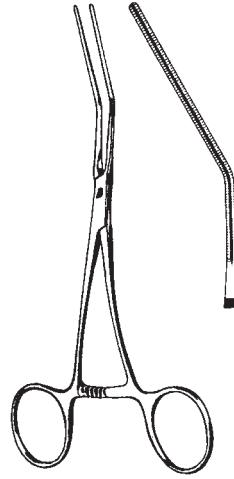

61489-16
 16 cm, 6 1/4"

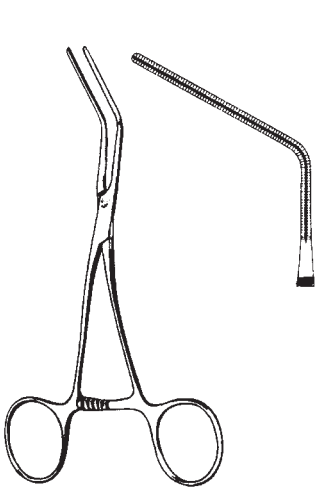

61490-15
 15 cm, 6"

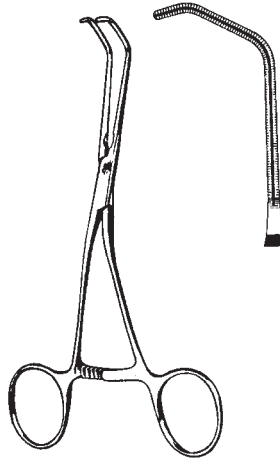

61491-15
 15 cm, 6"

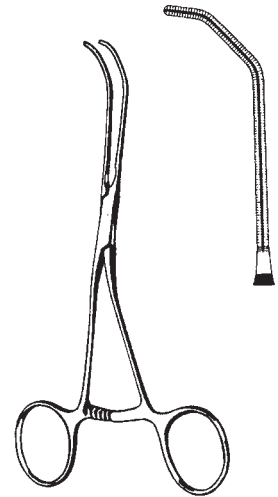

61492-16
 15,5 cm, 6"

Atrauma

Neonatal-Gefäßklemmen
Neonatal Vascular Clamps
Pinzas vasculares para recién nacidos
Pinze vascolari per neonati

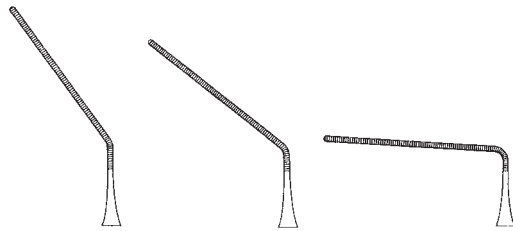

61493-01
13 cm
5 1/8"

61493-02
13 cm
5 1/8"

61493-03
11 cm
4 3/8"

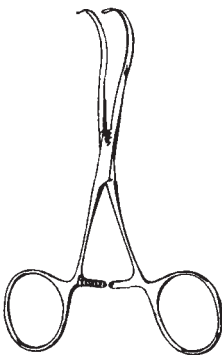

CASTANEDA
61493-01 - 61495-04

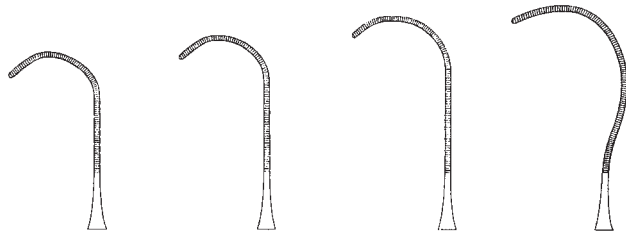

61495-01
12 cm
4 3/4"

61495-02
12 cm
4 3/4"

61495-03
12 cm
4 3/4"

61495-04
12 cm
4 3/4"

Aortenstanzen, Tourniquets
 Aorta punches, Tourniquets
 Trefina para aorta, Tourniques
 Trefino per Aorta, Tornichetti

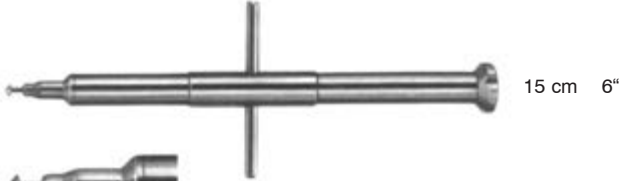

15 cm 6"



61715-04 Ø 4 mm



61715-05 Ø 5 mm



61715-06 Ø 6 mm



61700-01
 61710-01
 Mandrin alleine
 Guide only
 Guida sola



RUMEL-BELMONT
 61700-33 3,2 mm Ø
 61710-33 6,4 mm Ø
 33 cm, 13"
 flexibel, flexible,
 flexible, flessibile

Gefäß-Dilatatoren
 Vascular Dilators
 Dilatadores vasculares
 Dilatatori vascolari

biegsam
 malleable
 malleables
 malleabile

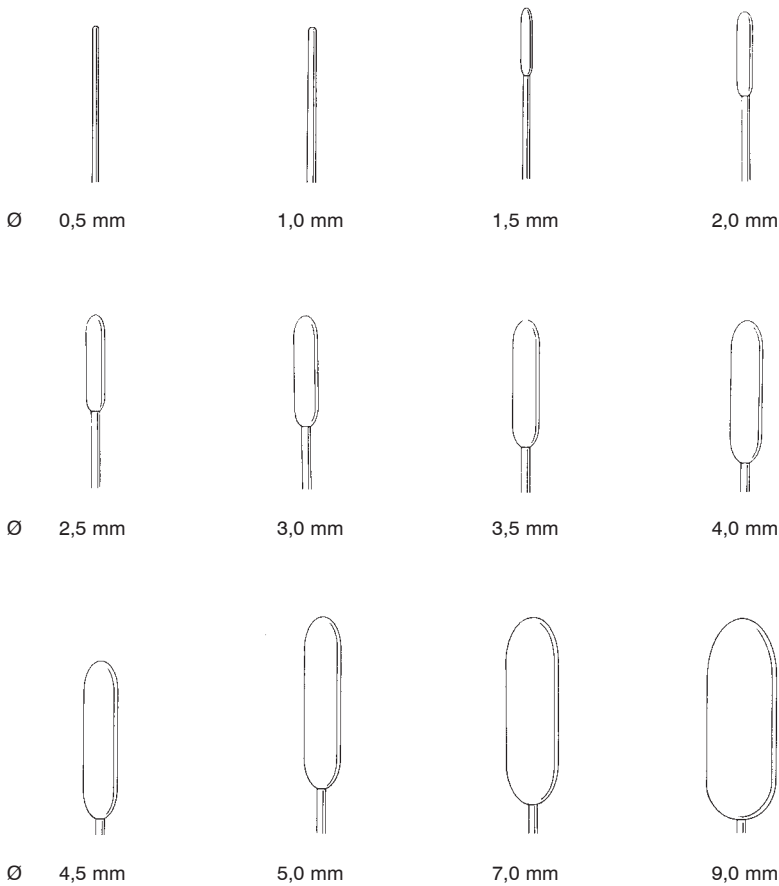

DE BAKEY

19 cm, 7 1/2"	Ø mm	35 cm, 13 3/4"
61810-05	0,5	61820-05
61810-10	1,0	61820-10
61810-15	1,5	61820-15
61810-20	2,0	61820-20
61810-25	2,5	61820-25
61810-30	3,0	61820-30
61810-35	3,5	61820-35
61810-40	4,0	61820-40
61810-45	4,5	61820-45
61810-50	5,0	61820-50
61810-70	7,0	61820-70
61810-90	9,0	61820-90

Gefäßdissektoren
 Vascular Dissectors
 Disecadores vasculares
 Dissettori vascolari

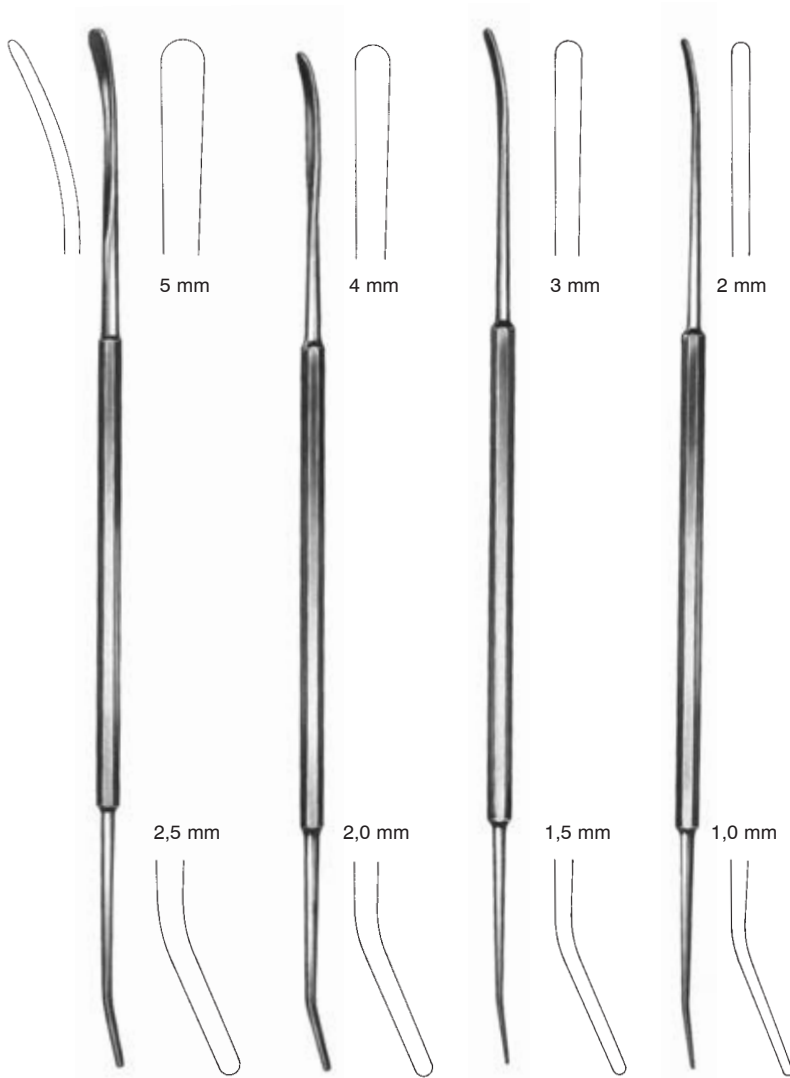

ROBB
 24 cm, 9 1/2"

Fig. 1
 61910-01

Fig. 2
 61910-02

Fig. 3
 61910-03

Fig. 4
 61910-04

Intimaspatel
Intima Spatulas
Espátulas para la intima
Spatole per intima



stumpf
blunt
roma
smussa



61920-14
14 cm 5 1/2"



61920-23
23,5 cm 9 1/4"



61930-18
18,5 cm, 7 1/4"

61930-21
21,5 cm, 8 1/2"

stumpf
blunt
roma
smussa



3 mm



Gallensteinzangen
Gall Stone Forceps
Pinzas para cálculos biliares
Pinze per calcoli biliari



DESJARDINS
23 cm, 9"

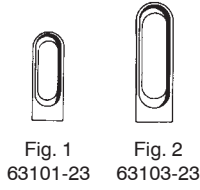
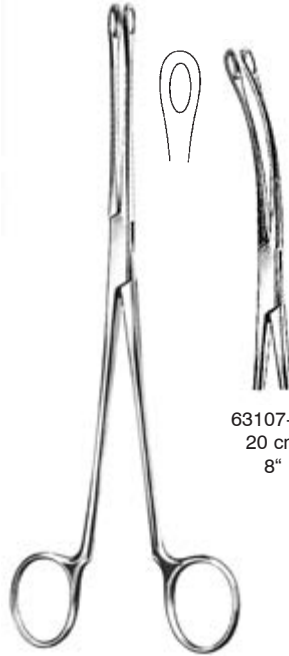

Fig. 1
63101-23

Fig. 2
63103-23



BLAKE
63106-20 20 cm, 8"



63107-20
20 cm
8"



MAYO-BLAKE
63110-20 20 cm, 8"



MAYO-BLAKE
63111-20 20 cm, 8"



MIXTER
63117-22 22 cm, 8 3/4"

Gallensteinsonden, Gallengangdilatoren
 Gall Stone Probes, Bile duct dilators
 Exploradores para cálculos biliares, Dilatadores para conductos biliares
 Sonde per calcoli biliari, Dilatatori per condotti biliari



Ø 5,8 cm

Gallensteinlöffel
 Gall Stone Scoops
 Cucharillas para cálculos biliares
 Cucchiari per calcoli biliari

MOOR
 63125-28
 28 cm, 11"

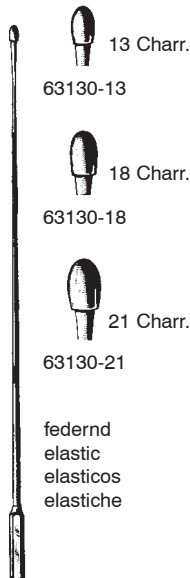

13 Charr.
 63130-13

18 Charr.
 63130-18

21 Charr.
 63130-21

federnd
 elastic
 elasticos
 elastiche

DESJARDINS
 63130-13 - 63130-21
 28 cm, 11"

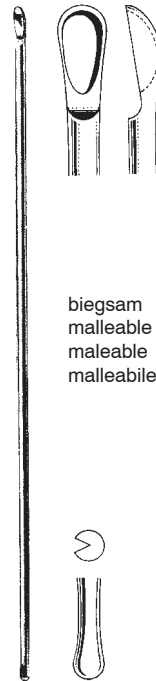

biegsam
 malleable
 malleable
 malleabile

MOYNIHAN
 63142-34 34 cm, 13 1/2"

Gallensteinsonden, Gallengangdilatoren

Gall Stone Probes, Bile duct dilators

Exploradores para cálculos biliares, Dilatadores para conductos biliares

Sonde per calcoli biliari, Dilatatori per condotti biliari

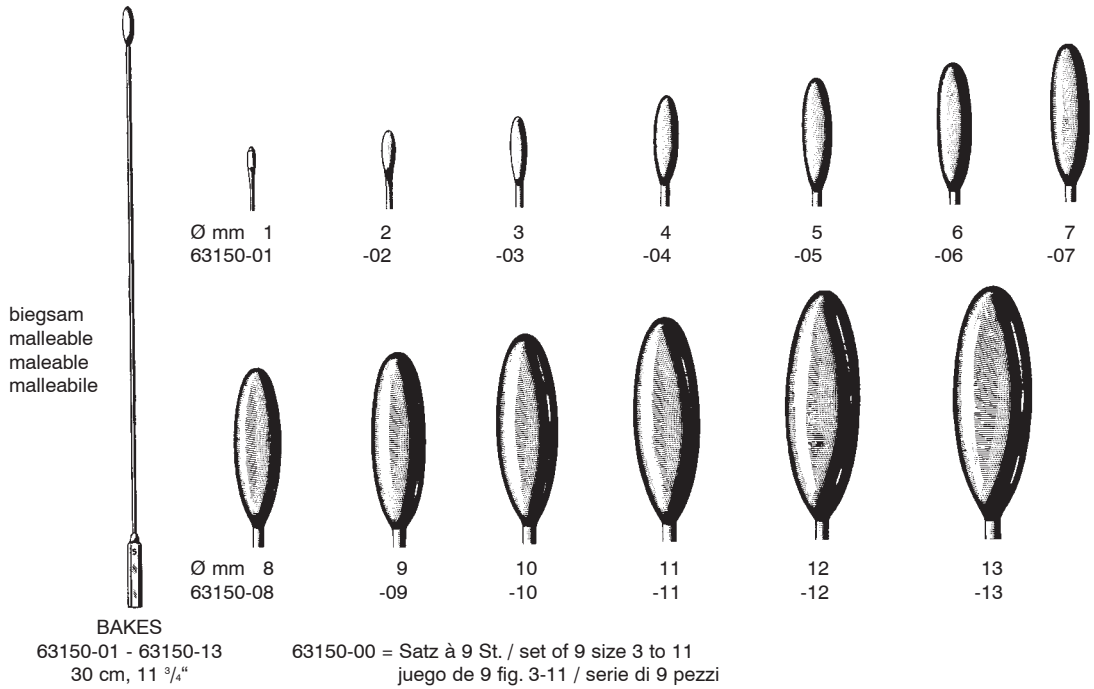

Gallensteinlöffel
 Gall Stone Scoops
 Cucharillas para cálculos biliares
 Cucchiari per calcoli biliari

biegsam
 malleable
 maleables
 malleabile



LUER-KOERTE
 63173-01 - 63173-08
 32 cm, 12 3/4"



FERGUSSON
 63170-21 - 63170-23

8,5 mm

11,5 mm

12,5 mm

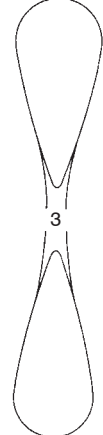
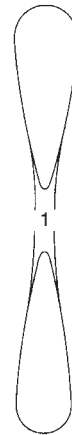

10,5 mm

12,5 mm

13,0 mm

63170-21
 24 cm
 9 1/2"

63170-22
 24 cm
 9 1/2"

63170-23
 24 cm
 9 1/2"



2,5 mm



3,2 mm



3,6 mm



5,5 mm

Fig. 000
 63173-01

Fig. 00
 63173-02

Fig. 0
 63173-03

Fig. 1
 63173-04



6,7 mm



8,0 mm



11 mm



15 mm

Fig. 2
 63173-05

Fig. 3
 63173-06

Fig. 4
 63173-07

Fig. 5
 63173-08



Gallensteinlöffel, Gallengangsonde
 Gall Stone Scoops, Gall Duct Probes
 Cucharillas para cálculos biliares, sonda para conducto biliar
 Cucchiari per calcoli biliari, sonda per bile



MAYO
 63175-27
 27 cm, 10 1/2"

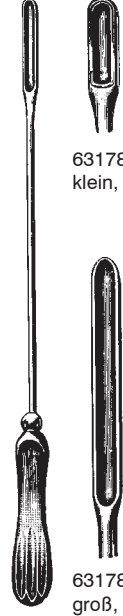

63178-01
 klein, small, pequeña, piccola

63178-03
 groß, large, grande

MAYO
 63178-01 - 63178-03
 27 cm, 10 1/2"



17 Charr.

Fig. 1
 63180-17



21 Charr.

Fig. 2
 63180-21



24 Charr.

Fig. 3
 63180-24



27 Charr.

Fig. 4
 63180-27

federnd
 elastic
 elásticas
 elastiche

DESJARDINS
 63180-17 - 63180-27
 30 cm, 11 3/4"



biegsam
 malleable
 maleable
 malleabile

MAYO
 63210-32
 32 cm, 12 3/4"

Nierensteinzange
Kidney Stone Forceps
Pinzas para cálculos renales,
Pinze per calcoli renali



Fig. 1
63231-01 23 cm, 9"



Fig. 2
63231-02 22 cm, 8 3/4"



Fig. 3
63231-03 22 cm, 8 3/4"



Fig. 4
63231-04 22 cm, 8 3/4"



RANDALL

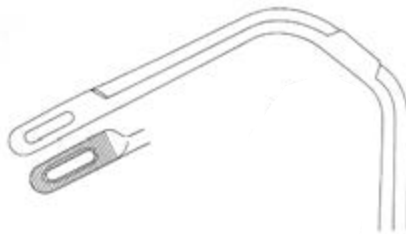

Fig. 5
63231-05 19 cm, 7 1/2"



Fig. 6
63231-06 19 cm, 7 1/2"

Nierensteinzange
Kidney Stone Forceps
Pinzas para cálculos renales
Pinze per calcoli renali



HEIMING

für Kinder
for children
para niños
per bambini



63232-01
17 cm, 6 ³/₄"



63232-02
16 cm, 6 ¹/₄"

Darm- und Gewebefasszangen
 Intestinal and Tissue Grasping Forceps
 Pinzas para intestinos y tejidos
 Pinze per afferrare intestino e tessuti



ALLIS-BABY
 65102-12 12 cm, 4 3/4"
 65102-14 14 cm, 5 1/2"

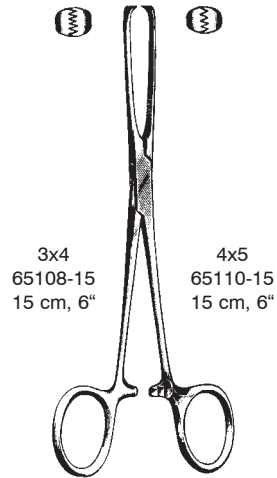

3x4
 65108-15 15 cm, 6"
4x5
 65110-15 15 cm, 6"

ALLIS 5x6
 65120-15 15 cm, 6"
 65120-19 19 cm, 7 1/2"
 65120-22 22 cm, 8 3/4"
 65120-24 24 cm, 9 1/2"



ALLIS Atrauma
 65124-16 16 cm, 6 1/4"
 65124-20 20 cm, 8"
 65124-22 22 cm, 8 3/4"
 65124-25 25 cm, 10"
 65124-30 30 cm, 11 3/4"

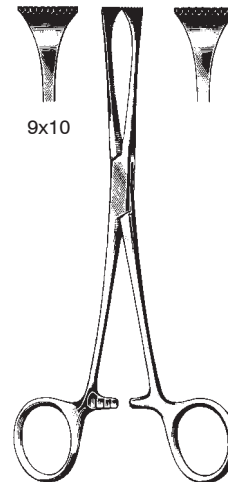

ALLIS-ADAIR
 65130-15 15,5 cm, 6"

Darm- und Gewebefasszangen
 Intestinal and Tissue Grasping Forceps
 Pinzas para intestinos y tejidos
 Pinze per afferrare intestino e tessuti



LOCKWOOD-ALLIS
 65132-16 16 cm, 6 1/4"
 65132-20 20 cm, 8"

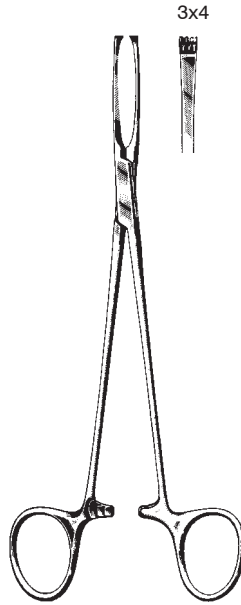

JUDD-ALLIS
 65140-15 15 cm, 6"
 65140-19 19 cm, 7 1/2"



BOYS-ALLIS
 65145-15 15 cm, 6"

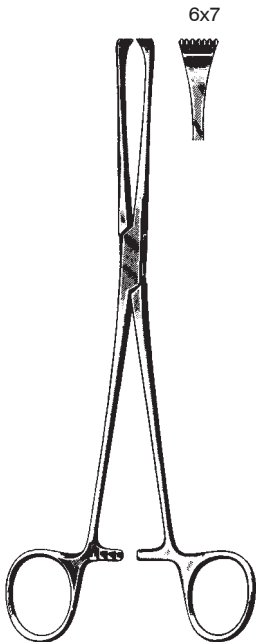

THOMS-ALLIS
 65150-20 20 cm, 8"



LITTLEWOOD
 65154-18 18,5 cm, 7 1/4"



GREGOIRE
 65155-18 18 cm, 7"
 65155-20 20 cm, 8"

Darm- und Gewebefasszangen
 Intestinal and Tissue Grasping Forceps
 Pinzas para intestinos y tejidos
 Pinze per afferrare intestino e tessuti

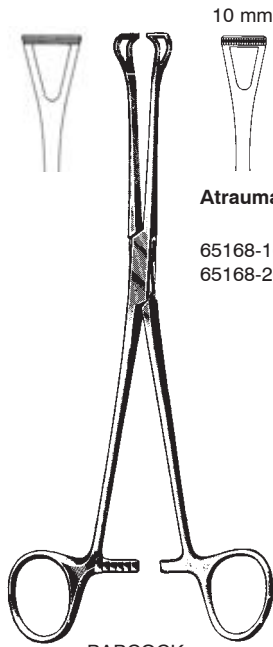

10 mm

Atrauma

65168-16 16 cm, 6 1/4"
 65168-20 20 cm, 8"

BABCOCK

65160-14 14 cm, 5 1/2"
 65160-16 16 cm, 6 1/4" **65164-16 TC 16 cm**
 65160-18 18 cm, 7"
 65160-20 20 cm, 8" **65164-20 TC 20 cm**
 65160-24 24 cm, 9 1/2"

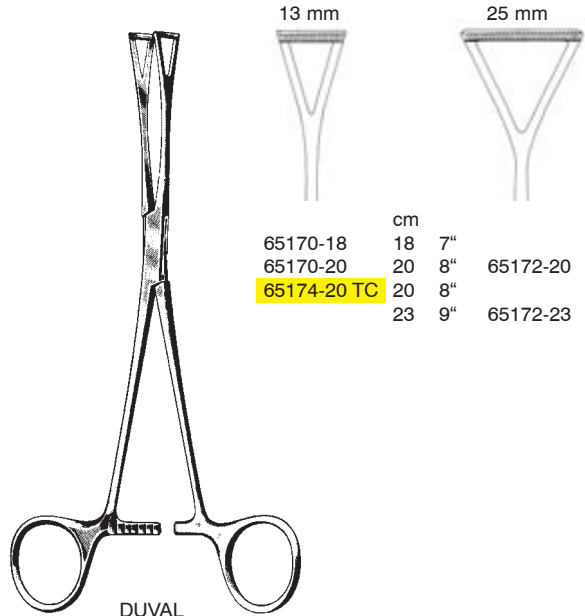

13 mm

25 mm

DUVAL

65170-18 - 65172-23

	cm	
65170-18	18	7"
65170-20	20	8"
65174-20 TC	20	8"
	23	9"
		65172-20
		65172-23

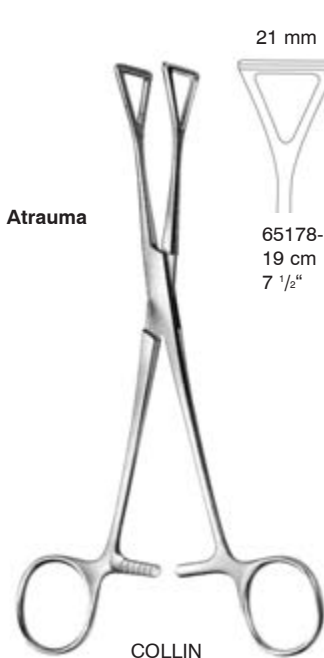

Atrauma

21 mm

65178-19
 19 cm
 7 1/2"

COLLIN



23 mm

65178-23
 23 cm
 9"



WILLIAMS

65180-16 16,5 cm, 6 1/2"

Darmklemmen
 Intestinal Forceps
 Pinzas intestinales
 Pinze intestinali

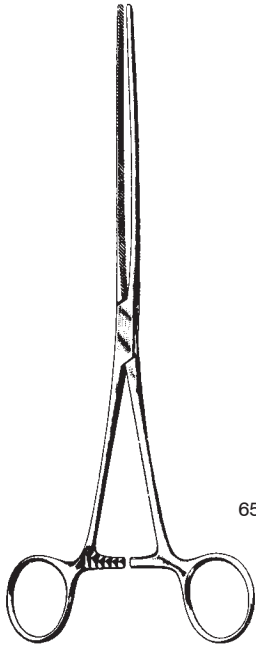

DOYEN-BABY
 65210-18 65211-18
 18 cm, 7"

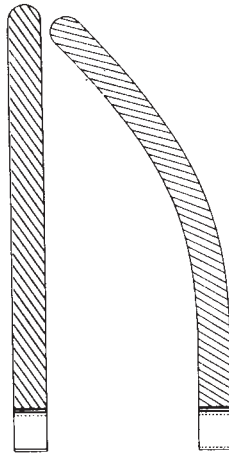
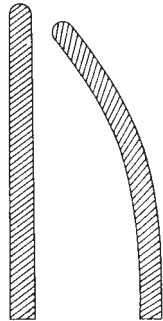

DOYEN
 65210-21 21 cm, 8 1/4" 65211-21
 65210-23 23 cm, 9" 65211-23

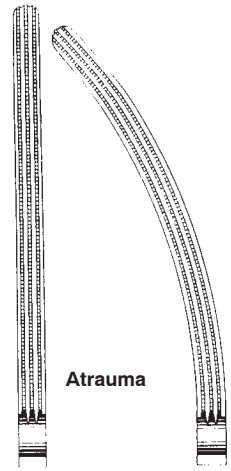

DOYEN
Atrauma
 65216-13 13 cm, 5 1/8" 65217-13
 65216-16 16 cm, 6 1/4" 65217-16
 65216-18 18 cm, 7" 65217-18
 65216-21 21 cm, 8 1/4" 65217-21
 65216-23 23 cm, 9" 65217-23

DOYEN
 65210-18 - 65217-23

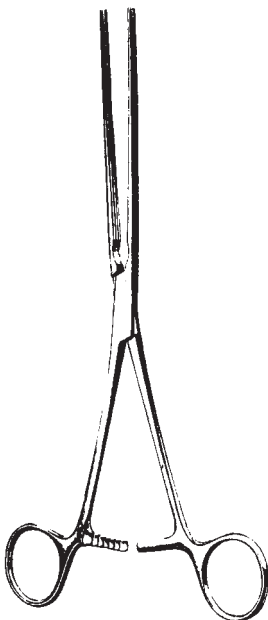

KOCHER
 65220-22 - 65227-28

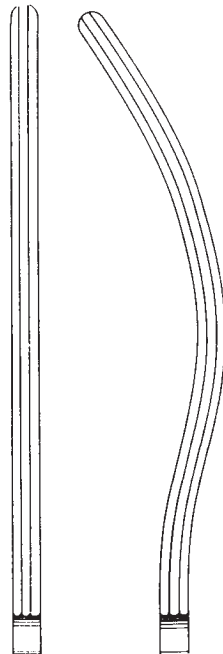

65220-13 13 cm, 5 1/8" 65221-13 **BABY-KOCHER**
 65220-22 22 cm, 8 3/4" 65221-22
 65220-25 25 cm, 10" 65221-25
 65220-28 28 cm, 11" 65221-28

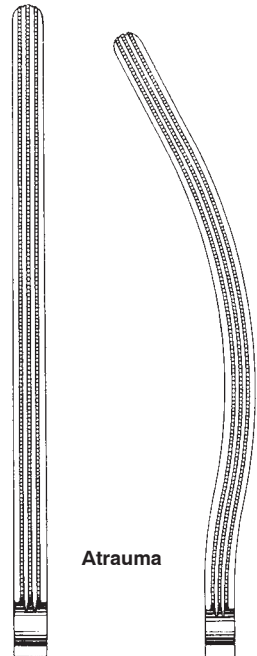

Atrauma
 65226-22 22 cm, 8 3/4" 65227-22
 65226-25 25 cm, 10" 65227-25
 65226-28 28 cm, 11" 65227-28

Darmklemmen
 Intestinal Forceps
 Pinzas intestinales
 Pinze intestinali

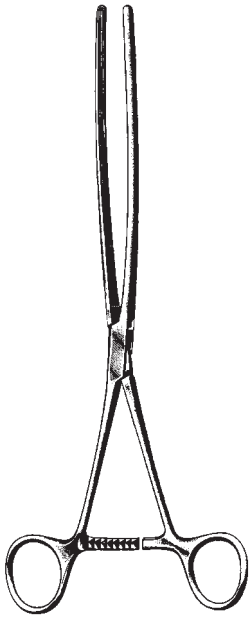

MAYO-ROBSON

65230-21 21 cm, 8 1/4"
 65237-25 25 cm, 10"

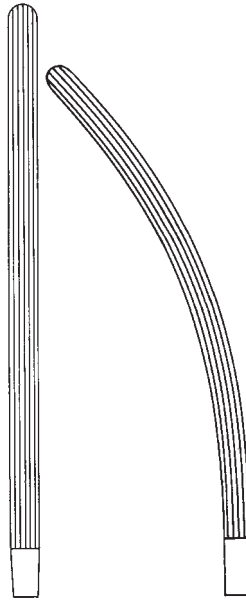

65230-21 21 cm, 8 1/4" 65231-21
 65230-23 23 cm, 9" 65231-23
 65230-25 25 cm, 10" 65231-25

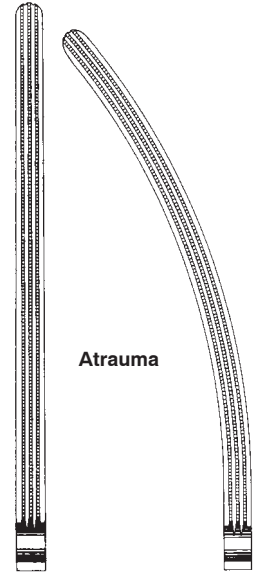

Atrauma

65236-25 25 cm, 10" 65237-25



SCUDDER
 65238-33
 33 cm, 13"



Atrauma



65239-33
 33 cm, 13"

Darmklemmen
Intestinal Forceps
Pinzas intestinales
Pinze intestinali



FEHLAND
65241-23
23,5 cm 9 1/4"



RESANO
65242-30
30 cm, 11 3/4"

Atrauma

Magen-Darmklemmen
Intestinal and Stomach Clamps
Pinzas-clamps intestinales y estomacales
Pinze intestinali e stomacali

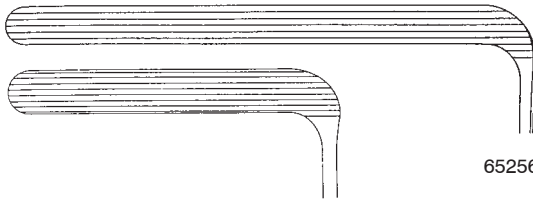

65255-19

65256-19

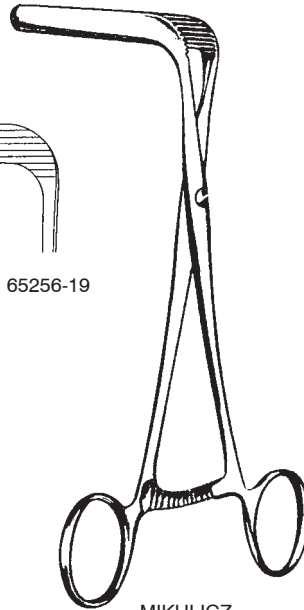

MIKULICZ
19 cm, 7 1/2"



BRUNNER
24 cm, 9 1/2"

Atrauma



65259-24



65260-24

Pylorusspreizer, Blinddarmklemmen
 Pylorus spreader, Blindgut forceps
 Separador para píloro, Pinzas para apéndice
 Divaricatori per piloro, Pinza per appendice



BENSON
 65261-15
 15,5 cm, 6"



KLEINSCHMIDT
 65262-12
 12 cm, 4 ³/₄"

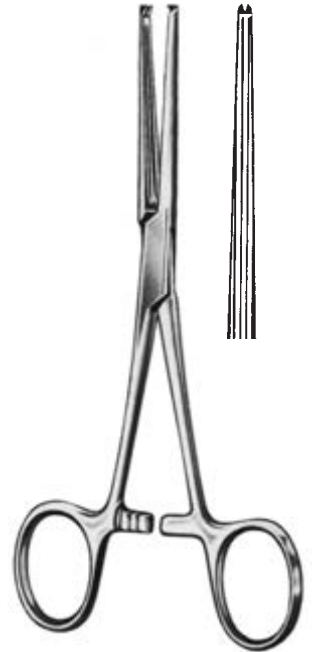

ALLEN
 65263-15 15 cm, 6"
 65263-20 20 cm, 8"

Darm-Anastomosenklemmen
 Intestinal Anastomosis Clamps
 Clamps para anastomosis intestinales
 Pinze per anastomosi intestinali



HAYES
 65265-26 26 cm, 10 1/4"
 65265-28 28 cm, 11"

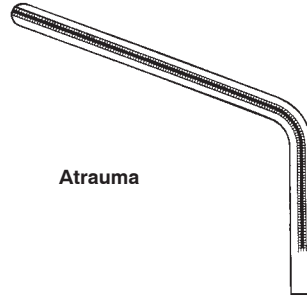

Atrauma

65265-26
 26 cm, 10 1/4"

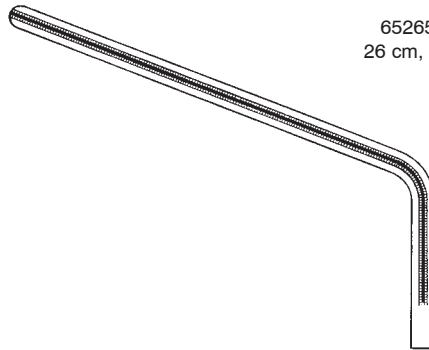

65265-28
 28 cm, 11"

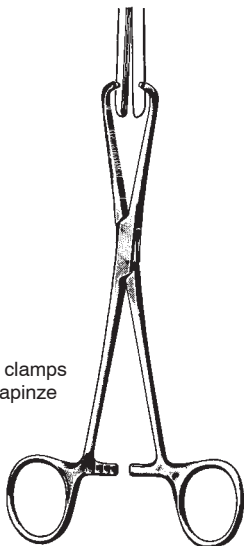

Schließklemme
 Closing Forceps
 Pinza para cerrar clamps
 Serrapinze e portapinze

STONE-WATT
 65270-15
 15,5 cm, 6"



STONE-WATT
 65272-07 7,5 cm, 3"
 65272-10 10,0 cm, 4"

Klemmschloß
 Locking Device
 Cierre para clamps intestinales
 Serratura per pinze intestinali



STONE-WATT
 65274-00

Darm-Anastomosenklemmen
 Intestinal Anastomosis Clamps
 Clamps para anastomosis intestinales
 Pinze per anastomosi intestinali

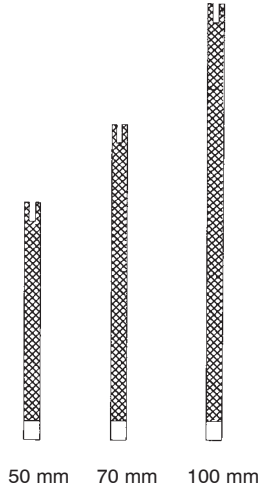

DE MARTEL-WOLFSON

65280-05	5 cm, 2"	set of 3
65280-07	7 cm, 2 3/4"	set of 3
65280-10	10 cm, 4"	set of 3

Klemmschließzange
 Closing Forceps
 Pinza para cerrar grapas
 Serrapinze



DE MARTEL-WOLFSON
 65282-26 26 cm, 10 1/4"

Klemmenhalterung
 Clamp Holder
 Porta-clamp
 Portapinze



DE MARTEL-WOLFSON
 65284-08 8,5 cm, 3 1/2"



DE MARTEL-WOLFSON
 65284-23 23 cm, 9"

Magen- und Darm-Zwillingsklemmen
Stomach and Intestinal Anastomosis Twin Clamps
Pinzas gastro-intestinales gemelas
Pinze gastrointestinali gemelle

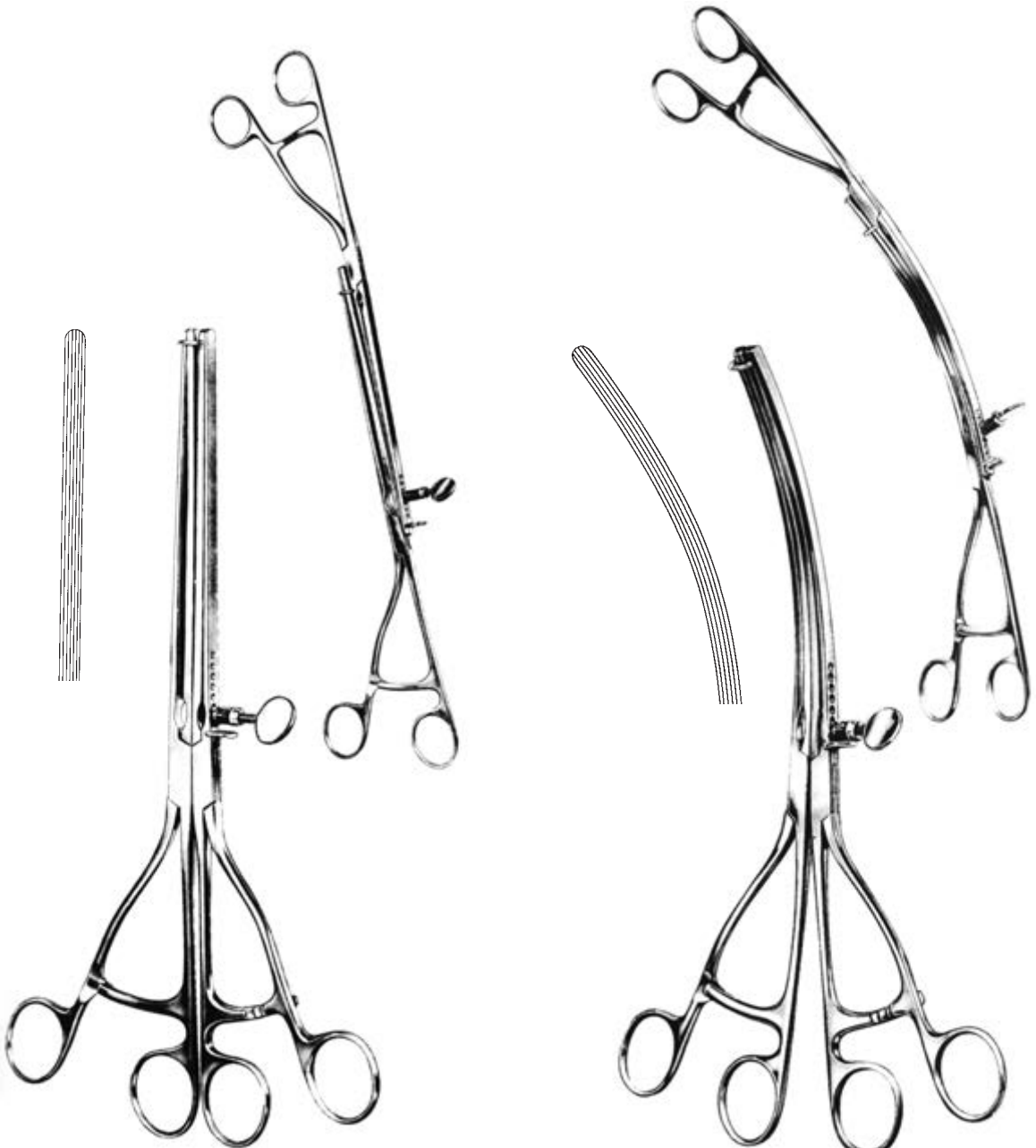

LANE
65290-30 30 cm, 11 ³/₄"

LANE
65291-30 30 cm, 11 ³/₄"

Darm- und Magenquetschklemmen
 Intestinal and Stomach Clamps
 Pinzas-clamps intestinales y estomacales
 Pinze e Schiacciatori per l'intestino e lo stomaco

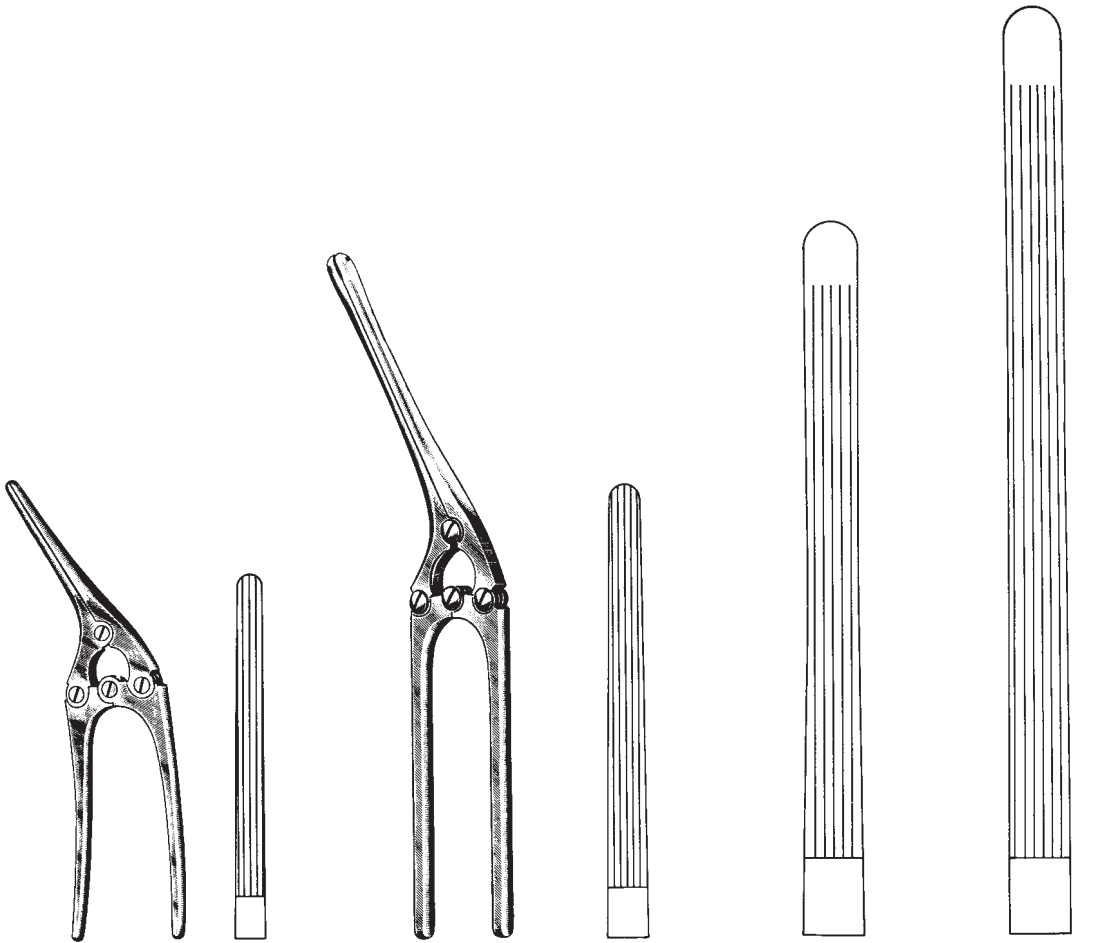

PAYR-BABY
 65310-15
 15 cm, 6"

PAYR

65310-21
 21 cm, 8 1/4"

65310-29
 29 cm, 11 1/2"

65310-35
 35 cm, 14"

Magen- und Darmnähapparat
 Stomach and Intestinal Suturing Apparatus
 Aparato para suturar estómago e intestinos
 Apparecchiature di sutura gastro-intestinale

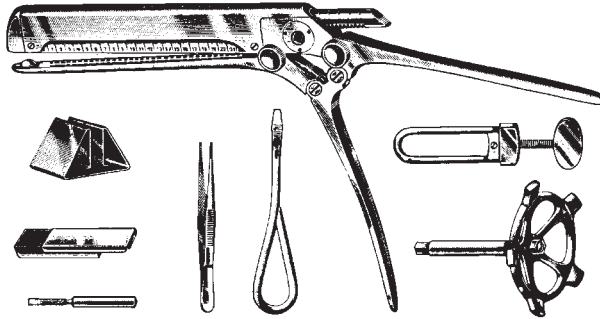

V. PETZ
 65320-00
 komplett in Holzetui
 compl. in wooden case
 en estuche de madera
 in astuccio di legno

bestehend aus:

- Nähapparat
- Holzetui
- Zusatzschloß
- Kurbel
- Füllständer
- Füllstift
- Füllpinzette
- Schraubenzieher
- Etui für Klammern
- Silberklammern
(Pack à 300 Stck.)

consisting of:

- suturing apparatus
- wooden case
- additional closing clamp
- gear wheel
- filling rack
- filling pin
- filling tweezer
- screw driver
- metal box for clips
- silver suturing clips
(Pack of 300 ea.)

compuesto de:

- Aparator para suturar
- Estuche de madera
- Cierre adicional
- Manivela
- Soporte para rellenar
- Espiga para rellenar
- Pinza para rellenar
- Destornillador
- Estuche para agrafas
- Agrafas para sutura de plata
(Paquete de 300 pzas.)

composta da:

- apparecchio per la sutura
- astuccio in legno
- Serratura supplementare
- manovella
- supporto di riempimento agraiffe
- perno per posizionare le agraiffe
- pinza per caricare
- cacciavite
- scatola in metallo per agraiffe
- agraiffe in argento
(confezione da 300 pezz.)

Prostatahaken, Prostatafaßzange, Kapsel­faßzange

Prostatic retractors, Grasping forceps for the capsule – anterior lobe and ligature carrier

Separador para prostata, pinza de agarre para capsula y prostate

Divaricatori per prostata, pinza per afferrare la capsula e prostata

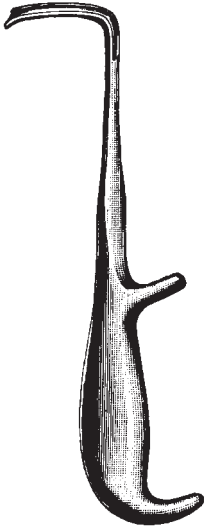

YOUNG
67101-21
21 cm, 8 1/4"

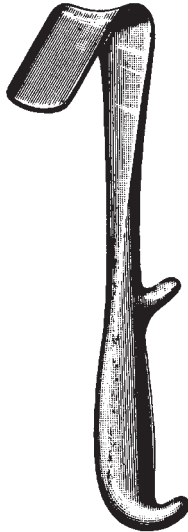

YOUNG
67103-22
22 cm, 8 3/4"

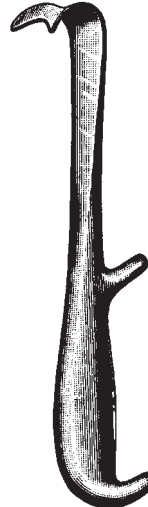

YOUNG
67105-21
21 cm, 8 1/4"



YOUNG
67105-22
22 cm, 8 3/4"

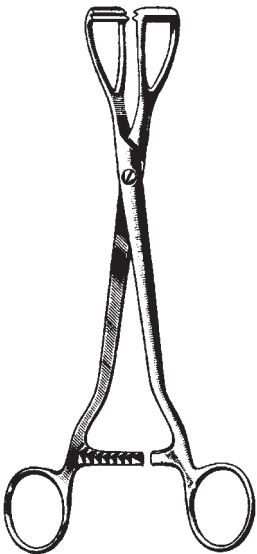

YOUNG
67106-20
20 cm, 8"



MILLIN
67110-23
23,5 cm, 9 1/4"

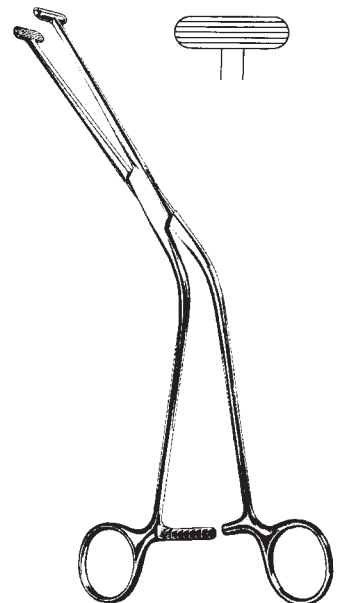

MILLIN
67111-23
23 cm, 9"

Kapselfasszange, Fadenführungszange
Capsule Forceps, Ligature Carrying Forceps
Pinzas capsulares, Pinza porta ligaduras
Pinze per afferrare capsule, Pinza porta-filo

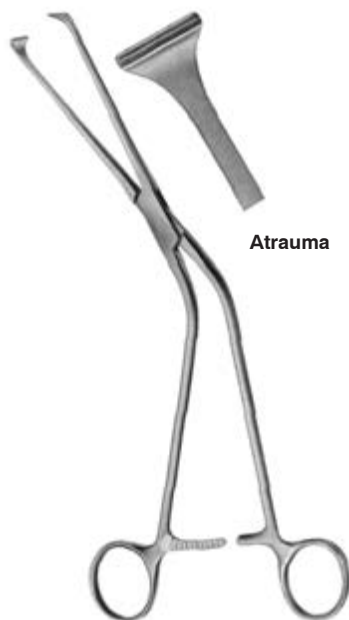

MILLIN
67122-23
24,5 cm, 9 3/4"

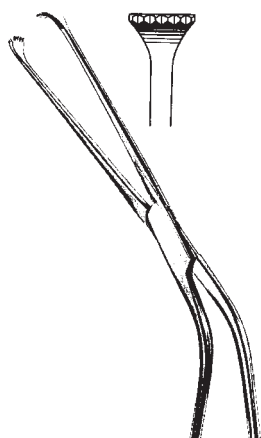

MILLIN
67123-23
23 cm, 9"

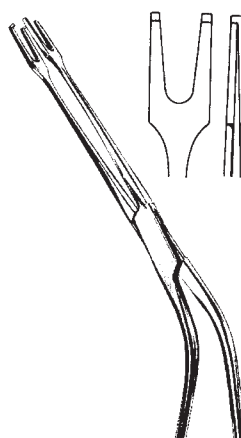

MILLIN
67125-24
24 cm, 9 1/2"

Blasenwundspreizer, Blasenspatel
Bladder Retractors
Separadores vesicales, Espátula vesical
Divaricatori vescicali, Spatoli vescicali

67130-01	2 Valven, 2 blades, 2 valvas, 2 valve	57 mm x 25 mm
67130-02	2 Valven, 2 blades, 2 valvas, 2 valve	80 mm x 25 mm
67130-03	1 Valven, 1 blade, 1 valva, 1 valve	120 mm x 45 mm



- 67130-00 ohne Kaltlicht
- 67132-00 Kaltlichtaufsatz für 67130-00
- 67130-00 without fiber optic
- 67132-00 fiber optic light carrier for 67130-00
- 67130-00 sin soporte de luz fría
- 67132-00 soporte de luz fría para 67130-00
- 67130-00 senza fibre ottiche
- 67132-00 supporto per luce fredda per 67130-00



- 67150-00 mit Mittelvalve, with Central Blade
con valva central, con valva centrale
- 67155-00 ohne Mittelvalve, without Central Blade
sin valva central, senza valva centr.



Blasenwundspreizer, Blasenhalssperrer, Urethrotome
 Bladder Retractors, Bladder Neck Spreader, Urethrotomes
 Separadores vesicales, Uretrótomos
 Divaricatori vescicali, Divaricatore del collo vescicale, Uretrotomi



LEGUEU
 67163-00



MILLIN
 67165-00

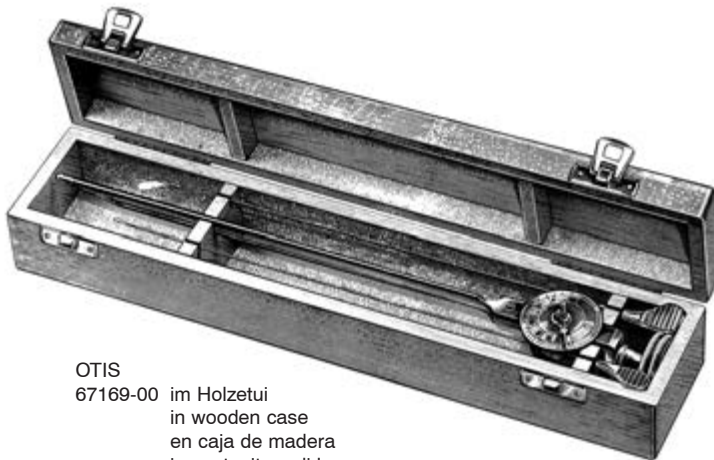

OTIS
 67169-00 im Holzetui
 in wooden case
 en caja de madera
 in contenitore di legno

67169-01 Ersatzblatt alleine
 Blade only
 Hoja de repuesto
 Lame di ricambio

Fremdkörperzange, Penisklemmen
 Foreign Body Forceps, Penis Seizing Forceps
 Pinzas para cuerpos extraños, Compresores uretrales
 Pinze per corpi estranei, Serrapene

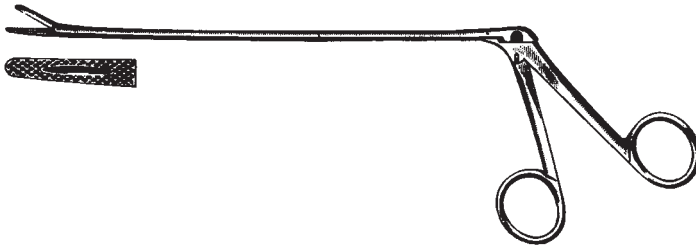

MATHIEU
 67172-20 20 cm, 8"
 67172-28 28 cm, 11"



STOCKMANN
 67175-08
 8 cm, 3 1/8"



STRAUSS
 67177-11
 11 cm, 4 3/8"

Vasektomie-Klemme
Vasectomy Forceps
Pinza para vasectomia
Pinza per vasectomia



67178-12
12 cm, 4 ³/₄"



innen Ø 3 mm

67178-14
14 cm, 5 ¹/₂"



67179-14
14,5 cm, 5 ³/₄"

Kathetereinführungsinstrumente, Dilatationsbougies
 Catheter Introducer, Dilating Bougies
 Introducator de catéteres, Bujías dilatadoras
 Mandrini per sonde uretrali, Candelette dilatatrici



67185-35
 35 cm, 13 3/4"

GUYON
 67184-39
 39 cm, 15 1/2"

Charr. FG	28 cm (11") VAN BUREN	25 cm (10") GUYON	28 cm (11") DITTEL	30 cm (11 3/4") DITTEL
8	67201-08	67205-08	67206-08	67207-08
9			67206-09	67207-09
10	67201-10	67205-10	67206-10	67207-10
11			67206-11	67207-11
12	67201-12	67205-12	67206-12	67207-12
13			67206-13	67207-13
14	67201-14	67205-14	67206-14	67207-14
15			67206-15	67207-15
16	67201-16	67205-16	67206-16	67207-16
17			67206-17	67207-17
18	67201-18	67205-18	67206-18	67207-18
19			67206-19	67207-19
20	67201-20	67205-20	67206-20	67207-20
21			67206-21	67207-21
22	67201-22	67205-22	67206-22	67207-22
23			67206-23	67207-23
24	67201-24	67205-24	67206-24	67207-24
25			67206-25	67207-25
26	67201-26	67205-26	67206-26	67207-26
27			67206-27	67207-27
28	67201-28	67205-28	67206-28	67207-28
29			67206-29	67207-29
30	67201-30	67205-30	67206-30	67207-30
32	67201-32	67205-32		
34	67201-34	67205-34		
36	67201-36	67205-36		
38		67205-38		
40		67205-40		

Metallkatheter
 Metal Catheters
 Sondas metálicas
 Sonde metalliche

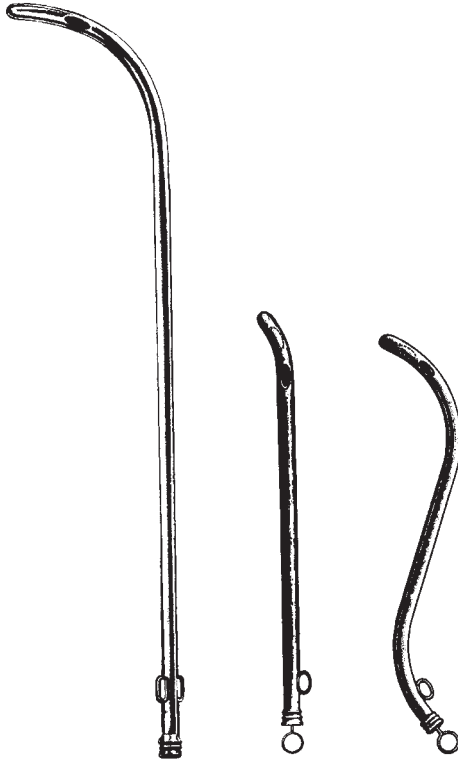

29 cm
 11 1/2"

15 cm
 6"

COXETER



WALTHER
 5 1/4"
 67220-00 (Set)

Charr.
 FG

6	67211-06	67213-06	
8	67211-08	67213-08	67219-08
10	67211-10	67213-10	67219-10
12	67211-12	67213-12	67219-12
14	67211-14	67213-14	67219-14
16	67211-16	67213-16	67219-16
18	67211-18	67213-18	67219-18
20	67211-20	67213-20	67219-20
22	67211-22	67213-22	67219-22
24	67211-24	67213-24	67219-24

67220-12	12 Fr.
67220-14	14 Fr.
67220-16	16 Fr.
67220-18	18 Fr.
67220-20	20 Fr.
67220-22	22 Fr.
67220-24	24 Fr.
67220-26	26 Fr.
67220-28	28 Fr.
67220-30	30 Fr.
67220-32	32 Fr.
67220-34	34 Fr.
67220-36	36 Fr.
67220-38	38 Fr.

Beschneidungsinstrument
Circumcision Instrument
Instrumentos para circuncisión
Strumenti per circoncisione

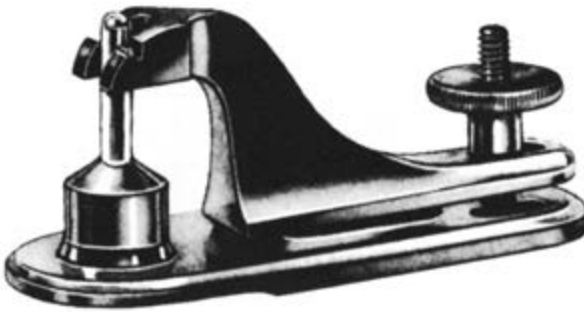

67240-08	8 mm Ø
67240-11	11 mm Ø
67240-13	13 mm Ø
67240-16	16 mm Ø
67240-21	21 mm Ø
67240-26	26 mm Ø
67240-32	32 mm Ø

67240-08 - 67240-32



MOGEN

67250-07	7,5 cm (3")	2,5 mm
67251-07	7,5 cm (3")	1,5 mm

für Kinder
for children
para niños
per bambini



Mastdarm-Spekula
Rectal Specula
Espéculos rectales
Specoli rettali



CZERNY
69105-22
22 cm, 8 ³/₄"



SIMS
69110-15
15 cm, 6"



BODENHAMMER
69115-15
15 cm, 6"

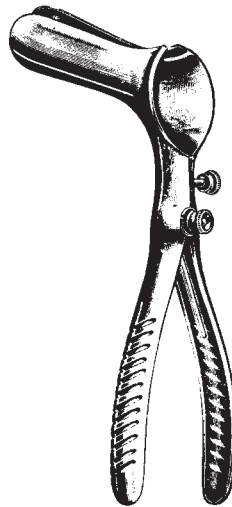

PRATT
69121-00
19 cm, 7 ¹/₂"

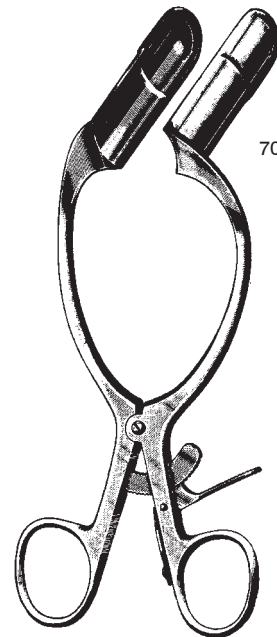

BARR
69125-17
17 cm, 6 ³/₄"

Mastdarm-Spekula
Rectal Specula
Espéculos rectales
Specoli rettali

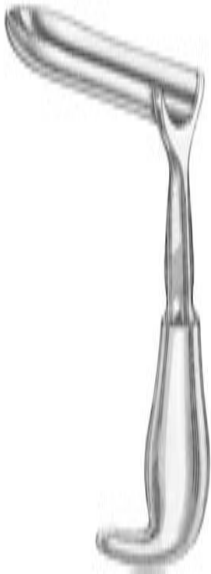

HILL-FERGUSON, 20 cm, 8"
69126-01 6,4x2,2 cm 2 1/2" x 7/8"
69126-02 7,6x3,0 cm 3" x 1 3/16"
69126-03 7,6x3,6 cm 3" x 1 7/16"

SAWYER, 25 cm, 9 3/4"
69127-01 6,4x2,2 cm 2 1/2" x 7/8"
69127-02 7,6x2,9 cm 3" x 1 1/8"
69127-03 8,9x3,8 cm 3 1/2" x 1 1/2"

MATHIEU
69130-19
19,5 cm, 7 3/4"



SCHULZE-BERGMANN
69142-06 - 69142-12

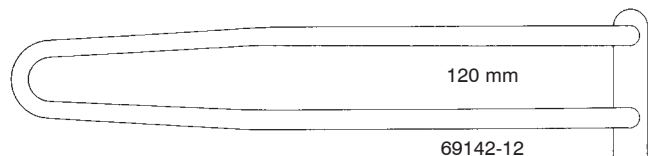
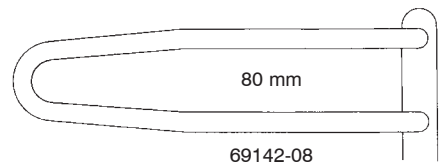
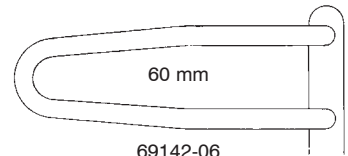

Analspreizer
 Anal Retractors
 Separadores rectales
 Dilatatori per l'ano e il retto

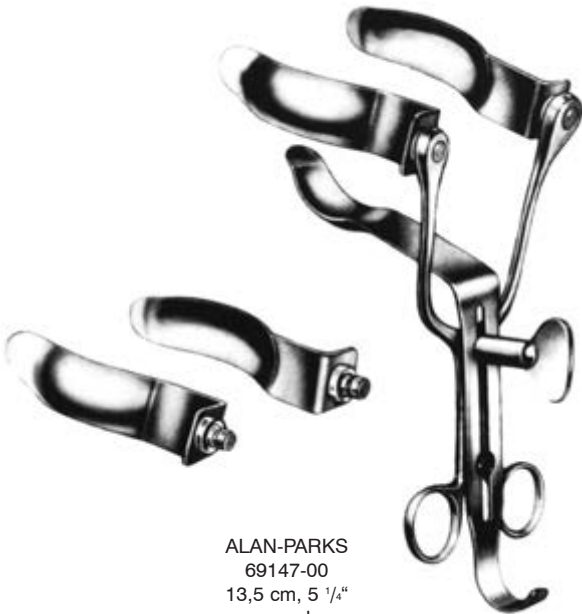

ALAN-PARKS
 69147-00
 13,5 cm, 5 1/4"
 compl.

- 69147-01 Sperrer allein
 Spreader only
 Separador rectal solo
 Solo telaio senza valve
- 69147-02 Mittelblatt allein
 Center blade, only
 Valva central, solo
 Valva centrale, sola
- 69147-03 Blatt allein 75 mm, 3"
 Blade only 75 mm, 3"
 Valva sola 75 mm, 3"
 Valva sola 75 mm, 3"
- 69147-04 Blatt allein 95 mm, 3 3/4"
 Blade only 95 mm, 3 3/4"
 Valva sola 95 mm, 3 3/4"
 Valva sola 95 mm, 3 3/4"

69148-00
 Kaltlicht Zubehör für 69147-00
 Cold Light Attachment for 69147-00
 Adaptador para luz fría 69147-00
 Adattatore luce fredda per 69147-00

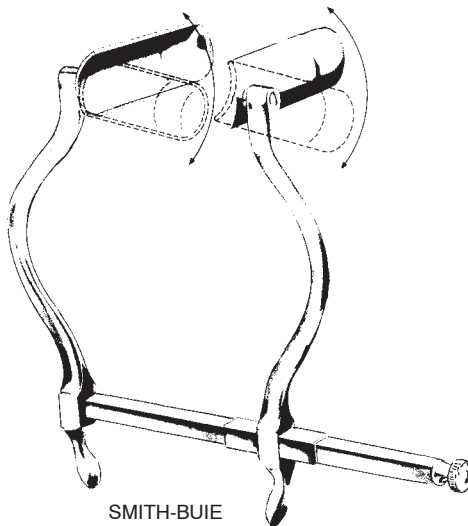

SMITH-BUIE
 69150-15
 15 cm, 6"
 75x23 mm

Anuskope, Proktoskope
 Anoscopes, Proctoscopes
 Anoscopios, Proctoscopios
 Anoscopi, Protoscopi

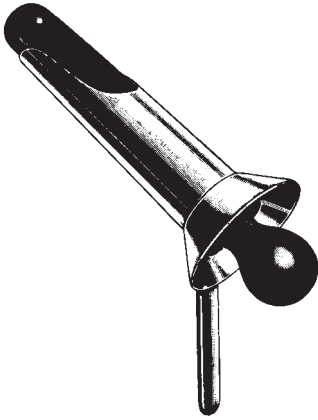

IVES-FANSLER
 69210-22 22 mm Ø
 L = 80 mm



Ø mm HIRSCHMANN
 16 69212-16
 19 69212-19
 22 69212-22
 L = 65 mm



mm
 ØxL KELLY
 22x 50 69220-05
 22x100 69220-10
 22x140 69220-14
 22x200 69220-20

Sphinkteroskope, Proktoskope, Fistelsonde
 Sphincteroscopes, Proctoscopes, Fistula Probe
 Sfinteroscopios, Proctoscopios, Sondas para fistulas
 Sfinteroscopi, Protoscopi, Sonde per fistole



Ø mm KELLY
 21 69224-21
 27 69224-27
 L = 50 mm, 2"

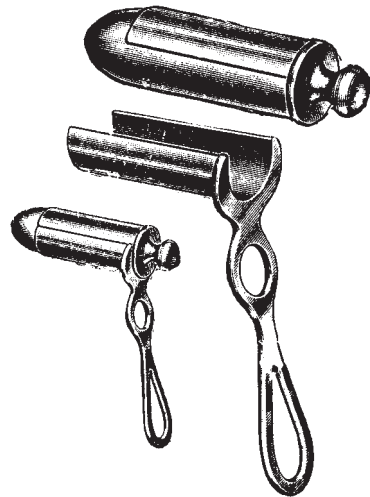

Ø mm CHELSEA-EATON
 22 x 65 69225-22
 30 x 65 69225-30



Fig. 1
 69251-01



Fig. 2
 69251-02



Fig. 3
 69251-03

PRATT
 21 cm, 8 1/4"
 69251-01 - 69251-03

Proktoskope
Proctoscopes
Proctoscopios
Protoscopi

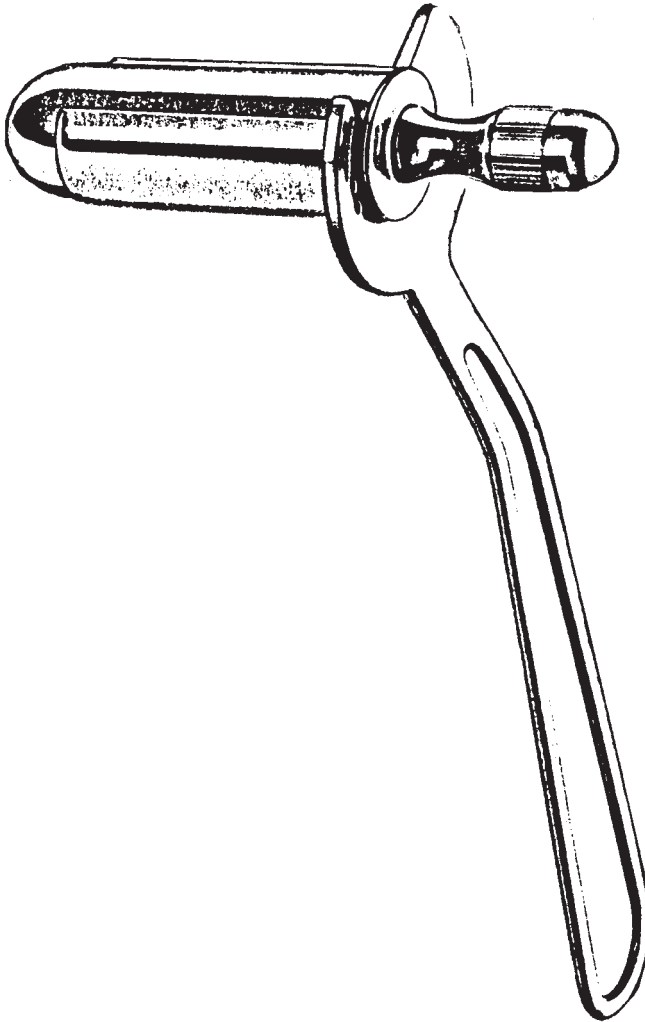

Ø	L	FANSLER, 24 cm, 9 1/2"
25 x 65 mm		69226-25
29 x 65 mm		69226-29
38 x 70 mm		69226-38

Proktoskope
Proctoscopes
Proctoscopios
Protoscopi

**MORGAN**

69227-01	17 mm Ø	L=65 mm
69227-02	17 mm Ø	L=80 mm
69227-03	20 mm Ø	L=65 mm
69227-04	20 mm Ø	L=80 mm
69227-05	24 mm Ø	L=65 mm
69227-06	24 mm Ø	L=80 mm

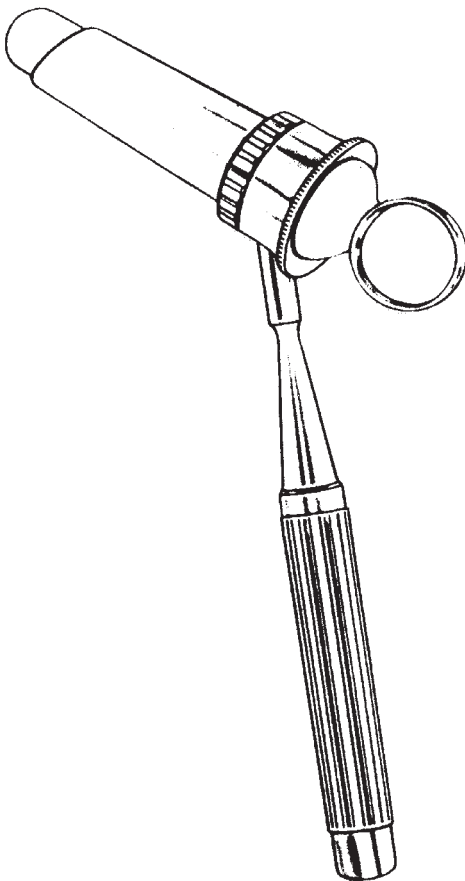
**BENSAUDE**

69229-01	19 mm Ø	L=70 mm
69229-02	22 mm Ø	L=70 mm



69228-01

Beleuchtungsstab für MORGAN
Illumination attachment for MORGAN
Mango con iluminación para MORGAN
Dispositivo Illuminativo per MORGAN

Rektal Absaugrohr, Rektalschnürer, Mastdarmbiopsiezangen
 Rectal aspiration cannula, Rectal snare, Rectal Biopsy Specimen Forceps
 Cánula de aspiración rectal, Cierra-nudo rectal, Pinzas para biopsia rectal
 Cannula d'aspirazione rettale, Serranodi, Pinze taglianti per biopsia rettale



BUIE
 69261-41
 41 cm, 16"

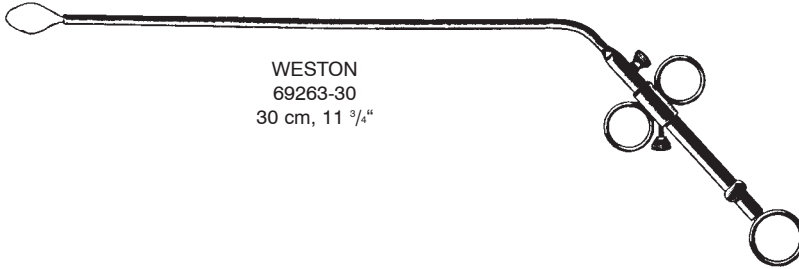

WESTON
 69263-30
 30 cm, 11 3/4"



YEOMAN
 69301-28 - 69304-42

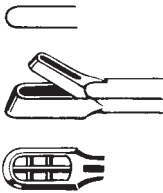

Fig. 1
 69301-28 28 cm, 11"
 69301-35 35 cm, 13 3/4"
 69301-42 42 cm, 16 1/2"

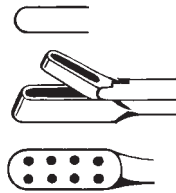

Fig. 2
 69302-28 28 cm, 11"
 69302-35 35 cm, 13 3/4"
 69302-42 42 cm, 16 1/2"

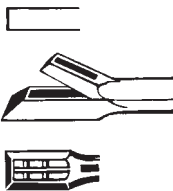

Fig. 3
 69303-28 28 cm, 11"
 69303-35 35 cm, 13 3/4"
 69303-42 42 cm, 16 1/2"

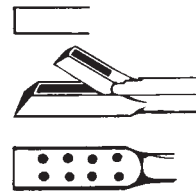
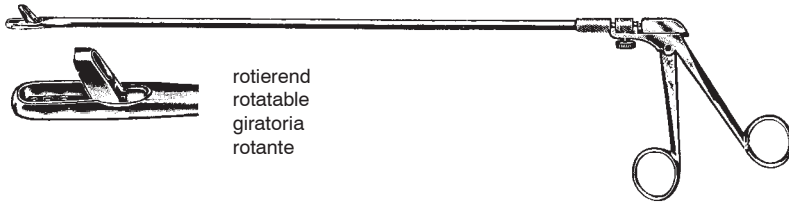

Fig. 4
 69304-28 28 cm, 11"
 69304-35 35 cm, 13 3/4"
 69304-42 42 cm, 16 1/2"

Mastdarm-Biopsiezangen, Hämorrhoidalzange
 Rectal Biopsy Specimen Forceps, Haemorrhoidal Forceps
 Pinzas para biopsia rectal, Pinzas-clamps hemorroidales
 Pinze taglienti per biopsia rettale, Pinze per emorroidi



rotierend
 rotatable
 giratoria
 rotante

YEOMANN
 69311-23 23 cm, 9"
 69311-33 33 cm, 13"
 69311-40 40 cm, 15 3/4"

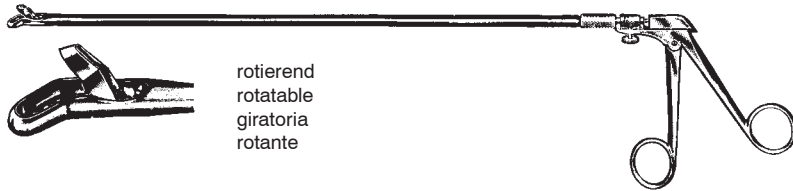

rotierend
 rotatable
 giratoria
 rotante

TURREL
 69321-23 23 cm, 9"
 69321-33 33 cm, 13"
 69321-40 40 cm, 15 3/4"



HEYWOOD-SMITH
 69402-21 21 cm, 8 1/4"
 69402-25 25 cm, 10"

Hämorrhoidal-Ligatoren, Hämorrhoidal-Fasszange
 Haemorrhoidal Ligators, Haemorrhoidal Forceps
 Ligadores para hemorroides, Pinzas-clamps para hemorroides
 Legatori emorroidali, Pinze per emorroidi

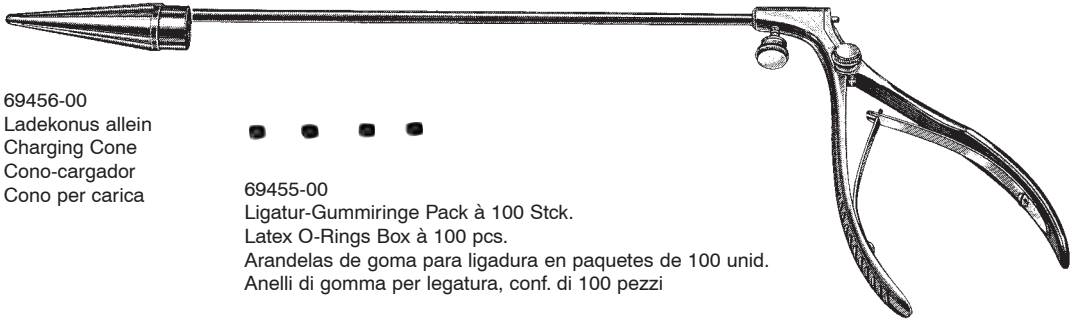

69456-00
 Ladekonus allein
 Charging Cone
 Cono-cargador
 Cono per carica



69455-00
 Ligatur-Gummiringe Pack à 100 Stck.
 Latex O-Rings Box à 100 pcs.
 Arandelas de goma para ligadura en paquetes de 100 unid.
 Anelli di gomma per legatura, conf. di 100 pezzi

MC GIVNEY
 69450-18
 18 cm, 7"

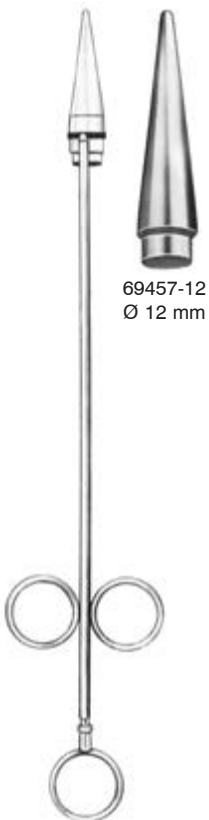

69457-12
 Ø 12 mm

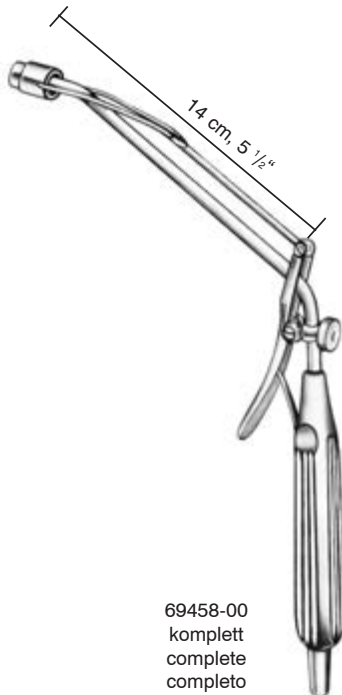

69458-00
 komplett
 complete
 completo



Ø 10 mm
 69458-10
 Ladekonus
 Charging cone
 Cono-cargador
 Cono per carica



Ø 10 mm
 69458-11 11 mm
 69458-16 16 mm
 Saugkopf
 Aspiration tip
 Cabeza de aspiración
 Testa d'aspirazione

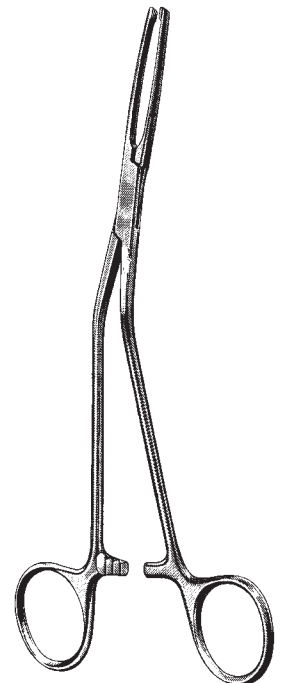

MC GIVNEY
 69460-00
 19 cm, 7 1/2"

RUDD
 69457-31
 31,5 cm, 12 1/2"
 kplt./cpt.

Lateral-Scheidenspekula
 Lateral Vaginal Retractor
 Espéculos vaginales
 Specoli vaginali



71100-00

Lateralspreizer allein
 Vaginal retractor lateral only
 Espéculo vaginal solo
 Specolo vaginale laterale, solo

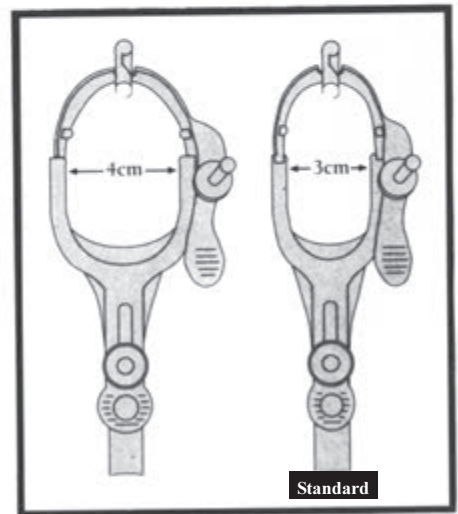

VU-MORE

Fig.	mm	
2	95x35	71115-02
3	115x35	71115-03

Scheidenspekula
Vaginal Specula
Espéculos vaginales
Specoli vaginali

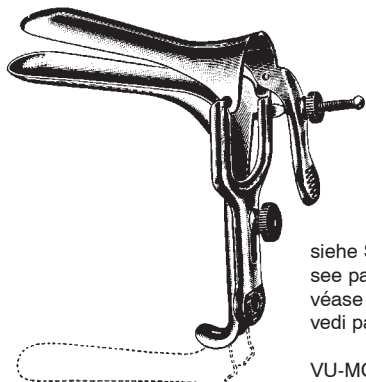

siehe Seite 569
see page no. 569
véase pagina no. 569
vedi pagina nr. 569

VU-MORE

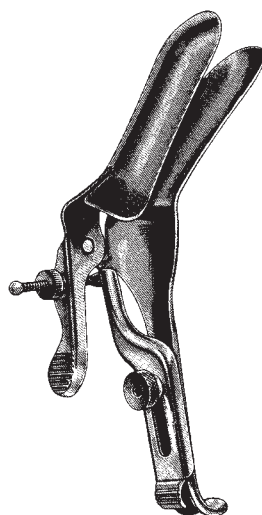

rechts offen
open right-side
abierto a la derecha
aperta a destra

GRAVE

71116-02

mittel, medium, mediano, medio
101x35 mm

GRAVE

Fig.	mm	Standard
1	75x20	71110-01
2	95x35	71110-02
3	115x35	71110-03

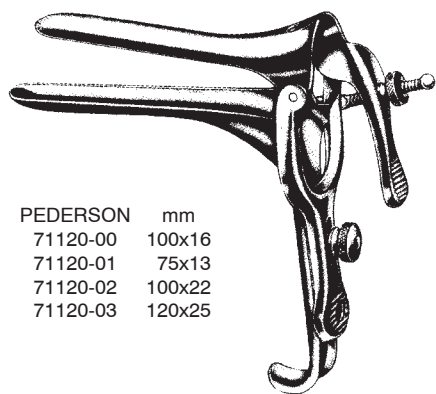

Fig.	PEDERSON	mm
	71120-00	100x16
1	71120-01	75x13
2	71120-02	100x22
3	71120-03	120x25

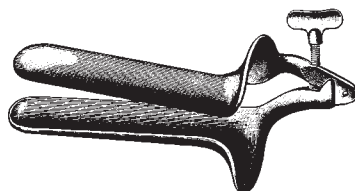
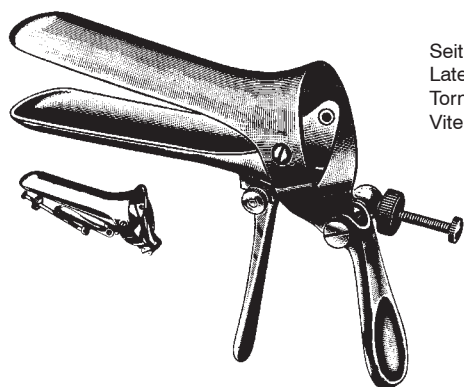

Fig.	COLLIN	mm
1	71130-01	85x30
2	71130-02	100x35
3	71130-03	110x40



Seitliche Schraube
Lateral Screw
Tornillo lateral
Vite laterale

CUSCO

Fig.	mm	Standard
1	75x32	71140-01
2	85x35	71140-02
3	100x35	71140-03
4	75x17	71142-04

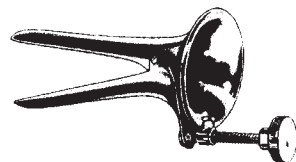

COLLIN
71132-00
65x10 mm

für Jungfrauen
for virgin
para vírgenes
per vergini

Scheidenspekula
 Vaginal Specula
 Espécúlos vaginales
 Specoli vaginali

Mittelschraube
 Central Screw
 Tornillo central
 Vite centrale

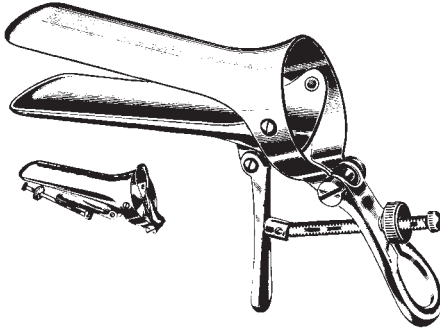

Fig.	CUSCO	mm
1	71150-01	75x32
2	71150-02	85x35
3	71150-03	100x37

Schweizer Modell
 Swiss Pattern
 Modelo suizo
 Modello svizzero

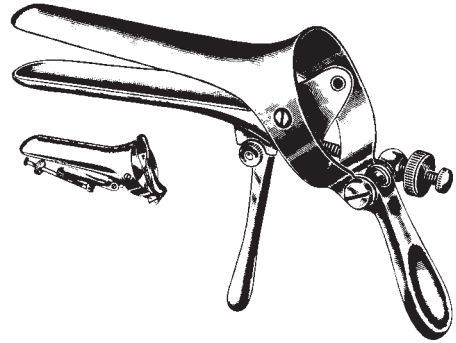
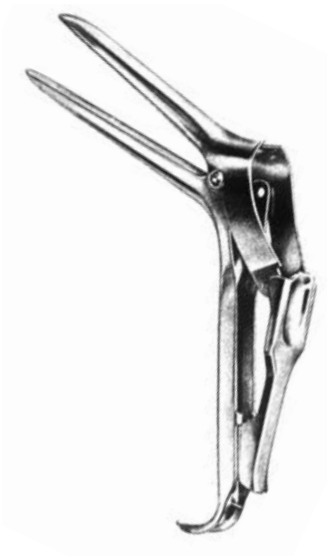

Fig.	CUSCO	mm
1	71160-01	90x23-25
2	71160-02	100x25-27
3	71160-03	110x27-30



SEMM		mm
71161-17	100 x 17 - 20 mm	
71161-25	100 x 25 - 30 mm	



Fig.	TRÉLAT	mm
1	71170-01	85x33
2	71170-02	95x35
3	71170-03	115x43

Scheidenspekula
Vaginal Specula
Espéculos vaginales
Specoli vaginali

Satz bestehend aus je 1 Spekula und 1 Halter
Set consisting of 1 specula and 1 retractor
Juego de 1 espéculo y 1 valva
Serie da 1 specolo e 1 valva

Spekula
Speculum
Espéculo
Specolo

Halter
Retractor
Valva
Valve



Fig. KRISTELLER
1 71210-01
2 71210-02
3 71210-03

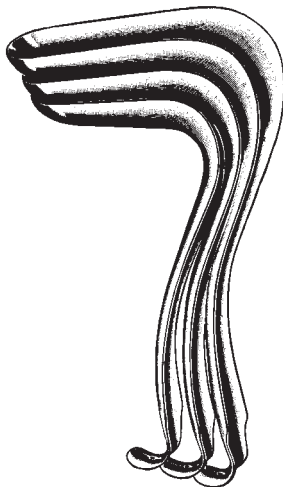

Fig. KRISTELLER mm
1 71211-01 70x27
2 71211-02 80x30
3 71211-03 90x36



Fig. KRISTELLER mm
1 71212-01 75x23
2 71212-02 85x26
3 71212-03 100x32



Fig. KRISTELLER
00 71240-00
0 71240-10
1 71240-01
2 71240-02
3 71240-03

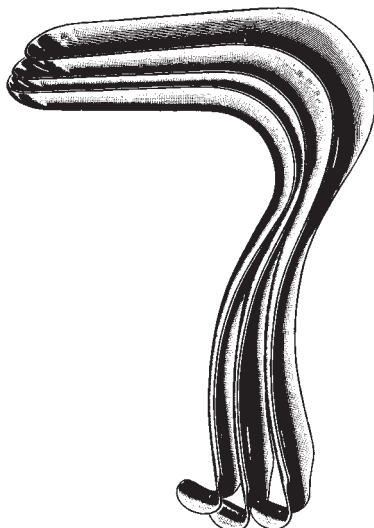

Fig. KRISTELLER mm
00 71241-00 110x18
0 71241-10 110x21
1 71241-01 110x27
2 71241-02 110x30
3 71241-03 110x36

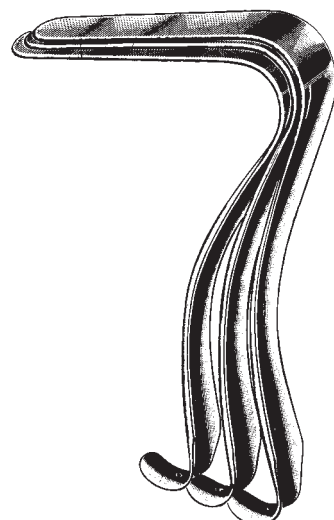

Fig. KRISTELLER mm
00 71242-00 115x14
0 71242-10 115x17
1 71242-01 115x23
2 71242-02 115x26
3 71242-03 115x32

Scheidenspekula
Vaginal Specula
Espéculos vaginales
Specoli vaginali



KALLMORGEN
71260-01 - 71262-02

Fig.	Satz	Spekula	Halter	mm
	Set	Speculum	Retractor	
	Juego	Espéculo	Valva	
	Serie	Specolo	Valve	mm
1	71260-01	71261-01	71262-01	70x33
2	71260-02	71261-02	71262-02	90x33

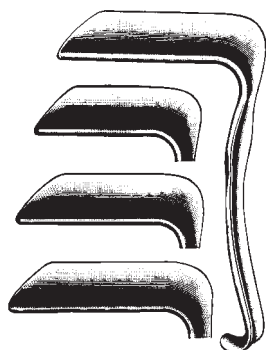

Fig.	JACKSON	mm
1	71271-01	75x38
2	71271-02	90x38
3	71271-03	100x38



Fig.	SIMS	mm
1	71281-01	63x32
2	71281-02	76x32
3	71281-03	89x38



Fig.	SIMS	mm
1	71291-01	60x25+30
2	71291-02	70x30+35
3	71291-03	80x35+40
Set	71291-00	(Fig. 1,2,3)

Scheidenspekula
Vaginal Specula
Espéculos vaginales
Specoli vaginali



DELEE
71300-01
23,5 cm, 9 1/4"

leicht hohl
slightly concave
ligeramente concavos
leggermente concavi

Fig.		mm
1	71301-01	55x35
2	71301-02	85x35
3	71301-03	115x35

Fig.		mm
1	71303-01	55x45
2	71303-02	85x45
3	71303-03	115x45
4	71303-04	160x45
5	71303-05	180x45

Fig.		mm
1	71305-01	55x60
2	71305-02	85x60
3	71305-03	115x60
4	71305-04	160x60
5	71305-05	180x60



35 mm
1.4"



45 mm
1.8"



60 mm
2.4"

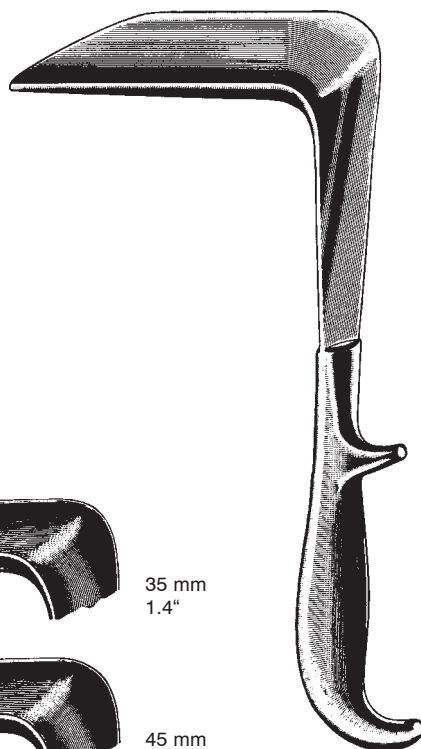

DOYEN
24 cm, 9 1/2"

Scheidenspekula
Vaginal Specula
Espéculos vaginales
Specoli vaginali

71306-01
80 x 30 mm

71306-02
85 x 35 mm

71306-03
90 x 40 mm



71306-04
Gewicht 400 gr
weight 400 grs
peso 400 grs
peso 400 grs

71306-05
Gewicht 800 gr
weight 800 grs
peso 800 grs
peso 800 grs



71306-01 - 71306-03

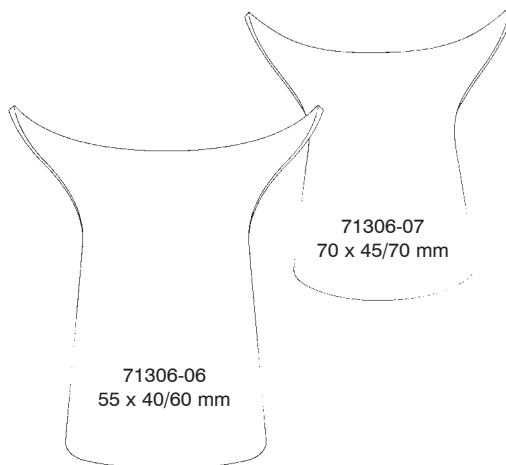
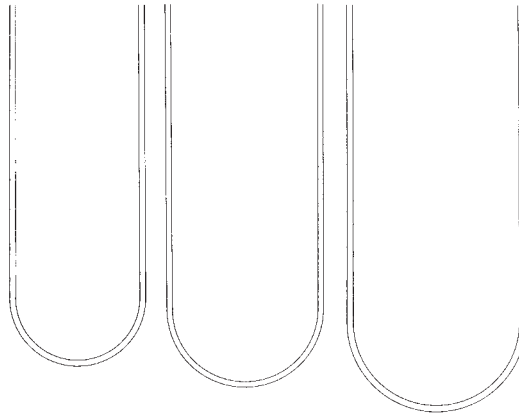

71306-07
70 x 45/70 mm

71306-06
55 x 40/60 mm

SCHERBAK
71306-00
Set komplett
complete set
juego completo
set completo



71306-08
Griff, handle,
mango, manico

Scheidenspekula
Vaginal Specula
Espéculos vaginales
Specoli vaginali



O'SULLIVAN-O'CONNOR
71308-00



Fig. 1 = 45 x 17 mm 71308-01
Fig. 2 = 90 x 37 mm 71308-02
Fig. 3 = 90 x 45 mm 71308-03

71308-00

komplett bestehend aus:

1 Rahmen mit 2 beweglichen Seitenvalven
3 austauschbare Mittelvalven Fig. 1-3

1 frame with 2 mobile lateral blades
3 interchangeable blades Fig. 1-3

1 Marco con 2 separadores móviles laterales
3 separadores centrales intercambiables fig. 1-3

1 telaio regolabile con 2 valve laterali mobili
3 valve intercambiabili fig. 1-3

71308-04
Rahmen allein
Frame only
Marco solo
Telaio solo

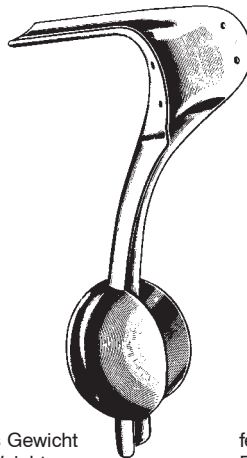

abnehmbares Gewicht
Detachable Weight
Peso desmontable
Peso smontabile

71307-00
1,4 kg
75 x 38 mm

AUVARD
24 cm, 9 1/2"

festes Gewicht
Fixed Weight
Peso fijo
Peso fisso

71309-00
1,4 kg
105 x 38 mm

Scheidenspekula, Endospekula
 Vaginal Specula, Endospecula
 Espéculos vaginales, Endo-espéculos
 Specoli vaginali, Endospecoli



mm	BREISKY	
100x20	71310-20	28 cm, 11"
100x25	71310-25	28 cm, 11"
100x30	71310-30	28 cm, 11"
100x35	71310-35	28 cm, 11"
100x40	71310-40	28 cm, 11"
130x20	71313-20	33 cm, 13"
130x25	71313-25	33 cm, 13"
130x30	71313-30	33 cm, 13"
130x35	71313-35	33 cm, 13"
130x40	71313-40	33 cm, 13"
155x40	71315-40	35 cm, 13 3/4"



mm	LANDAU	
100x28	71319-28	29 cm, 11 1/2"
100x38	71319-38	29 cm, 11 1/2"

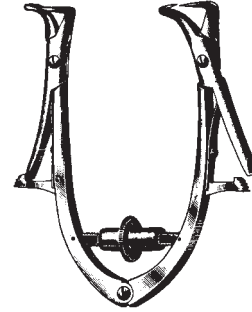

	JOLL (FRIEDMANN)	
71351-10		10 cm, 4"
71351-15		15 cm, 6"



	KOGAN	
71360-24	3 mm	24 cm, 9 1/2"
71361-24	4 mm	24 cm, 9 1/2"
71362-24	5 mm	24 cm, 9 1/2"



	KOGAN	
71363-24	3 mm	24 cm, 9 1/2"
71364-24	4 mm	24 cm, 9 1/2"
71365-24	5 mm	24 cm, 9 1/2"

Uterus Dilatatore
 Uterine Dilators
 Dilatadores uterinos
 Dilatatori uterini

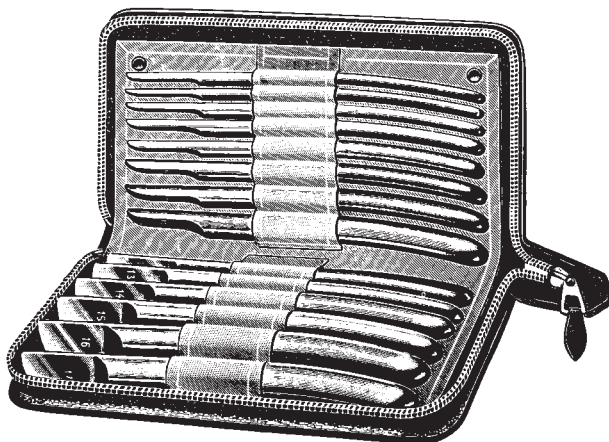

HEGAR
 71405-14 4-17 mm
 14 St./pces./pzas./pezzi

mm Ø	HEGAR	mm Ø
1	71410-01	71415-01 1,5
2	71410-02	71415-02 2,5
3	71410-03	71415-03 3,5
4	71410-04	71415-04 4,5
5	71410-05	71415-05 5,5
6	71410-06	71415-06 6,5
7	71410-07	71415-07 7,5
8	71410-08	71415-08 8,5
9	71410-09	71415-09 9,5
10	71410-10	71415-10 10,5
11	71410-11	71415-11 11,5
12	71410-12	71415-12 12,5
13	71410-13	71415-13 13,5
14	71410-14	71415-14 14,5
15	71410-15	71415-15 15,5
16	71410-16	71415-16 16,5
17	71410-17	71415-17 17,5
18	71410-18	71415-18 18,5
19	71410-19	71415-19 19,5
20	71410-20	
21	71410-21	
22	71410-22	
23	71410-23	
24	71410-24	
25	71410-25	
26	71410-26	
27	71410-27	
28	71410-28	
29	71410-29	
30	71410-30	

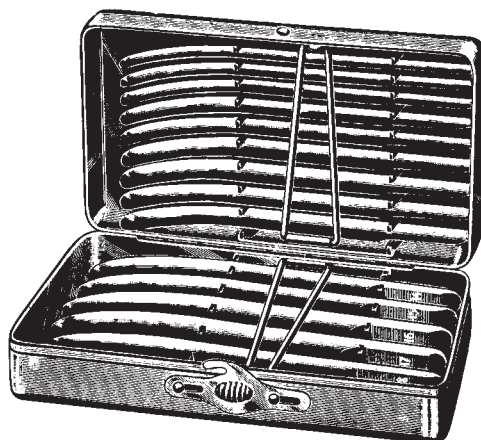

mm HEGAR
 4-17 71406-14 14 St./pces./pzas./pezzi
 1-26 71406-26 26 St./pces./pzas./pezzi

71404-14 Satz/Set/Juego/Set
 71410-04 - 71410-17 = 14

71404-26 Satz/Set/Juego/Set
 71410-01 - 71410-26 = 26

in Metalletui, in metal case,
 en estuche de metal, in astuccio metallico

Uterus Dilatatore
 Uterine Dilators
 Dilatadores uterinos
 Dilatatori uterini

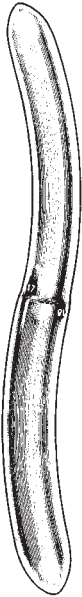

mm	HEGAR
1/ 2	71420-01
3/ 4	71420-03
5/ 6	71420-05
7/ 8	71420-07
9/10	71420-09
11/12	71420-11
13/14	71420-13
15/16	71420-15
17/18	71420-17
19/20	71420-19
21/22	71420-21
23/24	71420-23
25/26	71420-25

71424-08 Satz/Set/Juego/Set
 71420-03 - 71420-17 = 8
 3/4 - 17/18 mm

71424-13 Satz/Set/Juego/Set
 71420-01 - 71420-25 = 13
 1/2 - 25/26 mm

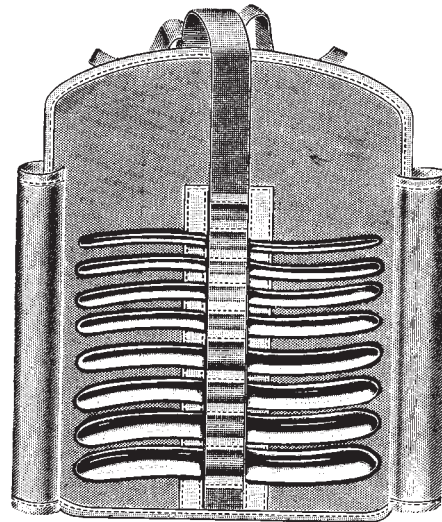

mm HEGAR
 3/4 - 17/18 71425-08 8 St./pces./pzas./pezzi

in Stofftasche, in khaki roll,
 en bolsa de tela, in borsa di tela

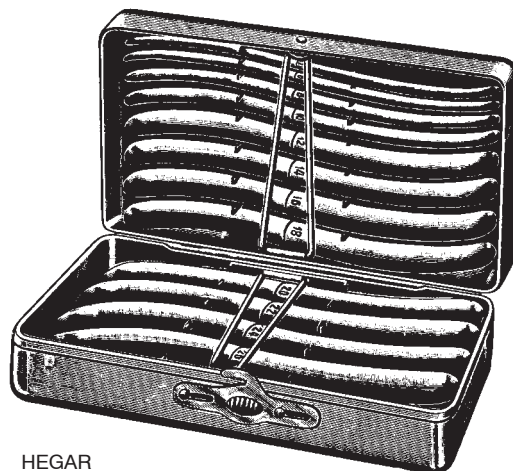

mm HEGAR
 3-4 - 17/18 71426-08 8 St./pces./pzas./pezzi
 1/2 - 25/26 71426-13 13 St./pces./pzas./pezzi

in Metalletui, in metal case,
 en estuche de metal, in astuccio metallico

Uterus Dilatatore
 Uterine Dilators
 Dilatadores uterinos
 Dilatatori uterini

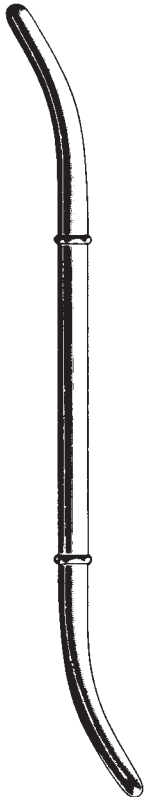

in Stofftasche
 in khaki roll
 en bolsa de tela
 in borsa di tela

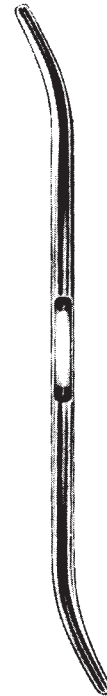
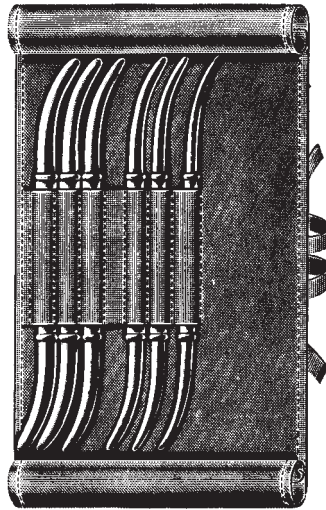

Fig.	mm/Ø	HANK
9/10	4,5/5	71430-10
11/12	5,5/6	71430-12
13/14	6,5/7	71430-14
15/16	7,5/8	71430-16
17/18	8,5/9	71430-18
19/20	9,5/10	71430-20

71436-06
 Satz, set, juego, serie = 6

Fig./U.S.	mm/Ø	PRATT
13/15	4,5/5	71438-13
17/19	5,6/6,3	71438-17
21/23	7/7,6	71438-21
25/27	8,3/9	71438-25
29/31	9,6/10,3	71438-29
33/35	11/11,6	71438-33
37/39	12,3/13	71438-37
41/43	13,6/14,3	71438-41

71438-00
 Satz, set, juego, serie = 8

Uterus Dilatatore
Uterine Dilators
Dilatadores uterinos
Dilatatori uterini

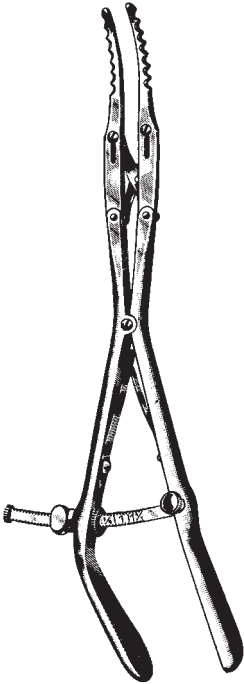

GOODELL
71441-34
34 cm, 13 1/2"

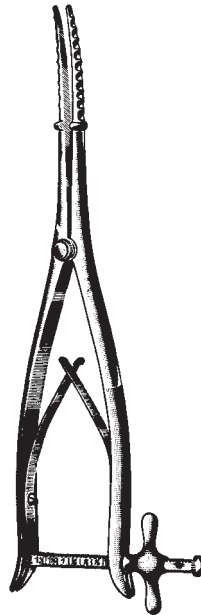

WYLIE
71443-29
29 cm, 11 1/2"

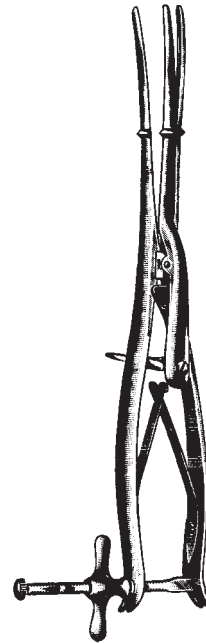

SIMS
71445-29
29 cm, 11 1/2"

Hakenzangen
 Tenaculum Forceps
 Pinzas para coger el cuello del útero
 Pinze per abbassare il collo dell'utero



ADAIR
 71500-18
 19 cm, 7 1/2"

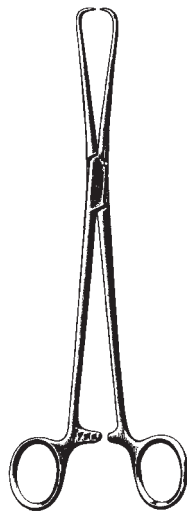

SCHRÖDER (POZZI)
 71502-25
 25 cm, 10"



POZZI-PALMER
 71503-25
 25 cm, 10"

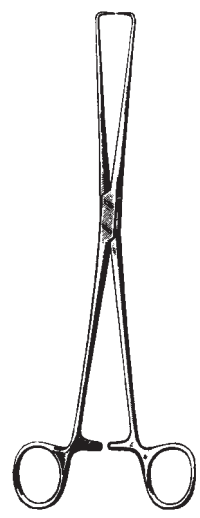

BRAUN
 71504-25
 25 cm, 10"

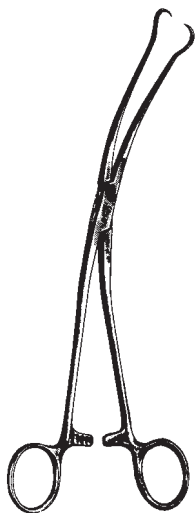

SKENE
 71505-24
 24 cm, 9 1/2"

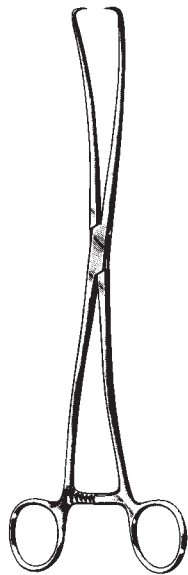

DUPLAY
 71507-28
 28 cm, 11"

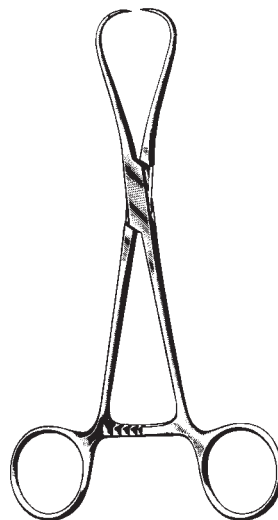

STAUDE-MOORE
 71508-17
 17 cm, 6 3/4"

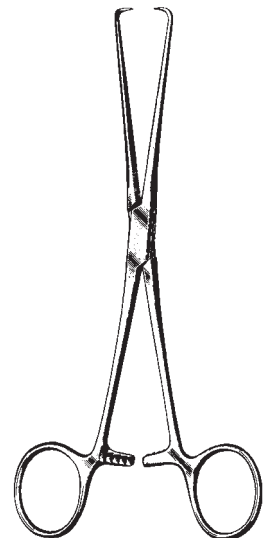

BARRETT
 71510-18
 18 cm, 7"

Hakenzangen
 Tenaculum Forceps, Vulsellum Forceps
 Pinzas para coger el cuello del útero
 Pinze per abbassare il collo dell'utero

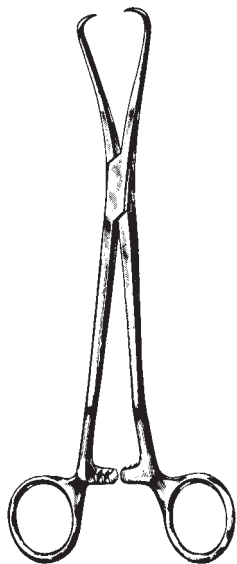

JARCHO
 71512-20
 20 cm, 8"

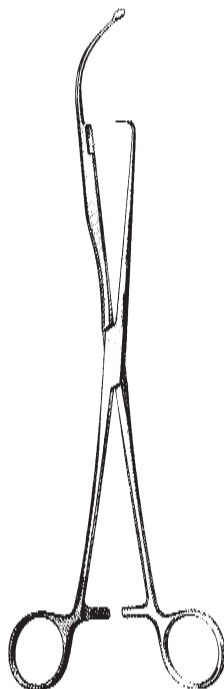

HULKA
 71512-28
 28 cm, 11"

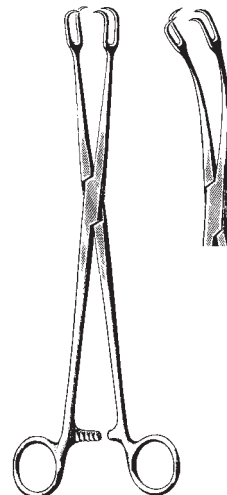

SCHRÖDER
 71514-24 71515-24
 24 cm, 9 1/2"

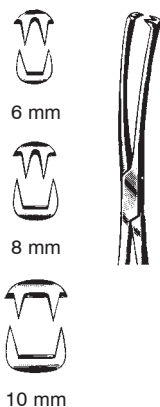
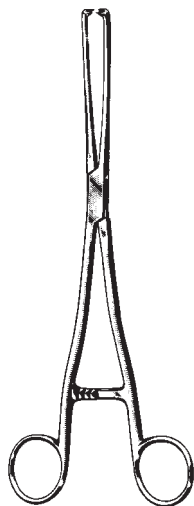

MUSEUX
 71524-06 6 mm 71525-06
 71524-08 8 mm 71525-08
 71524-10 10 mm 71525-10
 24 cm, 9 1/2"

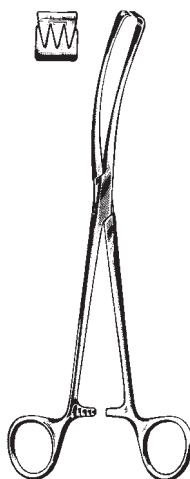

TEALE
 71531-23
 23 cm, 9"

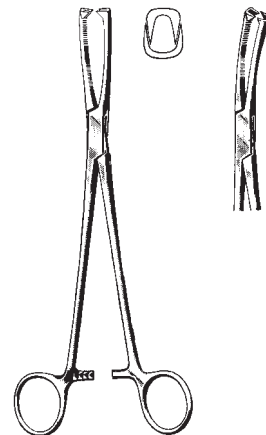

JACOBS
 71532-21 71533-21
 21 cm, 8 1/4"

Hakenzangen

Tenaculum Forceps, Vulsellum Forceps

Pinzas para coger el cuello del útero

Pinze per abbassare il collo dell'utero

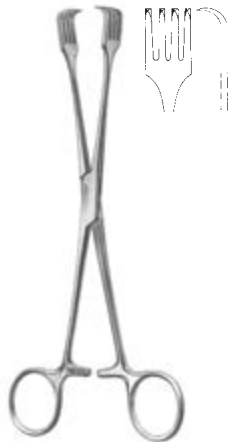

CZERNY
71536-21
20 cm, 8"



PRATT
71536-28
28 cm, 11"



SCHRÖDER
71537-27
27 cm, 10 1/2"

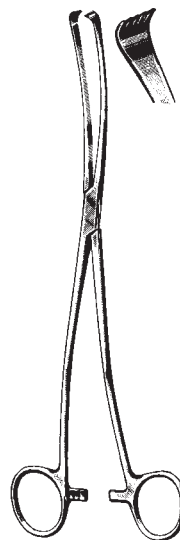

IOWA
71539-26
26 cm, 10 1/4"

Uterus Polypenzangen, Uterus-Faßzangen
 Uterine Polypus Forceps, Uterine Elevating Forceps
 Pinzas para pólipos uterinos, Pinzas para el útero
 Pinze per polipi uterini, Pinze per afferrare l'utero

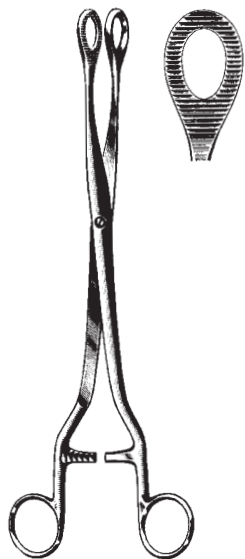

NOTO
 71540-27
 27 cm, 10 1/2"

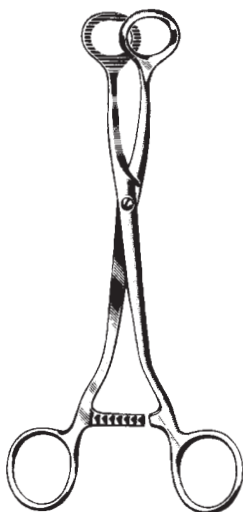

DOYEN
 71542-20
 20 cm, 8"

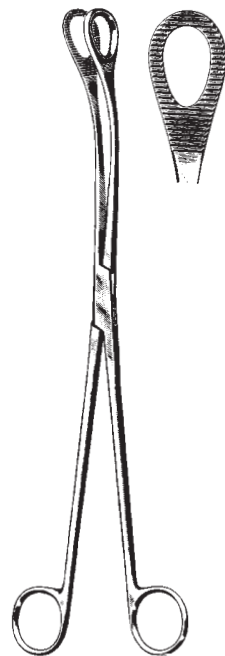

KELLY
 71543-32
 32 cm, 12 3/4"



DARTIGUES
 71545-27
 27 cm, 10 1/2"



SOMER
 71547-23
 23 cm, 9"

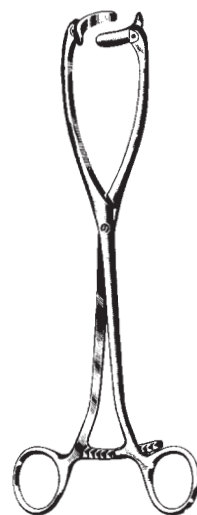

COLLIN
 71549-25
 25 cm, 10"

Amniotom, Uterus Depressoren, Uterus-Sonden
 Amniotome, Uterine Depressors, Uterine Sounds
 Amniótomo, Depresores uterinos, Histerómetros
 Amniotomo, Depressori uterini, Isterometri



BEACHAM
 71559-26
 26 cm, 10 1/4"



BRAUN
 71565-28
 28 cm, 11"



SIMS
 71567-26
 26 cm, 10 1/4"



fest
 rigid
 rigido
 rigida

SIMS

71580-32
 32 cm, 12 3/4"

biegsam
 malleable
 maleable
 malleabile

71581-32



fest
 rigid
 rigido
 rigida

MARTIN

71582-32
 32 cm, 12 3/4"

biegsam
 malleable
 maleable
 malleabile

71583-32



COLLIN
 71584-28
 28 cm, 11"



VALLEIX
 71585-25
 25 cm, 10"

Saugküretten, Biopsieküretten
 Biopsy Curettes
 Curetas para biopsia
 Curette per biopsia

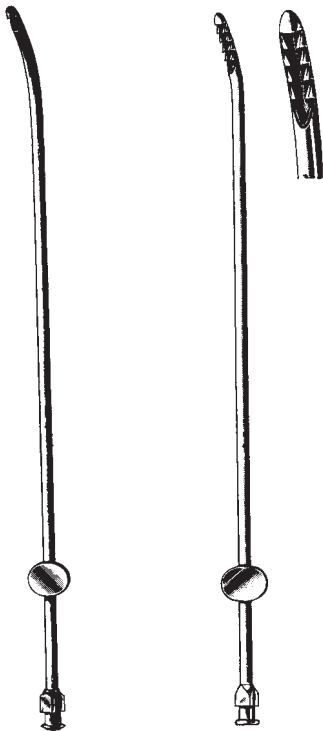

RANDALL
 71590-04
 24 cm, 9 1/2"
 Ø 4 mm

NOVAK
 71592-01 Ø 1 mm
 71592-02 Ø 2 mm
 71592-03 Ø 3 mm
 71592-04 Ø 4 mm



HEANY
 71593-00
 22,5 cm, 9"



71594-40
 ohne Korb
 without basket
 sin cesta
 senza cestello

71596-40
 mit Korb
 with basket
 con cesta
 con cestello

KEVORKIAN
 4,0 mm
 30 cm, 11 3/4"

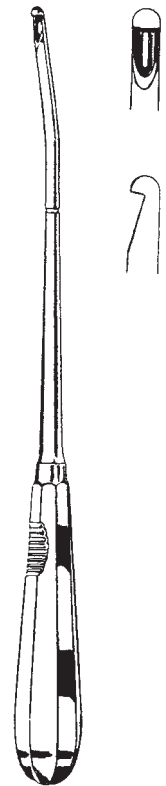

MOD. MUENCHEN
 71598-27
 27 cm, 10 1/2"

mit Luer-Lock Ansatz
 with Luer-Lock connection
 con conexión Luer-Lock
 con raccordo Luer-Lock

Biopsiezangen
 Biopsy Forceps
 Pinzas para biopsia
 Pinze taglienti per biopsia



71604-01
5 mm

71604-02
7 mm

SCHUMACHER
24 cm, 9 1/2"



SCHUBERT
71604-21 21 cm, 8 1/4"
71604-28 28 cm, 11"



SCHUBERT
71605-26
26 cm, 10 1/4"



THOMS-GAYLOR
71606-24
24 cm, 9 1/2"



van DOREN
71611-25
25 cm, 10"



FAURE
71612-21
21 cm, 8 1/4"

Uterus Biopsiezangen
 Biopsy Specimen Forceps
 Pinzas para biopsia
 Pinze per biopsia

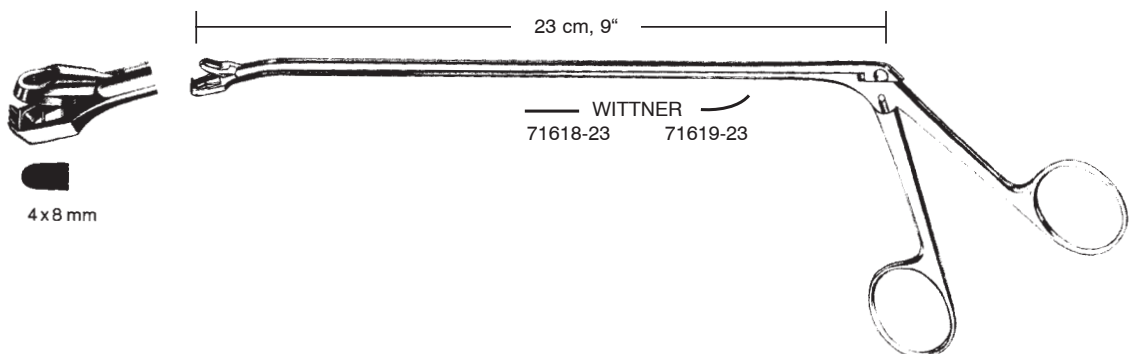
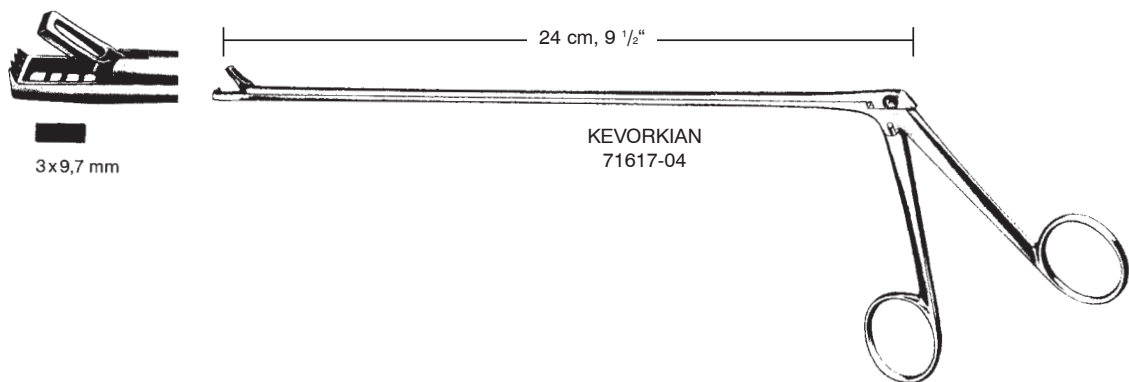
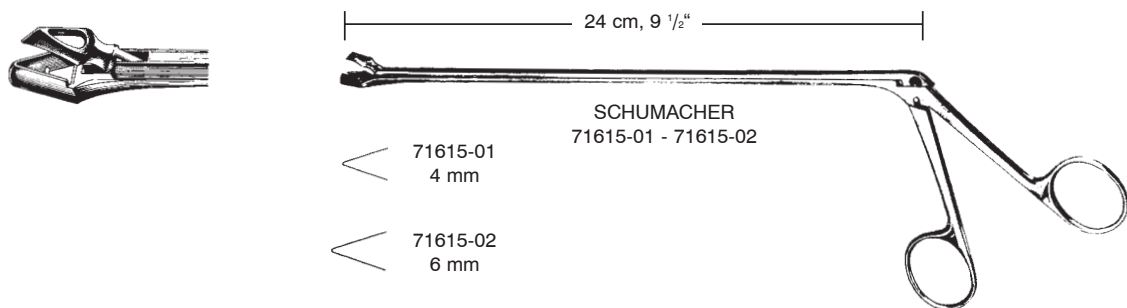
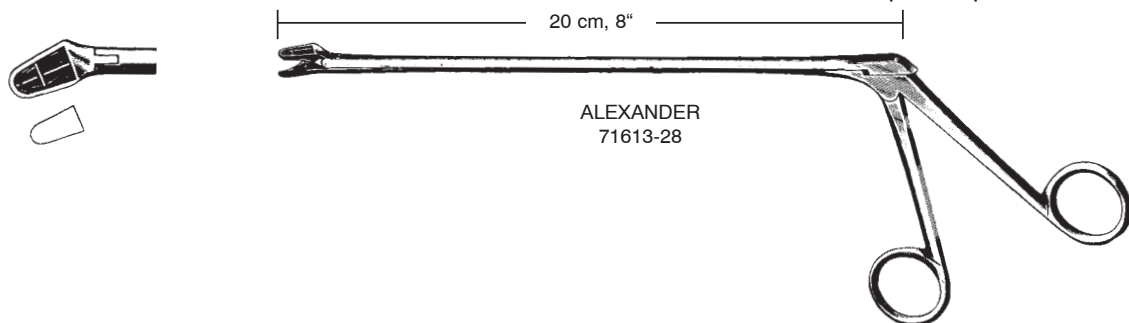

Uterus Biopsiezangen
 Biopsy Specimen Forceps
 Pinzas sacabocado p. biopsia
 Pinze per biopsia

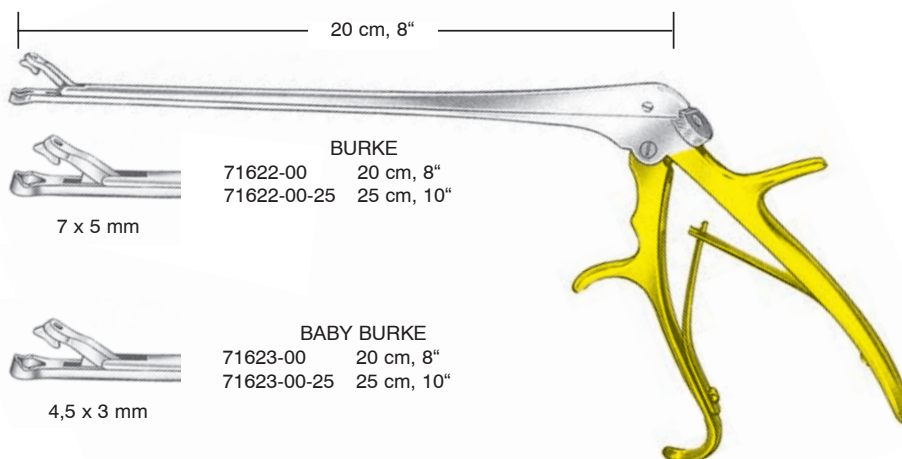
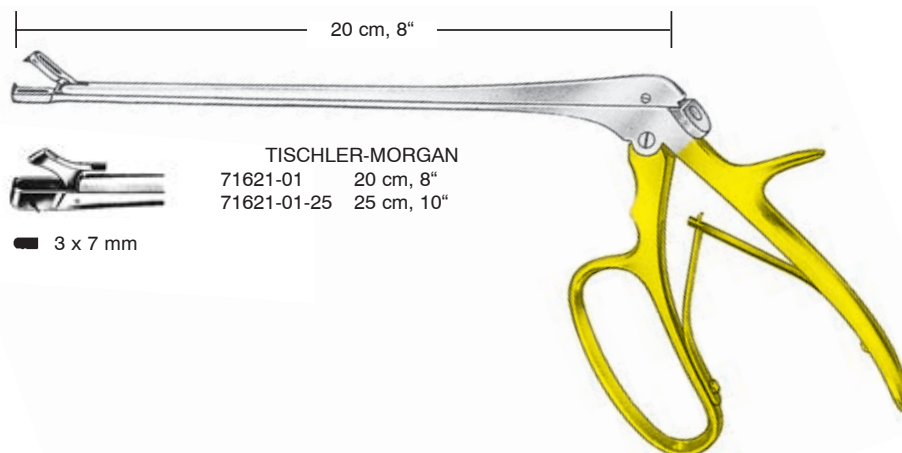
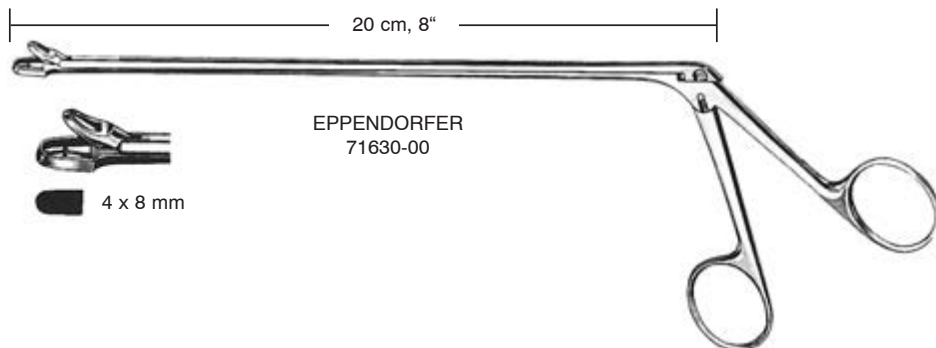

Uterus Biopsiezangen
 Biopsy Specimen Forceps
 Pinzas sacabocado p. biopsia
 Pinze per biopsia

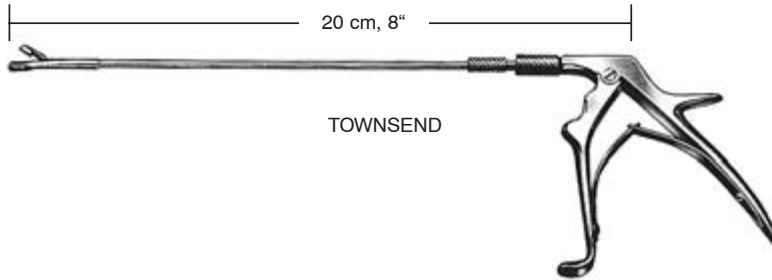

TOWNSEND

71624-10
 Griff allein
 Handle only
 Mango solo
 Manico solo



Fig. 1

TISCHLER-MORGAN



Fig. 6

TISCHLER-UP



Fig. 3

oval ● 3,7x5 mm



Fig. 7

TISCHLER-DOWN



Fig. 4

KEVORKIAN



Fig. 8

MINI-TOWNSEND-UP



Fig. 5

mini



Fig. 9

MINI-TOWNSEND-DOWN

Fig.	Strumento completo	Asta operativa sola
1	71624-01	71624-11
3	71624-03	71624-13
4	71624-04	71624-14
5	71624-05	71624-15
6	71624-06	71624-16
7	71624-07	71624-17
8	71624-08	71624-18
9	71624-09	71624-19

komplett
 compl. instr.
 Instrum. compl.

Aufsatz allein
 Tip only
 Punta sola

Uterus Biopsiezangen
 Biopsy Specimen Forceps
 Pinzas sacabocado p. biopsia
 Pinze per biopsia



2,3 x 4,2 mm

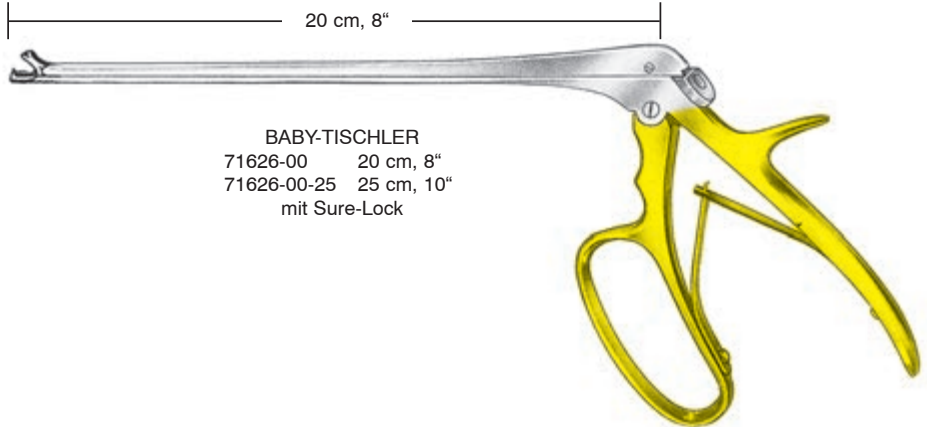

3 x 9,5 mm

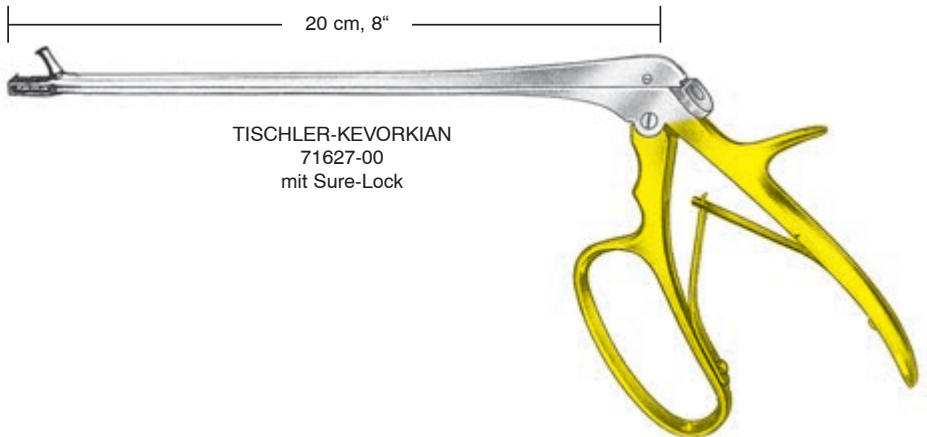

3 x 8 mm

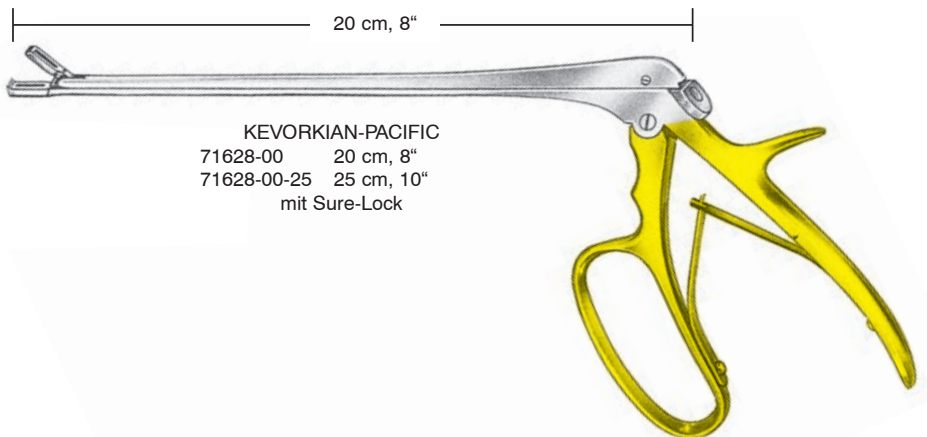

Uterus Biopsiezangen
Biopsy Specimen Forceps
Pinzas sacabocado p. biopsia
Pinze per biopsia

17,5 cm, 6.9"

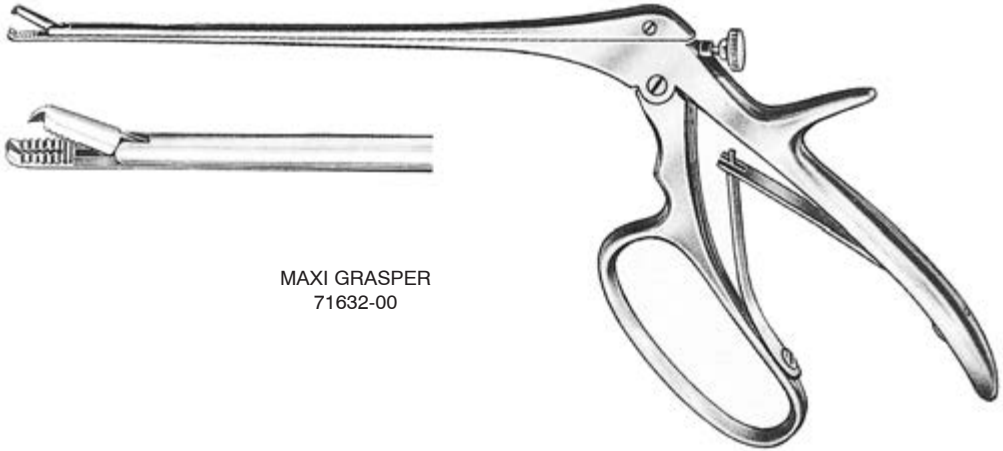

MAXI GRASPER
71632-00

20 cm, 8"

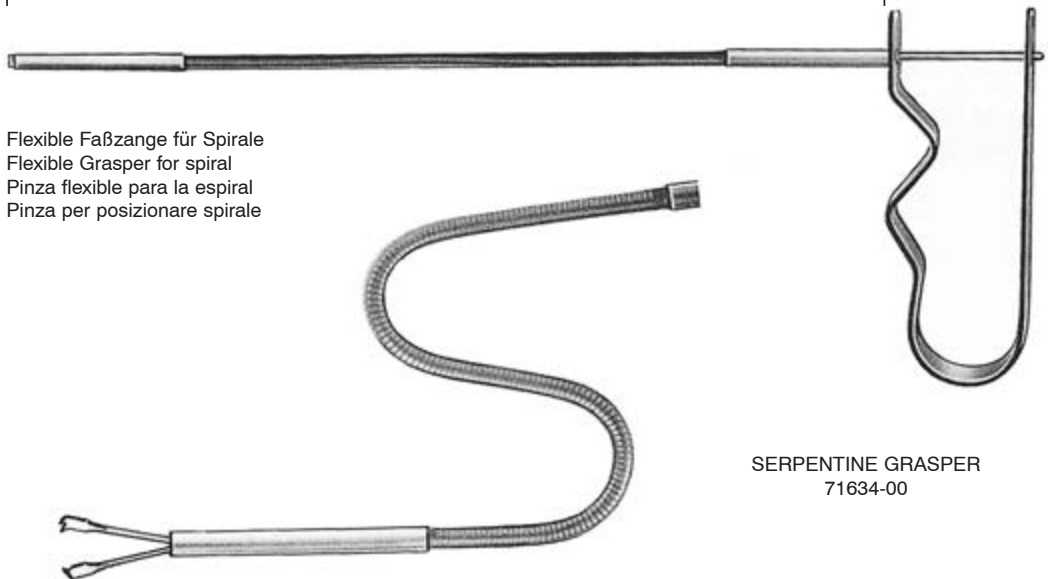

Flexible Faßzange für Spirale
Flexible Grasper for spiral
Pinza flexible para la espiral
Pinza per posizionare spirale

SERPENTINE GRASPER
71634-00



I.U.D.
Extractor Hook
71635-26
26 cm, 10 1/4"

Myomheber, Myommesser, Fistelhäkchen, Meßinstrumente, Uteruslöffel
 Myoma Screw, Myoma Knife, Fistula Hook, Measuring Instruments, Uterine Currettes
 Tirabuzón para fibromas, Bisturi para fibromas, Ganchos para fistulas, Instrumental para medir, Curetas uterinas
 Tiramiomi, Bisturi per fibromi, Uncini per fistole, Strumenti per misure, Curette uterine

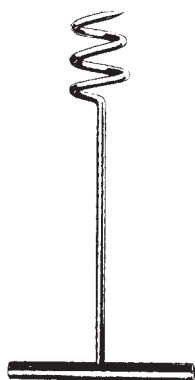

DOYEN
 71641-17
 17 cm, 6 3/4"



SEGOND
 71643-27
 27 cm, 10 1/2"

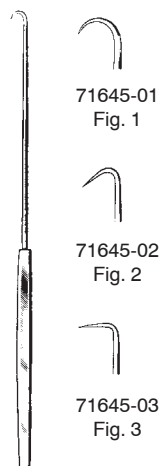

EMMET
 71645-01 - 71645-03
 22 cm, 8 3/4"

71645-01
 Fig. 1

71645-02
 Fig. 2

71645-03
 Fig. 3



71646-01

71646-02

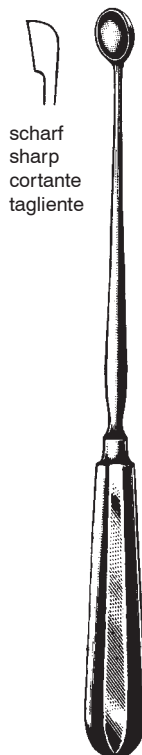

scharf
 sharp
 cortante
 tagliente

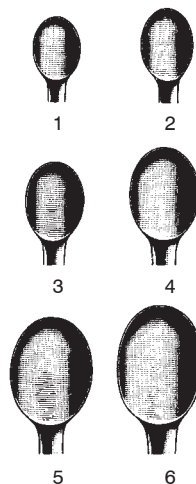

Fig. SIMON
 1 71702-01 6,8 mm
 2 71702-02 8,5 mm
 3 71702-03 10,0 mm
 4 71702-04 11,5 mm
 5 71702-05 13,0 mm
 6 71702-06 14,5 mm
 25 cm, 10"

Uterus-Küretten
 Uterine Currettes
 Curetas uterinas
 Curette uterine



SCHRÖDER
 31 cm, 12 1/4"



scharf/stumpf
 sharp/blunt
 cortante/roma
 tagliente/smussa



BLAKE
 71704-27
 27 cm, 10 1/2"

Salpingograph
Salpingograph
Salpingógrafo
Salpingografo

71650-00

SCHULTZE Salpingograph bestehend aus:

- 71650-01 1 Tubenkatheter
- 71650-02 1 Zwischenstück
- 71650-03 1 Manometer
- 71650-04 1 Kegel, klein
- 71650-05 1 Kegel, mittel
- 71650-06 1 Kegel, groß
- 71650-07 1 Recordspritze mit Luer-Lock Ansatz 10cc

SCHULTZE salpinogograph compl.:

- 71650-01 1 Tubal catheter only
- 71650-02 1 connecting piece
- 71650-03 1 manometer
- 71650-04 1 cone small
- 71650-05 1 cone medium
- 71650-06 1 cone large
- 71650-07 1 syringe record with Luer-Lock 10cc

Salpingógrafo compuesto de:

- 71650-01 1 cateter de tubo
- 71650-02 1 pieza de conexion
- 71650-03 1 manometro
- 71650-04 1 cono pequeño
- 71650-05 1 cono mediano
- 71650-06 1 cono grande
- 71650-07 1 jeringa con conexión Luer-Lock 10cc

Salpingografo composto da:

- 71650-01 1 Catetere per tubo
- 71650-02 1 Raccordo
- 71650-03 1 Manometro
- 71650-04 1 Cono, piccolo
- 71650-05 1 Cono, medio
- 71650-06 1 Cono, grande
- 71650-07 1 Siringa record con raccordo Luer-Lock 10cc

71660-00
Schultze Salpingograph, jedoch ohne Manometer

Schultze Salpingograph without manometer

Schultze Salpingografo sin manometro

Schultze Salpingografo senza manometro

71650-06

71650-05 71650-04

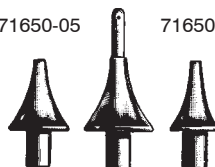

71650-07

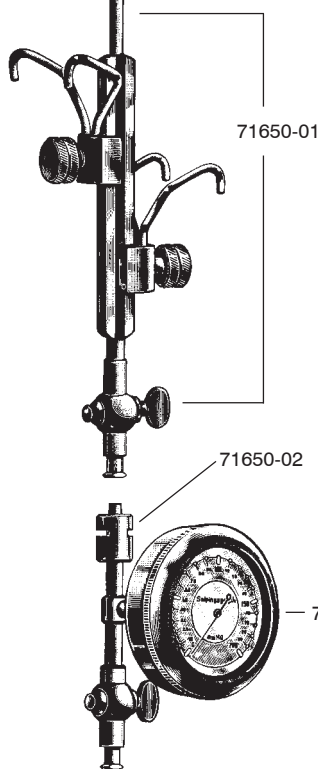
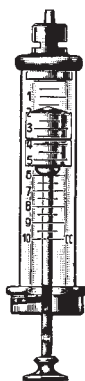

SCHULTZE
71650-00
compl.

im Etui
in case
en estuche
in astuccio

Uterus-Küretten
 Uterine Curettes
 Curetas uterinas
 Curette Uterine

SIMS

71710-05 - 71717-14
28 cm, 11"

	scharf sharp cort. tagl.	Fig.	mm	stumpf blunt roma smussa
fest	71710-05	00	5,0	71715-05
rig.	71710-06	0	6,0	71715-06
	71710-07	1	7,5	71715-07
	71710-08	2	8,5	71715-08
	71710-09	3	10,0	71715-09
	71710-11	4	11,5	71715-11
	71710-12	5	13,5	71715-12
	71710-14	6	14,5	71715-14

flexibel	71712-05	00	5,0	71717-05
flexible	71712-06	0	6,0	71717-06
fless.	71712-07	1	7,5	71717-07
	71712-08	2	8,5	71717-08
	71712-09	3	10,0	71717-09
	71712-11	4	11,5	71717-11
	71712-12	5	13,5	71717-12
	71712-14	6	14,5	71717-14

RECAMIER

71720-05 - 71727-20
31 cm, 12 1/4"

	scharf sharp cort. tagl.	Fig.	mm	stumpf blunt roma smussa
fest	71720-05	00	5	71725-05
rig.	71720-06	0	6	71725-06
	71720-07	1	7	71725-07
	71720-08	2	8	71725-08
	71720-09	3	9	71725-09
	71720-11	4	11	71725-11
	71720-12	5	12	71725-12
	71720-14	6	14	71725-14
	71720-15	7	15	71725-15
	71720-16	8	16	71725-16
	71720-19	9	19	71725-19
	71720-20	10	20	71725-20

flexibel	71722-05	00	5	71727-05
flexible	71722-06	0	6	71727-06
fless.	71722-07	1	7	71727-07
	71722-08	2	8	71727-08
	71722-09	3	9	71727-09
	71722-11	4	11	71727-11
	71722-12	5	12	71727-12
	71722-14	6	14	71727-14
	71722-15	7	15	71727-15
	71722-16	8	16	71727-16
	71722-19	9	19	71727-19
	71722-20	10	20	71727-20



BUMM

71730-30 - 71737-40
35 cm, 13 3/4"

	scharf sharp cort. tagl.	Fig.	mm	stumpf blunt roma smussa
fest	71730-30	14		71735-30
rig.	71730-35	15		71735-35
	71730-40	16		71735-40

flexibel	71732-30	14		71737-30
flexible	71732-35	15		71737-35
fless.	71732-40	16		71737-40

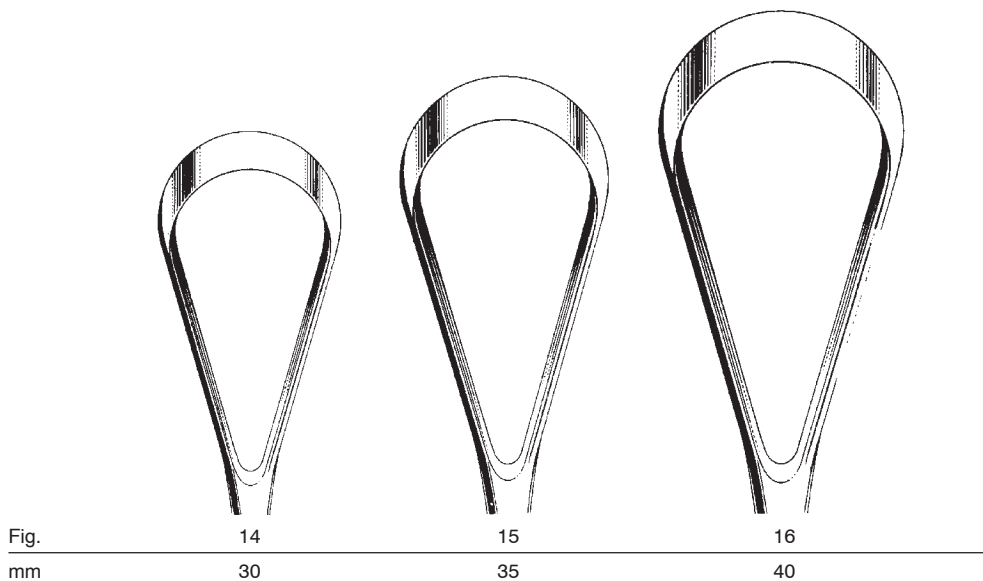
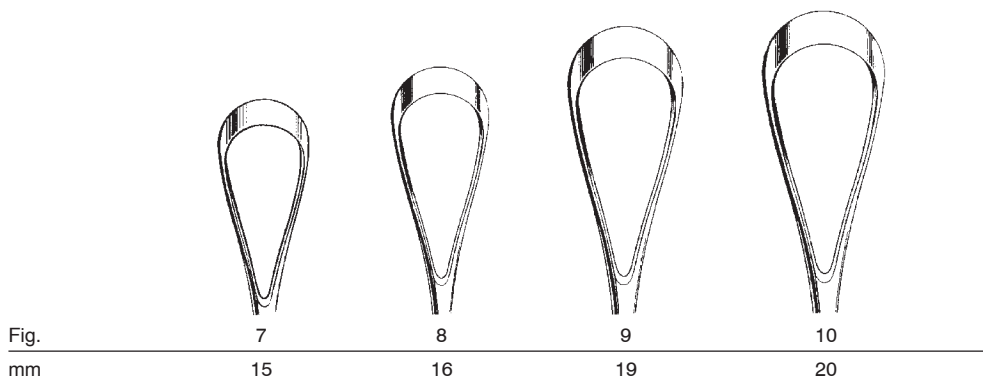
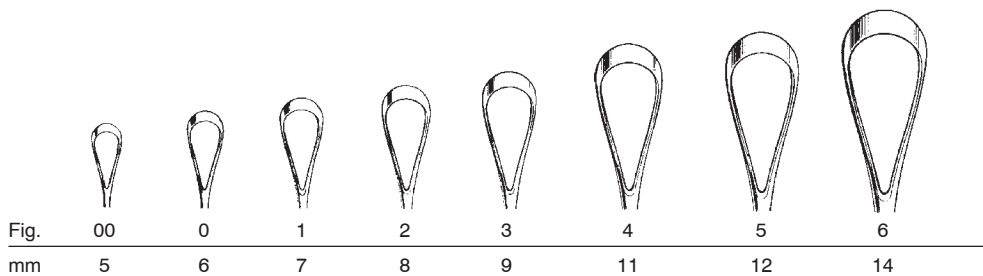
Uterus-Küretten
 Uterine Curettes
 Curetas uterinas
 Curette uterine



SIMS
 RECAMIER
 BUMM
 71710-05 - 71735-28

Uterus-Küretten
 Uterine Curettes
 Curetas uterinas
 Curette uterine

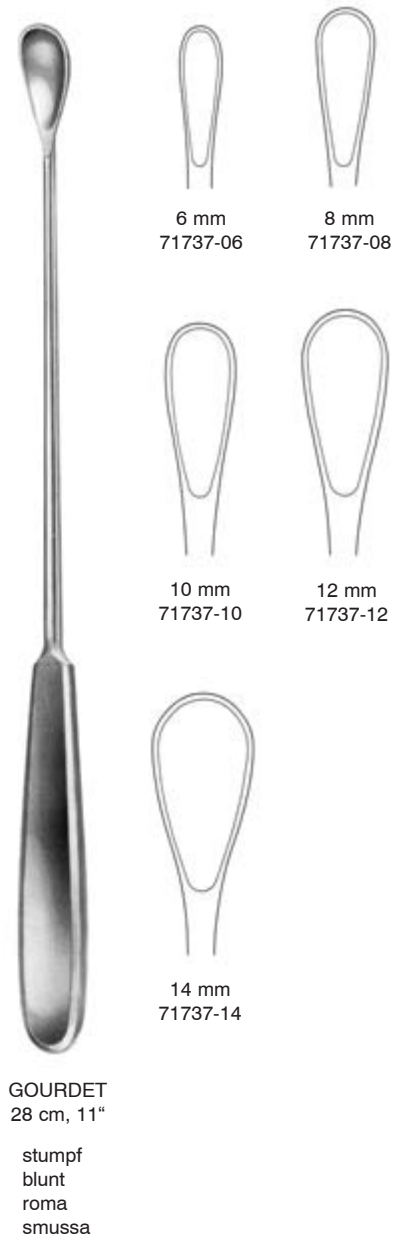
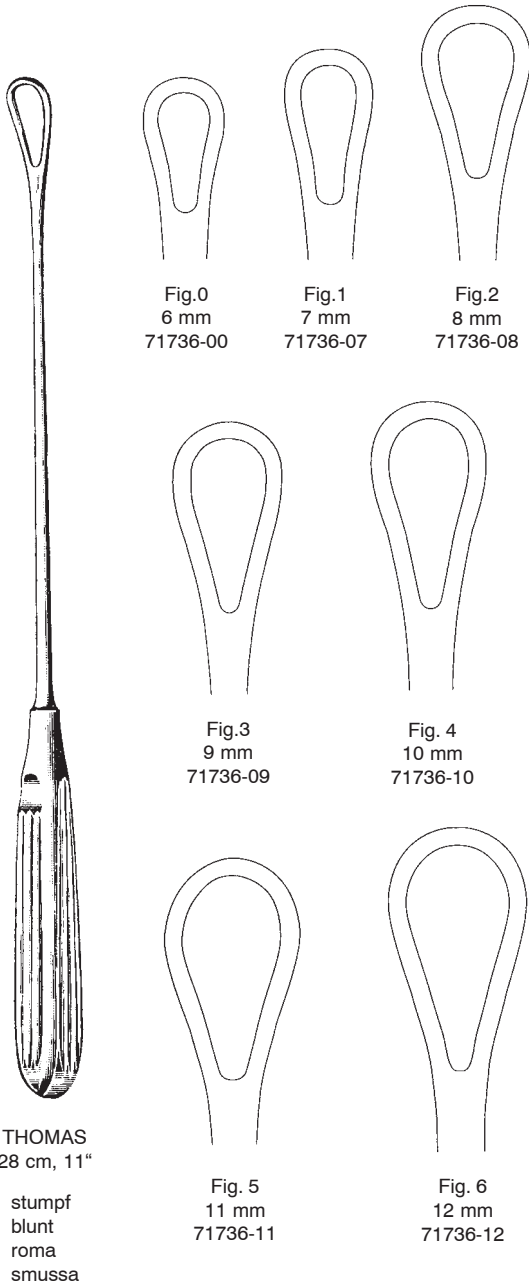

Biopsie- und Absaugküretten, Schlauch-Verbindungsstück
 Specimen and Aspirating Curettes, Hose connecting piece
 Curetas para biopsia y aspiración, Pieza conexión para tubos
 Curette di aspirazione per biopsia, Raccordo di connessione per tubi

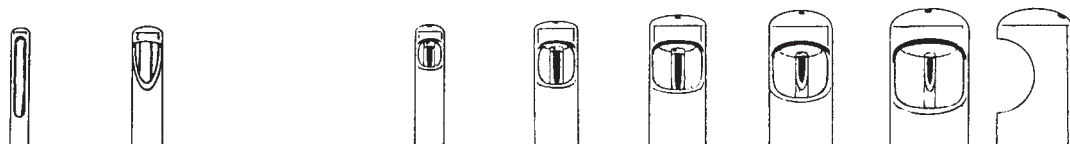

71803-03
3 mm Ø

71803-04
4,5 mm Ø

71803-06
6 mm Ø

71803-08
8 mm Ø

71803-10
10 mm Ø

71803-12
12 mm Ø

71803-14
14 mm Ø



71803-15

Amnioskope
Amnioscope
Amnioscopio
Amnioscopio



71810-12 12 x 24 mm Ø 20 cm, 8"
71810-16 16 x 24 mm Ø 20 cm, 8"
71810-20 20 x 24 mm Ø 20 cm, 8"



71810-50
Kaltlichtklammer
Cold Light clamp
Adaptador de iluminacion
Adattore di illuminazione

Geburtszangen
Obstetrical Forceps
Forceps obstétricos
Forcipi

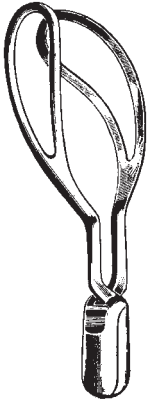

WRIGLEY
73101-23
23 cm, 9"



SIMPSON
73102-30
30 cm, 11 3/4"

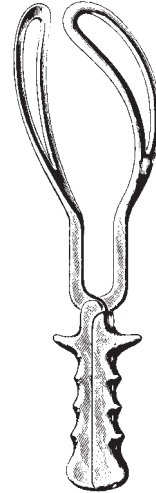

SIMPSON-BRAUN
73105-33 33 cm, 13"
73105-36 36 cm, 14"

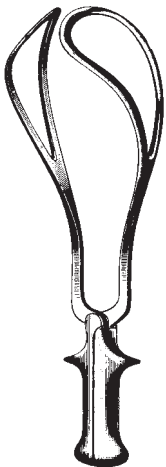

De LEE
73107-30
30 cm, 11 3/4"



De LEE
73108-36 36 cm, 14"
73108-39 39 cm, 15 1/2"



KIELLAND
73110-41
41 cm, 16"

Geburtszangen
 Obstetrical Forceps
 Forceps obstétricos
 Forcipi



ELLIOT
 73115-32 32 cm, 12 3/4"
 73115-38 38 cm, 15"

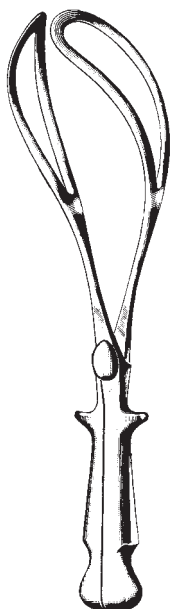

NAEGELE
 73119-36 36 cm, 14"
 73119-40 40 cm, 15 3/4"



THIERRY
 73123-39 39 cm, 15 1/2"

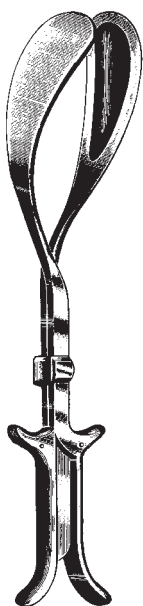

LUIKART
 73125-40
 40 cm, 15 3/4"

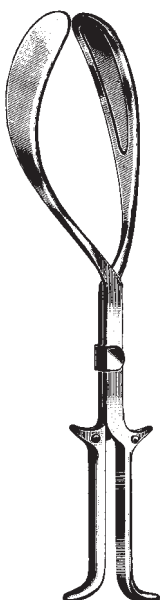

KIELLAND-LUIKART
 73127-40
 40 cm, 15 3/4"

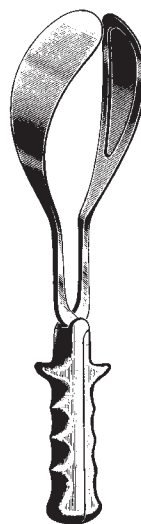

SIMPSON-LUIKART
 73135-36
 36 cm, 14"

Geburtszangen
Obstetrical Forceps
Forceps obstétricos
Forcipi

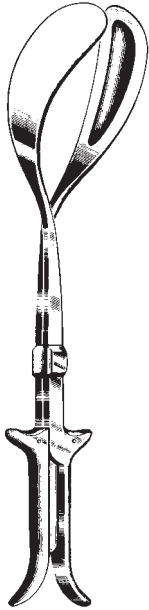

McLEAN-TUCKER-LUIKART
73139-40
40 cm, 15 ³/₄"

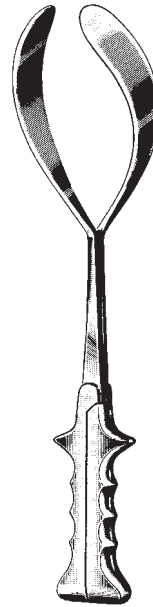

McLEAN-TUCKER
73141-39
39 cm, 15 ¹/₂"



McLEAN-LUIKART
73143-39
39 cm, 15 ¹/₂"

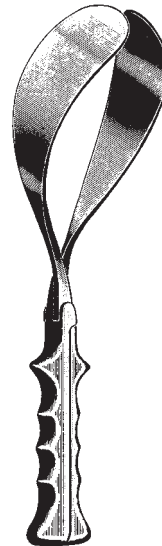

McLEAN
73145-36
36 cm, 14"

Geburtszangen, Zughebel
Obstetrical Forceps, Traction Handle
Forceps obstétricos, Dispositivos de tracción
Forcipi, Leve per trazione

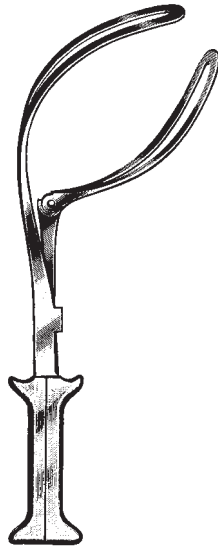

BARTON
73147-36
36 cm, 14"

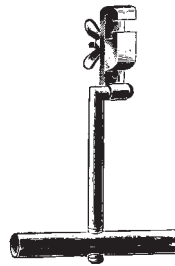

BARTON
73148-17
17 cm, 6 3/4"

Geburtszangen, Zughebel
 Obstetrical Forceps, Traction handles
 Forceps obstétricos, Dispositivos de tracción
 Forcipi, Leve per trazione

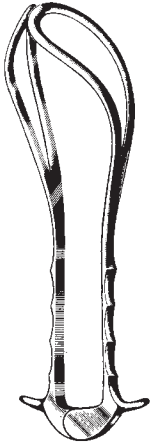

BOERMA
 73151-29
 29 cm, 11 1/2"

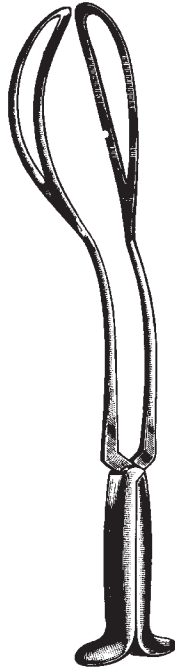

PIPER
 73155-44
 44 cm, 17 1/4"

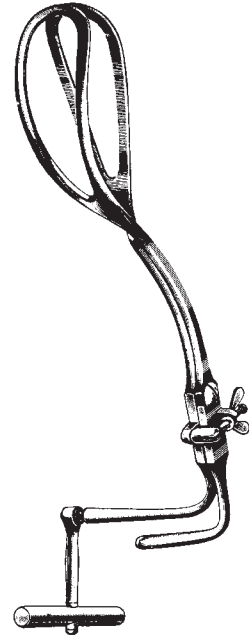

PIPER
 73157-40
 40 cm, 15 3/4"

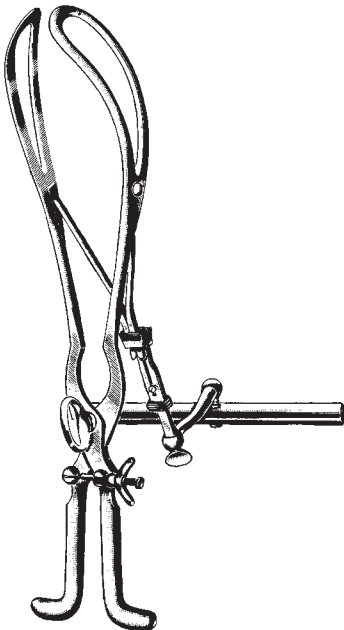

TARNIER
 73162-40
 40 cm, 15 3/4"

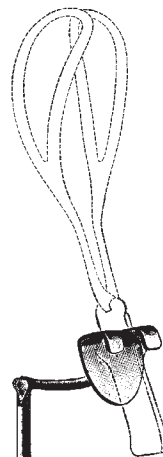

BILL
 73170-00
 21 cm, 8 1/4"

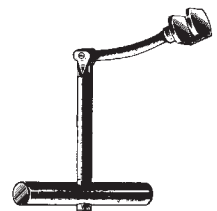

LUIKART-BILL
 73171-21
 21 cm, 8 1/4"

Geburtshaken, Kopfschwartzangen, Uterus-Klemmzange, Nabelschnurklemmen, Beckenzirkel
 Scalp flap forceps, Uterine haemostatic forceps, Umbilical cord clamps, Pelvimeters
 Pinzas para cuero cabelludo, Pinzas-clamps uterinas para hem6stasis, Clamp umbilical, Pelv6metros
 Pinza per il cuoio capelluto, Pinza uterina, Pinza ombelicale, Pelvimetri



SPELLIE
 73181-33
 33 cm, 13"

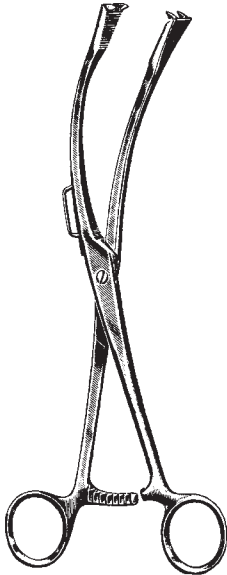

GAUSS
 73183-27
 27 cm, 10 1/2"



GREEN-ARMYTAGE
 73184-21
 21 cm, 8 1/4"



COLLIN
 73187-09
 9 cm, 3 1/2"

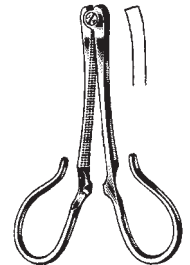

KANE
 73189-09
 8,5 cm, 3 1/4"

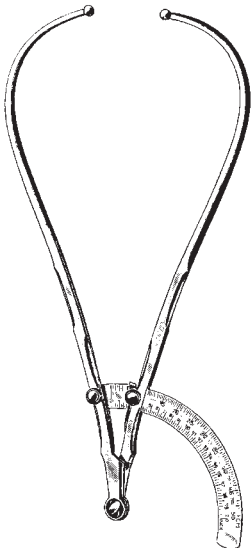

MARTIN
 73191-34
 34 cm, 13 1/2"

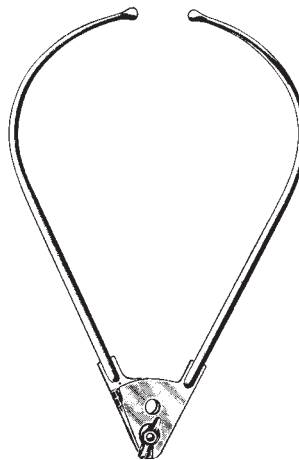

COLLIER
 73193-30
 30 cm, 11 3/4"

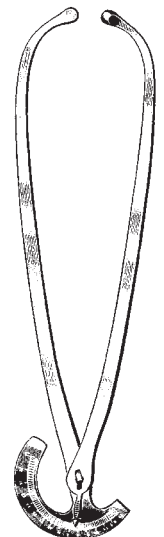

COLLIN
 73195-35
 35 cm, 14"

Abortuszangen, Abortuslöffel
 Ovum Forceps, Abortion Scoops
 Pinzas para aborto, Cucharillas para aborto
 Ostetricia, Curette per aborto



SAENGER
 73242-27 73243-27
 27 cm, 10 1/2"

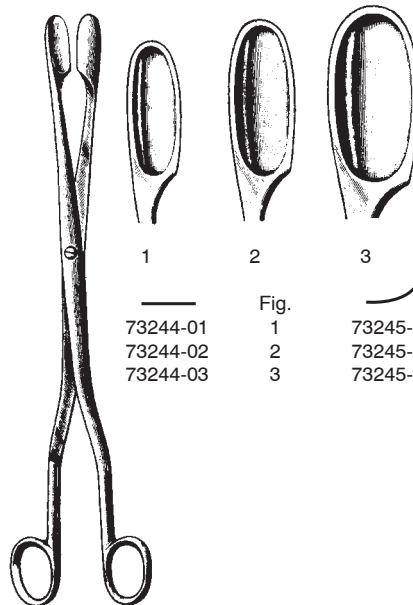

	1	2	3
	Fig. 1	Fig. 2	Fig. 3
73244-01	73245-01		
73244-02	73245-02		
73244-03	73245-03		

WINTER
 73244-01 - 73245-03
 28 cm, 11"

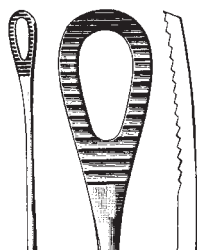

PESTALOZZA
 73252-30
 30 cm, 11 3/4"

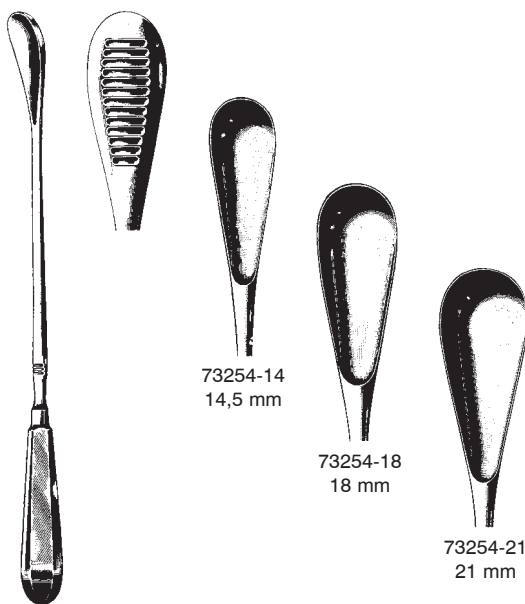

CUZZI
 73254-14 - 73254-21
 30 cm, 11 3/4"

Abortuslöffel, Geburtslöffel, Kranioklast, Basiotrip, Perforatorium, Dekapitationshaken
 Abortion Scoops, Elevating Spoon, Cranioclast, Basiotribe, Perforators, Decapitating hook
 Cucharillas para aborto, Separador obstetrico, Craneoclasto, Basiotribo, Perforacráneos, Gancho para decapitación
 Curette per aborto, Cucchiaio Ostetrico, cranioclasto, Basiotribo, spezzacrani, Uncino per decapitazione



stumpf
 blunt
 roma
 smussa



WALLICH
 73256-42
 42 cm, 16 1/2"



SELLHEIM
 73259-28
 28 cm, 11"

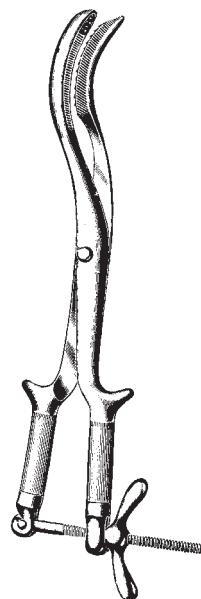

BRAUN
 73302-42
 42 cm, 16 1/2"



TARNIER
 73304-46
 46 cm, 18"

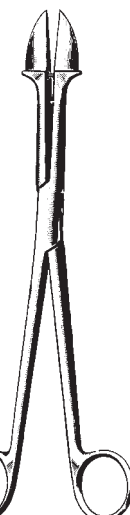
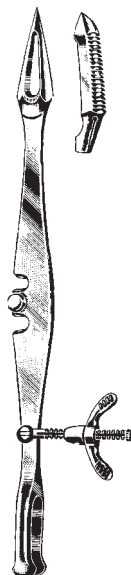

SMELLIE
 73306-25
 25 cm, 10"



BRAUN
 73309-30
 30 cm, 11 3/4"

Hauthäkchen, Komedonenquetscher, Lupusküretten, Hautküretten, Haut-Trephinen
 Skin hooks, Comedone extractors, Lupus curettes, Skin curettes, Cutaneous punches
 Ganchos cutáneos, Saca comedones, Curetas para lupus, Curetas cutáneas, Trépanos cutáneos
 Uncini cutanei, Schiaccia comedoni, Curette per lupus, Curette cutanee, Trefine cutanee



KILNER
75103-15
15 cm, 6"



SCHAMBERG
75111-10
10 cm, 4"

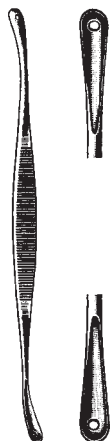

UNNA
75113-14
14 cm, 5 1/2"



UNNA
75115-14
14 cm, 5 1/2"



WALTON
75118-14
14 cm, 5 1/2"



SAALFELD
75121-10
10 cm, 4"

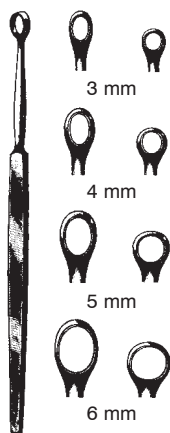

14 cm, 5 1/2"

FOX		FOX	
75128-01	1 mm	75129-01	1 mm
75128-02	2 mm	75129-02	2 mm
75128-03	3 mm	75129-03	3 mm
75128-04	4 mm	75129-04	4 mm
75128-05	5 mm	75129-05	5 mm
75128-06	6 mm	75129-06	6 mm

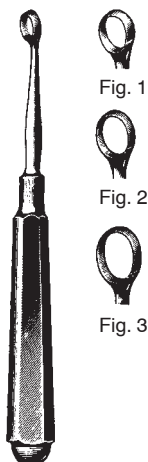

PIFFARD
14,5 cm, 5 3/4"
75130-01 Fig. 1
75130-02 Fig. 2
75130-03 Fig. 3



75138-00
Satz komplett mit 6 Aufsätzen
Set complete with 6 tips
Juego con 6 puntas
Serie completa con 6 trefini

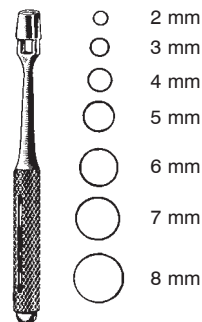

KEYES
10 cm, 4"
75140-02 2 mm
75140-03 3 mm
75140-04 4 mm
75140-05 5 mm
75140-06 6 mm
75140-07 7 mm
75140-08 8 mm

Nagelzangen, -Scheren
Nail Nippers, Scissors
Alicates corta-uñas
Tronchesini forbici per unghie



75301-10

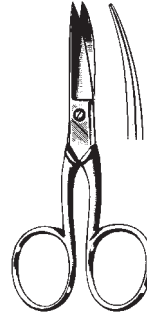

75304-10 10 cm, 4" 75305-10



75331-14
14 cm, 5 1/2"
stainless



TURNBULL
75341-11 11,5 cm, 4 1/2"
75341-13 13,5 cm, 5 1/4"
stainless

Nagelhautzangen, Hautscheren, Nagelfeilen
Cuticle Nippers, Cuticle Scissors, Nail Files
Pinzas y Tijeras cuticulares, Limas para uñas
Tronchesine per unghie e pelle, Limette per le unghie



75373-10
10,5 cm, 4"

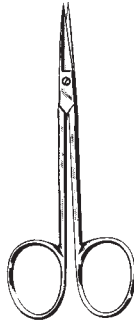

75378-10
10 cm, 4"

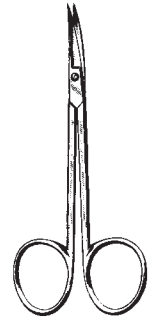

75379-10
10 cm, 4"



75382-16

Bürstenspender, Handwaschbürsten
Brush Dispensor, Nail brushes
Dispensador de cepillos, Cepillo para uñas
Distributore di spazzole, Spazzole per unghie

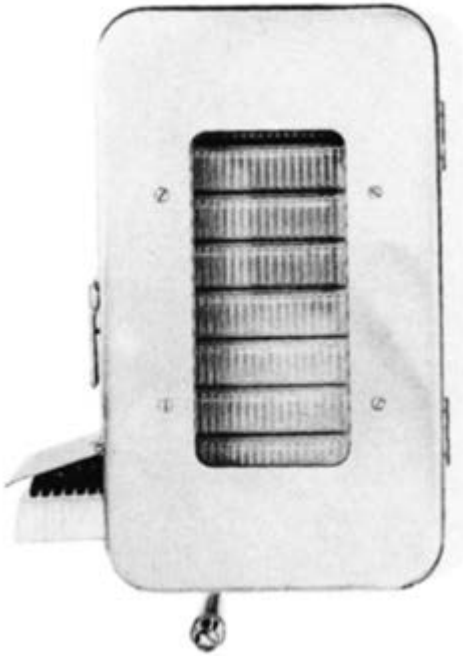

75396-01
Bürstenspender für 10 Bürsten
Brush dispenser for 10 brushes
Distribuidor de cepillos para 10 cepillos
Distributore per spazzolini da 10

75396-02
Bürstenspender für 20 Bürsten
Brush dispenser for 20 brushes
Distribuidor de cepillos para 20 cepillos
Distributore per spazzolini da 20

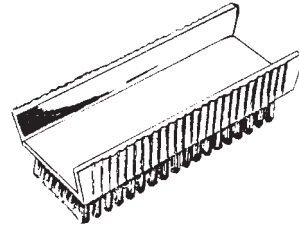

75397-00

Pack. à 10 St.
Box of 10 pcs
caja de 10 pzas.
confezione da 10 pezzi

Hygiene
Hygiene
Higiene
Igiene



PROBE AND PACKER
75450-00
14,5 cm, 5 ³/₄"



SPATULA AND PACKER
75440-00
14,5 cm, 5 ³/₄"



mit Loch, with hole,
con agujero, con foro

75430-12 = 1,5 mm + 2 mm
75430-13 = 1,5 mm + 2,5 mm
14,5 cm, 5 ³/₄"



14,5 cm, 5 ³/₄"
ohne Loch, without hole,
sin agujero, senza foro

75400-01 = 1 mm
75400-02 = 1,5 mm
75400-03 = 2 mm
75400-04 = 2,5 mm

mit Loch, with hole,
con agujero, con foro

75410-01 = 1 mm
75410-02 = 1,5 mm
75410-03 = 2 mm
75410-04 = 2,5 mm

Hygiene
Hygiene
Higiene
Igiene

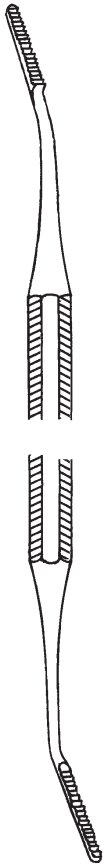

75410-15
17,5 cm, 6³/₄"



75420-15
15 cm, 6"



75430-01
12,5 cm, 5"



75440-11
11,5 cm, 4¹/₂"



INGROWN
75445-12
12,5 cm, 5"

Nagelzangen
Nail Nippers
Alicates corta-uñas
Tronchesini per unghie

stainless steel

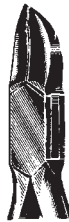

75450-13
concave



75460-13
gerade
straight
recto
retta



14,5 cm, 5 3/4"

stainless steel



75470-11
10 cm
4"

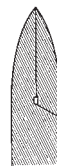

75475-11
11,5 cm
4 1/2"

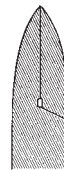

75480-13
12,5 cm
5"

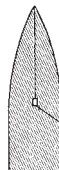

fine
75485-13
12,5 cm
5"

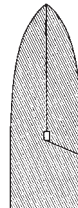

75490-15
15 cm
6"

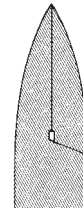

fine
75500-15
15 cm
6"

Nagelzangen
Nail Nippers
Alicates corta-uñas
Tronchesini per unghie

stainless steel

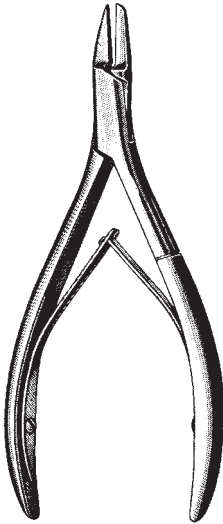

ANVIL
75550-13
13 cm, 5 1/8"

stainless steel

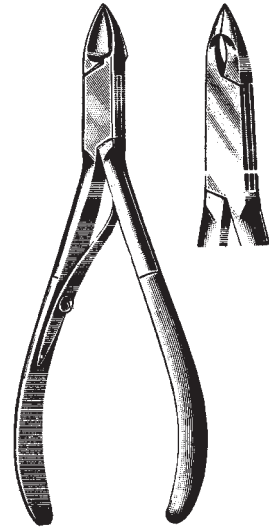

75600-10
10 cm, 4"

stainless steel



75618-15
15,2 cm, 6"

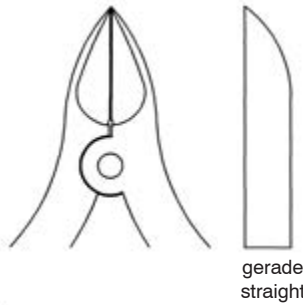

stainless steel

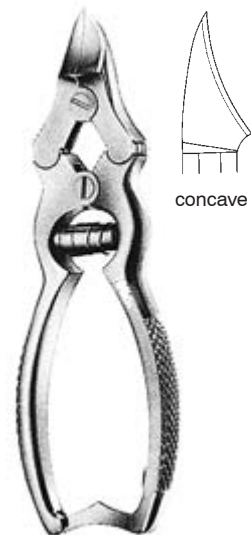

75620-15
15,5 cm, 6"



Nagelzangen, Nagelspaltscheren
Nail Nippers, Nail splitting scissors
Alicates corta-uñas, Tijeras para hender uñas
Tronchesini per unghie, Forbici per staccare unghie



75630-12
12 cm, 4³/₄"



75640-15
15 cm, 6"

Kappenzangen, Nadel-Sterilisierkästen
 Sterilizing Forceps, Needle Sterilizing cases
 Combinacion tapa-pinza, Estuches para esterilizar agujas
 Pinza coperchio, Scatole per sterilizzare aghi

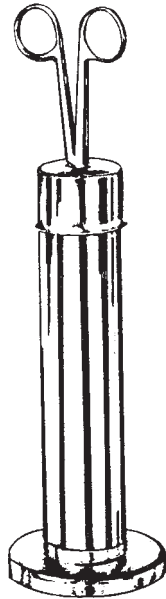

89111-25 25 cm, 10"
 89111-32 32 cm, 12³/₄"



89112-65
 65 x 15 mm



89113-65



89114-00
 150 x 95 x 13 mm



89115-50 50 x 25 x 4,5 mm
 89115-65 65 x 42 x 8,0 mm
 89115-75 75 x 25 x 4,5 mm



89116-50 50 x 25 x 4,5 mm
 89116-65 65 x 42 x 8,0 mm
 89116-75 75 x 25 x 4,5 mm



Instrumentenkästen
Instrument Boxes
Cajas para instrumentos
Scatole per strumenti



Abmessungen in mm
Sizes in mm
tamaños en mm
misura in mm

l x b x h mm	
400x200x80	89121-40
500x270x70	89121-50

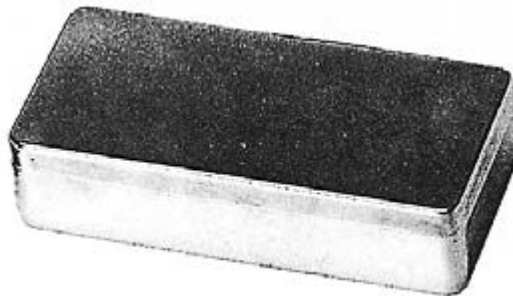

Abmessungen in mm Sizes in mm tamaños en mm misura in mm	Deckel ohne Knopf lid without knob tapa sin botón coperchio senza bottone
---	--

l x b x h mm	
165x 85x35	89122-16
200x100x50	89122-21
260x150x50	89122-26
300x200x50	89122-30

Bereitschaftskästen
Storage cases
Cajas para almacenaje
Scatole per magazzinaggio



Abmessungen in mm (l x b x h)
Sizes in mm (l x b x h)
tamaños en mm (l x f x a)
misura in mm (l x l x a)

230 x 130 x 50
260 x 150 x 50
275 x 235 x 50
300 x 200 x 50
325 x 275 x 50
420 x 175 x 50

230 x 130 x 75
260 x 150 x 75
300 x 200 x 75
325 x 275 x 75
420 x 175 x 75

Behälter
Containers
Recipientes
Recipienti

89124-23
89124-26
89124-27
89124-30
89124-32
89124-42

89125-23
89125-26
89125-30
89125-32
89125-42

Satz Spezialfilter (5 Paar)
Set of spezial filters (5 pairs)
Juego de filtros especiales (5 pares)
Set die 5 paia di filtri speciali

89126-23
89126-26
89126-27
89126-30
89126-32
89126-42

89127-23
89127-26
89127-30
89127-32
89127-42

Schüsseln
Bowls
Cubetas
Scondelle

18/10
Stainless Steel
Acero inoxidable
Acciajo inossidabile

matt
satin finish
pulidas mate
opaco



Abmessungen in mm sizes in mm Tamaños en mm misura in mm Ø x h	Inhalt capacity capacidad capacità l	
40x19	0,05	89127-04
61x30	0,07	89127-06
80x40	0,14	89127-08
116x50	0,35	89127-11
128x55	0,45	89127-12
147x65	0,70	89127-14
167x75	1,10	89127-16
187x85	1,60	89127-18

Abmessungen in mm sizes in mm Tamaños en mm misura in mm Ø x h	Inhalt capacity capacidad capacità l	
100x30	0,15	89129-11



	mm x mm	l
89133-16	165 x 60	0,75
89133-17	175 x 70	1,00
89133-22	220 x 80	2,00
89133-24	240 x 110	3,00
89133-31	310 x 120	6,00
89133-34	345 x 125	8,50
89133-38	380 x 130	11,00

89139-17	170 x 100 x 35 mm	0,50 l
89139-25	250 x 140 x 40 mm	1,25 l
89139-27	275 x 150 x 45 mm	2,25 l

Meßbecher, Dose, Standgefäß, Mehrzweckschalen
 Graduated Measures, Box, Jars, Universal Trays
 Copas graduadas, Recipientes, Tarros, Bandejas para instrumentos
 Bicchieri graduati, Recipienti, Recipienti cilindrici, Bacinelle per strumenti

18/10
 Stainless Steel
 Acero inoxidable
 Acciajo inossidabile

matt
 satin finish
 pulidas mate
 opaco



l	
0,25	89140-02
0,5	89140-05
1,0	89140-10
2,0	89140-20



89141-10
 100 x 20 mm



	mmxmm
89142-01	30x 90
89142-02	50x100
89142-03	50x130
89142-04	50x175
89142-05	75x100
89142-06	75x130
89142-07	75x175



89147-21 - 89147-42

	l x b x h
89147-21	210x160x10 mm
89147-24	240x180x10 mm
89147-30	310x150x10 mm
89147-31	310x210x10 mm
89147-35	350x240x10 mm
89147-40	400x270x20 mm
89147-42	420x280x10 mm



89145-23 - 89145-40

	l x b x h
89145-23	230x155x30 mm
89145-30	300x175x30 mm
89145-31	300x175x40 mm
89145-35	350x240x36 mm

Wattedosen, Medizinlöffel, -becher
 Cotton wool containers, Medicine Spoon and Cups
 Distribuidores de algodón, Cuchara graduada, Vasos graduados
 Vaso portacotone, Cucchiaino per medicinali, bicchieri per medicinali



mit Deckel
 with Lid
 Tapa
 Coperchio



89146-20 20 cc
 110 x 20 mm

	ø	h	l
89143-00	6 cm	6 cm	0,15 l
89143-01	8,5 cm	8,5 cm	0,4 l
89143-02	8,5 cm	12,5 cm	0,6 l
89143-03	8,5 cm	5 cm	0,25 l
89143-04	10 cm	10 cm	0,75 l
89143-05	10 cm	5 cm	0,35 l
89143-06	12 cm	12 cm	1,25 l
89143-07	15 cm	15 cm	2,5 l
89143-08	15 cm	10 cm	1,75 l
89143-09	20 cm	20 cm	6 l
89143-10	20 cm	10 cm	3 l



89147-10 100 cc
 89147-25 250 cc



89148-25 25 cc
 89148-50 50 cc

Stechbecken, Plazentabecken, Sputumbecher
Bed Pan, Placenta Pan, Sputum Cup
Silleta, Cubeta para placenta, Escupidera
Padella, bacinella per placenta, Sputacchiera



89148-31
ø 310 mm



89148-32



89148-35
350 x 290 x 90 mm



89150-30
90 x 80 mm

Verbandstofftrommel, Sterilisiersiebkorb
 Sterilizing Drums, Sterilization Trays
 Tambores p. esterilización, Cestas de esterilización
 Tamburi p. sterilizzazione, Cestelli per erilizzazione



SCHIMMELBUSCH

Ø

mmxmm

89152-08	125x 80
89152-10	125x100
89152-12	125x125
89155-08	150x 80
89155-10	150x100
89155-13	150x130
89155-15	150x150
89155-19	150x190
89159-14	190x145
89159-16	190x165
89159-19	190x190
89159-24	190x240
89164-14	240x145
89164-16	240x165
89164-19	240x190
89164-24	240x240
89164-29	240x290
89164-34	240x340
89164-39	240x390
89169-14	290x145
89169-16	290x165
89169-19	290x190
89169-24	290x240
89169-29	290x290
89169-34	290x340
89169-39	290x390
89174-14	340x145
89174-16	340x165
89174-19	340x190
89174-24	340x240
89174-29	340x290
89174-34	340x340
89174-39	340x390
89179-14	390x145
89179-16	390x165
89179-19	390x190
89179-24	390x240
89179-29	390x290
89179-34	390x340
89179-39	390x390
89179-49	390x490
89179-59	390x590

18/10

Stainless Steel

Acero inoxidable

Acciajo inossidabile

Acciaio inossidabile

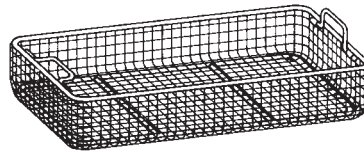

R390.03 255x245x 30 mm

R390.05 255x245x 50 mm

R390.07 255x245x 70 mm

R390.10 255x245x100 mm

R190.03 485x255x 30 mm

R190.05 485x255x 50 mm

R190.07 485x255x 70 mm

R190.10 485x255x100 mm

R191.03 540x255x 30 mm

R191.05 540x255x 50 mm

R191.07 540x255x 70 mm

R191.10 540x255x100 mm

Siebschalen, Endoskopiekorb
Trays
Bandejas
Cestelli

Aus perforiertem Blech
From Perforated Sheet Metal
De chapa de acero perforada
In acciaio perforato

18/10
Stainless Steel
Acero inoxidable
Acciajo inossidabile



	mm x mm x mm
89250-10	240 x 240 x 50
89250-20	240 x 240 x 80
89250-30	240 x 240 x 100
89250-40	480 x 260 x 50
89250-50	520 x 260 x 80
89250-60	520 x 260 x 100

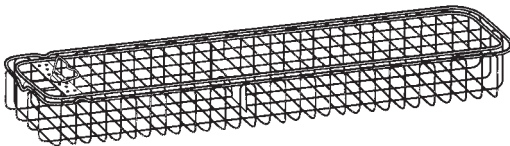

für 1 Endoskop, for 1 endoscope,
para 1 endoscopio, per 1 endoscopio

89256-29	290x80x52 mm
89256-46	460x80x52 mm
89256-67	670x80x52 mm

für 2 Endoskope, for 2 endoscopes,
para 2 endoscopios, per 2 endoscopi rigidi

89257-46	460x80x52 mm
----------	--------------

Schlauchklemmen, Messgerät, Sterilisierklammern
 Tubing Clamp, Decimal spring caliper, Safety pins
 Pinzas para tubos, calibrador decimal, Cadres de esterilizacion
 Morsetti serratubi, compasso, pinze per sterilizzazione

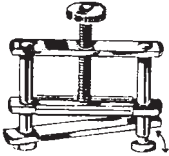

HOFFMANN

89260-13 13 mm
 89260-17 17 mm
 89260-20 20 mm
 89260-25 25 mm
 89260-30 30 mm
 89260-40 40 mm

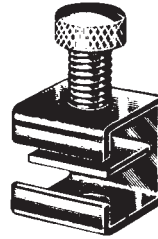

SIMPLEX

89265-12

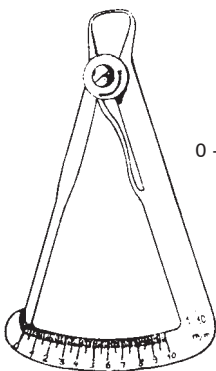

0 - 10 mm

IWANSON
89270-15

BUNT

29150-12
 12 cm, 4 3/4"

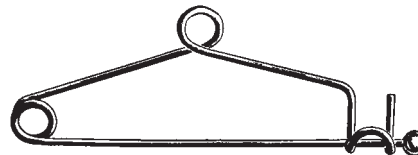

MAYO

29152-14
 14 cm, 5 1/2"

Reinigungspistole
Water Jet Pistol
Pistola-lavatora
Pistola lavatrice



89500-00
komplett mit 9 Aufsätzen
complete with 9 tips
con 9 toberas
completa con 9 raccordi



89500-01
Reinigungsaufsatz für Flaschen
Cleansing Tip for bottles
Tobera para botellas
Raccordo di lavaggio per bottiglie



89500-02
Reinigungsaufsatz für Recordspritzen-Konen
Cleansing Tip for Cones of Record Syringes
Tobera para conos de jeringas Record
Raccordo per coni di siringhe Record



89500-03
Reinigungsaufsatz für Katheter
Cleansing Tip for Catheters
Tobera para catéteres
Raccordo di lavaggio per cateteri



89500-04
Reinigungsaufsatz für Drainageschläuche
Cleansing Tip for Drainage Tubings
Tobera para tubos de drenaje
Raccordo di lavaggio per tubi di drenaggio



89500-05
Reinigungsaufsatz für Hohlgefäße (Brause)
Cleansing Tip for Receptacles (Shower)
Tobera para recipientes (ducha)
Raccordo di lavaggio per recipienti (doccia)

89500-12
Pistole allein
Pistol only
Pistola sola
Pistola sola



89500-06
Reinigungsaufsatz für Kanülen mit Recordkonus
Cleansing Tip for hypodermic needles with Record Cone
Tobera para agujas de inyección con cono Record
Raccordo di lavaggio per aghi ipodermici con cono Record



89500-07
Reinigungsaufsatz für Kanülen mit Luerkonus
Cleansing Tip for hypodermic needles with Luer Cone
Tobera para agujas de inyección con cono Luer
Raccordo di lavaggio per aghi ipodermici con cono Luer



89500-08
Reinigungsaufsatz für Meß- und Vollpipetten
Cleansing Tip for Meas. and Volumetric Pipettes
Tobera para pipetas de medida y volumétricas
Raccordo di lavaggio per pipette comuni e graduate

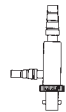

89500-09
Reinigungsaufsatz für feine Pipetten
Cleansing Tip for fine pipettes
Tobera para pipetas finas
Raccordo di lavaggio per pipette fine



89500-10
Reinigungsaufsatz 31 cm (12 1/4") gerade
Cleansing Tip 31 cm (12 1/4") straight
Tobera 31 cm (12 1/4") recta
Raccordo 31 cm (12 1/4") rette



89500-11
Reinigungsaufsatz 30 cm (11 3/4") aufgebogen
Cleansing Tip 30 cm (11 3/4") curved
Tobera 30 cm (11 3/4") curva
Raccordo di lavaggio 30 cm (11 3/4") curvo

89501-03
Überwurfmutter zum Anschluß an Gewindehähne
Couplings for connection to water tap
Tuercas-hembras para conexión al grifo de agua
Dadi premistoppa per connessione ai rubinetti filettati

Hochfrequenz-Chirurgie
 High Frequency Surgery
 Electrocirugía
 Elettrochirurgia

Mindestbestellmenge 10
 Minimum order quantity 10
 Cantidad minima 10
 Minimo di quantitativo 10



91010-01 Fig. 1
 91010-02 Fig. 2 45°
 91010-03 Fig. 3 120°
 91010-11 Fig. 11 Ø 3 mm
 91010-12 Fig. 12 Ø 5 mm
 91010-13 Fig. 13 Ø 8 mm



91010-14 Fig. 14
 91010-15 Fig. 15 45° 7,0x1,5 mm
 91010-16 Fig. 16 45° 7 mm
 91010-17 Fig. 17 6,0x1,3 mm
 91010-18 Fig. 18 30° 7,0x1,7 mm
 91010-21 Fig. 21 7,0x1,7 mm



91010-31 Fig. 31 45° Ø 0,6 mm
 91010-33 Fig. 33 45° Ø 1,7 mm
 91010-34 Fig. 34 45° Ø 3,0 mm
 91010-35 Fig. 35
 91010-36 Fig. 36 90°
 Schaft shaft
 vástago asta
 Ø 2,4 mm

Mindestbestellmenge 10
 Minimum order quantity 10
 Cantidad minima 10
 Minimo di quantitativo 10

Hochfrequenz-Chirurgie
 High Frequency Surgery
 Electrocirugía
 Elettrochirurgia



91011-51
 Fig. 51 45°
 Ø 3 mm



91011-52
 Fig. 52 45°
 7,0x1,7 mm



91011-53
 Fig. 53 45°



91011-54
 Fig. 54



91011-55
 Fig. 55



91011-56
 Fig. 56 45°
 Ø 5 mm



91011-61
 Fig. 61 45°



91011-62
 Fig. 62 90°

Schaft
 shaft
 vástago
 asta
 Ø 2,4 mm

Serie STANDARD



91020-01



91020-02

Schaft
 shaft
 vástago
 asta
 Ø 4 mm



91020-03



91020-04



Ø mm
 5 91022-05
 10 91022-10
 20 91022-20



Ø mm
 10 91024-10
 15 91024-15
 20 91024-20



Ø mm
 2 91030-02
 4 91030-04
 6 91030-06

Schaft
 shaft
 vástago
 asta
 Ø 4 mm

Bipolare Koagulation
Bipolar Coagulation
Coagulación bipolar
Coagulazione bipolare



91102-11
11 cm, 4 $\frac{3}{8}$ "

91104-11
11 cm, 4 $\frac{3}{8}$ "



91109-11
11 cm, 4 $\frac{3}{8}$ "
45°
0.5 mm

91113-11
11 cm, 4 $\frac{3}{8}$ "
45°
0.5 mm



91115-11
11 cm, 4 $\frac{3}{8}$ "
45°
0.5 mm



91122-16
16,5 cm, 6 $\frac{1}{2}$ "
0.5 mm

91123-16
16,5 cm, 6 $\frac{1}{2}$ "
0.5 mm



91124-16
16,5 cm, 6 $\frac{1}{2}$ "
1 mm

91125-16
16,5 cm, 6 $\frac{1}{2}$ "
0.5 mm



91127-16
16,5 cm, 6 $\frac{1}{2}$ "
1 mm

Bipolare Koagulation
Bipolar Coagulation
Coagulación bipolar
Coagulazione bipolare



91142-16
16,5 cm, 6 1/2"
1 mm



91144-16
16,5 cm, 6 1/2"
0.5 mm



91146-16
16,5 cm, 6 1/2"
1 mm



91152-19
19,5 cm, 7 3/4"
0.3 mm



91154-19
19,5 cm, 7 3/4"
1 mm



91157-19
19,5 cm, 7 3/4"
1 mm



91159-19
19,5 cm, 7 3/4"
2 mm

Bipolare Koagulation
 Bipolar Coagulation
 Coagulación bipolar
 Coagulazione bipolare



91162-19
 19,5 cm, 7 3/4"
 0,3 mm



91164-19
 19,5 cm, 7 3/4"
 1 mm



91166-19
 19,5 cm, 7 3/4"
 2 mm



91167-19
 19,5 cm, 7 3/4"
 1 mm



91169-19
 19,5 cm, 7 3/4"
 1 mm



91172-03 - 91172-12
 22,5 cm, 8,9"



91172-03
 0,3 mm



91172-07
 0,7 mm



91172-12
 1,2 mm

Verbindungskabel, bipolar
 Connection Cords, bipolar
 Cables de conexión, bipolar
 Cavi da connessione, bipolare



ERBE
 SELECT
 STORZ
 91190-30
 91190-50

3 m 118"
 5 m 197"



USA Mod.
 91192-30
 91192-50



MARTIN
 BERCHTOLD
 AESCULAP
 91193-30
 91193-50

für Elektro-Chirurgie-Einheiten
 for Electrosurgery Equipment
 para Electrobisturías
 per Elettrobisturi

Monopolare Pinzetten
 Monopolar Forceps
 Pinzas monopolares
 Pinze monopolare



91800-18 18 cm, 7"
 91800-21 21 cm, 8 1/4"
 91800-25 25 cm, 10"

ohne Buchse
 without socket
 sin casquillo
 senza presa



91801-18 18 cm, 7"
 91801-21 21 cm, 8 1/4"
 91801-25 25 cm, 10"

mit Buchse
 with socket
 con casquillo
 con presa

Instrumentenöl
Instrument oil
Oleo para instrumentos
Olio per strumenti

INSTRU CARE ist ein Instrumentenpflegeöl auf der Basis von hochreinen medizinischen Weißölen zum Erhalt der Funktionsfähigkeit und Werterhaltung von chirurgischen Instrumenten. Die Anwendung erfolgt nach der Reinigung bzw. vor dem Sterilisationsvorgang.

INSTRU CARE is an instrument oil for care and protection of surgical instruments and guaranties the function and protects the value of instruments. It will be used after cleansing and before sterilization process.

INSTRU CARE olio para instrumentos

INSTRU CARE è un olio estremamente puro per la lubrificazione e la pulizia dello strumentario chirurgico. Privo di silicone, appropriato per la sterilizzazione a vapore e ad aria calda. Fisiologicamente inerte con utilizzo prima della sterilizzazione.



98000-01
100ml

Kunststoff-Flasche
plastic bottle
bottiglia
botella



98000-02
400ml

Sprühdose
aerosol
spray
spray

03112-00.....5	05151-02.....27	05311-01.....37	07402-08.....46	09121-20.....51
03112-01.....5	05160-02.....28	05311-02.....37	07402-09.....46	09124-14.....51
03112-02.....5	05160-03.....28	05311-03.....37	07402-10.....46	09125-14.....51
03113-00.....6	05160-04.....28	05311-04.....37	07403-01.....47	09128-14.....52
03113-01.....6	05170-24.....28	05320-01.....37	07403-02.....47	09130-14.....52
03113-02.....6	05190-17.....28	05320-02.....37	07410-05.....47	09131-14.....52
03114-00.....7	05190-20.....28	05320-03.....37	07412-05.....47	09140-14.....52
03114-01.....7	05190-25.....28	05320-04.....37	07420-08.....48	09141-14.....52
03114-02.....7	05203-00.....31	05321-01.....37	07421-09.....48	09150-14.....52
03120-00.....8	05204-00.....31	05321-02.....37	07422-19.....48	09151-14.....52
03122-00.....9	05210-00.....29	05321-03.....37	07423-16.....48	09160-14.....52/1
03126-00.....10	05210-01.....29	05321-04.....37	07423-20.....48	09160-17.....52/1
03132-00.....11	05210-02.....29	07103-00.....38	07423-24.....48	09160-19.....52/1
03132-01.....11	05210-03.....29	07103-01.....38	07424-11.....48	09160-23.....52/1
03132-02.....11	05210-04.....29	07103-02.....38	07424-14.....48	09160-28.....52/1
03133-00.....12	05211-00.....29	07104-00.....39	07424-17.....48	09161-14.....52/1
03133-01.....12	05211-01.....29	07104-02.....39	07425-11.....48	09161-17.....52/1
03133-02.....12	05211-02.....29	07105-02.....39	07490-00.....49	09161-19.....52/1
03161-00.....13	05211-03.....29	07106-01.....39/1	07490-01.....49	09161-23.....52/1
03161-01.....14	05211-04.....29	07106-02.....39/1	07490-02.....49	09161-28.....52/1
03161-02.....15	05220-00.....29	07107-00.....39/2	07495-31.....50	09164-14.....52/1
03161-03C.....16	05220-01.....29	07107-01.....39/2	07496-00.....49	09164-17.....52/1
03161-03T.....16	05220-02.....29	07107-03.....39/2	07496-31.....50	09164-23.....52/1
03167-03.....20	05220-03.....29	07107-04.....39/2	07498-00.....50	09165-14.....52/1
03171-00.....17	05220-04.....29	07108-00.....40	07499-00.....50	09165-17.....52/1
03171-01.....17	05221-00.....29	07109-03.....40	07499-01.....50	09165-23.....52/1
03171-02.....17	05221-01.....29	07109-10.....41	09102-11.....51	09170-15.....52/1
03180-90.....21	05221-02.....29	07109-13.....41	09102-13.....51	09170-17.....52/1
03180-92.....21	05221-03.....29	07109-15.....41	09102-14.....51	09170-21.....52/1
03180-93.....21	05221-04.....29	07110-00.....42	09102-15.....51	09171-15.....52/1
03195-00.....22	05223-00.....31	07111-00.....42	09102-16.....51	09171-17.....52/1
03195-01.....22	05224-00.....31	07112-00.....42	09102-18.....51	09171-21.....52/1
03195-04.....22	05230-00.....30	07113-00.....42	09102-20.....51	09174-15.....52/1
03195-06.....22	05230-01.....30	07115-00.....42	09103-11.....51	09174-17.....52/1
03195-07.....22	05230-02.....30	07116-00.....42	09103-13.....51	09174-21.....52/1
03195-08.....22	05230-03.....30	07118-00.....42	09103-14.....51	09175-15.....52/1
03195-09.....22	05230-04.....30	07119-00.....42	09103-15.....51	09175-17.....52/1
03195-10.....22	05233-18.....32	07120-00.....42	09103-16.....51	09175-21.....52/1
03246-00.....23	05234-28.....32	07121-00.....42	09103-18.....51	09180-17.....52/1
03246-01.....23	05234-37.....32	07122-00.....42	09103-20.....51	09181-17.....52/1
03246-02.....23	05238-01.....32	07123-00.....42	09104-14.....51	09190-16.....53
03248-00.....23	05238-02.....33	07124-00.....42	09105-14.....51	09191-16.....53
03260-15.....23	05238-03.....33	07125-00.....42	09110-11.....51	09194-16.....53
03262-18.....23	05239-01.....29/30	07130-00.....42	09110-13.....51	09195-16.....53
03288-17.....24	05239-02.....29/30	07161-00.....41	09110-14.....51	09202-10.....53
03288-20.....24	05239-03.....29	07162-00.....41	09110-15.....51	09203-10.....53
03292-22.....24	05240-30.....34	07165-00.....41	09110-16.....51	09204-22.....53
03294-24.....24	05241-11.....34	07167-00.....41	09110-18.....51	09206-10.....53
03304-20.....24	05241-22.....34	07200-17.....44	09110-20.....51	09207-10.....53
03306-17.....24	05300-01.....36	07200-20.....44	09111-11.....51	09280-12.....53/1
03308-18.....24	05300-02.....36	07201-13.....44	09111-13.....51	09280-15.....53/1
03310-01.....25	05300-03.....36	07201-16.....44	09111-14.....51	09280-18.....53/1
03310-02.....25	05300-04.....36	07201-19.....44	09111-15.....51	09280-20.....53/1
03312-01.....25	05300-05.....36	07201-22.....44	09111-16.....51	09280-23.....53/1
03314-01.....25	05300-06.....36	07202-12.....44	09111-18.....51	09280-25.....53/1
03320-19.....25	05301-01.....35	07203-16.....44	09111-20.....51	09280-28.....53/1
03340-10.....25	05301-02.....35	07203-19.....44	09114-14.....51	09280-30.....53/1
03340-15.....25	05301-03.....35	07203-22.....44	09115-14.....51	09281-12.....53/1
03340-20.....25	05301-04.....35	07204-11.....44	09120-11.....51	09281-15.....53/1
03340-30.....25	05301-05.....35	07205-09.....44	09120-13.....51	09281-18.....53/1
03340-50.....25	05301-06.....35	07290-09.....45	09120-14.....51	09281-20.....53/1
03350-15.....25	05301-07.....35	07291-11.....45	09120-15.....51	09281-23.....53/1
03360-21.....26	05302-01.....36	07294-13.....45	09120-16.....51	09281-25.....53/1
03361-10.....26	05302-02.....36	07296-00.....45/50	09120-18.....51	09281-28.....53/1
05130-05.....27	05302-03.....36	07402-01.....46	09120-20.....51	09281-30.....53/1
05130-10.....27	05303-01.....36	07402-02.....46	09121-11.....51	09282-15.....53/1
05140-05.....27	05304-01.....36	07402-03.....46	09121-13.....51	09282-18.....53/1
05140-08.....27	05310-01.....37	07402-04.....46	09121-14.....51	09282-20.....53/1
05150-21.....27	05310-02.....37	07402-05.....46	09121-15.....51	09282-23.....53/1
05150-27.....27	05310-03.....37	07402-06.....46	09121-16.....51	09282-25.....53/1
05151-01.....27	05310-04.....37	07402-07.....46	09121-18.....51	09282-28.....53/1

09283-15.....53/1	09348-05.....55	09505-23.....63	09829-12.....67	10013-19.....73
09283-18.....53/1	09348-06.....55	09505-26.....63	09831-12.....67	10014-19.....73
09283-20.....53/1	09349-09.....58	09505-30.....63	09835-12.....67	10015-19.....73
09283-23.....53/1	09349-12.....55	09507-23.....63	09850-10.....68	10016-17.....73
09283-25.....53/1	09350-09.....57	09507-26.....63	09851-10.....68	10017-17.....73
09283-28.....53/1	09350-10.....56	09507-30.....63	09854-11.....69	10018-20.....73
09284-12.....53/1	09351-09.....57	09510-20.....62	09859-16.....69	10019-20.....73
09284-15.....53/1	09352-09.....57	09510-23.....62	09860-16.....69	10020-17.....73
09284-18.....53/1	09353-09.....57	09511-20.....62	09861-16.....69	10021-17.....73
09284-20.....53/1	09354-10.....57	09511-23.....62	09898-20.....69/1	10022-20.....73
09284-23.....53/1	09355-10.....57	09512-20.....62	09901-09.....69/1	10023-20.....73
09284-25.....53/1	09356-10.....57	09512-23.....62	09901-11.....69/1	10024-17.....73
09284-28.....53/1	09357-10.....57	09513-20.....62	09901-14.....69/1	10025-17.....73
09284-30.....53/1	09358-11.....56	09513-23.....62	09901-18.....69/1	10026-20.....73
09285-12.....53/1	09360-11.....58	09514-20.....62	09901-20.....69/1	10027-20.....73
09285-15.....53/1	09361-11.....58	09514-23.....62	09905-14.....69/1	10028-14.....73
09285-18.....53/1	09362-11.....58	09515-20.....62	09905-18.....69/1	10029-14.....73
09285-20.....53/1	09363-11.....58	09515-23.....62	09906-18.....69/1	10030-18.....73
09285-23.....53/1	09370-11.....58	09516-23.....62	09906-20.....69/1	10031-18.....73
09285-25.....53/1	09371-11.....58	09517-23.....62	09911-23.....69/1	10032-23.....73
09285-28.....53/1	09374-11.....58	09523-24.....62	09913-20.....69/2	10033-23.....73
09285-30.....53/1	09375-11.....58	09525-22.....63	09913-22.....69/2	10034-14.....73
09286-15.....53/1	09381-11.....58	09530-17.....63	09915-23.....69/2	10035-14.....73
09286-18.....53/1	09401-18.....58	09531-17.....63	09921-16.....69/2	10036-18.....73
09286-20.....53/1	09403-15.....58	09536-27.....63	09921-19.....69/2	10037-18.....73
09286-23.....53/1	09405-16.....59	09537-27.....63	09930-14.....70	10038-23.....73
09286-25.....53/1	09406-16.....59	09540-16.....61	09931-14.....70	10039-23.....73
09286-28.....53/1	09425-17.....59	09541-16.....61	09933-23.....70	10040-18.....74
09287-15.....53/1	09427-17.....59	09542-16.....61	09935-23.....70	10041-18.....74
09287-18.....53/1	09435-18.....59	09543-16.....61	09937-23.....70	10042-18.....74
09287-20.....53/1	09437-19.....59	09548-18.....64	09939-23.....70	10044-14.....74
09287-23.....53/1	09439-17.....59	09550-10.....64	09941-20.....70	10045-14.....74
09287-25.....53/1	09468-15.....59	09551-16.....64	09950-15.....70	10046-14.....74
09287-28.....53/1	09470-11.....59	09553-16.....64	09950-18.....70	10047-14.....74
09289-28.....53/2	09473-21.....59	09560-14.....64	09960-14.....71	10048-14.....74
09290-25.....53/2	09475-00.....60	09560-22.....64	09961-14.....71	10049-14.....74
09291-18.....54	09475-25.....60	09580-11.....65	09962-14.....71	10102-11.....75
09291-20.....54	09475-45.....60	09581-11.....65	09962-17.....71	10104-11.....75
09291-23.....54	09475-60.....60	09582-15.....65	09962-23.....71	10110-12.....75
09295-18.....54	09475-90.....60	09583-15.....65	09963-14.....71	10111-12.....75
09295-20.....54	09476-00.....60	09601-22.....65	09963-17.....71	10113-11.....75
09295-23.....54	09476-25.....60	09610-18.....65	09963-23.....71	10115-11.....75
09296-15.....54	09476-45.....60	09611-18.....65	09964-15.....71	10117-11.....75
09296-18.....54	09476-60.....60	09613-20.....65/1	09964-17.....71	10119-10.....75
09296-23.....54	09476-90.....60	09614-19.....65/1	09965-15.....71	10120-16.....76
09302-14.....54/1	09477-01.....60	09617-13.....65/1	09965-17.....71	10120-18.....76
09303-14.....54/1	09478-25.....60	09619-17.....65/1	09966-11.....71	10120-22.....76
09304-14.....54/1	09478-45.....60	09641-30.....65/2	09967-11.....71	10121-16.....76
09305-14.....54/1	09478-60.....60	09643-19.....65/2	09970-14.....71	10121-18.....76
09310-12.....54/1	09479-25.....60	09643-25.....65/2	09970-18.....71	10121-22.....76
09310-15.....54/1	09479-45.....60	09651-24.....65/2	09970-20.....71	10122-16.....76
09312-12.....54/1	09479-60.....60	09661-23.....65/2	09970-23.....71	10122-18.....76
09314-12.....54/1	09480-25.....61	09770-18.....66	09971-14.....71	10122-22.....76
09320-15.....54/1	09480-40.....61	09772-21.....66	09971-18.....71	10123-16.....76
09321-15.....54/1	09480-60.....61	09774-21.....66	09971-20.....71	10123-18.....76
09321-18.....54/1	09481-25.....61	09775-13.....66	09971-23.....71	10123-22.....76
09325-15.....54/1	09481-40.....61	09777-13.....66	09980-11.....72	10124-16.....76
09340-09.....54/2	09481-60.....61	09802-09.....66	09981-11.....72	10124-18.....76
09340-10.....54/2	09490-16.....61	09802-11.....66	09982-12.....72	10124-22.....76
09340-11.....54/2	09490-23.....61	09803-09.....66	09983-12.....72	10125-16.....76
09341-09.....54/2	09490-28.....61	09803-13.....66	09984-11.....72	10125-18.....76
09341-10.....54/2	09491-16.....61	09804-14.....66	09985-11.....72	10125-22.....76
09341-11.....54/2	09491-23.....61	09809-15.....66	09986-11.....72	10126-00.....77
09344-11.....54/2	09491-28.....61	09820-13.....67	09990-14.....72	10126-25.....77
09345-11.....54/2	09492-16.....61	09821-13.....67	09990-18.....72	10126-45.....77
09346-11.....54/2	09492-23.....61	09823-12.....67	09993-15.....72	10126-60.....77
09347-09.....58	09492-28.....61	09824-12.....67	09993-18.....72	10126-90.....77
09348-01.....55	09496-15.....61	09825-12.....67	09995-12.....72	10127-00.....77
09348-02.....55	09497-15.....61	09826-12.....67	10010-19.....73	10127-25.....77
09348-03.....55	09501-22.....63	09827-12.....67	10011-19.....73	10127-45.....77
09348-04.....55	09501-23.....63	09828-12.....67	10012-19.....73	10127-60.....77

10127-90.....77	11120-25.....81/1	11232-15.....83	11404-04.....90	12340-16.....99
10128-09.....78	11120-30.....81/1	11233-20.....84	11405-05.....90	12340-20.....99
10128-15.....78	11122-12.....81/1	11234-20.....84	11407-07.....90	12340-24.....99
10129-15.....78	11122-13.....81/1	11235-20.....84	11802-09.....91	13001-08.....101
10130-15.....78	11122-14.....81/1	11236-15.....84	11802-10.....91	13001-10.....101
10131-14.....78	11122-15.....81/1	11236-20.....84	11802-11.....91	13001-12.....101
10131-18.....78	11122-18.....81/1	11237-20.....84	11810-07.....91	13002-08.....101
10132-18.....78	11122-21.....81/1	11240-14.....84	11810-09.....91	13002-10.....101
10133-10.....79	11122-25.....81/1	11242-14.....84	11810-11.....91	13002-12.....101
10135-10.....79	11124-15.....81/1	11246-18.....85	11812-10.....91	13005-10.....101
10137-01.....78	11126-18.....81	11248-18.....85	11813-10.....91	13005-14.....101
10137-02.....78	11126-21.....81	11250-14.....85	11815-12.....91	13005-20.....101
10140-08.....79	11126-25.....81	11252-20.....85	11816-10.....91	13006-10.....101
10141-08.....79	11130-11.....81/1	11256-15.....85	11817-10.....91	13006-14.....101
10142-08.....79	11130-13.....81/1	11256-20.....85	11821-11.....92	13006-20.....101
10143-08.....79	11130-14.....81/1	11256-25.....85	11822-13.....92	13010-30.....102
10151-11.....79	11130-16.....81/1	11257-15.....85	11823-13.....92	13010-35.....102
10153-11.....79	11130-18.....81/1	11258-15.....85	11824-14.....92	13010-40.....102
10155-11.....79	11130-20.....81/1	11259-15.....85	11825-14.....92	13010-50.....102
10202-18.....80	11132-16.....81/1	11260-12.....86	11828-15.....92	13011-30.....102
10203-18.....80	11132-18.....81/1	11260-15.....86	11900-01.....93	13011-35.....102
10313-14.....80	11132-20.....81/1	11261-15.....86	11901-05.....93	13011-40.....102
10313-16.....80	11132-25.....81/1	11270-12.....86	11910-01.....93	13011-50.....102
10320-09.....80	11132-30.....81/1	11270-15.....86	12102-12.....94	13012-30.....102
10330-19.....80	11140-11.....81/1	11271-15.....86	12103-12.....94	13012-35.....102
10331-19.....80	11140-13.....81/1	11271-18.....86	12104-15.....94	13012-40.....102
10333-19.....80	11140-14.....81/1	11272-15.....86	12105-15.....94	13012-50.....102
11102-10.....81	11140-16.....81/1	11273-15.....86	12108-18.....94	13013-30.....102
11102-11.....81	11140-18.....81/1	11274-06.....86	12109-18.....94	13013-35.....102
11102-13.....81	11140-20.....81/1	11274-08.....86	12110-15.....95	13013-40.....102
11102-14.....81	11140-25.....81/1	11274-10.....86	12110-20.....95	13013-50.....102
11102-16.....81	11150-13.....81/1	11302-17.....86	12110-24.....95	13014-30.....102
11102-18.....81	11150-14.....81/1	11302-23.....86	12110-30.....95	13014-35.....102
11102-20.....81	11150-16.....81/1	11303-17.....86	12200-16.....96	13014-40.....102
11102-25.....81	11160-13.....81/1	11304-17.....86	12201-16.....96	13014-50.....102
11102-30.....81	11160-14.....81/1	11305-17.....87	12291-22.....97	13015-30.....102
11103-14.....81	11160-16.....81/1	11310-17.....87	12293-22.....97	13015-35.....102
11104-12.....81	11170-12.....81/2	11311-17.....87	12295-22.....97	13015-40.....102
11104-13.....81	11170-15.....81/2	11312-17.....87	12297-22.....97	13015-50.....102
11104-14.....81	11174-12.....81/2	11312-18.....87	12302-16.....98	13090-40.....100
11104-15.....81	11174-15.....81/2	11313-17.....87	12302-20.....98	13090-45.....100
11104-18.....81	11176-12.....81/2	11314-01.....87	12302-24.....98	13090-50.....100
11104-21.....81	11176-15.....81/2	11314-02.....87	12304-16.....98	13091-40.....100
11104-25.....81	11177-12.....81/2	11315-01.....87	12304-20.....98	13091-45.....100
11106-13.....81	11178-12.....81/2	11315-02.....87	12304-24.....98	13091-50.....100
11106-15.....81	11179-12.....81/2	11316-14.....88	12304-30.....98	13092-07.....103
11110-11.....81	11180-12.....82	11316-16.....88	12306-16.....98	13092-08.....103
11110-13.....81	11180-15.....82	11316-20.....88	12306-20.....98	13092-10.....103
11110-14.....81	11181-12.....82	11317-00.....88	12306-24.....98	13092-12.....103
11110-16.....81	11181-15.....82	11317-12.....88	12306-30.....98	13093-07.....103
11110-18.....81	11186-12.....82	11317-23.....88	12308-16.....98	13093-08.....103
11110-20.....81	11186-15.....82	11318-18.....88	12308-20.....98	13093-10.....103
11110-25.....81	11187-12.....82	11318-20.....88	12308-24.....98	13093-12.....103
11110-30.....81	11187-18.....83	11318-25.....88	12308-30.....98	13096-06.....103
11112-18.....81	11187-20.....83	11319-12.....88	12309-16.....98	13096-07.....103
11112-21.....81	11187-25.....83	11319-14.....88	12309-20.....98	13096-09.....103
11112-25.....81	11187-30.....83	11320-18.....88	12309-24.....98	13096-11.....103
11114-14.....81	11188-12.....82	11320-23.....88	12309-30.....98	13097-06.....103
11114-16.....81	11188-15.....82	11322-15.....89	12310-16.....98	13097-07.....103
11114-20.....81	11189-12.....82	11322-18.....89	12310-20.....98	13097-09.....103
11114-25.....81	11189-15.....83	11322-23.....89	12310-24.....98	13097-11.....103
11116-18.....81	11189-20.....83	11324-23.....89	12310-30.....98	13098-06.....100
11116-21.....81	11189-25.....83	11325-15.....89	12320-15.....99	13099-07.....100
11116-25.....81	11190-10.....83	11325-23.....89	12320-20.....99	13102-04.....104
11120-10.....81/1	11220-17.....83	11325-25.....89	12320-24.....99	13102-05.....104
11120-11.....81/1	11221-17.....83	11326-23.....89	12325-16.....99	13103-04.....104
11120-13.....81/1	11222-17.....83	11328-15.....89	12325-20.....99	13103-05.....104
11120-14.....81/1	11223-17.....83	11328-20.....89	12325-24.....99	13110-50.....104
11120-16.....81/1	11224-17.....83	11401-01.....90	12330-16.....99	13110-55.....104
11120-18.....81/1	11225-17.....83	11403-03.....90	12330-20.....99	13110-65.....104
11120-20.....81/1	11231-20.....84	11403-04.....90	12330-24.....99	13110-70.....104

13110-75.....104	13310-24.....108	13381-15.....111	13447-20.....117	13580-80.....126
13110-90.....104	13310-26.....108	13382-15.....111	13448-22.....117	13591-20.....126
13111-50.....104	13310-30.....108	13383-15.....111	13449-22.....117	13591-23.....126
13111-55.....104	13311-13.....108	13384-20.....112	13450-24.....118	13593-20.....126
13111-65.....104	13311-14.....108	13384-26.....112	13451-24.....118	13593-23.....126
13111-70.....104	13311-16.....108	13385-20.....112	13453-18.....118	13595-10.....127
13111-75.....104	13311-18.....108	13385-26.....112	13453-24.....118	13595-20.....127
13111-90.....104	13311-20.....108	13386-20.....112	13455-01.....118	13595-30.....127
13115-00.....104	13311-22.....108	13386-26.....112	13455-02.....118	13595-40.....127
13210-10.....104	13311-24.....108	13387-20.....112	13456-01.....119	13597-10.....127
13211-10.....104	13311-26.....108	13387-26.....112	13456-02.....119	13597-20.....127
13212-10.....104	13311-30.....108	13390-20.....112	13456-03.....119	13597-30.....127
13213-10.....104	13312-14.....108	13391-20.....112	13457-28.....119	13597-40.....127
13214-10.....104	13312-16.....108	13391-23.....112	13459-18.....119	13598-24.....126
13215-10.....104	13313-14.....108	13393-20.....112	13459-28.....119	13599-24.....126
13220-12.....105	13313-16.....108	13394-20.....112	13471-14.....119/1	13600-20.....127
13220-14.....105	13320-13.....108	13395-20.....112	13471-16.....119/1	13601-20.....127
13220-18.....105	13320-14.....108	13410-18.....112	13471-18.....119/1	13605-26.....128
13220-21.....105	13320-16.....108	13411-18.....112	13471-23.....119/1	13610-21.....128/1
13221-12.....105	13320-18.....108	13412-18.....113	13473-22.....119/1	13611-21.....128/1
13221-14.....105	13320-20.....108	13413-18.....113	13474-19.....119/1	13612-21.....128/1
13221-18.....105	13320-22.....108	13414-20.....113	13474-24.....119/1	13613-21.....128/1
13221-21.....105	13320-24.....108	13415-14.....113	13474-26.....119/1	13620-24.....128/1
13222-12.....105	13320-26.....108	13415-18.....113	13475-14.....119/1	13620-26.....128/1
13223-12.....105	13320-30.....108	13416-18.....113	13475-18.....119/1	13620-30.....128/1
13224-12.....105	13321-13.....108	13420-14.....114	13477-15.....119/2	13621-24.....128/1
13225-12.....105	13321-14.....108	13421-01.....114	13477-19.....119/2	13621-26.....128/1
13226-12.....105	13321-16.....108	13421-02.....114	13479-22.....119/2	13621-30.....128/1
13227-12.....105	13321-18.....108	13421-03.....114	13479-25.....119/2	13622-24.....128/1
13230-12.....105	13321-20.....108	13421-04.....114	13479-28.....119/2	13622-26.....128/1
13230-14.....105	13321-22.....108	13421-05.....114	13480-15.....119/2	13622-30.....128/1
13230-18.....105	13321-24.....108	13421-06.....114	13480-18.....119/2	13623-24.....128/1
13230-21.....105	13321-26.....108	13421-07.....114	13481-15.....119/2	13623-26.....128/1
13231-12.....105	13321-30.....108	13422-00.....114	13481-18.....119/2	13623-30.....128/1
13231-14.....105	13322-14.....108	13422-01.....114	13491-19.....119/2	13702-14.....129
13231-18.....105	13322-16.....108	13422-02.....114	13493-23.....120	13704-16.....129
13231-21.....105	13323-14.....108	13422-03.....114	13495-18.....120	13704-18.....129
13232-12.....105	13323-16.....108	13422-06.....114	13497-20.....120	13710-15.....129
13233-12.....105	13330-13.....109	13425-02.....114	13499-16.....120	13710-18.....129
13240-14.....106	13330-15.....109	13425-03.....114	13501-23.....120	13710-20.....129
13240-18.....106	13330-18.....109	13425-04.....114	13503-21.....121	13712-15.....129
13241-14.....106	13330-20.....109	13425-05.....114	13505-21.....121	13712-18.....129
13241-18.....106	13331-13.....109	13425-06.....114	13507-22.....121	13712-20.....129
13242-16.....106	13331-15.....109	13428-21.....115	13507-23.....121	13720-18.....130
13243-16.....106	13331-18.....109	13431-13.....115	13513-23.....122	13730-16.....131
13244-14.....106	13331-20.....109	13431-16.....115	13515-23.....122	15101-09.....132
13245-14.....106	13340-16.....109	13431-18.....115	13517-23.....122	15103-07.....132
13250-14.....107	13340-20.....109	13431-20.....115	13519-20.....122	15103-09.....132
13250-18.....107	13341-16.....109	13431-23.....115	13519-22.....122	15105-09.....132
13251-14.....107	13341-20.....109	13431-25.....115	13519-24.....122	15107-10.....132
13251-18.....107	13345-12.....109	13431-28.....115	13520-23.....122	15107-13.....132
13254-14.....107	13345-14.....109	13432-19.....116	13520-24.....122	15108-14.....132
13255-14.....107	13350-16.....109	13433-19.....116	13523-23.....123	15111-09.....132
13256-14.....106	13350-20.....109	13434-28.....116	13551-14.....123	15111-11.....132
13257-14.....106	13351-16.....109	13435-28.....116	13551-18.....123	15111-13.....132
13258-16.....106	13351-20.....109	13438-01.....116	13551-20.....123	15111-15.....132
13259-16.....106	13356-15.....109	13438-02.....116	13554-21.....123	15115-11.....132
13260-14.....107	13358-15.....109	13438-03.....116	13555-21.....123	15117-13.....132
13261-14.....107	13358-20.....109	13438-04.....116	13556-24.....123	15121-11.....133
13262-16.....107	13360-15.....110	13441-01.....117	13561-20.....123	15121-13.....133
13263-16.....107	13364-14.....110	13441-02.....117	13563-20.....123	15123-11.....133
13264-16.....107	13366-19.....110	13441-03.....117	13564-20.....123/1	15123-13.....133
13265-16.....107	13368-14.....110	13441-04.....117	13565-20.....123/2	15125-14.....133
13270-14.....106	13368-16.....110	13442-21.....117	13565-25.....123/2	15140-16.....133
13271-14.....106	13370-13.....110	13442-26.....117	13570-23.....124	15150-19.....133
13310-13.....108	13372-13.....110	13443-21.....117	13571-25.....124	15161-18.....133
13310-14.....108	13374-14.....110	13443-26.....117	13573-22.....124	15164-15.....133
13310-16.....108	13376-16.....110	13444-21.....117	13574-24.....125	15164-20.....133
13310-18.....108	13377-25.....111	13444-26.....117	13575-24.....125	17110-20.....134
13310-20.....108	13377-26.....111	13445-21.....117	13579-21.....125	17110-25.....134
13310-22.....108	13380-15.....111	13445-26.....117	13580-60.....126	17111-20.....134

17111-25.....134	19152-64.....142	19196-04.....148/1	19250-24.....153	19314-20.....159
17112-20.....134	19158-51.....142	19196-05.....148/1	19270-02.....153	19315-06.....159
17112-25.....134	19158-64.....142	19196-06.....148/1	19270-03.....153	19315-21.....159
17113-20.....134	19158-76.....142	19210-12.....148/2	19270-04.....153	19317-21.....159
17113-25.....134	19158-82.....142	19211-12.....148/2	19270-06.....153	19318-40.....159
17120-28.....134	19159-50.....142	19212-01.....148/2	19271-02.....153	19318-57.....159
17121-28.....134	19159-64.....142	19212-02.....148/2	19271-03.....153	19318-78.....159
17131-21.....134	19159-70.....142	19214-13.....148/2	19271-04.....153	19330-40.....158
17133-17.....135	19159-90.....142	19214-18.....148/2	19271-06.....153	19330-55.....158
17160-22.....135	19160-17.....143	19215-01.....149	19280-01.....154	19332-19.....160
17160-25.....135	19161-17.....143	19215-02.....149	19280-02.....154	19332-21.....160
17161-22.....135	19162-10.....143	19215-03.....149	19280-03.....154	19340-10.....160
17161-25.....135	19162-13.....143	19215-13.....148/2	19280-04.....154	19340-15.....160
17170-18.....136	19168-06.....143/1	19215-18.....148/2	19280-06.....154	19340-20.....160
17170-20.....136	19168-08.....143/1	19216-01.....149	19281-01.....154	19344-14.....160
17170-25.....136	19168-10.....143/1	19216-02.....149	19281-02.....154	19344-20.....160
17170-30.....136	19168-12.....143/1	19216-05.....149	19281-03.....154	19344-26.....160
17171-18.....136	19168-17.....143/1	19216-07.....149	19281-04.....154	19345-01.....160
17171-20.....136	19168-20.....143/1	19216-10.....149	19281-06.....154	19345-02.....160
17171-25.....136	19168-25.....143/1	19217-03.....149	19282-02.....154	19345-03.....160
17172-18.....136	19169-25.....143/1	19217-05.....149	19282-03.....154	19348-22.....160
17172-25.....136	19170-20.....143/1	19217-07.....149	19282-04.....154	19350-35.....161
17173-18.....136	19170-25.....143/1	19220-01.....150	19282-06.....154	19350-60.....161
17173-25.....136	19170-32.....143/1	19220-02.....150	19296-01.....155	19350-70.....161
17174-25.....136	19170-40.....143/1	19220-03.....150	19296-02.....155	19360-04.....162
17175-25.....136	19170-45.....143/1	19220-04.....150	19296-03.....155	19364-40.....162
17180-18.....136	19170-50.....143/1	19221-01.....150	19296-04.....155	19364-50.....162
17180-25.....136	19170-65.....143/1	19221-02.....150	19296-06.....155	19364-60.....162
17207-13.....137	19170-76.....143/1	19221-03.....150	19296-08.....155	19364-70.....162
17210-13.....137	19171-30.....143/2	19221-04.....150	19297-01.....155	19366-08.....162
17210-16.....137	19171-40.....143/2	19222-02.....150	19297-02.....155	19367-08.....162
17210-18.....137	19171-50.....143/2	19222-03.....150	19297-03.....155	19370-40.....163
17220-25.....137	19171-60.....143/2	19222-04.....150	19297-04.....155	19370-50.....163
17226-25.....137	19171-70.....143/2	19227-02.....150	19297-06.....155	19370-60.....163
17227-25.....137	19172-30.....143/3	19227-03.....150	19297-08.....155	19370-75.....163
17229-25.....137	19173-20.....143/3	19227-04.....150	19298-01.....156	19370-85.....163
17230-26.....138	19173-30.....143/3	19229-02.....150	19299-01.....156	19372-22.....163
17231-26.....138	19173-40.....143/3	19229-03.....150	19300-02.....156	19374-45.....163
17233-26.....138	19174-17.....143/3	19230-10.....151	19300-03.....156	19374-55.....163
19102-12.....139	19174-25.....143/3	19230-12.....151	19300-04.....156	19374-65.....163
19102-15.....139	19174-37.....143/3	19230-14.....151	19300-06.....156	19378-25.....163
19104-15.....139	19174-40.....143/3	19230-16.....151	19301-02.....156	19380-35.....163
19110-13.....139	19175-28.....143/3	19230-18.....151	19301-03.....156	19380-50.....163
19110-18.....139	19176-25.....143/4	19231-11.....151	19301-04.....156	19381-50.....163
19120-00.....139	19177-27.....143/4	19231-13.....151	19301-06.....156	19382-50.....163
19120-14.....139	19178-28.....143/4	19231-15.....151	19302-01.....157	19385-38.....164
19120-15.....139	19179-28.....144	19232-08.....151	19302-02.....157	19385-57.....164
19120-17.....139	19180-19.....145	19232-10.....151	19302-03.....157	19388-40.....164
19122-13.....140	19181-22.....145	19232-12.....151	19302-04.....157	19388-50.....164
19123-11.....140	19181-25.....145	19232-14.....151	19302-05.....157	19388-65.....164
19124-15.....140	19183-25.....145	19232-16.....151	19302-06.....157	19400-01.....165
19125-14.....140	19185-25.....145	19232-18.....151	19304-19.....157	19400-02.....165
19126-13.....140	19187-25.....145	19233-08.....152	19306-20.....157	19400-03.....165
19127-11.....140	19187-38.....146	19233-11.....152	19307-01.....157	19480-22.....164
19131-21.....141	19187-50.....146	19233-15.....152	19307-02.....157	19480-27.....164
19132-15.....141	19187-75.....146	19233-17.....152	19310-01.....158	19482-45.....164
19134-20.....141	19189-25.....146	19233-20.....152	19310-02.....158	19482-73.....164
19135-19.....141	19189-38.....146	19233-23.....152	19310-03.....158	19482-82.....164
19136-20.....141	19189-50.....146	19234-20.....153	19310-04.....158	19484-01.....164
19137-16.....141	19189-75.....146	19235-21.....153	19310-05.....158	19484-02.....164
19140-00.....142	19190-64.....147	19236-01.....153	19312-01.....158	19490-22.....166
19140-01.....142	19191-25.....147	19236-02.....153	19312-02.....158	19490-43.....166
19140-02.....142	19191-40.....147	19236-08.....152	19312-03.....158	19490-65.....166
19150-01.....142	19191-62.....147	19236-10.....152	19312-04.....158	19492-25.....164
19150-02.....142	19192-23.....147	19236-12.....152	19312-05.....158	19493-80.....167
19150-03.....142	19195-01.....148	19236-14.....152	19314-07.....159	19494-00.....167
19150-04.....142	19195-02.....148	19236-16.....152	19314-10.....159	19494-12.....167
19152-25.....142	19195-03.....148	19236-18.....152	19314-12.....159	19494-13.....167
19152-31.....142	19196-01.....148/1	19240-10.....153	19314-14.....159	19494-14.....167
19152-38.....142	19196-02.....148/1	19240-20.....153	19314-15.....159	19494-16.....167
19152-51.....142	19196-03.....148/1	19250-16.....153	19314-16.....159	19494-18.....167

19494-45.....166	19688-01.....175	19771-01.....185	19825-06.....193/194	21115-10.....199
19494-60.....166	19688-02.....175	19771-02.....185	19826-06.....193/194	21120-16.....199
19494-75.....166	19689-01.....175/1	19771-03.....185	19831-25.....193/194	21121-14.....199
19495-60.....167	19689-02.....175/1	19772-00.....185	19833-33.....193/194	21121-18.....199
19495-80.....167	19690-31.....176	19772-03.....185	19834-01.....193/194	21122-13.....199
19496-00.....167	19692-32.....176	19780-01.....186	19902-10.....267	21122-18.....199
19496-12.....167	19694-01.....177	19781-55.....185/187	19903-00.....267	21125-01.....200
19496-14.....167	19694-02.....177	19781-65.....185/187	19910-00.....196	21125-02.....200
19496-50.....166	19694-03.....177	19782-00.....185	19911-00.....196	21125-03.....200
19496-90.....166	19696-18.....178	19783-00.....187	19912-50.....196	21125-04.....200
19497-14.....167	19698-18.....178	19783-01.....187	19912-70.....196	21150-00.....201
19498-01.....167	19710-00.....178/1	19783-24.....185	19913-50.....196	21150-02.....201
19498-02.....167	19710-01.....178/1, 178/2	19784-00.....187/1	19913-70.....196	21150-03.....201
19498-03.....167	19710-40.....178/1, 178/3	19784-30.....187/1	19914-41.....196	21150-06.....201
19610-07.....168	19710-45.....178/1, 178/3	19784-40.....187/1	19914-67.....196	21150-09.....201
19611-07.....168	19710-50.....178/1, 178/3	19784-50.....187/1	19915-48.....196	21150-12.....201
19620-07.....168	19710-55.....178/1, 178/3	19784-60.....187/1	19915-64.....196	21150-15.....201
19620-10.....168	19710-60.....178/1, 178/3	19784-78.....187/1	19916-64.....196	21150-80.....201
19621-07.....168	19711-00.....178/3	19784-80.....187/1	19916-80.....196	21150-90.....201
19621-10.....168	19711-01.....178/3, 178/4	19784-98.....187/1	19917-64.....196	21154-01.....202
19630-10.....168	19711-40.....178/2, 178/4	19784-99.....187/1	19918-64.....196	21154-02.....202
19631-10.....168	19711-45.....178/2, 178/4	19790-01.....186	19918-88.....196	21154-03.....202
19634-10.....168	19711-50.....178/2, 178/4	19790-02.....186	19960-01.....197	21154-04.....202
19635-10.....168	19711-55.....178/2, 178/4	19795-01.....188	19960-02.....197	21154-05.....202
19636-14.....168	19711-60.....178/2, 178/4	19795-02.....188	19960-03.....197	21154-06.....202
19637-14.....168	19712-00.....178/2	19798-01.....188	19960-04.....197	21160-04.....202
19640-14.....169	19713-00.....178/4	19798-02.....188	19960-05.....197	21160-06.....202
19641-14.....169	19721-00.....179	19798-03.....188	19960-06.....197	21160-07.....202
19650-10.....169	19721-15.....179	19798-04.....188	19970-01.....198	21160-08.....202
19651-10.....169	19726-01.....179	19799-03.....189	19980-01.....197	21160-10.....202
19654-13.....169	19738-45.....179	19799-04.....189	19980-02.....197	21160-12.....202
19655-13.....169	19738-50.....179	19799-05.....189	19980-03.....197	21160-14.....202
19670-14.....169	19738-55.....179	19799-06.....189	19980-04.....197	21162-12.....202
19670-16.....169	19738-60.....179	19800-01.....189/1	19980-05.....197	21190-14.....203
19670-20.....169	19738-65.....179	19800-02.....189/1	19980-06.....197	21270-12.....203
19670-24.....169	19744-00.....180	19800-03.....189/1	19980-18.....198	21270-14.....203
19671-14.....169	19744-17.....180	19800-04.....189/1	19990-18.....198	21270-16.....203
19671-16.....169	19745-40.....180	19802-09.....189/1	19995-22.....198	21270-18.....203
19671-20.....169	19745-45.....180	19802-11.....189/1	19995-38.....198	21270-23.....203
19671-24.....169	19745-50.....180	19802-14.....189/1	19998-03.....198	21272-12.....203
19672-11.....171	19745-55.....180	19802-16.....189/1	19998-05.....198	21272-14.....203
19673-11.....171	19745-60.....180	19802-18.....189/1	21102-11.....199	21272-16.....203
19674-15.....171	19745-65.....180	19803-14.....189/1	21102-13.....199	21272-18.....203
19675-00.....170	19745-70.....180	19804-18.....189/2	21102-14.....199	21272-23.....203
19675-13.....171	19748-01.....180	19805-18.....189/2	21102-16.....199	21290-12.....203
19676-00.....170	19748-02.....180	19806-18.....189/2	21102-18.....199	21290-14.....203
19677-13.....171	19748-03.....180	19810-22.....190	21102-20.....199	21290-16.....203
19677-19.....170	19748-04.....180	19812-60.....190	21102-25.....199	21290-18.....203
19677-25.....170	19754-00.....181	19813-00.....191	21104-11.....199	21292-12.....203
19677-32.....170	19758-85.....181	19816-00.....191	21104-13.....199	21292-14.....203
19678-05.....170	19759-00.....181	19820-02.....193/195	21104-14.....199	21292-16.....203
19678-06.....170	19760-14.....181	19820-03.....193/195	21104-16.....199	21292-18.....203
19678-16.....171	19762-16.....181	19820-10.....193/195	21104-18.....199	21310-15.....203
19679-20.....172	19764-18.....182	19820-20.....193/194	21104-20.....199	21320-12.....203
19679-22.....172	19764-20.....182	19820-90.....192/193	21104-25.....199	21320-18.....203
19680-19.....172	19764-25.....182	19820-91.....192/193	21106-11.....199	21331-25.....203
19681-19.....172	19765-01.....183	19820-99.....193	21106-13.....199	21340-45.....203
19681-21.....172	19765-02.....183	19821-01.....193/195	21106-14.....199	23104-00.....204
19682-26.....173	19765-03.....183	19821-02.....193/195	21106-16.....199	23110-30.....204
19683-26.....173	19765-04.....183	19821-03.....193/195	21106-18.....199	23110-35.....204
19684-14.....173	19766-90.....182	19821-04.....193/195	21106-20.....199	23110-40.....204
19684-16.....173	19767-01.....184	19822-01.....193	21106-25.....199	23110-45.....204
19684-20.....173	19767-02.....184	19822-02.....193	21108-14.....199	23110-50.....204
19684-26.....173	19767-18.....184	19822-21.....194	21109-18.....199	23110-55.....204
19685-14.....173	19767-25.....184	19822-22.....194	21110-13.....199	23110-60.....204
19685-16.....173	19770-01.....186	19822-22L.....194	21110-14.....199	23123-30.....204
19685-20.....173	19770-02.....186	19822-23.....193	21110-16.....199	23123-40.....204
19685-26.....173	19770-03.....186	19822-24.....193	21110-18.....199	23123-50.....204
19686-32.....174	19770-04.....186	19822-25.....193/194	21110-20.....199	23125-11.....204
19687-01.....175	19770-05.....186	19822-26.....193/194	21111-14.....199	23128-19.....204
19687-02.....175	19771-00.....185	19824-06.....193/194	21112-14.....199	23140-02.....204

23150-10.....205	25180-12.....209	25408-12.....212	25721-14.....217	27413-05.....222
23150-12.....205	25180-14.....209	25410-14.....212	25722-14.....217	27413-06.....222
23150-14.....205	25180-16.....209	25410-17.....212	25723-14.....217	27413-07.....222
23150-16.....205	25180-18.....209	25414-14.....212	25730-18.....217	27413-08.....222
23150-18.....205	25180-20.....209	25414-17.....212	25731-18.....217	27413-09.....222
23150-20.....205	25180-24.....209	25414-18.....212	27109-20.....218	27413-10.....222
23170-25.....205	25180-26.....209	25415-14.....212	27110-21.....218	27413-11.....222
23170-30.....205	25180-30.....209	25415-17.....212	27110-24.....218	27413-12.....222
23170-33.....205	25184-12.....209	25415-20.....212	27110-27.....218	27413-13.....222
23170-35.....205	25184-14.....209	25415-20.....212	27111-21.....218	27413-14.....222
23181-40.....205	25184-16.....209	25434-11.....212	27111-24.....218	27413-15.....222
23195-08.....207	25184-18.....209	25434-13.....212	27111-27.....218	27413-16.....222
23195-10.....207	25184-20.....209	25434-16.....212	27120-21.....218	27423-01.....222
23195-12.....207	25184-24.....209	25436-13.....212	27120-24.....218	27423-02.....222
23195-14.....207	25184-26.....209	25438-13.....212	27120-27.....218	27423-03.....222
23195-16.....207	25184-30.....209	25438-15.....213	27121-21.....218	27423-04.....222
23195-18.....207	25190-16.....209	25446-25.....213	27121-24.....218	27423-05.....222
23197-08.....207	25190-18.....209	25447-25.....213	27121-27.....218	27423-06.....222
23197-10.....207	25190-20.....209	25450-14.....213	27130-13.....219	27423-07.....222
23197-12.....207	25194-16.....209	25450-17.....213	27131-13.....219	27423-08.....222
23197-14.....207	25194-18.....209	25450-20.....213	27133-24.....219	27423-09.....222
23197-16.....207	25194-20.....209	25450-24.....213	27134-32.....219	27423-10.....222
23197-18.....207	25196-13.....209	25452-14.....213	27135-24.....219	27423-11.....222
23198-08.....207	25196-18.....209	25452-17.....213	27139-19.....219	27423-12.....222
23198-10.....207	25214-16.....210	25452-20.....213	27201-15.....220	27423-13.....222
23198-12.....207	25214-18.....210	25452-24.....213	27201-19.....220	27423-14.....222
23198-14.....207	25214-20.....210	25460-18.....213	27201-21.....220	27423-15.....222
23198-16.....207	25214-23.....210	25460-20.....213	27202-15.....220	27423-16.....222
23198-18.....207	25214-26.....210	25460-23.....213	27202-19.....220	27433-01.....222
23210-00.....206	25214-31.....210	25465-20.....213	27202-21.....220	27433-02.....222
23250-20.....206	25224-13.....210	25465-25.....213	27203-15.....220	27433-03.....222
23250-40.....206	25224-15.....210	25466-17.....213	27203-19.....220	27433-04.....222
23302-01.....206	25224-18.....210	25466-20.....213	27203-21.....220	27433-05.....222
23302-02.....206	25224-20.....210	25467-17.....213	27204-15.....220	27433-06.....222
23302-03.....206	25224-23.....210	25467-20.....213	27204-19.....220	27433-07.....222
23302-04.....206	25224-26.....210	25610-11.....214	27204-21.....220	27433-08.....222
23302-05.....206	25225-13.....210	25612-13.....214	27240-00.....220	27433-09.....222
23302-06.....206	25225-15.....210	25612-15.....214	27240-01.....220	27433-10.....222
23302-07.....206	25225-18.....210	25614-12.....214	27240-02.....220	27433-11.....222
23302-08.....206	25225-20.....210	25615-12.....214	27240-03.....220	27433-12.....222
23310-14.....206	25225-23.....210	25620-16.....214	27271-19.....221	27433-13.....222
23310-18.....206	25225-26.....210	25621-16.....214	27273-19.....221	27433-14.....222
25110-12.....208	25230-18.....210	25624-16.....214	27275-30.....221	27433-15.....222
25114-12.....208	25230-20.....210	25625-16.....214	27277-25.....221	27433-16.....222
25120-12.....208	25230-23.....210	25627-14.....214	27285-20.....221/1	27434-01.....222
25122-12.....208	25241-21.....210	25628-14.....214	27288-22.....221/1	27434-02.....222
25128-13.....208	25241-26.....210	25650-10.....216	27289-22.....221/1	27434-03.....222
25129-13.....208	25245-21.....210	25651-10.....216	27291-18.....221/1	27434-04.....222
25130-13.....208	25245-26.....210	25656-10.....216	27291-27.....221/1	27434-05.....222
25134-13.....208	25250-27.....210	25657-10.....216	27297-23.....221/1	27434-06.....222
25136-11.....208	25254-27.....210	25660-13.....217	27298-23.....221/1	27434-07.....222
25137-11.....208	25260-27.....210	25661-13.....217	27403-01.....222	27434-08.....222
25138-11.....208	25264-27.....210	25667-18.....215	27403-02.....222	27434-09.....222
25140-13.....208	25285-20.....211	25667-21.....215	27403-03.....222	27434-10.....222
25144-13.....208	25285-24.....211	25668-18.....215	27403-04.....222	27434-11.....222
25146-13.....208	25285-26.....211	25668-21.....215	27403-05.....222	27434-12.....222
25148-13.....208	25290-18.....211	25670-14.....215	27403-06.....222	27434-13.....222
25150-12.....208	25292-18.....211	25671-14.....215	27403-07.....222	27434-14.....222
25150-14.....208	25293-27.....211	25672-14.....215	27403-08.....222	27434-15.....222
25154-12.....208	25311-20.....211	25673-14.....215	27403-09.....222	27434-16.....222
25154-14.....208	25311-27.....211	25676-14.....215	27403-10.....222	27441-01.....223
25160-15.....209	25315-20.....211	25677-14.....215	27403-11.....222	27441-02.....223
25160-18.....209	25315-27.....211	25678-09.....215	27403-12.....222	27441-03.....223
25160-20.....209	25324-18.....211	25678-14.....216	27403-13.....222	27441-04.....223
25160-23.....209	25324-26.....211	25679-09.....215	27403-14.....222	27441-05.....223
25164-15.....209	25330-21.....212	25679-14.....216	27403-15.....222	27441-06.....223
25164-18.....209	25330-23.....212	25680-13.....215	27403-16.....222	27441-07.....223
25164-20.....209	25334-23.....212	25684-13.....215	27413-01.....222	27441-08.....223
25164-23.....209	25405-12.....212	25700-18.....217	27413-02.....222	27441-09.....223
25170-15.....209	25406-12.....212	25701-18.....217	27413-03.....222	27441-10.....223
25174-15.....209	25407-12.....212	25720-14.....217	27413-04.....222	27441-11.....223

27441-12.....223	29150-12.....227	31350-28.....232	33259-23.....240	33416-17.....248
27443-01.....223	29152-14.....227	31360-30.....232	33260-24.....240	33417-18.....248
27443-02.....223	31101-24.....229	31362-28.....232	33261-22.....240	33418-17.....248
27443-03.....223	31103-23.....229	31366-23.....232	33274-14.....241	33419-20.....248
27443-04.....223	31103-26.....229	31370-20.....233	33274-17.....241	33420-20.....249
27443-05.....223	31103-37.....229	31380-18.....233	33274-19.....241	33421-20.....249
27443-10.....223	31120-19.....229	31390-18.....233	33274-22.....241	33423-23.....249
27443-20.....223	31130-14.....229	31395-18.....233	33275-14.....241	33424-10.....249
27443-30.....223	31200-39.....230/4	31397-24.....233	33275-17.....241	33441-13.....249
27450-01.....223	31200-58.....230/4	33100-01.....234	33275-19.....241	33441-18.....249
27450-02.....223	31200-95.....230/18	33100-02.....234	33275-22.....241	33441-20.....249
27450-03.....223	31200-98.....230/4	33101-12.....234	33280-15.....241	33442-19.....249
27450-04.....223	31200-99.....230/4	33101-14.....234	33281-15.....241	33443-18.....249
27450-05.....223	31201-01.....230	33102-01.....234	33282-19.....241	33444-15.....250
27450-06.....223	31201-02.....230	33102-02.....234	33283-17.....241	33450-01.....250
27452-01.....223	31201-11.....230/2	33103-14.....235	33284-15.....241	33450-02.....250
27452-02.....223	31201-22.....230/2	33105-17.....235	33286-18.....241	33467-97.....251
27452-03.....223	31201-39.....230/4	33107-16.....235	33289-18.....241	33467-98.....251
27452-04.....223	31201-45.....230/7	33109-16.....235	33290-23.....242	33468-00.....251
27452-05.....223	31201-58.....230/4	33115-15.....236	33290-27.....242	33468-01.....251
27452-06.....223	31201-70.....230/7	33117-15.....236	33291-23.....242	33468-02.....251
27465-10.....223	31202-00.....230/7	33119-15.....236	33291-27.....242	33468-03.....251
27465-20.....223	31202-14.....230/18	33131-15.....236	33292-26.....242	33468-04.....251
27467-01.....223	31202-16.....230/18	33133-15.....236	33293-27.....242	33469-96.....251
27467-02.....223	31203-00.....230/5	33136-17.....236	33295-24.....242	33469-97.....251
27467-03.....223	31203-10.....230/5	33137-17.....236	33300-21.....243	33469-98.....251
27467-04.....223	31203-20.....230/5	33142-20.....236	33362-21.....243	33470-00.....251
27467-05.....223	31203-30.....230/5	33143-20.....236	33365-19.....243	33470-01.....251
27475-10.....223	31203-50.....230/17	33147-20.....237	33366-19.....243	33470-02.....251
27475-20.....223	31204-00.....230/5	33148-18.....237	33366-23.....243	33470-03.....251
27477-01.....223	31204-01.....230/15	33150-16.....237	33366-26.....243	33470-04.....251
27477-02.....223	31204-02.....230/15	33151-16.....237	33368-26.....243	33470-05.....251
27477-03.....223	31204-03.....230/15	33152-17.....237	33370-22.....244	33470-06.....251
27477-04.....223	31204-04.....230/15	33153-17.....237	33370-27.....244	33471-96.....251
27477-05.....223	31204-10.....230/5	33154-18.....237	33370-30.....244	33471-97.....251
27485-10.....223	31204-20.....230/5	33155-18.....237	33372-22.....244	33471-98.....251
27485-20.....223	31204-30.....230/5	33156-18.....237	33372-26.....244	33472-00.....251
27487-01.....223	31205-00.....230/6	33157-02.....237	33372-33.....244	33472-01.....251
27487-02.....223	31205-08.....230/16	33157-03.....237	33378-15.....244	33472-02.....251
27487-03.....223	31205-09.....230/16	33157-04.....238	33378-17.....244	33472-03.....251
27487-04.....223	31205-20.....230/16	33157-05.....238	33378-21.....244	33472-04.....251
27487-05.....223	31205-21.....230/16	33157-06.....238	33380-15.....244	33472-05.....251
27610-12.....224	31210-10.....230/6	33158-03.....238	33380-17.....244	33472-06.....251
27612-12.....224	31210-21.....230/10	33158-04.....238	33380-21.....244	33473-01.....252
27614-12.....224	31210-22.....230/10	33158-05.....238	33382-33.....244	33473-02.....252
27616-12.....224	31210-30.....230/18	33159-03.....238	33382-45.....244	33473-03.....252
27620-18.....224	31210-45.....230/14	33159-04.....238	33384-33.....244	33473-04.....252
27630-12.....224	31210-50.....230/14	33159-05.....238	33384-45.....244	33473-05.....252
27640-13.....224	31210-65.....230/14	33201-18.....238	33391-15.....245	33473-06.....252
27642-14.....224	31211-45.....230/14	33202-18.....238	33391-19.....245	33474-96.....251
27660-07.....224	31211-50.....230/14	33205-18.....238	33391-24.....245	33474-97.....251
27660-11.....224	31211-65.....230/14	33211-15.....238	33391-26.....245	33474-98.....251
27660-12.....224	31212-02.....230/18	33213-15.....238	33391-28.....245	33475-00.....251
27660-14.....224	31212-50.....230/14	33216-18.....239	33395-17.....245	33475-01.....251
27660-16.....224	31212-65.....230/14	33217-18.....239	33395-25.....245	33475-02.....251
27660-18.....224	31220-21.....230/12	33219-23.....239	33395-26.....245	33475-03.....251
27660-20.....224	31220-22.....230/12	33220-20.....239	33395-27.....245	33475-04.....251
27660-22.....224	31220-99.....230/18	33230-22.....239	33402-17.....246	33475-05.....251
27680-00.....226	31250-00.....231	33230-26.....239	33404-20.....246	33475-06.....251
29102-16.....227	31250-10.....231/1	33231-22.....239	33405-20.....246	33476-01.....253
29102-20.....227	31250-12.....231/1	33231-26.....239	33406-20.....246	33476-02.....253
29102-24.....227	31250-13.....231/1	33235-23.....239	33407-19.....246	33476-03.....253
29110-27.....227	31250-14.....231/1	33237-23.....239	33409-13.....246	33476-98.....253
29120-20.....227	31250-15.....231/1	33241-30.....240	33410-19.....246	33476-99.....253
29120-28.....227	31252-11.....231	33243-30.....240	33412-16.....247	33477-00.....253
29121-20.....227	31252-22.....231	33245-23.....240	33412-24.....247	33477-01.....253
29121-28.....227	31253-00.....231	33247-23.....240	33413-14.....247	33477-02.....253
29130-23.....227	31253-11.....231	33251-26.....240	33414-21.....247	33477-03.....253
29140-20.....227	31254-10.....231	33253-26.....240	33415-23.....248	33477-04.....253
29140-30.....227	31254-11.....231	33257-23.....240	33415-25.....248	33477-05.....253
29145-55.....227	31254-12.....231	33258-23.....240	33415-28.....248	33477-06.....253

33478-98.....253	33492-20.....257	33622-04.....259	33645-09.....261	33661-07.....263
33478-99.....253	33494-13.....257	33622-05.....259	33645-13.....261	33661-10.....263
33479-00.....253	33494-14.....257	33622-06.....259	33645-16.....261	33661-15.....263
33479-01.....253	33494-17.....257	33622-07.....259	33645-19.....261	33661-20.....263
33479-02.....253	33495-16.....257	33622-08.....259	33645-25.....261	33661-25.....263
33479-03.....253	33496-00.....257	33623-02.....259	33645-32.....261	33661-30.....263
33479-04.....253	33496-01.....257	33623-03.....259	33647-06.....261	33664-04.....263
33479-05.....253	33496-12.....257	33623-04.....259	33647-09.....261	33664-06.....263
33479-06.....253	33497-00.....257	33623-05.....259	33647-14.....261	33664-08.....263
33480-97.....254	33498-00.....257	33623-06.....259	33647-16.....261	33664-10.....263
33480-98.....254	33498-01.....257	33623-07.....259	33647-19.....261	33664-12.....263
33481-00.....254	33498-12.....257	33623-08.....259	33647-25.....261	33665-04.....263
33481-01.....254	33500-01.....256	33625-02.....259	33647-32.....261	33665-06.....263
33481-02.....254	33500-02.....256	33625-03.....259	33649-09.....261	33665-08.....263
33481-03.....254	33500-03.....256	33625-04.....259	33649-14.....261	33665-10.....263
33481-04.....254	33509-03.....258	33625-05.....259	33649-16.....261	33665-12.....263
33481-05.....254	33509-05.....258	33625-06.....259	33649-19.....261	33665-24.....264
33481-06.....254	33509-08.....258	33625-07.....259	33649-25.....261	33665-26.....264
33482-01.....253	33510-12.....258	33625-08.....259	33649-32.....261	33665-55.....264
33482-02.....253	33510-14.....258	33626-25.....260	33650-04.....261	33665-90.....264
33482-03.....253	33510-16.....258	33626-35.....260	33650-06.....261	33666-22.....264
33482-97.....254	33600-02.....259	33627-04.....260	33650-08.....261	33668-03.....265
33482-98.....254	33600-03.....259	33627-06.....260	33650-10.....261	33668-05.....265
33483-00.....254	33600-04.....259	33628-03.....260	33650-13.....261	33668-06.....265
33483-01.....254	33600-05.....259	33628-05.....260	33650-16.....261	33668-08.....265
33483-02.....254	33600-06.....259	33630-06.....260	33650-18.....261	33668-09.....265
33483-03.....254	33600-08.....259	33630-08.....260	33650-20.....261	33668-13.....265
33483-04.....254	33600-09.....259	33630-10.....260	33650-25.....261	33668-16.....265
33483-05.....254	33600-10.....259	33630-12.....260	33650-30.....261	33668-19.....265
33483-06.....254	33602-04.....259	33630-15.....260	33650-38.....261	33669-05.....264
33484-97.....254	33602-06.....259	33630-20.....260	33650-44.....261	33669-10.....264
33484-98.....254	33602-08.....259	33630-25.....260	33650-50.....261	33669-15.....264
33485-00.....254	33602-10.....259	33630-30.....260	33651-04.....261	33670-05.....264
33485-01.....254	33602-12.....259	33631-10.....260	33651-06.....261	33670-06.....265
33485-02.....254	33602-14.....259	33631-12.....260	33651-08.....261	33670-09.....265
33485-03.....254	33602-16.....259	33631-15.....260	33651-10.....261	33670-10.....264
33485-04.....254	33604-04.....259	33631-20.....260	33651-13.....261	33670-13.....265
33485-05.....254	33604-06.....259	33631-25.....260	33651-16.....261	33670-15.....264
33485-06.....254	33604-08.....259	33631-30.....260	33651-18.....261	33670-16.....265
33485-21.....255	33604-10.....259	33632-06.....260	33651-20.....261	33670-19.....265
33485-99.....255	33604-12.....259	33632-08.....260	33651-25.....261	33670-25.....265
33486-00.....255	33604-14.....259	33632-10.....260	33651-30.....261	33670-32.....265
33486-01.....255	33604-16.....259	33632-12.....260	33651-38.....261	33671-06.....265
33486-02.....255	33605-04.....259	33632-15.....260	33651-44.....261	33671-09.....265
33486-99.....255	33605-06.....259	33632-20.....260	33651-50.....261	33671-13.....265
33487-00.....255	33605-08.....259	33632-25.....260	33652-02.....262	33671-16.....265
33487-01.....255	33605-10.....259	33632-30.....260	33652-03.....262	33671-19.....265
33487-02.....255	33605-12.....259	33633-06.....260	33652-04.....262	33671-25.....265
33487-99.....255	33605-14.....259	33633-08.....260	33652-06.....262	33671-32.....265
33488-00.....255	33605-16.....259	33633-10.....260	33652-08.....262	33672-06.....265
33488-01.....255	33610-04.....259	33633-12.....260	33652-10.....262	33672-09.....265
33488-02.....255	33610-06.....259	33633-15.....260	33652-12.....262	33672-13.....265
33489-00.....255	33610-08.....259	33633-20.....260	33652-15.....262	33672-16.....265
33489-01.....255	33610-10.....259	33633-25.....260	33654-02.....262	33672-19.....265
33489-02.....255	33610-12.....259	33633-30.....260	33654-03.....262	33672-25.....265
33489-03.....255	33610-14.....259	33634-06.....260	33654-04.....262	33672-32.....265
33490-10.....256	33611-04.....259	33634-08.....260	33654-06.....262	33673-06.....265
33490-20.....256	33611-06.....259	33634-10.....260	33654-08.....262	33673-09.....265
33490-30.....256	33611-08.....259	33634-12.....260	33654-10.....262	33673-13.....265
33490-40.....256	33611-10.....259	33634-15.....260	33654-12.....262	33673-16.....265
33490-50.....256	33611-12.....259	33634-20.....260	33654-15.....262	33673-19.....265
33491-01.....256	33611-14.....259	33634-25.....260	33656-28.....262	33673-25.....265
33491-02.....256	33620-02.....259	33634-30.....260	33657-28.....262	33673-32.....265
33491-03.....256	33620-03.....259	33644-06.....261	33658-28.....262	33675-06.....265
33491-04.....256	33620-04.....259	33644-09.....261	33659-28.....262	33675-09.....265
33491-05.....256	33620-05.....259	33644-13.....261	33660-07.....263	33675-13.....265
33491-06.....256	33620-06.....259	33644-16.....261	33660-10.....263	33675-16.....265
33491-07.....256	33620-07.....259	33644-19.....261	33660-15.....263	33675-19.....265
33491-08.....256	33620-08.....259	33644-25.....261	33660-20.....263	33675-25.....265
33492-13.....257	33622-02.....259	33644-32.....261	33660-25.....263	33675-32.....265
33492-16.....257	33622-03.....259	33645-06.....261	33660-30.....263	33676-01.....266

33676-02.....266	33716-18.....276	33804-15.....285	34101-04.....295	34320-25.....302
33676-05.....266	33717-19-01.....277	33805-22.....285	34101-05.....295	34320-27.....302
33676-10.....266	33717-19-02.....277	33805-33.....285	34101-06.....295	34320-30.....302
33676-16.....266	33718-16.....277	33807-24.....285	34101-07.....295	34320-32.....302
33676-25.....266	33719-17.....277	33809-22.....285	34105-01.....296	34320-35.....302
33677-05.....266	33720-19.....277	33810-24.....286	34110-00.....296	34320-40.....302
33677-10.....266	33720-21.....277	33811-06.....286	34112-00.....296	34320-45.....302
33677-16.....266	33721-17.....278	33811-08.....286	34112-01.....296	34320-50.....302
33677-25.....266	33723-17.....278	33812-16.....286/1	34112-02.....296	34320-60.....302
33678-24.....267	33725-17.....278	33813-12.....286/1	34114-39.....296	34320-70.....302
33679-13.....267	33727-17.....278	33814-44.....286/2	34116-30.....296	34321-10.....302
33680-22.....267	33728-24.....278	33814-65.....286/2	34118-31.....296	34321-15.....302
33682-01.....268	33729-01.....278	33823-26.....288	34120-23.....296	34321-20.....302
33682-02.....268	33729-02.....278	33825-26.....288	34161-13.....297	34321-25.....302
33682-22.....267	33729-03.....278	33826-00.....289	34162-13.....297	34321-27.....302
33683-01.....268	33729-04.....278	33826-01.....289	34172-00.....297	34321-30.....302
33683-02.....268	33729-05.....278	33826-02.....289	34172-01.....297	34321-32.....302
33683-03.....268	33729-06.....278	33826-03.....289	34175-00.....297	34321-35.....302
33683-04.....268	33729-07.....278	33827-17.....289	34175-01.....297	34321-40.....302
33683-05.....268	33729-24.....278	33828-21.....290	34210-20.....298	34321-45.....302
33683-06.....268	33731-22.....279	33829-25.....290	34212-25.....298	34321-50.....302
33684-00.....269	33733-22.....279	33830-23.....290	34212-30.....298	34321-60.....302
33686-25.....270	33740-19.....279	33831-16.....291	34212-35.....298	34321-65.....302
33687-75.....270	33741-18.....279	33832-01.....291	34212-40.....298	34321-70.....302
33688-45.....270	33742-18.....279	33832-02.....291	34214-05.....298	34321-80.....302
33689-90.....270	33743-18.....279	33832-03.....291	34214-08.....298	34321-90.....302
33690-22.....270	33745-19.....280	33832-04.....291	34214-10.....298	34322-00.....302
33691-34.....271	33746-19.....280	33832-05.....291	34214-12.....298	34322-11.....302
33692-26.....271	33747-18.....280	33833-16.....291	34214-16.....298	34322-15.....302
33693-32.....271	33748-20.....280	33910-17.....292	34216-10.....298	34322-20.....302
33693-33.....271	33749-10.....280	33911-17.....292	34216-15.....298	34322-25.....302
33693-34.....271	33749-13.....280	33913-17.....292	34216-20.....298	34322-27.....302
33694-01.....270	33749-19.....280	33921-22.....292	34220-24.....298	34322-32.....302
33694-03.....270	33749-25.....280	33923-22.....292	34222-25.....298	34322-35.....302
33695-40.....271	33754-17.....282	34222-01.....292	34222-30.....298	34322-45.....302
33696-75.....271	33755-17.....282	33950-02.....292	34222-35.....298	34392-14.....304
33698-98.....271	33756-17.....282	33950-03.....292	34230-28.....298	34393-18.....304
33699-00.....270	33757-17.....282	33950-04.....292	34231-15.....298	34393-21.....304
33699-17.....271	33758-01.....281	33950-05.....292	34232-00.....298	34394-14.....304
33700-01.....272	33758-02.....281	33960-15.....292	34240-27.....299	34401-08.....306
33700-01-01.....272	33758-04.....280	33960-25.....292	34241-00.....299	34401-10.....306
33700-02.....272	33758-06.....280	33960-45.....292	34242-09.....299	34401-11.....306
33700-03.....272	33758-08.....280	33960-55.....292	34242-14.....299	34401-12.....306
33700-04.....272	33759-06.....282	33961-15.....292	34242-16.....299	34401-13.....306
33700-05.....273	33759-12.....282	33962-16.....292	34242-22.....299	34401-14.....306
33700-06.....273	33759-19.....282	33963-12.....293	34243-02.....299	34401-15.....306
33700-07.....273	33759-25.....282	33964-15.....293	34244-10.....299	34401-16.....306
33700-08.....273	33760-01.....282	33964-19.....293	34244-14.....299	34401-17.....306
33702-15.....274	33760-02.....282	33964-24.....293	34244-16.....299	34401-18.....306
33703-15.....274	33760-03.....282	33965-15.....293	34244-17.....299	34401-20.....306
33704-01.....274	33761-21.....282	33965-19.....293	34246-00.....299	34401-22.....306
33704-02.....274	33763-01.....282	33965-24.....293	34248-00.....299	34401-23.....306
33705-05.....274	33763-02.....282	33966-11.....293	34250-00.....299	34401-24.....306
33705-10.....274	33763-03.....282	33966-15.....293	34252-00.....299	34401-25.....306
33705-15.....274	33763-04.....282	33967-15.....293	34270-00.....299	34401-28.....306
33705-20.....274	33765-17.....283	33967-20.....294	34270-01.....299	34401-30.....306
33705-25.....274	33767-19.....283	33968-30.....294	34280-00.....300	34402-08.....306
33706-18.....274	33769-30.....283	33968-60.....294	34290-00.....300	34402-10.....306
33707-17.....275	33771-71.....283	33969-18.....294	34295-00.....300	34402-11.....306
33708-19.....275	33771-73.....283	33969-23.....294	34296-00.....300	34402-12.....306
33709-21.....275	33801-08.....284	33970-01.....294	34296-05.....300	34402-13.....306
33710-19.....275	33801-12.....284	33970-02.....294	34296-10.....300	34402-14.....306
33711-16.....276	33801-18.....284	33970-03.....294	34296-15.....300	34402-15.....306
33711-18.....275	33801-43.....284	33971-24.....294	34296-20.....300	34402-16.....306
33711-20.....275	33801-70.....284	33972-22.....294	34296-25.....301	34402-17.....306
33711-21.....275	33802-01.....284	33973-27.....294	34296-30.....301	34402-18.....306
33712-16.....276	33802-02.....284	33975-30.....294	34296-35.....301	34402-19.....306
33713-16.....276	33802-14.....284	33977-28.....294	34296-40.....301	34402-20.....306
33713-17.....276	33803-05.....284	34101-01.....295	34320-10.....302	34402-22.....306
33714-15.....276	33803-07.....284	34101-02.....295	34320-15.....302	34402-23.....306
33715-20.....276	33803-43.....285	34101-03.....295	34320-20.....302	34402-24.....306

34435-10.....308	34445-18.....309	34519-02.....313	34570-02.....321	41056-28.....328
34435-12.....308	34445-20.....309	34520-02.....314	34573-35.....321	41058-18.....328
34435-14.....308	34445-25.....309	34520-03.....314	34583-60.....321	41058-28.....328
34435-16.....308	34445-28.....309	34520-04.....314	34584-60.....321	41061-16.....329
34435-18.....308	34445-30.....309	34520-05.....314	34585-60.....321	41064-16.....329
34435-20.....308	34446-16.....309	34520-06.....314	34588-01.....321	41068-20.....329
34435-22.....308	34446-18.....309	34520-07.....314	34588-02.....321	41069-20.....329
34435-23.....308	34446-20.....309	34520-08.....314	34588-03.....321	41070-29.....329
34435-24.....308	34446-25.....309	34520-09.....314	34590-00.....322	41074-23.....329/1
34435-26.....308	34446-28.....309	34520-10.....314	34590-01.....322	41075-24.....329/1
34435-28.....308	34446-30.....309	34520-12.....314	34590-02.....322	41076-03.....329/1
34435-30.....308	34447-16.....309	34520-15.....314	34596-29.....322	41076-04.....329/1
34436-16.....308	34447-18.....309	34528-01.....315	34596-37.....322	41076-05.....329/1
34436-18.....308	34447-20.....309	34528-02.....315	34596-42.....322	41076-07.....329/1
34436-20.....308	34447-25.....309	34528-03.....315	34596-49.....322	41078-23.....329/2
34436-25.....308	34447-28.....309	34530-28.....315	34597-06.....322	41079-21.....329/2
34436-28.....308	34447-30.....309	34531-21.....315	34597-07.....322	41080-19.....330
34436-30.....308	34450-08.....310	34533-17.....316	34597-08.....322	41081-19.....330
34437-16.....308	34450-10.....310	34534-15.....316	34597-09.....322	41083-19.....330
34437-18.....308	34450-12.....310	34534-18.....316	34597-10.....322	41085-20.....330
34437-20.....308	34450-14.....310	34535-16.....316	34597-11.....322	41090-33.....330
34437-25.....308	34450-15.....310	34536-14.....316	34597-12.....322	41091-31.....330
34437-28.....308	34450-16.....310	34537-19.....316	34597-13.....322	41091-41.....330
34437-30.....308	34450-18.....310	34538-01.....316	34597-14.....322	41092-30.....332
34438-16.....308	34450-20.....310	34538-02.....316	34597-15.....322	41092-40.....332
34438-18.....308	34450-22.....310	34538-03.....316	34597-16.....322	41092-50.....332
34438-20.....308	34450-25.....310	34539-01.....316	34597-17.....322	41092-60.....332
34438-25.....308	34450-30.....310	34539-02.....316	34597-18.....322	41092-70.....332
34438-28.....308	34460-08.....310	34539-03.....316	34597-19.....322	41094-00.....332
34438-30.....308	34460-10.....310	34540-01.....317	34597-20.....322	41096-21.....332
34439-00.....305	34460-12.....310	34540-02.....317	34612-00.....322/1	41097-22.....331
34439-16.....308	34460-14.....310	34540-16.....317	34613-00.....322/1	41141-25.....332
34439-18.....308	34460-15.....310	34540-18.....317	34615-00.....322/1	41143-21.....332
34439-20.....308	34460-16.....310	34540-19.....317	34617-00.....322/1	41145-21.....332
34439-25.....308	34460-20.....310	34540-20.....317	34620-25.....323	41146-18.....332
34439-28.....308	34460-22.....310	34541-23.....317/1	34624-01.....323	41146-24.....332
34439-30.....308	34460-25.....310	34542-15.....317/1	34624-02.....323	41147-21.....332
34440-01.....305	34460-30.....310	34543-23.....317/1	34624-03.....323	41149-22.....332
34440-02.....305	34470-08.....310	34544-18.....317/1	34624-04.....323	41151-24.....332
34440-03.....305	34470-10.....310	34545-22.....318	34628-01.....323	41155-20.....333
34440-16.....308	34470-12.....310	34546-16.....318	34628-02.....323	41156-18.....333
34440-18.....308	34470-14.....310	34546-18.....318	34628-15.....323	41158-01.....333
34440-20.....308	34470-15.....310	34547-01.....320/1	34628-25.....323	41158-02.....333
34440-25.....308	34470-16.....310	34547-02.....320/2	34628-35.....323	41158-03.....333
34440-28.....308	34470-20.....310	34547-03.....320/1	34629-01.....323	41161-01.....333
34440-30.....308	34470-22.....310	34547-23.....320/1	34632-25.....324	41161-02.....333
34441-16.....308	34470-25.....310	34547-28.....320/2	34634-35.....324	41161-03.....333
34441-18.....308	34470-30.....310	34548-18.....318	34637-23.....325	41161-04.....333
34441-20.....308	34480-01.....311	34549-14.....318	34639-22.....325	41161-05.....333
34441-25.....308	34480-02.....311	34550-13.....318	34640-18.....325	41210-23.....334
34441-28.....308	34480-03.....311	34550-18.....318	35548-18.....320/3	41211-23.....334
34441-30.....308	34492-01.....311	34551-17.....318	41011-15.....326	41213-23.....334
34442-16.....309	34492-02.....311	34552-16.....319	41011-19.....326	41221-00.....334
34442-18.....309	34492-03.....311	34554-15.....319	41015-23.....326	41222-00.....334
34442-20.....309	34502-15.....312	34554-18.....319	41015-26.....326	41223-00.....334
34442-25.....309	34502-21.....312	34554-20.....319	41017-23.....326	41224-00.....334
34442-28.....309	34514-18.....312	34555-15.....319	41017-26.....326	41230-19.....335
34442-30.....309	34514-27.....312	34555-18.....319	41019-14.....326	41231-19.....335
34443-16.....309	34515-01.....313	34555-20.....319	41020-00.....326	41232-19.....335
34443-18.....309	34515-02.....313	34556-18.....319	41021-00.....326	41233-19.....335
34443-20.....309	34515-09.....312	34557-22.....320	41025-01.....327	41234-19.....335
34443-25.....309	34515-10.....312	34557-25.....320	41025-02.....327	41236-19.....335
34443-28.....309	34515-11.....312	34557-30.....320	41026-35.....327	41237-19.....335
34443-30.....309	34515-12.....312	34558-32.....320	41026-50.....327	41238-19.....335
34444-16.....309	34515-13.....312	34559-47.....320	41027-00.....327	41239-19.....335
34444-18.....309	34515-15.....312	34560-57.....320	41028-00.....327	41242-19.....336
34444-20.....309	34515-20.....312	34562-24.....321	41051-20.....328	41243-19.....336
34444-25.....309	34518-01.....312	34562-32.....321	41052-20.....328	41244-19.....336
34444-28.....309	34518-02.....312	34562-48.....321	41053-20.....328	41245-19.....336
34444-30.....309	34518-03.....312	34562-64.....321	41054-20.....328	41250-11.....336
34445-16.....309	34519-01.....313	34570-01.....321	41056-18.....328	41250-15.....336

41250-18.....336	41307-04.....338	41512-04.....344	41604-62.....349	41614-58T.....352
41253-07.....336	41307-05.....338	41512-05.....344	41604-62T.....349	41614-65.....352
41253-11.....336	41307-06.....338	41513-01.....344	41604-79.....349	41614-65T.....352
41253-15.....336	41401-16.....339	41513-02.....344	41604-79T.....349	41614-72.....352
41253-18.....336	41405-17.....339	41513-03.....344	41604-87.....349	41614-72T.....352
41254-06.....337	41405-27.....339	41513-04.....344	41604-87T.....349	41615-49.....352
41254-10.....337	41406-01.....339	41513-05.....344	41605-10.....350	41615-49T.....352
41254-13.....337	41406-02.....339	41514-01.....344	41605-10T.....350	41615-50.....352
41254-16.....337	41420-01.....340	41514-02.....344	41605-12.....350	41615-50T.....352
41254-19.....337	41420-02.....340	41514-03.....344	41605-12T.....350	41615-51.....352
41254-25.....337	41420-03.....340	41514-04.....344	41605-13.....350	41615-51T.....352
41254-32.....337	41421-01.....340	41514-05.....344	41605-13T.....350	41616-79.....353
41254-38.....337	41421-02.....340	41515-01.....344	41606-62.....350	41616-79T.....353
41290-21.....337	41421-03.....340	41515-02.....344	41606-62T.....350	41616-91.....353
41294-40.....337	41422-01.....340	41515-03.....344	41606-65.....350	41616-91T.....353
41295-06.....337	41422-02.....340	41515-04.....344	41606-65T.....350	41617-10.....353
41295-07.....337	41422-03.....340	41515-05.....344	41606-78.....350	41617-10T.....353
41295-08.....337	41430-01.....340	41520-03.....344/1	41606-78T.....350	41617-65.....353
41295-09.....337	41430-02.....340	41520-05.....344/1	41606-84.....350	41617-65T.....353
41295-10.....337	41430-03.....340	41522-03.....344/1	41606-84T.....350	41617-72.....353
41295-11.....337	41431-01.....340	41522-05.....344/1	41607-56.....350	41617-72T.....353
41295-12.....337	41431-02.....340	41524-03.....344/1	41607-56T.....350	41617-78.....353
41295-15.....337	41431-03.....340	41524-05.....344/1	41607-57.....350	41617-78T.....353
41297-06.....337	41432-01.....340	41526-03.....344/1	41607-57T.....350	41618-55.....353
41297-07.....337	41432-02.....340	41526-05.....344/1	41607-58.....350	41618-55T.....353
41297-08.....337	41432-03.....340	41527-03.....344/1	41607-58T.....350	41618-56.....353
41297-09.....337	41440-01.....340	41527-05.....344/1	41607-59.....350	41618-56T.....353
41297-10.....337	41440-02.....340	41529-03.....344/1	41607-59T.....350	41618-57.....353
41297-11.....337	41440-03.....340	41529-05.....344/1	41607-60.....350	41618-57T.....353
41297-12.....337	41441-01.....340	41540-02.....344/2	41607-60T.....350	41618-79.....353
41298-12.....337	41441-02.....340	41540-03.....344/2	41607-72.....350	41618-79T.....353
41299-03.....336	41441-03.....340	41540-04.....344/2	41607-72T.....350	41618-88.....353
41299-05.....336	41442-01.....340	41540-05.....344/2	41607-73.....350	41618-88T.....353
41299-07.....336	41442-02.....340	41542-02.....344/2	41607-73T.....350	41619-00.....353
41300-02.....337/1	41442-03.....340	41542-03.....344/2	41607-82.....350	41619-00T.....353
41300-03.....337/1	41443-26.....341	41542-04.....344/2	41607-82T.....350	41620-58.....354
41300-04.....337/1	41444-01.....341	41542-05.....344/2	41608-57.....350	41620-58T.....354
41300-05.....337/1	41444-02.....341	41600-62.....349	41608-57T.....350	41620-59.....354
41301-15.....337/1	41444-03.....341	41600-62T.....349	41608-80.....350	41620-59T.....354
41301-20.....337/1	41445-25.....341/1	41600-70.....349	41608-80T.....350	41620-60.....354
41301-25.....337/1	41446-00.....341/1	41600-70T.....349	41609-70.....350	41620-60T.....354
41301-35.....337/1	41447-27.....341/2	41600-78.....349	41609-70T.....350	41620-61.....354
41302-02.....337/1	41448-02.....342	41600-78T.....349	41610-61.....351	41620-61T.....354
41303-09.....337/2	41448-03.....342	41600-92.....349	41610-61T.....351	41620-62.....354
41303-12.....337/2	41448-04.....342	41600-92T.....349	41610-68.....351	41620-62T.....354
41303-15.....337/2	41449-01.....342	41601-10.....349	41610-68T.....351	41620-63.....354
41303-18.....337/2	41449-02.....342	41601-10T.....349	41610-70.....351	41620-63T.....354
41303-25.....337/2	41449-03.....342	41601-11.....349	41610-70T.....351	41620-70.....354
41303-30.....337/2	41451-01.....343	41601-11T.....349	41611-74.....351	41620-70T.....354
41303-45.....337/2	41451-02.....343	41601-13.....349	41611-74T.....351	41620-78.....354
41304-06.....338	41451-03.....343	41601-13T.....349	41611-87.....351	41620-78T.....354
41304-08.....338	41452-01.....343	41602-60.....349	41611-87T.....351	41620-88.....354
41304-10.....338	41452-02.....343	41602-60T.....349	41611-92.....351	41620-88T.....354
41305-05.....338	41452-03.....343	41602-68.....349	41611-92T.....351	41621-58.....354
41305-06.....338	41453-01.....343	41602-68T.....349	41612-07.....351	41621-58T.....354
41305-07.....338	41453-02.....343	41602-75.....349	41612-07T.....351	41621-62.....354
41305-08.....338	41453-03.....343	41602-75T.....349	41612-09.....351	41621-62T.....354
41305-09.....338	41458-20.....343	41602-87.....349	41612-09T.....351	41622-58.....354
41305-10.....338	41510-01.....344	41602-87T.....349	41612-11.....351	41622-58T.....354
41305-12.....338	41510-02.....344	41603-55.....349	41612-11T.....351	41622-62.....354
41305-15.....338	41510-03.....344	41603-55T.....349	41612-12.....351	41622-62T.....354
41305-18.....338	41510-04.....344	41603-61.....349	41612-12T.....351	41623-56.....354
41305-20.....338	41510-05.....344	41603-61T.....349	41612-62.....351	41623-56T.....354
41305-25.....338	41511-01.....344	41603-65.....349	41612-62T.....351	41624-56.....354
41305-30.....338	41511-02.....344	41603-65T.....349	41613-74.....352	41624-56T.....354
41306-05.....337/1	41511-03.....344	41603-74.....349	41613-74T.....352	41625-56.....354
41306-07.....337/1	41511-04.....344	41603-74T.....349	41613-84.....352	41625-56T.....354
41306-09.....337/1	41511-05.....344	41604-54.....349	41613-84T.....352	41626-56.....354
41306-12.....337/1	41512-01.....344	41604-54T.....349	41613-96.....352	41626-56T.....354
41307-00.....338	41512-02.....344	41604-58.....349	41613-96T.....352	41627-33.....355
41307-03.....338	41512-03.....344	41604-58T.....349	41614-58.....352	41627-33T.....355

41627-40.....355	41648-07.....358	41830-30.....368/1	43251-12.....373	43441-02.....378
41627-40T.....355	41648-09.....358	41832-32.....368/1	43253-12.....373	43443-13.....378
41628-33.....355	41648-11.....358	41842-42.....368/4	43256-12.....373	43445-13.....378
41628-33T.....355	41649-07.....359	41842-44.....368/4	43258-12.....373	43447-13.....378
41628-40.....355	41649-09.....359	41842-46.....368/4	43262-12.....373	43449-01.....378
41628-40T.....355	41649-11.....359	41843-50.....368/4	43271-11.....373	43449-02.....378
41628-46.....355	41650-07.....359	41850-41.....368/4	43273-13.....373	43461-13.....378
41628-46T.....355	41650-09.....359	41860-14.....369	43304-12.....374	43462-13.....378
41629-32.....355	41650-11.....359	41860-17.....369	43305-12.....374	43482-20.....378
41629-32T.....355	41651-07.....359	41860-20.....369	43308-12.....374	43485-13.....378
41629-38.....355	41651-09.....359	41870-08.....369	43309-12.....374	43487-14.....378
41629-38T.....355	41651-11.....359	41870-11.....369	43310-13.....374	43501-06.....379
41630-36.....355	41652-07.....359	41870-14.....369	43311-13.....374	43501-10.....379
41630-36T.....355	41652-09.....359	41870-17.....369	43314-13.....374	43501-12.....379
41630-38.....355	41652-11.....359	41880-01.....369	43321-12.....374	43511-13.....379
41630-38T.....355	41653-18.....360	41880-02.....369	43325-13.....374	43513-14.....379
41631-36.....355	41654-18.....360	41880-03.....369	43327-12.....374	43515-14.....379
41631-36T.....355	41655-18.....360	43101-03.....370	43330-13.....374	43517-09.....379
41631-40.....355	41656-18.....360	43101-04.....370	43331-11.....374	43521-12.....379
41631-40T.....355	41657-17.....360	43104-07.....370	43332-12.....374	43523-12.....379
41631-44.....355	41657-21.....360	43105-06.....370	43334-12.....374	43524-10.....379
41631-44T.....355	41657-23.....360	43106-05.....370	43336-12.....374	43525-05.....379
41632-36.....355	41658-17.....360	43107-08.....370	43340-13.....374	43525-07.....379
41632-36T.....355	41658-21.....360	43109-07.....370	43342-12.....374	43525-10.....379
41633-35.....355	41658-23.....360	43109-09.....370	43351-01.....375	43526-12.....379
41633-35T.....355	41659-17.....360	43110-08.....370	43351-02.....375	43542-12.....380
41633-40.....355	41659-21.....360	43111-07.....370	43351-03.....375	43544-12.....380
41633-40T.....355	41659-23.....360	43113-07.....370	43353-13.....375	43546-13.....380
41634-35.....355	41660-17.....360	43115-05.....370	43355-13.....375	43548-13.....380
41634-35T.....355	41660-21.....360	43121-07.....370	43357-13.....375	43583-07.....380
41634-60.....355	41660-23.....360	43123-07.....370	43363-01.....375	43589-13.....380
41634-60T.....355	41661-40.....361	43125-05.....370	43363-02.....375	43593-09.....380
41634-70.....355	41661-50.....361	43125-07.....370	43370-12.....375	43602-01.....381
41634-70T.....355	41662-50.....361	43127-08.....370	43372-13.....375	43602-02.....381
41635-57.....355	41663-01.....361	43128-08.....370	43373-13.....375	43602-03.....381
41635-57T.....355	41663-02.....361	43129-07.....371	43376-13.....375	43605-12.....381
41636-45.....355	41664-10.....362	43130-07.....371	43377-13.....375	43605-34.....381
41636-45T.....355	41664-14.....362	43132-08.....371	43380-13.....375	43605-56.....381
41637-33.....356	41665-10.....362	43133-08.....371	43381-13.....375	43608-12.....381
41637-33T.....356	41665-14.....362	43135-07.....371	43383-13.....375	43609-14.....381
41637-40.....356	41666-00.....362	43139-07.....371	43386-13.....375	43610-01.....381
41637-40T.....356	41667-30.....363	43140-08.....371	43387-02.....376	43610-02.....381
41638-38.....356	41667-50.....363	43141-08.....371	43388-02.....376	43613-00.....381
41638-38T.....356	41668-50.....363	43150-11.....371	43389-02.....376	43614-00.....381
41638-46.....356	41669-50.....363	43170-00.....371	43390-05.....376	43614-01.....381
41638-46T.....356	41670-50.....363	43170-01.....371	43391-13.....376	43614-12.....381
41639-44.....356	41672-01.....364	43170-02.....371	43402-05.....377	43614-23.....381
41639-44T.....356	41672-02.....364	43170-03.....371	43402-10.....377	43614-34.....381
41640-40.....356	41672-03.....364	43172-13.....371	43402-15.....377	43614-45.....381
41640-40T.....356	41672-04.....364	43180-01.....372	43402-18.....377	43614-56.....381
41641-07.....357	41674-50.....365	43180-02.....372	43402-20.....377	43614-67.....381
41641-09.....357	41674-80.....365	43180-03.....372	43402-25.....377	43614-78.....381
41641-11.....357	41675-50.....365	43181-01.....372	43402-35.....377	43802-07.....382
41642-07.....357	41675-80.....365	43181-02.....372	43402-40.....377	43803-07.....382
41642-09.....357	41676-50.....365	43181-03.....372	43402-45.....377	43804-07.....382
41642-11.....357	41676-80.....365	43183-13.....372	43404-10.....377	43805-07.....382
41643-07.....357	41677-50.....365	43185-13.....372	43404-20.....377	43810-10.....382
41643-09.....357	41677-80.....365	43187-13.....372	43404-24.....377	43811-10.....382
41643-11.....357	41678-50.....365	43202-01.....372	43404-30.....377	43813-10.....382
41644-07.....357	41678-80.....365	43202-02.....372	43404-35.....377	43820-10.....382
41644-09.....357	41679-25.....366	43202-03.....372	43407-13.....377	43821-10.....382
41644-11.....357	41680-00.....366	43210-01.....372	43410-01.....377	43823-10.....382
41645-07.....358	41801-01.....368	43210-02.....372	43410-02.....377	43830-10.....383
41645-09.....358	41802-00.....368/3	43210-03.....372	43412-01.....377	43831-10.....383
41645-11.....358	41802-02.....368	43213-12.....372	43412-02.....377	43833-10.....383
41646-07.....358	41803-01.....368/2	43218-12.....373	43414-02.....378	43840-10.....383
41646-09.....358	41807-00.....368/2	43221-11.....373	43420-01.....378	43841-10.....383
41646-11.....358	41810-10.....368/2	43228-12.....373	43420-02.....378	43843-10.....383
41647-07.....358	41821-21.....368/1	43231-12.....373	43420-03.....378	43850-08.....383
41647-09.....358	41822-22.....368/1	43233-13.....373	43424-13.....378	43851-08.....383
41647-11.....358	41826-26.....368/1	43245-12.....373	43441-01.....378	43852-08.....383

43853-08.....383	44166-07.....392	45015-65.....399	45098-20.....407	45194-04.....410
43855-07.....384	44181-10.....392	45018-00.....399	45098-50.....407	45201-11.....410
43857-07.....384	44190-08.....392	45018-50.....399	45099-01.....407	45201-13.....410
43861-07.....384	44202-08.....392	45018-60.....399	45099-02.....407	45203-11.....410
43863-07.....384	44210-10.....392	45018-70.....399	45099-05.....407	45206-14.....410
43865-07.....384	44220-10.....392	45018-80.....399	45099-10.....407	45206-16.....410
43869-07.....384	44240-09.....393	45020-01.....400	45099-20.....407	45207-16.....410
43881-07.....384	44242-09.....393	45020-02.....400	45099-50.....407	45208-14.....410
43883-07.....384	44246-09.....393	45020-03.....400	45109-00.....407	45220-16.....411
43885-07.....384	44254-09.....393	45020-04.....400	45110-00.....407	45222-17.....411
43887-07.....384	44256-09.....393	45030-04.....401	45110-01.....407	45225-02.....411
43891-09.....385	44258-09.....393	45030-06.....401	45110-02.....407	45243-14.....411
43902-09.....385	44265-10.....393	45030-07.....401	45110-03.....407	45245-12.....411
43903-09.....385	44267-10.....393	45030-08.....401	45110-04.....407	45246-12.....411
43907-10.....385	44274-11.....393	45030-10.....401	45110-05.....407	45246-14.....411
43909-10.....385	44300-00.....394	45036-03.....402	45111-00.....407	45251-10.....412
43914-10.....385	44301-00.....394	45036-06.....402	45112-00.....407	45253-11.....412
43916-10.....385	44310-00.....394	45036-07.....402	45112-01.....407	45255-08.....412
43920-11.....385	44311-00.....394	45036-08.....402	45112-02.....407	45257-08.....412
43924-11.....386	44320-00.....394	45036-09.....401	45112-03.....407	45261-08.....412
43926-11.....386	44330-00.....394	45036-10.....401	45112-04.....407	45261-14.....412
43940-05.....386	44340-00.....394	45060-01.....403	45112-05.....407	45261-16.....412
43940-08.....386	44350-00.....394	45060-02.....403	45114-00.....407	45263-08.....412
43942-05.....386	44370-00.....394/1	45060-03.....403	45115-00.....407	45263-14.....412
43942-08.....386	44371-00.....394/1	45060-04.....403	45115-01.....407	45265-08.....412
43944-07.....387	44372-00.....394/1	45060-05.....403	45115-02.....407	45267-20.....412
43946-07.....387	44373-00.....394/1	45061-00.....403	45115-03.....407	45267-25.....412
43948-10.....387	44374-00.....394/1	45070-01.....403	45115-04.....407	45267-30.....412
43950-10.....387	44380-00.....394/2	45070-02.....403	45115-05.....407	45269-30.....412
43952-10.....387	44390-00.....394/2	45070-03.....403	45116-00.....407	45271-08.....412
43953-10.....387	44404-00.....394/2	45070-04.....403	45117-00.....407	45273-08.....412
43955-10.....387	44404-00G.....394/2	45070-05.....403	45117-01.....407	45275-08.....412
43956-10.....387	44406-00.....394/2	45070-06.....403	45117-02.....407	45310-40.....413
44015-20.....389	44406-00G.....394/2	45071-00.....403	45117-03.....407	45312-55.....413
44015-27.....389	44408-00.....395	45072-01.....404	45117-04.....407	45313-55.....413
44017-08.....389	44420-09.....395	45073-01.....404	45117-05.....407	45315-55.....413
44046-11.....389	44422-09.....395	45073-02.....404	45133-01.....408	45317-55.....413
44050-11.....389	44424-08.....395	45073-03.....404	45133-02.....408	45320-70.....413
44052-11.....389	44425-10.....395	45073-04.....404	45133-03.....408	45321-70.....413
44054-09.....389	44426-09.....395	45073-05.....404	45133-04.....408	45322-70.....413
44066-09.....390	44428-09.....395	45073-06.....404	45133-05.....408	45350-40.....413
44067-09.....390	45009-00.....399	45074-01.....404	45150-18.....408	45350-70.....413
44068-09.....390	45009-02.....399	45075-00.....404	45151-16.....408	45352-40.....413
44069-09.....390	45009-03.....399	45076-01.....404	45152-01.....408	45353-60.....413
44074-10.....390	45009-04.....399	45080-00.....405	45152-02.....408	45355-60.....413
44076-05.....390	45010-00.....399	45090-00.....405	45153-16.....408	45357-40.....413
44076-10.....390	45010-20.....399	45090-02.....405	45160-15.....408	45359-40.....413
44078-05.....390	45010-30.....399	45090-03.....405	45162-18.....408	45360-35.....413
44078-10.....390	45010-45.....399	45090-04.....405	45164-17.....408	45362-45.....414
44101-07.....390	45010-55.....399	45090-05.....405	45165-17.....408	45363-45.....414
44103-09.....391	45010-65.....399	45090-06.....405	45171-12.....409	45365-45.....414
44106-10.....391	45010-75.....399	45090-08.....405	45180-01.....409	45367-50.....414
44109-10.....391	45011-00.....399	45091-00.....406	45180-02.....409	45369-50.....414
44111-10.....391	45011-03.....399	45091-01.....406	45180-03.....409	45370-50.....414
44114-10.....391	45011-04.....399	45091-02.....406	45181-13.....409	45371-40.....414
44115-10.....391	45011-05.....399	45091-03.....406	45184-16.....409	45373-30.....414
44117-10.....391	45011-07.....399	45091-04.....406	45185-15.....409	45375-60.....414
44119-10.....391	45011-08.....399	45091-15.....406	45190-01.....409	45377-60.....414
44121-10.....391	45012-00.....399	45091-17.....406	45190-02.....409	45381-30.....414
44125-06.....391	45012-40.....399	45091-22.....406	45192-01.....409	45383-30.....414
44127-06.....391	45012-55.....399	45096-50.....406	45192-02.....409	45385-01.....414
44129-07.....391	45012-65.....399	45096-75.....406	45192-03.....409	45385-02.....414
44150-01.....392	45012-75.....399	45097-01.....406	45192-04.....409	45387-01.....414
44150-03.....392	45014-00.....399	45097-02.....406	45192-05.....409	45387-02.....414
44150-05.....392	45014-45.....399	45097-03.....406	45192-06.....409	45390-35.....415
44150-10.....392	45014-55.....399	45097-10.....406	45193-01.....409	45390-50.....415
44150-15.....392	45014-65.....399	45097-15.....406	45193-02.....409	45391-35.....415
44151-05.....392	45014-75.....399	45098-01.....407	45193-03.....409	45392-35.....415
44151-10.....392	45015-00.....399	45098-02.....407	45194-01.....410	45393-50.....415
44151-15.....392	45015-45.....399	45098-05.....407	45194-02.....410	45394-50.....415
44164-10.....392	45015-55.....399	45098-10.....407	45194-03.....410	45400-01.....416

45400-02.....416	45751-16.....420	47197-01.....426	47350-26.....433/2	47470-07.....441
45400-03.....416	45753-16.....420	47197-02.....426	47351-26.....433/2	47471-02.....441
45401-25.....416	45755-16.....420	47223-01.....426	47352-24.....433/2	47471-03.....441
45402-10.....416	45757-16.....420	47223-02.....426	47355-03.....433/2	47471-04.....441
45403-13.....416	45760-01.....420	47223-03.....426	47370-16.....434	47471-05.....441
45404-13.....416	45760-02.....420	47223-04.....426	47371-16.....434	47471-06.....441
45410-01.....417	45762-01.....420	47223-05.....426	47372-16.....434	47471-07.....441
45411-01.....417	45762-02.....420	47224-01.....426	47373-16.....434	47471-08.....441
45412-01.....417	45766-35.....420	47224-02.....426	47374-16.....434	47471-10.....441
45413-01.....417	45766-40.....420	47224-03.....426	47375-16.....434	47471-12.....441
45414-01.....417	45766-45.....420	47224-04.....426	47375-19.....434	47472-10.....441
45701-01.....418	45766-50.....420	47224-05.....426	47376-16.....435	47472-12.....441
45701-02.....418	45802-16.....420	47235-05.....427	47379-16.....435	47472-14.....441
45703-15.....418	45803-16.....420	47235-07.....427	47380-15.....435	47472-16.....441
45704-15.....418	45805-16.....420	47235-09.....427	47382-15.....435	47473-01.....442
45705-15.....418	45807-20.....420	47235-11.....427	47384-15.....435	47473-02.....442
45706-35.....418	47050-01.....421	47237-01.....427	47385-15.....435	47473-03.....442
45709-10.....418	47050-02.....421	47237-02.....427	47386-01.....435	47474-01.....442
45709-14.....418	47050-03.....421	47237-03.....427	47386-02.....435	47474-02.....442
45709-16.....418	47050-04.....421	47239-01.....427	47387-01.....435	47474-03.....442
45709-20.....418	47050-05.....421	47239-02.....427	47387-02.....435	47481-05.....442/1
45709-26.....418	47050-06.....421	47240-19.....427	47390-03.....436	47482-05.....442/1
45709-28.....418	47050-07.....421	47242-00.....427	47390-04.....436	47484-04.....442/1
45709-30.....418	47060-01.....421	47242-01.....427	47390-05.....436	47484-06.....442/1
45710-15.....419	47060-02.....421	47251-21.....428	47392-03.....436	47484-08.....442/1
45711-15.....419	47060-03.....421	47255-01.....428	47392-04.....436	47486-16.....442/1
45713-15.....419	47102-01.....421	47255-02.....428	47392-05.....436	47487-16.....442/1
45715-17.....419	47102-02.....421	47256-20.....428	47410-04.....437	47489-16.....442/1
45720-03.....419	47102-03.....421	47303-03.....428	47410-05.....437	47502-16.....443
45720-06.....419	47103-01.....422	47303-04.....428	47410-16.....437	47504-18.....443
45720-10.....419	47103-02.....422	47303-05.....428	47411-16.....437	47507-17.....443
45722-03.....419	47103-03.....422	47303-06.....428	47413-19.....437	47507-19.....443
45722-06.....419	47112-01.....421	47304-01.....429	47414-21.....437	47511-21.....443
45722-10.....419	47112-02.....421	47304-02.....429	47415-18.....437	47513-21.....443
45722-12.....419	47112-03.....421	47304-03.....429	47417-19.....437	47514-16.....443
45722-15.....419	47113-03.....421	47304-04.....429	47419-19.....437	47516-16.....443
45722-20.....419	47116-13.....423	47305-01.....429	47420-01.....438	47518-21.....444
45722-25.....419	47118-13.....423	47305-02.....429	47420-02.....438	47520-21.....444
45724-03.....419	47120-35.....423	47305-03.....429	47420-03.....438	47521-01.....444
45724-06.....419	47120-50.....423	47311-10.....430	47420-04.....438	47521-02.....444
45724-10.....419	47120-75.....423	47311-25.....430	47420-20.....438	47521-03.....444
45724-12.....419	47120-90.....423	47311-30.....430	47421-21.....438	47522-01.....445
45724-15.....419	47124-35.....423	47315-00.....430	47421-23.....439	47522-04.....445
45724-20.....419	47124-50.....423	47316-00.....430	47422-22.....439	47522-05.....445
45724-25.....419	47124-75.....423	47316-16.....431	47423-22.....439	47522-07.....445
45725-05.....419	47124-90.....423	47317-00.....430	47424-16.....439	47522-09.....445
45725-10.....419	47139-12.....423	47317-11.....431	47425-19.....439	47523-01.....446
45730-03.....419	47139-14.....423	47317-65.....431	47426-22.....439	47523-02.....446
45730-06.....419	47139-16.....423	47317-70.....431	47428-21.....439	47526-16.....446
45730-10.....419	47139-18.....423	47317-90.....431	47430-22.....439	47527-01.....446
45732-03.....419	47151-15.....424	47318-11.....431	47450-04.....439	47529-16.....446
45732-06.....419	47151-18.....424	47318-65.....431	47451-04.....439	47532-19.....446
45732-10.....419	47154-20.....424	47318-70.....431	47454-04.....440	47533-19.....446
45733-05.....419	47155-20.....424	47318-90.....431	47454-07.....440	47534-19.....446
45733-10.....419	47158-20.....424	47319-35.....432	47454-09.....440	47535-01.....446
45735-05.....419	47159-20.....424	47319-45.....432	47454-12.....440	47535-02.....446
45735-10.....419	47161-16.....424	47323-19.....430	47455-06.....440	47540-16.....447
45736-15.....419	47161-20.....424	47325-19.....430	47458-04.....440	47541-14.....447
45737-15.....419	47167-18.....425	47331-20.....433	47458-07.....440	47542-12.....447
45741-03.....419	47169-18.....425	47331-25.....433	47458-09.....440	47551-16.....447
45741-06.....419	47171-14.....425	47331-30.....433	47458-12.....440	47551-16L.....447
45741-10.....419	47173-14.....425	47331-40.....433	47460-04.....440	47552-16.....447
45743-03.....419	47181-18.....425	47332-20.....433	47460-07.....440	47553-15.....447/1
45743-06.....419	47185-18.....425	47332-25.....433	47460-12.....440	47554-01.....447/1
45743-10.....419	47191-01.....425	47332-30.....433	47461-00.....440	47554-02.....447/1
45745-03.....419	47191-02.....425	47332-40.....433	47463-10.....440	47554-03.....447/1
45745-06.....419	47191-03.....425	47342-25.....433	47463-12.....440	47555-08.....447/1
45745-10.....419	47191-04.....425	47342-30.....433	47463-14.....440	47556-16.....447/1
45747-03.....419	47192-16.....426	47342-40.....433	47470-04.....441	47557-17.....447/1
45747-06.....419	47195-01.....426	47345-15.....433/1	47470-05.....441	47558-15.....448
45747-10.....419	47195-02.....426	47347-20.....433/1	47470-06.....441	47559-20.....448

47560-18.....448	49274-13.....454	49640-07.....462	51187-19.....467	53230-03.....473
47562-18.....448	49274-15.....454	49640-09.....462	51191-19.....467	53230-04.....473
47563-22.....448	49287-02.....455	49650-06.....462	51193-19.....467	53230-05.....473
47564-16.....448	49287-03.....455	49650-07.....462	51202-19.....467	53230-06.....473
47565-10.....448	49287-04.....455	49650-09.....462	51203-19.....467	53230-07.....473
47566-12.....448	49287-05.....455	49650-11.....462	51205-18.....467	53230-08.....473
47571-23.....449	49288-02.....455	49660-18.....463	51205-23.....467	53240-01.....473
47572-23.....449	49288-03.....455	49665-24.....463	51207-21.....467	53240-02.....473
47573-23.....449	49288-04.....455	49670-19.....463	51209-20.....467	53240-03.....473
47575-23.....449	49288-05.....455	49670-20.....463	51210-20.....468	53240-04.....473
47601-21.....449	49310-00.....455	49670-23.....463	51211-21.....468	53240-05.....473
47607-01.....449	49310-01.....455	49671-01.....463/1	51213-21.....468	53240-06.....473
47607-02.....449	49310-02.....455	49671-01CL.....463/1	51219-22.....468	53240-07.....473
47607-03.....449	49310-03.....455	49671-02.....463/1	51250-28.....468	53240-08.....473
47607-04.....449	49310-04.....455	49671-02CL.....463/1	51252-28.....468	53250-01.....473
47607-05.....449	49310-05.....455	49673-01.....463/2	51256-28.....468	53250-02.....473
47607-06.....449	49310-10.....455	49673-02.....463/2	51257-40.....468	53250-03.....473
47620-00.....450	49310-12.....455	49673-03.....463/2	51257-50.....468	53250-04.....473
47620-01.....450	49315-00.....456	49673-04.....463/2	51259-03.....468	53250-05.....473
47620-02.....450	49315-01.....456	49675-18.....463/3	51259-04.....468	53250-06.....473
47620-03.....450	49315-02.....456	49680-10.....463/3	51259-05.....468	53250-07.....473
47620-04.....450	49315-03.....456	49680-20.....463/3	51260-00.....469	53250-08.....473
47620-05.....450	49315-10.....456	49685-21.....463/3	51270-00.....470	53260-01.....473
47620-06.....450	49317-00.....456	49691-15.....463/3	51270-01.....470	53260-02.....473
47630-00.....450	49317-01.....456	49692-15.....463/3	51270-02.....470	53260-03.....473
47630-01.....450	49317-02.....456	49694-25.....463/4	51270-03.....470	53260-04.....473
47630-02.....450	49317-03.....456	49694-25CL.....463/4	51270-04.....470	53260-05.....473
47630-03.....450	49317-10.....456	49695-01.....463/5	51290-02.....470	53260-06.....473
47630-04.....450	49320-00.....457	49695-02.....463/5	51290-05.....470	53260-07.....473
47636-01.....450	49320-01.....457	49696-18.....463/6	51290-10.....470	53260-08.....473
47636-02.....450	49320-02.....457	49700-01.....464	51290-20.....470	53270-08.....473
47636-03.....450	49320-03.....457	49700-02.....464	51291-00.....470	53270-10.....473
47636-04.....450	49320-10.....457	49705-08.....464/1	51292-00.....470	53270-12.....473
47641-01.....450	49320-20.....457	49705-12.....464/1	51293-00.....470	53270-14.....473
47641-02.....450	49340-00.....457	49705-16.....464/1	51293-45.....470	53270-16.....473
47641-03.....450	49342-01.....458	49705-20.....464/1	51293-90.....470	53270-18.....473
47642-01.....450	49342-02.....458	49710-04.....464/2	53101-22.....471	53270-20.....473
47642-02.....450	49342-03.....458	49710-06.....464/2	53102-20.....471	53270-22.....473
47642-03.....450	49342-04.....458	49710-08.....464/2	53103-22.....471	53270-24.....473
49102-16.....451	49342-05.....458	49711-04.....464/2	53111-18.....471	53270-26.....473
49103-17.....451	49345-01.....458	49711-06.....464/2	53115-01.....471	53270-28.....473
49104-15.....451	49345-02.....458	49713-06.....464/2	53115-02.....471	53270-30.....473
49105-16.....451	49345-03.....458	49713-08.....464/2	53115-03.....471	53272-08.....473
49106-01.....451	49345-04.....458	51103-18.....465	53115-04.....471	53272-10.....473
49106-02.....451	49345-05.....458	51103-20.....465	53121-24.....471	53272-12.....473
49107-19.....451	49360-10.....459	51103-22.....465	53130-00.....472	53272-14.....473
49108-15.....451	49400-01.....459	51109-24.....465	53131-20.....472	53272-16.....473
49109-19.....451	49501-22.....459	51111-23.....465	53132-20.....472	53272-18.....473
49110-19.....452	49501-23.....459	51131-22.....465	53132-30.....472	53272-20.....473
49111-15.....452	49501-24.....459	51133-23.....465	53132-40.....472	53272-22.....473
49115-01.....452	49503-22.....459	51134-21.....465	53132-50.....472	53272-24.....473
49115-02.....452	49503-23.....459	51135-01.....465	53132-60.....472	53272-26.....473
49117-11.....452	49503-24.....459	51135-02.....465	53150-00.....472	53272-28.....473
49119-14.....453	49605-07.....460	51139-25.....465	53152-00.....472	53272-30.....473
49230-11.....453	49605-10.....460	51143-24.....465	53154-00.....472	53274-12.....473
49231-12.....453	49605-11.....460	51151-19.....465	53155-00.....472	53276-10.....473
49231-14.....453	49605-12.....460	51165-22.....466	53157-00.....472	53280-01.....474
49231-16.....453	49605-14.....460	51167-22.....466	53158-02.....472	53280-02.....474
49235-19.....453	49605-16.....460	51168-23.....466	53158-03.....472	53280-03.....474
49250-16.....453	49610-12.....460	51169-23.....466	53160-02.....472	53280-04.....474
49250-18.....453	49610-13.....460	51170-24.....466	53160-03.....472	53280-05.....474
49255-16.....453	49610-16.....460	51171-22.....466	53162-00.....472	53280-06.....474
49255-99.....453	49613-10.....461	51172-19.....466	53164-01.....472	53280-07.....474
49265-12.....454	49615-12.....461	51173-21.....466	53164-02.....472	53280-08.....474
49265-14.....454	49620-15.....461/1	51174-21.....466	53166-00.....472	53280-09.....474
49267-12.....454	49623-16.....461/1	51177-23.....466	53170-00.....472	53280-10.....474
49270-16.....454	49627-01.....461/1	51178-21.....466	53175-00.....472	53280-11.....474
49270-19.....454	49630-02.....461/1	51179-17.....466	53177-01.....472	53290-01.....475
49272-13.....454	49631-00.....461/2	51181-19.....467	53177-02.....472	53290-02.....475
49274-09.....454	49635-18.....462	51183-19.....467	53230-01.....473	53290-03.....475
49274-11.....454	49640-05.....462	51185-19.....467	53230-02.....473	53290-04.....475

53290-05.....475	57244-13.....483	61021-24.....499	61063-16.....512	61372-08.....523
53290-06.....475	57245-13.....484	61022-01.....499	61138-14.....513	61372-09.....523
53290-07.....475	57246-16.....484	61022-02.....499	61138-16.....513	61373-01.....523
53290-08.....475	57246-21.....484	61022-24.....499/1	61138-18.....513	61373-02.....523
55111-13.....476	57247-95.....485	61022-28.....499/2	61138-20.....513	61373-03.....523
55111-14.....476	57248-14.....485	61023-25.....500	61139-14.....513	61373-04.....523
55113-14.....476	57249-01.....485	61023-26.....500	61139-16.....513	61373-05.....523
55115-07.....476	57251-15.....486	61024-01.....501	61139-18.....513	61373-06.....523
55116-15.....476	57252-19.....486	61024-02.....501	61139-20.....513	61373-07.....523
55117-17.....476	57260-02.....487	61024-24.....501/1	61140-17.....514	61373-08.....523
55118-16.....477	57260-03.....487	61024-27.....501/2	61141-16.....514	61373-09.....523
55119-16.....477	57260-04.....487	61025-20.....502	61143-15.....514	61374-01.....523
55120-15.....477	57260-06.....487	61025-24.....502	61145-15.....514	61374-02.....523
55122-16.....477	57260-09.....487	61025-25.....502	61147-17.....514	61374-03.....523
55124-16.....477	57264-16.....487	61025-26.....502	61149-17.....515	61374-04.....523
55151-05.....477	57265-00.....487/1	61025-27.....502	61151-17.....515	61374-05.....523
55151-07.....477	57266-13.....488	61026-01.....503	61153-16.....515	61374-06.....523
55151-09.....477	57270-00.....489	61026-02.....503	61153-17.....515	61374-07.....523
55220-04.....479	57270-65.....489	61026-03.....503	61156-16.....515	61374-08.....523
55220-05.....479	57270-75.....489	61026-04.....503	61156-17.....515	61374-09.....523
55220-06.....479	57270-80.....489	61027-23.....504	61156-18.....515	61460-15.....524
55220-07.....479	57280-19.....489/1	61027-25.....504	61157-17.....516	61460-19.....524
55220-08.....479	57283-14.....489/1	61029-25.....504	61158-10.....516	61461-15.....524
55220-09.....479	57284-16.....489/1	61030-21.....505	61158-11.....516	61461-19.....524
55220-10.....479	57286-16.....489/1	61030-22.....505	61158-12.....517	61461-28.....525
55220-11.....479	57288-30.....489	61031-17.....505	61159-12.....517	61462-19.....524
55220-12.....479	57289-32.....489	61032-18.....506	61159-13.....517	61462-28.....525
55220-13.....479	57290-20.....490	61032-20.....506	61161-14.....517	61463-19.....524
55240-04.....479	57291-20.....490	61032-23.....506	61161-18.....517	61463-28.....525
55240-05.....479	57301-30.....490	61032-25.....506	61161-19.....517	61464-15.....524
55240-06.....479	57307-24.....490	61033-23.....506	61172-15.....518	61464-19.....524
55240-07.....479	57309-22.....490	61033-24.....506	61173-16.....518	61464-28.....525
55240-08.....479	57311-22.....490	61033-25.....506	61174-17.....518	61465-15.....524
55240-09.....479	57313-22.....490	61034-21.....507	61175-17.....518	61465-19.....524
55240-10.....479	57321-23.....491	61034-23.....507	61176-17.....518	61465-28.....525
55240-11.....479	57323-23.....491	61034-27.....507	61177-17.....518	61466-15.....524
55240-12.....479	57325-15.....491	61034-31.....507	61178-16.....519	61466-19.....524
55240-13.....479	57327-26.....491	61035-21.....507	61178-17.....519	61466-28.....525
55501-15.....479	57329-26.....491	61035-23.....507	61179-18.....519	61467-15.....524
55503-15.....479	61000-21.....492	61035-27.....507	61180-17.....519	61467-19.....524
55511-21.....479	61000-22.....492	61035-31.....507	61187-16.....519	61467-28.....525
55520-15.....479	61001-21.....492	61036-18.....508	61187-17.....519	61468-19.....524
55520-20.....479	61001-22.....492	61036-19.....508	61188-20.....520	61468-28.....525
55523-17.....479	61003-21.....492	61036-23.....508	61189-21.....520	61469-19.....524
57102-23.....480	61003-22.....492	61036-27.....508	61190-17.....520	61469-28.....525
57105-22.....480	61005-22.....493	61037-20.....508	61191-16.....520	61470-15.....524
57107-22.....480	61007-22.....493	61037-21.....508	61192-17.....520	61470-19.....524
57111-21.....480	61008-19.....493	61037-25.....508	61193-01.....520/1	61471-15.....524
57123-35.....480	61008-23.....493	61037-29.....508	61193-02.....520/1	61471-19.....524
57125-35.....480	61009-16.....494	61038-12.....509	61193-03.....520/1	61471-28.....525
57126-34.....481	61010-18.....494	61039-00.....509/1	61193-04.....520/1	61472-19.....524
57131-26.....481	61011-19.....494	61039-12.....509	61193-05.....520/1	61472-28.....525
57137-27.....481	61011-20.....494	61039-15.....509/1	61194-26.....520/2	61473-19.....524
57138-21.....481	61012-17.....495	61039-30.....509/1	61195-28.....520/2	61473-28.....525
57141-36.....481	61012-18.....495	61039-45.....509/1	61195-32.....520/3	61481-15.....524
57146-28.....481	61012-19.....495	61039-90.....509/1	61196-26.....520/4	61481-19.....524
57147-28.....481	61013-18.....495	61040-21.....510	61259-15.....521	61482-15.....524
57210-16.....482	61013-19.....495	61041-00.....509/1	61261-16.....521	61482-19.....524
57210-20.....482	61013-20.....495	61041-15.....509/1	61263-16.....521	61482-28.....525
57210-25.....482	61014-15.....495/1	61041-30.....509/1	61266-01.....522	61483-19.....524
57214-75.....482	61014-18.....495/1	61041-45.....509/1	61266-02.....522	61483-28.....525
57230-13.....482	61015-15.....495/2	61041-90.....509/1	61266-03.....522	61484-19.....524
57230-17.....482	61015-18.....495/2	61045-18.....511	61266-04.....522	61484-28.....525
57230-18.....482	61016-20.....495/2	61046-19.....511	61266-05.....522	61488-16.....526
57234-75.....482	61017-26.....496	61050-01.....510	61372-01.....523	61489-16.....526
57236-20.....483	61017-27.....496	61050-02.....510	61372-02.....523	61490-15.....526
57236-25.....483	61017-31.....496	61050-03.....510	61372-03.....523	61491-15.....526
57236-30.....483	61017-33.....496	61050-04.....510	61372-04.....523	61492-16.....526
57242-20.....483	61018-28.....497	61050-05.....510	61372-05.....523	61493-01.....527
57242-25.....483	61019-30.....498	61050-07.....510	61372-06.....523	61493-02.....527
57242-30.....483	61020-27.....498	61062-16.....512	61372-07.....523	61493-03.....527

61495-01.....527	63170-23.....533	65211-23.....540	67122-23.....551	67206-21.....554
61495-02.....527	63173-01.....533	65216-13.....540	67123-23.....551	67206-22.....554
61495-03.....527	63173-02.....533	65216-16.....540	67125-24.....551	67206-23.....554
61495-04.....527	63173-03.....533	65216-18.....540	67130-00.....552	67206-24.....554
61700-01.....528	63173-04.....533	65216-21.....540	67130-01.....552	67206-25.....554
61700-33.....528	63173-05.....533	65216-23.....540	67130-02.....552	67206-26.....554
61710-01.....528	63173-06.....533	65217-13.....540	67130-03.....552	67206-27.....554
61710-33.....528	63173-07.....533	65217-16.....540	67132-00.....552	67206-28.....554
61715-04.....528	63173-08.....533	65217-18.....540	67147-27.....552	67206-29.....554
61715-05.....528	63174-00.....268	65217-21.....540	67149-27.....552	67206-30.....554
61715-06.....528	63175-27.....534	65217-23.....540	67150-00.....552	67207-08.....554
61810-05.....529	63178-01.....534	65220-13.....540	67155-00.....552	67207-09.....554
61810-10.....529	63178-03.....534	65220-22.....540	67160-00.....552	67207-10.....554
61810-15.....529	63180-17.....534	65220-25.....540	67163-00.....553	67207-11.....554
61810-20.....529	63180-21.....534	65220-28.....540	67165-00.....553	67207-12.....554
61810-25.....529	63180-24.....534	65221-13.....540	67169-00.....553	67207-13.....554
61810-30.....529	63180-27.....534	65221-22.....540	67169-01.....553	67207-14.....554
61810-35.....529	63210-32.....534	65221-25.....540	67172-20.....553/1	67207-15.....554
61810-40.....529	63231-01.....535	65221-28.....540	67172-28.....553/1	67207-16.....554
61810-45.....529	63231-02.....535	65226-22.....540	67175-08.....553/1	67207-17.....554
61810-50.....529	63231-03.....535	65226-25.....540	67177-11.....553/1	67207-18.....554
61810-70.....529	63231-04.....535	65226-28.....540	67178-12.....553/2	67207-19.....554
61810-90.....529	63231-05.....535	65227-22.....540	67178-14.....553/2	67207-20.....554
61820-05.....529	63231-06.....535	65227-25.....540	67179-14.....553/2	67207-21.....554
61820-10.....529	63232-01.....536	65227-28.....540	67184-39.....554	67207-22.....554
61820-15.....529	63232-02.....536	65230-21.....541	67185-35.....554	67207-23.....554
61820-20.....529	65102-12.....537	65230-23.....541	67201-08.....554	67207-24.....554
61820-25.....529	65102-14.....537	65230-25.....541	67201-10.....554	67207-25.....554
61820-30.....529	65108-15.....537	65231-21.....541	67201-12.....554	67207-26.....554
61820-35.....529	65110-15.....537	65231-23.....541	67201-14.....554	67207-27.....554
61820-40.....529	65120-15.....537	65231-25.....541	67201-16.....554	67207-28.....554
61820-45.....529	65120-19.....537	65236-25.....541	67201-18.....554	67207-29.....554
61820-50.....529	65120-22.....537	65237-25.....541	67201-20.....554	67207-30.....554
61820-70.....529	65120-24.....537	65238-33.....541	67201-22.....554	67211-06.....555
61820-90.....529	65124-16.....537	65239-33.....541	67201-24.....554	67211-08.....555
61910-01.....530	65124-20.....537	65241-23.....542	67201-26.....554	67211-10.....555
61910-02.....530	65124-22.....537	65242-30.....542	67201-28.....554	67211-12.....555
61910-03.....530	65124-25.....537	65255-19.....543	67201-30.....554	67211-14.....555
61910-04.....530	65124-30.....537	65256-19.....543	67201-32.....554	67211-16.....555
61920-14.....530/1	65130-15.....537	65259-24.....543	67201-34.....554	67211-18.....555
61920-23.....530/1	65132-16.....538	65260-24.....543	67201-36.....554	67211-20.....555
61930-18.....530/1	65132-20.....538	65261-15.....544	67205-08.....554	67211-22.....555
61930-21.....530/1	65140-15.....538	65262-12.....544	67205-10.....554	67211-24.....555
63101-23.....530/2	65140-19.....538	65263-15.....544	67205-12.....554	67213-06.....555
63103-23.....530/2	65145-15.....538	65263-20.....544	67205-14.....554	67213-08.....555
63106-20.....530/2	65150-20.....538	65265-26.....545	67205-16.....554	67213-10.....555
63107-20.....530/2	65154-18.....538	65265-28.....545	67205-18.....554	67213-12.....555
63110-20.....530/2	65155-18.....538	65270-15.....545	67205-20.....554	67213-14.....555
63111-20.....530/2	65155-20.....538	65272-07.....545	67205-22.....554	67213-16.....555
63117-22.....530/2	65160-14.....539	65272-10.....545	67205-24.....554	67213-18.....555
63125-28.....531	65160-16.....539	65274-00.....545	67205-26.....554	67213-20.....555
63130-13.....531	65160-18.....539	65280-05.....546	67205-28.....554	67213-22.....555
63130-18.....531	65160-20.....539	65280-07.....546	67205-30.....554	67213-24.....555
63130-21.....531	65160-24.....539	65280-10.....546	67205-32.....554	67219-08.....555
63142-34.....531	65164-16.....539	65282-26.....546	67205-34.....554	67219-10.....555
63150-00.....532	65164-20.....539	65284-08.....546	67205-36.....554	67219-12.....555
63150-01.....532	65168-16.....539	65284-23.....546	67205-38.....554	67219-14.....555
63150-02.....532	65168-20.....539	65290-30.....547	67205-40.....554	67219-16.....555
63150-03.....532	65170-18.....539	65291-30.....547	67206-08.....554	67219-18.....555
63150-04.....532	65170-20.....539	65310-15.....548	67206-09.....554	67219-20.....555
63150-05.....532	65172-20.....539	65310-21.....548	67206-10.....554	67219-22.....555
63150-06.....532	65172-23.....539	65310-29.....548	67206-11.....554	67219-24.....555
63150-07.....532	65174-20.....539	65310-35.....548	67206-12.....554	67220-00.....555
63150-08.....532	65178-19.....539	65320-00.....549	67206-13.....554	67220-12.....555
63150-09.....532	65178-23.....539	67101-21.....550	67206-14.....554	67220-14.....555
63150-10.....532	65180-16.....539	67103-22.....550	67206-15.....554	67220-16.....555
63150-11.....532	65210-18.....540	67105-21.....550	67206-16.....554	67220-18.....555
63150-12.....532	65210-21.....540	67105-22.....550	67206-17.....554	67220-20.....555
63150-13.....532	65210-23.....540	67106-20.....550	67206-18.....554	67220-22.....555
63170-21.....533	65211-18.....540	67110-23.....550	67206-19.....554	67220-24.....555
63170-22.....533	65211-21.....540	67111-23.....550	67206-20.....554	67220-26.....555

67220-28.....555	69302-42.....566	71241-02.....572	71362-24.....577	71424-08.....579
67220-30.....555	69303-28.....566	71241-03.....572	71363-24.....577	71424-13.....579
67220-32.....555	69303-35.....566	71241-10.....572	71364-24.....577	71425-08.....579
67220-34.....555	69303-42.....566	71242-00.....572	71365-24.....577	71426-08.....579
67220-36.....555	69304-28.....566	71242-01.....572	71404-14.....578	71426-13.....579
67220-38.....555	69304-35.....566	71242-02.....572	71404-26.....578	71430-10.....580
67240-08.....556	69304-42.....566	71242-03.....572	71405-14.....578	71430-12.....580
67240-11.....556	69311-23.....567	71242-10.....572	71406-14.....578	71430-14.....580
67240-13.....556	69311-33.....567	71260-01.....573	71406-26.....578	71430-16.....580
67240-16.....556	69311-40.....567	71260-02.....573	71410-01.....578	71430-18.....580
67240-21.....556	69321-23.....567	71261-01.....573	71410-02.....578	71430-20.....580
67240-26.....556	69321-33.....567	71261-02.....573	71410-03.....578	71436-06.....580
67240-32.....556	69321-40.....567	71262-01.....573	71410-04.....578	71438-00.....580
67250-07.....556	69402-21.....567	71262-02.....573	71410-05.....578	71438-13.....580
67251-07.....556	69402-25.....567	71271-01.....573	71410-06.....578	71438-17.....580
69105-22.....559	69450-18.....568	71271-02.....573	71410-07.....578	71438-21.....580
69110-15.....559	69455-00.....568	71271-03.....573	71410-08.....578	71438-25.....580
69115-15.....559	69456-00.....568	71281-01.....573	71410-09.....578	71438-29.....580
69121-00.....559	69457-12.....568	71281-02.....573	71410-10.....578	71438-33.....580
69125-17.....559	69457-31.....568	71281-03.....573	71410-11.....578	71438-37.....580
69126-01.....560	69458-00.....568	71291-00.....573	71410-12.....578	71438-41.....580
69126-02.....560	69458-10.....568	71291-01.....573	71410-13.....578	71441-34.....581
69126-03.....560	69458-11.....568	71291-02.....573	71410-14.....578	71443-29.....581
69127-01.....560	69458-16.....568	71291-03.....573	71410-15.....578	71445-29.....581
69127-02.....560	69460-00.....568	71300-01.....574	71410-16.....578	71500-18.....582
69127-03.....560	71100-00.....569	71301-01.....574	71410-17.....578	71502-25.....582
69130-19.....560	71110-01.....570	71301-02.....574	71410-18.....578	71503-25.....582
69142-06.....560	71110-02.....570	71301-03.....574	71410-19.....578	71504-25.....582
69142-08.....560	71110-03.....570	71303-01.....574	71410-20.....578	71505-24.....582
69142-12.....560	71115-02.....569	71303-02.....574	71410-21.....578	71507-28.....582
69147-00.....561	71115-03.....569	71303-03.....574	71410-22.....578	71508-17.....582
69147-01.....561	71116-02.....570	71303-04.....574	71410-23.....578	71510-18.....582
69147-02.....561	71120-00.....570	71303-05.....574	71410-24.....578	71512-20.....583
69147-03.....561	71120-01.....570	71305-01.....574	71410-25.....578	71512-28.....583
69147-04.....561	71120-02.....570	71305-02.....574	71410-26.....578	71514-24.....583
69148-00.....561	71120-03.....570	71305-03.....574	71410-27.....578	71515-24.....583
69150-15.....561	71130-01.....570	71305-04.....574	71410-28.....578	71524-06.....583
69210-22.....562	71130-02.....570	71305-05.....574	71410-29.....578	71524-08.....583
69212-16.....562	71130-03.....570	71306-00.....575	71410-30.....578	71524-10.....583
69212-19.....562	71132-00.....570	71306-01.....575	71415-01.....578	71525-06.....583
69212-22.....562	71140-01.....570	71306-02.....575	71415-02.....578	71525-08.....583
69220-05.....562	71140-02.....570	71306-03.....575	71415-03.....578	71525-10.....583
69220-10.....562	71140-03.....570	71306-04.....575	71415-04.....578	71531-23.....583
69220-14.....562	71142-04.....570	71306-05.....575	71415-05.....578	71532-21.....583
69220-20.....562	71150-01.....571	71306-06.....575	71415-06.....578	71533-21.....583
69224-21.....563	71150-02.....571	71306-07.....575	71415-07.....578	71536-21.....584
69224-27.....563	71150-03.....571	71306-08.....575	71415-08.....578	71536-28.....584
69225-22.....563	71160-01.....571	71307-00.....576	71415-09.....578	71537-27.....584
69225-30.....563	71160-02.....571	71308-00.....576	71415-10.....578	71539-26.....584
69226-25.....564	71160-03.....571	71308-01.....576	71415-11.....578	71540-27.....585
69226-29.....564	71161-17.....571	71308-02.....576	71415-12.....578	71542-20.....585
69226-38.....564	71161-25.....571	71308-03.....576	71415-13.....578	71543-32.....585
69227-01.....565	71170-01.....571	71308-04.....576	71415-14.....578	71545-27.....585
69227-02.....565	71170-02.....571	71309-00.....576	71415-15.....578	71547-23.....585
69227-03.....565	71170-03.....571	71310-20.....577	71415-16.....578	71549-25.....585
69227-04.....565	71210-01.....572	71310-25.....577	71415-17.....578	71559-26.....586
69227-05.....565	71210-02.....572	71310-30.....577	71415-18.....578	71565-28.....586
69227-06.....565	71210-03.....572	71310-35.....577	71415-19.....578	71567-26.....586
69228-01.....565	71211-01.....572	71310-40.....577	71420-01.....579	71580-32.....586
69229-01.....565	71211-02.....572	71313-20.....577	71420-03.....579	71581-32.....586
69229-02.....565	71211-03.....572	71313-25.....577	71420-05.....579	71582-32.....586
69251-01.....563	71212-01.....572	71313-30.....577	71420-07.....579	71583-32.....586
69251-02.....563	71212-02.....572	71313-35.....577	71420-09.....579	71584-28.....586
69251-03.....563	71212-03.....572	71313-40.....577	71420-11.....579	71585-25.....586
69261-41.....566	71240-00.....572	71315-40.....577	71420-13.....579	71590-04.....587
69263-30.....566	71240-01.....572	71319-28.....577	71420-15.....579	71592-01.....587
69301-28.....566	71240-02.....572	71319-38.....577	71420-17.....579	71592-02.....587
69301-35.....566	71240-03.....572	71351-10.....477/577	71420-19.....579	71592-03.....587
69301-42.....566	71240-10.....572	71351-15.....477/577	71420-21.....579	71592-04.....587
69302-28.....566	71241-00.....572	71360-24.....577	71420-23.....579	71593-00.....587
69302-35.....566	71241-01.....572	71361-24.....577	71420-25.....579	71594-40.....587

71596-40.....587	71703-02.....595	71725-16.....597	73147-36.....603/2	75379-10.....610
71598-27.....587	71703-03.....595	71725-19.....597	73148-17.....603/2	75382-16.....610
71604-01.....588	71703-04.....595	71725-20.....597	73151-29.....604	75396-01.....611
71604-02.....588	71703-05.....595	71727-05.....597	73155-44.....604	75396-02.....611
71604-21.....588	71703-06.....595	71727-06.....597	73157-40.....604	75397-00.....611
71604-28.....588	71704-27.....595	71727-07.....597	73162-40.....604	75400-01.....612
71605-26.....588	71710-05.....597	71727-08.....597	73170-00.....604	75400-02.....612
71606-24.....588	71710-06.....597	71727-09.....597	73171-21.....604	75400-03.....612
71611-25.....588	71710-07.....597	71727-11.....597	73181-33.....605	75400-04.....612
71612-21.....588	71710-08.....597	71727-12.....597	73183-27.....605	75410-01.....612
71613-28.....589	71710-09.....597	71727-14.....597	73184-21.....605	75410-02.....612
71615-01.....589	71710-11.....597	71727-15.....597	73187-09.....605	75410-03.....612
71615-02.....589	71710-12.....597	71727-16.....597	73189-09.....605	75410-04.....612
71617-04.....589	71710-14.....597	71727-19.....597	73191-34.....605	75410-15.....612/1
71618-23.....589	71712-05.....597	71727-20.....597	73193-30.....605	75420-15.....612/1
71619-23.....589	71712-06.....597	71730-30.....597	73195-35.....605	75430-01.....612/1
71621-01.....590	71712-07.....597	71730-35.....597	73242-27.....606	75430-12.....612
71621-01-25.....590	71712-08.....597	71730-40.....597	73243-27.....606	75430-13.....612
71622-00.....590	71712-09.....597	71732-30.....597	73244-01.....606	75440-00.....612
71622-00-25.....590	71712-11.....597	71732-35.....597	73244-02.....606	75440-11.....612/1
71623-00.....590	71712-12.....597	71732-40.....597	73244-03.....606	75445-12.....612/1
71623-00-25.....590	71712-14.....597	71735-30.....597	73245-01.....606	75450-00.....612
71624-01.....591	71715-05.....597	71735-35.....597	73245-02.....606	75450-13.....612/2
71624-03.....591	71715-06.....597	71735-40.....597	73245-03.....606	75460-13.....612/2
71624-04.....591	71715-07.....597	71736-00.....599	73252-30.....606	75470-11.....612/2
71624-05.....591	71715-08.....597	71736-07.....599	73254-14.....606	75475-11.....612/2
71624-06.....591	71715-09.....597	71736-08.....599	73254-18.....606	75480-13.....612/2
71624-07.....591	71715-11.....597	71736-09.....599	73254-21.....606	75485-13.....612/2
71624-08.....591	71715-12.....597	71736-10.....599	73256-42.....607	75490-15.....612/2
71624-09.....591	71715-14.....597	71736-11.....599	73259-28.....607	75500-15.....612/2
71624-10.....591	71717-05.....597	71736-12.....599	73302-42.....607	75550-13.....613
71624-11.....591	71717-06.....597	71737-06.....599	73304-46.....607	75600-10.....613
71624-13.....591	71717-07.....597	71737-08.....599	73306-25.....607	75618-15.....613
71624-14.....591	71717-08.....597	71737-10.....599	73309-30.....607	75620-15.....613
71624-15.....591	71717-09.....597	71737-12.....599	75103-15.....608	75630-12.....614
71624-16.....591	71717-11.....597	71737-14.....599	75111-10.....608	75640-15.....614
71624-17.....591	71717-12.....597	71737-30.....597	75113-14.....608	89111-25.....615
71624-18.....591	71717-14.....597	71737-35.....597	75115-14.....608	89111-32.....615
71624-19.....591	71720-05.....597	71737-40.....597	75118-14.....608	89112-65.....615
71626-00.....592	71720-06.....597	71803-03.....600	75121-10.....608	89113-65.....615
71626-00-25.....592	71720-07.....597	71803-04.....600	75128-01.....608	89114-00.....615
71627-00.....592	71720-08.....597	71803-06.....600	75128-02.....608	89115-50.....615
71628-00.....592	71720-09.....597	71803-08.....600	75128-03.....608	89115-65.....615
71628-00-25.....592	71720-11.....597	71803-10.....600	75128-04.....608	89115-75.....615
71630-00.....590	71720-12.....597	71803-12.....600	75128-05.....608	89116-50.....615
71632-00.....593	71720-14.....597	71803-14.....600	75128-06.....608	89116-65.....615
71634-00.....593	71720-15.....597	71803-15.....600	75129-01.....608	89116-75.....615
71635-26.....593	71720-16.....597	71810-12.....601	75129-02.....608	89121-40.....617
71641-17.....594	71720-19.....597	71810-16.....601	75129-03.....608	89121-50.....617
71643-27.....594	71720-20.....597	71810-20.....601	75129-04.....608	89122-16.....617
71645-01.....594	71722-05.....597	71810-50.....601	75129-05.....608	89122-21.....617
71645-02.....594	71722-06.....597	73101-23.....602	75129-06.....608	89122-26.....617
71645-03.....594	71722-07.....597	73102-30.....602	75130-01.....608	89122-30.....617
71646-01.....594	71722-08.....597	73105-33.....602	75130-02.....608	89124-23.....618
71646-02.....594	71722-09.....597	73105-36.....602	75130-03.....608	89124-26.....618
71650-00.....596	71722-11.....597	73107-30.....602	75138-00.....608	89124-27.....618
71650-01.....596	71722-12.....597	73108-36.....602	75140-02.....608	89124-30.....618
71650-02.....596	71722-14.....597	73108-39.....602	75140-03.....608	89124-32.....618
71650-03.....596	71722-15.....597	73110-41.....602	75140-04.....608	89124-42.....618
71650-04.....596	71722-16.....597	73115-32.....603	75140-05.....608	89125-23.....618
71650-05.....596	71722-19.....597	73115-38.....603	75140-06.....608	89125-26.....618
71650-06.....596	71722-20.....597	73119-36.....603	75140-07.....608	89125-30.....618
71650-07.....596	71725-05.....597	73119-40.....603	75140-08.....608	89125-32.....618
71660-00.....596	71725-06.....597	73123-39.....603	75301-10.....609	89125-42.....618
71702-01.....594	71725-07.....597	73125-40.....603	75304-10.....609	89126-23.....618
71702-02.....594	71725-08.....597	73127-40.....603	75305-10.....609	89126-26.....618
71702-03.....594	71725-09.....597	73135-36.....603	75331-14.....609	89126-27.....618
71702-04.....594	71725-11.....597	73139-40.....603/1	75341-11.....609	89126-30.....618
71702-05.....594	71725-12.....597	73141-39.....603/1	75341-13.....609	89126-32.....618
71702-06.....594	71725-14.....597	73143-39.....603/1	75373-10.....610	89126-42.....618
71703-01.....595	71725-15.....597	73145-36.....603/1	75378-10.....610	89127-04.....619

89127-06.....619	89155-13.....622	91010-03.....628	91801-21.....634
89127-08.....619	89155-15.....622	91010-11.....628	91801-25.....634
89127-11.....619	89155-19.....622	91010-12.....628	98000-01.....635
89127-12.....619	89159-14.....622	91010-13.....628	98000-02.....635
89127-14.....619	89159-16.....622	91010-14.....628	R190.03.....622
89127-16.....619	89159-19.....622	91010-15.....628	R190.05.....622
89127-18.....619	89159-24.....622	91010-16.....628	R190.07.....622
89127-23.....618	89164-14.....622	91010-17.....628	R190.10.....622
89127-26.....618	89164-16.....622	91010-18.....628	R191.03.....622
89127-30.....618	89164-19.....622	91010-21.....628	R191.05.....622
89127-32.....618	89164-24.....622	91010-31.....628	R191.07.....622
89127-42.....618	89164-29.....622	91010-33.....628	R191.10.....622
89129-11.....619	89164-34.....622	91010-34.....628	R390.03.....622
89133-16.....619	89164-39.....622	91010-35.....628	R390.05.....622
89133-17.....619	89169-14.....622	91010-36.....628	R390.07.....622
89133-22.....619	89169-16.....622	91011-51.....629	R390.10.....622
89133-24.....619	89169-19.....622	91011-52.....629	
89133-31.....619	89169-24.....622	91011-53.....629	
89133-34.....619	89169-29.....622	91011-54.....629	
89133-38.....619	89169-34.....622	91011-55.....629	
89139-17.....619	89169-39.....622	91011-56.....629	
89139-25.....619	89174-14.....622	91011-61.....629	
89139-27.....619	89174-16.....622	91011-62.....629	
89140-02.....620	89174-19.....622	91020-01.....629	
89140-05.....620	89174-24.....622	91020-02.....629	
89140-10.....620	89174-29.....622	91020-03.....629	
89140-20.....620	89174-34.....622	91020-04.....629	
89141-10.....620	89174-39.....622	91022-05.....629	
89142-01.....620	89179-14.....622	91022-10.....629	
89142-02.....620	89179-16.....622	91022-20.....629	
89142-03.....620	89179-19.....622	91024-10.....629	
89142-04.....620	89179-24.....622	91024-15.....629	
89142-05.....620	89179-29.....622	91024-20.....629	
89142-06.....620	89179-34.....622	91030-02.....629	
89142-07.....620	89179-39.....622	91030-04.....629	
89143-00.....621	89179-49.....622	91030-06.....629	
89143-01.....621	89179-59.....622	91102-11.....630	
89143-02.....621	89250-10.....623	91104-11.....630	
89143-03.....621	89250-20.....623	91109-11.....630	
89143-04.....621	89250-30.....623	91113-11.....630	
89143-05.....621	89250-40.....623	91115-11.....630	
89143-06.....621	89250-50.....623	91122-16.....630	
89143-07.....621	89250-60.....623	91123-16.....630	
89143-08.....621	89256-29.....623	91124-16.....630	
89143-09.....621	89256-46.....623	91125-16.....630	
89143-10.....621	89256-67.....623	91127-16.....630	
89145-23.....620	89257-46.....623	91142-16.....631	
89145-30.....620	89260-13.....624	91144-16.....631	
89145-31.....620	89260-17.....624	91146-16.....631	
89145-35.....620	89260-20.....624	91152-19.....631	
89146-20.....268/621	89260-25.....624	91154-19.....631	
89147-10.....621	89260-30.....624	91157-19.....631	
89147-21.....620	89260-40.....624	91159-19.....631	
89147-24.....620	89265-12.....624	91162-19.....632	
89147-25.....621	89270-15.....624	91164-19.....632	
89147-30.....620	89500-00.....626	91166-19.....632	
89147-31.....620	89500-01.....626	91167-19.....632	
89147-35.....620	89500-02.....626	91169-19.....632	
89147-40.....620	89500-03.....626	91172-03.....632	
89147-42.....620	89500-04.....626	91172-07.....632	
89148-25.....621	89500-05.....626	91172-12.....632	
89148-31.....621/1	89500-06.....626	91190-30.....633	
89148-32.....621/1	89500-07.....626	91190-50.....633	
89148-35.....621/1	89500-08.....626	91192-30.....633	
89148-50.....621	89500-09.....626	91192-50.....633	
89150-30.....621/1	89500-10.....626	91193-30.....633	
89152-08.....622	89500-11.....626	91193-50.....633	
89152-10.....622	89500-12.....626	91800-18.....634	
89152-12.....622	89501-03.....626	91800-21.....634	
89155-08.....622	91010-01.....628	91800-25.....634	
89155-10.....622	91010-02.....628	91801-18.....634	

Absfallzange, SAUERBRUCH	227	anatomische Pinzette, CUSHING-TAYLOR	87	Arterienklemme, KELLY-RANKIN	106
Abortuskürette, PESTALOZZA	606	anatomische Pinzette, DUEHRSEN	84	Arterienklemme, KOCHER	108
Abortuslöffel, CUZZI	606	anatomische Pinzette, GERALD	86, 87	Arterienklemme, LAHEY	119/2
Abortuslöffel, WALLICH	607	anatomische Pinzette, McINDOE	85	Arterienklemme, LAWRENCE	119
Abortuszange, SAENGER	606	anatomische Pinzette, OCHSNER	88	Arterienklemme, LERICHE	111
Abortuszange, WINTER	606	anatomische Pinzette, POTTS-SMITH	81	Arterienklemme, LOVELACE	109
ABRAHAM, Tonsillenfasszange	468	anatomische Pinzette, SEMKEN	86	Arterienklemme, LOWER	120
ABRAHAM, Tonsillennmesser	466	anatomische Pinzette, STILLE	81	Arterienklemme, MAYO-GUYON	122
Absauganlage f. Gipssäge	231	anatomische Pinzette, TAYLOR	87	Arterienklemme, MEEKER	119
Absaugküretten	600	anatomische Pinzette, TC	81	Arterienklemme, Micro-HARTMANN	104
Absaugrohr, BUIE	566	anatomische Pinzette, USA	81	Arterienklemme, MIXTER	116, 119/1
Absaugrohr, KLEINSASSER	36	anatomische Pinzette, WANGENSTEEN	89	Arterienklemme, MIXTER-BABY	119/1
ADAIR, Hakenzange	582	ANDERSON, Wundhaken	198	Arterienklemme, MOYNIHAN	120
ADLERKREUTZ, Gefäßspinzette	84	ANDREW, Zungendrucker	452	Arterienklemme, O'SHAUGNESSY	119/2
ADSON, anatomische Pinzette	81/2	ANDREW-PYNCHON, Saugrohr	28	Arterienklemme, OVERHOLT	114
ADSON, Arterienklemme	112	Anestrophon	23	Arterienklemme, OVERHOLT-BABY	114
ADSON, chirurgische Pinzette	81/2	Aneurysmaklemme, DeBAKEY-BAHNSON	506	Arterienklemme, OVERHOLT-GEISSENDOERFER	114
ADSON, Durahaken	329	Anlegepinzette, MEHDORN	362	Arterienklemme, OVERHOLT-MIXTER	115
ADSON, Halteklemme	298	Anlegezange	357 - 360	Arterienklemme, PEAN	108, 110
ADSON, Hohlmeißelzange	236	Anlegezange, JOHNS-HOPKINS	104	Arterienklemme, PENNINGTON	109
ADSON, Hypophysepinzette	334	Anlegezange, MCKENZIE	326	Arterienklemme, PROVIDENCE-HOSPITAL	106
ADSON, Nadelhalter	211	Anlegezange, OLIVECRONA-TOENNIS	326	Arterienklemme, ROBERTS	117
ADSON, Raspator	282	Anlegezange, RANEY	327	Arterienklemme, ROCHESTER-CARMALT	109
ADSON, Saugrohr	337	Anlegezange, SMITHWICK	326	Arterienklemme, ROCHESTER-OCHSNER	108
ADSON, Wundspreizer	172-174	Anlegezange, SWEET	326	Arterienklemme, ROCHESTER-PEAN	108
ADSON-BABY, Arterienklemme	113	ANTRUM, Kürette	435	Arterienklemme, RUMEL	117
ADSON-BABY, Wundspreizer	173	Antrumkürette, COAKLEY	449	Arterienklemme, SAROT	118
ADSON-BROWN, chirurgische Pinzette	82	Antrumraspel, GALLAHER	446	Arterienklemme, SPENCER-WELLS	109
ADSON-Micro, anatomische Pinzette	81/2	Antrumraspel, WIENER	443	Arterienklemme, STILLE	122
ADSON-Micro, chirurgische Pinzette	82	Anuskop, HIRSCHMANN	562	Arterienklemme, TOENNIS	117
AEBLI, Ophthalmologie-Schere	58	Anuskop, IVES-FANSLER	562	Arterienklemme, WIKSTROEM	117
Ahle, OBWEGESER	463, 463/3	Anuskop, KELLY	562, 563	Arterienklemme, ZENKER	118
AIR-INJECTION, Augenkantüle	394	ANVIL, Nagelspaltzange	613	ASCH, Septumrichtzange	449
ALAN-PARKS, Mastdarm-Spekula	561	Aorta-Aneurysmaklemme, DeBAKEY	496 - 498	Atrauma-Arterienklemme	492 - 527
ALDERDYCE, Elevator	282	Aortahaken, ROSS	148/1	Atrauma-Arterienklemme, DeBAKEY-MOSQUITO	509
ALEXANDER, Biopsiezange	589	Aortaklemme, DeBAKEY	499, 500	Atrauma-Arterienklemme, DeBAKEY-PEAN	513
ALEXANDER, Flachmeißel	259	Aortaklemme, DIETRICH	510	Atrauma-Arterienklemme, DeBAKEY-RANKIN	512
ALEXANDER, Hohlmeißel	259	Aortaklemme, MORRIS-DeBAKEY	506	Atrauma-Bulldogklemme, DeBAKEY	103
ALEXANDER, Raspator	276	Aortaklemme, WEBER	501	Atrauma-Bulldogklemme, GLOVER	103
ALEXANDER, Uterus-Biopsiezange	589	Aortaklemme, WYLIE	501/1	Atrauma-Darmfaßzange	539
ALLEN, Blinddarmklemme	544	Aortastanze	528	Atrauma-Neonatalklemme	523
ALLIS, Darmfasszange	537	Approximator, BIEMER	366	Atrauma-Pinzette, DeBAKEY	98
ALLIS-ADAIR, Darmfasszange	537	Approximator, BIEMER-MÜLLER	363	Atrauma-Pinzette, DeBAKEY TC	99
ALLIS-BABY, Darmfasszange	537	Approximator, MÜLLER	364	Atrauma-Gefäßklemme, BECK	516
ALLISON, Lungenspatel	489/2	ARCHER, Splitterzange	92	AUFFRANC-COBRA, Knochenheber	289
ALM, Wundhaken	168	ARL, Starschlinge	378	AUFFRANC-COBRA, Wundhaken	289
ALU, Stimmgabeln	403	Armsystem	188, 189	Aufreiber, KUNTSCHER	321
ALVIS, Fremdkörperkürette	374	ARRUGA, Extraktionshaken	375	AUFRICHT, Nasenhaken	447
Amnioskop	601	ARRUGA, Kapselpinzette	391	AUFRICHT, Nasenraspel	443
Amniotom, BEACHAM	586	ARRUGA, Lidsperrer	370	Aufsatz, BARACANI	472
Amputationsmesser, CATLIN	44	ARRUGA, Nadelhalter	214	Aufsatz, BRUENINGS	472
Amputationsmesser, LANGENBECK	44	ARRUGA, Wundlöffel	378	Aufsatz, CORDES	472
Amputationsmesser, LISTON	44	Arterienklemme, ADSON	112	Aufsatz, FRAENKEL	472
Amputationsmesser, REDA	44	Arterienklemme, ADSON-BABY	113	Aufsatz, KRAUSE	472
Amputationssäge, BIER	296	Arterienklemme, BAINBRIDGE	119/2	Aufsatz, LANGE	472
Amputationssäge, CHARRIERE	296	Arterienklemme, BENGOLEA	112	Aufsatz, Reinigungspistole	626
Amputationssäge, SATTERLEE	296	Arterienklemme, BIRKETT	116	Aufsatz, SCHEINMANN	472
Anal spreizer, SMITH-BUIE	561	Arterienklemme, CRAFOORD-SELLORS	119	Aufsatz, SCHUMACHER	472
Anastomosenklemme, BECK	516, 520	Arterienklemme, CRILE	107	Aufsatz, SEIFERT	472
Anastomosenklemme, COOLEY	520/1, 520/4	Arterienklemme, CRILE-RANKIN	107	Aufsatz, SLUDER-BALLENGER	470
Anastomosenklemme, COOLEY-DERRA	519	Arterienklemme, DANDY	109	Aufsatz, Uterus-Biopsiezangen	591
Anastomosenklemme, DeBAKEY	505	Arterienklemme, DESJARDINS	121	Augenkantüle	394
Anastomosenklemme, DeMARTEL-WOLFSON	546	Arterienklemme, FUCHSIG	113	Augenkantüle, AIR-INJECTION	394
Anastomosenklemme, DERRA	515	Arterienklemme, GEMINI	115	Augenkantüle, JENSEN	394
Anastomosenklemme, LAMBERT-KAY	505	Arterienklemme, GRAY	121	Augenkantüle, LACRIMAL	394
Anastomosenklemme, POTTS	493	Arterienklemme, GUYON	122	Augenkantüle, McINTYRE	394
anatomische Pinzette	81, 86	Arterienklemme, HALSTED-MOSQUITO	105	Augenkantüle, SHEETS	394/2
anatomische Pinzette, ADSON	81/2	Arterienklemme, HARTMANN	104	Augenmagnet, REDA	395
anatomische Pinzette, ADSON-DeBAKEY	81/2	Arterienklemme, HEISS	112	Augenpinzetten	382 - 393
anatomische Pinzette, ADSON-Micro	81/2	Arterienklemme, JACOBSON	105	Augenschere, BARRAQUER	75
anatomische Pinzette, BONNEY	88	Arterienklemme, JOHNS-HOPKINS	120	Augenschere, NOYES	75
anatomische Pinzette, BROPHY	84	Arterienklemme, KANTROWITZ	119/1	Augenschere, VANNAS	79
anatomische Pinzette, CUSHING	83	Arterienklemme, KELLY	106	Augenschere, WECKER	75

Augenschere, WESTCOTT	75	Bauchdeckenhalter, DENIS-BROWNE	185	Biopsiezange, KEVORKIAN	589, 591
Aurikelklemme, HARKEN	503	Bauchdeckenhalter, DOYEN	189/1	Biopsiezange, KEVORKIAN-PACIFIC	592
Autopsiesäge	230, 230/2	Bauchdeckenhalter, FRAZIER	181	Biopsiezange, MAXI GRASPER	593
AUVARD, Scheidenspekula	576	Bauchdeckenhalter, GELPI	189/1, 189/2	Biopsiezange, MINI-TOWNSEND-DOWN	591
AXENFELD, Chalzazionskürlette	377	Bauchdeckenhalter, GOSSET	181	Biopsiezange, MINI-TOWNSEND-UP	591
AYER, Chalzazionspinzette	393	Bauchdeckenhalter, HORGAN	183	Biopsiezange, SCHUBERT	588
B		Bauchdeckenhalter, JACKSON-BURROWS	189/2	Biopsiezange, SCHUMACHER	588, 589
BABCOCK, Darmfasszange	539	Bauchdeckenhalter, KIRSCHNER	185 - 187/1	Biopsiezange, THOMAS-GAYLOR	588
BABINSKI, Perkussionshammer	24	Bauchdeckenhalter, O'SULLIVAN-O'CONNOR	181	Biopsiezange, TISCHLER-BABY	592
BABY-BURKE, Uterus-Biopsiezange	590	Bauchdeckenhalter, RICARD	191	Biopsiezange, TISCHLER-DOWN	591
BABY-GOSSET, Bauchdeckenhalter	181	Bauchdeckenhalter, RIGBY	189/2	Biopsiezange, TISCHLER-KEVORKIAN	592
BABY-KOCHER, Darmklemme	540	Bauchdeckenhalter, ROCHARD	186	Biopsiezange, TISCHLER-MORGAN	590, 591
BABY-METZENBAUM, Supercuttschere	71	Bauch- u. Darmspatel	143/2	Biopsiezange, TISCHLER-UP	591
BABY-OLSEN-HEGAR, Nadelhalter	212	Bauch- u. Darmspatel, KADER	143/1	Biopsiezange, TOWNSEND	591
BABYPHON, Blutdruckmessgerät	10	Bauch- u. Darmspatel, KÖRTE	143/1	Biopsiezange, VAN DOREN	588
BABY-TISCHLER, Uterus-Biopsiezange	592	Bauch- u. Darmspatel, KÜMMEL	143/4, 144	Biopsiezange, WITNER	589
BABY-WEBSTER, Nadelhalter	208	Bauch- u. Darmspatel, LERICHE	143/4	Bipolare Koagulation	630 - 633
BABY-YANKAUER, Saugrohr	27	BAUMGARTNER, Nadelhalter	208	Bipolarkabel	633
BACKHAUS, Tuchklemme	132	BEACHAM, Amniotom	586	Bipolare Pinzette	630 - 632
BACKHAUS-CLIP, Tuchklemme	132	BECHERT, Linsenmanipulator	379	BIRCHER-GANSKE, Knochenhaltezange	246
BACKHAUS-BABY, Rippenkontraktor	489/1	BECK, Anastomosenklemme	516, 520	BIRKETT, Arterienklemme	116
BAILEY-GIBBON, Rippenkontraktor	489/1	Beckenzirkel, COLLIER	605	BISHOP-HARMAN, Irispinzette	386
BAILEY, Rippenkontraktor	489/1	Beckenzirkel, COLLIN	605	BISHOP-HARMON, Spül- und Saugkanüle	394/1
BAINBRIDGE, Arterienklemme	119/2	Beckenzirkel, MARTIN	605	Blätter-Wechselpinzette	179
BAINBRIDGE, Mehrzweck-Gefässklemme	495/1, 495/2	BECKER, Cystotom	375	BLAKE, Gallensteinzange	530/2
BAKES, Gallengangdilator	532	BECKMANN, Ringmesser	450	BLAKE, Uteruskürlette	595
BALFOUR-BABY, Bauchdeckenhalter	182	BECKMANN, Wundspreizer	176	Blasenhalsperrer, MILLIN	553
BALFOUR, Bauchdeckenhalter	182	BECKMANN-ADSON, Wundspreizer	175	Blasenspatel, KOCHER	552
BALFOUR, Haken	193	BECKMANN-EATON, Wundspreizer	176	Blasenspatel, LEGUEU	552
BALFOUR-US, Bauchdeckenhalter	184	BEEBEE, Kronenschere	68	Blasenwundspreizer, JUDD-MASSON	552
BALFOUR, Valve f. Bauchdeckenhalter	183	BEER, Cilienpinzette	395	Blasenwundspreizer, LEGUEU	553
BALL AND SOCKET, Tuchklemme	133	BEESON, Gipsspreizer	232	Blasenwundspreizer, MILLIN	552
BALLENGER, Schwingmesser	436	Begrenzungsscheibe	230/17	Blasenwundspreizer, THOMSON-WALKER	552
BALLENGER, Septumellevator	439	Beinhautmesser	47	Blattosteotom, OBWEGESER	464/1
BALLENGER, Tonsillenzange	467	Beleuchtungsstab f. MORGAN	565	Bleihand	250
Bandmass	25	BELLUCCI, Mikro-Ohrscherchen	413, 417	Blinddarmklemme, ALLEN	544
Bandscheibenstanze, COLCLOUGH	344/1	BENDER, Einschläger	322/1	Blinddarmklemme, KLEINSCHMIDT	544
Bandscheibenstanze, FERRIS-SMITH-KERRISON	344, 344/2	BENGOLEA, Arterienklemme	112	BLOHMKE, Tonsillenzange	467
BANE-HARTMANN, Hohlmeisselzange	237	BENNETT, Knochenhebel	283	BLOUNT, Knochenhebel	288
BANGERTER, Zykliodialysespatel	379	BENSAUDE, Proktoskop	565	BLOUNT, Meniskushaken	289
BARACANI, Aufsatz	472	BENSON, Pylorusspreizer	544	BLUMENTHAL, Hohlmeisselzange	236
BARANY, Lämtrommel	405	BERENS, Diszisionsmesser	372	Blutdruckmessgerät, BABYPHON	10
BARBARA, Hähchen	419	BERGMANN, Hammer	272	Blutdruckmessgerät, DIPLOMAT	5
BARBARA, Nadel	419	BERGMANN, Verbandschere	69/1	Blutdruckmessgerät, EXACTA	8
BARKAN, Goniotomiemesser	373	BERKE, Muskelpinzette	389	Blutdruckmessgerät, PRECISA	9
BARNHILL, Ringmeser	450	BERLINER, Perkussionshammer	24	Blutschöpfföfjel	268
BARON, Saugrohr	336	BERNHARD, Tuchklemme	133	Blutstillungsmeißel, PASSOW	260
BARR, Mastdarmspekula	559	BERRY, Drahtzange	319	BÖHLER, Hohlmeisselzange	238
BARRAQUER, Augenschere	75	Beschheidungsgerät, MOGEN	556	BÖHLER, Knochensplitterzange	241
BARRAQUER, Cilienpinzette	395	Bescheidungsinstrument	556	BODENHAMMER, Mastdarmspekula	559
BARRAQUER, Fixationspinzette	390	BETHUNE, Rippenschere	481	BOEHLER, Extensionsbügel	312
BARRAQUER, Irispinzette	384	BEYER, Hohlmeisselzange	237	BOERMA, Geburtszange	604
BARRAQUER, Keratoplastik-Messer	373	Biegeeisen, BENDER	322	BOETTCHEr, Tonsillenschere	59
BARRAQUER, Lidsperrer	370	Biegehebel, LANE	325	Bohrapparat, STILLE-SHERMAN	298
BARRAQUER, Nadelhalter	216, 217	BIEMER, Approximator	366	Bohrdraht, KIRSCHNER	306, 307
BARRAQUER-KATZIN, Irispinzette	384	BIEMER, Gefässclip	361	Bohrdrahtspender	305, 310
BARRAQUER-TROUTMAN, Nadelhalter	216	BIEMER-MÜLLER, Approximator	363	Bohrdrahtstütze	299
BARRET, Hakenzange	582	BIER, Amputationssäge	296	Bohrer	298, 302
BARTON, Geburtszange	603/2	BILL, Zughebel	604	Bohrer, CRUTCHFIELD	327
BARTON, Zughebel	603/2	BILLEAU, Ohrschlinge	409	Bohrer, ERRICO	299
Batteriegriff, Kaltlicht	33	Biopsie- und Absaugkürlette	600	Bohrer, MCKENZIE	299
Batteriegriff, Warmlicht	32	Biopsiekanüle, MENGHINI	206	BOIES, Elevator	277
Bauch- u. Darmspatel	143/1 - 143/4	Biopsiekürlette	600	Bolzenschneider	320
Bauch- u. Darmspatel, KÜMMEL	143/4	Biopsiekürlette, HEANY	587	BONACCOLTO, Strabismuspinzette	385
Bauchdeckenhalter, BABY-GOSSET	181	Biopsiekürlette, KEVORKIAN	587	BONN, Irispinzette	387
Bauchdeckenhalter, BALFOUR	182	Biopsiekürlette, MOD. MÜNCHEN	587	BONNEY, Pinzette	88
Bauchdeckenhalter, BALFOUR-BABY	182	Biopsiekürlette, NOVAK	587	BOSE, Trachealhaken	477
Bauchdeckenhalter, BALFOUR-US	184	Biopsiekürlette, RANDALL	587	BOSE, Trachealspreizer	476
Bauchdeckenhalter, CHARNELY	289	Biopsiezange, ALEXANDER	589	BOUCHERON, Ohrspekula	399
Bauchdeckenhalter, COLLIN	190	Biopsiezange, BABY-TISCHLER	592	BOWMAN, Diszisionsnadel	374
Bauchdeckenhalter, COLLIN-LOKTITE	191	Biopsiezange, BURKE	590	BOWMAN, Lidsperrer	370
Bauchdeckenhalter, DeBAKEY	189/1	Biopsiezange, EPPENDORFER	590	BOWMAN, Tränenkanalsonde	381
		Biopsiezange, FAURE	588	BOYNTON, Nadelhalter	214

BOYS-ALLIS, Darmfaßzange	538	Carotis-Shuntklemme, JAVID	511	Cilienpinzette, BEER	395
BOZEMANN, Nadelhalter	211	CARPENTER, Tonsillenelevator	465	Cilienpinzette, DOUGLAS	395
BOZEMANN, Tamponzange	138	CARPENTER, Tonsillennmesser	465	Cilienpinzette, GRADLE	395
BOZEMANN-DOUGLAS, Tamponzange	138	Cartilageschere, MARTIN	65/1	Cilienpinzette, LITTAUER	395
BRAND, Sehnenfassinstrument	293	CASPAR, Laminektomiespreizer	179, 180	Cilienpinzette, REDA	395
BRAND, Sehnenschäler	294	CASPAR, Spreizer	197	CINELLI, Septummeißel	441
BRAUN, Dekapitationshaken	607	CASPAR, Stössel	258	Circumcisionsgerät	556
BRAUN, Hakenzange	582	CASPAR, Wundspreizer	179, 180	CITELLI, Knochenstanze	430
BRAUN, Kranioklast	607	CASTANEDA, Neonatal-Gefäßklemme	527	CLAR, Stirnlampe	22
BRAUN, Uterusdepressor	586	CASTROVIEJO, Disziionsmesser	372	CLARK, Lidsperrerr	370
BRAUN-STADLER, Episotomie-Schere	64	CASTROVIEJO, Fixierpinzette	390	CLAUS, Tonsillennadel	466
BREAST, Wundhaken	198	CASTROVIEJO, Hornhautschere	79	CLAUS-EICKEN, Tonsillennadel	466
BREISKY, Scheidenspekula	577	CASTROVIEJO, Kapselpinzette	391	CLAYMAN, Hähchen	376
Breiten-Messinstrument	594	CASTROVIEJO, Klängenbrecher	45	CLEVELAND, Hohlmeißelzange	235
BRISTOW, Knochenhebel	290	CASTROVIEJO, Lidsperrerr	371	Cliplanlegezange, ETHICON	524, 525
BRODIE, Hohlsonde	199	CASTROVIEJO, Messzirkel	380	Cliplanlegezange, HORIZON	524, 525
Bronchoskopiezange, CHEVALIER-JACKSON	473	CASTROVIEJO, Nadelhalter	215, 216	Cliplanlegezange, PILLING	524, 525
Bronchusklemme	126	CASTROVIEJO, Nahtpinzette	392	Cliplanlegezange, SLS Clips	524, 525
Bronchusklemme, FINOCCHIETTO	490	CASTROVIEJO, Tränenkanal dilatator	381	CLOWARD, Laminektomiezange	342
Bronchusklemme, HARRINGTON	490	CASTROVIEJO, Zyklo dialysespatel	379	CLOWARD, Wirbelkörperspreizer	339
Bronchusklemme, LEES	504	CASTROVIEJO-Micro, Nadelhalter	215	CLOWARD, Wundsperrerr	178/1 - 178/4
Bronchusklemme, PRICE-THOMAS	490	CASTROVIEJO-STANDARD, Nadelhalter	216	COAKLEY, Antrumkürette	449
Bronchusklemme, SEMB	491	CATLIN, Amputationsmesser	44	COAKLEY, Kieferhöhlenotrokar	204
BROPHY, Pinzette	84	Cauter, WADSWORTH-TODD	378	Coarctationsklemme, DeBAKEY	507
BROWN, Gewebepinzette	83	CAWOOD-MINNESOTA, Wangenhalter	451	Coarctationsklemme, POTTS	492
BROWN, Nadelhalter	209	Cervicalspreizer, CLOWARD	178/1 - 179	COBB, Hohlmeißel	262
BRUENINGS, Aufsatz	472	Chalazionskürette, AXENFELD	377	COBB, Kürette	252
BRUENINGS, Ohrspekula	401	Chalazionskürette, HEBRA	377	COBB, Raspator	280
BRUENINGS, Septumzange	425	Chalazionskürette, MEYHOEFER	377	COBB, scharfer Löffel	252
BRUENINGS, Tonsillennmesser	466	Chalazionspinzette, AYER	393	COLCLOUGH, Bandscheibenstanze	344/1
BRUENINGS, Tonsillenschürer	468	Chalazionspinzette, DESMARRÉS	393	COLLER-CRILE, Arterienklemme	106
BRUENINGS, Verlängerungsrohr	472	Chalazionspinzette, LAMBERT	393	COLLIER, Beckenzirkel	605
BRUENINGS, Zungenspatel	451	CHANDLER, Elevator	282	COLLIER, Nadelhalter	208
BRÜNINGS-LUCAS, Flachmeißel	260	CHAPUT, Gewebefasszange	110	COLLIN, Bauchdeckenhalter	190
BRUNETTI, Meißel	268	CHARNLEY, Bauchdeckenhalter	289	COLLIN, Beckenzirkel	605
BRUNNER, Darmklemme	543	CHARRIERE, Amputationsäge	296	COLLIN, Darmfasszange	539
BRUNNER, Führungshohlsonde	221/1	CHEATLE, Sterilisierzange	227	COLLIN, Dynamometer	25
BRUNNER, Rippenschere	481	CHELSEA-EATON, Proktoskop	563	COLLIN, Gewebefasszange	110
BRUNNER, Wundhaken	167	CHERON, Tupferzange	137	COLLIN, Hammer	270
BRUNS, scharfer Löffel	251	CHEERY, Laminektomiesperrerr	488	COLLIN, Nabelschnurklemme	605
BRUNS, Verbandschere	70	CHEVALIER-JACKSON, Bronchoskopiezange	473	COLLIN, Scheidenspekula	570
Bruststütze, KLEINSASSER	36	CHEVALIER-JACKSON, Trachealkanüle	479	COLLIN, Sonde	586
Bruststütze, NEGUS	459	CHILDE, Wundklammerzange	224	COLLIN, Tupferzange	137
BRYANT, Tupferzange	137	chirurgische Nadel	222	COLLIN, Uterus-Fasszange	585
BUCHWALD, Zungenspatel	451	chirurgische Nadel, KEITH	223	COLLIN, Uterussonde	586
BUCK, Fremdkörperhebel	412	chirurgische Nadel, KOENIG	223	COLLIN, Wundhaken	139
BUCK, Ohrkürette	407	chirurgische Pinzette	81/1	COLLIN, Wundklammerzange	224
BUCK, Perkussionshammer	24	chirurgische Pinzette, ADLERKREUZ	84	COLLIN, Zungenzange	453
BUCK-GRAMCKO, Knochenhebel	285	chirurgische Pinzette, ADSON	81/2, 82	COLLIN-DUVAL, Fasspinzette	85
BUIE, Rektal-Absaugrohr	566	chirurgische Pinzette, ADSON-BROWN	82	COLLIN-HARTMANN, Wundhaken	141
Bulldogklemme, atrauma	100	chirurgische Pinzette, ADSON-Micro	82	COLLIN-LOKTITE, Bauchdeckenhalter	191
Bulldogklemme, DeBAKEY	103	chirurgische Pinzette, BONNEY	88	Columella-Pinzette, COTTLE	448
Bulldogklemme, GLOVER	103	chirurgische Pinzette, BROPHY	84	COLVER, Tonsillenfasszange	467
Bulldogklemme, JOHNS-HOPKINS	104	chirurgische Pinzette, BROWN	83	CONE, Schädelstanze	331
BÜLOW-GUNAR-HEY, Rollenklemme	130	chirurgische Pinzette, CUSHING	83	CONNIN-AMSLER, Markierungsinstrument	380
BUMM, Uteruskürette	597, 598	chirurgische Pinzette, FERRIS-SMITH	85	CONVERSE, Nasenhaken	448
BUNELL, Handbohrapparat	299	chirurgische Pinzette, GERALD	87	CONVERSE, Nasenmesser	435
BUNELL, Sehnenführer	294	chirurgische Pinzette, GILLIES	86	COOLEY, Anastomosenklemme	520/1
BUNELL, Sehnenschäler	292	chirurgische Pinzette, LANE	84	COOLEY, Aortaklemme	520/3
BUNGE, Exenterationslöffel	378	chirurgische Pinzette, LERCHE	83	COOLEY, Gefäßklemme	520/1 - 520/4
BUNT, Sterilisierklammer	227, 624	chirurgische Pinzette, McINDOE	85	COOLEY, Katheterklemme	510
BURCH, Fixiergabel	373	chirurgische Pinzette, OEHLER	81/1	COOLEY, Kinder-Gefäßklemmen	522
BURKE, Uterus-Biopsiezange	590	chirurgische Pinzette, POTTS-SMITH	81	COOLEY, Mehrzweck-Gefäßklemme	518 - 520
Bürstenspender	611	chirurgische Pinzette, SEMKEN	86	COOLEY, Rippensperrerr	485, 487
BUSCH, Nabelschnurschere	64	chirurgische Pinzette, Standard	81/1	COOLEY, Saugrohr	28
BUSHE, scharfer Löffel	256	chirurgische Pinzette, STILLE	81/1	COOLEY, Wundhaken	148
		chirurgische Pinzette, STILLE-BARRAYA	88	COOLEY-DERRA, Anastomosenklemme	519
		chirurgische Pinzette, STRASSBURGER MODELL	89	COOLEY-NEONATAL, Rippensperrerr	485
		chirurgische Pinzette, TAYLOR	87	COOPER, Unterbindungsnadel	219
		chirurgische Pinzette, WAUGH	83	CORDES, Aufsatz	472
		chirurgische Schere, DEAVER	52	CORONAL-BROW, Wundhaken	198
		chirurgische Schere, STANDARD	51	CORWIN-HEGAR, Drahtzange	319
		Cilienpinzette, BARRAQUER	395	CORYLLOS, Rippenschere	480
C					
CANFIELD, Tonsillennmesser	466				
CAPLAN, Nasenzange	428				
Cardiovascular-Klemme	526				
CARMALT, Splitterpinzette	91				
CAROLL, Sehnenfaßinstrument	293				

CORYLLOS, Wundhaken	166	Darmklemme, FEHLAND	542	DEMEL, Drahtspanninstrument	315
COS, Mikro-Ohrzängchen	414	Darmklemme, HAYES	545	DEMEL, Drahtumführungsnaedel	315
COTTLE, Bulldoggschere	56	Darmklemme, KOCHER	540	DENHART, Mundsperrer	454
COTTLE, Columella-Pinzette	448	Darmklemme, LANE	547	DENIS-BROWNE, Bauchdeckenhalter	185
COTTLE, Fixierpinzette	410	Darmklemme, MAYO-ROBSON	541	DERF, Nadelhalter	208
COTTLE, Hammer	273	Darmklemme, MIKULICZ	543	Dermatom, HUMBY	50
COTTLE, Hauthäkchen	447/1, 448	Darmklemme, PAYR	548	Dermatom, SCHINK	49
COTTLE, Knorpelquetscher	440	Darmklemme, RESANO	542	Dermatom, SILVER	50
COTTLE, Nasenhaken	447, 447/1	Darmklemme, SCUDDER	541	Dermatom, WATSON	50
COTTLE, Nasenmesser	435	Darmklemme, STONE-WATT	545	DERRA, Anastomosenklemme	515
COTTLE, Nasenschere	59	Darmschere	66	D'ERRICO, Nervwurzelhaken	329/2
COTTLE, Nasenspekula	423	Darmspatel	143/1 - 143/4	DESCHAMPS, Unterbindungsnaedel	218
COTTLE, Osteotom	440	Darmspatel, HABERER	143/3	DESJARDINS, Arterienklemme	121
COTTLE, Schere	56	Darmspatel, KADER	143/3	DESJARDINS, Gallensteinlöffel	534
COTTLE, Septumelelevator	439	Darmspatel, KÖRTE	143/3	DESJARDINS, Gallensteinsonde	531
COTTLE, Septummeissel	440	Darmspatel, KÜMMEL	143/4	DESJARDINS, Gallensteinzange	530/2
COTTLE-JOSEPH, Septumelelevator	439	Darmspatel, LERICHE	143/4	DESMARRES, Chalazionspinzette	393
COTTLE-KAZANJIAN, Knochenplitterzange	241	Darmspatel, REVERDIN	143/3	DESMARRES, Wundhaken	151
COTTLE-NEIVERT, Hauthäkchen	448	Darmspatel, RIBBON	143/1	DEUTSCHMANN, Starmesser	371
COXETER, Metallkatheter	555	Darm- u. Gewebefasszange, GREGOIRE	538	DeVILBISS, Schädelzange	332
CRAFOORD, Arterienklemme	118	DARTIGUES, Uterusfasszange	585	Diagnostik-Besteck ECO °C	16
CRAFOORD, Lungenschere	65/2	DASTOOR, Strabismuspinzette	386	Diagnostik-Besteck ECO "T"	16
CRAFOOD-SELLORS, Arterienklemme	119	DAUBENSPECK, scharfer Löffel	255	Diagnostik-Besteck, RI-MINI	17
CREGO, Elevator	282	DAVIDSON (SCAPULA), Wundhaken	166	Diagnostik-Besteck, UNI III	15
CRILE, Arterienklemme	107	DAVIEL, Starlöffel	377	DIEFFENBACH, Gefässklemme	104
CRILE, Nadelhalter	213	DAVIS, Duradisektor	332	DIETER, Mikro-Ohrzängchen	414
CRILE, Nervhaken	328	DAVIS, Fremdkörpernaedel	374	DIETRICH, Aortaklemme	510
CRILE, Wundhaken	140	DAVIS, Hirnspatel	337	DIETRICH, Gefässschere	60
CRILE-MURRAY, Nadelhalter	209	DAVIS, Sterilisierpinzette	227	DIETRICH, Mini-Bulldogklemme	101
CRILE-RANKIN, Arterienklemme	107	DAVIS-BOYLE, Mundsperrer	455	Dilatationsbougie, DITTEL	554
CRILE-WOOD, Nadelhalter	209	DAVIS-BOYLE, Sperrer	455	Dilatationsbougie, GUYON	554
CRITCHETT, Lidsperrer	370	DAVIS-BOYLE, Zugendrücker	455	Dilatationsbougie, VAN BUREN	554
CRUTCHFIELD, Bohrer	327	DAVIS-MEYER, Mundsperrer	457	Dilatator, BAKES	532
CRUTCHFIELD, Schädelhalter	327	DAY, Häkchen	409	Dilatator, CASTROVIEJO	381
CUSCO, Scheidenspekula	570, 571	DEAN, Irismesser	372	Dilatator, DeBAKEY	529
CUSHING, Bohrer	299	DEAN, Tonsillenschere	59	Dilatator, GOODELL	581
CUSHING, Hirnspatel	336, 369	DEAVER, Präparierschere	52	Dilatator, HANK	580
CUSHING, Laminektomie zange	340	DEAVER, Wundhaken	145, 146	Dilatator, HEGAR	578, 579
CUSHING, Nervenhaken	328	DEAVER-GRIP, Wundhaken	146	Dilatator, PRATT	580
CUSHING, Pinzette	83, 87	DeBAKEY, Anastomosenklemme	505	Dilatator, RITTER-HALLE	433
CUSHING, Wundhaken	151, 152	DeBAKEY, Aorta-Aneurysmaklemme	496 - 498	Dilatator, SIMS	581
CUSHING (TAYLOR), Pinzette	87	DeBAKEY, Aortaklemme	499, 500	Dilatator, WALTHER	555
CUZZI, Abortuslöffel	606	DeBAKEY, Atrauma-Bulldogklemme	103	Dilatator, WILDER	381
Cystotom, BECKER	375	DeBAKEY, Atrauma-Pinzette	98, 99	Dilatator, WYLIE	581
Cystotom, GRAEFFE	375	DeBAKEY, Bauchdeckenhalter	189/1	Dilatator, ZIEGLER	381
CZERNY, Hakenzange	584	DeBAKEY, Coarctationsklemme	507	DINGMANN, Elevator	463/3
CZERNY, Mastdarm-Spekula	559	DeBAKEY, Gefässdilator	529	DINGMANN, Knochenhalte zange	246
CZERNY, Wundhaken	141	DeBAKEY, Gefässklemme	493 - 499	DINGMANN, Mundsperrer	456
D		DeBAKEY, Gefässschere	61	DINGMANN, Raspator	463, 463/3
DALE, Gefässklemme	494, 495	DeBAKEY, Ligaturklemme	499 - 500	DINGMANN, Sperrer	456
DANDY, Arterienklemme	109	DeBAKEY, Mehrzweck-Gefäßklemme	495, 508, 514 - 517	DIPLOMAT, Blutdruckmeßgerät	5
DANDY, Nervenhaken	328	DeBAKEY, Nadelhalter	210	Dissektor, FISCH	420
DARDIK, Gefässklemme	509/1	DeBAKEY, Saugrohr	28	Dissektor, GÖRNEY	277
DARLING, Wundspreiber	178	DeBAKEY, Tangentialklemme	502	Dissektor, ROBB	530
Darmfasszange, ALLIS	537	DeBAKEY-BAHNSON, Aneurysmaklemme	506	Dissektor, PENFIELD	333
Darmfasszange, ALLIS-ADAIR	537	DeBAKEY-DIETRICH, Mini-Bulldogklemme	101	Diszisionsmesser, BERENS	372
Darmfasszange, ALLIS-BABY	537	DeBAKEY-MIXTER, Präparier- u. Ligaturklemme	499/2	Diszisionsmesser, CASTROVIEJO	372
Darmfasszange, atrauma	539	DeBAKEY-MOSQUITO, Atrauma-Arterienklemme	509	Diszisionsmesser, GRAEFFE	372
Darmfasszange, BABCOCK	539	DeBAKEY-PEAN, Atrauma-Arterienklemme	513	Diszisionsmesser, WHEELER	373
Darmfasszange, BOYS-ALLIS	538	DeBAKEY-RANKIN, Atrauma-Arterienklemme	512	Diszisionsmesser, ZIEGLER	373
Darmfasszange, COLLIN	539	DeBAKEY-RUMEL, Gefässklemme	499	Diszisionsnaedel	374
Darmfasszange, DOYEN-BABY	540	DeBAKEY-SATINSKY, Tangentialklemme	502	Diszisionsnaedel, BOWMAN	374
Darmfasszange, DOYEN	539	DeBOER, Rippersperrer	486	DITTEL, Dilatationsbougie	554
Darmfasszange, DUVAL	539	DECKER, Rongeur	341	DIX, Fremdkörperflächmeissel	374
Darmfasszange, JUDD-ALLIS	538	DEJERINE, Perkussionshammer	24	DIX, Fremdkörperinstrument	380
Darmfasszange, LITTLEWOOD	538	Dekapitationshaken, BRAUN	607	Doppelkürlette	612
Darmfasszange, LOCKWOOD-ALLIS	538	deLEE, Geburtszange	602	Doppelöffel, VOLKMANN	257
Darmfasszange, THOMS-ALLIS	538	deLEE, Scheidenspekula	574	DOUGHTY, Zungenpatel	458
Darmfasszange, WILLIAMS	539	DeMARTEL, Führungsinstrument	330	DOUGLAS, Cliepinzette	395
Darmklemme, BABY-KOCHER	540	DeMARTEL-WOLFSON, Anastomosenklemme	546	DOUGLAS, Kieferhöhlenrotor	204
Darmklemme, BRUNNER	543	DeMARTEL-WOLFSON, Darmklemme	546	DOUGLAS, Tonsillennesser	466
Darmklemme, DeMARTEL-WOLFSON	546	DeMARTEL-WOLFSON, Klemmenhalterung	546	DOYEN, Bauchdeckenhalter	189/1
Darmklemme, DOYEN	540	DeMARTEL-WOLFSON, Klemmenschlusszange	546	DOYEN, Darmklemme	540

DOYEN, Hohlsonde.....	199	Elevator, DINGMAN.....	463, 463/3	Fadenpinzette, Mod. TUEBINGEN.....	392
DOYEN, Myomheber.....	594	Elevator, DINGMANN.....	463/3	Fadenpinzette, PAUFIQUE.....	392
DOYEN, Raspator.....	278	Elevator, FREER.....	434, 437, 439	Fadenschere, HEATH.....	66
DOYEN, Scheidenspekula.....	574	Elevator, HAJEK-BALLENGER.....	439	Fadenschere, LITTAUER.....	66
DOYEN, Schere.....	63	Elevator, HALLE.....	437	Fadenschere, NORTHBENT.....	66
DOYEN, Tuchklemme.....	133	Elevator, HOWARTH.....	438	Fadenschere, SPENCER.....	66
DOYEN, Uterus-Polypenzange.....	585	Elevator, JOSEPH.....	437	FANSLER, Proktoskop.....	564
DOYEN, Wundhaken.....	163	Elevator, KEY.....	282	FARABEUF, Knochenhalte-zange.....	243
DOYEN-BABY, Darmklemme.....	540	Elevator, KILLIAN.....	438, 439	FARABEUF, Raspator.....	274
DOYEN-JANSEN (MOLT), Mundsperrer.....	454	Elevator, LEMPERT.....	420	FARABEUF, Wundhaken.....	139
DOYEN-STILLE, Wundhaken.....	167	Elevator, MASING.....	437	FARABEUF-COLLIN, Raspator.....	274
Drahtbogen, ERICH.....	461/2	Elevator, McDONALD.....	283	FARABEUF-LAMBOTTE, Knochenhalte-zange.....	243
Drahtfasszange.....	316, 318	Elevator, McKENTY.....	437	FARRELL, Watteräger.....	203
Drahtgeflecht.....	311	Elevator, MURPHY-LANE.....	283	Fasspinzette.....	305
Drahtkneifzange.....	317 - 320/3	Elevator, OBWEGESER.....	461/1	Fasspinzette, COLLIN-DUVAL.....	85
Drahtsäge, OLIVECRONA.....	332	Elevator, PENNINGTON.....	438	Fasspinzette, DURANTE.....	88
Drahtschere, UNIVERSAL.....	67	Elevator, PIERCE.....	438	Fasspinzette, DUVAL.....	85
Drahtspanninstrument, DEMEL.....	315	Elevator, ROGER.....	437	Fasspinzette, LERCHE.....	83
Drahtspanninstrument, LOUTE.....	315	Elevator, SAYRE.....	281	Fasspinzette, RUSS. MODELL.....	85
Drahtumföhrungs-nadel, DEMEL.....	315	Elevator, SINUS.....	438	Fasszange.....	316
Drahtvalven, Bauchdeckenhalter.....	184	Elevator, WATSON-CHEYNE.....	283	Fasszange, ALLIS.....	537
Drahtzange TC, BERRY.....	319	Elevator, YANKAUER.....	465	Fasszange, ALLIS-ADAIR.....	537
Drahtzange TC, CORWIN-HEGAR.....	319	ELLIOT, Geburtszange.....	603	Fasszange, ALLIS-BABY.....	537
Drahtzange TC, MAYO-HABERISSER.....	319	ELLIS, Fremdkörperrhöhlmeißel.....	374	Fasszange, BABCOCK.....	539
Dreibackenspannfutter Handgriff.....	300	ELSCHING, Fixationspinzette.....	389	Fasszange, BOYS-ALLIS.....	538
DUBOIS, Schere.....	63	ELSCHING, Hornhautmesser.....	373	Fasszange, COLLIN.....	539, 585
Duftstick.....	231/1	ELSCHING, Kapselpinzette.....	391	Fasszange, DARTIGUES.....	585
DUPLAY, Hakenzange.....	582	ELSCHING, Zykliodialysespatel.....	379	Fasszange, DOYEN.....	585
DUPLAY, Kornzange.....	134	EMMETT, Fistelhäkchen.....	594	Fasszange, DUVAL.....	539
DUPLEX, Stethoskop.....	23	Endarterektomie-Stripper.....	202	Fasszange, GREGOIRE.....	538
DUPIY-WEISS, Tonsillennadel.....	466	Endernagel, STEINMANN.....	307, 308	Fasszange, JUDD-ALLIS.....	538
Dura-Dissektor, DAVIS.....	332	Endoskopiekorb.....	623	Fasszange, KELLY.....	585
Dura-Dissektor, FRAZIER.....	333	Endospekula, KOGAN.....	577	Fasszange, LAHEY.....	479
Dura-Dissektor, HOEN.....	333	ENGL, Gips-säge.....	229	Fasszange, LANDOLT.....	341/2
Dura-Dissektor, HORSLEY.....	333	Enukleations-Löffel, WELLS.....	378	Fasszange, LITTLEWOOD.....	538
Dura-Dissektor, MILLIGAN.....	332	Episiotomie-Schere, BRAUN-STADLER.....	64	Fasszange, LOCKWOOD-ALLIS.....	538
Dura-Dissektor, OLIVECRONA.....	332	Episiotomie-Schere, WALDMANN.....	64	Fasszange, LOVE-LACE.....	490
Dura-Dissektor, PENFIELD.....	333	EPKER, Osteotome.....	464/2	Fasszange, MARTEL.....	110
Dura-Dissektor, SACHS.....	332	EPPENDORFER, Uterus-Biopsiezange.....	590	Fasszange, McGIVNEY.....	568
Dura-Dissektor, TOENNIS.....	332	ERBE, Verbindungskabel.....	633	Fasszange, MILLIN.....	550, 551
Dura-Dissektor, WOODSON.....	333	ERBE/SELECT, Verbindungskabel.....	633	Fasszange, NOTO.....	585
Dura-Haken.....	335	ERICH, Drahtbogen.....	461/2	Fasszange, PRATT.....	110
Dura-Haken, ADSON.....	329	ERRICO, Bohrer.....	299	Fasszange, YOUNG.....	550
Dura-Haken, JACOBSON.....	335	Ersatzklinge.....	49, 50	Fasszange, SERPENTINE-GRASPER.....	593
Dura-Messer, KOOS.....	335	Ersatzlämpchen.....	29, 30	Fasszange, SOMER.....	585
DURANTE, Fasspinzette.....	88	Ersatzsägeblätter.....	230	Fasszange, WILLET-MARTEL.....	110
Dura-Schere, SCHMIEDEN-TAYLOR.....	65/1	Ersatzteilst, HERCULES.....	320/1 - 320/3	Fasszange, WILLIAMS.....	539
DUVAL, Darmfasszange.....	539	ESMARCH, Gipsmesser.....	233	FAULKNER, Kürette.....	449
DUVAL, Fasspinzette.....	85	ESMARCH, Staubinde.....	296	FAURE, Biopsiezange.....	588
Dynamometer, COLLIN.....	25	ESMARCH, Verbandschere.....	69/2	FAURE, Peritoneumklemme.....	123
E		ETHICON, Cilpanlegezange.....	524, 525	FAVALORO, Gefäßschere.....	61
ECHLIN, Hohlmeißelzange.....	240	EVES, Tonsillenschnürer.....	468	FEHLAND, Darmklemme.....	542
ECO "C" Diagnostik-Besteck.....	16	EXACTA, Blutdruckmessgerät.....	8	FEILCHENFELD, Splitterpinzette.....	91
ECO "T" Diagnostik-Besteck.....	16	Exenterationslöffel, BUNGE.....	378	FELDHEIM, Knochenhalteklammer.....	249
EICKEN (KILLIAN), Spülkanüle.....	433	Extensionsbügel, BOEHLER.....	312	FERGUSSON, Gallensteinlöffel.....	533
Ein- u. Ausschlagninstrumente.....	321	Extensionsbügel, KIRSCHNER.....	312	FERGUSSON, Hämorrhoidalklemme.....	109
Einschläger, BENDER.....	322/1	Extensionsbügel, KIRSCHNER US.....	312	FERGUSSON, Knochenhalte-zange.....	243
Elektrode, monopolar.....	629	Extirpationsmeißel, ROLLET.....	374	FERGUSSON, Saugrohr.....	337
Elektrodenball-Koagulation.....	629	Extraktor.....	322/1	FERGUSSON, Schere.....	66
Elektroden-Drahtschlinge.....	629	Extraktionshaken.....	322	FERGUSSON-FRAZIER, Saugrohr.....	337
Elektroden-Koagulation.....	629	Extraktionshaken, ARRUGA.....	375	FERRIERA, Wundhaken.....	197
Elektroden-Lanzette.....	629	Extraktionshaken, I.U.D.....	593	FERRIS-SMITH, Laminektomie-zange.....	343
Elektroden-Nadel.....	629	Extraktor, KUENTSCHER.....	322	FERRIS-SMITH, Pinzette.....	85
Elektroden-Schlinge.....	628, 629	Exzentrische Begrenzungs-scheibe.....	230/17	FERRIS-SMITH-KERRISON, Bandscheibenstanze...344, 344/2	
Elevator.....	280	F		Fertigschläger, KUENTSCHER.....	321
Elevator, ALDERDYCE.....	282	Face-Lift-Schere, FREEMAN.....	74	Fiberglas-Lichtträger, KLEINSASSER.....	36
Elevator, BALLENGER.....	439	Face-Lift-Schere, GORNEY.....	73	Filtervlies f. Gips-säge.....	230/18
Elevator, BOIES.....	277	Face-Lift-Schere, KAYE.....	73	Finger-Goniometer.....	25
Elevator, CHANDLER.....	282	Face-Lift-Schere, REES.....	73	Fingerring-säge, REDA.....	297
Elevator, COTTLE.....	439	Fadengabel, REDA.....	221	Fingerring-säge, WALTON.....	297
Elevator, COTTLE-JOSEPH.....	439	Fadengabel, Tracheotomie.....	475	Fingersäge, LANGENBECK.....	296
Elevator, CREGO.....	282	Fadenpinzette, McPHERSON.....	392	Fingerschützer, LANGENBECK.....	311
				FINOCHIETTO, Bronchusklemme.....	490

FINOCHIETTO, Nadelhalter.....	211	Fremdkörperkürette, ALVIS	374	Gefäßscilip, MÜLLER.....	365
FINOCHIETTO, Rippensperrerr.....	482, 484	Fremdkörpernadel.....	374	Gefäßscilip, YASARGIL.....	345 - 356
FINOCHIETTO-BABY, Rippensperrerr.....	482	Fremdkörpernadel, DAVIS.....	374	Gefäßsdilatator, DeBAKEY.....	529
FINOCHIETTO-BURFORD, Rippensperrerr.....	483	Fremdkörpernadel, FRANCIS.....	374	Gefäßsdissektor, ROBB.....	530
FINSEN, Wundhaken.....	168	Fremdkörpernadel, LA FORCE.....	374	Gefäßsklemme, atrauma.....	492, 495/1, 495/2, 523 - 527
FISCH, Dissektor.....	420	Fremdkörpernadel, LEVINSON.....	374	Gefäßsklemme, BAINBRIDGE.....	495/1, 495/2
FISCH, feines Häkchen.....	335	Fremdkörperzängchen, HARTMANN.....	412	Gefäßsklemme, BECK.....	520
FISCHER, Irispinzette.....	384	Fremdkörperzängchen, HARTMANN-HOFFMANN.....	412	Gefäßsklemme, COOLEY.....	510, 518 - 522
FISH, Sonde.....	199	Fremdkörperzängchen, HARTMANN-WULLSTEIN.....	412	Gefäßsklemme, COOLEY-DERRA.....	519
FISHER, Tonsillennmesser.....	466	Fremdkörperzängchen, STRUEMPEL.....	412	Gefäßsklemme, DALE.....	494, 495
Fistelhäkchen, EMMETT.....	594	Fremdkörperzange, MATHIEU.....	553/1	Gefäßsklemme, DARDIK.....	509/1
Fistelsonde, LOCKHART-MUMMERY.....	200	FRENZEL, Nystagmusbrille.....	20	Gefäßsklemme, DeBAKEY.....	493 - 517
Fistelsonde, PRAIT.....	563	FRENZEL, Zungenspatel.....	451	Gefäßsklemme, DeBAKEY-BAHNSON.....	506
Fixationspinzette, BARRAQUER.....	390	FRIEDMAN, Hohlmeisselzange.....	234	Gefäßsklemme, DeBAKEY-BECK.....	516
Fixationspinzette, ELSCHNIG.....	389	FRIEDMANN, Spektula.....	577	Gefäßsklemme, DeBAKEY-MIXTER.....	499/2
Fixationspinzette, GRAEFE.....	389	FRITSCH, Wundhaken.....	163	Gefäßsklemme, DeBAKEY-MOSQUITO.....	509
Fixationspinzette, GREEN.....	390	FRYKHOLM, Hohlmeisselzange.....	240	Gefäßsklemme, DeBAKEY-PEAN.....	513
Fixationspinzette, LESTER.....	389	FUCHS, Kapselpinzette.....	391	Gefäßsklemme, DeBAKEY-RANKIN.....	512
Fixiergabel, BURCH.....	373	FUCHSIG, Arterienklemme.....	113	Gefäßsklemme, DeBAKEY-RUMEL.....	499
Fixierpinzette, CASTROVIEJO.....	390	Führungshohlsonde, BRUNNER.....	221/1	Gefäßsklemme, DeBAKEY-SATINSKY.....	502
Fixierpinzette, COTTLE.....	410	Führungshohlsonde, KIRSCHNER.....	221	Gefäßsklemme, DERRA.....	515
Fixierpinzette, GRAEFE.....	83	Führungshohlsonde, KOENIG.....	221/1	Gefäßsklemme, DIEFFENBACH.....	104
Fixierpinzette, KIRBY-ARTHUR.....	385	Führungshohlsonde, PAYR.....	221/1	Gefäßsklemme, DIETRICH.....	510
Fixiervorrichtung, LEYLA.....	368/1	Führungshohlsonde, REDA.....	221/1	Gefäßsklemme, GLOVER.....	515
Fixiervorrichtung, ROCHARD.....	186	Führungshohlsonde, SCHMIEDEN.....	221	Gefäßsklemme, GREGORY.....	517
Flachbohrer, CUSHING.....	299	Führungshohlsonde, SCHMIEDEN-PAYR.....	221	Gefäßsklemme, HARKEN.....	503
Flachmeissel.....	259, 264, 267	Führungshohlsonde, VIENNA.....	221/1	Gefäßsklemme, JAVID.....	511
Flachmeissel, ALEXANDER.....	259	Führungsinstrument, DeMARTEL.....	330	Gefäßsklemme, LAMBERT-KAY.....	505
Flachmeissel, BRÜNINGS-LUCAS.....	260	Führungsnadel, REDON.....	207	Gefäßsklemme, LEES.....	504
Flachmeissel, Ferrozellgriff.....	264	Führungsspiess.....	321	Gefäßsklemme, LELAND-JONES.....	495
Flachmeissel, HIBBS.....	265	G.....		Gefäßsklemme, MORRIS-DeBAKEY.....	506
Flachmeissel, HOKE.....	265	Galeahaken, YASARGIL.....	330	Gefäßsklemme, POTTS.....	492, 493
Flachmeissel, LEXER.....	263	GALLAHER, Antrumraspel.....	446	Gefäßsklemme, SATINSKY.....	491
Flachmeissel, NOVOTEX-Griff.....	264	Gallenblasenschere, THOREK.....	65/2	Gefäßsklemme, SUBRAMANIAN.....	521
Flachmeissel, PARTSCH.....	259	Gallengangdilator, BAKES.....	532	Gefäßsklemme, WEBER.....	501
Flachmeissel, STILLE.....	260	Gallensteinlöffel, DESJARDINS.....	534	Gefäßsklemme, WYLIE.....	501/1, 501/2
Flachzange.....	316, 317	Gallensteinlöffel, FERGUSON.....	533	Gefäßmesser, KOOS.....	335
flexible Fasszange, SERPENTINE-GRASPER.....	593	Gallensteinlöffel, LUER-KOERTE.....	533	Gefäßpinzette, ADLERKREUTZ.....	84
flexibler Hirnsattelhalter, LEYLA.....	368/2	Gallensteinlöffel, MAYO.....	534	Gefäßpinzette, NELSON.....	89
flexibler Spannarm, LEYLA.....	368/3	Gallensteinlöffel, MOOR.....	531	Gefäßpinzette, STILLE-BARRAYA.....	88
FOERSTER, Irispinzette.....	383	Gallensteinlöffel, MOOR.....	531	Gefäßpinzette, WANGENSTEEN.....	89
FOERSTER, Tupferzange.....	136	Gallensteinsonde, DESJARDINS.....	531	Gefäßschere, DeBAKEY.....	61
FOMON, Hauthäkchen.....	447/1	Gallensteinsonde, MAYO.....	534	Gefäßschere, DIETRICH.....	60
FOMON, Nasenhaken.....	447/1	Gallensteinsonde, MOYNIHAN.....	531	Gefäßschere, FAVALORO.....	61
FOMON, Nasenraspel.....	444, 445	Gallensteinzange, BLAKE.....	530/2	Gefäßschere, KELLY.....	61
FOMON, Nasenschere.....	58	Gallensteinzange, DESJARDINS.....	530/2	Gefäßschere, KLINKENBERG-LOTH.....	65/2
FOMON, Rasptator.....	277	Gallensteinzange, MAYO-BLAKE.....	530/2	Gefäßschere, POTTS-DeMARTEL.....	59
FOMON, Rhinoplastschere.....	65/1	Gallensteinzange, MIXTER.....	530/2	Gefäßschere, POTTS-SMITH.....	61
FOMON, Septummeissel.....	441	GASS, Häkchen.....	376	Gefäßschere, SATINSKY.....	65/2
FOX, Lupuskürette.....	608	GAUSS, Kopfschwarte.....	605	Gefäß-Spülkanüle, SCHMID.....	338
FRAENKEL, Aufsatz.....	472	Geburtslöffel, SELLHEIM.....	607	GELPI, Bauchdeckenhalter.....	189/1, 189/2
FRAENKEL, Kehikoptpolypenzange.....	471	Geburtszange.....	602 - 604	GELPI, Haken.....	193
FRANCIS, Fremdkörpernadel.....	374	Geburtszange, BARTON.....	603	GEMINI, Arterienklemme.....	115
FRAZIER, Bauchdeckenhalter.....	181	Geburtszange, BOERMA.....	604	GERALD, Pinzette.....	86, 87
FRAZIER, Dura-Dissektor.....	333	Geburtszange, DeLEE.....	602	GERSTER, Knochenhalteklammer.....	250
FRAZIER, Hauthäkchen.....	148/2	Geburtszange, ELLIOT.....	602	GERZOG, Hammer.....	270
FRAZIER/FERGUSON, Punktionskanüle.....	337	Geburtszange, KIELLAND.....	602	Gewebeasspinzette, BROWN.....	83
FRAZIER/FERGUSON, Saugrohr.....	337	Geburtszange, KIELLAND-LUIKART.....	603	Gewebeasspinzette, SINGLEY.....	88
FREEMAN, Face-Lift-Schere.....	74	Geburtszange, LUIKART.....	603	Gewebeasszange, CHAPUT.....	110
FREEMAN, Wundhaken.....	198	Geburtszange, McLEAN.....	603/1	Gewebeasszange, COLLIN.....	110
FREER, Elevatorium.....	437	Geburtszange, McLEAN-LUIKART.....	603/1	Gewebeasszange, GREGOIRE.....	538
FREER, Hauthäkchen.....	448	Geburtszange, McLEAN-TUCKER.....	603/1	Gewebeasszange, TUFFIER.....	110
FREER, Nasenmesser.....	434	Geburtszange, McLEAN-TUCKER-LUIKART.....	603/1	Gewicht, AUWARD.....	576
FREER, Septumlevator.....	437, 439	Geburtszange, NAEGELE.....	602	Gewicht, SCHERBAK.....	575
FREER, Septumhohlmeissel.....	442/1	Geburtszange, PIPER.....	604	GIERTZ-STILLE, Rippenschere.....	481
FREER, Septummeissel.....	439	Geburtszange, SIMPSON.....	602	GILLI, Säge.....	332
FREER, Septummesser.....	434	Geburtszange, SIMPSON-BRAUN.....	602	GILLI, Hornhautmesser.....	373
Fremdkörperfachmeissel, DIX.....	374	Geburtszange, SIMPSON-LUIKART.....	603	GILL, Irispinzette.....	384
Fremdkörperhebel, BUCK.....	412	Geburtszange, TARNIER.....	604	GILL-ARRUGA, Kapselpinzette.....	390
Fremdkörperhebel, QUIRE.....	412	Geburtszange, THIERRY.....	603	GILL-HESS, Irispinzette.....	384
Fremdkörperhohlmeissel, ELLIS.....	374	Geburtszange, WRIGLEY.....	602	GILLIES, Hauthäkchen.....	448
Fremdkörperhohlmeissel, WALTON.....	374	Gefäßscilip, BIEMER.....	361	GILLIES, Nadelhalter.....	212
Fremdkörperinstrument, DIX.....	380	Gefäßscilip, MEHDORN.....	362	GILLIES, Pinzette.....	86

GIL-VERNET, Wundhaken.....	152	GUYON, Nierenklemme.....	122	Haken, TAYLOR.....	196
Gipsabreisszange, WOLFF.....	233	GUYTON-LUNGSGAARD, Sklerotom.....	373	Haken, TESSIER.....	463/3
Gipsmesser, ESMARCH.....	233	Gynäkologie-Schere, DOYEN.....	63	Hakenzange, ADAIR.....	582
Gipsmesser, HOPKINS.....	233	Gynäkologie-Schere, DUBOIS.....	63	Hakenzange, BARRET.....	582
Gipsmesser, REINER.....	233	Gynäkologie-Schere, SIEBOLD.....	62	Hakenzange, BRAUN.....	582
Gipsmesser, WIGMORE.....	229	Gynäkologie-Schere, SIMS.....	62	Hakenzange, CZERNY.....	584
Gipssäge, elektrisch.....	230			Hakenzange, DUPLAY.....	582
Gipssäge, ENGEL.....	229	H		Hakenzange, HULKA.....	583
Gipssäge, oszillierend.....	230/10, 230/12	HABERER, Darmspatel.....	143/3	Hakenzange, IOWA.....	584
Gipsschere, STILLE.....	229	Hämorrhoidal-Klemme, FERGUSSON.....	109	Hakenzange, JACOBS.....	583
Gipsspreizer, BEESON.....	232	Hämorrhoidal-Ligatur, McGIVNEY.....	568	Hakenzange, JARCHO.....	583
Gipsspreizer, HAGLUND-STILLE.....	232	HAGLUND-STILLE, Gipsspreizer.....	232	Hakenzange, MUSEUX.....	583
Gipsspreizer, HENNIG.....	232	HAIGHT, Rippensperre.....	487	Hakenzange, POZZI-PALMER.....	582
Gipsspreizer, REDA.....	232	HAJEK, Hammer.....	273	Hakenzange, PRATT.....	584
GLOVER, Bulldogklemme.....	103	HAJEK, Septummeißel.....	442/1	Hakenzange, SCHRÖDER.....	583, 584
GLOVER, Mehrzweckklemme.....	515	HAJEK-BALLENGER, Elevator.....	439	Hakenzange, SCHRÖDER (POZZI).....	582
GLUCK, Rippenschere.....	480	HAJEK-KOFLER, Stanze.....	429, 431	Hakenzange, SKENE.....	582
GOELET, Wundhaken.....	141	Häkchen, ARRUGA.....	375	Hakenzange, STAUDE-MOORE.....	582
GOLDMANN-FOX, Zahnfleischschere.....	67	Häkchen, BARBARA.....	419	Hakenzange, TEALE.....	583
GOMMEL, Pinzette.....	96	Häkchen, BECKER.....	375	HALLE, scharfer Löffel.....	253
GOMMEL, Schere.....	80	Häkchen, BOSE.....	477	HALLE, Septumlevator.....	437
Goniometer f. Finger.....	25	Häkchen, CLAYMAN.....	376	Halogenlampe.....	29
Goniotomiemesser, BARKAN.....	373	Häkchen, CONVERSE.....	448	HALSEY, Nadelhalter.....	208
Goniotomiemesser, SCHEIE.....	373	Häkchen, COTTLE.....	447/1	HALSTED-MOSQUITO, Arterienklemme.....	105
GOOD, Tonsillenschere.....	59	Häkchen, COTTLE-NEIVERT.....	448	Haltearm, LEYLA.....	368/1
GOODELL, Uterus-Dilatator.....	581	Häkchen, DAY.....	409	Halteklemme, ADSON.....	298
GORNEY, Dissektor.....	277	Häkchen, FISCH.....	335	Halter, Hirnspatel, LEYLA.....	368/4
GORNEY, Face-Lift-Schere.....	73	Häkchen, FOMON.....	447/1	Halter, KALLMORGEN.....	573
GOSSET, Bauchdeckenhalter.....	181	Häkchen, FREER.....	448	Halter, KRISTTELLER.....	572
GOURDET, Uteruslöffel.....	599	Häkchen, GASS.....	376	Halterahmen.....	187
GRADLE, Pinzette.....	395	Häkchen, GILLIES.....	448	Haltezange, LANE.....	325
GRADLE, Schere.....	57	Häkchen, GRAEFE.....	375	Hammer.....	270 - 273
GRAEFE, Cystotom.....	375	Häkchen, GREEN.....	375	Hammer, BERGMANN.....	272
GRAEFE, Disziionsmesser.....	372	Häkchen, JAMESON.....	375	Hammer, COLLIN.....	270
GRAEFE, Fixationspinzette.....	389	Häkchen, KILNER.....	447/1, 608	Hammer, COTTLE.....	273
GRAEFE, Fixierpinzette.....	83	Häkchen, KNAPP.....	375	Hammer, Ferrozellgriff.....	272
GRAEFE, Hauthäkchen.....	148/2	Häkchen, KRAYENBÜHL.....	336	Hammer, GERZOG.....	270
GRAEFE, Irispinzette.....	382	Häkchen, KUGLEN.....	376	Hammer, HAJEK.....	273
GRAEFE, Lidsperrer.....	370	Häkchen, LANGE.....	448	Hammer, HEATH.....	273
GRAEFE, Schere.....	56	Häkchen, LUCAE.....	409	Hammer, KIRK.....	270
GRAEFE, Schielhaken.....	375	Häkchen, McGEE.....	419	Hammer, LUCAE.....	271
GRAEFE, Starlöffel.....	377	Häkchen, O'CONNOR.....	375	Hammer, MEAD.....	271
GRAEFE, Starmesser.....	371	Häkchen, ROLLET.....	375	Hammer, OMBREDANNE.....	273
GRAHAM, Nervhaken.....	329	Häkchen, SHAMBAUGH.....	419	Hammer, PARTSCH.....	271
GRAIG, Septumzange.....	426	Häkchen, SINSKEY.....	376	Hammer, QUISLING.....	271
GRAVE, Scheidenspekula.....	570	Häkchen, STEVENS.....	375	Hammer, WILLIGER.....	271
GRAY, Arterienklemme.....	121	Häkchen, Tracheotomie.....	475	Hämorrhoidal-Ligatur.....	568
GREEN, Fixationspinzette.....	390	Häkchen, WAGENER.....	409	Hämorrhoidal-Ligatur, RUDD.....	568
GREEN, Hornhautdissektor.....	374	Häkchen, WIENER.....	375	Hämorrhoidal-Zange, HEYWOOD-SMITH.....	567
GREEN, Muskelhäkchen.....	375	Haken, AUFRICHT.....	447	Hämorrhoidal-Zange, McGIVNEY.....	568
GREEN, Wundhaken.....	160	Haken, BALFOUR.....	193	Handbohrapparat, BUNELL.....	299
GREEN-ARMYTAGE, Uteruszange.....	605	Haken, BRAUN.....	607	Handbohrapparat, HUDSON.....	299
GREGOIRE, Darm- u. Gewebefasszange.....	538	Haken, COTTLE.....	447, 447/1	Handbohrapparat, KIRSCHNER.....	299
GREGORY, Profundaklemme.....	517	Haken, GELPI.....	193	Handbohrapparat, MOORE.....	298
GREVEN, Ohrzängchen.....	414	Haken, HARGIS.....	463/6	Handbohrapparat, RALK.....	300
Griff, Kehlkopfspiegel.....	473	Haken, HARRINGTON.....	193	Handbohrapparat, REDA.....	300
Griff, Meißel.....	266	Haken, HOFER.....	465	Handbohrapparat, STILLE.....	298
Griff, Osteotome.....	266	Haken, ITPERSON.....	477	Handgriff.....	300
Griff, SCHERBAK.....	575	Haken, JACKSON.....	476	Handgriff Dreibackenspannfutter.....	300
Griff, Skalpell.....	38 - 41	Haken, KELLY.....	193	Handgriff, NABATOFF.....	201
Griff, Skalpell Mini.....	41	Haken, KIRSCHNER.....	185, 187	Handgriff, Stabinstrumente f. Tracheotomie.....	475
Griff, Stabinstrumente, Tracheotomie.....	475	Haken, LOVE.....	465	Handwaschbürste.....	611
Griff, Uterus-Biopsiezangen.....	591	Haken, MASING.....	447	HANK, Uterus-Dilatator.....	580
GROSS, Ohrlöffel.....	409	Haken, MASING-NEIVERT.....	447	HARGIS, Raspator.....	463/2
GROSS-MAIER, Kornzange.....	134	Haken, NAGER.....	465	HARGIS, Unterkieferhaken.....	463, 463/6
GRUBER, Ohrspekula.....	399	Haken, NEWS.....	477	HARGIS, Wundhaken.....	463
GUILLEN, Saugraspatorium.....	433/1	Haken, OBWEGESER.....	460, 461/1	HARKEN, Aurikelklemme.....	503
Gummibirne, POLITZER.....	406	Haken, YOUNG.....	550	HARMS, Sonde.....	381
Gummiringe-Ligatur, McGIVNEY.....	568	Haken, RAMUS.....	461	HARRINGTON, Bronchusklemme.....	490
GUTHRIE, Hauthäkchen.....	148/2	Haken, SCHOENBORN.....	479	HARRINGTON, Haken.....	193
GUYON, Arterienklemme.....	122	Haken, SCOVILLE.....	196	HARRINGTON, Wundhaken.....	147
GUYON, Dilatationsbougie.....	554	Haken, SMELLIE.....	605	HARRINGTON-PEMBERTON, Wundhaken.....	147
GUYON, Katheter-Einführungsinstrument.....	554	Haken, SPINA-NASALIS.....	461	HARTMANN, Arterienklemme.....	104

HARTMANN, Fremdkörperzängchen	412	Hochfrequenz-Chirurgie	628, 629	HOUSE, Kürette	420
HARTMANN, Nasenspekula	422	HOEN, Dura-Dissektor	333	HOUSE, Mikro-Messsonde	420
HARTMANN, Nasenzange	427	HOESEL, Nadelhalter	213	HOUSE, Saugrohr	337/2
HARTMANN, Ohrkatheter	408	HOFFER, Wundhaken	465	HOWARTH, Septumlevator	438
HARTMANN, Ohrspekula	399	HOFFMANN, Schlauchklemme	624	HUBER, Universalgriff	472
HARTMANN, Ohrzängchen	411	Hohlmeißel	259, 264	HUDSON, Handbohrapparat	299
HARTMANN, Polypenzange	424	Hohlmeißel, ALEXANDER	259	HUDSON, T-Handgriff	300
HARTMANN, Stimmgabel	403	Hohlmeißel, COBB	262	HULKA, Hakenzange	583
HARTMANN, Zungendrücker	452	Hohlmeißel, HIBBS	265	HUMBY, Dermatom	50
HARTMANN-HALLE, Nasenspekula	421	Hohlmeißel, KILLIAN	442/1	HUNTER, Splitterpinzette	91
HARTMANN-HOFFMANN, Fremdkörperzängchen	412	Hohlmeißel, LEXER	263	HURD, Tonsillen-Dissektor	465
HARTMANN-WULLSTEIN, Fremdkörperzängchen	412	Hohlmeißel, LEXER-Mini	263	Hypophysenkürette, RAY	334
HASSON, Wundhaken	143	Hohlmeißel, NOVOTEX	264	Hypophysenpinzette, ADSON	334
HAUGH, Mikro-Ohrzängchen	414	Hohlmeißel, PARTSCH	259	Hypophysenzange	341
Hauthäkchen, COTTLE	447/1	Hohlmeißel, SMITH-PETERSEN	261	Hysterektomieklammer, HEANEY	126
Hauthäkchen, COTTLE-NEIVERT	448	Hohlmeißel, STILLE	260	Hysterektomieklammer, HEANY-BALLENTINE	127
Hauthäkchen, FOMON	447/1	Hohlmeißel, WEST	442/1	Hysterektomieklammer, HOLZBACH	126
Hauthäkchen, FRAZIER	148/2	Hohlmeißel, ZIELKE	264	Hysterektomieklammer, MAINGOT	123/1, 123/2
Hauthäkchen, FREER	448	Hohlmeißel, ADSON	236	Hysterektomieklammer, ROGERS	127
Hauthäkchen, GILLIES	448	Hohlmeißelzange, BANE-HARTMANN	237	Hysterektomieklammer, SEGOND	125
Hauthäkchen, GRAEFE	148/2	Hohlmeißelzange, BEYER	237	Hysterektomieklammer, SEGOND-LANDAU	125
Hauthäkchen, GUTHRIE	148/2	Hohlmeißelzange, BLUMENTHAL	236	Hysterektomieklammer, WERTHEIM	124, 128
Hauthäkchen, JOSEPH	149	Hohlmeißelzange, BÖHLER	238	Hysterektomieschere, WERTHEIM	63
Hauthäkchen, KILNER	608	Hohlmeißelzange, CLEVELAND	235		
Hauthäkchen, KLAPP	150	Hohlmeißelzange, ECHLIN	240	I	
Hauthäkchen, KLEINERT-KUTZ	149	Hohlmeißelzange, FRIEDMAN	234	I.U.D., Extraktionshaken	593
Hauthäkchen, LAHEY	149	Hohlmeißelzange, FRIEDMAN-Micro	234	Impaktor	322/1
Hauthäkchen, REDA	150	Hohlmeißelzange, FRIEDMAN-Mini	234	Impulschüssel	230/18
Haut-Trephinen, KEYE	608	Hohlmeißelzange, FRYKHOLM	240	INGE, Wirbelkörperspreizer	339
HAYES, Darmklemme	545	Hohlmeißelzange, JANSEN	237	INGROWN, Nagelinstrument	612/1
HAYES, Rektum-Anastosenklemme	545	Hohlmeißelzange, KLEINERT-KUTZ	237	Injektionskanüle	36
HEANEY, Hysterektomieklammer	126	Hohlmeißelzange, LEKSELL (STILLE)	240	INSTRU-CARE, Instrumentenöl	635
HEANEY, Nadelhalter	210	Hohlmeißelzange, LEMPERT	237	Instrumente f. Tracheotomie	475
HEANY, Biopsiekürette	587	Hohlmeißelzange, LUER	236	Instrumentenkasten	617
HEANY, Wundhaken	164	Hohlmeißelzange, MARQUARDT	239	Instrumentenöl, INSTRU-CARE	635
HEANY-BALLENTINE, Hysterektomieklammer	127	Hohlmeißelzange, MAYFIELD	238	Insufflationskanüle, VERESS	206
HEATH, Fadenschere	66	Hohlmeißelzange, MEAD	235	Intraorale Retraktoren	463/1, 463/4
HEATH, Hammer	273	Hohlmeißelzange, OLIVECRONA	237	Inzisionsschere	52
HEBRA, Chalazionskürette	377	Hohlmeißelzange, RUSKIN	239	IOWA, Hakenzange	584
HEGAR, Uterus-Dilatator	578, 579	Hohlmeißelzange, SAUERBRUCH	240	IOWA, Nadelführer	206
HEGENBARTH, Wundklammerpinzette	224	Hohlmeißelzange, SCAGLIETTI	240	IRIS, Schere	54/2
HEIFETZ, Hirnspatel	369	Hohlmeißelzange, SEMB	240	Irisschere, KNAPP	55
HEIMING, Nierensteinzange	536	Hohlmeißelzange, SMITH-PETERSEN	238	Irisschere, LITTLER	55
HEISS, Arterienklemme	112	Hohlmeißelzange, STELLBRINK	234	IRIS, Supercuttschere	72
HEISTER, Mundsperrer	454	Hohlmeißelzange, STILLE-LUER	239	Irishäkchen, O'CONNOR	375
Hemilaminektomiespreizer, DARLING	178	Hohlmeißelzange, STILLE-RUSKIN	239	Irishäkchen, WIENER	375
HENKE, Tonsillenelevator	465	Hohlmeißelzange, ZAUFAL-JANSEN	238	Irismesser, DEAN	372
HENLEY, Wundspreizer	170	Hohlsonde	199	Irismesser, KNAPP	372
HENNIG, Gipsspreizer	232	Hohlsonde, BRODIE	199	Irismesser, ZIEGLER	372
HEPA-Filter	231/1	Hohlsonde, DOYEN	199	Irispinzette, BARRAQUER	384
HEPP-SCHUIDEL, Schere	78	Hohlsonde, NELATON	199	Irispinzette, BARRAQUER-KATZIN	384
HERCULES, Drahtkniefzange	320/1 - 320/3	HOHMANN, Knochenhebel	284, 285	Irispinzette, BISHOP-HARMAN	386
HERRICK, Nierenstielklemme	123	HOHMANN-Mini, Knochenhebel	286	Irispinzette, BONN	387
HESS, Irispinzette	384	HOKE, Flachmeißel	265	Irispinzette, FISCHER	384
HESS, Kapselpinzette	391	HOKE, Osteotome	265	Irispinzette, FOERSTER	383
HESS, Nervwurzelhaken	329/1	HOLINGER, OP-Laryngoskop	37	Irispinzette, GILL	384
HEYMANN, Nasenschere	58	HOLLINGER, Lichtträger	37	Irispinzette, GILL-HESS	384
HEYMANN, Septumzange	425	HOLSHER, Nervwurzelhaken	329/1	Irispinzette, GRAEFE	382
HEYMANN-KNIGHT, Polypenzange	425	HOLTH, Kapselstanze	380	Irispinzette, HESS	384
HEYWOOD-SMITH, Hämmorrhoidalzange	567	HOLZBACH, Hysterektomieklammer	126	Irispinzette, STEVENS	383
HIBBS, Flachmeißel	265	HOLZHEIMER, Wundhaken	168	Irispinzette, TROUTMAN	384
HIBBS, Hohlmeißel	265	HOPKINS, Gipsmesser	233	Irisspatel, WECKER	378
HIBBS, Osteotome	265	HORGAN, Valve Bauchdeckenhalter	183	ISRAEL, Wundhaken	162
HIBBS, Wundhaken	164	HORIZON, Clipanlagezange	524, 525	ITERSON, Trachealhaken	477
HILL-FERGUSON, Rektal-Spekulum	560	Hornhautdissektor, GREEN	374, 375	IVES-FANSLER, Anuskop	562
Hirnmesser	48	Hornhautdissektor, PATON	373	IWANSON, Messgerät	624
Hirnspatel, CUSHING	336, 369	Hornhautmesser, ELSCHNIG	373		
Hirnspatel, DAVIS	337	Hornhautmesser, GILL	373	J	
Hirnspatel, HEIFETZ	369	Hornhautmesser, SATO	373	JACKSON-BURROWS, Bauchdeckenhalter	189/2
Hirnspatel, OLIVECRONA	336	Hornhautmesser, TOOK	373	JACKSON, Kehlkopfpinzette	471
Hirnspatelhalter, LEYLA	368/2	Hornhautschere, CASTROVIEJO	79	JACKSON, Laryngoskop	37
HIRSCHMANN, Anuskop	562	HORSLEY, Dura-Dissektor	333	JACKSON, Pinzette	471
HIRSCHMANN, Zyklodialysespatel	379	HOSEL, Wundhaken	167	JACKSON, Scheidenspekula	573

JACKSON, Sehnenfasszange	292	Kapselpinzette, CASTROVIEJO	391	KIRK, Hammer	270
JACKSON, Trachelhaken	476	Kapselpinzette, ELSCHNIG	391	KIRSCHNER, Bauchdeckenhalter	185, 187, 187/1
JACOBS, Hakenzange	583	Kapselpinzette, FUCHS	391	KIRSCHNER, Bohrdraht	306, 307
JACOBSON, Arterienklemme	105	Kapselpinzette, GILL-ARRUGA	390	KIRSCHNER, Extensionsbügel	312
JACOBSON, Dura-Haken	335	Kapselpinzette, HESS	391	KIRSCHNER, Führungshohlsonde	221
JACOBSON, Knopfsonde	335	Kapselpinzette, KALT	391	KIRSCHNER, Haken	185, 187
JACOBSON, Nadelhalter	215	Kapselpinzette, SCHWEIGGER	391	KIRSCHNER, Handbohrapparat	299
JACOBSON, scharfer Löffel	257	Kapselpinzette, TERSON	391	KIRSCHNER, Zughaken	313
JAEGER, Lanzenmesser	372	Kapselschere, RESANO	53/2	KIRSCHNER US, Extensionsbügel	312
JAEGER, Lidplatte	371	Kapselstanze, HOLTH	380	Klammeranlegezange, RANEY	327
JAMESON, Schielhaken	375	Katheter, COXETER	555	Klammerhalter	326
JAMESON, Strabismuspinzette	385	Katheter, Metall	555	KLAPP, Wundhaken	150
JANSEN, Hohlmeisselzange	237	Katheter, WALTHER	555	KLEINERT-KUTZ, Hauthäkchen	149
JANSEN, Nasenpinzette	424	Kathetereinführungsinstrument, GUYON	554	KLEINERT-KUTZ, Hohlmeissel	237
JANSEN, scharfer Löffel	257	Kathetereinführungzange, MAGILL	28	KLEINERT-KUTZ, Sehnenfassinstrument	294
JANSEN, Wundhaken	168	Katheterklemme, COOLEY	510	KLEINSASSER, Bruststütze	36
JANSEN-GRUENWALD, Nasenpinzette	424	KAYE, Face-Lift-Schere	73	KLEINSASSER, Fiberglas-Lichtträger	36
JARCHO, Hakenzange	583	Kegel, SCHULTZE Salpingograph	596	KLEINSASSER, Injektionskanüle	36
JAVID, Carotis-Shuntklemme	511	Kehldeckelhalter, REICHERT	471	KLEINSASSER, Rauchabsaugrohr	36
JENNINGS, Mundsperrler	454	Kehlkopfkanüle	470	KLEINSCHMIDT, Blinddarmklemme	544
JENSEN, Augenkanüle	394	Kehlkopfpinzette, JACKSON	471	Klemme, ALLEN	544
JOBSON-HORNE, Watteträger	203	Kehlkopfpolypenzange, FRAENKEL	471	Klemme, HAYES	545
JOHNS-HOPKINS, Anlegezange	104	Kehlkopfpolypenzange, JURASZ	471	Klemme, HOFFMANN	624
JOHNS-HOPKINS, Arterienklemme	120	Kehlkopfschere, KILLIAN	471	Klemme, KLEINSCHMIDT	544
JOHNS-HOPKINS, Bulldogklemme	104	Kehlkopfspiegel	473	Klemme, LANE	547
JOHNSON, Nadelhalter	211	Kehlkopfspiegel-Griff	473	Klemme, PAYR	548
JONES, Tuchklemme	132	Kehlkopfspiegel, MICHEL	423	Klemme, STOCKMANN	553/1
JONES-CLIP, Tuchklemme	132	Kehlkopfspritze	470	Klemme, STONE-WATT	545
JORGENSEN, Präparierschere	53	KEINSASSER, OP-Laryngoskop	35	Klemme, STRAUSS	553/1
JOSEF, Nasenmesser	434, 435	KEITH, Nadel	223	Klemme, Vasektomie	553/2
JOSEPH (LEWIS), Nasenraspel	443	KELLY, Anuskop	562, 563	Klemmenhalterung, DeMARTEL-WOLFSON	546
JOSEPH, Hauthäkchen	149	KELLY, Arterienklemme	106	Klemmenschießzange, DeMARTEL-WOLFSON	546
JOSEPH, Nasenmesser	434	KELLY, Gefäßschere	61	Klemmschloss, STONE-WATT	545
JOSEPH, Nasenraspel	443	KELLY, Proktoskop	563, 564	Klemmsockel	189
JOSEPH, Nasensäge	446	KELLY, Uterus-Polypenzange	585	Klinge	49
JOSEPH, Raspator	277	KELLY, Wundhaken	164, 193	Klinge-Skalpell	42
JOSEPH, Schere	54/1	KELLY-GRIP, Wundhaken	142	Klingenbrecher, CASTROVIEJO	45
JOSEPH, Septumelelevator	437	KELLY-RANKIN, Arterienklemme	106	Klingenbrecher, REDA	45
JUDD-ALLIS, Darmfasszange	538	Keratoplastik-Messer, BARRAQUER	373	Klingenbrecher, TROUTMAN-CHRIS	45
JUDD-MASSON, Blasenwundspreizer	552	Keratoplastik-Messer PAUFIQUE	373	Klingenentferner	42
JUERS, Mikro-Ohrzängchen	414	KERN, Knochenhalte zange	244	KLINIKUM BERLIN, Schlauchklemme	129
JURASZ, Kehlkopfpolypenzange	471	KERRISON, Stanze	428	KLINKENBERGH-LOTH, Gefäßschere	65/2
		KERVORKIAN, Biopsiekürette	587	KNAPP, Irismesser	372
		KEVORKIAN, Uterus-Biopsiezange	589, 591	KNAPP, Irisschere	55
		KEVORKIAN-PACIFIC, Uterus-Biopsiezange	592	KNAPP, Stariöffel	378
K		KEY, Elevator	282	KNAPP, Tränensackhäkchen	375
Kabel, bipolar	633	KEYES, Trepbine	608	KNAPP-LUER, Trachompinzette	393
KABIERESKE, Pulverbläser	405	Kieferhöhlenstanze, HAJEK-KOFLER	429, 431	KNIGHT, Septumzange	425
KADER, Bauch- u. Darmspatel	143/3	Kieferhöhlenstanze, KERRISON	428	Knochendraht	314
KALLMORGEN, Halter	573	Kieferhöhlentroktr, COAKLEY	204	Knochenfeile	294, 612/1
KALLMORGEN, Scheidenspekula	573	Kieferhöhlentroktr, DOUGLAS	204	Knochenhaken, VOLKMANN	156
KALT, Kapselpinzette	391	Kieferhöhlentroktr, LICHTWITZ	204	Knochenhalteklammer, GERSTER	250
KALT, Nadelhalter	214	Kieferhöhlentroktr, PIERCE	204	Knochenhalteklammer, LAMBERT-LOWMAN	249
KALT-ARRUGA, Nadelhalter	214	KIELLAND, Geburtszange	602	Knochenhalteklammer, LOWMAN	249
Kaltlichtklammer	601	KIELLAND-LUIKART, Geburtszange	603	Knochenhalteklammer, LOWMAN-HOGLUND	249
Kaltlichtträger, HOLLINGER	37	KILLIAN, Hohlmeissel	442/1	Knochenhalte zange	245, 247, 249
Kaltlichtträger, JACKSON	37	KILLIAN, Nasenspekula	423	Knochenhalte zange, BIRCHER-GANSKE	246
KANE, Nabelschnurklemme	605	KILLIAN, Septumelelevator	438, 439	Knochenhalte zange, DINGMANN	246
KANTROWITZ, Arterienklemme	119/1	KILLIAN, Septumschere	471	Knochenhalte zange, FARABEUF	243
Kanüle, Air Injection	394	KILLIAN, Spülkanüle	433, 433/1	Knochenhalte zange, FARABEUF-LAMBOTTE	243
Kanüle, BISHOP-HARMON	394/1	KILLIAN-CLAUS, Septumhohlmeissel	442/1	Knochenhalte zange, FERGUSSON	243
Kanüle, EICKEN (KILLIAN)	433	KILNER, Hauthäkchen	608	Knochenhalte zange, KERN	244
Kanüle, JENSEN	394	KILNER, Nadelhalter	212	Knochenhalte zange, LAMBOTTE	244
Kanüle, KILLIAN	433/1	KILNER, Nasenhaken	447/1	Knochenhalte zange, LANE	244
Kanüle, LACRIMAL	394	KILNER, Schere	54/1	Knochenhalte zange, LANGENBECK	243
Kanüle, McIntyre	394	KILNER, Supercuttschere	72	Knochenhalte zange, LEWIN	246
Kanüle, ROSEN	338	KILNER-DOUGHTY, Mundsperrler	456	Knochenhalte zange, MARTIN	246
Kanüle, Saugriff, ZÖLLNER u. WULLSTEIN	337/1	Kinder-Aortaklemme, SUBRAMANIAN	521	Knochenhalte zange, MEYER	248
Kanüle, SCHMID	338	Kinder-Aortaklemme, SUBRAMANIAN-MINUTURE	521	Knochenhalte zange, PATELLA	248
Kanüle, SIMCOE	394/2	Kinder-Atrauma-Gefäßklemme	526, 527	Knochenhalte zange, REDA	246, 247
Kanüle, VERRES	206	Kinder-Gefäßklemme	527	Knochenhalte zange, REILL	248
Kanüle, WAGENER-MOSHER	477	Kinder-Gefäßklemme, COOLEY	522	Knochenhalte zange, SEMB	243
Kappenzange, REDA	615	KIRBY-ARTHUR, Fixierpinzette	385	Knochenhalte zange, ULRICH	248
Kapsel fasszange, MILLIN	550, 551				
Kapselpinzette, ARRUGA	391				

Knochenhaltezange, VAN BUREN	249	Kornzange, ULRICH	135	Laminektomie-Zange, DECKER	341
Knochenhaltezange, VERBRUGGE	245	KÖRTE, Bauch- u. Darmspatel	143/3	Laminektomie-Zange, FERRIS-SMITH	343
Knochenhebel	282 - 286/2, 288	Krampfaderbesteck, NABATOFF	201	Laminektomie-Zange, LANDOLT	341/2
Knochenhebel, AUFRANC-COBRA	289	Kranioclast, BRAUN	607	Laminektomie-Zange, LOVE-GRUENWALD	340
Knochenhebel, BENNETT	283	Kranioclast, TARNIER	607	Laminektomie-Zange, OLDBERG	341/1
Knochenhebel, BLOUNT	288	KRAUSE, Aufsatz	472	Laminektomie-Zange, PEAPOD	341/1
Knochenhebel, BRISTOW	290	KRAUSE, Polypenschnürer	411, 433/2	Laminektomie-Zange, SCHLESINGER	342
Knochenhebel, BUCK-GRAMCKO	285	KRAUSE-VOSS, Polypenschnürer	433/2	Laminektomie-Zange, SPURLING	340
Knochenhebel, HOHMANN	284, 285	KRAYENBÜHL, Nervhäkchen	336	Laminektomie-Zange, WAGNER	343
Knochenhebel, HOHMANN Mini	286	Kreuzschlitzschraubenzieher, LANE	324	LANCASTER, Lidsperrer	371
Knochenhebel, KÖNIG	284	KRISTELLER, Halter	572	LANDAU, Scheidenspekula	577
Knochenhebel, LANE	290	KRISTELLER, Scheidenspekula	572	LANDOLT, Erukulationsschere	58
Knochenhebel, LANGE-HOHMANN	286	KROENIG, Zungenspatel	451	LANDOLT, Laminektomiezange	341/2
Knochenhebel, LANE-TRETHOWAN	290	KRONECKER, Unterbindungsnadel	219	LANDOLT, Tumorfasszange	341
Knochenhebel, MURPHY-LANE	283	Kronenschere, BEEBEE	68	LANE, Biegehebel	325
Knochenhebel, SMILLIE	291	Kropffasszange, LAHEY	479	LANE, Knochenhaltezange	244
Knochenhebel, TAYLOR	291	Kropfsonde, KOCHER	479	LANE, Knochenhebel	290
Knochenhebel, VERBRUGGE-MÜLLER	287	Kugelenkklöben, LEYLA	368/1	LANE, Knochenplatten-Haltezange	325
Knochen Nagel	309	KUGLEN, Hähchen	376	LANE, Kreuzschlitz-Schraubenzieher	324
Knochen Nagel, STEINMANN	307, 308	KÜMMEL, Bauch- u. Darmspatel	143/2	LANE, Magenquetschklemme	547
Knochenplattenhalte zange, LANE	325	KÜNTSCHER, Aufreiber	321	LANE, Pinzette	84
Knochenraspel	294	KÜNTSCHER, Extraktor	322	LANE, Schraubenhalte zange	325
Knochenraspel, PUTTI	294	KÜNTSCHER, Fertigschläger	321	LANE, Schraubenzieher	323
Knochen splitterzange, BÖHLER	241	KÜNTSCHER, Vorbohrer	321	LANE, Tuckklemme	133
Knochen splitterzange, COTTLE-KAZANJIAN	241	Kupplungskopf, LEYLA	368/1	LANE-TRETHOWAN, Knochenhebel	290
Knochen splitterzange, LISTON	241	Kürette	600, 612	LANG, Tränensack-Dissektor	378
Knochen splitterzange, McINDOE	241	Kürette, ANTRUM	435	LANGE, Aufsatz	472
Knochen splitterzange, RUSKIN-LISTON	241	Kürette, BLAKE	595	LANGE, Nasenflügelhähchen	448
Knochen splitterzange, SEMB	242	Kürette, BUMM	597	LANGE-HOHMANN, Knochenhebel	286
Knochen splitterzange, STAMM	241	Kürette, COAKLEY	449	LANGENBECK, Amputationsmesser	44
Knochen splitterzange, STILLE-HORSLEY	242	Kürette, COBB	252	LANGENBECK, Fingersäge	296
Knochen splitterzange, STILLE-LISTON	242	Kürette, FAULKNER	449	LANGENBECK, Fingerschützer	311
Knochen stanze, CITELLI	430	Kürette, FOX	608	LANGENBECK, Knochenhalte zange	243
Knochen stanze, OSTROEM	430	Kürette, GOURDET	599	LANGENBECK, Knorpelmesser	47
Knopfsonde	199	Kürette, HEANY	584	LANGENBECK, Nadelhalter	213
Knopfsonde, JACOBSON	335	Kürette, HEBRA	377	LANGENBECK, Ohrschlinge	409
Knorpel messer, LANGENBECK	47	Kürette, HOUSE	420	LANGENBECK, Raspator	275
Knorpelquetscher, COTTLE	440	Kürette, KEVORKIAN	587	LANGENBECK, Wundhaken	158, 159
Knorpelschere, McINDOE	65/1	Kürette, MEYHOEFER	377	LANGENBECK-GREEN, Wundhaken	153
KNOWLES, Verbandschere	70	Kürette, MOD. MUENCHEN	587	Lanzennmesser, JAEGER	372
Koagulationselektrode	629	Kürette, NOVAK	587	Lärmtrommel, BARANY	405
KOCHER, Arterienklemme	108	Kürette, PIFFARD	608	LARSEN, Sehnerfasspinzette	292
KOCHER, Blasen spatel	552	Kürette, RANDALL	587	Laryngoskop, HOLINGER	37
KOCHER, Darmklemme	540	Kürette, RAY	334	Laryngoskop, JACKSON	37
KOCHER, Kropfsonde	479	Kürette, RECAMIER	597	Laryngoskop, MILLER	30
KOCHER, Wundhaken	155, 159, 160, 163	Kürette, SCHRÖDER	595	Laryngoskop-Kaltlichtgriff, Batteriegriff	33
KOCHER-LANGENBECK, Wundhaken	159	Kürette, SIMS	597	Laryngoskop-Warmlicht, Batteriegriff	32
KOENIG, Führungshohlsonde	221/1	Kürette, THOMAS	599	Laryngoskop-Warmlichtgriff, Trafo-Anschluss	34
KOENIG, Nadel	223			Lateralspreizer	569
KOERTE, Wundhaken	162	L		LAWRENCE, Arterienklemme	119
Koffer, Gips säge	230/18	LA FORCE, Fremdkörp ernadel	374	LEBSCHKE, Sternummeißel	267
KOGAN, Endospekula	577	LA FORCE, Ringmesser	450	LEES, Bronchusklemme	504
Komedonenquetscher, SAALFELD	608	LA GRANGE, Zahnfleischschere	69	LEGUE, Blasenwund spreizer	553
Komedonenquetscher, SCHAMBERG	608	LA GRANGE, Supercuttschere	72	LEGUEU, Blasen spatel	552
Komedonenquetscher, UNNA	608	LABORDE, Trachealdilatator	476	LEKSELL (STILLE), Hohlmeißelzange	240
Komedonenquetscher, WALTON	608	LACRIMAL, Augenkanüle	394	LELAND-JONES, Gefäßklemme	495
Kompressorium, FELDHEIM	249	Ladekonus, RUDD	568	LEMPERT, Elevator	420
Komprimeter	295	LAHEY, Arterienklemme	120	LEMPERT, Hohlmeißelzange	237
KÖNIG, Knochenhebel	284	LAHEY, Kropffasszange	479	LEMPERT, scharfer Löffel	256
KÖNIG, Raspator	276	LAHEY, Wundhaken	157	LERICHE, Fasspinzette	83
KÖNIG, Wundhaken	153	LAMBERT, Chalzionspinzette	393	LERICHE, Arterienklemme	111
KOOS, Duramesser	335	LAMBERT-KAY, Anastomosenklemme	505	LERICHE, Bauchspatel	143/2
Kopfhautklammer, RANEY	327	LAMBERT-LOWMAN, Knochenhalteklammer	249	LERICHE, Darm spatel	143/2
Kopf schwartenzange, GAUSS	605	LAMBOTTE, Knochenhalte zange	244	LESTER, Fixationspinzette	389
Kornzange	135	LAMBOTTE, Osteotom	261	LEVINSON, Fremdkörp ernadel	374
Kornzange, BRYANT	137	LAMBOTTE, Raspator	274	LEWIN, Knochenhalte zange	246
Kornzange, CHERON	137	Laminektomie-Spreizer, CHERRY	488	LEWIS, Nasenraspel	443
Kornzange, COLLIN	137	Laminektomie-Spreizer, CASPAR	179, 180	LEXER-BABY, Präparierschere	53
Kornzange, DUPLAY	134	Laminektomie-Spreizer, MEYERDING	180	LEXER, Flachmeißel	263
Kornzange, GROSS-MAIER	134	Laminektomie-Spreizer, SCOVILLE	196	LEXER, Hohlmeißel	263
Kornzange, MAIER	134	Laminektomie-Spreizer, SCOVILLE-HAVERFIELD	196	LEXER-Mini, Hohlmeißel	263
Kornzange, PELKMANN	137	Laminektomie-Zange, CLOWARD	342	LEXER, Präparierschere	53
Kornzange, SIMS-MAIER	134	Laminektomie-Zange, CUSHING	340	LEYLA, Fixiervorrichtung	368/1

LEYLA, Haltearm	368/4	LUCAE, Hähchen	409	MAXI-GRASPER, Uterus-Biopsiezange	593
LEYLA, Hirnsattelhalter	368	LUCAE, Hammer	271	MAY, Ophthalmoskop UNI II	14
LEYLA, Kugelgelenkkloben	368/4	LUCAE, Ohrpinzette	410	MAYFIELD, Hohlmeißelzange	238
LEYLA, Kupplungskopf	368/4	LUCAE, Parazentese-Nadel	408	MAYO, Gallensteinlöffel	534
LEYLA, Retraktor-System	368 - 368/4	LUCAE, Stimmgabel	404	MAYO, Gallensteinsonde	534
LICHTENBERG, Nadelhalter	213	LUER, Hohlmeißelzange	236	MAYO, Pinzette	89
Lichtleiterkabel-Siebkorb	623	LUER, Trachealkanüle	479	MAYO, Präparierschere	52/1
Lichtträger	37	LUER, Wundhaken	140	MAYO, Sterilisierklammer	227, 624
Lichtträger, JACKSON	37	LUER-KOERTE, Gallensteinlöffel	533	MAYO, Supercuttschere	71
Lichtträger, HOLLINGER	37	Luftdusche, POLITZER	406	MAYO, Zungenspatel	451
LICHTWITZ, Kieferhöhlentroker	204	Luftpumpe	295	MAYO-ADAMS, Wundspreizer	171
Lidplatte, JAEGER	371	LUJKART, Geburtszange	603	MAYO-BLAKE, Gallensteinzange	530/2
Lidsperre, ARRUGA	370	LUJKART-BILL, Zughebel	604	MAYO-COLLINS, Wundhaken	141
Lidsperre, BARRAQUER	370	Lungenfasszange, LOVELACE	490	MAYO-GUYON, Arterienklemme	122
Lidsperre, BOWMAN	370	Lungenschere, CRAFOORD	65/2	MAYO-HABERISSER, Drahtzange	319
Lidsperre, CASTROVIEJO	371	Lungenspatel	489/2	MAYO-HEGAR, Nadelhalter	209
Lidsperre, CLARK	370	Lungenspatel, ALLISON	489/2	MAYO-NOBLE, Präparierschere	52/1
Lidsperre, CRITCHETT	370	LUNGSGAARD, Sklerotom	373	MAYO-ROBSON, Darmklemme	541
Lidsperre, GRAEFE	370	LUINIATSCHEK, Tamponstopfper	465	MAYO-STILLE, Präparierschere	52/1
Lidsperre, LANCASTER	371	Lupuskürette, FOX	608	MAYO-STILLE, Supercuttschere	71
Lidsperre, LIEBERMAN	371	Lupuskürette, PIFFARD	608	McDONALD, Elevator	283
Lidsperre, LISTER-BURCH	370	M		McCULLOUGH, Strabismuspinzette	385
Lidsperre, MELLINGER	370	Magen-Darmnähhäparat, PETZ	549	McGEE, Hähchen	419
Lidsperre, MELLINGER-AXENFELD	370	Magen-Darmklemme, LANE	547	McGEE, Mikro-Ohrzängchen	414
Lidsperre, MUELLER	371	Magen-Darmklemme, MIKULICZ	547	McGIVNEY, Hämorrhoidal-Ligator	568
Lidsperre, MURDOCK	370	Magen-Darmklemme, PAYR	548	McGIVNEY, Hämorrhoidal-Zange	568
Lidsperre, PARK	371	Magen-Darmklemme, PAYR	548	McINDOE, Knochensplitterzange	241
Lidsperre, SMITH	370	MAGILL, Kathetereinführungzange	28	McINDOE, Knorpelschere	65/1
Lidsperre, STEVENSON	371	MAIER, Kornzange	134	McINDOE, Pinzette	85
Lidsperre, WEEK	370	MALINGOT, Hysterektomieklammer	123/1, 123/2	McINTYRE, Augenkanüle	394
Lidsperre, WILLIAMS	370	MALTZ (COTTLE), Nasenraspel	444	McIVOR, Mundsperrerr	457
Lidsperre, ZIEGLER	371	MALTZ, Nasenraspel	443	McKENTY, Septumellevator	437, 438
LIEBERMAN, Lidsperre	371	Mammaria, Sternum-Sperrerr	487/1	McKENZIE, Anlegezange	326
Lidgur-Gummiringe, McGIVNEY	568	Mandrin, RUMEL-BELMONT	528	McKENZIE, Bohrer	299
Ligaturklemme, DeBAKEY	499, 500	Manometer	295	McLEAN, Geburtszange	603/1
Ligaturklemme, DeBAKEY-RUMEL	499	Manometer, SCHULTZE	596	McLEAN-LUIKART, Geburtszange	603/1
Ligaturschere	54	MAGNIE, Elevator	380	McLEAN-TUCKER, Geburtszange	603/1
Linsenaken, STEVENS	375	Markierungsinstrument, CONNIN-AMSLER	380	McLEAN-TUCKER-LUIKART, Geburtszange	603/1
Linsenmanipulator, BECHERT	379	Markraumborher	322	McPHERSON, Fadenpinzette	392
Lippenhalter	453, 451	MARQUARD, Hohlmeißelzange	239	MEAD, Hammer	271
Lippenhalter, CAWOOD-MINNESOTA	451	MARSHIK, Tonsillenfasspinzette	468	MEAD, Hohlmeißelzange	235
LISTER (SINUS) Tupferzange	137	MARTEL, Fasszange	110	Medizinbecher	621
LISTER, Supercuttschere	72	MARTIN, Beckenzirkel	605	Medizinlöffel	268, 621
LISTER, Verbandschere	69/1	MARTIN, Cartilageschere	65/1	MEEKER, Arterienklemme	119
LISTER-BURCH, Lidsperre	370	MARTIN, Knochenhaltezange	246	MEHDORN, Anlegepinzette	362
LISTON, Amputationsmesser	44	MARTIN, Uterussonde	586	MEHDORN, Gefäßspil	362
LITTON, Knochensplitterzange	241	MARTIN, Verbindungskabel	633	Mehrweck-Gefäßklemme	520
LITTAUER, Cilienpinzette	395	MARTIN, Wundspreizer	175/1	Mehrweck-Gefäßklemme, BAINBRIDGE	495/1, 495/2
LITTAUER, Fadenschere	66	MARTINI, scharfer Löffel	257	Mehrweck-Gefäßklemme, COOLEY	518 - 520
LITTAUER, Ohrzängchen	411	MASING, Elevator	437	Mehrweck-Gefäßklemme, GLOVER	515
LITTAUER, Polypenzange	425	MASING, Nasenhaken	447	Mehrweck-Gefäßklemme, DeBAKEY	495, 508, 514 - 517
LITTLE, Wundhaken	157	MASSON, Nadelhalter	210	Mehrweckschale	620
LITTLER, Irisschere	55	Maßband	25	Meissel, BRUNETTI	268
LITTLEWOOD, Darmfasszange	538	Maßstab, Metall	25	Meissel, CINELLI	441
LOCKHART-MUMMERY, Fistelsonde	200	Mastdarm-Biopsiezange, TURREL	567	Meissel, FREER	442/1
LOCKLIN, Zahnfleischschere	69	Mastdarm-Biopsiezange, YEOMAN	566, 567	Meissel, HAJEK	442/1
LOCKWOOD-ALLIS, Darmfasszange	538	Mastdarm-Spekula, ALAN-PARKS	561	Meissel, KILLIAN	442/1
Löffelzängchen	416	Mastdarm-Spekula, BARR	559	Meissel, KILLIAN-CLAUS	442/1
LONDON-COLLEGE, Zahnpinzette	93	Mastdarm-Spekula, BODENHAMMER	559	Meissel, SILVER	442
LOPEZ-REINKE, Tonsillen-Dissektor	465	Mastdarm-Spekula, CZERNY	559	Meissel, WEST	442/1
LORENZ, Verbandschere	70	Mastdarm-Spekula, MATHIEU	560	Meisselklinge	266
LORNA, Tuchklemme	133	Mastdarm-Spekula, PRATT	559	MELLINGER, Lidsperre	370
LOUTE, Drahtspanninstrument	315	Mastdarm-Spekula, SIMS	559	MELLINGER-AXENFELD, Lidsperre	370
LOVE, Nervwurzelhaken	329/2, 330	Mastdarm-Spekula, SCHULZE-BERGMANN	560	MENGHINI, Biopsiekannüle	206
LOVE, Wundhaken	465	MASTIN, Muskelklemme	479	Meniskusshaken, BLOUNT	289
LOVE-GRUENWALD, Laminektomiezange	340	MATHIEU, Fremdkörperzange	553/1	Meniskusmesser, NEFF	292
LOVELACE, Arterienklemme	109	MATHIEU, Mastdarmspekula	560	Meniskusmesser, SMILLIE	292
LOVELACE, Lungenfasszange	490	MATHIEU, Nadelhalter	213	MERCEDES, Thoraxsperrerr	489
LOWER, Arterienklemme	120	MATHIEU, Wundhaken	141	MERIAM, Zahnpinzette	93
LOWMAN, Knochenhalteklammer	249	MATHIEU-OLSEN, Nadelhalter	212	Messebecher	620
LOWMAN-HOGLUND, Knochenhalteklammer	249	MATSON, Raspator	279	Messer, Amputation	44
LUBET-BARBON, Nasentamponzange	424	MATSON-ALEXANDER, Raspator	279	Messer, BARKAN	373
LUC, Septumzange	426	MAUNDER, Mundkeil	459	Messer, BARRAQUER	373

Messer, BERENS.....	372
Messer, CASTROVIEJO.....	372
Messer, CONVERSE.....	435
Messer, COTTLE.....	435
Messer, DEAN.....	372
Messer, FREER.....	434
Messer, GRAFE.....	372
Messer, JAEGER.....	372
Messer, JOSEPH.....	434, 435
Messer, KNAPP.....	372
Messer, PAUFIQUE.....	373
Messer, PLESTER.....	418
Messer, POLITZER.....	408
Messer, REDA.....	435
Messer, ROSEN.....	418
Messer, SCHEIE.....	373
Messer, SCHUKNECHT.....	418
Messer, SEXTON.....	408
Messer, TABB.....	418
Messer, WHEELER.....	373
Messer, WULLSTEIN.....	418
Messer, ZIEGLER.....	372, 373
Messer, Zwischenknochen.....	44
Messgerät, IWANSON.....	624
Messinstrumente.....	594
Messschieber.....	26
Messsonde, HOUSE.....	420
Messzirkel, CASTROVIEJO.....	380
Metalkatheter.....	555
Metalkatheter, COXETER.....	555
METZENBAUM, Nadelhalter.....	211
METZENBAUM, Präparierschere.....	53 - 54
METZENBAUM, Supercutschere.....	71
MEYER, Knochenhaltezange.....	248
MEYERDING, Laminektomiespreizer.....	180
MEYERDING, Wundhaken.....	157, 177
MEYERDING, Wundspreizer.....	180
MEYHOEFER, Chalzionskürette.....	377
MICHEL, Kehlkopfspiegel.....	423
MICHEL, Wundklammern.....	224
MICHEL, Wundklammerpinzette.....	224
MICHEL, Wundklammerzange.....	224
Micro-FRIEDMANN, Hohlmeisselzange.....	234
Micro-HARTMANN, Arterienklemme.....	104
MICROVASCULAR, Nadelhalter.....	210
MIDDELDORF, Wundhaken.....	160
MIDDLETON-JANSEN, Septumzange.....	430
Mikro-chirurgische Pinzette.....	94
Mikro-chirurgische Pinzette, GOMEL.....	96
Mikro-Fasszängchen, Rohrschaft.....	415
Mikro-Kantüle, ZÖLLNER u. WULLSTEIN Sauggriff.....	337/1
Mikro-Löffelzängchen, Rohrschaft.....	416
Mikro-Löffelzängchen, WULLSTEIN.....	416
Mikro-Messsonde, HOUSE.....	420
Mikro-Ohrscheren, BELLUCCI.....	413, 417
Mikro-Ohrscheren, SHEA.....	413
Mikro-Ohrzängchen.....	413 - 416
Mikro-Ohrzängchen, COS.....	414
Mikro-Ohrzängchen, DIETER.....	414
Mikro-Ohrzängchen, GREVEN.....	414
Mikro-Ohrzängchen, HAUGH.....	414
Mikro-Ohrzängchen, JUERS.....	414
Mikro-Ohrzängchen, McGEE.....	414
Mikro-Rohrschaftzange REDA.....	474
Mikro-Schere, GOMEL.....	80
Mikro-Schere, HEPP-SCHUIDEL.....	78
MIKULICZ, Darmklemme.....	543
MIKULICZ, Peritoneumklemme.....	123
MIKULICZ, Wundhaken.....	163
MIKULICZ-BABY, Peritoneumklemme.....	123
MILLER, Laryngoskop.....	30
MILLER, Nasenraspel.....	444
MILLIGAN, Dura-Dissektor.....	332

MILLIN, Blasenperrerr.....	552, 553
MILLIN, Kapselasspinzette.....	550, 551
MILLIN, Prostatafasszange.....	550, 551
Mini-Bulldogklemme, DeBAKEY-DIETRICH.....	101
Mini-Bulldogklemme, DIETRICH.....	101
Mini-Schnellkupplungshandgriff.....	301
Mini-Skalpell.....	41
Mini-Skalpellgriffe.....	41
MINI-LAMBOTTE, Flachmeissel.....	262
MINI-TOWNSEND-DOWN, Biopsiezange.....	591
MINI-TOWNSEND-UP, Biopsiezange.....	591
MIXTER, Arterienklemme.....	116
MIXTER, Gallensteinzange.....	530/2
MIXTER-BABY, Arterienklemme.....	119/1
MIXTER-DeBAKEY, Gefäßsklemme.....	499/2
MIXTER-O-SHAUGNESSY, Arterienklemme.....	119/2
Mobilisierhaken, TESSIER.....	463/3
MOD, BONN, Nahtpinzette.....	387
MOD, TÜBINGEN, Fadenpinzette.....	392
MOD, TÜBINGEN, Nahtpinzette.....	387
MOD, MÜNCHEN, Biopsiekürette.....	587
MOD, VIENNA, Nasenspekula.....	421
MOELTGEN, Winkelmesser.....	25
MOGEN, Beschneidungsgerät.....	556
MOLLISON, Wundspreizer.....	171
MOLT, Raspatorium.....	276
Monopolare Elektrode.....	629
Monopolare Pinzette.....	634
MOOR, Gallensteinlöffel.....	531
MOORE, Handbohrapparat.....	298
MOORFIELD, Nahtpinzette.....	392
MORGAN, Proktoskop.....	565
MORITZ-SCHMIDT, Zungenspatel.....	452
MORRIS, Wundhaken.....	164
MORRIS-DeBAKEY, Aortaklemme.....	506
MORSE, Rippensperrer.....	484
MORSE-FAVALORO, Rippensperrer.....	484
Motorfilter.....	231/1
MOYNIHAN, Arterienklemme.....	120
MOYNIHAN, Gallensteinsonde.....	531
MOYNIHAN, Tuchklemme.....	133
Mukosamesser, FREER.....	434
MÜLLER, Approximator.....	364
MÜLLER, Gefäßscilip.....	365
MUELLER, Lidsperrerr.....	371
Mundkeil, MAUNDER.....	459
Mundsperrerr, DAVIS-BOYLE.....	455
Mundsperrerr, DAVIS-MEYER.....	457
Mundsperrerr, DENHART.....	454
Mundsperrerr, DINGMANN.....	456
Mundsperrerr, DOYEN-JANSEN (MOLT).....	454
Mundsperrerr, HEISTER.....	454
Mundsperrerr, JENNINGS.....	454
Mundsperrerr, KILNER-DOUGHTY.....	456
Mundsperrerr, McIVOR.....	457
Mundsperrerr, ROSER-KOENIG.....	454
MURDOCK, Lidsperrerr.....	370
MURPHY, Wundhaken.....	156
MURPHY-LANE, Elevator.....	283
MUSEUX, Hakenzange.....	583
Muskelhaken.....	267
Muskelklemme, MASTIN.....	479
Muskelpinzette, BERKE.....	389
Muskelpinzette, PRINCE.....	387
Muskelpinzette, SNELLEN.....	393
Muskelpinzette, TROUTMAN.....	389
Mutterschlüssel.....	313
MYLES, Nasenzange.....	427
Myomheber, DOYEN.....	594
Myommesser, SEGOND.....	594
Myrtenblattsonde.....	199

N	
NABATOFF, Krampfaderbesteck.....	201
Nabelschnurklemme, COLLIN.....	605
Nabelschnurklemme, KANE.....	605
Nabelschnurschere, BUSCH.....	64
Nabelschnurschere, MOD. USA.....	64
Nabelschnurschere, SCHUMACHER.....	64
Nadel, BARBARA.....	419
Nadel, chirurgisch.....	222
Nadel, REVERDIN.....	220
Nadel, ROSEN.....	419
Nadel, YOUNG-BOOMERANG.....	220
Nadeldose.....	615
Nadelelektrode, monopolar.....	628, 629
Nadelführer, IOWA.....	206
Nadelhalter, ADSON.....	211
Nadelhalter, ARRUGA.....	214
Nadelhalter, BABY-OLSEN-HEGAR.....	212
Nadelhalter, BABY-WEBSTER.....	208
Nadelhalter, BARRAQUER.....	216, 217
Nadelhalter, BARRAQUER-TROUTMAN.....	216
Nadelhalter, BAUMGARTNER.....	208
Nadelhalter, BOYNTON.....	214
Nadelhalter, BOZEMANN.....	211
Nadelhalter, BROWN.....	209
Nadelhalter, CASTROVIEJO.....	215, 216
Nadelhalter, COLLIER.....	208
Nadelhalter, CRILE.....	213
Nadelhalter, CRILE-MURRAY.....	209
Nadelhalter, CRILE-WOOD.....	209
Nadelhalter, DeBAKEY.....	210
Nadelhalter, DERF.....	208
Nadelhalter, FINOCHIETTO.....	211
Nadelhalter, GILLIES.....	212
Nadelhalter, HALSEY.....	208
Nadelhalter, HEANEY.....	210
Nadelhalter, HOESEL.....	213
Nadelhalter, JACOBSEN.....	215
Nadelhalter, JOHNSON.....	211
Nadelhalter, KALT.....	214
Nadelhalter, KALT-ARRUGA.....	214
Nadelhalter, KILNER.....	212
Nadelhalter, LANGENBECK.....	213
Nadelhalter, LICHTENBERG.....	213
Nadelhalter, MASSON.....	210
Nadelhalter, MATHIEU.....	213
Nadelhalter, MATHIEU-OLSEN.....	212
Nadelhalter, MAYO-HEGAR.....	209
Nadelhalter, METZENBAUM.....	211
Nadelhalter, MICROVASCULAR.....	210
Nadelhalter, NEIVERT.....	208
Nadelhalter, OLSEN-HEGAR.....	212
Nadelhalter, RYDER.....	210
Nadelhalter, SAROT.....	211
Nadelhalter, STEVENS.....	214
Nadelhalter, STRATTE.....	212
Nadelhalter, WANGENSTEEN.....	210
Nadelhalter, WEBSTER.....	208
Nadelkasten.....	615
NAEGELE, Geburtszange.....	603
Nagelausreisszange, RADOLF.....	297
Nageldoppelfeile.....	612/1
Nagelfeile.....	610
Nagelhaltzange.....	610, 613
Nagelinstrument, INGROWN.....	612/1
Nagelschere.....	609, 610, 614
Nagel-Set.....	609
Nagelsplittinstrument.....	612/1
Nagelzange.....	609, 612/2, 613, 614
Nagelzange, ANVIL.....	613
Nagelzange, TURNBULL.....	609
NAGER, Tonsillennadel.....	466
NAGER, Wundhaken.....	465

Nahtbesteck.....	226	Nervhaken, ADSON.....	329	Ohrspekula, HARTMANN.....	399
Nahtpinzette, CASTROVIEJO.....	392	Nervhaken, CRILE.....	328	Ohrspekula, POLITZER.....	399
Nahtpinzette, MOD. BONN.....	387	Nervhaken, CUSHING.....	328	Ohrspekula, RICHAU-HOLMGREN.....	400
Nahtpinzette, MOD. TUEBINGEN.....	387	Nervhaken, DANDY.....	328	Ohrspekula, SIEGLE.....	402
Nahtpinzette, MOORFIELD.....	392	Nervhaken, D'ERRICO.....	329/2	Ohrspekula, TOYNBEE.....	399
Nahtpinzette, St. MARTIN.....	392	Nervhaken, DeMARTEL.....	330	Ohrspekulahalter, LEYLA.....	368/3
Nasenflügelhäkchen, LANGE.....	448	Nervhaken, GRAHAM.....	329	Ohrspritze, REINER.....	406
Nasenhaken, AUFRICHT.....	447	Nervhaken, HESS.....	329/1	Ohrzängchen.....	413 - 416
Nasenhaken, CONVERSE.....	448	Nervhaken, HOLSHER.....	329/1	Ohrzängchen, COS.....	414
Nasenhaken, COTTLE.....	447/1	Nervhaken, LOVE.....	329/2, 330	Ohrzängchen, GREVEN.....	414
Nasenhaken, FOMON.....	447/1	Nervhaken, SACHS.....	329	Ohrzängchen, HARTMANN.....	411, 412, 424
Nasenhaken, KILLNER.....	447/1	Nervhaken, SCOVILLE.....	329/1, 330	Ohrzängchen, HARTMANN-HOFFMANN.....	412
Nasenhaken, MASING.....	447	Nervhaken, SMITHWICK.....	329	Ohrzängchen, HARTMANN-WULLSTEIN.....	412
Nasenhaken, MASING-NEVERT.....	447	Nervhaken, YASARGIL.....	330	Ohrzängchen, HAUGH.....	414
Nasenmeißel, WEST.....	442/1	Nervrädchen, WARTENBERG.....	25	Ohrzängchen, HEYMANN-KNIGHT.....	425
Nasennmesser, CONVERSE.....	435	Nervwurzelhaken, D'ERRICO.....	329/2	Ohrzängchen, JUERS.....	414
Nasennmesser, COTTLE.....	435	Nervwurzelhaken, HESS.....	329/1	Ohrzängchen, LITTAUER.....	411, 425
Nasennmesser, FREER.....	434	Nervwurzelhaken, LOVE.....	329/2, 330	Ohrzängchen, LUBET-BARBON.....	424
Nasennmesser, JOSEPH.....	434, 435	Nervwurzelhaken, SCOVILLE.....	329/1, 330	Ohrzängchen, McGEE.....	414
Nasenuolive, POLITZER.....	406	Neuro-chirurgische Schere.....	65	Ohrzängchen, NOYES.....	425
Nasenpinzette, JANSEN.....	424	Neuro-chirurgische Schere, STRULLY.....	65	Ohrzängchen, STRUEMPEL.....	412
Nasenpinzette, JANSEN-GRUENWALD.....	424	NEWS, Trachealhaken.....	477	Ohrzängchen, TILLEY.....	411
Nasenpinzette, TROELTSCH.....	424	Nierenklemme, GUYON.....	122	Ohrzängchen, WESTMACOTT.....	424
Nasensraspel, AUFRICHT.....	443	Nierenerschale.....	619	Ohrzängchen, WULLSTEIN.....	416
Nasensraspel, FOMON.....	444	Nierensteinklemme, HERRICK.....	123	OLDBERG, Laminektomie-Zange.....	341/1
Nasensraspel, JOSEPH.....	443	Nierensteinzange, HEIMING.....	536	OLIVECRONA, Drahtsäge.....	332
Nasensraspel, JOSEPH (LEWIS).....	443	Nierensteinzange, RANDALL.....	535	OLIVECRONA, Dura-Dissektor.....	332
Nasensraspel, LEWIS.....	443	Nierenstiellklemme, WERTHEIM-CULLEN.....	125	OLIVECRONA, Hirnspatel.....	336
Nasensraspel, MALTZ.....	443	NISSEN, Arterienklemme.....	113	OLIVECRONA, Hohlmeißelzange.....	237
Nasensraspel, MALTZ (COTTLE).....	444	NORFOLK/NORWICH, Wundspreizer.....	172	OLIVECRONA-TOENNIS, Anlegezange.....	326
Nasensraspel, MILLER.....	444	NORTHBENT, Fadenschere.....	66	OLLIER, Wundhaken.....	162
Nasensraspel, PEET.....	446	NOTO, Uterus-Polypenzange.....	585	OLSEN-HEGAR, Nadelhalter.....	212
Nasensraspel, WIENER.....	443	NOVAK, Biopsiekürette.....	587	OMBREDANNE, Hammer.....	273
Nasensäge, JOSEPH.....	446	NOVOTEX, Hohlmeißel.....	264	Ophtalmologie-Schere, AEBLI.....	58
Nasenschere.....	429	NOYES, Augenschere.....	75	Ophtalmologie-Schere, GRADLE.....	57
Nasenschere, COTTLE.....	59	NOYES, Polypenzange.....	425	Ophtalmologie-Schere, STEVENS.....	58
Nasenschere, FOMON.....	58	Nystagmusbrille, FRENZEL.....	20	Ophtalmoskop, MAY UNI II.....	14
Nasenschere, HEYMANN.....	58			OP-Laryngoskop, HOLINGER.....	37
Nasenspekula, COTTLE.....	423	O		OP-Laryngoskop, JACKSON.....	37
Nasenspekula, HARTMANN.....	422	Obduktions-Besteck.....	269	OP-Laryngoskop, KLEINSASSER.....	35
Nasenspekula, HARTMANN-HALLE.....	421	Oberarmmanschette.....	295	Organmesser.....	48
Nasenspekula, KILLIAN.....	423	Oberschenkelmanschette.....	295	Organ- und Gewebefäßzange, atrauma.....	111
Nasenspekula, MOD. VIENNA.....	421	OBWEGESER, Ahle.....	463, 463/3	osillierende Gipszange.....	230/10, 230/12
Nasenspekula, REDA.....	423	OBWEGESER, Blattosteotom.....	464/1	osillierende Gipszange m. Stababsauger.....	231
Nasenspekula, THUDICHUM.....	421	OBWEGESER, Elevator.....	461/1	Osteotom.....	259, 464
Nasenspekula, TIECK-HALLE.....	423	OBWEGESER, Osteotom.....	463, 464/1	Osteotom, COTTLE.....	440
Nasenspekula, VOLTOLINI.....	421	OBWEGESER, Raspator.....	462	Osteotom, EPKER.....	464/2
Nasentamponzange, LUBET-BARBON.....	424	OBWEGESER, Wundhaken.....	460, 461/1	Osteotom, FOMON.....	441
Nasentamponzange, WESTMACOTT.....	424	OCHSNER, Trokar.....	205	Osteotom, HIBBS.....	265
Nasenzange.....	431	O'CONNOR, Iriskäkchen.....	375	Osteotom, HOKE.....	265
Nasenzange, CAPLAN.....	428	OEHLER, chirurgische Pinzette.....	81/1	Osteotom, LAMBOTTE.....	261
Nasenzange, GRAIG.....	426	Ohrhebel, ZAUFAL.....	409	Osteotom, LEXER.....	263
Nasenzange, HARTMANN.....	427	Ohrhebel, ZAUFAL-JANSEN.....	409	Osteotom, MINI-LAMBOTTE.....	262
Nasenzange, MIDDLETON-JANSEN.....	430	Ohrkatheter, HARTMANN.....	408	Osteotom, NEVERT-ANDERSON.....	442
Nasenzange, MYLES.....	427	Ohrkürette, BUCK.....	407	Osteotom, OBWEGESER.....	463, 464/1
Nasenzange, RUBIN.....	428	Ohrküffel, GROSS.....	409	Osteotom, RUBIN.....	440
Nasenzange, SCHMEDEN.....	427	Ohrmesser, POLITZER.....	408	Osteotom, SHEEHAN.....	441
Nasenzange, STRUYCKEN.....	427	Ohrmesser, SEXTON.....	408	Osteotom, SMITH-PETERSEN.....	261
Nasenzange, TAKAHASHI.....	427	Ohrpinzette, JANSEN.....	424	Osteotom, STILLE.....	260
Nasenzange, WATSON-WILLIAMS.....	428	Ohrpinzette, JANSEN-GRUENWALD.....	424	Osteotom, WEST.....	442/1
Nasenzange, WEIL-BLAKESLEY.....	426	Ohrpinzette, LUCAE.....	410	Osteotomklinge.....	266
NEFF, Meniskusmesser.....	292	Ohrpinzette, TROELTSCH.....	410, 424	OSTROEM, Knochenstanze.....	430
NEGUS, Bruststütze.....	459	Ohrpinzette, WILDE (TROELTSCH).....	410	O'SULLIVAN-O'CONNOR, Bauchdeckenhalter.....	181
NEGUS, Tonsillenzange.....	467	Ohrschlinge, BILLEAU.....	409	O'SULLIVAN-O'CONNOR, Scheidenspekula.....	576
NEVERT, Nadelhalter.....	208	Ohrscherchen, BELLUCCI.....	413	Oszillierende Gipszange.....	230/10, 230/12
NEVERT-ANDERSON, Septummeißel.....	442	Ohrscherchen, SHEA.....	413	OTIS, Urethrotom.....	553
NELATON, Hohlsonde.....	199	Ohrscherchen, WULLSTEIN.....	417	Otoskop Diagnostik-Besteck, UNI I.....	13
NELSON, Gefäßspinzette.....	89	Ohrschlinge, LANGENBECK.....	409	OVERHOLT, Arterienklemme.....	114
NELSON, Trokar.....	205	Ohrschlinge, SHAPLEIGH.....	410	OVERHOLT-BABY, Arterienklemme.....	114
NELSON, Unterbindungsnadel.....	219	Ohrsonde, STACKE.....	199	OVERHOLT-GEISENDOERFER, Arterienklemme.....	114
NEONATAL, Atraumaklemme.....	523	Ohrspekula, BOUCHERON.....	399	OVERHOLT-MIXTER, Arterienklemme.....	115
Neonatal-Gefäßklemme, CASTANEDA.....	527	Ohrspekula, BRUENINGS.....	401		
Nervhäkchen, KRAYENBUEHL.....	336	Ohrspekula, GRUBER.....	399		

P	Pinzette, BISHOP-HARMAN	85	Pinzette, STILLE-BARRAYA	88	
PALMER-POZZI, Hakenzange.....	582	Pinzette, BONACCOLTO	385	Pinzette, St. MARTIN.....	392
Parametriummklemme, REDA	128/1	Pinzette, BONNEY	88	Pinzette, STRASSBURGER MODELL	89
Parametriumschere TC.....	63	Pinzette, BROPHY	84	Pinzette, TAYLOR	87
Parazentesenadel, LUCAE	408	Pinzette, BROWN	83	Pinzette, TERSON	391
Parazentesenadel, POLITZER	408	Pinzette, CARMALT	91	Pinzette, TROELTSCH	424
PARK, Lidsperre	371	Pinzette, CASTROVIEJO	390 - 392	Pinzette, TROUTMAN	389
PARKER, Wundhaken	139	Pinzette, COLLIN-DUVAL	85	Pinzette, Tumor.....	97
PARKER-LANGENBECK, Wundhaken.....	141	Pinzette, COTTLE	410	Pinzette, Uhrmacher.....	90
PARTSCH, Flachmeißel	259	Pinzette, CUSHING	83	Pinzette, Ultra-light	95
PARTSCH, Hammer	271	Pinzette, CUSHING-TAYLOR	87	Pinzette, USA	81/1
PARTSCH, Hohlmeißel.....	259	Pinzette, DASTOOR	386	Pinzette, WAGENSTEEN	89
PASSOW, Blutstillungsmeißel	260	Pinzette, DAVIS	227	Pinzette, WAUGH	83
PATELLA, Knochenhaltezange	248	Pinzette, DeBAKEY	98, 99	Pinzette, WILDE (TROELTSCH).....	410
PATON, Hornhautdissektor	373	Pinzette, DESMARRÉS	393	Pinzette, YASARGIL	97
PAUFIQUE, Fadenpinzette	392	Pinzette, DOUGLAS	395	PIPER, Geburtszange	604
PAUFIQUE, Keratoplastik-Messer	373	Pinzette, DUEHRSEN	84	Pistole f. Reinigung	626
PAYR, Darmquetschklemme	548	Pinzette, DURANTE	88	Plastik-Hammer	271
PAYR, Führungshohlsonde	221/1	Pinzette, DUVAL	85	Plazentabecken	621/1
PAYR-BABY, Darmquetschklemme	548	Pinzette, ELSCHNIG	389, 391	PLESTER, Messer	418
PEAN, Arterienklemme	108, 110	Pinzette, FEILCHENFELD	91	PLESTER, Saugrohr	338
PEAPOD, Rongeur	341/1	Pinzette, FERRIS-SMITH	85	PLESTER, Wundspreizer	171
PECK-JOSEPH Präparierschere	74	Pinzette, FISCHER	384	POLITZER, Gummibirne	406
PEDERSON, Scheidenspekula	570	Pinzette, FOERSTER	383	POLITZER, Luftdusche	406
PENFIELD, Dissektor.....	333	Pinzette, FUCHS	391	POLITZER, Nasenolive	406
PEERS, Tuckklemme.....	132	Pinzette, GERALD	85, 86	POLITZER, Ohrmesser	408
PEET, Nasenraspel	446	Pinzette, GILL	384	POLITZER, Ohrspekula	399
PEET, Splitterzange	92	Pinzette, GILL-ARRUGA	390	POLITZER, Parazentesse-Nadel	408
PELKMANN, Tupferzange	137	Pinzette, GILL-HESS	384	Polster f. Oberarm- u. Oberschenkelmanschette	295
Pelvis-Haken, St. MARKS	165	Pinzette, GILLIES	86	Polypenschlinge	411
Penisklemme, STOCKMANN	553/1	Pinzette, GOMEL	96	Polypenschnürer, KRAUSE	411, 433/2
Penisklemme, STRAUSS	553/1	Pinzette, GRADLE	395	Polypenschnürer, KRAUSE-VOSS	433/2
PENNINGTON, Arterienklemme	109	Pinzette, GRAEFE	83, 382, 389	Polypenschnürer, WILDE	411, 433/2
PENNINGTON, Septumelevator	438	Pinzette, GREEN	390	Polypenzange, BRUENINGS	425
PERCY, Retraktor	296	Pinzette, HESS	384, 391	Polypenzange, HARTMANN	424
Perforatorie, SMELLIE	607	Pinzette, HUNT	97	Polypenzange, HEYMANN	425
Peripheral-Gefäßsklemme, DeBAKEY	494	Pinzette, HUNTER	91	Polypenzange, HEYMANN-KNIGHT	425
Peripheral-Gefäßsklemme, LELAND-JONES	494	Pinzette, JACKSON	471	Polypenzange, JURASZ	471
Peritoneumklemme, FAURE	123	Pinzette, JAMESON	385	Polypenzange, KNIGHT	425
Peritoneumklemme, MIKULICZ	123	Pinzette, JANSEN	424	Polypenzange, LITTAUER	425
Peritoneumklemme, PHANEUF	123	Pinzette, JANSEN-GRUENWALD	424	Polypenzange, LUBET-BARBON	424
PERKINS, Wundspreizer	168	Pinzette, KALT	391	Polypenzange, NOYES	425
Perkussionshammer, BABINSKY	24	Pinzette, KIRBY-ARTHUR	385	Polypenzange, WESTMACOTT	424
Perkussionshammer, BERLINER	24	Pinzette, KNAPP-LUER	393	POOLE, Saugrohr	27
Perkussionshammer, BUCK	24	Pinzette, LANE	84	POST MORTEM	269
Perkussionshammer, TAYLOR	24	Pinzette, LERCHE	83	POTTS, Anastomosen-Klemme	493
Perkussionshammer, TROEMNER	24	Pinzette, LESTER	389	POTTS, Coarctations-Klemme	492
PERTHES, Pfiem	304	Pinzette, LITTAUER	395	POTTS, Gefäßklemme	492, 493
PIFFALDOZZA, Abortuskürette	606	Pinzette, LONDON-COLLEGE	93	POTTS-DeMARTEL, Gefäßschere	59
PETRI, Schale.....	620	Pinzette, LUCAE	410	POTTS-SMITH, anatomische Pinzette	81
PETZ, Magen- und Darmnähapparat	549	Pinzette, MAYO	89	POTTS-SMITH, chirurgische Pinzette	81
Pfiem	304	Pinzette, McCULLOUGH	385	POTTS-SMITH, Gefäßschere	61
Pfiem, PERTHES	304	Pinzette, McINDOE	85	POZZI-PALMER, Hakenzange	582
Phalagenmesser	44	Pinzette, MCPHERSON	392	Präparierschere	52
PHANEUF, Peritoneumklemme	123	Pinzette, MERIAM	93	Präparierschere, DEAVER	52
PIERCE, Kieferhöhlentrokär	204	Pinzette, Mikrochirurgie	94, 96	Präparierschere, JORGENSEN	53
PIERCE, Septumelevator	438	Pinzette, MOD. BONN	387	Präparierschere, LEXER	53
PIFFARD, Lupuskürette	608	Pinzette, MOD. TÜBINGEN	387, 392	Präparierschere, LEXER-BABY	53
PILLING, Clipanlegezange	524, 525	Pinzette, Monopolar	634	Präparierschere, MAYO	52/1
PINARD, Stethoskop	23	Pinzette, MOORFIELD	392	Präparierschere, MAYO-NOBLE	52/1
Pinzette, ADLERKREUTZ	84	Pinzette, NELSON	89	Präparierschere, MAYO-STILLE	52/1
Pinzette, ADSON	81/2, 82, 334	Pinzette, OCHSNER	88	Präparierschere, METZENBAUM	53/1
Pinzette, ADSON-BROWN	82	Pinzette, OEHLER	81/1	Präparierschere, METZENBAUM FINO	53/1
Pinzette, ADSON-DeBAKEY	81/2	Pinzette, PAUFIQUE	392	Präparierschere, PECK-JOSEPH	74
Pinzette, anatomisch	81	Pinzette, POTTS-SMITH	81	Präparierschere, TOENNIS-ADSON	65
Pinzette, ARRUGA	391	Pinzette, PRINCE	387	Präparierschere, WELLER	53/2
Pinzette, atrauma	98, 99	Pinzette, REDA	395	PRATT, Dilator	580
Pinzette, AYER	393	Pinzette, SCHWEIGGER	391	PRATT, Fasszange	110
Pinzette, BARRAQUER	384, 390, 395	Pinzette, SEMKEN	86	PRATT, Fistelsonde	563
Pinzette, BARRAQUER-KATZIN	384	Pinzette, SINGLEY	88	PRATT, Hakenzange	584
Pinzette, BEER	395	Pinzette, SNELLEN	393	PRATT, Mastdam-Spekula	559
Pinzette, BERKE	389	Pinzette, STEVENS	383	PRATT, Uterus-Dilatator	580
Pinzette, bipolar	630 - 632	Pinzette, STILLE	81	PRECISA, Blutdruckmessgerät	9

PRESBYTERIAN, Schlauchklemme	129	Raspel, GALLAHER	446	Ringmesser, LAFORCE	450
PRICE-THOMAS, Bronchusklemme	490	Raspel, JOSEPH	443, 446	Ringmesser, St. CLAIR-THOMSON	450
PRINCE, Muskelpinzette	387	Raspel, JOSEPH (LEWIS)	443	Rippenkontraktor, BAILEY	489/1
PRINCE, Tonsillenscherer	59	Raspel, MALTZ	443	Rippenkontraktor, BAILEY-BABY	489/1
PROBE AND PACKER	612	Raspel, MALTZ (COTTLE)	444	Rippenkontraktor, BAILEY-GIBBON	489/1
Profundaklemme, GREGORY	517	Raspel, MILLER	444	Rippenkontraktor, SELLOORS	489/1
Proktoskop, BENSAUDE	565	Raspel, PEET	446	Rippenscherer	480
Proktoskop, CHELSEA-EATON	563	Raspel, WIENER	443	Rippenscherer, BETHUNE	481
Proktoskop, FANSLER	564	Rauchabsaugrohr, KLEINSASSER	36	Rippenscherer, BRUNNER	481
Proktoskop, HIRSCHMANN	563	RAY, Hypophysenkürette	334	Rippenscherer, COLLIN	480
Proktoskop, IVES-FANSLER	563	RECAMIER, Uteruskürette	597, 598	Rippenscherer, CORYLLOS	480
Proktoskop, KELLY	563, 564	Recordspritze	596	Rippenscherer, GIERTZ-STILLE	481
Proktoskop, MORGAN	565	REDA, Amputationsmesser	44	Rippenscherer, GLUCK	480
Prostatafasszange, MILLIN	550, 551	REDA, Augenmagnet	395	Rippenscherer, SAUERBRUCH	481
Prostatahaken, YOUNG	550	REDA, Cilienpinzette	395	Rippenscherer, SAUERBRUCH-FREY	481
PROVIDENCE-HOSPITAL, Arterienklemme	106	REDA, EXCENTER, Verbandschere	69/2	Rippenscherer, STILLE	480
Pulverbläser, KABIERKE	405	REDA, Fadengabel	221	Rippensperrer, CHERRY	488
Pulverbläser, UNIVERSAL	405	REDA, Fingerringssäge	297	Rippensperrer, COOLEY	485, 487
Pumpe f. Komprimierer	295	REDA, Führungsohohlsonde	221/1	Rippensperrer, COOLEY-NEONATAL	485
Punktionskanüle, FRAZIER	337	REDA, Gipsspreizer	232	Rippensperrer, DeBOER	486
PUTTI, Knochenraspel	294	REDA, Handbohrapparat	300	Rippensperrer, FINOCHIETTO	482, 484
Pylorusspreizer, BENSON	544	REDA, Hauthäkchen	150	Rippensperrer, FINOCHIETTO-BABY	482
Q		REDA, Kappenzange	615	Rippensperrer, FINOCHIETTO-BURFORD	483
QUERVAIN, Elevator	275	REDA, Klingenbrecher	45	Rippensperrer, HAIGHT	487
QUINBY, Zahnfleischschere	67	REDA, Knochenhaltezange	246, 247	Rippensperrer, MORSE	484
QUIRE, Fremdkörperhebel	412	REDA, Mikro-Rohrschaftzange	474	Rippensperrer, MORSE-FAVALORO	484
QUISLING, Hammer	271	REDA, Nasenspekulum	423	Rippensperrer, RIENHOFF-FINOCHIETTO	486
R		REDA, Organ- u. Gewebefäßzange	111	Rippensperrer, TUFFIER	487
Rachiotom	267	REDA, Parametriumklemme	128/1	RITTER-HALLE, Stirnhöhliendilatator	433
RADOLF, Nagelausschneidzange	297	REDA, Parametriumschere	63	ROBB, Spatel	530/1
RAGNELL, Wundhaken	140	REDA, scharfer Löffel	256	ROBERTS, Arterienklemme	117
Rahmen, DENIS-BROWNE, Bauchdeckenhalter	185	REDA, Sichelmesser	435	ROCHARD, Bauchdeckenhalter	186
Rahmen, KIRSCHNER, Bauchdeckenhalter	185 - 187/1	REDA, Watteträger	203	ROCHARD, Fixiervorrichtung	186
Rahmen, O'SULLIVAN-O'CONNOR	576	REDON, Führungsnadel	207	ROCHESTER-CARMALT, Arterienklemme	109
RALK, Handbohrapparat	300	REES, Face-Lift-Schere	73	ROCHESTER-OCHSNER, Arterienklemme	108
RAMPLEY, Tupferzange	136	Reibahle	304	ROCHESTER-PEAN, Arterienklemme	108
RAMUS, Wundhaken	461	REICHERT, Kehldeckelhalter	471	ROEDER, Tuchklemme	132
RANDALL, Biopsiekürette	587	REILL, Knochenhaltezange	248	ROGER, Septumelevator	437
RANDALL, Nierensteinzange	535	REINER, Gipsmesser	233	ROGERS, Hysterektomieklammer	127
RANEY, Klammeranlagezange	327	REINER, Ohrspritze	406	ROGGE, Sterilisierzange	227
RANEY, Kopfhautklammern	45	Reinigungsaufsatz	626	Rohrschaftzange, REDA	474
Rasierklammer	45	Reinigungspistole	626	Rollenklemme	131
Rasiermesser	49	Rektal-Absaugrohr, BUJE	566	Rollenklemme, BÜLOW-GUNAR-HEY	130
Raspatorium	279	Rektal-Schnürer, WESTON	566	ROLLET, Extipationsmeißel	374
Raspatorium, ADSON	282	Rektal-Spekulum, SAWYER	560	ROLLET, Tränensackhäkchen	375
Raspatorium, ALEXANDER	276	Rektal-Spekulum, HILL-FERGUSON	560	Rongeur, CLOWARD	342
Raspatorium, COBB	280	Rektum-Anastosenklemme, HAYES	545	Rongeur, CUSHING	340
Raspatorium, DINGMANN	463, 463/3	Repositionszange, ROWE	459	Rongeur, DECKER	341
Raspatorium, DOYEN	278	RESANO, Darmklemme	542	Rongeur, FERRIS-SMITH	343
Raspatorium, FARABEUF	274	RESANO, Kapselschere	53/2	Rongeur, LANDOLT	341/2
Raspatorium, FARABEUF-COLLIN	274	Resektionsmesser	47	Rongeur, LOVE-GRUENWALD	340
Raspatorium, FOMON	277	Retraktor	463/1	Rongeur, OLDBERG	341/1
Raspatorium, GUILLEN	433/1	Retraktor, PERCY	296	Rongeur, PEAPOD	341/1
Raspatorium, HARGIS	463/2	Retraktoren, Intraoral	463/1, 463/4	Rongeur, SCHLESINGER	342
Raspatorium, JOSEPH	277	Retraktor-System, LEYLA	368 - 368/4	Rongeur, SPURLING	340
Raspatorium, KÖNIG	276	REVERDIN, Darmspatel	143/3	Rongeur, WAGNER	343
Raspatorium, LAMBOTTE	274	REVERDIN, Nadel	220	ROSE, Wundhaken	140
Raspatorium, LANGENBECK	275	REYNOLDS, chirurgische Schere	54/1	ROSEN, Messer	418
Raspatorium, MATSON	279	REYNOLDS, Supercutschere	72	ROSEN, Nadel	419
Raspatorium, MATSON-ALEXANDER	279	Rhinoplastikschere, FOMON	65/1	ROSEN, Saugkanüle	338
Raspatorium, MOLT	276	RIBBON, Bauch- u. Darmspatel	143/1	ROSER-KOENIG, Mundsperrer	454
Raspatorium, OBWEGESER	462	RICARD, Bauchdeckenhalter	191	ROSS, Aortahaken	148/1
Raspatorium, QUERVAIN	275	RICHARDSON, Wundhaken	142	ROUX-BABY, Wundhaken	140
Raspatorium, SEBILAU	275	RICHARDSON-EASTMAN, Wundhaken	142	ROUX, Wundhaken	140
Raspatorium, SEDILLOT	274, 275	RICHARDSON-GRIP, Wundhaken	142	ROUX, Wundhaken	139
Raspatorium, SELDIN	277	RICHNAU-HOLMGREN, Ohrspekula	400	ROWE, Repositionszange	459
Raspatorium, SEMB	278	RICHTER-HEATH, Wundklammerzange	224	RUBIN, Septummeißel	440
Raspatorium, WILLIGER	276	RIENHOFF-FINOCHIETTO, Rippensperrer	486	RUBIN, Septumzange	428
Raspatorium, MOLT	276	RIGBY, Bauchdeckenhalter	189/2	RUDD, Hämorrhoidal-Ligator	568
Raspel, AUFRICHT	443	Ri-MINI, Diagnostik-Besteck	17	RUMEL, Arterienklemme	117
Raspel, FOMON	444, 445	RING, Zungenspatel	455	RUMEL-BELMONT, Tourniquet	528
		Ringmesser, BARNHILL	450	RUMEL-DeBAKEY, Gefäßklemme	499
		Ringmesser, BECKMANN	450	RUSKIN, Hohlmeißelzange	239

RUSKIN-LISTON, Knochensplitterzange	241
RUSSEL-DAVIS, Zungenspatel	458
RUSSISCHES MODELL, Fasspinzette.....	85
RYDEL-SEIFFERT, Stimmgabel.....	404
RYDER, Nadelhalter	210
S	
Säge, GIGLI	332
Sägeblatt	230/14 - 230/17
Sägeblatt, Fingerringssäge	297
SAALFELD, Komedonenquetscher	608
SACHS, Dura-Dissektor	332
SACHS, Nervhaken	329
SAENGER, Abortuszange	606
Sagittalspreizer, SMITH.....	463/5
Salpingograph, SCHULTZE	596
SANVENERO, chirurgische Schere.....	54/1
SAROT, Arterienklemme	118
SAROT, Nadelhalter	211
SATINSKY, Gefässklemme	491
SATINSKY, Gefässschere	65/2
SATINSKY, Tangentialklemme	502
SATO, Hornhautmesser	373
Sattelhäkchen	151, 152
Sattelhäkchen, CUSHING	151, 152
Sattelhäkchen, DESMARRES.....	151
Sattelhäkchen, GIL-VERNET	152
SATTERLEE, Amputationssäge	296
SAUERBRUCH, Abfallzange.....	227
SAUERBRUCH, Hohlmeisselzange.....	240
SAUERBRUCH, Rippenschere	481
SAUERBRUCH, Wundhaken.....	164, 166
SAUERBRUCH-FREY, Rippenschere.....	481
Sauggriff, WULLSTEIN	338
Saugkanüle, ROSEN	338
Saugkanüle, SCHMID	338
Saugkürlette, NOVAK	587
Saugkürlette, RANDALL.....	587
Saugraspatorium, GUILLEN.....	433/1
Saugrohr	337/1
Saugrohr, ADSON.....	337
Saugrohr, ANDREW-PYNCHON.....	28
Saugrohr, BABY-YANKAUER.....	27
Saugrohr, BARON.....	336
Saugrohr, COOLEY	28
Saugrohr, DeBAKEY	28
Saugrohr, FERGUSSON	337
Saugrohr, FRAZIER/FERGUSSON	337
Saugrohr, HOUSE	337/2
Saugrohr, PLESTER.....	338
Saugrohr, POOLE	27
Saugrohr, ROSEN	338
Saugrohr, SCHMID	338
Saugrohr, YANKAUER	27
Saugrohr, YASARGIL.....	337/1
Saugrohr, ZÖLLNER.....	337/1
Saugschlauch	231
SAWTELL, Tonsillenzange	467
SAWYER, Rektal-Spekulum	560
SAYRE, Elevator	281
SCAGLIETTI, Hohlmeisselzange	240
SCALP-CONTOUR, Wundspreizer	169
Schädelhalter, CRUTCHFIELD	327
Schädelspalter	267
Schädelstanze, CONE.....	331
Schädelzange, DeVILBISS	332
SCHAEDEL, Tuchklemme	132
Schaft	230/4, 230/7
Schale, PETRI.....	620
Schälmesser, Tracheotomie	475
SCHAMBERG, Komedonenquetscher	608
Scharfer Löffel	255
Scharfer Löffel, BRUNS	251, 254

Scharfer Löffel, BUSHE.....	256
Scharfer Löffel, COBB.....	252
Scharfer Löffel, DAUBENSPECK	255
Scharfer Löffel, HALLE	253
Scharfer Löffel, JACOBSON	257
Scharfer Löffel, JANSEN	257
Scharfer Löffel, LEMPERT.....	256
Scharfer Löffel, MARTINI.....	257
Scharfer Löffel, REDA	256
Scharfer Löffel, SCHEDE	251
Scharfer Löffel, SCOVILLE	253
Scharfer Löffel, SPINAL	253
Scharfer Löffel, SPRATT.....	251
Scharfer Löffel, VOLKMANN	257
Scharfer Löffel, WILLIGER	255, 257
SCHEDE, scharfer Löffel	251
Scheidenspekula.....	569 - 577
Scheidenspekula, AUWARD	576
Scheidenspekula, BREISKY	577
Scheidenspekula, COLLIN	570
Scheidenspekula, CUSCO	570, 571
Scheidenspekula, DELEE	574
Scheidenspekula, DOYEN.....	574
Scheidenspekula, GRAVE	570
Scheidenspekula, JACKSON	573
Scheidenspekula, KALLMORGEN	573
Scheidenspekula, KRISTELLER	572
Scheidenspekula, LANDAU	577
Scheidenspekula, O'SULLIVAN-O'CONNOR.....	576
Scheidenspekula, PEDERSON	570
Scheidenspekula, SCHERBAK	575
Scheidenspekula, SEMM	571
Scheidenspekula, SIMS	573
Scheidenspekula, TRELAT	571
Scheidenspekula, VU-MORE	569
SCHIEI, Goniotomiemesser	373
SCH EINMANN, Aufsatz.....	472
SCHERBAK, Scheidenspekula	575
Schere, AEBLI	58
Schere, BABY-METZENBAUM	71
Schere, BARRAQUER	75
Schere, BEEBEE	68
Schere, BERGMANN.....	69/1
Schere, BETHUNE.....	481
Schere, BOETTCHER	59
Schere, BRAUN-STADLER	64
Schere, BRUNNER	481
Schere, BRUNS	70
Schere, BUSCH	64
Schere, CASTROVIEJO	79
Schere, COLLIN	480
Schere, COTTLE	56, 59
Schere, CORYLLOS	480
Schere, CRAFOORD	65/2
Schere, DEAN	59
Schere, DeBAKEY	60, 61
Schere, DIETRICH	60
Schere, DOYEN	63
Schere, DUBOIS.....	63
Schere, ESMARCH	69/2
Schere, FAVALORO	61
Schere, FERGUSSON	66
Schere, FOMON	58, 65/1
Schere, FREEMAN	74
Schere, GLUCK	480
Schere, GOLDMAN-FOX	67
Schere, GOMEL	80
Schere, GOOD.....	59
Schere, GORNEY	73
Schere, GRADLE	57
Schere, GRAEFE	56
Schere, Haut.....	610
Schere, HEATH.....	66

Schere, HEPP-SCH EIDEL	78
Schere, HEYMANN.....	58
Schere, IRIS	54/2, 72
Schere, JORGENSEN.....	53
Schere, JOSEPH	54/1
Schere, KAYE	73
Schere, KELLY	61
Schere, KILLIAN	471
Schere, KILNER.....	54/1
Schere, KILNER/RAGNELL	72
Schere, KLINKENBERGH-LOTH.....	65/2
Schere, KNAPP	55
Schere, KNOWLES	70
Schere, LA GRANGE.....	69, 72
Schere, LANDOLT	58
Schere, LEXER	53
Schere, LEXER-BABY	53
Schere, Ligatur, TC	54
Schere, LISTER	69/1, 72
Schere, LITTAUER.....	66
Schere, LITTLER	55
Schere, LOCKLIN	69
Schere, LORENZ	70
Schere, MARTIN	65/1
Schere, MAYO	52/1, 71
Schere, MAYO-NOBLE	52/1
Schere, MAYO-STILLE	52/1, 71
Schere, McINDOE	65/1
Schere, METZENBAUM	53/1, 54, 71
Schere, MIKRO	76
Schere, Nagel	609, 610
Schere, Neurochirurgie.....	65
Schere, NORTHBENT	66
Schere, NOYES	75
Schere, Parametrium.....	63
Schere, PECK-JOSEPH	74
Schere, POTTS-DeMARTEL	59
Schere, POTTS-SMITH	60, 61
Schere, PRINCE	59
Schere, QUINBY	67
Schere, REDA	77, 80
Schere, REDA EXCENTER	69/2
Schere, REES	73
Schere, RESANO	53/2
Schere, REYNOLDS.....	54/1, 72
Schere, SANVENERO	54/1
Schere, SATINSKY	65/2
Schere, SAUERBRUCH.....	481
Schere, SAUERBRUCH-FREY	481
Schere, SCHMIEDEN-TAYLOR	65/1
Schere, SCHUMACHER	64, 481
Schere, SEUTIN	69/2
Schere, SIEBOLD	62
Schere, SIMS	62
Schere, SMITH-US-ARMY.....	69/1
Schere, Standard.....	51
Schere, STILLE	480
Schere, STEVENS	58, 72
Schere, STRULLY	65
Schere, SYSTRUNK	66
Schere, THOREK	65/2
Schere, TOENNIS-ADSON	65
Schere, UNIVERSAL.....	67, 70
Schere, USA Mod.....	64
Schere, VANNAS	79
Schere, WAGNER	67, 72
Schere, WALDMANN.....	64
Schere, WECKER.....	75
Schere, WELLER	53/2
Schere, WERTHEIM	63
Schere, WESTCOTT	75
Schieblehre, TOWNLEY	26
Schlielhaken, GRAEFE	375

Schielhaken, JAMESON.....	375	Sehenschäler, BUNNELL.....	292	Siebschale.....	623
Schilddrüsenhaken, SCHOENBORN.....	479	SEIFERT, Aufsatz.....	472	SIEGLE, Ohrspekula.....	402
SCHIMMELBUSCH, Verbandstofftrommel.....	622	Sektionsnadel.....	268	Silberklammern.....	326
SCHINK, Dermatome.....	49	SELDIN, Raspor.....	277	Silikoneinlage, DAVIS-BOYLE.....	455
SCHIOETZ, Tonometer.....	394/2	SELECT, Verbindungskabel.....	633	Silikonschlauch, McIVOR.....	457
Schlauchhalterung.....	188	SELLHEIM, Geburtsöffel.....	607	SILVER, Dermatome.....	50
Schlauchklemme.....	129	SELLORS, Rippenkontraktor.....	489/1	SILVER, Septummeissel.....	442
Schlauchklemme, BÜLOW-GUNAR-HEY.....	130	SEMB, Bronchusklemme.....	491	SIMCOE, Spülkanüle.....	394/2
Schlauchklemme, HOFFMANN.....	624	SEMB, Hohlmeisselzange.....	240	SIMON, Uterusöffel.....	594
Schlauchklemme, KLINIKUM BERLIN.....	129	SEMB, Knochenhaltezange.....	243	SIMON, Wundhaken.....	164
Schlauchklemme, PRESBYTERIAN.....	129	SEMB, Knochensplittierzange.....	242	SIMPLEX, Schlauchklemme.....	624
Schlauchklemme, SIMPLEX.....	624	SEMB, Raspor.....	278	SIMPSON, Geburtszange.....	602
Schlauchverbindungsstück.....	600	SEMKEN, anatomische Pinzette.....	86	SIMPSON-BRAUN, Geburtszange.....	602
SCHLESINGER, Laminektomiezange.....	342	SEMKEN, chirurgische Pinzette.....	86	SIMPSON-LUIKART, Geburtszange.....	603
Schliessklemme, STONE.....	545	SEMM, Scheidenspekula.....	571	SIMS, gynäkologische Schere.....	62
Schlinge, Polypenschnürer.....	433/2	SENN-GREEN, Wundhaken.....	153	SIMS, Mastdarm-Spekula.....	559
Schlüssel, Meissel.....	266	SENN-MILLER, Wundhaken.....	143	SIMS, Scheidenspekula.....	573
Schlüssel, Osteotome.....	266	Septemzange, KNIGHT.....	425	SIMS, Sonde.....	586
Schlüsselpaar, Gips säge u. Autopsiesäge.....	230/18	Septemzange, HEYMANN.....	425	SIMS, Uterusdepressor.....	586
SCHMEDEN, Nasenzange.....	427	Septumhohlmeissel, FREER.....	442/1	SIMS, Uterusdilator.....	581
SCHMID, Gefäss- u. Spülkanüle.....	338	Septumhohlmeissel, HAJEK.....	442/1	SIMS, Uteruskürette.....	597, 598
SCHMIEDEN, Führungshohlsonde.....	221	Septumhohlmeissel, KILLIAN-CLAUS.....	442/1	SIMS, Uterussonde.....	586
SCHMIEDEN-DICK, Unterbindungsnadel.....	219	Septumelevator, BALLENGER.....	439	SIMS-MAIER, Kornzange.....	134
SCHMIEDEN-TAYLOR, Duraschere.....	65/1	Septumelevator, COTTLE.....	439	SINGLEY, Gewebefasspinzette.....	88
Schnellkupplungs-Handgriff.....	301	Septumelevator, COTTLE-JOSEPH.....	439	SINOSKOPIE-TROKAR.....	205
Schnellkupplungs-T-Handgriff.....	300, 301	Septumelevator, FREER.....	437, 439	SINSKEY, Häkchen.....	376
SCHNIDT, Tonsillenzange.....	467	Septumelevator, HAJEK-BALLENGER.....	439	SINUS, Septumelevator.....	438
SCHOENBORN, Schilddrüsenhaken.....	479	Septumelevator, HALLE.....	437	Sinuskopie-Zange.....	431
Schraubenhaltehülse.....	324	Septumelevator, HOWARTH.....	438	Skalpelle Mini.....	41
Schraubenhalte zange, LANE.....	325	Septumelevator, JOSEPH.....	437	Skalpelle, steril.....	43
Schraubenzieher, Ferrozellgriff.....	323	Septumelevator, KILLIAN.....	438, 439	Skalpеллgriff.....	38 - 42
Schraubenzieher, LANE.....	323, 324	Septumelevator, McKENTY.....	437, 438	Skalpеллgriff Mini.....	41
Schraubenzieher, WILLIAMS.....	323	Septumelevator, PENNINGTON.....	438	Skalpеллklingen.....	42
SCHRÖDER, Hakenzange.....	584	Septumelevator, PIERCE.....	438	Skalpеллklingen-Entferner.....	42
SCHRÖDER, Uterusöffel.....	595	Septumelevator, ROGER.....	437	SKENE, Hakenzange.....	582
SCHROEDER, Hakenzange.....	583	Septumelevator, SINUS.....	438	Sklerotom, GUYTON-LUNDSSGAARD.....	373
SCHROEDER (POZZI), Hakenzange.....	582	Septummeissel, CINELLI.....	441	Sklerotom, LUNDSSGAARD.....	373
SCHUBERT, Biopsiezange.....	588	Septummeissel, COTTLE.....	440	SLS, Cipanlegezange.....	524, 525
SCHUKNECHT, Messer.....	418	Septummeissel, FOMON.....	441	SLUDER-BALLENGER, Tonsillotom.....	470
SCHULTZE, Salpingograph.....	596	Septummeissel, FREER.....	439	SMELLIE, Haken.....	605
SCHULZE-BERGMANN, Mastdarm-Spekula.....	560	Septummeissel, NEIVERT-ANDERSON.....	442	SMELLIE, Perforatorie.....	607
SCHUMACHER, Aufsatz.....	472	Septummeissel, RUBIN.....	440	SMILLIE, Knochenheber.....	291
SCHUMACHER, Biopsiezange.....	588	Septummeissel, SHEEHAN.....	441	SMILLIE, Meniskusmesser.....	292
SCHUMACHER, Nabelschnurschere.....	64	Septummeissel, SILVER.....	442	SMITH, Lidsperrer.....	370
SCHUMACHER, Sternumschere.....	481	Septumosteotom, CINELLI.....	441	SMITH, Sagittalspreizer.....	463/5
SCHUMACHER, Uterus-Biopsiezange.....	589	Septumosteotom, FOMON.....	441	SMITH, Spreizer.....	463/5
Schüssel.....	619	Septumosteotom, SHEEHAN.....	441	SMITH, Spreiz zange.....	463
Schwammzange.....	136	Septumrichtzange, ASCH.....	449	SMITH US ARMY, Verbandschere.....	69/1
Schwammzange, FOERSTER.....	136	Septumrichtzange, WALSHAM.....	449	SMITH-BUIE, Analspreizer.....	561
Schwammzange, RAMPLEY.....	136	Septumschere, KILLIAN.....	471	SMITH-PETERSEN, Hohlmeissel.....	261
SCHWEIGGER, Kapselpinzette.....	391	Septumzange, BRUENINGS.....	425	SMITH-PETERSEN, Hohlmeisselzange.....	238
Schwingmesser, BALLENGER.....	436	Septumzange, GRAIG.....	426	SMITH-PETERSEN, Osteotom.....	261
SCOVILLE, Haken.....	196	Septumzange, LUC.....	426	SMITHWICK, Anlegezange.....	326
SCOVILLE, Laminektomiespreizer.....	196	Septumzange, MIDDLETON-JANSEN.....	430	SMITHWICK, Nervhaken.....	329
SCOVILLE, Nervwurzelhaken.....	329/1, 330	Septumzange, RUBIN.....	428	SNELLLEN, Muskelpinzette.....	393
SCOVILLE, scharfer Löffel.....	253	Sequesterzange.....	249	SNELLEN, Starschlinge.....	378
SCOVILLE-HAVERFIELD, Laminektomiespreizer.....	196	SERPENTINE-GRASPER, Fasszange.....	593	SOMER, Uterus-Fasszange.....	585
SCUDDER, Darmklemme.....	541	Set Doppel-Sägeblatt.....	230/7	Sonde.....	199, 335
SEBILAU, Raspor.....	275	Set Filtertüten.....	231/1	Sonde, BRODIE.....	199
SEDLLOT, Raspor.....	274, 275	Set Sägeblatt.....	230/5, 230/6	Sonde, COLLIN.....	586
Segment sägeblatt.....	230/5, 230/15	SEUTIN, Verbandschere.....	69/2	Sonde, DOYEN.....	199
SEGOND, Hysterektomie klemme.....	125	SEXTON, Ohrmesser.....	408	Sonde, FISH.....	199
SEGOND, Myommesser.....	594	Seziermesser, VIRCHOW.....	48	Sonde, HARMS.....	381
SEGOND-LANDAU, Hysterektomie klemme.....	125	SHAMBAUGH, Häkchen.....	419	Sonde, JACOBSON.....	335
Sehnenfassinstrument, BRAND.....	293	SHAPLEIGH, Ohrschlinge.....	410	Sonde, LOCKHART-MUMMERY.....	200
Sehnenfassinstrument, CAROLL.....	293	SHEA, Mikro-Ohrschere.....	413	Sonde, MARTIN.....	586
Sehnenfassinstrument, KLEINERT-KUTZ.....	294	SHEEHAN, Osteotom.....	441	Sonde, NELATON.....	199
Sehnenfasspinzette, LARSEN.....	292	SHEEHAN, Septummeissel.....	441	Sonde, PRATT.....	563
Sehnenfasszange.....	293	SHEETS, Augenkanüle.....	394/2	Sonde, SIMS.....	586
Sehnenfasszange, JACKSON.....	292	Sichelmesser, REDA.....	435	Sonde, STACKE.....	199
Sehnenführer, BUNELL.....	294	Sichelmesser, Tracheotomie.....	475	Sonde, VALLEIX.....	586
Sehnenhalte zange, STEINMANN.....	292	Siebkorb, Endoskope u. Lichtleiterkabel.....	623	Sonde, WATSON-CHEYNE.....	199
Sehenschäler, BRAND.....	294	Siebdin, gynäkologische Schere.....	62	Sonde, WORST.....	381

Sondenspitzen, NABATOFF	201	SPURLING, Laminektomiezange	340	STILLE-LUER, Hohlmeisselzange	239
Spannarm, flexibel, LEYLA	368/3	Sputumbecher	621/1	STILLE-RUSKIN, Hohlmeisselzange	239
Spannplatte	49	St. CLAIR-THOMSON, Ringmesser	450	STILLE-SHERMAN, Handbohrapparat	298
Spannschlüssel	313	St. MARKS, Wundhaken	165	Stimmgabel	403, 404
Spatel	203, 530/1, 612/1	St. MARKS-PELVIS, Haken	165	Stimmgabel, HARTMANN	403
Spatel, KOCHER	552	St. MARTIN, Nahtpinzette	392	Stimmgabel, LUCAE	404
Spatel, LEGUEU	552	STACKE, Ohrsonde	199	Stimmgabel, RYDEL-SEIFFERT	404
Spatel, ROBB	530/1	STAMM, Knochensplitterzange	241	Stirnhöhliendilatator, RITTER-HALLE	433
SPATULA AND PACKER	612	Standard, chirurgische Schere	51	Stirnlampe, CLAR	22
Spekula, BARR	559	STANDARD (NELSON) Trokar	204	Stirnspiegel, ZIEGLER	21
Spekula, BODENHAMMER	559	Standgefäß	620	STOCKMANN, Penisklamme	553/1
Spekula, BREISKY	577	Stanze, Aorta	528	STONE, Schließklamme	545
Spekula, COLLIN	570	Stanze, CITELLI	430	STONE-WATT, Darmklamme	545
Spekula, CUSCO	570, 571	Stanze, COLCLOUGH	344/1	STONE-WATT, Klemmschloss	545
Spekula, CZERNY	559	Stanze, FERRIS-SMITH-KERRISON	344, 344/2	Stössel	258, 259
Spekula, DELEE	574	Stanze, HAJEK-KOFLER	429, 431	Stössel, CASPAR	258
Spekula, DOYEN	574	Stanze, KERRISON	428	STRABISMUS, Schere	58
Spekula, FRIEDMANN	577	Stanze, ÖSTROEM	430	Strabismuspinzette, BONACCOLTO	385
Spekula, GRAVE	570	Stanze, Zirkular	432	Strabismuspinzette, DASTOOR	386
Spekula, HILL-FERGUSON	560	Stariöffel, DAVIEL	377	Strabismuspinzette, JAMESON	385
Spekula, JACKSON	573	Stariöffel, GRAEFE	377	Strabismuspinzette, McCULLOUGH	385
Spekula, JOLL (FRIEDMANN)	577	Stariöffel, KNAPP	378	STRANDELL-STILLE, Wundhaken	157
Spekula, KALLMORGEN	573	Starmesser, DEUTSCHMANN	371	STRASSBURGER, Pinzette	89
Spekula, KOGAN	577	Starmesser, GRAEFE	371	STRATTE, Nadelhalter	212
Spekula, KRISTELLER	572	starrer Haltearm, LEYLA	368/1	STRAUSS, Penisklamme	553/1
Spekula, LANDAU	577	Starschlinge, ARLT	378	STRUEMPEL, Fremdkörperzangchen	412
Spekula, MATHIEU	560	Starschlinge, SNELLEN	378	STRULLY, neuro-chirurgische Schere	65
Spekula, O'SULLIVAN-O'CONNOR	576	Starschlinge, WEBER	378	STRUYCKEN, Nasenzange	427
Spekula, PEDERSON	570	Starschlinge, WILDER	378	SUBRAMANIAN, Kinder-Gefäßklamme	521
Spekula, PRATT	559	Stativ	188	SUBRAMANIAN-MINIATURE, Kinder-Gefäßklamme	521
Spekula, SAWYER	560	Staubbeutel	231/1	Supercutschere	71
Spekula, SCHERBAK	575	Staubbinde, ESMARCH	296	Supercutschere, BABY-METZENBAUM	71
Spekula, SCHULZE-BERGMANN	560	Staubsauger	231	Supercutschere, FREEMAN	74
Spekula, SEMM	571	STAUDE-MOORE, Hakenzange	582	Supercutschere, GORNEY	73
Spekula, SIMS	559, 573	Stechbecken	621/1	Supercutschere, IRIS	72
Spekula, TRÉLAT	571	STEINMANN, Knochen Nagel	307, 308	Supercutschere, KAYE	73
Spekula, VU-MORE	569, 570	STEINMANN, Sehenhalte zange	292	Supercutschere, KILNER	72
SPENCER, Fadenschere	66	STELLBRINK, Hohlmeisselzange	234	Supercutschere, LISTER	72
SPENCER-WELLS, Arterienklamme	109	sterile Ersatzlinge	50	Supercutschere, MAYO	71
Sperrer, ALAN-PARKES	561	sterile Skalpell-Klingen	42	Supercutschere, MAYO-STILLE	71
Sperrer, DAVIS-BOYLE	455	Sterilisierkasten	616, 618	Supercutschere, METZENBAUM	71
Sperrer, DINGMANN	456	Sterilisierklammer, BUNT	227, 624	Supercutschere, REES	73
Sperrer, KILNER-DOUGHTY	456	Sterilisierklammer, MAYO	227, 624	Supercutschere, REYNOLDS	72
Sperrer, Mammaria	487/1	Sterilisiersiebschale	622	Supercutschere, STEVENS	72
SPINAL, scharfer Löffel	253	Sterilisierzange	227	Supercutschere, WAGNER	72
Spinalhaken, TAYLOR	291	Sterilisierzange, CHEATLE	227	SWEET, Anlegezange	326
SPINA-NASALIS, Wundhaken	461	Sterilisierzange, ROGGE	227	SYSTRUNK, chirurgische Schere	66
Spiralbohrer	302	Sterilisierzange, UNIVERSAL	227		
Spitze, YANKAUER Saugrohr	27	STERNBERG, Wangenhalter	453	T	
Splitterpinzette	91	Sternmeissel, LEBSCHKE	267, 480	TABB, Messer	418
Splitterpinzette, CARMALT	91	Sternschere, SCHUMACHER	481	Tablett	620
Splitterpinzette, FEILCHENFELD	91	Sternsperrer, Mammaria	487/1	TAKAHASHI, Nasenzange	427
Splitterpinzette, HUNTER	91	Stethoskop, ANESTOPHON	23	Tamponstopfer, LUNIATSCHEK	465
Splitterzange, ARCHER	92	Stethoskop, DUPLEX	23	Tamponzange, BOZEMANN	138
Splitterzange, PEET	92	Stethoskop, PINARD	23	Tamponzange, BOZEMANN-DOUGLAS	138
Splitterzange, STIEGLITZ	92	STEVENS, Irispinzette	383	Tangentialklamme, DeBAKEY	502
Splitterzange, VIRTUS (RALK)	92	STEVENS, Linsenhaken	375	Tangentialklamme, DeBAKEY-SATINSKY	502
SPRATT, scharfer Löffel	251	STEVENS, Nadelhalter	214	Tangentialklamme, SATINSKY	502
Spreizer, ALAN-PARKS	561	STEVENS, Sehnenschere	58	TARNIER, Geburtszange	604
Spreizer, BENSON	544	STEVENS, Supercutschere	72	TARNIER, Kranioclast	607
Spreizer, Lateral	569	STEVENS, Lidsperre	371	Taschenbesteck	226
Spreizer, LEGUEU	553	STIEGLITZ, Splitterzange	92	TAYLOR, chirurgische Pinzette	87
Spreizer, MILLIN	552	STILLE, Arterienklamme	122	TAYLOR, Haken	196
Spreizer, SMITH	463/5	STILLE, Flachmeissel	260	TAYLOR, Perkussionshammer	24
Spreizer, SMITH-BUIE	561	STILLE, Gipsschere	229	TAYLOR, Spinalhaken	291
Spreizer, THOMSON-WALKER	552	STILLE, Handbohrapparat	298	TC chirurgische Schere fein, REYNOLDS	54
Spreizzange, SMITH	463	STILLE, Hohlmeissel	260	TC chirurgische Schere, STANDARD	51
Spritze	407	STILLE, Osteotom	260	TC Nasenraspel, FOMON	445
Spritze gefüllt mit Fett	230/18	STILLE, Pinzette	81, 81/1	TC Pinzette, anatomisch	81
Spülkanüle, BISHOP-HARMON	394/1	STILLE, Rippenschere	480	TC Pinzette, chirurgisch	81/1
Spülkanüle, EICKEN (KILLIAN)	433	STILLE-BARRAYA, Gefäßspinzette	88	TC Pinzette, CUSHING	83
Spülkanüle, KILLIAN	433, 433/1	STILLE-HORSLEY, Knochensplitterzange	242	TC Pinzette, GILLIES	86
Spülkanüle, SIMCOE	394/2	STILLE-LISTON, Knochensplitterzange	242	TC Pinzette, SEMKEN	86

TC Pinzette, WAGENSTEIN	89	Tonsillenscherer, PRINCE	59	TUFFIER, Gewebefasszange	110
TC Schere, FREEMAN	74	Tonsillenschnürer, BRUENINGS	468	TUFFIER, Rippensperrer	487
TC Schere, GORNEY	73	Tonsillenschnürer, EVES	468	TUFFIER, Wundhaken	147
TC Schere, KAYE	73	Tonsillenschnürer, TYDING	469	Tumorfasszange, LANDOLT	341
TC Schere, PECK-JOSEPH	74	Tonsillenspritze	470	Tumorpinzette, YASARGIL	97
TC Schere, REES	73	Tonsillenzange, BALLENGER	467	Tupferzange, BRYANT	137
TEALE, Hakenzange	583	Tonsillenzange, BLOHMKE	467	Tupferzange, CHERON	137
TEBBETS, Wundhaken	197	Tonsillenzange, NEGUS	467	Tupferzange, COLLIN	137
Teleskop-Bohrdrahtstütze	299	Tonsillenzange, SAWTELL	467	Tupferzange, FOERSTER	136
TERSON, Kapselpinzette	391	Tonsillenzange, SCHNIDT	467	Tupferzange, LISTER (SINUS)	137
TESSIER, Haken	463/3	Tonsillenzange, TYDING	468	Tupferzange, PELKMANN	137
TESSIER, Mobilisierhaken	463/3	Tonsillenzange, WHITE	467	Tupferzange, RAMPLEY	136
T-Handgriff, HUDSON	300	Tonsillotom, SLUDER-BALLENGER	470	TURNBULL, Nagelzange	609
T-Handgriff, Schnellkupplung	300, 301	Tonsillotom, TYDING	469	TURREL, Mastdarmbiopsiezange	567
THIERRY, Geburtszange	603	TOOK, Hornhautmesser	373	TYDING, Tonsillenschnürer	469
THOMAS, Uteruskurette	599	Tourniquet, RUMEL-BELMONT	528	TYDING, Tonsillenzange	468
THOMAS-GAYLOR, Biopsiezange	588	TOWNLEY, Schieblehre	26	TYDING, Tonsillotom	469
THOMS-ALLIS, Darmfasszange	538	TOWNSEND, Uterus-Biopsiezange	591		
THOMSON-WALKER, Blasenwundspitzer	552	TOYBEE, Ohrspekula	399	U	
Thoraxsperrer, MERCEDES	489	Trachealhaken, BOSE	477	USA MOD., Nabelschnur-Schere	64
THOREK, Gallenblasenschere	65/2	Trachealdilatator, LABORDE	476	UCKERMANN, Watteträger	203
THUDICHUM, Nasenspekula	421	Trachealdilatator, TROUSSEAU	476	Uhmacher Pinzette	90
TIECK-HALLE, Nasenspekula	423	Trachealdilatator, TROUSSEAU-BABY	476	ULRICH, Knochenhaltezange	248
Tiefen-Messinstrument	594	Trachealhaken, ITERSON	477	ULRICH, Kornzange	135
Tiefensägeblatt	230/6, 230/16	Trachealhaken, JACKSON	476	ULTA-LIGHT, Pinzette, atrauma	95
TILLEY, Ohrzängchen	411	Trachealhaken, NEWS	477	UNI I, Diagnostik-Besteck	13
TISCHLER-DOWN, Uterus-Biopsiezange	591	Trachealkanüle, CHEVALIER-JACKSON	479	UNI III, Diagnostik-Besteck	15
TISCHLER-KEVORKIAN, Uterus-Biopsiezange	592	Trachealkanüle, LUER	479	UNIVERSAL, Drahtschere	67
TISCHLER-MORGAN, Uterus-Biopsiezange	590, 591	Trachealkanüle, WAGENER-MOSHER	477	UNIVERSAL, Endoskophalterung	188
TISCHLER-UP, Uterus-Biopsiezange	591	Trachealwundspitzer, BOSE	476	UNIVERSAL, Pulverbläser	405
Titan-Arterienklemme, CRILE	107	Trachompinzette, KNAPP-LUER	393	UNIVERSAL, Sterilisierzange	227
Titan-Arterienklemme, KELLY	106	Tränenkanaldilatator, CASTROVIEJO	381	UNIVERSAL, Trokar	204
Titan-Bulldogklemme	102	Tränenkanaldilatator, WILDER	381	UNIVERSAL, Verbandschere	70
Titan-Pinzette, DeBAKEY	99	Tränenkanaldilatator, ZIEGLER	381	Universalsgriff, HUBER	472
TOBOLD, Watteträger	203	Tränenkanalsonde, BOWMAN	381	Universelle Wundhakenhalterung f. Armsystem	188
TOBOLD, Zungendrucker	453	Tränensackdissektor, LANG	378	UNNA, Komedonenquetscher	608
TOENNIS, Arterienklemme	117	Tränensackhäkchen, KNAPP	375	Unterbindungsnadel	218
TOENNIS, Dura-Dissektor	332	Tränensackhäkchen, ROLLET	375	Unterbindungsnadel, COOPER	219
TOENNIS-ADSON, Schere	65	TRAVERS, Wundspitzer	172	Unterbindungsnadel, DESCHAMPS	218
TOHUKU, Tuchklemme	132	TRELAT, Scheidenspekula	571	Unterbindungsnadel, KRONECKER	219
Tonometer, SCHIOETZ	394/2	Trepine, KEYES	608	Unterbindungsnadel, NELSON	219
Tonsillennadel, CLAUS	466	TROELTSCH, Nasenpinzette	424	Unterbindungsnadel, SCHMIEDEN-DICK	219
Tonsillennadel, CLAUS-EICKEN	466	TROELTSCH, Ohrpinzette	410, 424	Unterkieferhaken, HARGIS	463, 463/6
Tonsillennadel, DUPUY-WEISS	466	TROEMNER, Perkussionshammer	24	Urethrotom, OTIS	553
Tonsillennadel, NAGER	466	Trokar, COAKLEY	204	US-ARMY, Wundhaken	141
Tonsillendissektor, HURD	465	Trokar, DOUGLAS	204	USA, anatomische Pinzette	81
Tonsillendissektor, LOPEZ-REINKE	465	Trokar, LICHTWITZ	204	USA Mod. Nabelschnurschere	64
Tonsillendissektor, YANKAUER	465	Trokar, NELSON	205	USA Modell, Verbindungskabel	633
Tonsillendraht	468	Trokar, OCHSNER	205	Uterusdilator, GOODELL	581
Tonsillenelevator, CARPENTER	465	Trokar, SINOSKOPIE	205	Uterusdilator, HANK	580
Tonsillenelevator, HENKE	465	Trokar, STANDARD (NELSON)	204	Uterusdilator, PRATT	580
Tonsillenfassspinzette, MARSCHIK	468	Trokar, UNIVERSAL	204	Uterusdilator, SIMS	581
Tonsillenfasszange, ABRAHAM	468	TROUSSEAU, Trachealdilatator	476	Uterusdilator, WYLIE	581
Tonsillenfasszange, BALLENGER	467	TROUSSEAU-BABY, Trachealdilatator	476	Uteruspolypenzange, DOYEN	585
Tonsillenfasszange, BLOHMKE	467	TROUTMAN, Irispinzette	384	Uteruspolypenzange, KELLY	585
Tonsillenfasszange, COLVER	467	TROUTMAN, Muskelpinzette	389	Uteruspolypenzange, NOTO	585
Tonsillenfasszange, MARSCHIK	468	TROUTMAN-CHRIS, Klingenbrecher	45	Uterus-Biopsiezange, ALEXANDER	589
Tonsillenfasszange, NEGUS	467	Tubenkatheter, SCHULTZE	596	Uterus-Biopsiezange, BABY-TISCHLER	592
Tonsillenfasszange, SAWELL	467	Tuchklemme	133	Uterus-Biopsiezange, BURKE	590
Tonsillenfasszange, SCHNIDT	467	Tuchklemme, BACKHAUS	132	Uterus-Biopsiezange, BURKE-BABY	590
Tonsillenfasszange, TYDING	468	Tuchklemme, BACKHAUS-CLIP	132	Uterus-Biopsiezange, EPPENDORFER	590
Tonsillenfasszange, WHITE	467	Tuchklemme, BALL AND SOCKET	133	Uterus-Biopsiezange, KEVORKIAN	589, 591
Tonsillennmesser, ABRAHAM	466	Tuchklemme, BERNHARD	133	Uterus-Biopsiezange, KEVORKIAN-PACIFIC	592
Tonsillennmesser, BRUENINGS	466	Tuchklemme, DOYEN	133	Uterus-Biopsiezange, MAXI GRASPER	593
Tonsillennmesser, CANFIELD	466	Tuchklemme, JONES	132	Uterus-Biopsiezange, MINI-TOWNSEND-DOWN	591
Tonsillennmesser, CARPENTER	465	Tuchklemme, JONES-CLIP	132	Uterus-Biopsiezange, MINI-TOWNSEND-UP	591
Tonsillennmesser, DOUGLAS	466	Tuchklemme, LANE	133	Uterus-Biopsiezange, SCHUMACHER	589
Tonsillennmesser, FISHER	466	Tuchklemme, LORNA	133	Uterus-Biopsiezange, TISCHLER-DOWN	591
Tonsillennadel	470	Tuchklemme, MOYNIHAN	133	Uterus-Biopsiezange, TISCHLER-KEVORKIAN	592
Tonsillenschere	59	Tuchklemme, PEERS	132	Uterus-Biopsiezange, TISCHLER-MORGEN	590, 591
Tonsillenschere, BOETTCHER	59	Tuchklemme, ROEDER	132	Uterus-Biopsiezange, TISCHLER-UP	591
Tonsillenschere, DEAN	59	Tuchklemme, SCHAEDEL	132	Uterus-Biopsiezange, TOWNSEND	591
Tonsillenschere, GOOD	59	Tuchklemme, TOHOKU	132	Uterus-Biopsiezange, WITTMANN	589

Uterus-Depressor, BRAUN.....	586	WAGENER-MOSHER, Trachealkanüle.....	477	WOLFF, Gipsabreisszange.....	233
Uterus-Depressor, SIMS.....	586	WAGENSTEEN, Gefäßspinzette.....	89	WOODSON, Dura-Dissektor.....	333
Uterus-Dilatator, GOODELL.....	581	WAGNER, Laminektomiezange.....	343	WORST, Sonde.....	381
Uterus-Dilatator, HANK.....	580	WAGNER, SCHERE.....	67	WRIGLEY, Geburtszange.....	602
Uterus-Dilatator, HEGAR.....	578, 579	WAGNER, Supercutterschere.....	72	WULLSTEIN, Messer.....	418
Uterus-Dilatator, PRATT.....	580	WALDMANN, Episotomie-Schere.....	64	WULLSTEIN, Mikro-Löffelzangchen.....	416
Uterus-Dilatator, SIMS.....	581	WALSHAM, Septumrichtzange.....	449	WULLSTEIN, Mikro-Ohrzangchen.....	416
Uterus-Dilatator, WYLIE.....	581	WALTHER, Dilator-Katheter.....	555	WULLSTEIN, Sauggriff.....	338
Uterus-Fasszange, COLLIN.....	585	WALTON, Fingerringssäge.....	297	WULLSTEIN, Wundspreizer.....	171
Uterus-Fasszange, DARTIGUES.....	585	WALTON, Fremdkörperhohlmeißel.....	374	Wundhaken.....	463/3
Uterus-Fasszange, SOMER.....	585	WALTON, Komodonenquetscher.....	608	Wundhaken, ALM.....	168
Uterus-Kürette, BLAKE.....	595	Wangenhalter.....	453, 451	Wundhaken, ANDERSON.....	198
Uterus-Kürette, BUMM.....	597, 598	Wangenhalter, CAWOOD-MINNESOTA.....	451	Wundhaken, AUFRANC-COBRA.....	289
Uterus-Kürette, RECAMIER.....	597, 598	Wangenhalter, STERNBERG.....	453	Wundhaken, BREAST.....	198
Uterus-Kürette, SIMS.....	597, 598	WANGENSTEEN, Nadelhalter.....	210	Wundhaken, BRUNNER.....	167
Uterus-Kürette, THOMAS.....	599	WARTENBERG, Nervrädchen.....	25	Wundhaken, COLLIN.....	139
Uterus-Löffel, GOURDET.....	599	WATSON, Dermatome.....	50	Wundhaken, COLLIN-HARTMANN.....	141
Uterus-Löffel, SCHRÖDER.....	595	WATSON-CHEYNE, Elevator.....	283	Wundhaken, COOLEY.....	148
Uterus-Löffel, SIMON.....	594	WATSON-CHEYNE, Sonde.....	199	Wundhaken, CORONAL.....	198
Uterus-Sonde, COLLIN.....	586	WATSON-WILLIAMS, Nasenzange.....	428	Wundhaken, CORYLLOS.....	166
Uterus-Sonde, MARTIN.....	586	Wattedose.....	621	Wundhaken, CRILE.....	140
Uterus-Sonde, SIMS.....	586	Watteträger, FARRELL.....	203	Wundhaken, CUSHING.....	151- 153
Uterus-Sonde, VALLEIX.....	586	Watteträger, JOBSON-HORNE.....	203	Wundhaken, CZERNY.....	141
Uterus-Zange, GREEN-ARMYTAGE.....	605	Watteträger, REDA.....	203	Wundhaken, DAVIDSON.....	166
		Watteträger, TOBOLD.....	203	Wundhaken, DEAVER.....	145, 166
V		Watteträger, UCKERMANN.....	203	Wundhaken, DEAVER-GRIP.....	146
VALLEIX, Uterus-Sonde.....	586	WALLICH, Abortuslöffel.....	607	Wundhaken, DESMARRÉS.....	151
Valve, CASPAR, Cervicalspreizer.....	179, 180	WAUGH, chirurgische Pinzette.....	83	Wundhaken, DOYEN.....	163
Valve, CLOWARD, Cervicalspreizer.....	178/1 - 178/4	WEBER, Aortaklemme.....	501	Wundhaken, DOYEN-STILLE.....	167
Valve, Bauchdeckenhalter, BALFOUR.....	183	WEBER, Starschlinge.....	378	Wundhaken, FARABEU.....	139
Valve, Bauchdeckenhalter, HORGAN.....	183	WEBSTER, Nadelhalter.....	208	Wundhaken, FERRIERA.....	197
Valve, Scheidenspekula, O'SULLIVA-O'CONNOR.....	576	Wechselpinzette, Blätter.....	179	Wundhaken, FINSEN.....	168
VAN BUREN, Dilatationsbougie.....	554	WECKER, Augenschere.....	75	Wundhaken, FREEMAN.....	198
VAN BUREN, Knochenhaltezange.....	249	WECKER, Iris spatel.....	378	Wundhaken, FRITSCH.....	163
VAN DOREN, Biopsiezange.....	588	WEEK, Lidsperrerr.....	370	Wundhaken, GIL-VERNET.....	152
VANNAS, Augenschere.....	79	WEIL-BLAKESLEY, Nasenzange.....	426	Wundhaken, GOELET.....	141
VARADY, Varizeninstrument.....	202	WEITLANER, Wundspreizer.....	169	Wundhaken, GREEN.....	160
Varizeninstrument, VARADY.....	202	WEITLANER-WULLSTEIN, Wundspreizer.....	169	Wundhaken, HARGIS.....	463
Vaskotomieklammer.....	553/1	WELLER, Präparierschere.....	53/2	Wundhaken, HARRINGTON.....	147
Verbandschere.....	70	WELLS, Eukleationslöffel.....	378	Wundhaken, HARRINGTON-PEMBERTON.....	147
Verbandschere, BERGMANN.....	69/1	WERTHEIM, gynäkologische Schere.....	62	Wundhaken, HASSON.....	143
Verbandschere, BRUNS.....	70	WERTHEIM, Hysterektomieklammer.....	124, 128	Wundhaken, HEANEY.....	164
Verbandschere, ESMARCH.....	69/2	WERTHEIM, Hysterektomieschere.....	63	Wundhaken, HIBBS.....	164
Verbandschere, KNOWLES.....	70	WERTHEIM-CULLEN, Nierenstielklammer.....	125	Wundhaken, HÖSEL.....	167
Verbandschere, LISTER.....	69/1	WEST, Hohlmeißel.....	442/1	Wundhaken, HOFER.....	465
Verbandschere, LORENZ.....	70	WEST, Nasenmeißel.....	442/1	Wundhaken, HOLZHEIMER.....	168
Verbandschere, REDA EXCENTER.....	69/2	WESTCOTT, Augenschere.....	75	Wundhaken, ISRAEL.....	162
Verbandschere, SEUTIN.....	69/2	WESTMACOTT, Nasentamponzange.....	424	Wundhaken, JANSEN.....	168
Verbandschere, SMITH US ARMY.....	69/1	WESTON, Rektalschnürer.....	566	Wundhaken, KELLY.....	164
Verbandschere, UNIVERSAL.....	70	WHEELER, Diszionsmesser.....	373	Wundhaken, KELLY-GRIP.....	142
Verbandstoffrommel, SCHIMMELBUSCH.....	622	WHEELER, Zyklodialysespatel.....	379	Wundhaken, KLAPP.....	150
Verbindungskabel.....	633	WHITE, Tonsillenzange.....	467	Wundhaken, KÖNIG.....	153
VERBRUGGE, Knochenhaltezange.....	245	WIEDER, Zungendrücker.....	452	Wundhaken, KOCHER.....	155, 159, 160, 163
VERBRUGGE-MÜLLER, Knochenhebel.....	287	WIENER, Antrumraspel.....	443	Wundhaken, KOCHER-LANGENBECK.....	159
VERESS, Insufflationskanüle.....	206	WIENER, Irishäcken.....	375	Wundhaken, KOERTE.....	162
Verlängerungsrohr, BRUENINGS.....	472	WIGMORE, Gipsmesser.....	229	Wundhaken, LAHEY.....	157
Verlängerungsstück.....	299	WILSTROEM, Arterienklammer.....	117	Wundhaken, LANGENBECK.....	158, 159
Verstellbares Sägeblatt.....	230/7	WILDE, Polypenschnürer.....	411, 433/2	Wundhaken, LANGENBECK-GREEN.....	153
VIENNA, Führungshohlsonde.....	221/1	WILDE (TROELTSCH), Ohrpinzette.....	410	Wundhaken, LITTLE.....	157
VIRCHOEW, Seziermesser.....	48	WILDER, Starschlinge.....	378	Wundhaken, LOVE.....	465
VIRTUS (RALK), Splitterzange.....	92	WILDER, Tränenkanal-Dilatator.....	381	Wundhaken, LUER.....	140
VOLKMANN, Doppellöffel.....	257	WILLET-MARTEL, Fasszange.....	110	Wundhaken, MATHIEU.....	141
VOLKMANN, Knochenhaken.....	156	WILLIAMS, Darmfasszange.....	539	Wundhaken, MIDDELDORPF.....	160
VOLKMANN, scharfer Löffel.....	251, 257	WILLIAMS, Lidsperrerr.....	370	Wundhaken, MIKULICZ.....	163
VOLKMANN, Wundhaken.....	153, 154, 156	WILLIAMS, Schraubenzieher.....	323	Wundhaken, MEYERDING.....	177
VOLTOLINI, Nasenspekula.....	421	WILLIGER, Hammer.....	271	Wundhaken, MORRIS.....	164
Vorböhrer, KUENTSCHER.....	321	WILLIGER, Raspator.....	276	Wundhaken, MURPHY.....	156
VU-MORE, Scheidenspekula.....	569	WILLIGER, scharfer Löffel.....	255, 257	Wundhaken, NAGER.....	465
		Winkelmesser, MOELTGEN.....	25	Wundhaken, OBWEGESER.....	460, 461/1
W		WINTER, Abortuszange.....	606	Wundhaken, OLLIER.....	162
WACHENFELDT, Wundklammerpinzette.....	224	Wirbelkörperspreizer, CLOWARD.....	339	Wundhaken, PARKER.....	139
WADSWORTH-TODD, Cauter.....	378	Wirbelkörperspreizer, INGE.....	339	Wundhaken, RAGNELL.....	140
WAGENER, Häkchen.....	409	WITTNER, Uterus-Biopsiezange.....	589	Wundhaken, RAMUS.....	461

Wundhaken, RICHARDSON.....	142	YASARGIL, SAUGROHR.....	337/1	Zange, WITTNER.....	589
Wundhaken, RICHARDSON-GRIP.....	142	YASARGIL, Spannam.....	368/2	Zange, YEOMANN.....	567
Wundhaken, RICHARDSON-EASTMAN.....	142	YASARGIL, Tumorzinzette.....	97	ZAUFAL, Ohrhebel.....	409
Wundhaken, ROSE.....	140	YASARGIL, Mastdarm-Biopsiezange.....	566, 567	ZAUFAL-JANSEN, Hohlmeisselzange.....	238
Wundhaken, ROSS.....	148/1	YOUNG, Prostatahaken.....	550	ZAUFAL-JANSEN, Ohrhebel.....	409
Wundhaken, ROUX.....	139	YOUNG, Zungenzange.....	453	ZEIGLER, Lidsperrer.....	371
Wundhaken, ROUX-BABY.....	140	YOUNG-BOOMERANG, Nadel.....	220	ZENKER, Arterienklemme.....	118
Wundhaken, ROUX-Mini.....	140	Z.....		ZENKER, Wundhaken.....	161
Wundhaken, SAUERBRUCH.....	164, 166	Zahnfleischschere, GOLDMAN-FOX.....	67	Zerlegbare Stanze, FERRIS-SMITH-KERRISON.....	344/2
Wundhaken, SENN-GREEN.....	153	Zahnfleischschere, LA GRANGE.....	69, 72	ZEIGLER, Disziionsmesser.....	373
Wundhaken, SENN-MILLER.....	143	Zahnfleischschere, LOCKLIN.....	69	ZIEGLER, Irismesser.....	372
Wundhaken, SIMON.....	164	Zahnfleischschere, QUINBY.....	67	ZIEGLER, Stirnspiegel.....	21
Wundhaken, SPINA-NASALIS.....	461	Zahnpinzette, LONDON-COLLEGE.....	93	ZIEGLER, Tränenkanal-Dilatator.....	381
Wundhaken, St. MARKS.....	165	Zahnpinzette, MERIAM.....	93	ZIELKE, Hohlmeissel.....	264
Wundhaken, STRANDELL-STILLE.....	157	Zange, ADAIR.....	582	Zirkular-Stanze.....	432
Wundhaken, TEBBETTS.....	197	Zange, ALEXANDER.....	589	ZÖLLNER, Saugrohr.....	337/1
Wundhaken, TUFFIER.....	147	Zange, ASCH.....	449	Zubehör f. Autopsiesäge.....	230/1 - 230/9
Wundhaken, US-ARMY/PARKER-LANGENBECK.....	141	Zange, BABY-TISCHLER.....	592	Zubehör f. oszillierende Gipssäge.....	230/11, 230/13
Wundhaken, VOLKMANN.....	153, 154, 156	Zange, BARRETT.....	582	Zubehör f. Staubsauger u. Anlage.....	231/1
Wundhaken, YANCOSKIE.....	198	Zange, BLAKE.....	530/2	Zughaken, KIRSCHNER.....	313
Wundhaken, ZENKER.....	161	Zange, BRAUN.....	582	Zughebel, BARTON.....	603/2
Wundhakenhalterung.....	188	Zange, BURKE.....	590	Zughebel, BILL.....	604
Wundklammern, MICHEL.....	224	Zange, CHEVALIER-JACKSON.....	473	Zughebel, LUIKART-BILL.....	604
Wundklammerpinzette, HEGENBARTH.....	224	Zange, COLLIN.....	585	Zugsel, NABATOFF.....	201
Wundklammerpinzette, MICHEL.....	224	Zange, CZERNY.....	584	Zungendrucker, ANDREW.....	452
Wundklammerpinzette, WACHENFELDT.....	224	Zange, DARTIGUES.....	585	Zungendrucker, DAVIS-BOYLE.....	455
Wundklammerzange, CHILDE.....	224	Zange, DESJARDINS.....	530/2	Zungendrucker, DINGMANN.....	456
Wundklammerzange, COLLIN.....	224	Zange, DOYEN.....	585	Zungendrucker, HARTMANN.....	452
Wundklammerzange, MICHEL.....	224	Zange, DUPLAY.....	582	Zungendrucker, KILNER-DOUGHTY.....	456
Wundklammerzange, RICHTER-HEATH.....	224	Zange, EPPENDORFER.....	590	Zungendrucker, MORITZ-SCHMIDT.....	452
Wundlöffel, ARRUGA.....	378	Zange, FAURE.....	588	Zungendrucker, TOBOLD.....	453
Wundnahtbesteck.....	225, 226	Zange, GAUSS.....	605	Zungendrucker, WIEDER.....	452
Wundsperrer, ALM.....	168	Zange, GREEN-ARMYTAGES.....	605	Zungenspatel.....	451
Wundsperrer, CLOWARD.....	178/1 - 178/4	Zange, HEIMING.....	536	Zungenspatel, BRUENINGS.....	451
Wundsperrer, FINSEN.....	168	Zange, HEYWOOD-SMITH.....	567	Zungenspatel, BUCHWALD.....	451
Wundsperrer, GELPI.....	189/2	Zange, HULKA.....	583	Zungenspatel, DOUGHTY.....	458
Wundsperrer, HOLZHEIMER.....	168	Zange, IOWA.....	584	Zungenspatel, FRENZEL.....	451
Wundsperrer, JACKSON-BURROWS.....	189/2	Zange, JACOBS.....	583	Zungenspatel, KROENIG.....	451
Wundsperrer, JANSEN.....	168	Zange, JARCHO.....	583	Zungenspatel, MAYO.....	451
Wundsperrer, RIGBY.....	189/2	Zange, JURASZ.....	471	Zungenspatel, MORITZ-SCHMIDT.....	452
Wundspreizer, ADSON.....	172 - 174	Zange, KELLY.....	585	Zungenspatel, RING.....	455
Wundspreizer, ADSON-BABY.....	173	Zange, KEVORKIAN.....	589, 592	Zungenspatel, RUSSEL-DAVIS.....	458
Wundspreizer, ANDERSON-ADSON.....	172	Zange, KEVORKIAN-PACIFIC.....	592	Zungenzange, COLLIN.....	453
Wundspreizer, BECKMANN.....	176	Zange, MATHIEU.....	553/1	Zungenzange, YOUNG.....	453
Wundspreizer, BECKMANN-ADSON.....	175	Zange, MAYO-BLAKES.....	530/2	Zwischenknochen-Messer.....	44
Wundspreizer, BECKMANN-EATON.....	176	Zange, MAXI GRASPER.....	593	Zwischenstück, SCHULTZE Salpingograph.....	596
Wundspreizer, BOSE.....	476	Zange, MIXTER.....	530/2	Zyklodialysespatel, BANGERTER.....	379
Wundspreizer, CASPAR.....	180	Zange, MUSEUX.....	583	Zyklodialysespatel, CASTROVIEJO.....	379
Wundspreizer, DARLING.....	178	Zange, NOTO.....	585	Zyklodialysespatel, ELSCHNIG.....	379
Wundspreizer, HENLEY.....	170	Zange, POZZI-PALMER.....	582	Zyklodialysespatel, HIRSCHMANN.....	379
Wundspreizer, MARTIN.....	175/1	Zange, PRATT.....	584	Zyklodialysespatel, WHEELER.....	379
Wundspreizer, MAYO-ADAMS.....	171	Zange, RANDALL.....	535		
Wundspreizer, MEYERDING.....	180	Zange, REDA.....	474		
Wundspreizer, MOLLISON.....	171	Zange, ROWE.....	459		
Wundspreizer, NORFOLK/NORWICH.....	172	Zange, SAENGER.....	606		
Wundspreizer, PERKINS.....	168	Zange, SCHRÖDER.....	584		
Wundspreizer, PLESTER.....	171	Zange, SCHRÖDER (POZZI).....	582		
Wundspreizer, SCALP-CONTOUR.....	169	Zange, SCHUBERT.....	588		
Wundspreizer, TRAVERS.....	172	Zange, SCHUMACHER.....	588, 589		
Wundspreizer, WEITLANER.....	169	Zange, SERPENTINE GRASPER.....	593		
Wundspreizer, WEITLANER-WULLSTEIN.....	169	Zange, SKENE.....	582		
Wundspreizer, WULLSTEIN.....	169, 171	Zange, SMITH.....	463		
WYLIE, Aortaklemme.....	501/1	Zange, SOMER.....	585		
WYLIE, Uterus-Dilatator.....	581	Zange, TEALE.....	583		
Y.....		Zange, THOMAS-GAYLOR.....	588		
YANCOSKIE, Wundhaken.....	198	Zange, TISCHLER-KEVORKIAN.....	592		
YANKAUER, Saugrohr.....	27	Zange, TISCHLER-MORGAN.....	590		
YANKAUER, Tonsillen-Dissektor.....	465	Zange, TOWNSEND.....	591		
YASARGIL, Gefäßclip.....	349 - 356	Zange, TURREL.....	567		
YASARGIL, Galeahaken.....	330	Zange, Van DOREN.....	588		
YASARGIL, Hirnspatelhalter.....	368	Zange, WALSHAM.....	449		
YASARGIL, Ohrspekulahalter.....	368/2	Zange, WINTER.....	606		

abdominal- a. intestinal spatula KÜMMEL.....	143/4, 144	amputation saw SATTERLEE.....	296	atraumatic forceps COOLEY.....	99
abdominal retractor KIRSCHNER.....	187, 187/1	Anal retractor SMITH-BUIE.....	561	atraumatic tissue forceps DEBAKEY.....	99
abdominal retractors BABY GOSSET.....	181	anastomosis clamp BECK.....	516	AUFBRANC retractor.....	289
abdominal retractors BALFOUR.....	182	anastomosis clamp BECK.....	520	AUFRICHT nose hook.....	447
abdominal retractors BALFOUR Baby.....	182	anastomosis clamp COOLEY.....	519, 520 - 520/4	AUFRICHT nose rasp.....	443
abdominal retractors BALFOUR-US.....	184	anastomosis clamp COOLEY-DERRA.....	519	Auricle clamp HARKEN.....	503
abdominal retractors CHARNLEY.....	289	anastomosis clamp DE MARTEL-WOLFSON.....	546	autopsy knife.....	48
abdominal retractors COLLIN.....	190	anastomosis clamp DEBAKEY.....	505	autopsy saw and accessories.....	230 - 230/9
abdominal retractors COLLIN-LOKTITE.....	191	anastomosis clamp LAMBERT-KAY.....	505	AUVARD vaginal specula.....	576
abdominal retractors DENIS-BROWNE.....	185	anatomic tissue forceps BROPHY.....	84	awl.....	304
abdominal retractors DOYEN.....	189/1	anatomic tissue forceps.....	81	awl HARGIS.....	463
abdominal retractors FRAZIER.....	181	anatomic tissue forceps ADSON.....	81/2	Awl OBWEGESER.....	463
abdominal retractors GELPI.....	189/1, 189/2	anatomic tissue forceps ADSON Micro.....	81/2	awl PERTHES.....	304
abdominal retractors GOSSET.....	181	anatomic tissue forceps BONNEY.....	88	AXENFELD chalazio curette.....	377
abdominal retractors KIRSCHNER.....	185, 187	anatomic tissue forceps CUSHING.....	83	AYER chalazio tissue forceps.....	393
abdominal retractors RICARD.....	191	anatomic tissue forceps CUSHING-TAYLOR.....	87		
abdominal retractors RIGBY.....	189/2	anatomic tissue forceps DUEHRSEN.....	84	B	
abdominal retractors ROCHARD.....	186	anatomic tissue forceps GERALD.....	86	BABCOCK intestinal grasping forceps.....	539
abdominal spatula KADER.....	143/3	anatomic tissue forceps McINDOE.....	85	BABINSKI percussion mallet.....	24
abdominal spatula KOERTE.....	143/3	anatomic tissue forceps POTTS-SMITH.....	81	BABY BURKE biopsy forceps.....	590
abdominal spatula Leriche.....	143/4	anatomic tissue forceps SEMKEN.....	86	BABY GOSSET abdominal retractor.....	181
ABLI ophthalmologic scissors.....	58	anatomic tissue forceps TAYLOR.....	87	BABY METZENBAUM supercut scissors.....	71
ABRAHAM tonsil forceps.....	468	anatomic tissue forceps TC.....	81	BABY TISCHLER rongeur.....	592
ABRAHAM tonsil knives.....	466	anatomic tissue forceps type USA.....	81	BABY WEBSTER needle holder.....	208
accessories for autopsy saw.....	231/3	anatomic tissue forceps STILLE.....	81	BABY YANKAUER suction tube.....	27
ADAIR tenaculum forceps.....	582	ANDERSON ADSON retractors.....	172	BABY-KOCHER intestinal clamp.....	540
adenoid curette BARNHILL.....	450	ANDERSON retractor.....	198	BABY-OLSEN-HEGAR needle holder.....	212
adenoid curette BECKMANN.....	450	ANDREW tongue depressor.....	452	BABYPHON Sphygmomanometer.....	10
adenoid curette St. CLAIR-THOMSON.....	450	ANDREW-PYNCHON suction tube.....	28	Back holder Abdominal retractor system.....	192, 193, 194, 195
Adenotom LA FORCE.....	450	ANESTOPHON.....	23	BACKHAUS towel clamp.....	132
ADLERKREUTZ vascular tissue forceps.....	84	aneurysm clamp DEBAKEY-BAHNSON.....	506	BACKHAUS-clip.....	132
ADSON retractors.....	173	aneurysm clip applicator forceps.....	357 - 360	BAILEY rib spreader.....	489/1
ADSON anatomic tissue forceps.....	81/2	aneurysm vascular clip YASARGIL.....	349 - 356	BAILEY-BABY rib spreader.....	489/1
ADSON anatomic tissue forceps.....	81/2	anoscope HIRSCHMANN.....	562	BAILEY-GIBBON rib spreader.....	489/1
ADSON BABY hemostatic clamp.....	113	anoscope IVES-FANSLER.....	562	BAINBRIDGE hemostatic clamp.....	120
ADSON bone rongeur.....	236	Antrum curette COAKLEY.....	449	BAINBRIDGE vascular clamp.....	495/1, 495/2
ADSON dura hook.....	328	Antrum rasp GALLAHER.....	446	BAKES gall duct dilator.....	532
ADSON hemostatic clamp.....	112	Antrum rasp LEWIS.....	443	BALFOUR abdominal retractors.....	182
ADSON holding clamp.....	298	ANTRUM-curette.....	435	BALFOUR US abdominal retractors.....	184
ADSON hypophyseal forceps.....	334	ANVIL nail forceps.....	613	BALFOUR BABY abdominal retractors.....	182
ADSON MICRO anatomic tissue forceps.....	81/2	aorta clamp WEBER.....	501	BALFOUR hook.....	193
ADSON MICRO surgical tissue forceps.....	81/2	aorta punch.....	528	BALFOUR-NS abdominal retractors.....	184
ADSON needle holder.....	211	aortic clamp WYLIE.....	501/1, 501/2	BALL AND SOCKET towel clamp.....	133
ADSON raspatories.....	282	appendix clamp ALLEN.....	544	ball electrode MONOPOLAR.....	628, 629
ADSON retractors.....	172, 173, 174	appendix clamp KLEINSCHMIDT.....	544	BALLENGER knives.....	436
ADSON suction tube.....	337	applier forceps aneurysm clip.....	357 - 360	BALLENGER septum elevator.....	439
ADSON surgical tissue forceps.....	81/2	applier forceps BIEMER.....	361, 366	BALLENGER tonsil forceps.....	467
ADSON-BROWN tissue forceps.....	82	applier forceps JOHNS-HOPKINS.....	104	bandage scissors.....	70
ADSON-DEBAKEY atraumatic forceps.....	81/2	applier forceps MC KENZIE.....	326	bandage scissors BERGMANN.....	69/1
air blower.....	405	applier forceps MEHDORN.....	362	bandage scissors BRUNS.....	70
air blower POLITZER.....	406	applier forceps SMITHWICK.....	326	bandage scissors ESMARCH.....	69/2
AIR INJECTION eye cannula.....	394	applier forceps SWEET.....	326	bandage scissors KNOWLES.....	70
air pump.....	295	appling forceps RANEY.....	327	bandage scissors LISTER.....	69/1
ALAN-PARKS rectal specula.....	561	Approximator BIEMER.....	366	bandage scissors LORENZ.....	70
ALDERDYCE elevator.....	282	Approximator BIEMER-MÜLLER.....	363	bandage scissors REDA EXCENTER.....	69/2
ALEXANDER biopsy forceps.....	589	Approximator MÜLLER.....	364	bandage scissors SEUTIN.....	69/2
ALEXANDER chisels.....	259	ARCHER splinterforceps.....	92	bandage scissors SMITH US army.....	69/1
ALEXANDER raspatories.....	276	ARLT cataract loop.....	378	bandage scissors UNIVERSAL.....	70
ALLEN appendix intestinal clamp.....	544	armsystem.....	188	BANE-HARTMANN bone rongeur.....	237
ALLIS intestinal grasping forceps.....	537	ARRUGA capsular forceps.....	391	BANGERTER cycloidialysis spatula.....	379
ALLIS-ADAIR intestinal grasping forceps.....	537	ARRUGA extraction hook.....	375	BARACANI interchangeable tips.....	472
ALLIS-BABY intestinal grasping forceps.....	537	ARRUGA eye specula.....	370	BARANY air blower.....	405
ALLISON lung spatula.....	489/2	ARRUGA needle holder.....	214	BARBARA hook.....	419
ALM retractor.....	168	ARRUGA wound curette.....	378	BARBARA needle.....	419
ALVIS foreign body curette.....	374	ASCH septum straightening forceps.....	449	BARKAN goniotomy knives.....	373
amnioscope.....	601	atrauma bulldog clamp.....	100	BARNHILL adenoid curette.....	450
amniotome BEACHAM.....	586	Atrauma bulldog clamp.....	100, 102	BARON suction tube.....	336
amputation knives CATLIN.....	44	atrauma clamp DEBAKEY.....	100	BARR rectal-specula.....	559
amputation knives LANGENBECK.....	44	atrauma clamp DEBAKEY.....	103	BARRAQUER cilia forceps.....	395
amputation knives LISTON.....	44	atrauma clamp GLOVER.....	100	BARRAQUER eye scissors.....	75
amputation knives REDA.....	44	atrauma neonatal clamp.....	523	BARRAQUER eye specula.....	370
amputation saw BIER.....	296	Atrauma-bulldog clamp GLOVER.....	103	BARRAQUER fixation forceps.....	390
amputation saw CHARRIERE.....	296	atraumatic forceps ADSON-DEBAKEY.....	81/2	BARRAQUER knives.....	373

BARRAQUER needle holder.....	217	Bipolar-tissue forceps bajonett.....	632	bone holding forceps FARABEUF.....	243
BARRAQUER needle holder.....	216, 217	BIRCHER-GANSKE bone holding forceps.....	246	bone holding forceps FARABEUF-LAMBOTTE.....	243
BARRAQUER-KATZIN iris tissue forceps.....	384	BIRKETT hemostatic clamp.....	116	bone holding forceps FERGUSSON.....	243
BARRET hook forceps.....	582	BISHOP-HarmAN iris tissue forceps.....	386	bone holding forceps KERN.....	244
BARTON obstetrical forceps.....	603/2	BISHOP-HarmAN irrigation cannula.....	394/1	bone holding forceps LAMBOTTE.....	244
battery handle for cold light.....	33	bladder retractors LEGUE.....	553	bone holding forceps LANE.....	244
battery handle for warm light.....	32	bladder retractors MILLIN.....	552	bone holding forceps LANGENBECK.....	243
BAUMGARTNER needle holder.....	208	bladder retractors THOMSON-WALKER.....	552	bone holding forceps LEWIN.....	246
BEAGHAM amniotome.....	586	bladder retractorsJUDD-MASSON.....	552	bone holding forceps MEYER.....	248
BECHERT Nucleus Rotator.....	379	bladder spatula KOCHER.....	552	bone holding forceps REDA.....	246, 247
BECK anastomosis clamp.....	520	bladder spatula LEGUEU.....	552	bone holding forceps REILL.....	248
BECK vascular clamp.....	516	bladder spreader MILLIN.....	553	bone holding forceps SEMB.....	243
BECKER cystotome.....	375	blade breaker CASTROVIEJO.....	45	bone holding forceps ULRICH.....	248
BECKMANN adenoid curette.....	450	blade breaker REDA.....	45	bone holding forceps VAN BUREN.....	249
BECKMANN retractors.....	176	blade breaker TROUTMAN-CHRIS.....	45	bone holding forceps VERBRUGGE.....	245
BECKMANN-ADSON retractors.....	175	blade ejecting forceps.....	179	bone hook VOLKMANN.....	156
BECKMANN-EATON retractors.....	176	blade remover.....	42	bone levers.....	284, 288
bed pan.....	621/1	blade scalpel.....	42	bone levers BENNETT.....	283
BEEBEE crown scissors.....	68	blades razor.....	45	bone levers BLOUNT.....	288
BEER cilia forceps.....	395	BLAKE gall stone forceps.....	530/2	bone levers HOHMANN.....	284
BEESON plaster retractor.....	232	BLAKE uterine curette.....	595	bone levers HOHMANN.....	285
BELLUCCI micro ear scissors.....	413	BLOHMKE tonsil forceps.....	467	bone levers HOHMANN Mini.....	286
BELLUCCI micro scissors.....	417	blood vessel clamp DIETRICH.....	510	bone levers KOENIG.....	284
bender LANE.....	322/1	blood vessel clamp MORRIS-DEBAKEY.....	506	bone levers LANGE-HOHMANN.....	286
bender LANE.....	325	BLOUNT bone levers.....	288, 289	bone levers SMILLIE.....	291
BENGOLEA hemostatic clamp.....	112	blower KABIERSKE.....	405	bone levers VERBRUGGE-MÜLLER.....	287
BENNETT bone levers.....	283	BLUMENTHAL bone rongeur.....	236	bone plate holding forceps LANE.....	325
BENSAUDE proctoscope.....	565	BODENmallet rectal specula.....	559	bone rasp.....	294
BENSON pylorus retractor.....	544	BOEHLER extension bow.....	312	bone rasp PUTTI.....	294
BERENS discision knives.....	372	BOERMA obstetrical forceps.....	604	bone rongeur rLEKSELL-STILLE.....	240
BERGMANN bandage scissors.....	69/1	BOETTCHER tonsil scissors.....	59	bone rongeur ADSON.....	236
BERGMANN mallet.....	272	BÖHLER bone cutting forceps.....	241	bone rongeur BANE-HARTMANN.....	237
BERKE muscle forceps.....	389	BÖHLER bone rongeur.....	238	bone rongeur BEYER.....	237, 238
BERLINER percussion mallet.....	24	BOIES elevator.....	277	bone rongeur BLUMENTHAL.....	236
BERNHARD towel clamp.....	133	BONACCOLTO strabismus forceps.....	385	bone rongeur BOEHLER.....	238
BERRY wire forceps.....	319	bone curettes.....	255, 256	bone rongeur CLEVELAND.....	235
BETHUNE rib scissors.....	481	bone curettes BRUNS.....	251, 254	bone rongeur ECHLIN.....	240
BEYER bone rongeur.....	237, 238	bone curettes BUSHE.....	256	bone rongeur FRIEDMAN-MICRO.....	234
BIEMER applier forceps.....	361, 366	bone curettes DAUBENSPECK.....	255	bone rongeur FRIEDMAN-MINI.....	234
BIEMER approximator.....	366	bone curettes HALLE.....	253	bone rongeur FRYKHOLM.....	240
BIEMER vascular clip.....	361	bone curettes JACOBSON.....	257	bone rongeur JANSEN.....	237
BIEMER-MÜLLER approximator.....	363	bone curettes JANSEN.....	257	bone rongeur KLEINERT-KUTZ.....	237
BIER amputation saw.....	296	bone curettes LEMPERT.....	256	bone rongeur LEMPERT.....	237
BILLEAU ear loop.....	409	bone curettes MARTINI.....	257	bone rongeur LUER.....	236
biopsy curette HEANY.....	587	bone curettes SCHEDE.....	251	bone rongeur MARQUARD.....	239
biopsy curette KEVORKIAN.....	587	bone curettes SCOVILLE.....	253	bone rongeur MAYFIELD.....	238
biopsy curette NOVAK.....	587	bone curettes SPINAL.....	253	bone rongeur MEAD.....	235
biopsy curette RANDALL.....	587	bone curettes SPRATT.....	251	bone rongeur OLIVECRONA.....	237
biopsy curette type MÜNCHEN.....	587	bone curettes VOLKMANN.....	251, 257	bone rongeur RUskin.....	239
biopsy forceps ALEXANDER.....	589	bone curettes WILLIGER.....	255, 257	bone rongeur SAUERBRUCH.....	240
biopsy forceps BABY BURKE.....	590	bone cutting forceps BOEHLER.....	241	bone rongeur SCAGLIETTI.....	240
biopsy forceps BURKE.....	590	bone cutting forceps COTTLE-KAZANJIAN.....	241	bone rongeur SEMB.....	240
biopsy forceps EPPENDORFER.....	590	bone cutting forceps LISTON.....	241	bone rongeur SMITH-PETERSEN.....	238
biopsy forceps FAURE.....	588	bone cutting forceps McINDOE.....	241	bone rongeur STELLBRINK.....	234
biopsy forceps KEVORKIAN.....	589	bone cutting forceps RUskin.....	241	bone rongeur STILLE-LUER.....	239
biopsy forceps KEVORKIAN.....	591	bone cutting forceps SEMB.....	242	bone rongeur STILLE-RUskin.....	239
biopsy forceps KEVORKIAN-PACIFIC.....	592	bone cutting forceps STILLE-HORSLEY.....	242	bone rongeur ZAUFAL-JANSEN.....	238
biopsy forceps MAXI GRASPER.....	593	bone cutting forceps STILLE-LISTON.....	242	bone wire soft.....	314
biopsy forceps SCHUBERT.....	588	bone hand drills BUNELL.....	299	BONNI iris tissue forceps.....	387
biopsy forceps SCHUMACHER.....	588, 589	bone hand drills HUDSON.....	299	BONNEY anatomic tissue forceps.....	88
biopsy forceps THOMAS-GAYLOR.....	588	bone hand drills KIRSCHNER.....	299	BONNEY surgical tissue forceps.....	88
biopsy forceps TISCHLER-DOWN.....	591	bone hand drills MOORE.....	298	BOSE trachea hook.....	476, 477
biopsy forceps TISCHLER-KEVORKIAN.....	592	bone hand drills RALK.....	300	BOUCHERON ear specula.....	399
biopsy forceps TISCHLER-MORGAN.....	591	bone hand drillsSTILLE.....	298	BOWMAN discision needle gerade.....	374
biopsy forceps TOWNSEND MINI.....	591	bone hand drillsSTILLE-SHERMAN.....	298	BOWMAN eye specula.....	370
biopsy forceps TOWNSEND TISCHLER MINI.....	591	bone holding clamp FELDHEIM.....	249	BOWMAN lachrymal probes.....	381
biopsy forceps VAN DOREN.....	588	bone holding clamp GERSTER.....	250	Box PETRI.....	620
biopsy forceps WITTNER.....	589	bone holding clamp LAMBERT-LOWMAN.....	249	BOYNTON needle holder.....	214
biopsy forcepsTISCHLER-MORGAN.....	590	bone holding clamp LOWMAN.....	249	BOZEMANN dressing forceps.....	138
biopsy needle MENGHINI.....	206	bone holding clamp LOWMAN-HOGLUND.....	249	BOZEMANN needle holder.....	211
biopsy-/suction curette.....	600	bone holding forceps.....	249	BOZEMANN-DOUGLAS dressing forceps.....	138
bipolar cable.....	633	bone holding forceps BIRCHER-GANSKE.....	246	brain knives.....	48
bipolar tissue forceps.....	630, 631	bone holding forceps DINGMANN.....	246	brain spatula CUSHING.....	336

brain spatula CUSHING.....	369	capsular forceps CASTROVIEJO.....	391	chisels COTTLE.....	440
brain spatula DAVIS.....	337	capsular forceps ELSCHNIG.....	391	chisels HIBBS.....	265
brain spatula HEIFETZ.....	369	capsular forceps FUCHS.....	391	chisels HOKE.....	265
brain spatula OLIVECRONA.....	336	capsular forceps GILL-ARRUGA.....	390	chisels Killian.....	442/1
BRAND tendon grasping instrument.....	293	capsular forceps HESS.....	391	chisels LAMBOTTE.....	261
BRAND tendon passing instrument.....	294	capsular forceps KALT.....	391	chisels LEXER.....	263
BRAUN cranoplast.....	607	capsular forceps SCHWEIGGER.....	391	chisels MINI-LAMBOTTE.....	262
BRAUN decapitating hook.....	607	capsular forceps TERSON.....	391	chisels NOVOTEX.....	264
BRAUN hook forceps.....	582	capsular grasping forceps MILLIN.....	551	chisels OBWEGESER.....	463
BRAUN uterine-Depressor.....	586	cardiovascular clamps.....	526	chisels SMITH-PETERSEN.....	261
BRAUN-STADLER episotomy scissors.....	64	CarmALT splinter tissue forceps.....	91	chisels STILLE.....	260
BREAST retractor.....	198	CAROLL tendon grasping instrument.....	293	cilia forceps BARRAQUER.....	395
BREISKY vaginal specula.....	577	Carotid shunt clamp JAVID.....	511	cilia forceps BEER.....	395
BRIDGE hemostatic clamp.....	116	CARPENTER tonsil knives.....	465	cilia forceps DOUGLAS.....	395
BRISTOW bone levers.....	290	CARTILAGE knives.....	47	cilia forceps GRADLE.....	395
BRODIE probes.....	199	CASPAR hemostats.....	258	cilia forceps LITTAUER.....	395
Broncho forceps CHEVALIER-JACK.....	473	CASPAR retractors.....	179, 180	cilia forceps REDA.....	395
bronchus clamp.....	126	CASTANEDA Neonatal vascular clamp.....	527	CINELLI septum chisels.....	441
bronchus clamp FINOCCHIETTO.....	490	CASTROVIEJO.....	79, 381	circular rongeur.....	432
bronchus clamp HARRINGTON.....	490	CASTROVIEJO bladeBREAKER.....	45	CIRCUMCISIONS instrument.....	556
bronchus clamp LEES.....	504	CASTROVIEJO capsular forceps.....	391	CITELLI rongeur.....	430
bronchus clamp PRICE-THOMAS.....	490	CASTROVIEJO cyclodialysis spatula.....	379	clamp socket.....	189
bronchus clamp SEMB.....	491	CASTROVIEJO discision knives.....	372	clamp Vasktomie.....	553/2
BROPHY anatomic tissue forceps.....	84	CASTROVIEJO eye specula.....	371	CLAR HEAD LIGHTS.....	22
BROPHY surgical tissue forceps.....	84	CASTROVIEJO fixation forceps.....	390	CLARK eye specula.....	370
BROWN needle holder.....	209	CASTROVIEJO hornyskinscissors.....	79	CLAUS tonsil needle.....	466
BROWN tissue forceps.....	83	CASTROVIEJO Measurance circle.....	380	CLAYMAN.....	376
BRUENINGS ear specula.....	401	CASTROVIEJO needle holder.....	215	Clayman hook.....	376
BRUENINGS interchangeable tips.....	472	CASTROVIEJO tissue forceps.....	392	cleaning pistol.....	626
BRUENINGS septum forceps.....	425	CASTROVIEJO-MICRO needle holder.....	215	CLEVELAND bone rongeur.....	235
BRUENINGS tongue depressors.....	451	CASTROVIEJO-STANDARD needle holder.....	216	clip forceps CHILDE.....	224
BRUENINGS tonsil knives.....	466	cataract curette DAVIEL.....	377	clip forceps COLLIN.....	224
BRUENINGS tonsil snare.....	468	cataract curette GRAEFE.....	377	clip forceps MICHEL.....	224
BRUNETTI chisels.....	268	cataract curette KNAPP.....	378	clip forcepsRICHTER-Heath.....	224
BRÜNINGS-LUCAS chisels.....	260	cataract knives DEUTSCHMANN.....	371	clip MICHEL.....	224
BRUNNER guideprobes.....	221/1	cataract knives GRAEFE.....	371	clip tissue forceps HEGENBARTH.....	224
BRUNNER intestinal clamp.....	543	cataract loop ARLT.....	378	clip tissue forceps MICHEL.....	224
BRUNNER retractor.....	167	cataract loop SNELLEN.....	378	clip tissue forceps WACHENFELDT.....	224
BRUNNER rib scissors.....	481	cataract loop WEBER.....	378	clip-applier forceps.....	523, 524
BRUNS bandage scissors.....	70	cataract loop WILDER.....	378	CLOWARD lamina spreader.....	339
BRUNS bone curettes.....	251, 254	CATHER INTRODUCING FORCEPS MAGILL.....	28	CLOWARD laminectomy retractor forceps.....	342
brush dispenser.....	611	catheter forceps COOLEY.....	510	CLOWARD retractors.....	178/1, 178/2, 178/3, 178/4
BRYANT dressing forceps.....	137	catheter guide GUYON.....	554	COAKLEY ANTRUM curette.....	449
BUCHWALD tongue depressors.....	451	catheter WALTHER.....	555	COAKLEY trocar.....	204
BUCK ear curette.....	407	CATLIN amputation knives.....	44	COBB curette.....	252
BUCK foreign body lever.....	412	cauter WADSWORTH-TODD.....	378	COBB gouges.....	262
BUCK percussion mallet.....	24	cervica retractor CLOWARD.....	178/1, 178/2, 178/3, 178/4	COBB raspatories.....	280
BUCK-GRAMCKO bone levers.....	285	cervical traction tong CRUTCHFIELD.....	327	COLCLOUGH intervertebral disc rongeur.....	344/1
BUJE rectal suction tube.....	566	chalazio curette AXENFELD.....	377	COLD LIGHT GUIDE HOLLINGER.....	37
BULLDOG clamp atrauma.....	100	chalazio curette HEBRA.....	377	COLD LIGHT GUIDE JACKSON.....	37
BULLDOG clamp DEBAKEY.....	100, 103	chalazio curette MEYHOEFER.....	377	COLD LIGHTclamp for Amnioskope.....	601
bulldog clamp DIETRICH.....	101	chalazio tissue forceps AYER.....	393	COLLER-CRILE hemostatic clamp.....	106
bulldog clamp GLOVER.....	103	chalazio tissue forceps DESMARRES.....	393	COLLIER needle holder.....	208
bulldog clamp JOHNS-HOPKINS.....	104	chalazio tissue forceps LAMBERT.....	393	COLLIER pelvimeter.....	605
BÜLOW-GUNAR-HEY tubing clamp.....	130	CHAPUT tissue grasping forceps.....	110	COLLIN abdominal retractor.....	190
BUMM uterine curette.....	597	CHARNLEY abdominal retractor.....	289	COLLIN clip forceps.....	224
BUNELL bone hand drills.....	299	CHARRIERE amputation saw.....	296	COLLIN dressing forceps.....	137
BUNELL tendon guide.....	294	CHEATLE sterilization forceps.....	227	COLLIN DYNAMOMETER.....	25
BUNELL tendon passing instr.....	292	cheek retractorSTERNBERG.....	453	COLLIN intestinal grasping forceps.....	539
BUNGE scoop.....	378	cheekSTEIN needle holder.....	210	COLLIN LOKTITE abdominalDE.....	191
BUNT sterilization clamp.....	227	CHELSEA-EATON proctoscope.....	563	COLLIN mallet.....	270
BURCH fixation forceps.....	373	CHERON dressing forceps.....	137	COLLIN navelstringclamp.....	605
BURKE biopsy forceps.....	590	CHEERY laminectomy retractor.....	488	COLLIN pelvimeter.....	605
BUSCH episiotomy scissors.....	64	CHEST SUPPORT KLEINSASSER.....	36	COLLIN retractor.....	139
BUSHE bone curette.....	256	CHEVALIER-JACKSON.....	473	COLLIN scalpel-handle.....	40
		CHEVALIER-JACKSON trachea cannula.....	479	COLLIN tissue grasping forceps.....	110
C		CHILDE clip forceps.....	224	COLLIN tongue forceps.....	453
cable bipolar.....	633	children atrauma vascular clamp.....	526	COLLIN uterine-grasping forceps.....	585
caliper TOWNLEY.....	26	chisel NEIVERT-ANDERSON.....	442	COLLIN uterine-probes.....	586
CANFIELD tonsil knives.....	466	chisels.....	259, 264	COLLIN vaginal specula.....	570
CAPLAN nose forceps.....	428	chisels ALEXANDER.....	259	COLLIN-DUVAL grasping PINZE.....	85
capsula scissors RESANO.....	53/2	chisels blade.....	266	COLLIN-HARTMANN retractor.....	141
capsular forceps ARRUGA.....	391	chisels BRUNETTI.....	268	Columella tissue forceps COTTLE.....	448

COLVER tonsil forceps.....	467	cup medicine.....	621	DEBAKEY vascular scissors.....	61
comedone extractor SAALFELD.....	608	cup sputum.....	621/1	DEBAKEY vascular scissors TC.....	60
comedone extractor SCHAMBERG.....	608	curette Antrum.....	435	DEBAKEY-BAHNSON aneurysm clamp.....	506
comedone extractor UNNA.....	608	curette Cobb.....	252	DEBAKEY-DIETRICH MINI BULLDOG clamp.....	101
comedone extractor WALTON.....	608	curette FAULKNER.....	449	DEBAKEY-MIXTER vascular clamp.....	499/2
compression bandage.....	296	curette forceps.....	416	DEBAKEY-MOSQUITO hemostatic clamp.....	509
CONE curette.....	280	curette HOUSE.....	420	DEBAKEY-PEAN atrauma clamp.....	513
CONE head punch.....	331	CUSCO vaginal specula.....	570	DEBAKEY-RANKIN atrauma clamp.....	512
CONE raspatories.....	280	Cushing (Taylor) tissue forceps TC.....	87	DEBAKEY-RUMEL vascular clamp.....	499
CONNIN-AMSLER marker.....	380	CUSHING anatomic tissue forceps.....	83	Decapitating hook BRAUN.....	607
CONVERSE nose hook.....	448	CUSHING brain spatula.....	336, 369	DECKER rongeur.....	341
CONVERSE septum knives.....	435	CUSHING drill.....	299	DEJERINE percussion mallet.....	24
COOLEY anastomosis clamp.....	519, 520 - 520/4	CUSHING laminectomy retractor forceps.....	340	Delee retractor.....	574
COOLEY atraumatic tissue forceps.....	99	CUSHING nerve ENhook.....	328	DEMEL wire guide needle.....	315
COOLEY catheter forceps.....	510	CUSHING retractor.....	152	DEMEL wire instrument.....	315
COOLEY retractor.....	148	CUSHING retractor.....	153	DENHART mouth gags.....	454
COOLEY rib spreader.....	487	CUSHING retractor.....	151, 152, 153	DENIS-BROWNE abdominal retractors.....	185
COOLEY vascular clamp.....	518, 522	CUSHING surgical tissue forceps.....	83	depth ruler.....	594
COOLEY-DERRA anastomosis clamp.....	519	CUSHING tissue forceps.....	87	DERF needle holder.....	208
COOLEY-NEONATAL rib spreader.....	485	CUSHING-TAYLOR anatomic tissue forceps.....	87	Dermatom HUMBY.....	50
COOLY suction tube.....	28	CUZZI ovum curette.....	606	Dermatom SILVER.....	50
COOPER ligaturee needle.....	219	cyclodialysis spatula BANGERTER.....	379	Dermatome SCHINK.....	49
CORDES interchangeable tips.....	472	cyclodialysis spatula CASTROVIEJO.....	379	dermatome blade.....	49
corneal dissector GREEN.....	374	cyclodialysis spatula ELSCHNIG.....	379	DESCHAMPS ligaturee needle.....	218
corneal dissector PATON.....	373	cyclodialysis spatula WHEELER.....	379	DESJARDINS gall stone curette.....	534
corneal scarifier ELSCHNIG.....	373	Cystotom BECKER.....	375	DESJARDINS gall stone forceps.....	530/2
corneal scarifier GILL.....	373	Cystotom GRAEFE.....	375	DESJARDINS gall stone probe.....	531
corneal scarifier TOOK.....	373	CZERNY hook forceps.....	584	DESJARDINS hemostatic clamp.....	121
CORONAL BROW retractor.....	198	CZERNY rectal-specula.....	559	DESMARRES chalazio tissue forceps.....	393
CORWIN-HEGAR wire forceps.....	319	CZERNY retractor.....	141	DESMARRES retractor.....	151
CORYLLOS retractor.....	166	D		DEUTSCHMANN cataract knives.....	371
CORYLLOS rib scissors.....	480	DALE vascular clamp.....	494, 495	DEVILBISS head forceps.....	332
COS micro ear forceps.....	414	DANDY hemostatic clamp.....	109	Diagnostic set ECO "C".....	16
COTTLE columella tissue forceps.....	448	DANDY nerve hook.....	328	Diagnostic set ECO "T".....	16
COTTLE fixation forceps.....	410	DARDIK multi purpose clamp.....	509/1	Diagnostic set RI-MINI.....	17
COTTLE mallet.....	273	DARLING retractors.....	178	Diagnostic set UNI III.....	15
COTTLE nose hook.....	447, 447/1	DARTIGUES uterine grasping forceps.....	585	DIFFENBACH vascular clamp.....	104
COTTLE nose scissors.....	59	DASTOOR strabismus forceps.....	386	DIETER micro ear forceps.....	414
COTTLE nose specula.....	423	DASTOOR suction tube.....	380	DIETRICH blood vessel clamp.....	510
COTTLE scissors.....	56	DAUBENSPECK bone currettes.....	255	DIETRICH MINI-bulldog clamp.....	101
COTTLE septum chisels.....	440	DAVIDSON(SCAPULA) retractor.....	166	DIETRICH vascular scissors.....	60
COTTLE septum elevator.....	439	DAVIEL cataract curette.....	377	dilation bougie DITTEL.....	554
COTTLE septum knives.....	435	DAVIS brain spatula.....	337	dilation bougie GUYON.....	554
COTTLE skin hook.....	447, 448	DAVIS dura dissector.....	379	dilation bougie VAN BUREN.....	554
COTTLE-JOSEPH septum.....	439	DAVIS foreign body needle.....	374	DINGMANN bone holding forceps.....	246
COTTLE-KAZANJIAN bone cutting forceps.....	241	DAVIS sterilization tissue forceps.....	227	DINGMANN mouth gag.....	456
COTTLE-NEIVERT.....	448	DAVIS-BOYLE.....	455	DINGMANN raspatories.....	463
cotton-applicator.....	203	DAVIS-SPERRE.....	455	DINGMANN retractor.....	463
cotton-applicator FARRELL.....	203	DAVIS-MEYER mouth gag.....	457	DINGMANN spreader.....	456
cotton-applicator JOBSON-HORNE.....	203	DAY hook.....	409	DIPLOMAT Sphygmomanometer.....	5
cotton-applicator REDA.....	203	DE BAKEY needle holder.....	210	discision knives BERENS.....	372
cotton-applicator TOBOLD.....	203	DE BAKEY vascular clamp.....		discision knives CASTROVIEJO.....	372
cotton-applicator UCKERMANN.....	203	493-500, 502, 505-508, 512-517	discision knives JAEGER.....	372
COXETER METAL catheter.....	555	DE BAKEY vascular scissors.....	60, 61	discision knives WHEELER.....	373
CRAFOOD-SELLORS hemostatic clamp.....	118	DE BAKEY vascular-dilator.....	529	discision knives ZIEGLER.....	373
CRAFOORD hemostatic clamp.....	118	DE BOER rib spreader.....	486	discision needle.....	374
CRAFOORD lung scissors.....	65/2	DE LEE obstetrical forceps.....	602	discision needle BOWMAN.....	374
cranoplast BRAUN.....	607	DE MARTEL guide sleeve.....	330	disimpaction forceps ROWE.....	459
cranoplast TARNIER.....	607	DE MARTEL-WOLFSON.....	546	dissecting scissors.....	52, 52/1, 53
CREGO elevator.....	282	DEAN iris knives.....	372	dissecting scissors.....	53/2
CRILE hemostatic clamp.....	107	DEAN tonsil scissors.....	59	dissecting scissors DEAVER.....	52
CRILE needle holder.....	213	DEAVER dissecting scissors.....	52	dissecting scissors JORGENSEN.....	53
CRILE nerve hook.....	328	DEAVER retractor.....	145	dissecting scissors LEXER.....	53
CRILE retractor.....	140	DEAVER-GRIP retractor.....	146	dissecting scissors LEXER-BABY.....	53
CRILE-MURRAY needle holder.....	209	DEBAKEY aortic clamp.....	505	dissecting scissors LEXER-BABY TC.....	53
CRILE-RANKIN hemostatic clamp.....	107	DeBaKey atrauma bulldog clamp.....	100, 103	dissecting scissors MAYO.....	52/1
CRILE-WOOD needle holder.....	209	DEBAKEY atrauma clamp.....	100	dissecting scissors MAYO-NOBLE.....	52/1
CRITCHETT eye specula.....	370	DEBAKEY atrauma clamp.....	103	dissecting scissors MAYO-STILLE.....	52/1
crown scissors BEEBEE.....	68	DEBAKEY atraumatic tissue forceps.....	99	dissecting scissors METZENBAUM.....	53/1
CRUTCHFIELD head holder.....	327	DEBAKEY retractor.....	189/1	dissecting scissors METZENBAUM.....	53/1
CRUTCHFIELD cervical traction tong.....	327	DEBAKEY suction tube.....	28	dissecting scissors METZENBAUM FINO.....	53/1
cuff for leg.....	295	DEBAKEY vascular clamp.....	493-500, 502, 505-508, 512-517	dissecting scissors METZENBAUM FINO TC.....	53/1
cuff for upper arm.....	295				

dissecting scissors METZENBAUM TC	53/1	dura scissors SCHMIEDEN-TAYLOR	65/1	ESMARCH bandage scissors	69/2
dissecting scissors PECK-JOSEPH	74	duraNTE grasping tissue forceps	88	ESMARCH plaster knives	233
dissecting scissors TOENNIS-ADSON	65	DUVAL grasping tissue forceps	85	ETHICON clip forceps	524
dissector FISCH	420	DUVAL intestinal grasping forceps	539	EVES tonsil snare	468
dissector GORNEY	277	Dynamometer COLLIN	25	EXACTA Sphygmomanometer	8
dissector PENFIELD	333			Exenteration curette BUNGE	378
DITTEL dilation bougie	554	E		extensions bows BOEHLER	312
DIX foreign body chisels	374	ear catheter HARTMANN	408	extensions bows KIRSCHNER	312
DIX foreign body instrument	380	ear curette BUCK	407	extensions bows KIRSCHNER US	312
double curette VOLKMANN	257	ear curette GROSS	409	extirpation chisels ROLLET	374
DOUGHTY tongue blade	458	ear forceps HARTMANN	411	extraction dissector LANG	378
DOUGLAS cilia forceps	395	ear forceps HEYMANN-KNIGHT	425	extraction hook ARRUGA	375
DOUGLAS tonsil knives	466	ear forceps JANSEN	424	extraction hook KNAPP	375
DOUGLAS trocar	204	ear forceps LITTAUER	411	extraction hook ROLLET	375
DOYEN abdominal retractor	189/1	ear forceps LUCAE	410	extractor KUENTSCHER	322
DOYEN gynecological scissors	63	ear forceps TILLEY	411	eye cannula MCINTYRE	394
DOYEN intestinal clamp	540	ear forceps TROELTSCH	424	eye cannula type AIR INJECTION	394
DOYEN myoma a screw	594	ear forceps WILDE (TROELTSCH)	410	eye cannula type SHEETS	394/2
DOYEN probes	199	ear knives POLITZER	408	eye magnet REDA	395
DOYEN raspatories	278	ear knives SEXTON	408	eye scissors BARRAQUER	75
DOYEN retractor	163	ear lever ZAUFAL	409	eye scissors NOYES	75
DOYEN scissors	63	ear lever ZAUFAL-JANSEN	409	eye scissors VANNAS	79
DOYEN towel clamp	133	ear loop BILLEAU	409	eye scissors WECKER	75
DOYEN uterine polyp forceps	585	ear loop SHAPLEIGH	410	eye scissors WESTCOTT	75
DOYEN vaginal specula	574	ear probes STACKE	199	eye specula ARRUGA	370
DOYEN-BABY intestinal clamp	540	ear specula BOUCHERON	399	eye specula BARRAQUER	370
DOYEN-JANSEN(MOLT)	454	ear specula BRUENINGS	401	eye specula BOWMAN	370
DOYEN-JANSEN(MOLT) mouth gags	454	ear specula GRUBER	399	eye specula CASTROVIEJO	371
DOYEN-STILLE	167	ear specula HARTMANN	399	eye specula CLARK	370
dressing forceps BOZEMANN	138	ear specula POLITZER	399	eye specula CRITCHETT	370
dressing forceps BOZEMANN-DOUGLAS	138	ear specula RICHNAU-HOLMGREN	400	eye specula GRAEFE	370
dressing forceps BRYANT	137	ear specula SIEGLE	402	eye specula LANCASTER	371
dressing forceps CHERON	137	ear specula TOYNBEE	399	eye specula LISTER-BURCH	370
dressing forceps COLLIN	137	ear syringe REINER	406	eye specula MELLINGER	370
dressing forceps FOERSTER	136	ECHLIN bone rongeur	240	eye specula MELLINGER-AXENFELD	370
dressing forceps GROSS-MAIER	134	ECO "C" Diagnostic set	16	eye specula MUELLER	371
dressing forceps BOZEMANN-DOUGLAS	138	ECO "T" Diagnostic set	16	eye specula MURDOCK	370
dressing forceps MAIER	134	EICKEN (KILLIAN) irrigation cannula	433	eye specula PARK	371
dressing forceps PELKMANN	137	elevator ALDERDYCE	282	eye specula SMITH	370
dressing forceps RAMPLEY	136	elevator BOIES	277	eye specula WEEK	370
dressing forceps SIMS-MAIER	134	elevator CREGO	282	eye specula WILLIAMS	370
dressing forceps ULRICH	135	elevator DINGMANN	463, 463/3	eye specula ZIEGLER	371
dressing tissue forceps JACKSON	471	elevator FREER	434	eye specula STEVENSON	371
drill bits	302	elevator KEY	282	eye suction -irrigation cannula	394
drill CUSHING	299	elevator LEMPERT	420		
drill ERRICO	299	elevator LUNIATSCHEK	465	F	
drill MC KENZIE	299	elevator McDONALD	283	Face Lift scissors FREEMAN	74
drill wire	299	elevator MURPHY-LANE	283	Face Lift scissors GORNEY	73
drills	299	elevator SAYRE	281	Face Lift scissors KAYE	73
drillwire KIRSCHNER	306, 307	elevator WATSON-CHEYNE	283	Face Lift scissors REES	73
driver KUENTSCHER	321	ELLIOT obstetrical forceps	603	FANSLER proctoscope	564
drivers	321	ELLIS foreign body gouges	374	FARABEUF bone holding forceps	243
drums SCHIMMELBUSCH	622	ELSCHING capsular forceps	391	FARABEUF raspatories	274
DUBOIS gynecological scissors	63	ELSCHING corneal scarifier	373	FARABEUF retractor	139
DUEHRSEN anatomic tissue forceps	84	ELSCHING cyclodialysis spatula	379	FARABEUF-COLLIN raspatories	274
DUPLAY dressing forceps	134	ELSCHING fixation forceps	389	FARABEUF-LAMBOTTE bone holding forceps	243
DUPLAY hook forceps	582	EMMETT fistula hook	594	FARRELL cotton-applicator	203
DUPLEX stethoscope	23	ENDERmail STEINMANN	307	FARRIOR ear specula	400
DUPUY-WEISS tonsil knives	466	endoscop eassembly	188	FARRIOR ear specula	400
dura dissector	332	endoscope wire basket	623	FAULKNER curette	449
dura dissector DAVIS	332	Endospecula KOGAN	577	FAURE biopsy forceps	588
dura dissector FRAZIER	333	ENGEL plaster cast saw	229	FAURE peritoneum clamp	123
dura dissector HOEN	333	enterotomy scissors	66	FAVALORO vascular scissors	61
dura dissector HORSLEY	333	Entropium forceps SNELLEN	393	FEHLAND intestinal clamp	542
dura dissector MILLIGAN	332	enucleation curette WELLS	378	FEILCHENFELD tissue forceps	91
dura dissector OLIVECRONA	332	ENUCLEATION scissors	58	FELDHEIM bone holding clamp	249
dura dissector SACHS	332	epiglottis retractor FRAENKEL	471	FERGUSSON bone holding forceps	243
dura dissector TOENNIS	332	epiglottis retractor JACKSON	471	FERGUSSON clamp	109
dura dissector WOODSON	333	epiglottis retractor REICHERT	471	FERGUSSON FRAZIER suction tube	337
dura hook	335	episotomy scissors WALDMANN	64	FERGUSSON gall stone curette	533
dura hook ADSON	328	EPKER osteotome	464/2	FERGUSSON surgical scissors	66
dura hook JACOBSON	335	EPPENDORFER biopsy forceps	590	FERRIERA retractor	197
dura knives KOOS	335	ERICH wire pusher	461/2	FERRIS-SMITH laminectomy retractor forceps	343

FERRIS-SMITH surgical tissue forceps	85	FREER skin hook.....	448	graduated measure	620
FERRIS-SMITH-KERRISON rongeur	344, 344/2	FRENZEL nystagmus spectacles.....	20	GRAEFFE cataract curette	377
FICHOCHIETTO-BABY rib spreader	482	FRENZEL tongue depressors.....	451	GRAEFFE cataract knives	371
files nail	612/1	FRIEDMANN MINI bone rongeur	234	GRAEFFE cystotome	375
FINGER nail drill	297	FRIEDMANN specula	577	GRAEFFE discision knives	372
finger protector LANGENBECK	311	FRITSCH retractor.....	163	GRAEFFE discision knives	372
Finger ring saw REDA	297	FRYKHOLM bone rongeur	240	GRAEFFE fixation forceps	389
Finger ring saw WALTON	297	FUCHS capsular forceps	391	GRAEFFE hook	148/2
Finger-Goniometer	25	FUCHSIG hemostatic clamp	113	GRAEFFE IRIS tissue forceps	382
Fingersaw LANGENBECK.....	296			Graefe scissors.....	56
FINOCCHIETTO bronchusclamp.....	490	G		GRAEFFE strabismus hook.....	375
FINOCCHIETTO rib spreader.....	482	Galeahook YASARGIL.....	330	GRAEFFE tissue forceps.....	83
FINOCCHIETTO Baby rib spreader	482	gall duct dilator BAKES.....	532	GRAFFFE eye specula	370
FINOCCHIETTO needle holder	211	gall stone curette DESJARDINS.....	534	GRAHAM nerve hook	328
FINOCCHIETTO rib spreader	484	gall stone curette FERGUSSON.....	533	grasping forceps.....	316
FINOCCHIETTO-BURFORD rib spreader	483	gall stone curette LUER-KOERTE	533	grasping forceps.....	415
FINSEN retractor	168	gall stone curette MAYO	534	grasping forceps LAHEY	479
FISCH dissector	420	gall stone curette MOOR	531	grasping forceps MARTEL	110
FISCH fine hook	335	gall stone forceps BLAKE	530/2	grasping forceps PRATT	110
FISCHER iris tissue forceps	384	gall stone forceps DESJARDINS	530/2	grasping forceps WILLET MARTEL.....	110
FISH probes	199	gall stone forceps MAYO-BLAKE	530/2	grasping tissue forceps COLLIN-DUVAL	85
FISHER tonsil knives.....	466	gall stone forceps MIXTER	530/2	grasping tissue forceps duraNTE	88
fistula hook EMMETT	594	gall stone probes DESJARDINS	531	grasping tissue forceps DUVAL	85
fistula probes PRATT.....	563	gall stone probes MAYO	534	grasping tissue forceps LERCHE	83
fistulapropes LOCKHART-MUMMERY.....	200	gall stone probes MOYNIHAN	531	grasping tissue forceps RUSS MODELL	85
fixation forceps BARRAQUER.....	390	GALLAHER ANTRUM rasp.....	446	GRAVE vaginal specula.....	570
fixation forceps CASTROVIEJO	390	GASS hook.....	376	GRAY hemostatic clamp	121
fixation forceps Cottle	410	GAUSS scalp forceps	605	GREEN corneal dissector.....	374
fixation forceps ELSCHNIG.....	389	GELPI abdominal retractor	189/1, 189/2	GREEN fixation forceps.....	390
fixation forceps GRAEFE	389	GELPI hook	193	GREEN muscle hook	375
fixation forceps GREEN.....	390	GEMINI hemostatic clamp	115	GREEN retractor.....	160
fixation forceps LESTER	389	GERALD anatomic tissue forceps.....	86	GREEN-armYTAGE.....	605
Fixierforc BURCH.....	373	GERALD surgical tissue forceps	87	GREGOIRE intestinal forceps.....	538
Flat forceps	316, 317	GERSTER bone holding clamp	250	GREVIN micro ear forceps	414
FOERSTER dressing forceps	136	GERZOG mallet.....	270	GROSS ear curette.....	409
FOERSTER IRIS tissue forceps	383	GIERTZ-STILLE rib scissors.....	481	GROSS-MAIER dressing forceps	134
FOMON nose rasp	444	GIGLI saw	332	GRUBER ear specula	399
FOMON nose scissors	58	GILL corneal scarifier	373	guide driver.....	321
FOMON raspatories	277	GILL iris tissue forceps.....	384	guide needle REDON	207
FOMON Rhinoplastscissors	65/1	GILL-ARRUGA capsular forceps.....	390	GUILLEN suction raspatories.....	433/1
FOMON septum chisels	441	GILL-HESS iris tissue forceps.....	384	gum scissors LA GRANGE.....	69
FOMON skin hook	447/1	GILLIES needle holder	212	gumscissors GOLDMAN-FOX.....	67
FOMON TC nose rasp.....	445	GILLIES skin hook	448	gumscissors LOCKLIN	69
FOREGGER laryngoscopee	29, 31	GILLIES surgical tissue forceps	86	gumscissors QUINBY	67
foreign body chisels DIX	374	GIL-VERNET retractor	152	GUTHRIE skin hook	148/2
foreign body curette ALVIS	374	GLOVER atrauma clamp	100	GUYON catheter einguide.....	554
foreign body forceps HARTMANN.....	412	GLOVER bulldog clamp	103	GUYON dilation bougie.....	554
foreign body forceps HARTMANN-HOFFMANN	412	GLOVER vascular clamp	515	GUYON hemostatic clamp	122
foreign body forceps HARTMANN-WULLSTEIN.....	412	GLUCK rib scissors	480	GUYON kidney clamp	122
foreign body forceps MATHIEU	553/1	GOELET retractor.....	141	GUYTON-LUNDSGAARD sclerotome	373
foreign body gouges ELLIS	374	GOLDMANN-FOX gum scissors	67	gynecological scissors DOYEN	63
foreign body gouges WALTON.....	374	GOMEL microsurgical tissue forceps.....	96	gynecological scissors DUBOIS	63
foreign body instr. DIX	380	GOMMEL micro scissors	80	gynecological scissors SIEBOLD	62
foreign body lever BUCK	412	goniometer for finger	25	gynecological scissors SIMS	62
foreign body lever QUIRE.....	412	goniometer MOELTGEN.....	25	gynecological scissors WERTHEIM	63
foreign body needle.....	374	goniotomy knives BARKAN	373		
foreign body needle DAVIS	374	goniotomy knives SCHEIE	373	H	
foreign body needle FRANCIS	374	GOOD tonsil scissors	59	HABERER intestinal spatula	143/3
foreign body needle LA FORCE	374	GOODELL uterine Dilatator	581	haemorrhoid.forceps McGIVNEY	568
foreign body needle LEVINSON.....	374	GORNEY dissector.....	277	haemorrhoid.LigatorRUDD	568
FOX LUPUS curette	608	GORNEY FACE LIFT scissors	73	haemorrhoidal clamp FERGUSSON	109
FRAENKEL interchangeable tips.....	472	GOSSET abdominal retractor	181	haemorrhoidal forceps HEYWOOD-SMITH	567
FRANCIS foreign body needle	374	gouges	264	Haemorrhoidal Ligator MC GIVNEY.....	568
FRAZIER abdominal retractor	181	gouges PARTSCH	259	HAGLUND-STILLE plaster retractor	232
FRAZIER dura dissector.....	333	gouges COBB	262	HAIGHT rib spreader	487
FRAZIER punctum cannula	337	gouges HIBBS	265	HAJEK mallet	273
FRAZIER skin hook	148/2	gouges LEXER MINI.....	263	HAJEK septum chisels.....	442/1
FREEMAN face lift scissors.....	74	gouges WEST.....	442/1	HAJEK-BALLENGER elevator	439
FREEMAN retractor	198	gouges ZIELKE.....	264	HAJEK-KOFLER rongeur	429, 431
FREER elevatorIUM	434	gougesSTILLE	260	HALLE bone currettes	253
FREER septum chisels.....	439, 442	GOURDET uterine curette	599	HALLE septum elevator	437
FREER septum elevator	437	GRADLE cilia forceps	395	halogen lamp for laryngoscopee	29
FREER septum knives	434	GRADLE ophthalmologic scissors	57	HALSEY needle holder.....	208

HALSTED-MOSQUITO hemostatic clamp.....	105	hemostatic clamp JACOBSON.....	105	hook BARBARA.....	419
handle for chisels/chisels.....	266	hemostatic clamp JOHNS-HOPKINS.....	120	hook DAY.....	409
handle For chisels/OSTEO.....	266	hemostatic clamp KANTROWITZ.....	119	hook FISCH.....	335
handle scalpel.....	38, 39, 39/1, 39/2, 40, 41	hemostatic clamp KELLY.....	106	hook forceps BARRET.....	582
handle scalpel MINI.....	41	hemostatic clamp KELLY-RANKIN.....	106	hook forceps BRAUN.....	582
HANK uterine dilator.....	580	hemostatic clamp KOCHER.....	108	hook forceps CZERNY.....	584
HARGIS awl.....	463	hemostatic clamp LAHEY.....	120	hook forceps DUPLAY.....	582
HARGIS mandibular body retractor.....	463/6	hemostatic clamp LAWRENCE.....	119	hook forceps HULKA.....	583
HARGIS raspatory.....	463/2	hemostatic clamp LERICHE.....	111	hook forceps IOWA.....	584
HARKEN auricle clamp.....	503	hemostatic clamp LOVELACE.....	109	hook forceps JACOBS.....	583
HarmS lachrymal probes.....	381	hemostatic clamp LOWER.....	120	hook forceps JARCHO.....	583
HarmS probes.....	333	hemostatic clamp MAYO-GUYON.....	122	hook forceps MUSEUX.....	583
HARRINGTON bronchusclamp.....	490	hemostatic clamp MEEKER.....	119	hook forceps PRATT.....	584
HARRINGTON hook.....	193	hemostatic clamp Micro-HARTMANN.....	104	hook forceps Schröder.....	584
HARRINGTON -PEMBERTON retractor.....	147	hemostatic clamp MIXTER.....	119, 121	hook forceps SCHROEDER.....	583
HARRINGTON retractor.....	147	hemostatic clamp MIXTER-BABY.....	119	hook forceps SCHROEDER (POZZI).....	582
HARTMANN ear catheter.....	408	hemostatic clamp MOYNIHAN.....	121	hook forceps SKENE.....	582
HARTMANN ear specula.....	399	hemostatic clamp O'SHAUGNESSY.....	120	hook forceps TEALE.....	583
HARTMANN foreign body forceps.....	412	hemostatic clamp OVERHOLT.....	114	hook forcepsSTAUDE-MOORE.....	582
HARTMANN foreign body lever.....	411	hemostatic clamp PEAN.....	108	hook GASS.....	376
HARTMANN hemostatic clamp.....	104	hemostatic clamp PEAN.....	110	hook GELPI.....	193
HARTMANN nose specula.....	422, 427	hemostatic clamp PENNINGTON.....	109	hook HARRINGTON.....	193
HARTMANN polyp forceps.....	424	hemostatic clamp PROVIDENCE-HOSPITAL.....	106	hook KELLY.....	193
HARTMANN tongue depressors.....	452	hemostatic clamp ROBERTS.....	117	hook KUGLEN.....	376
HARTMANN tuning forc.....	403	hemostatic clamp ROCHESTER-CarmALT.....	109	hook LUCAE.....	409
HARTMANN-HALLE nose specula.....	421	hemostatic clamp ROCHESTER-OCHSNER.....	108	hook McGEE.....	419
HARTMANN-HOFFMANN foreign body forceps.....	412	hemostatic clamp ROCHESTER-PEAN.....	108	hook SCOVILLE.....	196
HARTMANN-WULLSTEIN foreign body forceps.....	412	hemostatic clamp RUMEL.....	117	hook SINSKEY.....	376
HASSON retractor.....	143	hemostatic clamp SAROT.....	118	hook SMELLIE.....	605
HAUGH micro ear forceps.....	414	hemostatic clamp S-cvd MIXTER.....	116	hook WAGENER.....	409
HAYES rectum clamp.....	545	hemostatic clamp SPENCER-WELLS.....	109	hookSt.EVENS.....	375
head holder CRUTCHFIELD.....	327	hemostatic clamp STILLE.....	122	HOPKINS plaster knives.....	233
head mirror ZIEGLER.....	21	hemostatic clamp TOENNIS.....	117	HORIZON clip forceps.....	524
head punch CONE.....	331	hemostatic clamp WIKSTROEM.....	117	HORSLEY dura dissector.....	333
HEANEY hysterectomy clamp.....	126	hemostatic clamp ZENKER.....	118	HÖSEL retractor.....	167
HEANEY needle holder.....	210	hemostatic clampOVERHOLT-BABY.....	114	HOUSE curette.....	420
HEANY biopsy curette.....	587	hemostatic clampOVERHOLT-GEISSENDÖRFER.....	114	HOUSE suction tubeE.....	337/2
HEANY retractor.....	164	hemostatic clampOVERHOLT-MIXTER.....	115	HOWARTH septum elevator.....	438
HEANY-BALLENTINE hysterectomy clamp.....	127	hemostats.....	259	HUBER UNIVERSALhandle.....	472
hear light CLAR.....	22	HENKE tonsil-elevator.....	465	HUDSON bone hand drills.....	299
HEATH mallet.....	273	HENLEY retractors.....	170	HUDSON T-handle.....	300
HEATH suture scissors.....	66	HENNIG plaster retractor.....	232	HULKA hook forceps.....	583
HEBRA chalazial curette.....	377	HEPP-SCHUIDEL micro scissors.....	78	HUMBY DERMATOM.....	50
HEGAR uterine dilator.....	578, 579	HERCULES wire cutter.....	320/1 - 320/3	HUNTER splinter forceps.....	91
HEGENBARTH clip tissue forceps.....	224	HERRICK NIERENSTIELclamp.....	123	HURD tonsil elevator.....	465
HEIFETZ brain spatula.....	369	HESS capsular forceps.....	391	hypophyse curette.....	334
HEIMING kidney stone forceps.....	536	HESS iris tissue forceps.....	384	hypophyse tissue forceps ADSON.....	334
HEISS hemostatic clamp.....	112	HEYMANN septum forceps.....	425	hysterectomy clamp HEANEY.....	126
HEISTER mouth gags.....	454	HEYMANN nose scissors.....	58	hysterectomy clamp HEANY-BALLENTINE.....	127
hemostatic clamp ADSON.....	112	HEYMANN-KNIGHT ear forceps.....	425	hysterectomy clamp MAINGOT.....	123/1, 123/2
hemostatic clamp ADSON-BABY.....	113	HEYWOOD-SMITH haemorrhoidal forceps.....	567	hysterectomy clamp ROGERS.....	127
hemostatic clamp BAINBRIDGE.....	120	HIBBS chisels.....	265	hysterectomy clamp SEGOND.....	125
hemostatic clamp BENGOLEA.....	112	HIBBS gouges.....	265	hysterectomy clamp SEGON-LANDAU.....	125
hemostatic clamp BIRKETT.....	116	HIBBS retractor.....	164	hysterectomy clamp WERTHEIM.....	124
hemostatic clamp BRIDGE.....	116	HILL-FERGUSON rectal-specula.....	560	hysterectomy clamp WERTHEIM.....	128
hemostatic clamp COLLIER-CRILE.....	106	HIRSCHMAN spatula.....	331	hysterectomy forceps WERTHEIM-CULLEN.....	125
hemostatic clamp CRAFOORD.....	118	HIRSCHMANN anoscope.....	562	hysterectomy scissors WERTHEIM.....	63
hemostatic clamp CRAFOORD-SELLORS.....	118	HOEN dura dissector.....	333		
hemostatic clamp CRILE.....	107	HOESEL needle holder.....	213	I	
hemostatic clamp CRILE-RANKIN.....	107	HOFER retractor.....	465	I.U.D. extractor hook.....	593
hemostatic clamp DANDY.....	109	HOFFMANN tubing clamp.....	624	I.U.D. SERPENTINE GRASPER.....	593
hemostatic clamp DEBAKEY-MOSQUITO.....	509	HOHMANN bone levers.....	284, 285	impactor/extractor.....	322/1
hemostatic clamp DEBAKEY-PEAN.....	513	HOHMANN MINI.....	286	incision scissors.....	52
hemostatic clamp DEBAKEY-RANKIN.....	512	HOKKE chisels.....	265	INGE lamina spreader.....	339
hemostatic clamp DESJARDINS.....	121	holding arm system LEYLA.....	368 - 368/4	INGROWN nail instrument.....	612/1
hemostatic clamp FUCHSIG.....	113	holding clamp ADSON.....	298	INSTRU-CARE instrument oil.....	635
hemostatic clamp GEMINI.....	115	HOLLINGER laryngoscope.....	37	instrument BOX.....	617
hemostatic clamp GRAY.....	121	HOLLINGER LIGHT GUIDE.....	37	instrument oil INSTRU CARE.....	635
hemostatic clamp GUYON.....	122	HOLSHER nerve hook.....	329	Insufflationcannula VERESS.....	206
hemostatic clamp HALSTED-MOSQUITO.....	105	HOLTH rongeur.....	380	interchangeable tips BARACANI.....	472
hemostatic clamp HALSTED-MOSQUITO titanium.....	105	HOLZBACH hysterectomy clamp.....	126	interchangeable tips BRUENINGS.....	472
hemostatic clamp HARTMANN.....	104	HOLZHEIMER retractor.....	168	interchangeable tips CORDES.....	472
hemostatic clamp HEISS.....	112	hook BALFOUR.....	193	interchangeable tips FRAENKEL.....	472

interchangeable tips FRAENKEL.....	472	IWANSON Measuring instrument.....	624	KERRISON rongeur.....	428
interchangeable tips KRAUSE.....	472	J		KEVORKIAN biopsy curette.....	587
interchangeable tips LANGE.....	472	JACKSON laryngoscope.....	37	KEVORKIAN biopsy forceps.....	589, 591
interchangeable tips SCHEINMANN.....	472	JACKSON tendon grasping forceps.....	292	KEVORKIAN-PACIFIC biopsy forceps.....	592
interchangeable tips SCHUMACHER.....	472	JACKSON trachea hook.....	476	KEY elevator.....	282
interchangeable tips SEIFERT.....	472	JACKSON vaginal specula.....	573	KEYES punch.....	608
intervertebral disc rongeur COLCLOUGH.....	344/1	JACKSON-BURROWS retractor.....	189/2	kidney clamp GUYON.....	122
intestinal clamp BABY-KOCHER.....	540	JACOBS hook forceps.....	583	kidney forceps HERRICK.....	123
intestinal clamp Brunner.....	543	JACOBSON buttonprobes.....	335	kidney stone forceps HEIMING.....	536
intestinal clamp DOYEN.....	540	JACOBSON curette.....	257	kidney stoneforceps RANDALL.....	535
intestinal clamp FEHLAND.....	542	JACOBSON dura hook.....	335	kidney tray.....	619
intestinal clamp KOCHER.....	540	JACOBSON hemostatic clamp.....	105	KIELLAND obstetrical forceps.....	602
intestinal clamp MAYO-ROBSON.....	541	JACOBSON needle holder.....	215	KIELLAND-LUIKART obstetrical forceps.....	603
intestinal clamp PAYR.....	548	JAEGER discision knife.....	372	KILLIAN gouges.....	442/1
intestinal clamp RESANO.....	542	JAEGER lid plate.....	371	KILLIAN nose specula.....	423
intestinal clamp SCUDDER.....	541	JAMESON strabismus forceps.....	385	KILLIAN septum elevator.....	438, 439
intestinal clampSt.ONE-WATT.....	545	JAMESON strabismus hook.....	375	KILLIAN septum scissors.....	471
intestinal forceps GREGOIRE.....	538	JANSEN bone curettes.....	257	KILLIAN-CLAUS septum gouges.....	442/1
intestinal grasping forceps ALLIS.....	537	JANSEN bone rongeur.....	237	KILNER needle holder.....	212
intestinal grasping forceps ALLIS-ADAIR.....	537	JANSEN ear forceps.....	424	KILNER nose hook.....	447/1
intestinal grasping forceps ALLIS-BABY.....	537	JANSEN retractor.....	168	KILNER skin hook.....	608
intestinal grasping forceps ATRAUMA.....	111	Jar.....	620	KILNER surgical scissors.....	541/1
intestinal grasping forceps BABCOCK.....	539	JARCHO hook forceps.....	583	KILNER/RAGNELL supercut scissors.....	72
intestinal grasping forceps COLLIN.....	539	JAVID carotid shunt clamp.....	511	KILNER-DOUGHTY mouth gag.....	456
intestinal grasping forceps DOYEN-BABY.....	540	JENNING'S mouth gags.....	454	KIRBY-ARTHUR IRIS forceps.....	385
intestinal grasping forceps DUVAL.....	539	jewelry tissue forceps.....	90	KIRK mallet.....	270
intestinal grasping forceps JUDD-ALLIS.....	538	JOBSON-hornyE cotton-applicator.....	203	KIRSCHNER.....	312
intestinal grasping forceps LITTLEWOOD.....	538	JOHNS-HOPKINS applier forceps.....	104	KIRSCHNER abdominal retractor.....	187, 187/1
intestinal grasping forceps LOCKWOOD-ALLIS.....	538	JOHNS-HOPKINS bulldog clamp.....	104	KIRSCHNER abdominal retractor.....	185, 187
intestinal grasping forceps THOMS-ALLIS.....	538	JOHNS-HOPKINS bulldog clamp.....	104	KIRSCHNER bone hand drills.....	299
intestinal grasping forceps WILLIAMS.....	539	JOHNS-HOPKINS hemostatic.....	120	KIRSCHNER drill wire.....	306, 307
intestinal spatula HABERER.....	143/3	JOHNSON needle holder.....	211	KIRSCHNER guideprobes.....	221
intestinal spatula LERICHE.....	143/3	JONES towel clamp.....	132	KIRSCHNER nail.....	308, 309
intestinal spatula REVERDIN.....	143/3	JONES-clip towel clamp.....	132	KIRSCHNER US extension bow.....	312
intestinal spatula RIBBON.....	143/1	JORGENSEN dissecting scissors.....	53	KLAPP retractor.....	150
intima spatula.....	530/1	JOSEPH (LEWIS) nose rasp.....	443	KLEINERT-KUTZ rongeur.....	237
intra oral retractors.....	463/1, 463/4	JOSEPH nose rasp.....	443	KLEINERT-KUTZ skin hook.....	149
intramedullary drills.....	322	JOSEPH nose saw.....	446	KLEINERT-KUTZ tendon grasping instrument.....	294
IOWA hook forceps.....	584	JOSEPH raspatories.....	277	KLEINSASSER chest support.....	36
IOWA needle guide.....	206	JOSEPH septum.....	437	KLEINSASSER injection cannula.....	36
Iris hook O'CONNOR.....	375	JOSEPH septum knives.....	434	KLEINSASSER light guide.....	36
Iris hook WIENER.....	375	JOSEPH septum knives.....	434, 435	KLEINSASSER suction tube tube.....	36
Iris knives DEAN.....	372	JOSEPH skin hook.....	149	KLEINSCHMIDT appendix intestinal clamp.....	544
Iris knives KNAPP.....	372	JOSEPH surgical scissors.....	54/1	KLINKENBERGH-LOTH vascular scissors.....	65/1
Iris knives ZIEGLER.....	372	JUDD-ALLIS intestinal grasping forceps.....	538	KNAPP cataract curette.....	378
IRIS scissors.....	54/2	JUDD-MASSON bladder retractors.....	552	KNAPP extraction hook.....	375
Iris scissors KNAPP.....	55	JUERS micro ear forceps.....	414	KNAPP iris knives.....	372
Iris scissors LITTLER.....	55	JURASZ laryngeal polypus forceps.....	471	KNAPP IRIS scissors.....	55
Iris spatula WECKER.....	378	K		KNAPP-LUER forceps.....	393
IRIS supercut scissors.....	72	KABIERSKE powder blower.....	405	KNIGHT septum forceps.....	425
Iris tissue forceps BARRAQUER-KATZIN.....	384	KADER abdominal spatula.....	143/1	knives amputation.....	44
Iris tissue forceps BISHOP-HarmAN.....	386	KALLMORGEN specula.....	573	knives BALLENGER.....	436
Iris tissue forceps BONN.....	387	KALT capsular forceps.....	391	knives bone.....	44
Iris tissue forceps FISCHER.....	384	KALT needle holder.....	214	knives LANGENBECK.....	47
Iris tissue forceps FOERSTER.....	383	KALT needle holder.....	214	knives MUCK.....	420
Iris tissue forceps GILL.....	384	KALT needle holder.....	214	knives PLESTER.....	418
Iris tissue forceps GILL-HESS.....	384	KALT-ARRUGA needle holder.....	214	knives ROSEN.....	418
Iris tissue forceps GRAEFE.....	382	KANE navelstringclamp.....	605	knives SCHUKNECHT.....	418
Iris tissue forceps HESS.....	384	KANTROWITZ hemostaticL.....	119	knives TABB.....	418
Iris tissue forceps KIRBY-ARTHUR.....	385	KAYE FACE LIFT scissors.....	73	knives WULLSTEIN.....	418
Iris tissue forceps ModELL BONN.....	387	KEINSASSER OP-laryngoscope.....	35	KNOWLES bandage scissors.....	70
Iris tissue forceps TROUTMAN.....	384; 389	KEITH needle.....	223	KOCHER bladder spatula.....	552
Iris tissue forceps type TUEBINGEN.....	387	KELLY GRIP retractor.....	142	KOCHER hemostatic clamp.....	108
Iris tissue forcepsSTEVENS.....	383	KELLY hemostatic clamp.....	106	KOCHER intestinal clamp.....	540
irrigation cannula EICKEN (KILLIAN).....	433	KELLY hook.....	193	KOCHER probes.....	479
irrigation cannula KILLIAN.....	433/1	KELLY proctoscope.....	562, 563	KOCHER retractor.....	155, 160, 163
irrigation cannula KILLIAN.....	433/1	KELLY retractor.....	164	KOCHER-LANGENBECK retractor.....	159
irrigation cannula RITTER-HALLE.....	433	KELLY uterine polyp forceps.....	585	KOENIG needle.....	223
irrigation cannula SIMCOE.....	394/2	KELLY vascular scissors.....	61	KOERTE abdominal spatula.....	143/3
Irrigations cannula type LACRIMAL.....	394	KELLY-RANKIN hemostatic clamp.....	106	KOERTE retractor.....	162
ISRAEL retractor.....	162	Keratoplast.-knives BARRAQUER.....	373	KOGAN endo specula.....	577
ITERSON trachea hook.....	477	Keratoplast.-knives PAUFIQUE.....	373	KÖNIG bone levers.....	284
IVES-FANSLER anoscope.....	562	KERN bone holding forceps.....	244	KÖNIG guideprobes.....	221/1

KÖNIG raspatories.....	276	LANGENBECK amputation knives.....	44	LOCKHART-MUMMERY fistula probes.....	200
KÖNIG retractor.....	153	LANGENBECK bone holding forceps.....	243	LOCKLIN gum scissors.....	69
KOOS dura knives.....	335	Langenbeck ear loop.....	409	LOCKWOOD-ALLIS intestinal grasping forceps.....	538
KRAUSE interchangeable tips.....	472	LANGENBECK FINGER saw.....	296	LONDON-COLLEGE teeth tissue forceps.....	93
KRAUSE polyp snare.....	433/2	LANGENBECK knives.....	47	loop electrode MONOPOLAR.....	628, 629
KRAUSE polyp snare.....	411, 434	LANGENBECK needle holder.....	213	LOPEZ-REINKE tonsil.....	465
KRAUSE-VOSS polyp snare.....	433/2	LANGENBECK raspatories.....	275	LORENZ bandage scissors.....	70
KRAYENBÜHL nerve hook.....	336	LANGENBECK retractor.....	158, 159	LORNA towel clamp.....	133
KRISTELLER specula.....	572	LANGENBECK-GREEN retractor.....	153	LOUTE wire instrument.....	315
KRISTELLER vaginal specula.....	572	LARSEN tendon grasping forceps.....	292	LOVE nerve hook.....	329, 330
KROENIG tongue depressors.....	451	laryngeal cannula.....	470	LOVE retractor.....	465
KRONECKER ligaturee needle.....	219	laryngeal mirror.....	473	LOVE-GRUENWALD.....	340
KUGLEN hook.....	376	laryngeal mirror MICHEL.....	423	LOVELACE hemostatic clamp.....	109
KÜMME abdominal spatula.....	143/4, 144	laryngeal polypus forceps FRAENKEL.....	471	LOVELACE lung grasping forceps.....	490
KÜNTSCHER driver.....	321	laryngeal polypus forceps JURASZ.....	471	LOWER hemostatic clamp.....	120
KÜNTSCHER extractor.....	322	laryngoscope FOREGGER.....	29, 31	LOWMAN bone holding clamp.....	249
KÜNTSCHER reamer.....	321	laryngoscope handle cold light.....	33	LOWMAN-HOGLUND bone holding clamp.....	249
K-wire dispenser.....	310	laryngoscope handle warm light.....	32	LUBET-BARBON nose dressing forceps.....	424
		laryngoscope handle with transformer.....	34	LUC septum forceps.....	426
		laryngoscope HOLINGER.....	37	LUCAE ear forceps.....	410
L		laryngoscope JACKSON.....	37	LUCAE hook.....	409
LA FORCE adenoid curette.....	450	laryngoscope MCINTOSH.....	29, 31	LUCAE mallet.....	271
LA FORCE foreign body needle.....	374	laryngoscope MILLER.....	30	LUCAE paracentesis needle.....	408
LA GRANGE gum scissors.....	69	Lateral vaginal retractor.....	569	LUCAE tuning forc.....	404
LABORDE trachea dilator.....	476	LAWRENCE hemostatic clamp.....	119	LUCAS.....	260
lachrymal dilat. WILDER.....	381	lead hand.....	250	LUER bone rongeur.....	236
lachrymal dilat.CASTROVIEJO.....	381	LEBSCHKE skull breaker.....	267	LUER retractor.....	140
lachrymal dilator ZIEGLER.....	381	LEES bronchus clamp.....	504	LUER trachea cannula.....	479
lachrymal probes BOWMAN.....	381	LEGUE bladder retractors.....	553	LUER-KOERTE gall stone curette.....	533
lachrymal probes HarmS.....	381	LEGUEU bladder spatula.....	552	LUJKART obstetrical forceps.....	603
LACRIMAL Irrigationscannula.....	394	LEKSELL(STILLE) bone rongeur.....	240	LUNDSGAARD SKLEROTOM.....	373
LAGRANGE supercut scissors.....	72	LELAND-JONES vascular clamp.....	495	lung grasping forceps LOVELACE.....	490
LAHEY grasping forceps.....	479	LEMPERT bone curettes.....	256	lung scissors CRAFOORD.....	65/2
LAHEY hemostatic clamp.....	120	LEMPERT bone rongeur.....	237	lung spatula ALLISON.....	489/2
LAHEY retractor.....	149, 157	LEMPERT elevator.....	420	LUNIATSCHEK.....	465
LAMBERT chalazio tissue forceps.....	393	LERICHE grasping tissue forceps.....	83	Lupus curette FOX.....	608
LAMBERT-KAY aortic-ANASTOMosis clamp.....	505	LERICHE abdominal spatula.....	143/4	Lupus curette PIFFARD.....	608
LAMBERT-LOWMAN bone holding clamp.....	249	LERICHE hemostatic clamp.....	111		
LAMBOTTE bone holding forceps.....	244	LESTER fixation forceps.....	389	M	
LAMBOTTE chisels.....	261	LEVINSON foreign body needle.....	374	MAGILL CATETHER INTRODUCING FORCEPS.....	28
LAMBOTTE raspatories.....	274, 275	LEWIN bone holding forceps.....	246	MAIER dressing forceps.....	134
lamina spreader CLOWARD.....	339	LEXER BABY dissecting scissors.....	53	MAINGOT hysterectomy forceps.....	123/1, 123/2
lamina spreader INGE.....	339	LEXER chisels.....	263	mallet.....	270, 272
laminectomy retractor CHERRY.....	488	LEXER dissecting scissors.....	53	mallet BERGMANN.....	272
laminectomy retractor forceps CLOWARD.....	342	LEXER MINI gouges.....	263	mallet COLLIN.....	270
laminectomy retractor forceps OLDBERG.....	341/1	LEYLA holding arm system.....	368 - 368/4	mallet COTTLE.....	273
laminectomy retractor forceps SCHLESINGER.....	342	LICHTENBERG needle holder.....	213	mallet GERZOG.....	270
laminectomy retractor forceps SPURLING.....	340	LICHTWITZ trocar.....	204	mallet HAJEK.....	273
laminectomy retractor forceps WAGNER.....	343	LIEBERMAN eye specula.....	324	mallet HEATH.....	273
laminectomy retractor forcepsCUSHING.....	340	ligature rings.....	568	mallet KIRK.....	270
laminectomy retractor forcepsFERRIS-SMITH.....	343	ligature scissors.....	54	mallet LUCAE.....	271
laminectomy retractor forcepsLOVE-GRUENWALD.....	340	ligaturee needle.....	218	mallet MEAD.....	271
laminectomy retractor SCOVILLE.....	196	ligaturee needle COOPER.....	219	mallet OMBREDANNE.....	273
laminectomy retractor SCOVILLE-HAVERFIELD.....	196	ligaturee needle DESCHAMPS.....	218	mallet PARTSCH.....	271
LANCASTER eye specula.....	371	ligaturee needle KRONECKER.....	219	mallet QUISLING.....	271
lancet electrode MONOPOLAR.....	628, 629	ligaturee needle NELSON.....	219	mallet WILLIGER.....	271
LANDAU vaginal specula.....	577	ligaturee needle SCHMIEDEN-DICK.....	219	MALTZ (COTTLE) nose rasp.....	444
LANDOLT TUMOR grasping forceps.....	341/2	light guide HOLLINGER.....	37	MALTZ nose rasp.....	443
LANE bender.....	325	light guide JACKSON.....	37	mamaria sternum retractor.....	486
LANE bone holding forceps.....	244	lip retractor.....	453	mandibular body retractor HARGIS.....	463/6
LANE bone levers.....	290	LISTER bandage scissors.....	69/1	MANDRIN for tourniquet.....	528
Lane bone levers.....	290	LISTER SUPERCUT scissors.....	72	MANOMETER.....	295, 596
LANE bone plate holding forceps.....	325	LISTER(SINUS) dressing forceps.....	137	marker CONNIN-AMSLER.....	380
LANE screw driver.....	323, 324	LISTER-BURCH eye specula.....	370	MARQUARD bone rongeur.....	239
LANE srewholdingforceps.....	325	LISTON amputation knives.....	44	MARSCHIK tonsil forceps.....	468
LANE stomach clamp.....	547	LISTON bone cutting forceps.....	241	MARTEL grasping forceps.....	110
LANE surgical tissue forceps.....	84	LITTAUER cilia forceps.....	395	MARTIN bone holding forceps.....	246
LANE towel clamp.....	133	LITTAUER ear forceps.....	411	MARTIN CARTILAGE scissors.....	65/1
LANE TRETOWAN bone levers.....	290	LITTAUER polyp forceps.....	425	MARTIN pelvimeter.....	605
LANG extraction dissector.....	378	LITTAUER suture scissors.....	66	MARTIN retractor.....	175/1
LANG interchangeeable tips.....	472	LITTLE retractor.....	157	MARTIN uterine-probes.....	586
LANG nose hook.....	448	LITTLE IRIS scissors.....	55	MARTINI bone curettes.....	257
LANG-HOHMANN.....	286	LITTLEWOOD intestinal grasping forceps.....	538	MASING septum elevator.....	437
LANGENBECK.....	311, 409				

MASSING-NEIVERT nose hook	447/1	METZENBAUM TC dissecting scissors	53/1	MORITZ-SCHMIDT tongue depressors	452
MASSON needle holder	210	MEYER bone holding forceps	248	MORRIS retractor	164
MASTIN muscle clamp	479	MEYERDING retractor	157	MORRIS-DEBAKEY aortic clamp	506
MATHIEU foreign body forceps	553/1	MEYERDING retractors	180	MORSE rib spreader	484
MATHIEU needle holder	213	MEYHOEFER chalazio curette	377	MORSE-FAVALORO rib spreader	484
MATHIEU rectal-specula	560	MICHEL clip	224	mouth gags DAVIS-BOYLE	455
MATHIEU retractor	141	MICHEL clip forceps	224	mouth gags DENHART	454
MATHIEU-OLSEN needle holder	212	MICHEL clip tissue forceps	224	mouth gags DINGMANN	456
MATSON raspatories	279	MICHEL laryngeal mirror	423	mouth gags HEISTER	454
MATSON-ALEXANDER raspatories	279	micro ear forceps	413	mouth gags JENNINGS	454
MAXI GRASPER biopsy forceps	593	micro ear forceps COS	414	mouth gags McIVOR	457
MAYFIELD bone rongeur	238	micro ear forceps DIETER	414	mouth gags ROSER-KOENIG	454
MAYO dissecting scissors	52	micro ear forceps GREVEN	414	mouth gagsDOYEN-JANSEN(MOLT)	454
MAYO gall stone curette	534	micro ear forceps HAUGH	414	MOYNIHAN gall stone probes	531
MAYO gall stone probes	534	micro ear forceps JUERS	414	MOYNIHAN hemostatic clamp	121
MAYO sterilization clamp	227	micro ear forceps McGEE	414	MOYNIHAN towel clamp	133
MAYO supercut scissors	71	micro ear scissors BELLUCCI	413	MUCK knives	420
MAYO tissue forceps	89	micro ear scissors SHEA	413	MUELLER eye specula	371
MAYO tongue depressors	451	MICRO FRIEDMANN	234	MÜLLER APPROXIMATOR	364
MAYO-ADAMS retractors	171	MICRO FRIEDMANN bone rongeur	234	MÜLLER vascular clip	365
MAYO-BLAKE gall stone forceps	530/2	micro scissors	76, 77, 78, 80	MÜNCHEN biopsy curette	587
MAYO-COLLINS retractor	141	micro scissors BELLUCCI	417	MURDOCK eye specula	370
MAYO-COLLINS retractor Set	141	micro scissors GOMEL	80	MURPHY retractor	156
MAYO-HABERISSER wire forceps	319	micro scissors HEPP-SCHIEDL	78	MURPHY-LANE elevator	283
MAYO-HEGAR needle holder	209	micro scissors REDA	77, 78, 80	muscle clamp MASTIN	479
MAYON-GUYON hemostatic clamp	122	micro sickle knives	475	muscle forceps PRINCE	387
MAYO-NOBLE dissecting scissors	52	micro tissue forceps	94	musclehook	267
MAY-OPHTHALMOSKOP UNI	14	micro-curette forceps WULLSTEIN	416	musclehook GREEN	375
MAYO-ROBSON intestinal clamp	541	micro-grasping forceps tube shaft	415	muscle forceps BERKE	389
MAYO-STILLE dissecting scissors	52	MICRO-HARTMANN hemostatic clamp	104	MUSEUX hook forceps	583
MAYO-STILLE supercut scissors	71	microsurgical tissue forceps GOMEL	96	MYLES nose forceps	427
MC DONALD elevator	283	MICROVASCULAR needle holder	210	myoma knives SEGOND	594
MC GIVNEY haemorrhoidal LIGATOR	568	MIDDELDORPF retractor	160	myoma screw DOYEN	594
MC INDOE bone cutting forceps	241	MIDDLETON-JANSEN septum forceps	430		
MC KENZIE drill	299	MIKULICZ intestinal clamp	543	N	
MCCULLOUGH strabismus forceps	385	MIKULICZ peritoneum clamp	123	NABATOFF varicose vein probes	201
MCGEE hook	419	MIKULICZ retractor	163	NAEGELE obstetrical forceps	603
MCGEE micro ear forceps	414	MIKULICZ-BABY peritoneum clamp	123	NAGER retractor	465
MCINDOE scissors	65/1	MILLER laryngoscope	30	NAGER tonsil needle	466
MCINDOE tissue forceps	85	MILLER nose rasp	444	nail brushes	611
MCINTOSH laryngoscope	29, 31	MILLIGAN dura dissector	332	nail drill	297
MCINTYRE eye cannula	394	MILLIN bladder retractors	552	nail files	612/1
MCIVOR mouth gags	457	MILLIN bladder spreader	553	nail forceps	609, 613
MCKENTY septum elevator	437, 438	MILLIN capsular grasping forceps	551	nail forceps Anvil	613
MCKENZIE applier forceps	326	MILLIN prostatic grasping forceps	551	nail forceps Radolf	297
MCLEAN obstetrical forceps	603/1	Mini bulldog clamp DEBAKEY-DIETHRICH	101	nail forceps TURNBULL	609
MCLEAN-LUIKART obstetrical forceps	603/1	Mini quick handle	301	nail impactor	322/1
MCLEAN-TUCKER-LUIKART obstetrical forceps	603/1	mini scalpel	41	nail nippers	612/2, 613, 614
MCPHERSON tissue forceps	392	mini scalpel handle	41	nail rasp	610
MEAD bone rongeur	235	Mini-bulldog clamp	101	nail scissors	609
MEAD mallet	271	MINI-LAMBOTTE chisels	262	nail SET	609
Measurement circle CASTROVIEJO	380	MINIMUS Sphygmomanometer	11, 12	nail skin forceps	613
Measuring instrument IWANSON	624	MINI-TOWNSEND-DOWN biopsy forceps	591	nail skin forceps	610, 613
medicine cup	621	MINI-TOWNSEND-UP biopsy forceps	591	Nail splitting scissors	614
medicine spoon	621	MIXTER gall stone forceps	530/2	needle BARBARA	419
MEEKER hemostatic clamp	119	MIXTER hemostatic clamp	116, 119, 120, 121	needle electrode MONOPOLAR	628, 629
MEHDORN applier forceps	362	MIXTER hemostatic clamp S-cvd	116	needle guide IOWA	206
MEHDORN vascular clip	362	MIXTER-BABY hemostatic clamp	119	needle holder ADSON	211
MELLINGER eye specula	370	MIXTER-O'SHAUGNESSY	120	needle holder ARRUGA	214
MELLINGER-AXENFELD eye specula	370	MIXTER-O'SHAUGNESSY hemostatic clamp	120	needle holder BABY-OLSEN-HEG	212
MENGHINI biopsy needle	206	MODELL BONN iris tissue forceps	387	needle holder BABY-WEBSTER	208
meniscus hook BLOUNT	289	MOELTGEN goniometer	25	needle holder BARRAQUER	217
meniscus knives NEFF	292	MOGEN circumcision instrument	556	needle holder BARRAQUER Micro	216
meniscus knives SMILLIE	292	MOLLISON retractors	171	needle holder BAUMGARTNER	208
MERCEDES thoracic spreader	489	MOLT raspatories/LUM	276	needle holder BOYNTON	214
MERIAM teeth tissue forceps	93	MONOPOLAR electrode ball	628, 629	needle holder BOZEMANN	211
METAL catheter	555	MONOPOLAR electrode lancet	628, 629	needle holder BROWN	209
Metal catheter COXETER	555	MONOPOLAR electrode loop	628, 629	needle holder CASTROVIEJO	215
METZENBAUM "S" surgical scissors	54	MONOPOLAR electrode needle	628, 629	needle holder Castroviejo	216
METZENBAUM dissecting scissors	53/1	MOOR gall stone scoop	531	needle holder CASTROVIEJO Micro	215
METZENBAUM FINO TC dissecting scissors	53/1	MOORE bone hand drills	298	needle holder cheek/STEEN	210
METZENBAUM needle holder	211	MOORFIELD tissue forceps	392	needle holder COLLIER	208
METZENBAUM supercut scissors	71	MORGAN proctoscope	565	needle holder CRILE	213

needle holder CRILE-MURRAY	209	nose forceps SCHMEDEN	427	OLIVECRONA dura dissector.....	332
needle holder CRILE-WOOD TC.....	209	nose forceps STRUYCKEN.....	427	OLIVECRONA wire saw.....	332
needle holder DE BAKERY	210	nose forceps TAKAHASHI.....	427	OLIVECRONA-TOENNIS applicator forceps.....	326
needle holder DERF	208	nose forceps WATSON-WILLIAMS	428	OLLIER retractor.....	162
needle holder FINOCCHIETTO	211	nose forceps WEIL-BLAKESLEY	426	OLSEN-HEGAR needle holder.....	212
needle holder GILLIES	212	nose hook.....	447	OMBREDANNE mallet.....	273
needle holder HALSEY	208	nose hook AUFRICHT	447	Ophthalmoskop MAY UNI II.....	14
needle holder HALSEY	208	nose hook CONVERSE	448	OP-laryngoscope HOLINGER.....	37
needle holder HEANEY	210	nose hook COTTLE	447, 447/1	OP-laryngoscope JACKSON.....	37
needle holder HOESEL.....	213	nose hook LANGE	448	OP-laryngoscope KLEINSASSER	35
needle holder JACOBSON	215	nose hook MASING-NEIVERT.....	447	ophthalmologic scissors	57, 58
needle holder JOHNSON	211	nose rasp FOMON	444, 445	ophthalmologic scissors AEBLI	58
needle holder KALT-ARRUGA.....	214	nose rasp JOSEPH.....	443	ophthalmologic scissors GRADLE	57
needle holder KILNER	212	nose rasp JOSEPH (LEWIS).....	443	ophthalmologic scissors STEVENS	58
needle holder LANGENBECK	213	nose rasp MALTZ	443	Oscillation plaster cast saw and accessories.....	230/10 - 230/18
needle holder LICHTENBERG.....	213	nose rasp MALTZ (COTTLE).....	444	osteotome blade OBWEGESER	464/1
needle holder MASSON.....	210	nose rasp MILLER.....	444	osteotome EPKER.....	464/2
needle holder MATHIEU	213	nose rasp PEET	446	OSTROEM Antrum-punch.....	430
needle holder MATHIEU-OLSEN.....	212	nose rasp WIENER.....	443	O'Sullivan-O'Connor abdominal retractor.....	181
needle holder MAYO-HEGAR.....	209	nose saw JOSEPH	446	O'SULLIVAN-O'CONNOR abdominal retractor.....	576
needle holder METZENBAUM.....	211	nose scissors.....	429	O'SULLIVAN-O'CONNOR abdominal retractors.....	181
needle holder MICROVASCULAR	210	nose scissors COTTLE	58	OTIS urethrotome.....	553
needle holder NEIVERT	208	nose scissors FOMON	58	Otoskope Diagnostic set UNI I.....	13
needle holder OLSEN-HEGAR	212	nose scissors HEYMANN.....	58	OVAL RING.....	194
needle holder RYDER.....	210	nose specula COTTLE	423	OVERHOLT hemostatic clamp.....	114
needle holder SAROT.....	211	nose specula HARTMANN.....	422	OVERHOLT-BABY hemostatic clamp.....	114
needle holder STEVENS.....	214	nose specula HARTMANN-HALLE.....	421	OVERHOLT-GEISENDOERFER hemostatic clamp.....	114
needle holder STRATTE	212	nose specula KILLIAN	423	OVERHOLT-MIXTER hemostatic clamp.....	115
needle holder WEBSTER.....	208	nose specula REDA.....	423	ovum curette CUZZI.....	606
needle nose plier.....	320	nose specula THUDICHUM	421	ovum curette PESTALOZZA	606
needle REVERDIN.....	220	nose specula TIECK-HALLE	423	ovum curette WALLICH.....	607
needle ROSEN	419	nose specula type VIENNA	421	ovum forceps SAENGER.....	606
needle sterilization case	615	nose specula VOLTOLINI	421	ovum forceps WINTER.....	606
needle YOUNG-BOOMERANG	220	noseolive POLITZER	406		
needles.....	222, 223	NOTO uterine polyp forceps	585		
NEFF meniscus knives.....	292	NOVA Sphygmomanometer	6, 7	P	
Negus CHEST SUPPORT	459	NOVAK biopsy curette	587	pan bed	621/1
NEIVERT needle holder.....	208	NOYES eye scissors	75	pan placenta	621/1
NEIVERT-ANDERSON chisel.....	442	NOYES polyp forceps	425	paracentesis needle LUCAE	408
NELATON probes	199	Nucleus Rotator Bechert	379	paracentesis needle POLITZER	408
NELSON ligaturee needle.....	219	nystagmus spectacles FRENZEL.....	20	parametrium clamp REDA	128/1
NELSON STANDARD trocar.....	204			PARAMETRIUM scissors.....	63
NELSON trocar.....	205			PARK eye specula	371
NELSON vascular tissue forceps	89	O		PARKER retractor	139
NEONATAL vascular clamp	523	obstetrical curette SELLHEIM.....	607	PARTSCH chisels	259
Neonatal vascular clamp CASTANEDA	527	obstetrical forceps BARTON	603/2	PARTSCH mallet.....	271
nerve hook CRILE	328	obstetrical forceps BOERMA	604	PASSOW.....	260
nerve hook CUSHING	328	obstetrical forceps DE LEE	602	Passow chisels	260
nerve hook DANDY	328	obstetrical forceps ELLIOT.....	603	PATELLA forceps.....	248
nerve hook GRAHAM	328	obstetrical forceps KIELLAND.....	602	PATON corneal dissector	373
nerve hook HOLSHER.....	329	obstetrical forceps KIELLAND-LUIKART	603	PAUFIQUE Keratoplast.-knives.....	373
nerve hook KRAYENBUEHL.....	336	obstetrical forceps LUIKART	603	PAUFIQUE tissue forceps	392
nerve hook LOVE	329	obstetrical forceps McLEAN	603/1	PAYR guide probes	221/1
nerve hook LOVE	330	obstetrical forceps McLEAN-LUIKART	603/1	PAYR intestinal clamp	548
nerve hook SACHS	328	obstetrical forceps McLEAN-TUCKER.....	603/1	PEAN hemostatic clamp	108
nerve hook SCOVILLE	329, 330	obstetrical forceps McLEAN-TUCKER-LUIKART	603/1	PEAN hemostatic clamp	110
nerve hook SMITHWICK	328	obstetrical forceps NAEGELE	603	PEAN hemostatic clamp	108, 110
NEUGS tonsil forceps	467	obstetrical forceps PIPER	604	PEAPOD rongeur.....	341/1
neurosurgical SCISSOR STRULLY	65	obstetrical forceps SIMPSON.....	602	PECK-JOSEPH dissecting scissors.....	74
neurosurgical scissors.....	65	obstetrical forceps SIMPSON-BRAUN	602	PEDERSON vaginal specula	570
NEWS trachea hook.....	477	obstetrical forceps SIMPSON-LUIKART	603	PEENFIELD dissector.....	333
nippers nail.....	612/2, 613, 614	obstetrical forceps THIERRY	603	PEERS towel clamp	132
Nissen fine hemostatic clamp.....	113	obstetrical forceps WRIGLEY	602	PEET nose rasp	446
NISSEN hemostatic clamp.....	113	OBWEGESER awl.....	463	PEET splinter forceps	92
nmonopolar forceps.....	634	OBWEGESER blade osteotome	464/1	PELMANN dressing forceps	137
noise appartus POLITZER.....	405	OBWEGESER raspatories.....	462	pelvimeter COLLIER.....	605
NORDFOLK-NORWICH retractors.....	172	OBWEGESER retractor.....	460, 461/1	pelvimeter MARTIN	605
NORTHBENT suture scissors.....	66	OBWEGESER retractors	463	Pelvis-hook St.MARKS.....	165
nose dressing forceps LUBET-BARBON	424	OCHSNER trocar.....	205	Penisclamp Stockmann	553/1
nose dressing forceps WESTMACOTT	424	O'CONNOR iris hook.....	375	Penisclamp STRAUSS	553/1
nose forceps CAPLAN	428	OEHLER surgical tissue forceps.....	81/1	PENNINGTON hemostatic clamp	109
nose forceps HARTMANN.....	427	OLDBERG laminectomy retractor forceps.....	341/1	PENNINGTON septum elevator	438
nose forceps MYLES.....	427	OLIVECRONA bone rongeur	237	percussion mallet BABINSKY	24
		OLIVECRONA brain spatula	336		

percussion mallet BERLINER.....	24	PRATT fistula probes.....	563	raspatoriesium WIBERG.....	277
percussion mallet BUCK.....	24	PRATT grasping forceps.....	110	raspatoriesSEDLLOT.....	274, 275
percussion mallet TAYLOR.....	24	PRATT hook forceps.....	584	raspatory HARGIS.....	463/2
percussion mallet TROEMNER.....	24	PRATT rectal-specula.....	559	raspatory SELDING.....	277
PERCY RETRAKTOR.....	296	PRATT uterine Dilatatator.....	580	RAZOR blades.....	45
perforators SMELLIE.....	607	PRECISA Sphygmomanometer.....	9	reamer KUENTSCHER.....	321
Peripheral vascular clamp DE BAKEY.....	494	PRICE-THOMAS bronchus clamp.....	490	reamer KUENTSCHER.....	321
Peripheral vascular clamp LELAND-JONES.....	495	PRINCE muscle forceps.....	387	RECAMIER uterine curette.....	597
peritoneum clamp FAURE.....	123	PRINCE tonsil scissors.....	59	rectal biopsy forceps TURREL.....	567
peritoneum clamp MIKULICZ.....	123	PROBE AND PACKER.....	612	rectal suction tube BUIE.....	566
peritoneum clamp MIKULICZ-BABY.....	123	probe tips.....	201	rectalbiopsy forceps YEOMAN.....	566, 567
peritoneum clamp PHANEUF.....	123	probes.....	199	rectalsnare WESTON.....	566
PERKINS retractors.....	168	probes BRODIE.....	199	rectal-specula ALAN-PARKS.....	561
PERTHES awl.....	304	probes DOYEN.....	199	rectal-specula BARR.....	559
PESTALOZZA ovum curette.....	606	probes FISH.....	199	rectal-specula BODENHAMMER.....	559
petri box.....	620	probes Harms.....	333	rectal-specula CZERNY.....	559
PETZ stomach and intestinal suturing apparatus.....	549	probes JACOBSON.....	335	rectal-specula HILL-FERGUSSON.....	560
PHALANGEN knives.....	44	probes KOCHER.....	479	rectal-specula MATHIEU.....	560
PHANEUF peritoneum clamp.....	123	probes NELATON.....	199	rectal-specula PRATT.....	559
PIERCE septum.....	438	probes Valleix.....	586	rectal-specula SAWYER.....	560
PIERCE trocar.....	204	probes WATSON-CHEYNE.....	199	rectal-specula SCHULZE-BERG.....	560
PIFFARD LUPUS curette.....	608	probes Worst.....	333	rectal-specula SIMS.....	559
PILLING clip forceps.....	524	protoscope Bensaude.....	565	rectum clamp HAYES.....	545
pin cutter.....	320	protoscope CHELSEA-EATON.....	563	REDA tuning forc.....	403
PINARD stethoscope.....	23	protoscope FANSLER.....	564	REDA amputation knife.....	44
PINWHEEL WARTENBERG.....	25	protoscope KELLY.....	562, 563	REDA blade breaker.....	45
PIPER obstetrical forceps.....	604	protoscope Morgan.....	565	REDA bone currettes.....	256
Pistol for cleaning.....	626	protoscope MILLIN.....	551	REDA bone hand drills.....	300
pituitary rongeur.....	341	prostatic grasping forceps MILLIN.....	551	REDA bone holding forceps.....	246, 247
placenta pan.....	621/1	prostatic hook YOUNG.....	550	REDA cilia forceps.....	395
plaster cast saw ENGEL.....	229	PROVIDENCE-HOSPITAL hemostatic clamp.....	106	REDA cotton-applicator.....	203
plaster cast saw oscillating and accessories.....	230/10 - 230/18	punch KEYES.....	608	REDA EXCENTER bandage scissors.....	69/2
plaster forceps WOLFF.....	233	punction cannula FRAZIER.....	337	REDA eye magnet.....	395
plaster knives ESMARCH.....	233	punction cannula QUINKE.....	206	REDA Finger ring saw.....	297
plaster knives HOPKINS.....	233	PUTTI bone rasp.....	294	REDA intestinal grasping forceps atrauma.....	111
plaster knives REINER.....	233	Pylorusretractor BENSON.....	544	REDA nose specula.....	423
plaster knives WIGMORE.....	229	Q		REDA parametrium clamps.....	128/1
plaster retractor BEESON.....	232	QUERVAIN elevator.....	275	REDA plaster retractor.....	232
plaster retractor HAGLUND-STILLE.....	232	quick handle.....	301	REDA sickle knives.....	435
plaster retractor HENNIG.....	232	QUINBY gum scissors.....	67	REDA skin hook.....	150
plaster retractor REDA.....	232	QUINKE punction cannula.....	206	REDA sterilization forceps.....	615
plasterscissorsSTILLE.....	229	QUIRE foreign body lever.....	412	REDA suture fork.....	221/1
platte JAEGER.....	371	QUISLING mallet.....	271	REDON guide needle.....	207
PLESTER knives.....	418	R		REES FACE LIFT scissors.....	73
PLESTER retractors.....	171	RACHOTOM.....	267	REICHERT DECKEL epiglottis retractor.....	471
PLESTER suction tube.....	338	RADOLF nail forceps.....	297	REILL bone holding forceps.....	248
pneumatic tournique.....	295	RALK bone hand drills.....	300	REINER ear syringe.....	406
POLITZER air blower.....	406	RAMPLEY dressing forceps.....	136	REINER plaster knives.....	233
POLITZER ear knives.....	408	RAMUS retractor.....	461	REKORD syringe.....	596
POLITZER ear specula.....	399	RANDALL biopsy curette.....	587	RESANO capsula scissors.....	53/2
POLITZER noseOLIVE.....	406	RANDALL kidney stone forceps.....	535	RESANO intestinal clamp.....	542
POLITZER paracentesis needle.....	408	RANEY appling forceps.....	327	RESECTION knives.....	47
polyp forceps HARTMANN.....	424	RANGELL retractor.....	140	retractor ALM.....	168
polyp forceps LITTAUER.....	425	raspatories.....	279	retractor ANDERSON.....	198
polyp forceps NOYES.....	425	raspatories ADSON.....	282	retractor assembly.....	188
polyp loop.....	411	raspatories ALEXANDER.....	276	retractor AUFRANC.....	289
polyp snare KRAUSE.....	433/2	raspatories COBB.....	280	retractor breast.....	198
polyp snare KRAUSE.....	411, 434	raspatories DINGMANN.....	463, 463/3	retractor BRUNNER.....	167
polyp snare KRAUSE-VOSS.....	433/2	raspatories DOYEN.....	278	retractor COLLIN.....	139
polyp snare WILDE.....	433/2	raspatories FARABEU.....	274	retractor COLLIN HARTMANN.....	141
polyp snare WILDE.....	411, 434	raspatories FARABEU-COLLIN.....	274	retractor COOLEY.....	148
POOLE suction tube.....	27	raspatories FOMON.....	277	retractor CORONAL BLOW LIFT.....	198
POST MORTEM.....	268	raspatories JOSEPH.....	277	retractor CORYLLOS.....	166
POST MORTEM knives.....	48	raspatories KOENIG.....	276	retractor CRILE.....	140
POST MORTEM knives VIRCHOW.....	48	raspatories LAMBOTTE.....	274	retractor CUSHING.....	151
post mortem set.....	269	raspatories LANGENBECK.....	275	retractor CZERNY.....	141
POTTS SMITH tissue forceps.....	81	raspatories MATSON.....	279	retractor DAVIDSON (Scapula).....	166
POTTS-DE MARTEL vascular scissors.....	59	raspatories MATSON-ALEXANDER.....	279	retractor DEEVER.....	145
POTTS-SMITH tissue forceps.....	81	raspatories OBWEGESER.....	462	retractor DEEVER GRIP.....	146
POTTS-SMITH vascular scissors.....	61	raspatories SEMB.....	278	retractor DEBAKEY.....	189/1
POZZI-PALMER tenaculum forceps.....	582	raspatories WILLIGER.....	276	retractor DELEE.....	574
		raspatoriesium MOLT.....	276	retractor DESMARRES.....	151
				retractor DESMARRES.....	151

retractor DOYEN.....	163	retractors BECKMANN.....	176	rongeur HAJEK-KOFLER.....	429, 431
retractor DOYEN-STILLE.....	167	retractors BECKMANN-ADSON.....	175	rongeur HOLTH.....	380
retractor FARABEUF.....	139	retractors BECKMANN-EATON.....	176	rongeur KERRISON.....	428
retractor FERRIERA.....	197	retractors CASPAR.....	179, 180	rongeur PEAPOD.....	341/1
retractor FINSEN.....	168	retractors DARLING.....	178	ROSE retractor.....	140
retractor Freeman.....	198	retractors HENLEY.....	170	ROSEN knives.....	418
retractor FRITSCH.....	163	retractors MAYO-ADAMS.....	171	ROSEN needle.....	419
retractor GIL-VERNET.....	152	retractors MEYERDING.....	180	ROSEN suction tube.....	338
retractor GOELET.....	141	retractors MOLLISON.....	171	ROSER-KOENIG.....	454
retractor GREEN.....	160	retractors NORFOLK NORWICH.....	172	ROSS retractor.....	148/1
retractor HARRINGTON.....	147	retractors PERKINS.....	168	ROUND RING MEDIUM.....	194
retractor HARRINGTON-PEMBERTON.....	147	retractors PLESTER.....	171	ROUX MINI retractor.....	140
retractor HASSON.....	143	retractors SCALP-CONTOUR.....	169	ROUX retractor.....	139
retractor HEANEY.....	164	retractors TRAVERS.....	172	ROUX-BABY retractor.....	140
retractor HIBBS.....	164	retractors WEITLANER.....	169	ROWE reposition forceps.....	459
retractor HOESEL.....	167	retractors WULLSTEIN.....	171	RUBIN septum forceps.....	428
retractor HOFER.....	465	Retraktor PERCY.....	296	RUDD haemorrhoidal ligator.....	568
retractor HOLZHEIMER.....	168	REVERDIN intestinal spatula.....	143/3	ruler metal.....	25
retractor ISRAEL.....	162	REVERDIN needle.....	220	RUMEL hemostatic clamp.....	117
retractor JACKSON-BURROWS.....	189/2	REYNOLDS supercut scissors.....	72	RUMEL-BELMONT tourniquet.....	528
retractor JANSEN.....	168	REYNOLDS surgical scissors.....	54	RuSkin bone rongeur.....	239
retractor KELLY.....	164	rhinoplastic scissors FOMON.....	65/1	RuSkin-LISTON bone cutting forceps.....	241
retractor KELLY GRIP.....	142	rib contractor SELLORS.....	489/1	RUSS MODELL grasping tissue forceps.....	85
retractor KLAPP.....	150	rib scissors.....	480	RUSSEL-DAVIS mouth gag.....	458
retractor KOCHER.....	155	rib scissors BETHUNE.....	481	RYDEL-SEIFFERT tuning forc.....	404
retractor KOCHER.....	160, 163	rib scissors BRUNNER.....	481	RYDER needle holder.....	210
retractor KOCHER-LANGENBECK.....	159	rib scissors CORYLLOS.....	480		
retractor KOERTE.....	162	rib scissors GIERTZ-STILLE.....	481		
retractor KÖNIG.....	153	rib scissors GLUCK.....	480		
retractor LAHEY.....	157	rib scissors SAUERBRUCH.....	481		
retractor LANGENBECK.....	158, 159	rib scissors SAUERBRUCH-FREY.....	481		
retractor LANGENBECK-GREEN.....	153	rib scissors STILLE.....	480		
retractor LITTLE.....	157	rib spreader BAILEY.....	489/1		
retractor LOVE.....	465	rib spreader BAILEY-BABY.....	489/1		
retractor MARTIN.....	175/1	rib spreader BAILEY-GIBBON.....	489/1		
retractor MATHIEU.....	141	rib spreader COOLEY.....	487		
retractor MEYERDING.....	157, 177	rib spreader COOLEY-NEONATAL.....	485		
retractor MEYERDING.....	177	rib spreader DE BOER.....	486		
retractor MIDDELDORFF.....	160	rib spreader FINOCCHIETTO.....	482, 484		
retractor MIKULICZ.....	163	rib spreader FINOCCHIETTO-BURFORD.....	483		
retractor MORRIS.....	164	rib spreader HAIGHT.....	487		
retractor MURPHY.....	156	rib spreader MORSE.....	484		
retractor NAGER.....	465	rib spreader MORSE-FAVALORO.....	484		
retractor OBWEGESER.....	460, 461/1	rib spreader RIENHOFF-FINOCCHIETTO.....	486		
retractor OLLIER.....	162	rib spreader TUFFIER.....	487		
retractor PARKER.....	139	RIBBON intestinal spatula.....	143/1		
retractor RAGNELL.....	140	RICARD abdominal retractor.....	191		
retractor RAMUS.....	461	RICHARDSON retractor.....	142		
retractor RICHARDSON.....	142	RICHARDSON-EASTMAN retractor.....	142		
retractor RICHARDSON GRIP.....	142	RICHARDSON-GRIP retractor.....	142		
retractor RICHARDSON-EASTMAN.....	142	RICHNAU-HOLMGREN ear specula.....	400		
retractor ROSE.....	140	RICHTER-HEATH clip forceps.....	224		
retractor ROSS.....	148/1	RIENHOFF-FINOCCHIETTO rib spreader.....	486		
retractor ROUX.....	139	RIGBY abdominal retractor.....	189/2		
retractor ROUX-BABY.....	140	RI-MINI Diagnostic set.....	17		
retractor ROUX-MINI.....	140	RING tongue depressors.....	455		
retractor SAUERBRUCH.....	164	rings ligature.....	568		
retractor SAUERBRUCH.....	164, 166	RITTER-HALLE irrigation cannula.....	433		
retractor SENN-GREEN.....	153	ROBB spatula.....	530		
retractor SENN-MILLER.....	143	ROBERTS hemostatic clamp.....	117		
retractor SIMON.....	164	ROCHARD abdominal retractors.....	186		
retractor SPINA-NASALIS.....	461	ROCHESTER-CarmALT hemostatic clamp.....	109		
retractor TEBBETS.....	197	ROCHESTER-OCHSNER hemostatic clamp.....	108		
retractor TESSIER.....	463/3	ROCHESTER-PEAN hemostatic clamp.....	108		
retractor TUFFIER.....	147	ROEDER towel clamp.....	132		
retractor US-army PARKER-LANGENBECK.....	141	ROGER septum.....	437		
retractor VOLKMANN.....	153	ROGERS hysterectomy clamp.....	127		
retractor VOLKMANN.....	156	ROGGE sterilization forceps.....	227		
retractor YANCOSKIE.....	198	ROLLET EXTIRPATION chisels.....	374		
retractor ZENKER.....	161	ROLLET extraction hook.....	375		
retractors ADSON.....	173	rongeur CITELLI.....	430		
retractors ADSON.....	172, 173, 174	rongeur DECKER.....	341		
retractors ANDERSON-ADSON.....	172	rongeur FERRIS-SMITH-KERRISON.....	344, 344/2		

S

SAALFELD comedone extractor.....	608
SACHS dura dissector.....	332
SACHS nerve hook.....	328
SAENGER ovum forceps.....	606
sagittal split retractor SMITH.....	463/5
SaipingographSCHULTZE.....	596
SANVENERO surgical scissors.....	54/1
SAROT hemostatic clamp.....	118
SAROT needle holder.....	211
SATINSKY tangential clamp.....	502
SATINSKY vascular clamp.....	491
SATINSKY vascular scissors.....	65/1
SATTERLEE amputation saw.....	296
SAUERBRUCH bone rongeur.....	240
SAUERBRUCH retractor.....	164
SAUERBRUCH retractor.....	164, 166
SAUERBRUCH rib scissors.....	481
SAUERBRUCH wasteforceps.....	227
SAUERBRUCH-FREY sternum scissors.....	481
saw GIGLI.....	332
SAWLETT tonsil forceps.....	467
SAWYER rectal specula.....	560
SAYRE elevator.....	281
SCAGLIETTI bone rongeur.....	240
scalp forceps GAUSS.....	605
SCALP-CONTOUR retractors.....	169
scalpel.....	46
scalpel blade.....	42
scalpel blade remover.....	42
scalpel handle.....	38, 39, 39/1, 39/2, 40, 42
scalpel handle COLLIN.....	40
scalpel handle MINI.....	41
scalpel MINI.....	41
SCHAEDEL towel clamp.....	132
SCHAMBERG comedone extractor.....	608
SCHAEDE bone currettes.....	251
SCHAEIE goniotomy knives.....	373
SCHHEINMANN interchangeable tips.....	472
SCHERBAK vaginal specula.....	575
SCHINK dermatome.....	49
SCHIOETZ tonometer.....	394/2
SCHLESINGER laminectomy retractor forceps.....	342
SCHMEDEN nose forceps.....	427
Schmid vascular-irrigation cannula.....	338
SCHMIEDEN guideprobes.....	221

SCHMIEDEN-DICK ligaturee needle.....	219, 221	septum chisels FREER.....	439	skin hook FREER.....	448
SCHMIEDEN-TAYLOR durascissors.....	65/1	septum chisels SHEEHAN.....	441	skin hook GILLIES.....	448
SCHNIDT tonsil forceps.....	467	septum chisels SILVER.....	442	skin hook GRAEFE.....	148/2
SCHOENBORN thyroid gland hook.....	479	septum elevator BALLENGER.....	439	skin hook GUTHRIE.....	148/2
SCHRÖDER hook forceps.....	583, 584	septum elevator COTTLE.....	439	skin hook JOSEPH.....	149
SCHRÖDER uterine curette.....	595	septum elevator COTTLE-JOSEPH.....	439	skin hook KILNER.....	608
SCHROEDER(POZZI) hook forceps.....	582	septum elevator FREER.....	437	skin hook KLEINERT-KUTZ.....	149
SCHUBERT biopsy forceps.....	588	septum elevator HAJEK-BALLENGER.....	439	skin hook REDA.....	150
SCHUKNECHT knives.....	418	septum elevator HALLE.....	437	skin punch KEYE.....	608
SCHULTZE salpingrograph.....	596	septum elevator HOWARTH.....	438	skin punch KEYE.....	608
SCHULZE-BERGMANN rectal-specula.....	560	septum elevator JOSEPH.....	437	skin scissors.....	610
SCHUMACHER biopsy forceps.....	588, 589	septum elevator KILLIAN.....	438	skin STRAIGHTENING blade FOR DERMATOME.....	49
SCHUMACHER episotomy scissors.....	64	septum elevator MASING.....	437	slip joint plier.....	317
SCHUMACHER interchangeable tips.....	472	septum elevator MCKENTY.....	437, 438	SLS clip forceps.....	524
SCHUMACHER sternum scissors.....	481	septum elevator PENNINGTON.....	438	SLUDER-BALLENGER.....	470
SCHWEIGGER capsular forceps.....	391	septum elevator PIERCE.....	438	SMELLIE hook.....	605
scissors CASTROVIEJO.....	79	septum elevator ROGER.....	437	SMELLIE perforators.....	607
scissors CASTROVIEJO.....	79	septum forceps BRUENINGS.....	425	SMILLIE bone levers.....	291
scissors COTTLE.....	56	septum forceps HEYMANN.....	425	SMILLIE meniscusknives.....	292
scissors DOYEN.....	63	septum forceps KNIGHT.....	425	SMITH eye specula.....	370
scissors enterotomy.....	66	septum forceps LUC.....	426	SMITH ramus separator.....	463
scissors ENUCLEATION.....	58	septum forceps MIDDLETON-JANSEN.....	430	SMITH sagittal split retractor.....	463/5
scissors GORNEY.....	73	septum forceps RUBIN.....	428	SMITH US army bandage scissors.....	69/1
scissors GRAEFE.....	56	septum gouges FREER.....	442/1	SMITH-BUIE ANAL retractor.....	561
scissors HEPP-SCHEIDEL.....	78	septum gouges HAJEK.....	442/1	SMITH-PETERSEN.....	261
scissors MARTIN CARTILAGE.....	65/1	septum gouges KILLIAN-CLAUS.....	442/1	SMITH-PETERSEN bone rongeur.....	238
scissors McINDOE.....	65/1	septum knives CONVERSE.....	435	SMITHWICK applicator forceps.....	326
scissors micro.....	76	septum knives COTTLE.....	435	SMITHWICK nerve hook.....	328
scissors neurosurgical.....	65	septum knives FREER.....	434	SNELLEN cataract loop.....	378
scissors Parametrium.....	63	septum knives JOSEPH.....	434, 435	SNELLEN Entropium forceps.....	393
scissors REES.....	73	septum scissors KILLIAN.....	471	SOMER uterine-grasping forceps.....	585
scissors SIEBOLD.....	62	septum straightening forceps ASCH.....	449	spare blade.....	49
scissors SIMS.....	62	septum straightening forceps WALSHAM.....	449	spatula.....	203, 530/1, 612
scissors THOREK.....	65/2	SERPENTINE biopsy forceps.....	593	SPATULA AND PACKER.....	612
scissors WAGNER.....	67	SEUTIN bandage scissors.....	69/2	spatula Hirschman.....	379
scissors WERTHEIM.....	63	SEXTON ear knives.....	408	specula FRIEDMANN.....	577
sclerotome GUYTON-LUNDSGAARD.....	373	SHAPLEIGH ear loop.....	410	specula KALLMORGEN.....	573
sclerotome LUNDGAARD.....	373	SHAVER knives.....	49	specula KRISTELLER.....	572
SCOVILLE bone curette.....	253	SHEA micro ear scissors.....	413	specula O'SULLIVAN-O'CONNOR.....	576
SCOVILLE hook.....	196	SHEEHAN chisels.....	441	SPENCER suture scissors.....	66
SCOVILLE laminectomy retractor.....	196	SHEETS eye cannula.....	394/2	SPENCER-WELLS hemostatic clamp.....	109
SCOVILLE nerve hook.....	329, 330	sickle knives REDA.....	435	Sphygmomanometer BABYPHON.....	10
SCOVILLE-HAVERFIELD laminectomy retractor.....	196	SIEBOLD gynecological scissors.....	62	Sphygmomanometer DIPLOMAT.....	5
screw driver.....	232	SIEGLE ear specula.....	402	Sphygmomanometer EXACTA.....	8
screw driver LANE.....	323	Silver clips.....	326	Sphygmomanometer MINIMUS.....	11, 12
screw driver WILLIAMS.....	323	SILVER DERMATOM.....	50	Sphygmomanometer NOVA.....	6, 7
screw holding sleeve.....	324	SILVER septum chisels.....	442	Sphygmomanometer PRECISA.....	9
SCUDDER intestinal clamp.....	541	SIMCOE irrigation cannula.....	394/2	SPINAL bone currettes.....	253
SEBILÉAU elevator.....	275	SIMON retractor.....	164	Spinal hook TAYLOR.....	291
Section needle.....	268	SIMON uterine curette.....	594	SPINA-NASALIS retractor.....	461
SEDLLOT raspatories.....	274	SIMPLEX tubing clamp.....	624	splinterforceps ARCHER.....	92
SEGMENTED RING.....	194	SIMPSON obstetrical forceps.....	602	splinterforceps PEET.....	92
SEGOND hysterectomy clamp.....	125	SIMPSON-BRAUN obstetrical forceps.....	602	splinterforceps VIRTUS (RALK).....	92
SEGOND myoma knives.....	594	SIMPSON-LUIKART obstetrical forceps.....	603	splinterforcepsSTIEGLITZ.....	92
SEGOND-LANDAU hysterectomy clamp.....	125	SIMS gynecological scissors.....	62	splinterforceps forceps.....	91
SEIFERT interchangeable tips.....	472	SIMS rectal-specula.....	559	splinterforceps forceps CARMALT.....	91
SELDIN raspatory.....	277	SIMS uterine curette.....	597	splinterforceps forceps FEILCHENFELD.....	91
SELLHEIM obstetrical curette.....	607	SIMS uterine depressor.....	586	splinterforceps forceps HUNTER.....	91
SELLORS rib contractor.....	489/1	SIMS uterine dilator.....	581	spoon medicine.....	621
SEMB bone cutting forceps.....	242	SIMS uterine probes.....	586	SPRATT bone currettes.....	251
SEMB bone holding forceps.....	243	SIMS vaginal specula.....	573	spreader DAVIS-BOYLE.....	455
SEMB bone rongeur.....	240	SIMS-MAIER dressing forceps.....	134	spreader DAVIS-MEYER.....	457
SEMB bronchusclamp.....	491	SINGLEY tissue forceps.....	88	spreader DINGMANN.....	456
SEMB raspatories.....	278	Sinskey hook.....	376	spreader KILNER-DOUGHTY.....	456
SEMKEN anatomic tissue forceps.....	86	Sinus probes.....	438	SPURLING laminectomy retractor forceps.....	340
SEMKEN surgical tissue forceps.....	86	SINUS septum elevator.....	438	sputum cup.....	621/1
SEMM vaginal specula.....	571	sinuscopy forceps.....	431	srewholding forceps LANE.....	325
SENN-GREEN retractor.....	153	sinuscopy-trocar.....	205	ST.CLAIR-THOMSON adenoid curette.....	450
SENN-MILLER retractor.....	143	SKENE hook forceps.....	582	ST.MARKS pelvis hook.....	165
septum cannula.....	406	skin hook COTTLE.....	447, 448	ST.MARTIN tissue forceps.....	392
septum chisels CINELLI.....	441	skin hook COTTLE-NEIVERT.....	448	STACKE earprobes.....	199
septum chisels COTTLE.....	440	skin hook FOMON.....	447/1	STAMMBERGER forceps.....	431
septum chisels FOMON.....	441	skin hook FRAZIER.....	148/2	STAUDE-MOORE hook forceps.....	582

STEINMANN ENDER nail	307, 308	suction tube DEBAKEY	28	TC scissors PECK-JOSEPH	74
STEINMANN tendon holdingforceps	292	suction tube FRAZIER/FERGUSSON	337	TC scissors REES	73
STELLBRINK bone rongeur	234	suction tube HOUSE	337/2	TC surgical scissors STANDARD	51
STERILE scalpel-blade	42	suction tube PLESTER	338	TC tissue forceps CUSHING	83
STERILE spare blade	50	suction tube POOLE	27	TC tissue forceps GILLIES	86
sterilization clamp BUNT	227	suction tube ROSEN	338	TC tissue forceps SEMKEN	86
sterilization clamp MAYO	227	suction tube tube KLEINSASSER	36	TC tissue forceps surgical	81
sterilization forceps	227	suction tube YANKAUER	27	TC tissue forceps WANGENSTEEN	89
sterilization forceps	227	suction tube YASARGIL	337/1	TC tissue forcepsN ANATOMIC	81
sterilization forceps CHEATLE	227	suction tube ZOEGLNER	337/1	TC-scissors Gorney	73
sterilization forceps REDA	615	supercut scissors	71	TC-scissors KAYE	73
sterilization forceps ROGGE	227	supercut scissors BABY METZENBAUM	71	TEALE hook forceps	583
sterilization forceps UNIVERSAL	227	supercut scissors FREEMAN	74	TEBBETTS retractor	197
sterilization tray	622, 623	supercut scissors GORNEY	73	teeth tissue forceps LONDON-COLLEGE	93
sterilization tray	618	supercut scissors IRIS	72	teeth tissue forceps MERIAM	93
STERNBERG cheek retractor	453	supercut scissors KAYE	73	tenaculum forceps ADAIR	582
sternum scissors SCHUMACHER	481	supercut scissors KILNER/RAGNELL	72	tenaculum forceps POZZI-PALMER	582
Sternumchisels LEBSCHKE	267	supercut scissors LAGRANGE	72	tendon grasping forceps	293
stethoscope ANESTOPHON	23	supercut scissors LISTER	72	tendon grasping forceps JACKSON	292
stethoscope DUPLEX	23	supercut scissors MAYO	71	tendon grasping forceps LARSEN	292
stethoscope PINARD	23	supercut scissors MAYO-STILLE	71	tendon grasping instr KLEINERT-KUTZ	294
STEVENS iris tissue forceps	383	supercut scissors METZENBAUM	71	tendon grasping instrument BRAND	293
STEVENS lens hook	375	supercut scissors REES	73	tendon grasping instrument CAROLL	293
STEVENS needle holder	214	supercut scissors REYNOLDS	72	tendon guide BUNELL	294
STEVENS ophthalmologic scissors	58	supercut scissors STEVENS	72	tendon holding forceps STEINMANN	292
STEVENS supercut scissors	72	supercut scissors WAGNER	72	tendon passing instr. BRAND	294
STEVENSON eye specula	371	surgical needle KEITH	223	tendon passing instr. BUNNELL	292
STIEGLITZ splinter forceps	92	surgical needle KOENIG	223	TERSON capsular forceps	391
STILLE anatomic tissue forceps	81	surgical scissors FERGISSON	66	TESSIER retractor	463/3
STILLE bone hand drills	298	surgical scissors fine IRIS	54/2	T-handle	300, 301
STILLE chisels	260	surgical scissors fine JOSEPH	54/1	T-handle HUDSON	300
STILLE chisels	260	surgical scissors fine KILNER	54/1	THIERRY obstetrical forceps	603
STILLE gouges	260	surgical scissors fine REYNOLDS	54/1	THOMAS uterine curette	599
STILLE hemostatic clamp	122	surgical scissors fine SANVENERO	54/1	THOMAS-GAYLOR biopsy forceps	588
STILLE plaster scissors	229	surgical scissors METZENBAUM	51, 54/1	THOMAS-ALLIS intestinal grasping forceps	538
STILLE rib scissors	480	surgical scissors STANDARD	51	THOMSON-WALKER bladder retractors	552
STILLE-LISTON bone cutting forceps	241	surgical scissors SYSTRUNK	66	thoracic spreader MERCEDES	489
STILLE-LUER bone rongeur	239	surgical tissue forceps	81	THOREK scissors	65/2
STILLE-RUSKIN bone rongeur	239	surgical tissue forceps ADSON	81/2	THUDICHUM nose specula	421
STILLE-SHERMAN bone hand drills	298	surgical tissue forceps ADSON Micro	81/2	thyroid gland hook SCHOENBORN	479
STOCKMANN penis clamp	553/1	surgical tissue forceps ADSON-BROWN	82	TIECK-HALLE nose specula	423
stomach clamp LANE	547	surgical tissue forceps BONNEY	88	TILLEY ear forceps	411
stomach-/intestinal suturing apparatus V.PETZ	549	surgical tissue forceps BROPHY	84	TIP for suction tube	27
stomach-intestinal clamp MIKULICZ	543	surgical tissue forceps CUSHING	83	TISCHLER-DOWN biopsy forceps	591
STONE forceps	545	surgical tissue forceps FERRIS-SMITH	85	TISCHLER-KEVORKIAN biopsy forceps	592
Stone holding clamp	545	surgical tissue forceps GERALD	87	TISCHLER-MORGAN biopsy forceps	591
STONE-WATT	545	surgical tissue forceps GILLIES	86	TISCHLER-MORGAN biopsy forceps	590, 591
strabismus forceps BONACCOLTO	385	surgical tissue forceps LANE	84	TISCHLER-UP biopsy forceps	591
strabismus forceps DASTOOR	386	surgical tissue forceps OEHLER TC	81/1	tissue forceps	90, 94
strabismus forceps JAMESON	385	surgical tissue forceps Potts Smith	81	tissue forceps anatomic	81
strabismus forceps McCULLOUGH	385	surgical tissue forceps SEMKEN	86	tissue forceps bipolar	630, 631
strabismus hook GRAEFE	375	surgical tissue forceps STILLE	81	tissue forceps BONNEY	88
strabismus hook JAMESON	375	surgical tissue forceps TAYLOR	87	tissue forceps BROWN	83
STRANDELL-STILLE retractor	157	surgical tissue forceps type USA	81/1	tissue forceps CASTROVIEJO	392
STRASSBURGER tissue forceps	89	surgical tissue forceps WAUGH	83	tissue forceps DAVIS	227
STRATTE needle holder	212	suture fork REDA	221/1	tissue forceps DeBakey	99
STRAUSS penis clamp	553/1	suture scissors HEATH	66	tissue forceps Gerald	86, 87
Stripper	202	suture scissors LITTAUER	66	tissue forceps GOMEL	96
STRULLY neuro surgical	65	suture scissors NORTHBENT	66	tissue forceps GRAEFE	83
STRUYCKEN nose forceps	427	suture scissors SPENCER	66	tissue forceps jewelry	90
SUBRAMANIAN-MINIATURE	521	SWEET applicator forceps	326	tissue forceps MAYO	89
suction -irrigation cannula	394	SYSTRUNK surgical scissors	66	tissue forceps McPHERSON	392
suction handle WULLSTEIN	338	T		tissue forceps MOORFIELD	392
suction raspatories GUILLEN	433/1	TABB knives	418	tissue forceps PAUFIQUE	392
suction tube ADSON	337	TAKAHASHI nose forceps	427	tissue forceps SINGLEY	88
suction tube ANDREW-PYNCHON	28	Tangentialclamp DeBAKEY-SATINSKY	502	tissue forceps STRASSBURGER MODELL	89
suction tube BARON	336	TARNIER cranioplast	607	tissue forceps type TUEBINGEN	392
suction tube COOLEY	28	TARNIER obstetrical forceps	604	tissue forceps ULTRA LIGHT	95
suction tube DASTOOR	380	TAYLOR percussion mallet	24	tissue forceps WAGENSTEEN	89
		TAYLOR SPINAL hook	291	tissue forceps YASARGIL	97
		TAYLOR surgical tissue forceps	87	tissue forcepsSt. MARTIN	392
		TC scissors FREEMAN	74	tissue grasping forceps CHAPUT	110
				tissue grasping forceps COLLIN	110

tissue grasping forceps TUFFIER	110	towel clamp BACKHAUS-clip	132	U	
titanium clips	549	towel clamp BALL AND SOCKET	133	UCKERMANN cotton-applicator.....	203
titanium HALSTED-MOSQUITO hemostatic clamp	105	towel clamp BERNHARD	133	ULRICH bone holding forceps	248
titanium hemostatic clamp CRILE	107	towel clamp DOYEN.....	133	ULRICH dressing forceps.....	135
titanium hemostatic clamp KELLY	106	towel clamp JONES	132	Ultra-Light-tissue forceps atrauma	95
titanium tissue forceps DEBAKEY	99	towel clamp JONES-clip	132	umbilical cord COLLIN	605
titanium-ATRAUMA-bulldog clamp	102	towel clamp LANE	133	umbilical cord KANE	605
TOBOLD cotton-applicator	203	towel clamp LORNA.....	133	umbilical cord scissors BRAUN-STADLER	64
TOBOLD tongue depressors.....	453	towel clamp MOYNIHAN	133	umbilical cord scissors BUSCH	64
TOENNIS dura dissector	332	towel clamp PEERS	132	umbilical cord scissors SCHUMACHER	64
TOENNIS hemostatic clamp	117	towel clamp ROEDER	132	umbilical cord scissors type USA	64
TOENNIS-ADSON dissecting scissors	65	towel clamp SCHAEDEL	132	UNI I DIAGNOSTIK-BES.....	13
TOHUKU towel clamp	132	towel clamp TOHOKU	132	UNI III DIAGNOSTIK-BES.....	15
tongue blade DOUGHTY.....	458	TOWNLEY caliper.....	26	UNIVERSAL bandage scissors	70
tongue depressors	451	TOWNSEND biopsy forceps	591	UNIVERSAL endoscope assembly	188
tongue depressors ANDREW	452	TOWNSEND MINI biopsy forceps.....	591	Universal handle HUBER	472
tongue depressors BRUENINGS	451	TOWNSEND TISCHLER MINI biopsy forceps	591	UNIVERSAL sterilization forceps.....	227
tongue depressors BUCHWALD	451	TOYNBEE ear specula	399	Universal tray	620
tongue depressors DAVIS-BOYLE	455	trachea cannula LUER.....	479	UNIVERSAL trocar.....	204
tongue depressors DINGMANN	456	trachea cannula WAGENER-MOSHER	477	UNIVERSAL wire scissors	67
tongue depressors FRENZEL	451	trachea cannulaCHEVALIER-JACK	479	UNNA comedone extractor	608
tongue depressors HARTMANN	452	trachea dilator LABORDE	476	Urethrotome OTIS	553
tongue depressors KILNER-DOUGHTY	456	trachea dilator TROUSSEAU.....	476	US army retractor	141
tongue depressors KROENIG	451	trachea dilator TROUSSEAU-BABY	476	USA anatomic tissue forceps.....	81
tongue depressors MAYO	451	trachea hook BOSE	476, 477	USA type umbilical cord scissors	64
tongue depressors MORITZ-SCHMIDT	452	trachea hook ITERSON	477	uterine clamp GREEN-ARMYTAGE	605
tongue depressors RING	455	trachea hook JACKSON.....	476	uterine curette SIMON	594
tongue depressors RUSSEL-DAVIS.....	458	trachea hook NEWS	477	uterine curette BLAKE.....	595
tongue depressors TOBOLD	453	Trachoma forceps KNAPP-LUER	393	uterine curette BUMM.....	597
tongue depressors WIEDER	452	Transformer	22	uterine curette GOURDET	599
tongue forceps COLLIN	453	TRANSFORMER FOR laryngoscope handle.....	34	uterine curette RECAMIER	597
tongue forceps YOUNG	453	TRAVERS retractors	172	uterine curette SCHRÖDER	595
tonometer SCHIOETZ	394/2	tray	619	uterine curette SIMS	597
tonsil forceps Abraham	468	Tray universal.....	620	uterine curette THOMAS	599
tonsil elevator HENKE	465	TRELAT tonsil needle	466	uterine depressor BRAUN.....	586
tonsil elevator HURD	465	TRELAT vaginal specula	571	uterine depressor SIMS	586
tonsil elevator LOPEZ-REINKE	465	trocar COAKLEY	204	uterine Dilatator GOODELL	581
tonsil elevator YANKAUER.....	465	trocar DOUGLAS	204	uterine Dilatator HANK	580
tonsil forceps BALLENGER	467	trocar LICHTWITZ	204	uterine Dilatator HEGAR	578, 579
tonsil forceps BLOHMKE	467	trocar NELSON	205	uterine Dilatator PRATT	580
tonsil forceps MARSCHIK	468	trocar OCHSNER	205	uterine Dilatator SIMS	581
tonsil forceps NEGUS	467	trocar PIERCE	204	uterine Dilatator WYLIE	581
tonsil forceps SAWTELL	467	trocar UNIVERSAL	204	uterine grasping forceps COLLIN	585
tonsil forceps SCHNIDT	467	trocarStandard (NELSON)	204	uterine grasping forceps DARTIGUES	585
tonsil forceps TYDING	467	TROELTSCH ear forceps	424	uterine grasping forceps SOMER	585
tonsil forceps WHITE	467	TROEMNER percussion mallet	24	uterine polyp forceps DOYEN	585
tonsil grasping forceps COLVER.....	467	TROUSSEAU trachea dilator	476	uterine polyp forceps KELLY	585
tonsil knives ABRAHAM	466	TROUSSEAU-BABY trachea dilator	476	uterine polyp forceps NOTO	585
tonsil knives BRUENINGS.....	466	TROUTMAN iris tissue forceps	389	uterine-probes COLLIN	586
tonsil knives CANFIELD	466	TROUTMAN iris tissue forceps	384, 389	uterine-probes MARTIN	586
tonsil knives CARPENTER	465	TROUTMAN-CHRIS bladeBREAKERS	45	uterine-probes SIMS	586
tonsil knives DOUGLAS	466	tubal catheter	596		
tonsil knives FISHER	466	tube milking roller	131	V	
tonsil needle	470	tubing clamp	129	vaginal specula	569
tonsil needle CLAUS	466	tubing clamp HOFFMANN	624	vaginal specula JACKSON	573
tonsil needle DUPUY-WEISS	466	tubing clamp SIMPLEX	624	vaginal specula AUVARD	576
tonsil needle NAGER	466	tubing clampBülow-Gunar-Hey	130	vaginal specula BREISKY	577
tonsil needleTRELAT	466	TÜBINGEN IRIS forceps.....	387	vaginal specula COLLIN	570
tonsil scissors.....	59	TÜBINGEN tissue forceps.....	392	vaginal specula CUSCO	570
tonsil scissors BOETTCHER	59	TUFFIER retractor	147	vaginal specula DOYEN	574
tonsil scissors DEAN	59	TUFFIER rib spreader	487	vaginal specula GRAVE.....	570
tonsil scissors GOOD	59	TUFFIER tissue grasping forceps	110	vaginal specula KRISTELLER.....	572
tonsil scissors PRINCE.....	59	Tumor grasping forceps LANDOLT	341/2	vaginal specula LANDAU	577
tonsil snare BRUENINGS	468	Tumortissue forceps YASARGIL	97	vaginal specula PEDERSON	570
tonsil snare EVES	468	tuning forc	404	vaginal specula SCHERBAK	575
tonsil syringe	470	tuning forc HARTMANN	403	vaginal specula SEMM	571
tonsil wire	468	tuning forc LUCAE.....	404	vaginal specula SIMS	573
tonsilotome SLUDER-BALLENGER	470	tuning forc REDA.....	403	vaginal specula TRELAT	571
tonsilotome TYDING.....	469	tuning forc RYDEL-SEIFFERT	404	vaginal specula VU-MORE.....	569
TOOK corneal scarifier	373	TURNBULL nail forceps	609	VALLEIX probes	586
Tourniquet RUMEL-BELMONT	528	TURREL rectal biopsy forceps	567	VAN BUREN bone holding forceps	249
towel clamp	133	TYDING tonsil forceps	467	VAN BUREN dilation bougie	554
towel clamp BACKHAUS	132	TYDING tonsilotome.....	469	VAN DOREN biopsy forceps	588

VANNAS eye scissors	79	WEBER aorta clamp.....	501	YASARGIL aneurysm	349 - 356
VARADY varix instrument.....	202	WEBER cataract loop	378	YASARGIL GALEAhook.....	330
varicose vein probes NABATOFF	201	WEBSTER needle holder.....	208	YASARGIL suction tube	337/1
varix instrument VARADY	202	WECKER eye scissors	75	YASARGIL tumor tissue forceps.....	97
vascular clamp BAINBRIDGE	495/1, 495/2	WECKER iris spatula.....	378	YEOMAN rectal biopsy forceps	566, 567
vascular clamp COOLEY	518, 522	WEEK eye specula	370	YOUNG BOOMERANG	220
vascular clamp DALE	494, 495	WEIL-BLAKESLEY nose forceps	426	YOUNG prostatic hook	550
vascular clamp DARDIK.....	509/1	WEITLANER retractors.....	169	YOUNG tongue forceps	453
vascular clamp DEBAKEY	493-500, 502, 505-508, 512-517	WEITLANER-WULLSTEIN retractors.....	169		
vascular clamp DEBAKEY children	516	WELLER dissecting scissors	53/2	Z	
vascular clamp DEBAKEY-MIXTER.....	499/2	WELLS enucleation curette.....	378	ZAUFAL ear lever	409
vascular clamp DEBAKEY-RUMEL	499	WERTHEIM gynecological scissors	63	ZAUFAL-JANSEN bone rongeur	238
vascular clamp DIEFFENBACH.....	104	WERTHEIM hysterectomy clamp	124, 128	ZAUFAL-JANSEN ear lever	409
vascular clamp GLOVER	515	WERTHEIM hysterectomy scissors.....	63	ZENKER hemostatic clamp.....	118
vascular clamp SATINSKY	491	WERTHEIM-CULLEN hysterectomy clamp.....	125	ZENKER retractor	161
vascular clip BIEMER	361	WEST nose chisels	442	ZIEGLER discision knives	373
vascular clip MEHDORN	362	WESTCOTT eye scissors	75	ZIEGLER eye specula	371
vascular clip MUELLER.....	365	WESTMACOTT nose dressing forceps	424	ZIEGLER head mirror	21
vascular scissors DE BAKEY	61	WESTON rectalsnare.....	566	ZIEGLER iris knives	372
vascular scissors DeBaKey TC.....	60	WHEELER cyclodialysis spatula	379	ZIEGLER lachrymal dilator	381
vascular scissors DIETRICH.....	60	WHEELER discision knives	373	ZIELKE gouges.....	264
vascular scissors FAVALORO.....	61	WHITE tonsil forceps.....	467	ZOELLNER suction tube.....	337/1
vascular scissors KELLY	61	WIBERG raspatoriesIUM.....	277		
vascular scissors KLINKENBERG-LOTH.....	65/2	width ruler	594		
vascular scissors POTTS-DE MARTEL	59	WIEDER tongue depressors.....	452		
vascular scissors POTTS-SMITH.....	61	WIENER antrum rasp	443		
vascular scissors SATINSKY	65/1	WIENER iris hook	375		
vascular tissue forceps ADLERKREUTZ	84	WIGMORE plaster knives.....	229		
vascular tissue forceps NELSON	89	WIKSTROEM hemostatic clamp	117		
vascular tissue forcepsSTILLE-BARRAYA	88	WILDE polyp snare.....	411		
vascular-cannula SCHMID	338	WILDE polyp snare.....	433/2		
vascular-dilator DEBAKEY	529	WILDE(TROELTSCH) ear forceps.....	410		
vasculardissector ROBB	530	WILDER cataract loop	378		
vasectomy clamp	553/2	WILDER dilator	381		
VERBRUGGE bone holding forceps	245	WILLET MARTEL grasping forceps.....	110		
VERBRUGGE-MÜLLER bone levers	287	WILLIAMS eye specula	370		
VERESS insufflation cannula.....	206	WILLIAMS intestinal grasping forceps.....	539		
VIENNA guide probes	221/1	WILLIAMS screw driver	323		
VIENNA nose specula	421	WILLIGER curette.....	255, 257		
VIRCHOW POST MORTEM knives	48	WILLIGER mallet	271		
VIRTUS(RALK) splinter forceps	92	WILLIGER raspatories	276		
VOLKMANN bone curettes	251	WINTER ovum forceps	606		
VOLKMANN curette	257	wire basket for endoscope	623		
VOLKMANN retractor	153	wire cutter HERCULES.....	320/1 - 320/3		
VOLKMANN retractor.....	153, 156	wire dispenser	310		
VOLTOLINI nose specula	421	wire forceps	317 - 320/3		
VU-MORE vaginal specula.....	569	wire forceps BERRY TC	319		
		wire forceps CORWIN-HEGAR TC.....	319		
W		wire forceps MAYO-HABERISSER TC.....	319		
WACHENFELDT clip tissue forceps.....	224	wire gauze	311		
WADSWORTH-TODD	378	wire grasping forceps	318		
WAGENER-MOSHER trachea cannula	477	wire guide needle DEMEL	315		
WAGENR hook	409	wire instrument DEMEL.....	315		
WAGNER laminectomy retractor forceps.....	343	wire instrument LOUTE	315		
Wagner scissors	67	wiresaw OLIVECRONA	332		
WAGNER supercut scissors	72	wirescissors UNIVERSAL	67		
WALDMANN episotomy scissors.....	64	WITTNER biopsy forceps	589		
WALLICH ovum curette.....	607	WOLFF plaster forceps	233		
WALSHAM septum straightening forceps	449	WOODSON dura dissector	333		
WALTHER catheter	555	WORST probes	333		
WALTON foreign body gouges	374	wound curette ARRUGA	378		
WALTON comedone extractor	608	WRIGLEY obstetrical forceps.....	602		
WALTON Finger ring saw	297	WULLSTEIN knives	418		
WANGENSTEIN vascular tissue forceps	89	WULLSTEIN micro-curette forceps.....	416		
WARTENBERG PINWHEEL	25	WULLSTEIN retractors	171		
waste forceps SAUERBRUCH	227	WULLSTEIN suction handle	338		
water jet pistol.....	626	WYLIE aortic clamp	501/1, 501/2		
WATSON DERMATOM	50	WYLIE uterine dilator.....	581		
WATSON-CHEYNE	283				
WATSON-CHEYNE probes	199	Y			
WATSON-WILLIAMS nose forceps	428	YANCOSKIE retractor.....	198		
WAUGH surgical tissue forceps	83	YANKAUER suction tube	27		
		YANKAUER tonsil dissector	465		

Abraham bisturi para amígdalas.....	466	Air Injection canula.....	394	asa Langenbeck.....	409
Abraham pinza para coger amígdalas.....	468	alambre de Kirschner.....	306, 307	asa Shapleigh.....	410
abre-boca Davis-Boyle.....	455	alambre de Steinmann.....	307, 308	asa Snellen.....	378
abre-boca Davis-Meyer.....	457	alambres.....	306-308	asa Weber.....	378
abre-boca Denhart.....	454	Alan-Parks especulo rectal.....	561	asa Wilder.....	378
abre-boca Dingmann.....	456	Alderdyce elevador.....	282	Asch pinza para enderezar el tabique nasal.....	449
abre-boca Doughty-Kilner.....	456	Alexander cincel.....	259	Aufranc-Cobra separador.....	289
abre-boca Doyen-Jansen (Molt).....	454	Alexander gubia.....	259	Aufricht lima nasal.....	443
abre-boca Heister.....	454	Alexander periostotomo.....	276	Aufricht retractor nasal.....	447
abre-boca Jansen-Doyen (Molt).....	454	Alexander pinza para biopsia.....	589	Auard especulo vaginal.....	576
abre-boca Jennings.....	454	Alexander-Matson periostotomo.....	279	Axenfeld cucharilla para chalazion.....	377
abre-boca Kilner-Doughty.....	456	alicate corta-uñas.....	609, 612/2-614	Axenfeld-Mellinger biflorostato.....	370
abre-boca Koenig-Roser.....	454	alicate corta-uñas Anvil.....	613	Ayer pinza para ligadura.....	393
abre-boca Mclvor.....	457	alicate cuticular.....	613		
abre-boca Molt (Doyen-Jansen).....	454	alicate Grip.....	316	B	
abre-boca Roser-Koenig.....	454	alicate para cortar uñas Turnbull.....	609	Babcock pinza intestinal.....	539
aceite para instrumentos InstruCare.....	635	alicates.....	316-318, 320	Babinsky martillo de percusion.....	24
Adair pinza uterina.....	582	alicates para alambres.....	317-320/3	Baby Balfour separador abdominal.....	182, 183
Adams-Mayo separador.....	171	alicates para alambres Hercules.....	320/1-320/3	Baby Burke pinza para biopsia.....	590
adaptador para iluminacion para amnioscopio.....	600	alicates para cortar alambres.....	316-320	Baby Gosset separador abdominal.....	181
adenotomo LaForce.....	450	Allen pinza para apendice.....	544	Baby Lexer tijera de diseccion.....	53
Adlerkreutz pinza de diseccion.....	84	Allis pinza intestinal.....	537	Baby Metzbaum tijera supercut.....	71
Adson Anderson separador.....	172	Allis-Adair pinza intestinal.....	537	Baby Mixer pinza hemostatica.....	119/1
Adson Baby pinza hemostatica.....	113	Allis-Baby pinza intestinal.....	537	Baby Roux separador.....	140
Adson elevador.....	282	Allis-Judd pinza intestinal.....	538	Baby-Bailey aproximador para costillas.....	489/1
Adson gancho para dura-madre.....	329	Allis-Lockwood pinza intestinal.....	538	Baby-Doyen pinza intestinal.....	540
Adson pinza de diseccion.....	81/2, 82	Allison espátula pulmonar.....	489/2	Baby-Kocher pinza intestinal.....	540
Adson pinza de proteccion.....	298	Allis-Thoms pinza intestinal.....	538	Baby-Olsen-Hegar porta aguja.....	212
Adson pinza gubia.....	236	Alm separador.....	168	Baby-Overholt pinza hemostatica.....	114
Adson pinza hemostatica.....	112, 113	Alvis cureta para cuerpos extraños.....	374	Baby-Payr pinza intestinal y estomacal.....	548
Adson pinza para hipofisis.....	334	amigdalotomo Sluder-Ballenger.....	470	Babyphon esfigmomanometro.....	10
Adson porta aguja.....	211	amigdalotomo Tyding.....	469	Baby-Tischler pinza para biopsia.....	592
Adson separador.....	172-174	amniotomo.....	586, 600	Baby-Trousseau dilatador traqueal.....	476
Adson tubo de aspiracion.....	337	amniotomo Beacham.....	586	Baby-Yankauer tubo de aspiracion.....	27
Adson-Beckmann separador.....	175	Ansler-Connin marcador.....	380	Back holder separador abdominal.....	192-195
Adson-Brown pinza de diseccion.....	82	Anderson Adson separador.....	172	Backhaus pinza de campo.....	132
Adson-DeBakey pinza de diseccion.....	81/2	Anderson separador.....	198	Backhaus-Clip pinza de campo.....	132
Adson-Toennis tijera.....	65	Anderson-Neivert cincel nasal.....	442	Bahnson-DeBakey pinza para aneurisma.....	506
Aebli tijera corneal.....	58	Andrew baja-lengua.....	452	Bailey aproximador para costillas.....	489/1
agrafe Michel.....	224	Andrew-Pynchon tubo de aspiracion.....	28	Bailey-Baby aproximador para costillas.....	489/1
aguja Barbara.....	419	Anestophon estetoscopio.....	23	Bailey-Gibbon aproximador para costillas.....	489/1
aguja de discision Bowman.....	374	anillo para Kleinsasser.....	36	Bainbridge pinza hemostatica.....	119/2
aguja de guia para anestesia.....	206	anoscopio Chelsea-Eaton.....	563	Bainbridge pinza vascular de uso multiple.....	495/1-495/2
aguja de guia Redon.....	207	anoscopio Hirschmann.....	562	baja-lengua Andrew.....	452
aguja para amígdalas.....	470	anoscopio Ives-Fansler.....	562	baja-lengua Bruenings.....	451
aguja para autopsia.....	268	anteojos para nistagmo Frenzel.....	20	baja-lengua Buchwald.....	451
aguja para biopsia Menghini.....	206	Antrum cureta.....	435	baja-lengua Cawood-Minnesota.....	451
aguja para catarata.....	374	Anvil alicate corta-uñas.....	613	baja-lengua Davis-Russel.....	458
aguja para cuerpos extraños.....	374	aparato para suturar estomago y intestinos V. Petz.....	549	baja-lengua Doughty.....	458
aguja para cuerpos extraños Davis.....	374	aproximador de Biemer.....	366	baja-lengua Frenzel.....	451
aguja para cuerpos extraños Francis.....	374	aproximador de Biemer-Müller.....	363	baja-lengua Hartmann.....	452
aguja para cuerpos extraños Levinson.....	374	aproximador de Müller.....	364	baja-lengua Kroenig.....	451
aguja para laringe.....	470	aproximador de Müller-Biemer.....	363	baja-lengua Mayo.....	451
aguja para ligadura.....	218, 219	aproximador para costillas Baby-Bailey.....	489/1	baja-lengua Minnesota-Cawood.....	451
aguja para ligadura Cooper.....	219	aproximador para costillas Bailey.....	489/1	baja-lengua Moritz-Schmidt.....	452
aguja para ligadura Deschamps.....	218	aproximador para costillas Bailey-Baby.....	489/1	baja-lengua Ring.....	455
aguja para ligadura Dick-Schmieden.....	219	aproximador para costillas Bailey-Gibbon.....	489/1	baja-lengua Russel-Davis.....	458
aguja para ligadura Kronecker.....	219	aproximador para costillas Gibbon-Bailey.....	489/1	baja-lengua Schmidt-Moritz.....	452
aguja para ligadura Nelson.....	219	aproximador para costillas Sellors.....	489/1	baja-lengua Tobold.....	453
aguja para ligadura Schmieden-Dick.....	219	Archer pinza para espinas.....	92	baja-lengua Wieder.....	452
aguja para neumoperitoneo Verres.....	206	Arit asa.....	378	baja-lenguas.....	451-453, 455
aguja para paracentesis Lucae.....	408	Armytage-Green pinza para uterus.....	605	Bakes dilatador para conductos biliares.....	532
aguja para paracentesis Politzer.....	408	Arruga biflorostato.....	370	Balfour Baby separador abdominal.....	182, 183
aguja para sutura amígdalas Dupuy-Weiss.....	466	Arruga gancho para extraccion.....	375	Balfour separador abdominal.....	182, 183
aguja para sutura amígdalas Weiss-Dupuy.....	466	Arruga pinza capsular.....	391	Balfour-Us separador abdominal.....	184
aguja para sutura del paladar Claus.....	466	Arruga porta aguja.....	214	Ball and Socket pinza para campo.....	133
aguja para sutura del paladar Claus-Eicken.....	466	Arruga protector.....	378	Ballenger cuchillo para tabique nasal.....	436
aguja para sutura del paladar Eicken-Claus.....	466	Arruga-Gil pinza capsular.....	390	Ballenger elevador para el tabique nasal.....	439
aguja para sutura del paladar Nager.....	466	Arruga-Kalt pora aguja.....	214	Ballenger pinza para coger amígdalas.....	467
aguja pasa-hilo Demel.....	315	Arthur-Kirby pinza para fijacion.....	385	Ballenger-Hajek elevador para el tabique nasal.....	439
aguja Reverdin.....	220	articulacion para Kleinsasser.....	36	Ballenger-Sluder amigdalotomo.....	470
aguja Young Boomerang.....	220	asa Arit.....	378	Ballentine-Heany pinza para histerectomia.....	127
agujas de sutura.....	222, 223	asa Billeau.....	409	bandejas.....	620

Bane-Hartmann pinza gubia	237	Blake pinza para calculos biliares	530/2	Brown pinza de diseccion	83
Bangerter espátula para ciclodialisís	379	Blake-Mayo pinza para calculos biliares	530/2	Brown porta aguja	209
Baracani punta de pinza	472	Blakesley-Weil pinza nasal	426	Browne-Denis separador abdominal	185
Barany ensordecedor	405	blefarostato Arruga	370	Bruenings baja-lengua	451
Barbara aguja	419	blefarostato Axenfeld-Mellinger	370	Bruenings bisturi para amígdalas	466
Barbara gancho	419	blefarostato Barraquer (Colibri)	370	Bruenings cierranudos	468
Barbon-Lubet pinza nasal	424	blefarostato Bowman	370	Bruenings especulo auricular	401
Barkan cuchillo para goniotomía	373	blefarostato Burch-Lister	370	Bruenings pinza nasal	425
Barnhill cuchillo para vegetaciones adenoides	450	blefarostato Clark	370	Bruenings punta de pinza	472
Baron canula de succion	336	blefarostato Colibri (Barraquer)	370	Bruenings tubo de extension	472
Barr especulo rectal	559	blefarostato Critchett	370	Brunetti cincel	268
barra de traccion Gerster	250	blefarostato Graefe	370	Brünings-Lucas cincel	260
Barraquer (Colibri) blefarostato	370	blefarostato Lancaster	371	Brünings-Lucas gubia	260
Barraquer (Colibri) pinza para iris	384	blefarostato Lister-Burch	370	Brunner costotomo	481
Barraquer Colibri tijera para oftalmología	75	blefarostato Mellinger	370	Brunner pinza intestinal	543
Barraquer cuchillo para queratoplastica	373	blefarostato Mellinger-Axenfeld	370	Brunner separador	167
Barraquer micro porta aguja	216, 217	blefarostato Murdock	370	Brunner sonda conductora	221, 221/1
Barraquer pinza depilatoria	395	blefarostato Smith	370	Bruns cucharilla cortante	251, 254
Barraquer pinza para fijacion	390	blefarostato Week	370	Bruns tijera para vendaje	70
Barraquer-Katzin pinza para iris	384	blefarostato Williams	370	Bryant pinza para medicacion	137
Barraquer-Troutmann micro porta aguja	216	blefarostato Ziegler	371	Buchwald baja-lengua	451
Barraquer-Stille pinza de diseccion	88	blefarostato Castroviejo	371	Buck cureta	407
Barrett pinza uterina	582	blefarostato Liebermann	371	Buck elevador para cuerpos extraños	412
Barton forceps obstetrico	603/2	blefarostato Mueller	371	Buck martillo de percusion	24
Barton tractor	603/2	blefarostato Park	371	Buck-Gramcko elevador	285
Baumgartner porta aguja	208	blefarostato Stevenson	371	Buie canula de aspiracion rectal	566
Beacham amniotomo	586	Blohmke pinza para coger amígdalas	467	Buie-Smith separador rectal	561
Beichert rotador	379	Blount elevador	288	bujia dilatadora Dittel	554
Beck pinza para anastomosis	516, 520	Blount separador para rodilla	289	bujia dilatadora Guyon	554
Becker quistotomo	375	Blumenthal pinza gubia	236	bujia dilatadora Van Buren	554
Beckmann cuchillo para vegetaciones adenoides	450	Bodenhammer especulo rectal	559	Bülow-Gunar-Hey pinza cierra-tubo	130
Beckmann separador	176	Boerma forceps obstetrico	604	Bumm cureta uterina	597
Beckmann-Adson separador	175	Boettcher tijera para amígdalas	59	Bunell pasador de tendones	294
Beckmann-Eaton separador	176	Böhler estribo para extension	312	Bunell perforador de mano	299
Beer pinza depilatoria	395	Böhler pinza cortante para huesos	241	Bunell separador para tendones	292
Beeson separador para yesos	232	Böhler pinza gubia	238	Bunge cucharilla para exenteracion	378
Bellucci tijera auricula micro	413, 417	Boies elevador	277	Bunt clip para esterilizacion	227, 624
Belmont-Rumel tournique	528	bomba de aire	295	Burch horquilla fijadora	373
Bengolea pinza hemostatica	112	bombilla de repuesto para laringoscopio	29, 30	Burch-Lister blefarostato	370
Bennett elevador	283	bomboneras	621	Burford-Finocchio separador costal	483
Bensaude proctoscopio	565	Bonaccolto pinza para estrabismo	385	Burke pinza para biopsia	590
Benson separador para piloro	544	Bonn Mod. pinza para sutura	386	Burrows-Jackson separador	189/2
Berens cuchillo de discision	372	Bonn pinza para sutura	386	Busch tijera para cordon umbilical	64
Bergmann martillo	272	Bonney pinza de diseccion	88	Bushe cucharilla cortante	256
Bergmann tijera para vendaje	69/1	Boomerang Young aguja	220		
Bergmann-Schulze especulo rectal	560	Boomerang Young porta aguja	220	C	
Berke pinza muscular	389	Bose gancho para traqueotomia	477	caja para esterilizacion	618
Berlin Klinikum pinza cierra-tubo	129	Bose separador traqueal	476	caja para instrumentos	617
Berliner martillo de percusion	24	Boucheron especulo auricular	399	calibrador decimal Iwanson	624
Bernhard pinza de campo	133	Bowman aguja de discision	374	calibre	26
Berry pinza para torcer hilo	319	Bowman blefarostato	370	calibre Townley	26
Bethune costotomo	481	Bowman sonda lacrimal	381	Canfield bisturi para amígdalas	466
Beyer pinza gubia	237, 238	Boyle-Davis abre-boca	455	canula Air Injection	394
Biemer aproximador	366	Boynton porta aguja	214	canula capsular Jensen	394
Biemer pinza para vasos	361	Boys-Allis pinza intestinal	538	canula de aspiracion para mango de Wullstein	
Biemer-Müller aproximador	363	Bozemann pinza porta esponja	138	y Zöllner	337/1
Biel sierra para amputacion	296	Bozemann porta aguja	211	canula de aspiracion rectal Buie	566
Bill tractor	604	Bozemann-Douglas pinza porta esponja	138	canula de aspiracion para mango de Zöllner	
Billeau asa	409	Brand mondador de tendones	294	y Wullstein	337/1
Bill-Luikart tractor	604	Brand pinza de agarre para tendones	293	canula de inyeccion Kleinsasser	36
Bircher-Ganske pinza para hueso	246	Braun cranioclasto	607	canula de irrigacion y aspiracion Bishop-Harmon	394/1
Birkett pinza hemostatica	116	Braun depresor uterino	586	canula de irrigacion y aspiracion Harmon-Bishop	394/1
Bishop-Harman pinza para iris	386	Braun gancho de decapitacion	607	canula de succion Baron	336
Bishop-Harmon canula de irrigacion y aspiracion	394/1	Braun pinza uterina	582	canula de succion Kleinsasser	36
bisturi nasal Joseph	434, 435	Braun-Stadler tijera para episiotomia	64	canula irrigacion Eicken (Killian)	433
bisturi para amígdalas Abraham	466	brazalete para brazo	295	canula irrigacion Killian (Eicken)	433
bisturi para amígdalas Bruenings	466	brazalete para femur	295	canula Killian	433/1
bisturi para amígdalas Canfield	466	Breast separador mamario	198	canula Lacrimal	394
bisturi para amígdalas Douglas	466	Breisky especulo vaginal	577	canula lacrimal McIntyre	394
bisturi para amígdalas Fisher	466	Bridge pinza hemostatica	116	canula para lavador vascular Schmid	338
bisturi para fibroma Segond	594	Bristow elevador	290	canula para traqueotomia Chevalier-Jackson	479
bisturies	46	Brodie sonda acanalada	199	canula para traqueotomia Jackson-Chevalier	479
Blake cureta uterina	595	Brophy pinza de diseccion	84	canula para traqueotomia Luer	479

canula para traqueotomía Mosher-Wagener.....	477	cincel nasal Rubin	440	Collin separador	139
canula para traqueotomía Wagener-Mosher.....	477	cincel nasal Sheehan	441	Collin separador abdominal	190
canula Sheets.....	394/2	cincel nasal Silver.....	442	Collin-Duval pinza de disección	85
canula Simcoe.....	394/2	cincel nasal West	442/1	Collin-Farabeuf periostotomo	274
Carmalt pinza para espinas.....	91	cincel para cuerpos extraños Dix	374	Collin-Hartmann separador	141
Carmalt-Rochester pinza hemostática.....	109	cincel para el tabique nasal Freer	439	Collins-Mayo separador	141
Caroli pinza de agarre para tendones.....	293	cincel para extirpación Rollet.....	374	Colver pinza para coger amígdalas	467
Carpenter cuchillo para amígdalas	465	cincel Partsch.....	259	compas marcador Castroviejo	380
Cartilage-Martin tijera.....	65/1	cincel Petersen-Smith	261	Cone pinza sacabocado craneal.....	331
Caspar hemostático.....	258	cincel rompe-craneo.....	267	Connin-Amsler marcador	380
Caspar separador.....	179	cincel Smith-Petersen	261	Contour-Scalp separador.....	169
Castaneda pinza vascular para neonatales	527	cincel Stille	260	Converse cuchillo rinoplástico.....	435
Castroviejo blerarostato	371	cincel tamponador para huesos Passow	260	Converse separador.....	448
Castroviejo compas marcador	380	Cinelli cincel nasal	441	Cooley pinza traumática.....	99
Castroviejo cuchillo para disección	372	Circumflex micro tijera	76	Cooley pinza para anastomosis	519-520/1, 520/4
Castroviejo dilatador lacrimal.....	381	Citelli pinza sacabocado	430	Cooley pinza para aorta	520/3
Castroviejo espátula para ciclodialis	379	cizalla para yesos Stille	229	Cooley pinza para cateter	510
Castroviejo pinza capsular	391	clamp atrauma bulldog	100	Cooley pinza vascular	520
Castroviejo pinza para fijación	390	clamp atrauma bulldog DeBakey.....	100, 103	Cooley pinza vascular de uso múltiple.....	518-520, 520/2
Castroviejo pinza para sutura	392	clamp atrauma bulldog Glover.....	100, 103	Cooley pinza vascular pediátrica	522
Castroviejo porta aguja	215	clamp bulldog de Titano	102	Cooley separador	148
Castroviejo rompe hojas	45	clamp bulldog DeBakey-Dietrich	101	Cooley separador costal	485, 487
Castroviejo tijera para corneales.....	79	clamp bulldog Dietrich	101	Cooley-Derra pinza para anastomosis.....	519
Castroviejo tijera para iridectomía.....	79	clamp bulldog Dietrich-DeBakey	101	Cooper aguja para ligadura.....	219
Castroviejo-Micro porta aguja	215	clamp umbilical Collin	605	copas graduadas.....	620
Castroviejo-Standard micro porta aguja	216	clamp umbilical Kane	605	Cordes punta de pinza	472
cateter auricular Hartmann.....	408	Clar lámpara frontal.....	22	Coronal Blow Lift separador	198
cateter Coxeter.....	555	Clark blefarostato	370	Corwin-Hegar pinza para torcer hilo	319
cateter metálicos.....	555	Claus aguja para sutura del paladar	466	Coryllos (Thorax) separador	166
cateter Walthers.....	555	Claus-Eicken aguja para sutura del paladar	466	Coryllos costotomo	480
Cattin cuchillo para amputación.....	44	Claus-Killian cincel nasal	442/1	Cos pinza auricular micro.....	414
cauterio Todd-Wadsworth	378	Clayman gancho	376	costotomo	480, 481
cauterio Wadsworth-Todd	378	Cleveland pinza gubia	235	costotomo Bethune.....	481
Cawood-Minnesota baja-lengua.....	451	clip para esterilización Bunt	227, 624	costotomo Brunner	481
cepillo para uñas.....	611	clip para esterilización Mayo.....	227, 624	costotomo Coryllos	480
cesta de esterilización	622, 623	Clip-Jones pinza de campo	132	costotomo Frey-Sauerbruch	481
Chandler elevador	282	clips para aneurisma Yasargil	345-356	costotomo Giertz-Stille.....	481
Chaput pinza hemostática	110	clips para vasos de Müller	365	costotomo Gluck	480
Charnley separador abdominal	289	Cloward pinza cortante para laminectomía	342	costotomo Sauerbruch.....	481
Charniere sierra para amputación.....	296	Cloward separador	178/1-178/4	costotomo Sauerbruch-Frey	481
Cheatle pinza para esterilización	227	Cloward separador para cuerpo vertebral.....	339	costotomo Stille	480
Chelsea-Eaton anoscopio	563	Cloward separador para tejido cervical.....	339	costotomo Stille-Giertz.....	481
Cheron pinza porta esponja.....	137	coagulación bipolar.....	628-633	Cottle (Maltz) lima nasal	444
Cherry separador para laminectomía.....	488	Coakley cureta para seno	449	Cottle cincel nasal	440
Chevalier-Jackson canula para traqueotomía	479	Coakley trocar para seno maxilar	204	Cottle cuchillo rinoplástico.....	435
Chevalier-Jackson pinza para bronco-esofagoscopia.....	473	Cobb cureta.....	252	Cottle elevador para el tabique nasal	439
Cheyne-Watson disecador.....	199	Cobb gubia.....	262	Cottle especulo nasal	423
Cheyne-Watson elevador	283	Cobb periostotomo	280	Cottle gancho para la piel	448
Childe pinza para aplicar agrafes.....	224	Cobra-Aufranc separador	289	Cottle Joseph elevador para el tabique nasal	439
cierra-nudo auricular Krause	411	Colclough pinza sacabocado para discos		Cottle martillo	273
cierra-nudo auricular Wilde	411	intervertebral	344/1	Cottle pinza para columna	448
cierra-nudo rectal Yeoman	566	Colibri (Barraquer) blefarostato	370	Cottle pinza para fijación.....	410
cierranudos Bruenings	468	Colibri (Troutman) pinza para iris.....	384	Cottle retractor nasal	447, 447/1
cierranudos Eves.....	468	Colibri Barraquer tijera para oftalmología	75	Cottle tijera nasal.....	59
cierra-tubos Hoffmann	624	Colibri pinza para iris.....	384	Cottle tijera para cirugía.....	56
cierra-tubos Simplex	624	College-London pinza dental	93	Cottle-Kazanjian pinza cortante para huesos.....	241
cincel	259-261, 264-265	Coller-Crile pinza hemostática	106	Cottle-Neivert gancho para la piel	448
cincel Alexander	259	Collier pelvimetro	605	Coxeter cateter.....	555
cincel Brunetti	268	Collier porta aguja	208	Crafoord pinza hemostática	118
cincel Brünings-Lucas	260	Collin clamp umbilical	605	Crafoord tijera pulmonar	65/2
cincel de esternon Lebsche	267	Collin dinamómetro	25	Crafoord-Sellers pinza hemostática.....	119
cincel Hibbs.....	265	Collin especulo vaginal	570	cranioclasto Braun	607
cincel Lucas-Brünings	260	Collin histerometro	586	cranioclasto Tarnier	607
cincel nasal Anderson-Neivert	442	Collin Loktite separador abdominal	191	Crego elevador	282
cincel nasal Cinelli.....	441	Collin mango de bisturí	40	Crile gancho para nervio.....	328
cincel nasal Claus-Killian	442/1	Collin martillo.....	270	Crile pinza hemostática	107
cincel nasal Cottle	440	Collin pelvimetro.....	605	Crile porta aguja	213
cincel nasal Fomon	441	Collin pinza hemostática	110	Crile separador.....	140
cincel nasal Freer	442/1	Collin pinza para el útero	585	Crile-Coller pinza hemostática	106
cincel nasal Hajek	442/1	Collin pinza para quitar agrafes	224	Crile-Murray porta aguja	209
cincel nasal Killian	442/1	Collin pinza para tejido.....	539	Crile-Rankin pinza hemostática	107
cincel nasal Killian-Claus	442/1	Collin pinza porta esponja.....	137	Crile-Wood porta aguja	209
cincel nasal Neivert-Anderson	442	Collin pinza tira-lengua.....	453	Critchett blefarostato.....	370

Crutchfield perforador inicial.....	327	cuchillo para reseccion.....	47	Davis-Boyle abre-boca.....	455
Crutchfield pinza de traccion craneal.....	327	cuchillo para reseccion Langenbeck.....	47	Davis-Meyer abre-boca.....	457
cubeta para placenta.....	621/1	cuchillo para tabique nasal Ballenger.....	436	Davis-Russel baja-lengua.....	458
cubeta Petri.....	620	cuchillo para tabique nasal Freer.....	434	Day gancho auricular.....	409
cubetas.....	619-621/1	cuchillo para vegetaciones adenoides Barnhill.....	450	Dean cuchillo para iris.....	372
cuchara medicinal.....	268	cuchillo para vegetaciones adenoides Beckmann.....	450	Dean tijera para amigdalas.....	59
cuchara para calculos biliares Desjardins.....	534	cuchillo para vegetaciones adenoides St.Clair-Thomson.....	450	Deaver separador.....	145, 146
cuchara para calculos biliares Fergusson.....	533	cuchillo para vegetaciones adenoides Thomson-St.Clair.....	450	Deaver tijera de diseccion.....	52
cuchara para calculos biliares Koerte-Luer.....	533	cuchillo para vendaje enyesado Esmarch.....	233	Deaver-Grip separador.....	146
cuchara para calculos biliares Luer-Koerte.....	533	cuchillo para vendaje enyesado Hopkins.....	233	DeBakey clamp trauma bulldog.....	100, 103
cuchara para calculos biliares Mayo.....	534	cuchillo para vendaje enyesado Reiner.....	233	DeBakey dilatador vascular.....	529
cuchara para calculos biliares Moor.....	531	cuchillo para vendaje enyesado Wigmore.....	229	DeBakey pinza atraumatica.....	98, 99
cuchara y gancho Gross.....	409	cuchillo Plester.....	418	DeBakey pinza para anastomosis.....	505, 515
cucharilla cortante.....	251-257	cuchillo rinoplastico Converse.....	435	DeBakey pinza para aneurisma de la aorta.....	496-498
cucharilla cortante Bruns.....	251, 254	cuchillo rinoplastico Cottle.....	435	DeBakey pinza para ligadura.....	493, 499-500
cucharilla cortante Bushe.....	256	cuchillo Rosen.....	418	DeBakey pinza para vasos perifericos.....	494
cucharilla cortante Daubenspeck.....	255	cuchillo Schuhknecht.....	418	DeBakey pinza vascular.....	
cucharilla cortante Halle.....	253	cuchillo Tabb.....	418	de uso multiple.....	495/2, 507, 508, 514, 515
cucharilla cortante Jacobson.....	257	cuchillo Wulstein.....	418	DeBakey pinza vascular pediatrica.....	516, 517
cucharilla cortante Jansen.....	257	Cullen-Wertheim pinza para histerectomia.....	125	DeBakey porta aguja.....	210
cucharilla cortante Lempert.....	256	cureta Antrum.....	435	DeBakey separador.....	189/1
cucharilla cortante Martini.....	257	cureta aspiradora.....	600	DeBakey tijera.....	60
cucharilla cortante Reda.....	256	cureta aspiradora para biopsia uterina Novak.....	587	DeBakey tijera vascular.....	61
cucharilla cortante Schede.....	251	cureta aspiradora para biopsia uterina Randall.....	587	DeBakey-Bahnon pinza para aneurisma.....	506
cucharilla cortante Scoville.....	253	cureta Buck.....	407	DeBakey-Dietrich clamp bulldog.....	101
cucharilla cortante Spinal.....	253	cureta Cobb.....	252	DeBakey-Mixer pinza para ligaduras.....	499/2
cucharilla cortante Spratt.....	251	cureta Faulkner.....	449	DeBakey-Morris pinza para la aorta.....	506
cucharilla cortante Voikmann.....	251, 257	cureta House.....	420	DeBakey-Mosquito pinza hemostatica.....	509
cucharilla cortante Williger.....	255, 257	cureta para aborto Pestalozza.....	606	DeBakey-Pean pinza hemostatica atraumatica.....	513
cucharilla para aborto Cuzzi.....	606	cureta para biopsia Heany.....	587	DeBakey-Rankin pinza hemostatica atraumatica.....	512
cucharilla para aborto Wallich.....	607	cureta para biopsia Kevorkian.....	587	DeBakey-Rumel pinza para ligaduras.....	499
cucharilla para cataratas Daviel.....	377	cureta para biopsia Mod. Muenchen.....	587	DeBakey-Satinsky pinza para oclusion tangencial.....	502
cucharilla para cataratas Graefe.....	377	cureta para biopsia Muenchen Mod.....	587	DeBakey-Semb pinza para ligadura y la aorta.....	499
cucharilla para cataratas Knapp.....	378	cureta para cuerpos extraños Alvis.....	374	DeBoer separador costal.....	486
cucharilla para chalazion Axenfeld.....	377	cureta para hipofisis.....	334	Decker pinza cortante para laminectomia.....	341
cucharilla para chalazion Hebra.....	377	cureta para hipofisis Ray.....	334	dedal.....	311
cucharilla para chalazion Meyhoefer.....	377	cureta para lupus Fox.....	608	Dejerine martillo de percusion.....	24
cucharilla para exenteracion Bunge.....	378	cureta para lupus Piffard.....	608	Delee especulo vaginal.....	574
cucharilla uterina Simon.....	594	cureta para seno Coakley.....	449	DeLee forceps obstetrico.....	602
cucharra para sangre.....	268, 621	cureta uterina Blake.....	595	DeMartel guia conductora.....	330
cuchillo auricular Politzer.....	408	cureta uterina Bumm.....	597	DeMartel-Wolfson pinza para anastomosis.....	546
cuchillo auricular Sexton.....	408	cureta uterina Gourdet.....	599	DeMartel-Wolfson pinza para cerrar clamps.....	546
cuchillo corneal Elschmig.....	373	cureta uterina Recamier.....	597	DeMartel-Wolfson porta-clamps.....	546
cuchillo corneal Gill.....	373	cureta uterina Schröder.....	595	Demel aguja pasa-hilo.....	315
cuchillo corneal Took.....	373	cureta uterina Sims.....	597	Demel tensor de cierra-hilo.....	315
cuchillo de discision Berens.....	372	cureta uterina Thomas.....	599	Denhart abre-boca.....	454
cuchillo de discision Jaeger.....	372	Cusco especulo vaginal.....	570, 571	Denis-Browne separador abdominal.....	185
cuchillo de hoz Reda.....	435	Cushing espátula cerebral.....	336, 369	depressor para epiglotis Reichert.....	471
cuchillo interoseo.....	44	Cushing gancho para nervio.....	328	depressor uterino Braun.....	586
cuchillo para amigdalas Carpenter.....	465	Cushing pinza cortante para laminectomia.....	340	depressor uterino Sims.....	586
cuchillo para amputacion Catlin.....	44	Cushing pinza de diseccion.....	83	Derf porta aguja.....	208
cuchillo para amputacion Langenbeck.....	44	Cushing separador.....	151- 153	dermatomo Humby.....	50
cuchillo para amputacion Liston.....	44	Cushing-Taylor pinza de diseccion.....	87	dermatomo Schink.....	49
cuchillo para amputacion Reda.....	44	Cuzzi cucharilla para aborto.....	606	dermatomo Silver.....	50
cuchillo para iris Dean.....	48	Czerny especulo rectal.....	559	dermatomo Watson.....	50
cuchillo para autopsia.....	48	Czerny pinza uterina.....	584	Derra pinza para anastomosis.....	515
cuchillo para autopsia Virchow.....	48	Czerny separador.....	141	Derra-Cooley pinza para anastomosis.....	519
cuchillo para cataratas Deutschmann.....	371	D		D'Errico separador para la raiz de nervios.....	329/2
cuchillo para cataratas Graefe.....	371	D		Deschamps aguja para ligadura.....	218
cuchillo para cerebro Virchow.....	48	D		Desjardins cuchara para calculos biliares.....	534
cuchillo para discision Wheeler.....	373	D		Desjardins explorador para calculos biliares.....	531
cuchillo para discision Castroviejo.....	372	D		Desjardins pinza hemostatica.....	121
cuchillo para discision Graefe.....	372	D		Desjardins pinza para calculos biliares.....	530/2
cuchillo para discision Ziegler.....	373	D		Desmarres pinza para chalazion.....	393
cuchillo para falanges.....	44	D		Desmarres separador.....	151
cuchillo para goniotomia Barkan.....	373	D		desoblitador de vena.....	202
cuchillo para goniotomia Scheie.....	373	D		destornillador.....	323, 324
cuchillo para iris Dean.....	372	D		destornillador Lane.....	323, 324
cuchillo para iris Knapp.....	372	D		destornillador Williams.....	323
cuchillo para iris Ziegler.....	372	D		Deutschmann cuchillo para cataratas.....	371
cuchillo para organos.....	48	D		Devilbiss pinza sacabocado craneal.....	332
cuchillo para periostio.....	47	D		diapason Hartmann.....	403
cuchillo para queratoplastica Barraquer.....	373	D		diapason Reda.....	403
cuchillo para queratoplastica Paufigue.....	373	D			
		D			
		Dandy pinza para vasos perifericos.....	494, 495		
		Dandy gancho para nervio.....	328		
		Dandy pinza hemostatica.....	109		
		Dardik pinza vascular.....	509/1		
		Darling separador.....	178		
		Dartiques pinza para el utero.....	585		
		Dastoor pinza para estrabismo.....	386		
		Daubenspeck cucharilla cortante.....	255		
		Davidson (Scapula) separador.....	166		
		Daviel cucharilla para cataratas.....	377		
		Davis aguja para cuerpos extraños.....	374		
		Davis elevador para duramadre.....	332		
		Davis espátula cerebral.....	337		
		Davis pinza para esterilizacion de jeringas.....	227		

diapason Lucae	404	Dupuy-Weiss aguja para sutura amigdalas	466	elevador para el tabique nasal Joseph Cottle	439
diapason Rydel-Seiffert	404	Durante pinza de diseccion	88	elevador para el tabique nasal Killian	438, 439
diapason Seiffert-Rydel	404	Duval pinza de diseccion	85	elevador para el tabique nasal Masing	437
diaposones	403, 404	Duval pinza para tejido	539	elevador para el tabique nasal McKenty	437, 438
Dick-Schmieden aguja para ligadura	219	Duval-Collin pinza de diseccion	85	elevador para el tabique nasal Pennington	438
Dieffenbach serra-fina	104			elevador para el tabique nasal Pierce	438
Dieter pinza auricular micro	414	E		elevador para el tabique nasal Roger	437
Dietrich clamp bulldog	101	Eastman-Richardson separador	142	elevador Sayre	281
Dietrich pinza para la aorta	510	Eaton-Chelsea anoscopio	563	elevador Trethowan Lane	290
Dietrich tijera vascular	60	Echlin pinza gubia	240	elevador Verbrugge-Müller	286/2
Dietrich-DeBakey clamp bulldog	101	ECO "T" y "C" estuche de diagnostico	16	elevador Watson-Cheyne	283
dilatador lacrimal Castroviejo	381	Eicken (Killian) canula irrigacion	433	Elliot forceps obstetrico	603
dilatador lacrimal Wilder	381	Eicken-Claus aguja para sutura del paladar	466	Ellis gubia para cuerpos extraños	374
dilatador lacrimal Ziegler	381	electrocirugia	628-634	Elschnig cuchillo corneal	373
dilatador para conductos biliares Bakes	532	elevador	281-291	Elschnig espátula para ciclodialisís	379
dilatador para el seno Halle-Ritter	433	elevador Adson	282	Elschnig pinza capsular	391
dilatador para el seno Ritter-Halle	433	elevador Alderdyce	282	Elschnig pinza para fijacion	389
dilatador traqueal Baby-Trousseau	476	elevador auricular Jansen-Zaufal	409	Emmet gancho para fistulas	594
dilatador traqueal Laborde	476	elevador auricular Zaufal	409	empujador de alambres Erich	461/2
dilatador traqueal Trousseau-Baby	476	elevador auricular Zaufal-Jansen	409	Engel sierra para vendajes enyesados	229
dilatador uterino Goodell	581	elevador Bennett	283	ensordecedor Barany	405
dilatador uterino Hank	580	elevador Blount	288	Enucleation tijera	58
dilatador uterino Hegar	578, 579	elevador Boies	277	Epker osteotomo	464/2
dilatador uterino Pratt	580	elevador Bristow	290	Eppendorfer pinza para biopsia	590
dilatador uterino Sims	581	elevador Buck-Gramcko	285	Erich empujador de alambres	461/2
dilatador uterino Wylie	581	elevador Chandler	282	escariador	304
dilatador vascular DeBakey	529	elevador Cheyne-Watson	283	escariador Perthes	304
dinamómetro Collin	25	elevador Crego	282	esclerotomo Guyton-Lundsgaard	373
Dingman elevador	463/3	elevador Dingman	463/3	esclerotomo Lundsgaard	373
Dingman periostotomo	463	elevador Gramcko-Buck	285	esclerotomo Lundsgaard-Guyton	373
Dingmann abre-boca	456	elevador Hohmann	284, 285	escofina nasal Miller	444
Dingmann pinza para hueso	246	elevador Hohmann Mini	286	escofina nasal Peet	446
Diplomat esfigmomanómetro	5	elevador Hohmann-Lange	286	escofina nasal Wiener	443
disecador Cheyne-Watson	199	elevador Key	282	escupidora	621/1
disecador corneal Green	374	elevador König	284	esfigmomanómetro Babyphon	10
disecador corneal Paton	373	elevador Lane	290	esfigmomanómetro Diplomat	5
disecador para el saco lacrimal Lang	378	elevador Lane Trethowan	290	esfigmomanómetro Exacta-Spezial	8
disecador vascular Robb	530	elevador Lane-Murphy	283	esfigmomanómetro Minimus II	11
disecador Watson-Cheyne	199	elevador Lange-Hohmann	286	esfigmomanómetro Minimus III	12
disector Fisch	420	elevador Lempert	420	esfigmomanómetro Nova	7
disector Gorney	277	elevador Masing	437	esfigmomanómetro Nova-Presameter	6
dispensador de cepillos	611	elevador McDonald	283	esfigmomanómetro Precisa	9
Dix instrumento para brocas filiformes	310	elevador Mini Hohmann	286	esfigmomanómetro Presameter-Nova	6
Dittel bujia dilatadora	554	elevador Müller-Verbrugge	286/2	esfigmomanómetro Spezial-Exacta	8
Dix cincel para cuerpos extraños	374	elevador Murphy-Lane	283	Esmarch cuchillo para vendaje enyesado	233
Dix instrumento para cuerpo extraños	380	elevador Obwegeser	461/1	Esmarch tijera para vendaje	69/2
Doren pinza para biopsia	588	elevador para amigdalas Reinke-Lopez	465	Esmarch vendaje de compresion	296
Doughty baja-lengua	458	elevador para amigdales Henke	465	espátula	143/1-144, 203, 336-337,
Doughty-Kilner abre-boca	456	elevador para amigdales Hurd	465	369, 378-379, 489/2, 530, 552, 612/1
Douglas bisturí para amigdalas	466	elevador para amigdales Lopez-Reinke	465	espátula abdominal Haberer	143/3
Douglas pinza depilatoria	395	elevador para amigdales Yankauer	465	espátula abdominal Kader	143/3
Douglas trocar	204	elevador para cuerpos extraños Buck	412	espátula abdominal Kümmel	143/4, 144
Douglas-Bozemann pinza porta esponja	138	elevador para cuerpos extraños Quire	412	espátula abdominal Ribbon	143/1
Down-Mini-Townsend pinza para biopsia	591	elevador para duramadre	332, 333	espátula cerebral Cushing	336, 369
Down-Tischler pinza para biopsia	591	elevador para duramadre Davis	332	espátula cerebral Davis	337
Doyen espejuelo vaginal	574	elevador para duramadre Frazier	333	espátula cerebral Heifetz	369
Doyen estilite acanalado	199	elevador para duramadre Hoen	333	espátula cerebral Olivecrona	336
Doyen periostotomo	278	elevador para duramadre Horsley	333	espátula Locke	612/1
Doyen pinza de campo	133	elevador para duramadre Milligan	332	espátula para ciclodialisís Bangertner	379
Doyen pinza intestinal	540	elevador para duramadre Olivecrona	332	espátula para ciclodialisís Castroviejo	379
Doyen pinza para polipos uterinos	585	elevador para duramadre Penfield	333	espátula para ciclodialisís Elschnig	379
Doyen separador	163	elevador para duramadre Sachs	332	espátula para ciclodialisís Hirschman	379
Doyen separador abdominal	189/1	elevador para duramadre Toennis	332	espátula para ciclodialisís Wheeler	379
Doyen tijera ginecologica	63	elevador para duramadre Woodson	333	espátula para enucleacion Wells	378
Doyen tirabuzon para fibroma	594	elevador para el tabique nasal Ballenger	439	espátula para iris Wecker	378
Doyen-Baby pinza intestinal	540	elevador para el tabique nasal Ballenger-Hajek	439	espátula para la intima Robb	530
Doyen-Jansen (Molt) abre-boca	454	elevador para el tabique nasal Cottle	439	espátula pulmonar Allison	489/2
Doyen-Stille separador	167	elevador para el tabique nasal Cottle Joseph	439	espátula vesical Kocher	552
Dubois tijera ginecologica	63	elevador para el tabique nasal Freer	437	espátula vesical Legueu	552
Duehrsen pinza de diseccion	84	elevador para el tabique nasal Hajek-Ballenger	439	espátulas abdominales	143-144
Duplay pinza porta-esponja	134	elevador para el tabique nasal Halle	437	espátulas para la intima	530-530/1
Duplay pinza uterina	582	elevador para el tabique nasal Howarth	438	espejuelo auricular	399-402
Duplex stetoscopio	23	elevador para el tabique nasal Joseph	437	espejuelo auricular Boucheron	399

especulo auricular Bruenings.....	401	estuche de diagnostico Ri-Mini.....	17	forceps obstetrico Elliot.....	603
especulo auricular Gruber.....	399	estuche de diagnostico Uni I.....	13	forceps obstetrico Kielland.....	602
especulo auricular Hartmann.....	399	estuche de diagnostico Uni II.....	14	forceps obstetrico Kielland-Luikart.....	603
especulo auricular Holmgren-Richnau.....	400	estuche de diagnostico Uni III.....	15	forceps obstetrico Luikart.....	603
especulo auricular Politzer.....	399	estuche para autopsia.....	269	forceps obstetrico Luikart-Kielland.....	603
especulo auricular Richnau-Holmgren.....	400	estuche para esterilizar agujas.....	615	forceps obstetrico Luikart-McLean-Tucker.....	603/1
especulo auricular Siegle.....	402	estuche para sutura Standard.....	226	forceps obstetrico Luikart-Simpson.....	603
especulo auricular Toynbee.....	399	Eves cierranudos.....	468	forceps obstetrico McLean.....	603/1
especulo endocervical Kogan.....	577	Exacta-Spezial esfigmomanómetro.....	8	forceps obstetrico McLean-Tucker.....	603/1
especulo Friedmann.....	477, 577	Excenter Reda tijera para vendaje.....	69/2	forceps obstetrico McLean-Tucker-Luikart.....	603/1
especulo nasal.....	421-423	explorador para calculos biliares Desjardins.....	531	forceps obstetrico Naegle.....	603
especulo nasal Cottle.....	423	explorador para calculos biliares Moynihan.....	531	forceps obstetrico Piper.....	604
especulo nasal Halle-Hartmann.....	421	extractor Künstscher.....	322	forceps obstetrico Simpson.....	602
especulo nasal Halle-Tieck.....	423	extractor/impactor para clavos.....	321-322/1	forceps obstetrico Simpson-Braun.....	602
especulo nasal Hartmann.....	422			forceps obstetrico Simpson-Luikart.....	603
especulo nasal Hartmann-Halle.....	421			forceps obstetrico Tarnier.....	604
especulo nasal Killian.....	423	F		forceps obstetrico Tucker-Luikart-McLean.....	603/1
especulo nasal Mod. Vienna.....	421	face lift tijera Freeman.....	73	forceps obstetrico Tucker-McLean.....	603/1
especulo nasal Reda.....	423	face lift tijera Gorney.....	73	forceps obstetrico Tucker-McLean.....	603/1
especulo nasal Thudichum.....	421	face lift tijera Joseph Peck.....	73	forceps obstetrico Wrigley.....	602
especulo nasal Tieck-Halle.....	423	face lift tijera kaye.....	73	forceps obstetricos Luikart-McLean.....	603/1
especulo nasal Vienna Mod.....	421	face lift tijera Peck Joseph.....	73	forceps obstetricos McLean-Luikart.....	603/1
especulo nasal Voltolini.....	421	face lift tijera Rees.....	73	forceps obstetricos Thierry.....	603
especulo rectal.....	559-561	Fansler protoscopio.....	564	Foregger juego de laringoscopia.....	31
especulo rectal Alan-Parks.....	561	Fansler-Ives anoscopio.....	562	Foregger laringoscopia.....	29
especulo rectal Barr.....	559	Farabeuf periostotomo.....	274	Fox cureta para lupus.....	608
especulo rectal Bergmann-Schulze.....	560	Farabeuf pinza para hueso.....	243	Fox-Goldmann tijera para encias.....	67
especulo rectal Bodenhammer.....	559	Farabeuf separador.....	139	Fraenkel pinza para laringe.....	471
especulo rectal Czerny.....	559	Farabeuf-Collin periostotomo.....	274	Fraenkel punta de pinza.....	472
especulo rectal Ferguson-Hill.....	560	Farabeuf-Lambotte pinza para hueso.....	243	Francis aguja para cuerpos extraños.....	374
especulo rectal Hill-Ferguson.....	560	Farrell porta-algodon.....	203	Frazier elevador para duramadre.....	333
especulo rectal Mathieu.....	560	Faulkner cureta.....	449	Frazier gancho.....	148/2
especulo rectal Parks-Alan.....	561	Faure pinza para biopsia.....	588	Frazier separador abdominal.....	181
especulo rectal Pratt.....	559	Faure pinza para peritoneo.....	123	Frazier/Ferguson tubo de aspiracion.....	337
especulo rectal Sawyer.....	560	Favaloro tijera vascular.....	61	Freeman separador.....	198
especulo rectal Schulze-Bergmann.....	560	Favaloro-Morse separador costal.....	484	Freeman tijera face lift.....	73
especulo rectal Sims.....	559	Fehland pinza intestinal.....	542	Freer cincel nasal.....	442/1
especulo vaginal.....	569-577	Feilchenfeld pinza para espinas.....	91	Freer cincel para el tabique nasal.....	439
especulo vaginal Auvard.....	576	Feldheim pinza para huesos.....	249	Freer cuchillo para tabique nasal.....	434
especulo vaginal Breisky.....	577	Ferguson-Hill especulo rectal.....	560	Freer elevador para el tabique nasal.....	437
especulo vaginal Collin.....	570	Ferguson cuchara para calculos biliares.....	533	Freer gancho para la piel.....	448
especulo vaginal Cosco.....	570, 571	Ferguson pinza hemostatica.....	109	Frenzel anteojos para nistagmo.....	20
especulo vaginal Delee.....	574	Ferguson pinza para hueso.....	243	Frenzel baja-lengua.....	451
especulo vaginal Doyen.....	574	Ferguson tijera para intestino.....	66	Frey-Sauerbruch costotomo.....	481
especulo vaginal Grave.....	570	Ferguson tubo de aspiracion.....	337	Friedmann especulo.....	477, 577
especulo vaginal Jackson.....	573	Ferguson/Frazier tubo de aspiracion.....	337	Friedmann micro pinza gubia.....	234
especulo vaginal Joll.....	477, 577	Ferrera separador para cirugia plastica.....	197	Friedmann mini pinza gubia.....	234
especulo vaginal Kallmorgen.....	573	Ferris-Smith pinza cortante para laminectomia.....	343	Friedmann pinza gubia.....	234
especulo vaginal Kristeller.....	572	Ferris-Smith pinza de diseccion.....	85	Friedmann separador.....	477, 577
especulo vaginal Landau.....	577	Ferris-Smith-Kerrison pinza sacabocado para discos intervertebral.....	344, 344/2	Fritsch separador.....	163
especulo vaginal More-Vu.....	569	Finocchetto pinza bronquial.....	490	Frykholm pinza gubia.....	240
especulo vaginal Kreisky.....	577	Finocchetto porta aguja.....	211	Fuchs pinza capsular.....	391
especulo vaginal O'Connor-O'Sullivan.....	576	Finocchetto separador costal.....	482, 484	Fuchsig pinza hemostatica.....	113
especulo vaginal O'Sullivan-O'Connor.....	576	Finocchetto-Burford separador costal.....	483		
especulo vaginal Pederson.....	570	Finocchetto-Rienhoff separador costal.....	486	G	
especulo vaginal Scherbak.....	575	Finsen separador.....	168	Gallaher lima para seno.....	446
especulo vaginal Semm.....	571	Fisch disector.....	420	gancho Frazier.....	148/2
especulo vaginal Sims.....	573	Fisch gancho para duramadre.....	335	gancho Graefe.....	148/2
especulo vaginal Trelat.....	571	Fischer pinza para iris.....	384	gancho Guthrie.....	148/2
especulo vaginal Vu-More.....	569	Fish sonda.....	199	gancho Joseph.....	149
espejo laringeo.....	423, 473	Fisher bisturi para amigdalas.....	466	gancho Kleinert-Kutz.....	149
espejo laringeo Michel.....	423	Foerster pinza para iris.....	383	gancho Kutz-Kleinert.....	149
estetoscopio Anestophon.....	23	Foerster porta esponjas.....	136	gancho Lahey.....	149
estetoscopio Duplex.....	23	Fomon cincel nasal.....	441	gancho nasal Fomon.....	447/1
estetoscopio Pinard.....	23	Fomon gancho nasal.....	447/1	gancho abotonado Lucace.....	409
estilite abotonado.....	199	Fomon lima nasal.....	444, 445	gancho abotonado Wagener.....	409
estilite acanalado abotonado.....	199	Fomon periostotomo.....	277	gancho auricular Day.....	409
estilite acanalado Doyen.....	199	Fomon tijera nasal.....	58	gancho Barbara.....	419
estilite hoja mirte.....	199	Fomon tijera para rinoplastia.....	65/1	gancho Clayman.....	376
estribo para extension Böhler.....	312	forceps obstetrico Barton.....	603/2	gancho cutaneo Kilner.....	608
estribo para extension Kirschner.....	312	forceps obstetrico Boerma.....	604	gancho de decapitacion Braun.....	607
estribo para extension Kirschner U.S.....	312	forceps obstetrico DeLee.....	602	gancho de menton Obwegeser.....	461/1
estribo para extension U.S. Kirschner.....	312			gancho extractor.....	322
estuche de diagnostico ECO "T" y ECO "C".....	16			gancho Gass.....	376

gancho Kirschner.....313	Good tijera para amigdalas59	H
gancho Klapp150	Goodell dilatador uterino.....581	Haberer espátula abdominal143/3
gancho Knapp.....375	Gorney disector277	Haberisser-Mayo pinza para torcer hilo319
gancho McGee.....419	Gorney tijera face lift.....73	Haglund-Stille separador para yesos.....232
gancho muscular.....267, 375	Gosset separador abdominal.....181	Haight separador costal487
gancho muscular Green.....375	Gourdet cureta uterina599	Hajek cinceal nasal442/1
gancho obstetrico Smellie.....605	Gradle pinza depiladora.....395	Hajek martillo.....273
gancho para cristalino Stevens.....375	Gradle tijera para oftalmologia.....57	Hajek-Ballenger elevador para el tabique nasal439
gancho para duramadre.....335	Graefe blefarostato.....370	Hajek-Kofler pinza cortante.....429
gancho para duramadre Adson329	Graefe cucharilla para cataratas.....377	Hajek-Kofler pinza sacabocado.....431
gancho para duramadre Fisch.....335	Graefe cuchillo para cataratas.....371	Halle cucharilla cortante.....253
gancho para estrabismo Graefe.....375	Graefe cuchillo para discision.....372	Halle elevador para el tabique nasal.....437
gancho para estrabismo Jameson.....375	Graefe gancho.....148/2	Halle-Hartmann espejulo nasal.....421
gancho para extraccion Arruga.....375	Graefe gancho para estrabismo.....375	Halle-Ritter dilatador para el seno433
gancho para fistulas Emmet.....594	Graefe pinza de diseccion.....83	Halle-Tieck espejulo nasal.....423
gancho para galea Yasargil.....330	Graefe pinza para fijacion.....389	Halsey porta aguja.....208
gancho para iris O'Conner.....375	Graefe pinza para iris.....382	Halsted-Mosquito pinza hemostatica105
gancho para iris Wiener.....375	Graefe quistotomo.....375	Hank dilatador uterino.....580
gancho para la piel Cottle.....448	Graeffe tijera para cirugia.....56	Hargis separador para el borde anterior.....463
gancho para la piel Cottle-Neivert.....448	Graham gancho para nervio.....329	Hargis separador para el cuerpo mandibular.....463/6
gancho para la piel Freer.....448	Graig pinza para tabique nasal.....426	Harken pinza auricular.....503
gancho para la piel Gillies.....448	grapa para cuero cabelludo Raney.....327	Harms sonda.....381
gancho para la piel Neivert-Cottle.....448	grapas.....326	Harrington pinza bronquial.....490
gancho para las alas de la nariz Lange.....448	grapas de plata.....326	Harrington separador.....147
gancho para nervio Crile.....328	Grave espejulo vaginal.....570	Harrington-Pemberton separador.....147
gancho para nervio Cushing.....328	Gray pinza hemostatica.....121	Hartmann baja-lengua.....452
gancho para nervio Dandy.....328	Green disecador corneal.....374	Hartmann cateter auricular.....408
gancho para nervio Graham.....329	Green gancho muscular.....375	Hartmann diapason.....403
gancho para nervio Krayenbühl.....336	Green pinza para fijacion.....390	Hartmann espejulo auricular.....399
gancho para nervio Sachs.....329	Green separador.....160	Hartmann espejulo nasal.....422
gancho para nervio Smithwick.....329	Green-Armytage pinza para uterus.....605	Hartmann pinza auricular.....411
gancho para sacar el insierto I.U.D.....593	Green-Langenbeck separador.....153	Hartmann pinza hemostatica.....104
gancho para traqueotomia Bose.....477	Green-Senn separador.....153	Hartmann pinza nasal.....424, 427
gancho para traqueotomia Itersen.....477	Gregoire pinza intestinal.....538	Hartmann pinza para polipos.....412
gancho para traqueotomia Jackson.....476	Gregory pinza atraumatica.....517	Hartmann-Collin separador.....141
gancho para traqueotomia News.....477	Greven pinza auricular micro.....414	Hartmann-Halle espejulo nasal.....421
gancho Reda.....150	Grip alicate.....316	Hartmann-Hoffmann pinza para polipos.....412
gancho Rollet.....375	Grip Kelly separador.....142	Hartmann-Wulstein pinza para polipos.....412
gancho Rosen.....419	Grip Richardson separador.....142	Hasson separador.....143
gancho Shambaugh.....419	Grip-Deaver separador.....146	Haugh pinza auricular micro.....414
gancho Sinskey.....376	Gross cuchara y gancho.....409	Haverfield-Scoville separador para laminectomia.....196
gancho y cuchara Gross.....409	Gross-Maier pinza porta-esponja.....134	Hayes pinza para anastomosis.....545
ganchos.....419	Gruber espejulo auricular.....399	Heaney pinza para histerectomia.....126
garrote de madera Maunder.....459	Gruenwald-Jansen pinza nasal.....424	Heaney porta aguja.....210
Gass gancho.....376	Gruenwald-Love pinza cortante para laminectomia.....340	Heaney separador.....164
Gauss pinza para pericraneio.....605	gubia.....259-265	Heany cureta para biopsia.....587
Gaylor-Thomas pinza para biopsia.....588	gubia Alexander.....259	Heany-Ballentine pinza para histerectomia.....127
Geissendoerfer-Overholt pinza hemostatica.....114	gubia Brünings-Lucas.....260	Heath martillo.....273
Gelpi separador perineal.....189/1, 189/2	gubia Cobb.....262	Heath tijera para ligadura.....66
Gemini pinza hemostatica.....115	gubia Hibbs.....265	Heath-Richter pinza para quitar agrafes.....224
Gerald pinza de diseccion.....86, 87	gubia Lexer.....263	Hebra cucharilla para chalazion.....377
Gerster barra de traccion.....250	gubia Lexer Mini.....263	Hegar dilatador uterino.....578, 579
Gerzog martillo.....270	gubia Lucas-Brünings.....260	Hegar-Conwin pinza para torcer hilo.....319
Gibbon-Bailey aproximador para costillas.....489/1	gubia Mini Lexer.....263	Hegar-Mayo porta aguja.....209
Gierzt-Stille costotomo.....481	gubia para cuerpos extraños Ellis.....374	Hegar-Olsen porta aguja.....212
Gigli mango para sierra hilo.....332	gubia para cuerpos extraños Walton.....374	Hegenbarth pinza para aplicar agrafes.....224
Gill cuchillo corneal.....373	gubia Partsch.....259	Heifetz espátula cerebral.....369
Gill pinza para iris.....384	gubia Petersen-Smith.....261	Heiming pinza para calculos renales.....536
Gill-Arruga pinza capsular.....390	gubia Smith-Petersen.....261	Heiss pinza hemostatica.....112
Gill-Hess pinza para iris.....384	gubia Stille.....260	Heister abre-boca.....454
Gillies gancho para la piel.....448	gubia Zielke.....264	hemostatico.....258, 259
Gillies pinza de diseccion.....86	guia-conductora DeMartel.....330	hemostatico Caspar.....258
Gillies porta aguja.....212	guia-conductora para clavos medulares.....321	Henke elevador para amigdalas.....465
Gil-Vernet separador.....152	Guilen legra de succion.....433/1	Henley separador.....170
Glover clamp atrauma bulldog.....100, 103	Gunar-Hey-Bülöw pinza cierra-tubo.....130	Hennig separador para yesos.....232
Glover pinza para uso multiple.....515	Guthrie gancho.....148/2	Hepp-Scheidel micro tijera.....78
Gluck costotomo.....480	Guyon bujia dilatadora.....554	Hercules alicates para alambres.....320/1-320/3
Goelet separador.....141	Guyon mandril para cateter.....554	Herrick pinza para pediculo.....123
Goldman-Fox tijera para encias.....67	Guyon pinza hemostatica.....122	Hess pinza capsular.....391
Gomel micro tijera.....80	Guyon-Mayo pinza hemostatica.....122	Hess pinza para iris.....384
Gomel pinza para microcirugia.....96	Guyton-Lundsgaard esclerotomo.....373	Hess separador para la raiz de nervios.....329/1
goniometro Moeltgen.....25		Hess-Gill pinza para iris.....384
goniometro para dedos.....25		Hey-Bülöw-Gunar pinza cierra-tubo.....130

Heymann pinza nasal.....	425	instrumento para vendaje enyesado Reda.....	232	juego para varices Nabatoff.....	201
Heymann tijera nasal.....	58	instrumentos para manicura.....	612, 612/1	Juers pinza auricular micro.....	414
Heymann-Knight pinza nasal.....	425	instrumentos para medir.....	594	Jurasz pinza para polipos laringeos.....	471
Heywood-Smith pinza hemorroidal.....	567	instrumentos para traqueotomia.....	475		
Hibbs cincel.....	265	lowa pinza uterina.....	584	K	
Hibbs gubia.....	265	lris tijera para cirugia.....	54/2	Kabierske lanzapovo.....	405
Hibbs osteotomo.....	265	lris tijera supercut.....	72	Kader espátula abdominal.....	143/3
Hibbs separador.....	164	Israel separador.....	162	Kallmorgen especulo vaginal.....	573
Hill-Ferguson especulo rectal.....	560	Iterson gancho para traqueotomia.....	477	Kalt pinza capsular.....	391
hilos para huesos.....	314	Ives-Fansler anoscopio.....	562	Kalt porta aguja.....	214
Hirschman espátula para ciclodialis.....	379	Iwanson calibrador decimal.....	624	Kalt-Arruga porta aguja.....	214
Hirschmann anoscopio.....	562			Kane clamp umbilical.....	605
histerometro Collin.....	586	J		Kantrowitz pinza hemostatica.....	119/1
histerometro Martin.....	586	Jackson especulo vaginal.....	573	Kaye tijera face lift.....	73
histerometro Sims.....	586	Jackson gancho para traqueotomia.....	476	Kay-Lambert pinza para anastomosis.....	505
histerometro Valleix.....	586	Jackson laringoscopia.....	37	Kazanjan-Cottle pinza cortante para huesos.....	241
Hoen elevador para duramadre.....	333	Jackson pinza de agarre para tendones.....	292	Kelly Grip separador.....	142
Hoessel porta aguja.....	213	Jackson pinza para taponos.....	471	Kelly pinza hemostatica.....	106
Hofer separador para pilar.....	465	Jackson portador de luz.....	37	Kelly pinza para polipos uterinos.....	585
Hoffmann cierra-tubos.....	624	Jackson separador traqueal.....	476	Kelly proctoscopia.....	562, 563
Hoffmann-Hartmann pinza para polipos.....	412	Jackson-Burrows separador.....	189/2	Kelly separador.....	142, 164
Hoglund-Lowman pinza para huesos.....	249	Jackson-Chevalier canula para traqueotomia.....	479	Kelly tijera vascular.....	61
Hohmann elevador.....	284, 285	Jackson-Chevalier pinza para bronco-esofagoscopia.....	473	Kelly-Rankin pinza hemostatica.....	106
Hohmann mini elevador.....	286	Jacobs pinza uterina.....	583	Kern pinza para hueso.....	244
Hohmann-Lange elevador.....	286	Jacobsen porta aguja.....	215	Kerrison pinza cortante.....	428
hoja de repuesto para dermatomo.....	49, 50	Jacobson cucharilla cortante.....	257	Kerrison-Ferris-Smith pinza sacabocado	
hojas de afeitar.....	45	Jacobson sonda abotonada.....	335	para discos intervertebral.....	344, 344/2
hojas de bisturi, esteril.....	42	Jaeger cuchillo de discision.....	372	Keorkian cureta para biopsia.....	587
hojas de cincel intercambiables.....	266	Jaeger placa para parpado.....	371	Keorkian pinza para biopsia.....	589, 591
hojas de osteotomo intercambiables.....	266	Jameson gancho para estrabismo.....	375	Keorkian-Pacific pinza para biopsia.....	592
Hoke osteotomo.....	265	Jameson pinza para estrabismo.....	385	Keorkian-Tischler pinza para biopsia.....	592
Holinger laringoscopia.....	37	Jansen cucharilla cortante.....	257	Key elevador.....	282
Holinger portador de luz.....	37	Jansen pinza gubia.....	237	Keyes trepano.....	608
Holmgren-Richnau especulo auricular.....	400	Jansen pinza nasal.....	424	Kielland forceps obstetrico.....	602
Holsher separador para la raiz de nervios.....	329/1	Jansen separador.....	168	Kielland-Luikart forceps obstetrico.....	603
Holth pinza para capsuloridectom.....	380	Jansen-Doyen (Molt) abre-boca.....	454	Killian (Eicken) canula irrigacion.....	433
Holzbach pinza para histerectomia.....	126	Jansen-Gruenwald pinza nasal.....	424	Killian canula.....	433/1
Holzheimer separador.....	168	Jansen-Middleton pinza para el tabique nasal.....	430	Killian cincel nasal.....	442/1
Hopkins cuchillo para vendaje enyesado.....	233	Jansen-Zaufal elevador auricular.....	409	Killian elevador para el tabique nasal.....	438, 439
Hopkins-Johns pinza hemostatica.....	120	Jansen-Zaufal pinza gubia.....	238	Killian especulo nasal.....	423
Hopkins-Johns serra-fina.....	104	Jarcho pinza uterina.....	583	Killian tijera para septo.....	471
Horne-Jobson porta-algodon.....	203	Javid pinza para shunt carotido.....	511	Killian-Claus cincel nasal.....	442/1
horquilla fijadora Burch.....	373	Jennings abre-boca.....	454	Kilner gancho cutaneo.....	608
Horsley elevador para duramadre.....	333	Jensen canula capsular.....	394	Kilner porta aguja.....	212
Horsley-Stille pinza cortante para huesos.....	242	jeringa.....	406, 407, 470	Kilner retractor nasal.....	447/1
Hösel separador.....	167	jeringa auricular Reiner.....	406	Kilner tijera para cirugia.....	54/1
Hospital-Providence pinza hemostatica.....	106	jeringa para amigdalas.....	470	Kilner/Ragnell tijera supercut.....	72
House cureta.....	420	Jobson-Horne porta-algodon.....	203	Kilner-Doughty abre-boca.....	456
House sonda para medir.....	420	Johns-Hopkins pinza hemostatica.....	120	Kirby-Arthur pinza para fijacion.....	385
House tubo de aspiracion.....	337/2	Johns-Hopkins serra-fina.....	104	Kirk martillo.....	270
Howarth elevador para el tabique nasal.....	438	Joll especulo vaginal.....	477, 577	Kirschner alambre.....	306, 307
Huber mango universal.....	472	Joll separador.....	477, 577	Kirschner estribo para extension.....	312
Hudson perforador de mano.....	299	Jones pinza de campo.....	132	Kirschner gancho.....	313
Hulka pinza uterina.....	583	Jones-Clip pinza de campo.....	132	Kirschner perforador de mano.....	299
Humby dermatomo.....	50	Jones-Leland pinza para vasos perifericos.....	495	Kirschner separador abdominal.....	185, 187, 187/1
Hunter pinza para espinas.....	91	Jonson porta aguja.....	211	Kirschner sonda conductora.....	221
Hurd elevador para amigdales.....	465	Jorgensen tijera de discision.....	53	Kirschner soporte de esterilizacion para alambres.....	305
		Joseph (Lewis) lima nasal.....	443	Kirschner U.S. estribo para extension.....	312
I		Joseph bisturi nasal.....	434, 435	Klapp gancho.....	150
I.U.D. gancho para sacar el inserto.....	593	Joseph Cottle elevador para el tabique nasal.....	439	Kleinert-Kutz gancho.....	149
lman ocular Reda.....	395	Joseph elevador para el tabique nasal.....	437	Kleinert-Kutz pinza de agarre para tendones.....	294
impactor final Kuentscher.....	321	Joseph gancho.....	149	Kleinert-Kutz pinza gubia.....	237
impactor/extractor para clavos.....	321-322/1	Joseph lima para hueso.....	443	Kleinsasser anillo.....	36
luge separador para cuerpo vertebral.....	339	Joseph Peck tijera face lift.....	73	Kleinsasser articulacion.....	36
Ingrown instrumento para uña.....	612/1	Joseph periostotomo.....	277	Kleinsasser canula de inyeccion.....	36
InstruCare aceite para instrumentos.....	635	Joseph sierra nasal.....	446	Kleinsasser canula de succion.....	36
instrumento para circuncision.....	556	Joseph tijera para cirugia.....	54/1	Kleinsasser laringoscopia operativo.....	35
instrumento para circuncision Mogen.....	556	Judd-Allis pinza intestinal.....	538	Kleinsasser portador de luz fria.....	36
instrumento para cuerpo extraños Dix.....	380	Judd-Masson separador vesical.....	552	Kleinsasser soporte pectoral.....	36
instrumento para cuerpo extraños LaForce.....	374	juego de laringoscopia Foregger.....	31	Kleinschmidt pinza para apendice.....	544
instrumento para el fragmento de la uña.....	612/1	juego de laringoscopia McIntosh.....	31	Klinikum Berlin pinza cierra-tubo.....	129
instrumento para uña Ingrown.....	612/1	juego de manicura para enfermeras.....	609	Klinkenbergh-Loth tijera vasija.....	65/2
instrumento para varices Varady.....	202	juego de recambio para alicate Hercules.....	320/1-320/3	Knapp cucharilla para cataratas.....	378

Knapp cuchillo para iris.....	372	Lane pinza de diseccion	84	lima para uñas.....	610
Knapp gancho.....	375	Lane pinza estomacal	547	Lister (Sinus) pinza porta esponja.....	137
Knapp tijera para cirugía.....	55	Lane pinza para hueso.....	244	Lister tijera para vendaje.....	69/1
Knapp-Luer pinza para tracoma.....	393	Lane pinza para sostener placas.....	325	Lister tijera supercut.....	72
Knight pinza nasal.....	425	Lane pinza para sostener tornillos.....	325	Lister-Burch blefarostato.....	370
Knight-Heymann pinza nasal.....	425	Lane Trethowan elevador.....	290	Liston cuchillo para amputacion.....	44
Knowles tijera para vendaje.....	70	Lane-Murphy elevador.....	283	Liston pinza cortante para huesos.....	241
Kocher espátula vesical.....	552	Lang diseccionador para el saco lacrimal.....	378	Liston-Ruskin pinza cortante para huesos.....	241
Kocher pinza hemostatica.....	108	Lange gancho para las alas de la nariz.....	448	Liston-Stille pinza cortante para huesos.....	242
Kocher pinza intestinal.....	540	Lange punta de pinza.....	472	Littauer pinza auricular.....	411
Kocher separador.....	155, 159, 160, 163	Lange-Hohmann elevador.....	286	Littauer pinza depilatoria.....	395
Kocher sonda para bocio.....	479	Langenbeck asa.....	409	Littauer pinza para polipos.....	425
Kocher-Langenbeck separador.....	159	Langenbeck cuchillo para amputacion.....	44	Littauer tijera para ligadura.....	66
Koenig sonda conductora.....	221/1	Langenbeck cuchillo para reseccion.....	47	Little separador.....	157
Koenig-Roser abre-boca.....	454	Langenbeck periototomo.....	275	Littler tijera para cirugía.....	55
Koerte separador.....	162	Langenbeck pinza para hueso.....	243	Littlewood pinza intestinal.....	538
Koerte-Luer cuchara para calculos biliares.....	533	Langenbeck porta aguja.....	213	llave de tuerca.....	313
Kofler-Hajek pinza cortante.....	429	Langenbeck separador.....	158, 159	Locke espátula.....	612/1
Kofler-Hajek pinza sacabocado.....	431	Langenbeck sierra para amputacion.....	296	Lockhart-Mummary sonda para fistula.....	200
Kogan especulo endocervical.....	577	Langenbeck-Green separador.....	153	Locklin tijera para encias.....	69
König elevador.....	284	Langenbeck-Kocher separador.....	159	Lockwood-Allis pinza intestinal.....	538
König periototomo.....	276	Langenbeck-Parker / Us Army separador.....	141	Loktite Collin separador abdominal.....	191
König separador.....	153	lanzapolvo Kabierske.....	405	London-College pinza dental.....	93
Koos micro cuchillo.....	335	laringoscopia Foregger.....	29	Lopez-Reinke elevador para amigdales.....	465
Körte separador.....	143/3	laringoscopia Holinger.....	37	Lorenz tijera para vendaje.....	70
Krause cierra-nudo auricular.....	411	laringoscopia Jackson.....	37	Lorna pinza para campo.....	133
Krause polipotomo.....	433/2	laringoscopia McIntosh.....	29	Loth-Klinkenbergh tijera vasija.....	65/2
Krause punta de pinza.....	472	laringoscopia Miller.....	30	Loute tensor de cierra-hilo.....	315
Krause-Voss polipotomo.....	433/2	laringoscopia operativo Kleinsasser.....	35	Love separador para la raiz de nervios.....	329/2, 330
Krayenbühl gancho para nervios.....	336	Larsen pinza para tendones.....	292	Love separador para uvula.....	465
Kristeller especulo vaginal.....	572	Lawrence pinza hemostatica.....	119	Love-Gruenwald pinza cortante para laminectomia.....	340
Kroenig baja-lengua.....	451	Lebsche cincel de esternon.....	267	Lovelace pinza hemostatica.....	109
Kronecker aguja para ligadura.....	219	Lees pinza bronquial.....	504	Lovelace pinza para coger el pulmon.....	490
Kuentscher impactor final.....	321	legra de succion Guilen.....	433/1	Lower pinza hemostatica.....	120
Kuglen manipulador.....	376	Legueu espátula vesical.....	552	Lowman pinza para huesos.....	249
Kümmel espátula abdominal.....	143/4, 144	Legueu separador vesical.....	553	Lowman-Hoglund pinza para huesos.....	249
Kümmel separador abdominal.....	143/4	Leksell (Stille) pinza gubia.....	240	Lowman-Lambert pinza para huesos.....	249
Küntscher extractor.....	322	Leland-Jones pinza para vasos perifericos.....	495	Lubet-Barbon pinza nasal.....	424
Küntscher perforador para femur.....	321	Lempert cuchara cortante.....	256	Luc pinza nasal.....	426
Küntscher perforador para la cavidad medular.....	321	Lempert elevador.....	420	Lucae aguja para paracentesis.....	408
Kutz-Kleinert ganchito.....	149	Lempert pinza gubia.....	237	Lucae diapason.....	404
Kutz-Kleinert pinza de agarre para tendones.....	294	Lerche pinza de diseccion.....	83	Lucae gancho abotonado.....	409
Kutz-Kleinert pinza gubia.....	237	Lerliche pinza hemostatica.....	111	Lucae martillo.....	271
		Lerliche separador intestinal.....	143/4	Lucae pinza auricular.....	410
L		Lester pinza para fijacion.....	389	Luer canula para traqueotomia.....	479
L&M separador intra oral.....	463/4	Levinson aguja para cuerpos extraños.....	374	Luer pinza gubia.....	236
Laborde dilatador traqueal.....	476	Lewin pinza para hueso.....	246	Luer separador.....	140
Lacrimal canula.....	394	Lewis (Joseph) lima nasal.....	443	Luer-Knapp pinza para tracoma.....	393
LaForce adenotomo.....	450	Lexer Baby tijera de diseccion.....	53	Luer-Koerte cuchara para calculos biliares.....	533
LaForce instrumento para cuerpos extraños.....	374	Lexer gubia.....	263	Luer-Stille pinza gubia.....	239
LaGrange tijera para encias.....	69	Lexer Mini gubia.....	263	Luikart forceps obstetrico.....	603
LaGrange tijera supercut.....	72	Lexer Mini osteotomo.....	263	Luikart-Bill tractor.....	604
Lahey ganchito.....	149	Lexer osteotomo.....	263	Luikart-Kielland forceps obstetrico.....	603
Lahey pinza hemostatica.....	119/2, 120	Lexer tijera de diseccion.....	53	Luikart-McLean-Tucker forceps obstetrico.....	603/1
Lahey pinza para agarrar el bocio.....	479	Leyla separador de sistema.....	368-368/3	Lundsgaard esclerotomo.....	373
Lahey separador.....	157	lezna Obwegeser.....	463, 463/3	Lundsgaard-Guyton esclerotomo.....	373
Lambert pinza para chalazion.....	393	Lichtenberg porta aguja.....	213	Luniatshchek tamponeador.....	465
Lambert-Kay pinza para anastomosis.....	505	Lichtwitz trocar para seno maxilar.....	204		
Lambert-Lowman pinza para huesos.....	249	Liebermann blefarostato.....	371	M	
Lambotte osteotomo.....	261	ligador para hemorroides.....	568	Magill pinza para introducir cateter.....	28
Lambotte periototomo.....	274	ligador para hemorroides McGivney.....	568	Maier-Gross pinza porta-esponja.....	134
Lambotte pinza para hueso.....	244	ligador para hemorroides Rudd.....	568	Maingot pinza para histerectomia.....	123/1, 123/2
Lambotte-Farabeuf pinza para hueso.....	243	lima nasal Aufrecht.....	443	malla de alambre.....	311
lampara frontal Clar.....	22	lima nasal Cottle (Maltz).....	444	Maltz (Cottle) lima nasal.....	444
lampara halogena.....	29	lima nasal Fomon.....	444, 445	Maltz lima nasal.....	443, 444
Lancaster blefarostato.....	371	lima nasal Joseph (Lewis).....	443	mamaria separador.....	486/1
Landau especulo vaginal.....	577	lima nasal Lewis (Joseph).....	443	mandril.....	300
Landau-Segond pinza para histerectomia.....	125	lima nasal Maltz.....	443, 444	mandril para cateter Guyon.....	554
Landolt pinza para tumores.....	341/2	lima nasal Maltz (Cottle).....	444	mango bisturi Mini.....	41
Lane destornillador.....	323, 324	lima para hueso Joseph.....	443	mango bisturies.....	38-41
Lane elevador.....	290	lima para huesos.....	294, 443-446, 612/1	mango con iluminacion para proctoscopia Morgan.....	565
Lane palanca para doblar placas.....	325	lima para huesos Putti.....	294	mango de acople rapido.....	301
Lane pinza de campo.....	133	lima para seno Gallaher.....	446	mango de aspiracion Wullstein.....	338

mango de bisturi Collin.....	40	Mayo-Noble tijera de diseccion.....	52/1	Millin pinza para ligadura.....	551
mango de pila para laringoscopia.....	32-34	Mayo-Robson pinza intestinal.....	541	Millin pinza para lobo anterior.....	551
mango para cincel/gubia.....	266	Mayo-Stille tijera de diseccion.....	52/1	Millin separador cuello vejiga.....	553
mango para espejo laringeo.....	473	Mayo-Stille tijera supercut.....	71	Millin separador vesical.....	552
mango para sierra hilo Gigli.....	332	McCullough pinza para estrabismo.....	385	Mini Friedmann pinza gubia.....	234
mango universal Huber.....	472	McDonald elevador.....	283	Mini Hohmann elevador.....	286
manguito de cierre Stone-Watt.....	545	McGee gancho.....	419	Mini mango de bisturi.....	41
manguito de cierre Watt-Stone.....	545	McGee pinza auricular micro.....	414	Mini Roux separador.....	140
manipulador Kuglen.....	376	McGivney ligador para hemorroides.....	568	Mini-Lambotte osteotomo.....	262
manometro.....	295	McGivney pinza para hemorroides.....	568	Minimus II esfigmomanometro.....	11
manopla de plomo.....	250	McIndoe pinza cortante para huesos.....	241	Minimus III esfigmomanometro.....	12
marcador Amsler-Connin.....	380	McIndoe pinza de diseccion.....	85	Mini-Townsend-Down pinza para biopsia.....	591
marcador Connin-Amsler.....	380	McIndoe tijera para cartilago.....	65/1	Mini-Townsend-Up pinza para biopsia.....	591
Marquardt pinza gubia.....	239	McIntosh juego de laringoscopia.....	31	Minnesota-Cawood baja-lengua.....	451
Marschik pinza para amigdalas.....	468	McIntosh laringoscopia.....	29	Mixer Baby pinza hemostatica.....	119/1
Martel pinza hemostatica.....	110	McIntyre canula lacrimal.....	394	Mixer pinza hemostatica.....	116, 119/1-120
Martel Willet pinza hemostatica.....	110	McIvor abre-boca.....	457	Mixer pinza para calculos biliares.....	530/2, 531
martillo.....	24, 270-273	McKenty elevador para el tabique nasal.....	437, 438	Mixer-DeBakey pinza para ligaduras.....	499/2
martillo Bergmann.....	272	McKenzie pinza aplicadora.....	326	Mixer-O'Shaughnessy pinza hemostatica.....	119/2
martillo Collin.....	270	McLean forceps obstetrico.....	603/1	Mixer-Overholt pinza hemostatica.....	115
martillo Cottle.....	273	McLean-Luikart forceps obstetricos.....	603/1	Mod. Bonn pinza para sutura.....	386
martillo de percusion Babinsky.....	24	McLean-Tucker forceps obstetrico.....	603/1	Mod. Muenchen cureta para biopsia.....	587
martillo de percusion Berliner.....	24	McLean-Tucker-Luikart forceps obstetrico.....	603/1	Mod. Tübingen pinza para ligadura.....	392
martillo de percusion Buck.....	24	McPherson pinza para ligadura.....	392	Mod. Tübingen pinza para sutura.....	386
martillo de percusion Taylor.....	24	Mead martillo.....	271	Mod. USA tijera para cordon umbilical.....	64
martillo de percusion Troemner.....	24	Mead pinza gubia.....	235	Mod. Vienna especulo nasal.....	421
martillo Gerzog.....	270	Meeker pinza hemostatica.....	119	Moeftgen goniometro.....	25
martillo Hajek.....	273	Mehdorn pinza para vasos.....	362	Mogen instrumento para circuncision.....	556
martillo Heath.....	273	Mellinger blefarostato.....	370	Mollison separador.....	171
martillo Kirk.....	270	Mellinger-Axenfeld blefarostato.....	370	Molt (Doyen-Jansen) abre-boca.....	454
martillo Lucae.....	271	Menghini aguja para biopsia.....	206	Molt periototomo.....	276
martillo Mead.....	271	meniscotomo Neff.....	292	mondador de tendones Brand.....	294
martillo Ombredanne.....	273	meniscotomo Smillie.....	292	monopolares pinza.....	634
martillo Partsch.....	271	Mercedes separador toracico.....	489	Moor cuchara para calculos biliares.....	531
martillo Quising.....	271	Meriam pinza dental.....	93	Moore perforador de mano.....	298
martillo Williger.....	271	Metzenbaum porta aguja.....	211	Moore-Staude pinza uterina.....	582
Martin histerometro.....	586	Metzenbaum tijera de diseccion.....	53/1	Moorfield pinza para sutura.....	392
Martin pelvimetro.....	605	Metzenbaum tijera para cirugia.....	54	More-Vu especulo vaginal.....	569
Martin pinza para cartilago.....	246	Metzenbaum tijera supercut.....	71	Morgan protoscopia.....	565
Martin separador.....	175/1	Meyer pinza para aplicar agrafes.....	248	Morgan-Tischler pinza para biopsia.....	590, 591
Martin-Cartilage tijera.....	65/1	Meyer-Davis abre-boca.....	457	Moritz-Schmidt baja-lengua.....	452
Martini cucharilla cortante.....	257	Meyerding separador.....	157, 177, 180	Morris separador.....	164
Masing elevador.....	437	Meyhoefer cucharilla para chalazion.....	377	Morris-DeBakey pinza para la aorta.....	506
Masing elevador para tabique nasal.....	437	Michel agrafe.....	224	Morse separador costal.....	484
Masing retractor nasal.....	447	Michel espejo laringeo.....	423	Morse-Favaloro separador costal.....	484
Masing-Neivert retractor nasal.....	447	Michel pinza para aplicar agrafes.....	224	Mosher-Wagener canula para traqueotomia.....	477
Masson porta aguja.....	210	Michel pinza para aplicar y quitar agrafes.....	224	Mosquito-DeBakey pinza hemostatica.....	509
Masson-Judd separador vesical.....	552	micro cuchillo Koos.....	335	Mosquito-Halsted pinza hemostatica.....	105
Mastin pinza muscular.....	479	Micro Friedmann pinza gubia.....	234	Moynihan explorador apra calculos biliares.....	531
Mathieu especulo rectal.....	560	micro pinza.....	86, 94	Moynihan pinza de campo.....	133
Mathieu pinza para cuerpos extraños.....	553/1	micro pinza auricular.....	413-415	Moynihan pinza hemostatica.....	120
Mathieu porta aguja.....	213	micro porta aguja Barraquer.....	216, 217	Mueller bierarostato.....	371
Mathieu separador.....	141	micro porta aguja Barraquer-Trountman.....	216	Muenchen Mod. cureta para biopsia.....	587
Mathieu-Olsen porta aguja.....	212	micro porta aguja Castroviejo-Standard.....	216	Müller aproximador.....	364
Matson periototomo.....	279	micro porta aguja Standard-Castroviejo.....	216	Müller clip para vasos.....	365
Matson-Alexander periototomo.....	279	micro porta aguja Troutman-Barraquer.....	216	Müller-Verbrugge elevador.....	286/2
Mauder garrote de madera.....	459	micro tijera.....	76-78	Mummery-Lockhart sonda para fistula.....	200
Maxi Grasper pinza para biopsia.....	593	micro tijera Circumflex.....	76	Murdoch blefarostato.....	370
May oftalmoscopio Uni II.....	14	micro tijera Gommel.....	80	Murphy separador.....	156
Mayfield pinza gubia.....	238	micro tijera Hepp-Scheidel.....	78	Murphy-Lane elevador.....	283
Mayo baja-lengua.....	451	micro tijera Reda.....	77, 80	Murray-Crile porta aguja.....	209
Mayo clip para esterilizacion.....	227, 624	micro tijera Scheidel-Hepp.....	78	Museux pinza uterina.....	583
Mayo cuchara para calculos biliares.....	534	Micro-Castroviejo porta aguja.....	215	Myles pinza nasal.....	427
Mayo pinza de diseccion.....	89	Microvascular porta aguja.....	210		
Mayo sonda para calculos biliares.....	534	Middeldorf separador.....	160	N	
Mayo tijera de diseccion.....	52/1	Middleton-Jansen pinza para el tabique nasal.....	430	Nabatoff juego para varices.....	201
Mayo tijera supercut.....	71	Mikulicz pinza intestinal.....	543	Naegele forceps obstetrico.....	603
Mayo-Adams separador.....	171	Mikulicz pinza para peritoneo.....	123	Nager aguja para sutura del paladar.....	466
Mayo-Blake pinza para calculos biliares.....	530/2	Mikulicz separador.....	163	Nager separador para paladar.....	465
Mayo-Collins separador.....	141	Miller laringoscopia.....	30	Nasalis-Spina separador para el ramo.....	461
Mayo-Guyon pinza hemostatica.....	122	Miller-Senn separador.....	143	navaja.....	49
Mayo-Haberisser pinza para torcer hilo.....	319	Milligan elevador para duramadre.....	332	Neff meniscotomo.....	292
Mayo-Hegar porta aguja.....	209	Millin pinza de agarre para capsula.....	550, 551	Negus pinza para coger amigdalas.....	467

Negus soporte de pecho.....459	Overholt-Baby pinza hemostatica.....114	periotostomo Matson-Alexander.....279
Neivert porta aguja.....208	Overholt-Geissendoerfer pinza hemostatica.....114	periotostomo Molt.....276
Neivert-Anderson cincel nasal.....442	Overholt-Mixer pinza hemostatica.....115	periotostomo Obwegeser.....462
Neivert-Cottle gancho para la piel.....448		periotostomo Quervain.....275
Neivert-Masing retractor nasal.....447	P	periotostomo Sebleau.....275
Nelaton sonda.....199	Pacific-Kevorkian pinza para biopsia.....592	periotostomo Sedillot.....274, 275
Nelson (Standard) trocar abdominal.....204	palanca para doblar placas Lane.....325	periotostomo Seldin.....277
Nelson aguja para ligadura.....219	Palmer-Pozzi pinza uterina.....582	periotostomo Semb.....278
Nelson pinza de diseccion.....89	Park blierarostato.....371	periotostomo Williger.....276
Nelson trocar.....205	Parker separador.....139	Perkins separador.....168
Neonatal pinza vascular.....523	Parker-Langenbeck / Us Army separador.....141	Perthes escariador.....304
News gancho para traqueotomia.....477	Partsch cincel.....259	Pestalozza cureta para aborto.....606
Nissen pinza hemostatica.....113	Partsch gubia.....259	Petersen-Smith cincel.....261
Noble-Mayo tijera de diseccion.....52/1	Partsch martillo.....271	Petersen-Smith gubia.....261
Norfolk / Norwich separador.....172	pasador de tendones Bunell.....294	Petersen-Smith pinza gubia.....238
Northent tijera.....66	Passow cincel tamponador para huesos.....260	Petri cubeta.....620
Norwich / Norfolk separador.....172	Patella pinza para hueso.....248	Phaneuf pinza para peritoneo.....123
Noto pinza para polipos uterinos.....585	Paton disecador corneal.....373	Pierce elevador para el tabique nasal.....438
Nova esfingomanometro.....7	Paufique cuchillo para queratoplastica.....373	Pierce trocar para seno maxilar.....204
Novak cureta aspiradora para biopsia uterina.....587	Paufique pinza para ligadura.....392	pieza de acomplamiento para cureta aspiradoras.....600
Nova-Presameter esfingomanometro.....6	Payr pinza intestinal y estomacal.....548	Piffard cureta para lupus.....608
Noyes pinza para polipos.....425	Payr sonda conductora.....221/1	Pinard estetoscopio.....23
Noyes tijera para iris.....75	Payr-Baby pinza intestinal y estomacal.....548	pinza aplicadora.....104
O	Payr-Schmieden sonda conductora.....221	pinza aplicadora de clips.....524, 525
Obwegeser elevador.....461/1	Pean pinza hemostatica.....108, 110	pinza aplicadora McKenzie.....326
Obwegeser gancho de menton.....461/1	Pean-DeBakey pinza hemostatica atraumatica.....513	pinza aplicadora Olivecrona-Toennis.....326
Obwegeser lezna.....463, 463/3	Pean-Rochester pinza hemostatica.....108	pinza aplicadora Raney.....327
Obwegeser osteotomo.....463	Peapod pinza cortante para laminectomia.....341/1	pinza aplicadora Smithwick.....326
Obwegeser osteotomo de hoja.....464/1	Peck Joseph tijera face lift.....73	pinza aplicadora Sweet.....326
Obwegeser periotostomo.....462	Pederson espejulo vaginal.....570	pinza aplicadora Toennis-Olivecrona.....326
Obwegeser separador manibular.....461/1	Peers pinza de campo.....132	pinza traumatica Cooley.....99
Obwegeser separador para partes blandas.....460	Peet escofina nasal.....446	pinza traumatica DeBakey.....98, 99
Ochsner pinza de diseccion.....88	Peet pinza para espinas.....92	pinza traumatica Gregory.....517
Ochsner trocar.....205	Pelkmann pinza porta esponja.....137	pinza traumatica Reda.....111
Ochsner-Rochester pinza hemostatica.....108	pelvimetro Collier.....605	pinza traumatica Rogers.....127
O'Conner gancho para iris.....375	pelvimetro Collin.....605	pinza auricular Harken.....503
O'Conner-O'Sullivan espejulo vaginal.....576	pelvimetro Martin.....605	pinza auricular Hartmann.....411
O'Conner-O'Sullivan separador abdominal.....181	Pemberton-Harrington separador.....147	pinza auricular Littauer.....411
Oehler pinza de diseccion.....81/1	Penfield elevador para duramadre.....333	pinza auricular Lucae.....413
oftalmoscopio May Uni II.....14	Pennington elevador para el tabique nasal.....438	pinza auricular micro.....410-415
Oldberg pinza cortante para laminectomia.....341/1	Pennington pinza hemostatica.....109	pinza auricular micro Cos.....414
oliva auricular.....406	Percy retractor para amputacion.....296	pinza auricular micro Dieter.....414
oliva auricular Politzer.....406	perforacraneeo Smellie.....607	pinza auricular micro Greven.....414
Olivecrona elevador para duramadre.....332	perforador de mano.....298-300, 304	pinza auricular micro Haugh.....414
Olivecrona espátula cerebral.....336	perforador de mano Bunell.....299	pinza auricular micro Juers.....414
Olivecrona pinza gubia.....237	perforador de mano Hudson.....299	pinza auricular micro McGee.....414
Olivecrona sierra hilo.....332	perforador de mano Kirschner.....299	pinza auricular micro Wullstein.....416
Olivecrona-Toennis pinza aplicadora.....326	perforador de mano Moore.....298	pinza auricular Tilley.....411
Ollier separador.....162	perforador de mano Stille.....300	pinza auricular Troeltsch (Wilde).....410
Olsen-Hegar porta aguja.....212	perforador de mano Reda.....300	pinza auricular Wilde (Troeltsch).....410
Olsen-Mathieu porta aguja.....212	perforador de mano Sherman-Stille.....298	pinza autocentradora para sostener huesos Reda.....247
Ombredanne martillo.....273	perforador de mano Stille-Sherman.....298	pinza bronquial.....126
O'Shaughnessy-Mixer pinza hemostatica.....119/2	perforador de mano Stille.....298	pinza bronquial Finochietto.....490
osteotomo.....259-267, 464	perforador inicial Crutchfield.....327	pinza bronquial Harrington.....490
osteotomo de hoja Obwegeser.....464/1	perforador medular.....322	pinza bronquial Lees.....504
osteotomo Epker.....464/2	perforador para femur Kuntscher.....321	pinza bronquial Price-Thomas.....490
osteotomo Hibbs.....265	perforador para la cavidad medular Kuntscher.....321	pinza bronquial Semb.....491
osteotomo Hoke.....265	periotostomo.....274-280, 463-464	pinza bronquial Thomas-Price.....490
osteotomo Lambotte.....261	periotostomo Alexander.....276	pinza capsular Arruga.....391
osteotomo Lambotte-Mini.....262	periotostomo Alexander-Matson.....279	pinza capsular Arruga-Gill.....390
osteotomo Lexer.....263	periotostomo Cobb.....280	pinza capsular Castroviejo.....391
osteotomo Lexer Mini.....263	periotostomo Collin-Farabeuf.....274	pinza capsular Elschmig.....391
osteotomo Mini Lexner.....263	periotostomo Dingman.....463	pinza capsular Fuchs.....391
osteotomo Mini-Lambotte.....262	periotostomo Doyen.....278	pinza capsular Gill-Arruga.....390
osteotomo Obwegeser.....463	periotostomo Farabeuf.....274	pinza capsular Hess.....391
osteotomo Stille.....260	periotostomo Farabeuf-Collin.....274	pinza capsular Kalt.....391
Ostroem pinza sacabocado.....430	periotostomo Fomon.....277	pinza capsular Schweigger.....391
O'Sullivan-O' Connor espejulo vaginal.....576	periotostomo Hargis.....463/2	pinza capsular Terson.....391
O'Sullivan-O' Connor separador abdominal.....181	periotostomo Joseph.....277	pinza tierra-tubo.....129, 130
Otis uretrotomo.....553	periotostomo König.....276	pinza tierra-tubo Berlin Klinikum.....129
otoscopio Uni I.....13	periotostomo Lambotte.....274	pinza tierra-tubo Bülow-Gunar-Hey.....130
Overholt pinza hemostatica.....114	periotostomo Langenbeck.....275	pinza tierra-tubo Gunar-Hey-Bülow.....130
	periotostomo Matson.....279	pinza tierra-tubo Hey-Bülow-Gunar.....130

pinza cierra-tubo Klinikum Berlin.....	129	pinza de diseccion Duehrsen.....	84	pinza gubia Ruskin-Stille.....	239
pinza cierra-tubo Presbyterian.....	129	pinza de diseccion Durante.....	88	pinza gubia Sauerbruch.....	240
pinza circular.....	432	pinza de diseccion Duval.....	85	pinza gubia Scagletti.....	240
pinza cortante Hajek-Kofler.....	429	pinza de diseccion Duval-Collin.....	85	pinza gubia Semb.....	240
pinza cortante Kerrison.....	428	pinza de diseccion Ferris-Smith.....	85	pinza gubia Smith-Petersen.....	238
pinza cortante Kofler-Hajek.....	429	pinza de diseccion Gerald.....	86, 87	pinza gubia Stellbrink.....	234
pinza cortante para hipofisis.....	341	pinza de diseccion Gillies.....	86	pinza gubia Stille (Leksell).....	240
pinza cortante para huesos Böhler.....	241	pinza de diseccion Graefe.....	83	pinza gubia Stille-Luer.....	239
pinza cortante para huesos Cottle-Kazanjian.....	241	pinza de diseccion Lane.....	84	pinza gubia Stille-Ruskin.....	239
pinza cortante para huesos Horsley-Stille.....	242	pinza de diseccion Lerche.....	83	pinza gubia Zaufal-Jansen.....	238
pinza cortante para huesos Kazanjian-Cottle.....	241	pinza de diseccion Mayo.....	89	pinza hemorroidal Heywood-Smith.....	567
pinza cortante para huesos Liston.....	241	pinza de diseccion McIndoe.....	85	pinza hemorroidal Smith-Heywood.....	567
pinza cortante para huesos Liston-Ruskin.....	241	pinza de diseccion modelo ruso.....	85	pinza hemostatica Adson.....	112, 113
pinza cortante para huesos Liston-Stille.....	242	pinza de diseccion modelo Strassburger.....	89	pinza hemostatica Adson Baby.....	113
pinza cortante para huesos McIndoe.....	241	pinza de diseccion Nelson.....	89	pinza hemostatica atraumatica DeBakey-Mosquito.....	509
pinza cortante para huesos Ruskin-Liston.....	241	pinza de diseccion Ochsner.....	88	pinza hemostatica atraumatica DeBakey-Pean.....	513
pinza cortante para huesos Semb.....	242	pinza de diseccion Oehler.....	81/1	pinza hemostatica atraumatica DeBakey-Rankin.....	512
pinza cortante para huesos Stamm.....	241	pinza de diseccion Potts-Smith.....	81, 81/1	pinza hemostatica atraumatica Mosquito-DeBakey.....	509
pinza cortante para huesos Stille-Horsley.....	242	pinza de diseccion Serchen.....	86	pinza hemostatica atraumatica Pean-DeBakey.....	513
pinza cortante para huesos Stille-Liston.....	242	pinza de diseccion Singley.....	88	pinza hemostatica atraumatica Rankin-DeBakey.....	512
pinza cortante para laminectomia Cloward.....	342	pinza de diseccion Smith-Ferris.....	85	pinza hemostatica Baby Adson.....	113
pinza cortante para laminectomia Cushing.....	340	pinza de diseccion Smith-Potts.....	81, 81/1	pinza hemostatica Baby Mixer.....	119/1
pinza cortante para laminectomia Decker.....	341	pinza de diseccion Standard.....	81, 81/1	pinza hemostatica Baby-Overholt.....	114
pinza cortante para laminectomia Ferris-Smith.....	343	pinza de diseccion Stille.....	81, 81/1	pinza hemostatica Bainbridge.....	119/2
pinza cortante para laminectomia Gruenwald-Love.....	340	pinza de diseccion Stille-Barraya.....	88	pinza hemostatica Bengolea.....	112
pinza cortante para laminectomia Love-Gruenwald.....	340	pinza de diseccion Taylor.....	87	pinza hemostatica Birkett.....	116
pinza cortante para laminectomia Oldberg.....	341/1	pinza de diseccion Taylor-Cushing.....	87	pinza hemostatica Bridge.....	116
pinza cortante para laminectomia Peapod.....	341/1	pinza de diseccion USA.....	81, 81/1	pinza hemostatica Carmalt-Rochester.....	109
pinza cortante para laminectomia Schlesinger.....	342	pinza de diseccion Wagensteen.....	89	pinza hemostatica Chaput.....	110
pinza cortante para laminectomia Smith-Ferris.....	343	pinza de diseccion Waugh.....	83	pinza hemostatica Collier-Crile.....	106
pinza cortante para laminectomia Spurling.....	340	pinza de proteccion Adson.....	298	pinza hemostatica Collin.....	110
pinza cortante para laminectomia Wagner.....	343	pinza de reduction Reda.....	247	pinza hemostatica Crafoord.....	118
pinza cuticular.....	610	pinza de relojero.....	90	pinza hemostatica Crafoord-Sellors.....	119
pinza de agarre.....	305	pinza de rodillos.....	131	pinza hemostatica Crile.....	107
pinza de agarre para capsula Milin.....	292-294, 550, 551	pinza de traccion craneal Crutchfield.....	327	pinza hemostatica Crile-Collier.....	106
pinza de agarre para prostata Young.....	550	pinza dental College-London.....	93	pinza hemostatica Crile-Rankin.....	107
pinza de agarre para tendones.....	292, 293	pinza dental London-College.....	93	pinza hemostatica Dandy.....	109
pinza de agarre para tendones Brand.....	293	pinza dental Meriam.....	93	pinza hemostatica Desjardins.....	121
pinza de agarre para tendones Carroll.....	293	pinza depiladora Barraquer.....	395	pinza hemostatica Fergusson.....	109
pinza de agarre para tendones Jackson.....	292	pinza depiladora Beer.....	395	pinza hemostatica Fuchsig.....	113
pinza de agarre para tendones Kleinert-Kutz.....	294	pinza depiladora Douglas.....	395	pinza hemostatica Geissendoerfer-Overholt.....	114
pinza de agarre para tendones Kutz-Kleinert.....	294	pinza depiladora Gradle.....	395	pinza hemostatica Gemini.....	115
pinza de agarre para tendones Steinmann.....	292	pinza depiladora Littauer.....	395	pinza hemostatica Gray.....	121
pinza de aplicacion.....	357-360	pinza depiladora Reda.....	395	pinza hemostatica Guyon.....	122
pinza de campo.....	132, 133	pinza estomacal Lane.....	547	pinza hemostatica Guyon-Mayo.....	122
pinza de campo Backhaus.....	132	pinza gubia Adson.....	236	pinza hemostatica Halsted-Mosquito.....	105
pinza de campo Backhaus-Clip.....	132	pinza gubia Bane-Hartmann.....	237	pinza hemostatica Hartmann.....	104
pinza de campo Bernhard.....	133	pinza gubia Beyer.....	237, 238	pinza hemostatica Heiss.....	112
pinza de campo Clip-Backhaus.....	132	pinza gubia Blumenthal.....	236	pinza hemostatica Hopkins-Johns.....	120
pinza de campo Clip-Jones.....	132	pinza gubia Böhler.....	238	pinza hemostatica Hospital-Providence.....	106
pinza de campo Doyen.....	133	pinza gubia Cleveland.....	235	pinza hemostatica Johns-Hopkins.....	120
pinza de campo Jones.....	132	pinza gubia Echlin.....	240	pinza hemostatica Kantrowitz.....	119/1
pinza de campo Jones-Clip.....	132	pinza gubia Friedmann.....	234	pinza hemostatica Kelly.....	106
pinza de campo Lane.....	133	pinza gubia Friedmann Micro.....	234	pinza hemostatica Kelly-Rankin.....	106
pinza de campo Moynihan.....	133	pinza gubia Friedmann Mini.....	234	pinza hemostatica Kocher.....	108
pinza de campo Peers.....	132	pinza gubia Frykholm.....	240	pinza hemostatica Lahey.....	119/2, 120
pinza de campo Roeder.....	132	pinza gubia Hartmann-Bane.....	237	pinza hemostatica Lawrence.....	119
pinza de campo Schaedel.....	132	pinza gubia Jansen.....	237	pinza hemostatica Leriche.....	111
pinza de campo Tohoku.....	132	pinza gubia Jansen-Zaufal.....	238	pinza hemostatica Lovelace.....	109
pinza de diseccion.....	81-89	pinza gubia Kleinert-Kutz.....	237	pinza hemostatica Lower.....	120
pinza de diseccion Adlerkreutz.....	84	pinza gubia Kutz-Kleinert.....	237	pinza hemostatica Martel.....	110
pinza de diseccion Adson.....	81/2, 82	pinza gubia Leksell (Stille).....	240	pinza hemostatica Martel Willet.....	110
pinza de diseccion Adson-Brown.....	82	pinza gubia Lempert.....	237	pinza hemostatica Mayo-Guyon.....	122
pinza de diseccion Adson-DeBakey.....	81/2	pinza gubia Luer.....	236	pinza hemostatica Meeker.....	119
pinza de diseccion Barraya-Stille.....	88	pinza gubia Luer-Stille.....	239	pinza hemostatica Mixer.....	116, 119/1-120
pinza de diseccion Bonney.....	88	pinza gubia Marquardt.....	239	pinza hemostatica Mixer Baby.....	119/1
pinza de diseccion Brophy.....	84	pinza gubia Mayfield.....	238	pinza hemostatica Mixer-O'Shaugnessy.....	119/2
pinza de diseccion Brown.....	83	pinza gubia Mead.....	235	pinza hemostatica Mixer-Overholt.....	115
pinza de diseccion Brown-Adson.....	82	pinza gubia Micro Friedmann.....	234	pinza hemostatica Mosquito-Halsted.....	105
pinza de diseccion Collin-Duval.....	85	pinza gubia Mini Friedmann.....	234	pinza hemostatica Moynihan.....	120
pinza de diseccion Cushing.....	83	pinza gubia Olivecrona.....	237	pinza hemostatica Nissen.....	113
pinza de diseccion Cushing-Taylor.....	87	pinza gubia Petersen-Smith.....	238	pinza hemostatica Ochsner-Rochester.....	108
pinza de diseccion DeBakey-Adson.....	81/2	pinza gubia Ruskin.....	239	pinza hemostatica O'Shaugnessy-Mixer.....	119/2

pinza hemostatica Overholt	114	pinza nasal Jansen	424	pinza para biopsia Townsend.....	591
pinza hemostatica Overholt-Baby.....	114	pinza nasal Jansen-Gruenwald	424	pinza para biopsia Townsend-Down-Mini.....	591
pinza hemostatica Overholt-Geissendoerfer.....	114	pinza nasal Knight	425	pinza para biopsia Townsend-Up-Mini	591
pinza hemostatica Overholt-Mixter	115	pinza nasal Knight-Heymann	425	pinza para biopsia Turrel	567
pinza hemostatica Pean.....	108, 110	pinza nasal Lubet-Barbon	424	pinza para biopsia Up-Mini-Townsend	591
pinza hemostatica Pean-Rochester	108	pinza nasal Luc	426	pinza para biopsia Up-Tischler	591
pinza hemostatica Pennington	109	pinza nasal Myles.....	427	pinza para biopsia Van Doren	588
pinza hemostatica Pratt	110	pinza nasal Schmeden	427	pinza para biopsia Wittner	589
pinza hemostatica Providence-Hospital	106	pinza nasal Struycken	427	pinza para biopsia Yeoman	566, 567
pinza hemostatica Rankin-Crile	107	pinza nasal Takahashi	427	pinza para bronco-esofagoscopia Chevalier-Jackson	473
pinza hemostatica Rankin-Kelly	106	pinza nasal Troeltsch	424	pinza para bronco-esofagoscopia Jackson-Chevalier	473
pinza hemostatica Roberts	117	pinza nasal Watson-Williams.....	428	pinza para calculos biliares Blake	530/2
pinza hemostatica Rochester-Carmalt.....	109	pinza nasal Weil-Blakesley	426	pinza para calculos biliares Blake-Mayo	530/2
pinza hemostatica Rochester-Ochsner	108	pinza nasal Westmacott	424	pinza para calculos biliares Desjardins	530/2
pinza hemostatica Rochester-Pean	108	pinza nasal Williams-Watson.....	428	pinza para calculos biliares Mayo-Blake	530/2
pinza hemostatica Rumel.....	117	pinza para aborto Saenger	606	pinza para calculos biliares Mixter.....	530/2
pinza hemostatica Sarot.....	118	pinza para aborto Winter.....	606	pinza para calculos renales Heiming	536
pinza hemostatica Sellors-Crafoord.....	119	pinza para agarrar el bocio Lahey.....	479	pinza para calculos renales Randall	535
pinza hemostatica Spencer-Wells	109	pinza para amigdalas Marschik	468	pinza para cambiar hojas	179
pinza hemostatica Stille	122	pinza para anastomosis Beck	516, 520	pinza para campo Ball and Socket	133
pinza hemostatica Toennis	117	pinza para anastomosis Cooley	519-520/4	pinza para campo Lorna	133
pinza hemostatica Tuffier	110	pinza para anastomosis Cooley-Derra.....	519	pinza para campo Socket and Ball.....	133
pinza hemostatica Wells-Spencer	109	pinza para anastomosis DeBakey.....	505, 515	pinza para capsuloridectom Holth	380
pinza hemostatica Wikstroem	117	pinza para anastomosis DeMartel-Wolfson	546	pinza para cartilagos Martin	246
pinza hemostatica Willet Martel	110	pinza para anastomosis Derra	515	pinza para cateter Cooley	510
pinza hemostatica Zenker	118	pinza para anastomosis Derra-Cooley.....	519	pinza para cerrar clamps DeMartel-Wolfson	546
pinza intestinal Adair-Allis	537	pinza para anastomosis Hayes	545	pinza para cerrar clamps Stone	545
pinza intestinal Allis	537	pinza para anastomosis Kay-Lambert	505	pinza para cerrar clamps Wolfson-DeMartel	546
pinza intestinal Allis-Adair	537	pinza para anastomosis Lambert-Kay	505	pinza para chalazion Desmarres	393
pinza intestinal Allis-Baby	537	pinza para anastomosis Potts	493	pinza para chalazion Lambert	393
pinza intestinal Allis-Boys	538	pinza para anastomosis Wolfson-DeMartel	546	pinza para coartacion Potts	492
pinza intestinal Allis-Judd	538	pinza para aneurisma Bahnsen-DeBakey.....	506	pinza para coger amigdalas Abraham	468
pinza intestinal Allis-Lockwood	538	pinza para aneurisma de la aorta DeBakey.....	496-498	pinza para coger amigdalas Ballenger	467
pinza intestinal Allis-Thoms	538	pinza para aneurisma DeBakey-Bahnsen	506	pinza para coger amigdalas Blohmke.....	467
pinza intestinal Babcock	539	pinza para aorta Cooley.....	520/3	pinza para coger amigdalas Colver	467
pinza intestinal Baby-Allis	537	pinza para apendice Allen	544	pinza para coger amigdalas Negus	467
pinza intestinal Baby-Doyen	540	pinza para apendice Kleinschmidt	544	pinza para coger amigdalas Sawtell	467
pinza intestinal Baby-Kocher	540	pinza para aplicar agrafes Childe	224	pinza para coger amigdalas Schmidt	467
pinza intestinal Boys-Allis	538	pinza para aplicar agrafes Hegenbarth	224	pinza para coger amigdalas Tyding	468
pinza intestinal Brunner	543	pinza para aplicar agrafes Michel	224	pinza para coger amigdalas White	467
pinza intestinal Doyen	540	pinza para aplicar agrafes Wachenfeldt	224	pinza para coger el pulmon Lovelace	490
pinza intestinal Doyen-Baby	540	pinza para aplicar y quitar agrafes Michel.....	224	pinza para columna Cottle	448
pinza intestinal Fehland	542	pinza para arrancar uñas Radolf	297	pinza para cordon espermatico	553/2
pinza intestinal Gregoire	538	pinza para arrancar vendaje enyesado Wolff.....	233	pinza para cuerpos extraños Mathieu	553/1
pinza intestinal Judd-Allis	538	pinza para biopsia Alexander	589	pinza para desechos Sauerbruch	227
pinza intestinal Kocher	540	pinza para biopsia Baby Burke	590	pinza para el pene Stockmann	553/1
pinza intestinal Kocher-Baby	540	pinza para biopsia Baby-Tischler	592	pinza para el pene Strauss	553/1
pinza intestinal Littlewood	538	pinza para biopsia Burke	590	pinza para el tunel del tendon	293
pinza intestinal Lockwood-Allis	538	pinza para biopsia Burke Baby	590	pinza para el utero Collin	585
pinza intestinal Mayo-Robson	541	pinza para biopsia Down-Mini-Townsend.....	591	pinza para el utero Dartigues	585
pinza intestinal Mikulicz	543	pinza para biopsia Down-Tischler	591	pinza para el utero Somer	585
pinza intestinal Resano	542	pinza para biopsia Eppendorfer	590	pinza para enderezar el tabique nasal Asch	449
pinza intestinal Robson-Mayo.....	541	pinza para biopsia Faure	588	pinza para enderezar el tabique nasal Walsham	449
pinza intestinal Scudder	541	pinza para biopsia Gaylor-Thomas	588	pinza para espinas	91, 92
pinza intestinal Stone-Watt	545	pinza para biopsia Grasper Maxi	593	pinza para espinas Archer.....	92
pinza intestinal Thoms-Allis	538	pinza para biopsia Grasper Serpentine	593	pinza para espinas Carmalt.....	91
pinza intestinal Watt-Stone	545	pinza para biopsia Kevorkian	589, 591	pinza para espinas Feilchenfeld	91
pinza intestinal y estomacal Baby-Payr.....	548	pinza para biopsia Kevorkian-Pacific	592	pinza para espinas Hunter	91
pinza intestinal y estomacal Payr.....	548	pinza para biopsia Kevorkian-Tischler	592	pinza para espinas Peet.....	92
pinza intestinal y estomacal Payr-Baby	548	pinza para biopsia Maxi Grasper	593	pinza para espinas Stieglitz	92
pinza maleolar	247	pinza para biopsia Mini-Townsend-Down.....	591	pinza para esterilizacion	227
pinza monopolares	634	pinza para biopsia Mini-Townsend-Up	591	pinza para esterilizacion Cheatle	227
pinza muscular Berke	389	pinza para biopsia Morgan-Tischler	590, 591	pinza para esterilizacion de jeringas Davis	227
pinza muscular Mastin	479	pinza para biopsia Pacific-Kevorkian	592	pinza para esterilizacion Rogge	227
pinza muscular Prince	386	pinza para biopsia Schubert	588	pinza para esterilizacion Universal	227
pinza muscular Snellen	393	pinza para biopsia Schumacher	588, 589	pinza para estrabismo Bonaccolto	385
pinza nasal Barbon-Lubet	424	pinza para biopsia Serpentine Grasper	593	pinza para estrabismo Dastoor	386
pinza nasal Blakesley-Weil	426	pinza para biopsia Thomas-Gaylor	588	pinza para estrabismo Jameson	385
pinza nasal Bruenings	425	pinza para biopsia Tischler-Baby	592	pinza para estrabismo McCullough	385
pinza nasal Gruenwald-Jansen	424	pinza para biopsia Tischler-Down	591	pinza para fijacion Arthur-Kirby	385
pinza nasal Hartmann	424, 427	pinza para biopsia Tischler-Kevorkian	592	pinza para fijacion Barraquer	390
pinza nasal Heymann	425	pinza para biopsia Tischler-Morgan	590, 591	pinza para fijacion Castroviejo	390
pinza nasal Heymann-Knight	425	pinza para biopsia Tischler-Up	591	pinza para fijacion Cottle	410

pinza para fijacion Elschmig.....	389	pinza para ligadura Ayer.....	393	pinza para tracoma Knapp-Luer.....	393
pinza para fijacion Graefe.....	389	pinza para ligadura DeBakey.....	493, 499-500	pinza para tracoma Luer-Knapp.....	393
pinza para fijacion Green.....	390	pinza para ligadura McPherson.....	392	pinza para tumores Landolt.....	341/2
pinza para fijacion Kirby-Arthur.....	385	pinza para ligadura Millin.....	551	pinza para tumores Yasargil.....	97
pinza para fijacion Lester.....	389	pinza para ligadura Mod. Tübingen.....	392	pinza para uso multiple Glover.....	515
pinza para hemorroides McGivney.....	568	pinza para ligadura Paufigue.....	392	pinza para uterus Armytage-Green.....	605
pinza para hipofisis Adson.....	334	pinza para ligadura Tübingen Mod.....	392	pinza para uterus Green-Armytage.....	605
pinza para histerectomia Ballentine-Heany.....	127	pinza para ligadura y la aorta DeBakey-Semb.....	499	pinza para vasectomia.....	553/2
pinza para histerectomia Cullen-Wertheim.....	125	pinza para ligadura y la aorta Semb-DeBakey.....	499	pinza para vasos Biemer.....	361
pinza para histerectomia Heaney.....	126	pinza para ligaduras DeBakey-Mixer.....	499/2	pinza para vasos Mehdon.....	362
pinza para histerectomia Heany-Ballentine.....	127	pinza para ligaduras DeBakey-Rumel.....	499	pinza para vasos perifericos Dale.....	494, 495
pinza para histerectomia Holzbach.....	126	pinza para ligaduras Mixer-DeBakey.....	499/2	pinza para vasos perifericos DeBakey.....	494
pinza para histerectomia Landau-Segond.....	125	pinza para ligaduras Rumel-DeBakey.....	499	pinza para vasos perifericos Jones-Leland.....	495
pinza para histerectomia Maingot.....	123/1, 123/2	pinza para lobo anterior Millin.....	551	pinza para vasos perifericos Leland-Jones.....	495
pinza para histerectomia Segond.....	125	pinza para magullar tabique Rubin.....	428	pinza para vasos Satinsky.....	491
pinza para histerectomia Landau-Landau.....	125	pinza para medicacion Bryant.....	137	pinza para vasos Satinsky.....	491
pinza para histerectomia Wertheim.....	124, 128	pinza para microcirugia.....	96	pinza pico plano.....	317, 320
pinza para histerectomia Wertheim-Cullen.....	125	pinza para micro-cirugia de la laringe.....	474	pinza porta esponja Bozemann.....	138
pinza para hueso Bircher-Ganske.....	246	pinza para oclusion tangencial DeBakey-Satinsky.....	502	pinza porta esponja Bozemann-Douglas.....	138
pinza para hueso Dingmann.....	246	pinza para oclusion tangencial Satinsky-DeBakey.....	502	pinza porta esponja Cheron.....	137
pinza para hueso Farabeuf.....	243	pinza para parametrio.....	128/1	pinza porta esponja Collin.....	137
pinza para hueso Farabeuf-Lambotte.....	243	pinza para parametrio Reda.....	128/1	pinza porta esponja Douglas-Bozemann.....	138
pinza para hueso Fergusson.....	243	pinza para pediculo Herrick.....	123	pinza porta esponja Lister (Sinus).....	137
pinza para hueso Ganske-Bircher.....	246	pinza para pericraneos Gauss.....	605	pinza porta esponja Pelkmann.....	137
pinza para hueso Kern.....	244	pinza para peritoneo Faure.....	123	pinza porta esponja Sinus (Lister).....	137
pinza para hueso Lambotte.....	244	pinza para peritoneo Mikulicz.....	123	pinza porta-esponja Duplay.....	134
pinza para hueso Lambotte-Farabeuf.....	243	pinza para peritoneo Phaneuf.....	123	pinza porta-esponja Gross-Maier.....	134
pinza para hueso Lane.....	244	pinza para polipos Hartmann.....	412	pinza porta-esponja Maier-Gross.....	134
pinza para hueso Langenbeck.....	243	pinza para polipos Hartmann-Hoffmann.....	412	pinza porta-esponja Maier-Sims.....	134
pinza para hueso Lewin.....	246	pinza para polipos Hartmann-Wullstein.....	412	pinza porta-esponja Sims-Maier.....	134
pinza para hueso Patella.....	248	pinza para polipos Hoffmann-Hartmann.....	412	pinza sacabocado Citelli.....	430
pinza para hueso Reda.....	246	pinza para polipos laringeos Jurasz.....	471	pinza sacabocado craneal Cone.....	331
pinza para hueso Reill.....	248	pinza para polipos Littauer.....	425	pinza sacabocado craneal DeVilbiss.....	332
pinza para hueso Semb.....	243	pinza para polipos Noyes.....	425	pinza sacabocado Hajek-Kofler.....	431
pinza para hueso Ulrich.....	248	pinza para polipos Struempel.....	412	pinza sacabocado Kofler-Hajek.....	431
pinza para hueso Verbrugge.....	245	pinza para polipos uterinos Doyen.....	585	pinza sacabocado Ostroem.....	430
pinza para huesos.....	243-250	pinza para polipos uterinos Kelly.....	585	pinza sacabocado para discos intervertebral Colclough.....	344/1
pinza para huesos autocentrantes.....	245	pinza para polipos uterinos Noto.....	585	pinza sacabocado para discos intervertebral Ferris-Smith-Kerrison.....	344, 344/2
pinza para huesos Feldheim.....	249	pinza para polipos Wullstein-Hartmann.....	412	pinza sacabocado para discos intervertebral Kerrison-Ferris-Smith.....	344, 344/2
pinza para huesos Hoglund-Lowman.....	249	pinza para quitar agrafes Collin.....	224	pinza sacabocado para discos intervertebral Smith-Kerrison-Ferris.....	344, 344/2
pinza para huesos Lambert-Lowman.....	249	pinza para quitar agrafes Heath-Richter.....	224	pinza Smith.....	463
pinza para huesos Lowman.....	249	pinza para quitar agrafes Richter-Heath.....	224	pinza tira-lengua Collin.....	453
pinza para huesos Lowman-Hoglund.....	249	pinza para reduction.....	246	pinza tira-lengua Young.....	453
pinza para huesos Lowman-Lambert.....	249	pinza para reposicion Rowe.....	459	pinza Ultra-Ligera.....	95
pinza para huesos Meyer.....	248	pinza para secuestros.....	249	pinza uterina Adair.....	582
pinza para introducir cateter Magill.....	28	pinza para secuestros Van Buren.....	249	pinza uterina Barrett.....	582
pinza para iris Barraquer (Colibri).....	384	pinza para senoscopia.....	431	pinza uterina Braun.....	582
pinza para iris Barraquer-Katzin.....	384	pinza para separar la rama Smith.....	463	pinza uterina Czerny.....	584
pinza para iris Barraquer-Harman.....	386	pinza para shunt carotido Javid.....	511	pinza uterina Duplay.....	582
pinza para iris Colibri.....	384	pinza para sostener placas Lane.....	325	pinza uterina Hulka.....	583
pinza para iris Colibri (Barraquer).....	384	pinza para sostener tornillos Lane.....	325	pinza uterina Iowa.....	584
pinza para iris Colibri (Troutman).....	384	pinza para sutura Bonn Mod.....	386	pinza uterina Jacobs.....	583
pinza para iris Fischer.....	384	pinza para sutura Castroviejo.....	392	pinza uterina Jarcho.....	583
pinza para iris Foerster.....	383	pinza para sutura Mod. Bonn.....	386	pinza uterina Moore-Staude.....	582
pinza para iris Gill.....	384	pinza para sutura Moorfield.....	392	pinza uterina Museux.....	583
pinza para iris Gill-Hess.....	384	pinza para sutura St. Martin.....	392	pinza uterina Palmer-Pozzi.....	582
pinza para iris Graefe.....	382	pinza para sutura Tübingen Mod.....	386	pinza uterina Pozzi (Schroeder).....	582
pinza para iris Harman-Bishop.....	386	pinza para tabique nasal Graig.....	426	pinza uterina Pozzi-Palmer.....	582
pinza para iris Hess.....	384	pinza para tabique nasal Jansen-Middleton.....	430	pinza uterina Pratt.....	584
pinza para iris Hess-Gill.....	384	pinza para tabique nasal Middleton-Jansen.....	430	pinza uterina Schröder.....	584
pinza para iris Hess-Katzin-Barraquer.....	384	pinza para tapones.....	135, 471	pinza uterina Schroeder.....	583
pinza para iris Stevens.....	383	pinza para tapones Jackson.....	471	pinza uterina Schroeder (Pozzi).....	582
pinza para iris Troutman.....	389	pinza para tapones Ulrich.....	135	pinza uterina Skene.....	582
pinza para iris Troutman (Colibri).....	384	pinza para tejido Collin.....	539	pinza uterina Staude-Moore.....	582
pinza para la aorta DeBakey-Morris.....	506	pinza para tejido Duval.....	539	pinza uterina Teale.....	583
pinza para la aorta Dietrich.....	510	pinza para tejido Williams.....	539	pinza vascular Cooley.....	520
pinza para la aorta Miniature-Subramanian.....	521	pinza para tendones Larsen.....	292	pinza vascular Dardik.....	509/1
pinza para la aorta Morris-DeBakey.....	506	pinza para torcer hilo Berry.....	319	pinza vascular de uso multiple Bainbridge.....	495/1-495/2
pinza para la aorta Subramanian.....	521	pinza para torcer hilo Corwin-Hegar.....	319	pinza vascular de uso multiple Cooley.....	518-520, 520/2
pinza para la aorta Subramanian-Miniature.....	521	pinza para torcer hilo Haberisser-Mayo.....	319		
pinza para la aorta Weber.....	501	pinza para torcer hilo Hegar-Corwin.....	319		
pinza para la aorta Wylie.....	501/1, 501/2	pinza para torcer hilo Mayo-Haberisser.....	319		
pinza para laringe Fraenkel.....	471				

pinza vascular de uso multiple DeBaKey.....	495/2, 507, 508, 514, 515	pinza vascular Neonatal.....	523	pinza vascular para neontales Castaneda.....	527	pinza vascular pediátrica Cooley.....	522	pinza vascular pediátrica DeBaKey.....	516, 517	Piper forceps obstetrico.....	604	Pistola lavadora.....	626	placa para extender la piel.....	49	placa para parpado Jaeger.....	371	Plester cuchillo.....	418	Plester separador.....	171	Plester tubo de aspiracion.....	338	polipotomo Krause.....	433/2	polipotomo Krause-Voss.....	433/2	polipotomo Voss-Krause.....	433/2	polipotomo Wilde.....	433/2	Politzer aguja para paracentesis.....	408	Politzer cuchillo auricular.....	408	Politzer especulo auricular.....	399	Politzer oliva auricular.....	406	Poole tubo de aspiracion.....	27	porta aguja (micro) Barraquer.....	216, 217	porta aguja (micro) Barraquer-Troutmann.....	216	porta aguja (micro) Castroviejo-Standard.....	216	porta aguja (micro) Standard-Castroviejo.....	216	porta aguja (micro) Troutmann-Barraquer.....	216	porta aguja Adson.....	211	porta aguja Arruga.....	214	porta aguja Arruga-Kalt.....	214	porta aguja Baby-Olsen-Hegar.....	212	porta aguja Baumgartner.....	208	porta aguja Boomerang Young.....	220	porta aguja Boynton.....	214	porta aguja Bozemann.....	211	porta aguja Brown.....	209	porta aguja Castroviejo.....	215	porta aguja Castroviejo-Micro.....	215	porta aguja Collier.....	208	porta aguja Crile.....	213	porta aguja Crile-Murray.....	209	porta aguja Crile-Wood.....	209	porta aguja DeBaKey.....	210	porta aguja Derf.....	208	porta aguja Finocchio.....	211	porta aguja Gillies.....	212	porta aguja Halsey.....	208	porta aguja Heaney.....	210	porta aguja Hegar-Baby-Olsen.....	212	porta aguja Hegar-Mayo.....	209	porta aguja Hegar-Olsen.....	212	porta aguja Hoesel.....	213	porta aguja Jacobsen.....	215	porta aguja Johnson.....	211	porta aguja Kalt.....	214	porta aguja Kalt-Arruga.....	214	porta aguja Kilner.....	212	porta aguja Langenbeck.....	213	porta aguja Lichtenberg.....	213	porta aguja Masson.....	210	porta aguja Mathieu.....	213	porta aguja Mathieu-Olsen.....	212	porta aguja Mayo-Hegar.....	209	porta aguja Metzenbaum.....	211	porta aguja Micro-Castroviejo.....	215	porta aguja Microvascular.....	210	porta aguja Murray-Crile.....	209	porta aguja Neivert.....	208	porta aguja Olsen-Hegar.....	212	porta aguja Olsen-Hegar-Baby.....	212	porta aguja Olsen-Mathieu.....	212	porta aguja Ryder.....	210	porta aguja Sarot.....	211	porta aguja Stevens.....	214	porta aguja Stratte.....	212	porta aguja Wangenstein.....	210	porta aguja Webster.....	208	porta aguja Wood-Crile.....	209	porta aguja Young Boomerang.....	220	porta esponjas Foerster.....	136	porta esponjas Rampley.....	136	porta ligadura para tourniquet.....	528	porta pinza de traslado.....	615	porta-algodon.....	203	porta-algodon Farrell.....	203	porta-algodon Horne-Jobson.....	203	porta-algodon Jobson-Horne.....	203	porta-algodon Reda.....	203	porta-algodon Tobold.....	203	porta-algodon Uckermann.....	203	porta-clamps DeMartel-Wolfson.....	546	porta-clamps Wolfson-DeMartel.....	546	portador de luz fria Kleinsasser.....	36	portador de luz Holinger.....	37	portador de luz Jackson.....	37	Potts pinza para anastomosis.....	493	Potts pinza para coartacion.....	492	Potts-DeMartel tijera vascular.....	59	Potts-Smith pinza de diseccion.....	81, 81/1	Potts-Smith tijera vascular.....	61	Pozzi (Schroeder) pinza uterina.....	582	Pozzi-Palmer pinza uterina.....	582	Pratt dilatador uterino.....	580	Pratt especulo rectal.....	559	Pratt pinza hemostatica.....	110	Pratt pinza uterina.....	584	Pratt sonda para fistula.....	563	Precisa esfigmomanometro.....	9	Presameter-Nova esfigmomanometro.....	6	Presbyterian pinza cierra-tubo.....	129	Price-Thomas pinza bronquial.....	490	Prince pinza muscular.....	386	Prince tijera para amigdalas.....	59	protoscopio Bensaude.....	565	protoscopio Fansler.....	564	protoscopio Kelly.....	562, 563	protoscopio Morgan.....	565	protector Arruga.....	378	Providence-Hospital pinza hemostatica.....	106	punta de pinza Baracani.....	472	punta de pinza Bruenings.....	472	punta de pinza Cordes.....	472	punta de pinza Fraenkel.....	472	punta de pinza Krause.....	472	punta de pinza Lange.....	472	punta de pinza Scheimann.....	472	punta de pinza Schumacher.....	472	punta de pinza Seifert.....	472	Putti lima para huesos.....	294	Pynchon-Andrew tubo de aspiracion.....	28	Q	Quervain periototomo.....	275	Quincy tijera para encias.....	67	Quire elevador para cuerpos extraños.....	412	Quisling martillo.....	271	quistotomo Becker.....	375	quistotomo Graefe.....	375	quita hojas.....	42	R	Radolf pinza para arrancar uñas.....	297	Ragnell separador.....	140	Ragnell/Kilner tijera supercut.....	72	Ralk perforador de mano.....	300	Rampley porta esponjas.....	136	Ramus separador para el ramo.....	461	Randall cureta aspiradora para biopsia uterina.....	587	Randall pinza para calculos renales.....	535	Raney grapa para cuero cabelludo.....	327	Raney pinza aplicadora.....	327	Rankin-Crile pinza hemostatica.....	107	Rankin-DeBaKey pinza hemostatica atraumatica.....	512	Rankin-Kelly pinza hemostatica.....	106	raquiotomo.....	267	Ray cureta para hipofisis.....	334	Recamier cureta uterina.....	597	Reda cucharilla cortante.....	256	Reda cuchillo de hoz.....	435	Reda cuchillo para amputacion.....	44	Reda diapason.....	403	Reda especulo nasal.....	423	Reda Excenter tijera para vendaje.....	69/2	Reda gancho.....	150	Reda iman ocular.....	395	Reda instrumento para vendaje enyesado.....	232	Reda micro tijera.....	77, 80	Reda perforador de mano.....	300	Reda pinza atraumatica.....	111	Reda pinza autocentradora para sostener huesos.....	247	Reda pinza de reduction.....	247	Reda pinza depilatoria.....	395	Reda pinza para hueso.....	246	Reda pinza para parametrio.....	128/1	Reda porta-algodon.....	203	Reda rompe hojas.....	45	Reda sierra para abrir anillos.....	297	Reda sonda conductora.....	221/1	Redon aguja de guia.....	207	Rees tijera face lift.....	73	regla.....	25	Reichert depresor para epiglottis.....	471	Reill pinza para hueso.....	248	Reiner cuchillo para vendaje enyesado.....	233	Reiner jeringa auricular.....	406	Reinke-Lopez elevador para amigdalas.....	465	Resano pinza intestinal.....	542	Resano tijera para capsula.....	53/2	retractor nasal Aufricht.....	447	retractor nasal Cottle.....	447, 447/1	retractor nasal Kilner.....	447/1	retractor nasal Masing.....	447	retractor nasal Masing-Neivert.....	447	retractor nasal Neivert-Masing.....	447	retractor para amputacion Percy.....	296	Reverdin aguja.....	220	Reverdin separador abdominal.....	143/3	Reynolds tijera para cirugía.....	54/1	Reynolds tijera supercut.....	72	Ribbon espátula abdominal.....	143/1	Ricard separador abdominal.....	191	Richardson Grip separador.....	142	Richardson separador.....	142	Richardson-Eastman separador.....	142	Richnau-Holmgren especulo auricular.....	400	Richter-Heath pinza para quitar agrafes.....	224	Rienhoff-Finocchio separador costal.....	486	Rigby separador.....	189/2	Ri-Mini estuche de diagnostico.....	17	Ring baja-lengua.....	455	riñoneras.....	619	Ritter-Halle dilatador para el seno.....	433	Robb disecador vascular.....	530	Robb espátula para la intima.....	530	Roberts pinza hemostatica.....	117	Robson-Mayo pinza intestinal.....	541	Rochard separador abdominal.....	186	Rochester-Carmalt pinza hemostatica.....	109	Rochester-Ochsner pinza hemostatica.....	108
---	---------------------------	------------------------------	-----	--	-----	---------------------------------------	-----	--	----------	-------------------------------	-----	-----------------------	-----	----------------------------------	----	--------------------------------	-----	-----------------------	-----	------------------------	-----	---------------------------------	-----	------------------------	-------	-----------------------------	-------	-----------------------------	-------	-----------------------	-------	---------------------------------------	-----	----------------------------------	-----	----------------------------------	-----	-------------------------------	-----	-------------------------------	----	------------------------------------	----------	--	-----	---	-----	---	-----	--	-----	------------------------	-----	-------------------------	-----	------------------------------	-----	-----------------------------------	-----	------------------------------	-----	----------------------------------	-----	--------------------------	-----	---------------------------	-----	------------------------	-----	------------------------------	-----	------------------------------------	-----	--------------------------	-----	------------------------	-----	-------------------------------	-----	-----------------------------	-----	--------------------------	-----	-----------------------	-----	----------------------------	-----	--------------------------	-----	-------------------------	-----	-------------------------	-----	-----------------------------------	-----	-----------------------------	-----	------------------------------	-----	-------------------------	-----	---------------------------	-----	--------------------------	-----	-----------------------	-----	------------------------------	-----	-------------------------	-----	-----------------------------	-----	------------------------------	-----	-------------------------	-----	--------------------------	-----	--------------------------------	-----	-----------------------------	-----	-----------------------------	-----	------------------------------------	-----	--------------------------------	-----	-------------------------------	-----	--------------------------	-----	------------------------------	-----	-----------------------------------	-----	--------------------------------	-----	------------------------	-----	------------------------	-----	--------------------------	-----	--------------------------	-----	------------------------------	-----	--------------------------	-----	-----------------------------	-----	----------------------------------	-----	------------------------------	-----	-----------------------------	-----	-------------------------------------	-----	------------------------------	-----	--------------------	-----	----------------------------	-----	---------------------------------	-----	---------------------------------	-----	-------------------------	-----	---------------------------	-----	------------------------------	-----	------------------------------------	-----	------------------------------------	-----	---------------------------------------	----	-------------------------------	----	------------------------------	----	-----------------------------------	-----	----------------------------------	-----	-------------------------------------	----	-------------------------------------	----------	----------------------------------	----	--------------------------------------	-----	---------------------------------	-----	------------------------------	-----	----------------------------	-----	------------------------------	-----	--------------------------	-----	-------------------------------	-----	-------------------------------	---	---------------------------------------	---	-------------------------------------	-----	-----------------------------------	-----	----------------------------	-----	-----------------------------------	----	---------------------------	-----	--------------------------	-----	------------------------	----------	-------------------------	-----	-----------------------	-----	--	-----	------------------------------	-----	-------------------------------	-----	----------------------------	-----	------------------------------	-----	----------------------------	-----	---------------------------	-----	-------------------------------	-----	--------------------------------	-----	-----------------------------	-----	-----------------------------	-----	--	----	---	---------------------------	-----	--------------------------------	----	---	-----	------------------------	-----	------------------------	-----	------------------------	-----	------------------	----	---	--------------------------------------	-----	------------------------	-----	-------------------------------------	----	------------------------------	-----	-----------------------------	-----	-----------------------------------	-----	---	-----	--	-----	---------------------------------------	-----	-----------------------------	-----	-------------------------------------	-----	---	-----	-------------------------------------	-----	-----------------	-----	--------------------------------	-----	------------------------------	-----	-------------------------------	-----	---------------------------	-----	------------------------------------	----	--------------------	-----	--------------------------	-----	--	------	------------------	-----	-----------------------	-----	---	-----	------------------------	--------	------------------------------	-----	-----------------------------	-----	---	-----	------------------------------	-----	-----------------------------	-----	----------------------------	-----	---------------------------------	-------	-------------------------	-----	-----------------------	----	-------------------------------------	-----	----------------------------	-------	--------------------------	-----	----------------------------	----	------------	----	--	-----	-----------------------------	-----	--	-----	-------------------------------	-----	---	-----	------------------------------	-----	---------------------------------	------	-------------------------------	-----	-----------------------------	------------	-----------------------------	-------	-----------------------------	-----	-------------------------------------	-----	-------------------------------------	-----	--------------------------------------	-----	---------------------	-----	-----------------------------------	-------	-----------------------------------	------	-------------------------------	----	--------------------------------	-------	---------------------------------	-----	--------------------------------	-----	---------------------------	-----	-----------------------------------	-----	--	-----	--	-----	--	-----	----------------------	-------	-------------------------------------	----	-----------------------	-----	----------------	-----	--	-----	------------------------------	-----	-----------------------------------	-----	--------------------------------	-----	-----------------------------------	-----	----------------------------------	-----	--	-----	--	-----

Rochester-Pean pinza hemostatica.....	108	Schioetz tonometro.....	394/2	separador abdominal Rochard.....	186
Roeder pinza de campo.....	132	Schlesinger pinza cortante para laminectomia.....	342	separador abdominal Us-Balfour.....	184
Roger elevador para el tabique nasal.....	437	Schmeden pinza nasal.....	427	separador Adams-Mayo.....	171
Roger pinza traumatica.....	127	Schmid canula para lavador vascular.....	338	separador Adson.....	172-174
Rogge pinza para esterilizacion.....	227	Schmidt-Moritz baja-lengua.....	452	separador Adson Anderson.....	172
Rollet cincel para extirpacion.....	374	Schmieden sonda conductora.....	221	separador Adson-Beckmann.....	175
Rollet gancho.....	375	Schmieden-Dick aguja para ligadura.....	219	separador Alm.....	168
rompe hojas Castroviejo.....	45	Schmieden-Payr sonda conductora.....	221	separador Anderson.....	198
rompe hojas Chris-Troutman.....	45	Schmieden-Taylor tijera duramadre.....	65/1	separador Anderson Adson.....	172
rompe hojas Reda.....	45	Schmidt pinza para coger las amigdalas.....	467	separador Aufranc-Cobra.....	289
rompe hojas Troutman-Chris.....	45	Schoenborn separador para la glandula tiroidea.....	479	separador Baby Roux.....	140
Rose separador.....	140	Schröder cureta uterina.....	595	separador Beckmann.....	176
Rosen cuchillo.....	418	Schröder pinza uterina.....	584	separador Beckmann-Adson.....	175
Rosen gancho.....	419	Schroeder (Pozzi) pinza uterina.....	582	separador Beckmann-Eaton.....	176
Rosen tubo de aspiracion.....	338	Schroeder pinza uterina.....	583	separador Brunner.....	167
Roser-Koenig abre-boca.....	454	Schubert pinza para biopsia.....	588	separador Burrows-Jackson.....	189/2
Ross separador.....	148/1	Schuhknecht cuchillo.....	418	separador Caspar.....	179
Ross separador para aorta.....	148/1	Schultze salpingografo.....	596	separador Cloward.....	178/1-178/4
rotador Bechert.....	379	Schulze-Bergmann especulo rectal.....	560	separador Cobra-Aufranc.....	289
Roux Baby separador.....	140	Schumacher pinza para biopsia.....	588, 589	separador Collin.....	139
Roux mini separador.....	140	Schumacher punta de pinza.....	472	separador Collin-Hartmann.....	141
Roux separador.....	139	Schumacher tijera para cordon umbilical.....	64	separador Collins-Mayo.....	141
Rowe pinza para reposicion.....	459	Schumacher tijera para esternon.....	481	separador Contour-Scalp.....	169
Rubin cincel nasal.....	440	Schweigger pinza capsular.....	391	separador Cooley.....	148
Rubin pinza para magullar tabique.....	428	Scoville cucharilla cortante.....	253	separador Coronol Blow Lift.....	198
Rudd ligador para hemorroides.....	568	Scoville separador para la raiz de nervios.....	329/1, 330	separador Coryllos (Thorax).....	166
Rumel pinza hemostatica.....	117	Scoville separador para laminectomia.....	196	separador costal Burford-Finochietto.....	483
Rumel-Belmont tourniquet.....	528	Scoville-Haverfield separador para laminectomia.....	196	separador costal Cooley.....	485, 487
Rumel-DeBakey pinza para ligaduras.....	499	Scudder pinza intestinal.....	541	separador costal DeBoer.....	486
Ruskin pinza gubia.....	239	Sebileau periostotomo.....	275	separador costal Favalaro-Morse.....	484
Ruskin-Liston pinza cortante para huesos.....	241	Sedillot periostotomo.....	274, 275	separador costal Finochietto.....	482, 484
Ruskin-Stille pinza gubia.....	239	Segond bisturi para fibroma.....	594	separador costal Finochietto-Burford.....	483
Russel-Davis baja-lengua.....	458	Segond pinza para histerectomia.....	125	separador costal Finochietto-Rienhoff.....	486
Rydel-Seiffert diaposon.....	404	Segond-Landau pinza para histerectomia.....	125	separador costal Haight.....	487
Ryder porta aguja.....	210	Seifert punta de pinza.....	472	separador costal Morse.....	484
S		Seiffert-Rydel diaposon.....	404	separador costal Morse-Favaloro.....	484
Saalfeld saca comedones.....	608	Seldin periostotomo.....	277	separador costal Rienhoff-Finochietto.....	486
saca comedones Saalfeld.....	608	Sellheim separador obstetrico.....	607	separador costal Tuffier.....	487
saca comedones Schamberg.....	608	Sellors aproximador para costillas.....	489/1	separador Crile.....	140
saca comedones Unna.....	608	Sellors-Crafoord pinza hemostatica.....	119	separador cuello vejiga Millin.....	553
saca comedones Walton.....	608	Semb periostotomo.....	278	separador Cushing.....	151-153
Sachs elevador para duramadre.....	332	Semb pinza bronquial.....	491	separador Czerny.....	141
Sachs gancho para nervio.....	329	Semb pinza cortante para huesos.....	242	separador Doyen.....	178
Sauer pinza para aborto.....	606	Semb pinza gubia.....	240	separador Davidson (Scapula).....	166
salpingografo Schultze.....	596	Semb pinza para hueso.....	243	separador de mobilizacion Tessier.....	463/3
Sanvenero tijera para cirugia.....	54/1	Semb-DeBakey pinza para ligadura y la aorta.....	499	separador de pelvis St. Marks.....	165
Sarot pinza hemostatica.....	118	Semken pinza de diseccion.....	86	separador de sistema Leyla.....	368-368/3
Sarot porta aguja.....	211	Semm especulo vaginal.....	571	separador Deaver.....	145, 146
Satinsky pinza para vasos.....	491	Senn-Green separador.....	153	separador Deaver Grip.....	146
Satinsky tijera para vasija.....	65/2	Senn-Miller separador.....	143	separador DeBakey.....	189/1
Satinsky-DeBakey pinza para oclusion tangencial.....	502	sensimetro Wartenberg.....	25	separador Desmarres.....	151
Satterlee sierra para amputacion.....	296	separador abdominal Baby Balfour.....	182, 183	separador Doyen.....	163
Sauerbruch costotomo.....	481	separador abdominal Baby Gosset.....	181	separador Doyen-Stille.....	167
Sauerbruch pinza gubia.....	240	separador abdominal Back holder.....	192-195	separador Eastman-Richardson.....	142
Sauerbruch pinza para desechos.....	227	separador abdominal Balfour.....	182, 183	separador Eaton-Beckmann.....	176
Sauerbruch separador.....	164, 166	separador abdominal Balfour Baby.....	182, 183	separador espinal Taylor.....	291
Sauerbruch-Frey costotomo.....	481	separador abdominal Balfour-Us.....	184	separador Farabeuf.....	139
Sawtell pinza para coger las amigdalas.....	467	separador abdominal Browne-Denis.....	185	separador Finsen.....	168
Sawyer especulo rectal.....	560	separador abdominal Chamley.....	289	separador Freeman.....	198
Sayre elevador.....	281	separador abdominal Collin.....	190	separador Friedmann.....	477, 577
Scaglietti pinza gubia.....	240	separador abdominal Collin Loktite.....	191	separador Fritsch.....	163
Scalp-Contour separador.....	169	separador abdominal Denis-Browne.....	185	separador Gil-Vernet.....	152
Scapula (Davidson) separador.....	166	separador abdominal Doyen.....	189/1	separador Goelet.....	141
Schaedel pinza de campo.....	132	separador abdominal Frazier.....	181	separador Green.....	160
Schamberg saca comedones.....	608	separador abdominal Gosset.....	181	separador Green-Langenbeck.....	153
Schede cucharilla cortante.....	251	separador abdominal Gosset Baby.....	181	separador Green-Senn.....	153
Scheidel-Hepp micro tijera.....	78	separador abdominal Kirschner.....	185-187/1	separador Grip Deaver.....	146
Scheie cuchillo para goniotomia.....	373	separador abdominal Kummel.....	143/4	separador Grip Kelly.....	142
Scheinmann punta de pinza.....	472	separador abdominal Loktite Collin.....	191	separador Grip Richardson.....	142
Scherbak especulo vaginal.....	575	separador abdominal O'Connor-O'Sullivan.....	181	separador Harrington.....	147
Schimmelbusch tambores para esterilizacion.....	622	separador abdominal O'Sullivan-O'Connor.....	181	separador Harrington-Pemberton.....	147
Schink dermatomo.....	49	separador abdominal Reverdin.....	143/3	separador Hartmann-Collin.....	141
		separador abdominal Ricard.....	191	separador Hasson.....	143

separador Heaney.....	164	separador para rodilla Blount.....	289	sierra nasal Joseph.....	446
separador Henley.....	170	separador para tejido cervical Cloward.....	339	sierra oscilante con aspiracion.....	231-231/1
separador Hibbs.....	164	separador para tendones Bunell.....	292	sierra oscilante para vendajes enyesados.....	230/10-230/18
separador Holzheimer.....	168	separador para uvula Love.....	465	sierra para abrir anillos Reda.....	297
separador Hösel.....	167	separador para yesos Beeson.....	232	sierra para abrir anillos Walton.....	297
separador intestinal Leriche.....	143/4	separador para yesos Haglund-Stille.....	232	sierra para amputacion Bier.....	296
separador intra oral.....	463/1, 463/4	separador para yesos Henning.....	232	sierra para amputacion Charriere.....	296
separador intra oral L&M.....	463/4	separador para yesos Stille-Haglund.....	232	sierra para amputacion Langenbeck.....	296
separador Israel.....	162	separador Parker.....	139	sierra para amputacion Satterlee.....	296
separador Jackson-Burrows.....	189/2	separador Parker-Langenbeck / Us Army.....	141	sierra para autopsia.....	230-230/9
separador Jansen.....	168	separador Pemberton-Harrington.....	147	sierra para vendajes enyesados Engel.....	229
separador Joll.....	477, 577	separador perineal Gelpi.....	189/1, 189/2	sileta.....	621/1
separador Kelly.....	142, 164	separador Perkins.....	168	Silver cincel nasal.....	442
separador Kelly Grip.....	142	separador Plester.....	171	Silver dermatomo.....	50
separador Kocher.....	155	separador prostatico Young.....	550	Simcoe canula.....	394/2
separador Kocher.....	159, 160, 163	separador Ragnell.....	140	Simon cucharilla uterina.....	594
separador Kocher-Langenbeck.....	159	separador rectal Buie-Smith.....	561	Simon separador.....	164
separador Koerte.....	162	separador rectal Smith-Buie.....	561	Simplex cierra-tubos.....	624
separador König.....	153	separador Richardson.....	142	Simpson forceps obstetrico.....	602
separador Körte.....	143/3	separador Richardson Grip.....	142	Simpson-Braun forceps obstetrico.....	602
separador Lahey.....	157	separador Richardson-Eastman.....	142	Simpson-Luikart forceps obstetrico.....	603
separador Langenbeck.....	158, 159	separador Rigby.....	189/2	Sims cureta uterina.....	597
separador Langenbeck-Green.....	153	separador Rose.....	140	Sims depresor uterino.....	586
separador Langenbeck-Kocher.....	159	separador Ross.....	148/1	Sims dilatador uterino.....	581
separador Little.....	157	separador Roux.....	139	Sims especulo rectal.....	559
separador Luer.....	140	separador Roux Baby.....	140	Sims especulo vaginal.....	573
separador mamarío Breast.....	198	separador Roux mini.....	140	Sims histerometro.....	586
separador manipulador Obwegeser.....	461/1	separador sagital Smith.....	463/5	Sims tijera ginecologica.....	62
separador Martin.....	175/1	separador Sauerbruch.....	164, 166	Sims-Maier pinza porta-esponja.....	134
separador Mathieu.....	141	separador Scalp-Contour.....	169	Singley pinza de diseccion.....	88
separador Mayo-Adams.....	171	separador Scapula (Davidson).....	166	Sinsky gancho.....	376
separador Mayo-Collins.....	141	separador Senn-Green.....	153	Sinus (Lister) pinza porta esponja.....	137
separador Meyerding.....	157, 177, 180	separador Senn-Miller.....	143	Sinus sonda para sinoscopia.....	438
separador Middeldorf.....	160	separador Simon.....	164	sistema de brazo.....	188, 189
separador Mikulicz.....	163	separador Stille-Doyen.....	167	Skene pinza uterina.....	582
separador Miller-Senn.....	143	separador Stille-Strandell.....	157	Sluder-Ballenger amigdalotomo.....	470
separador Mini Roux.....	140	separador Strandell-Stille.....	157	Smellie gancho obstetrico.....	605
separador Mollison.....	171	separador Thorax (Coryllos).....	166	Smellie perforacraneo.....	607
separador Morris.....	164	separador toracico Mercedes.....	489	Smillie meniscotomo.....	292
separador Murphy.....	156	separador traqueal Bose.....	476	Smillie separador para menisco.....	291
separador nasal Converse.....	448	separador traqueal Jackson.....	476	Smith bifeleostato.....	370
separador Norfolk / Norwich.....	172	separador Travers.....	172	Smith pinza.....	463
separador Norfolk / Norfolk.....	172	separador Tuffier.....	147	Smith pinza para separar la rama.....	463
separador obstetrico Sellheim.....	607	separador Us Army / Parker-Langenbeck.....	141	Smith separador sagital.....	463/5
separador Ollier.....	162	separador Vernet-Gil.....	152	Smith Us Army tijera para gaza.....	69/1
separador para aorta Ross.....	148/1	separador vesical Judd-Masson.....	552	Smith-Buie separador rectal.....	561
separador para cirugia plastica Ferriera.....	197	separador vesical Legueu.....	553	Smith-Ferris pinza cortante para laminectomia.....	343
separador para cirugia plastica Tebbetts.....	197	separador vesical Masson-Judd.....	552	Smith-Ferris pinza de diseccion.....	85
separador para cuerpo vertebral Cloward.....	339	separador vesical Millin.....	552	Smith-Heywood pinza hemorroidal.....	567
separador para cuerpo vertebral Inge.....	339	separador vesical Thomson-Walker.....	552	Smith-Kerrison-Ferris pinza sacabocado para	
separador para el borde anterior Hargis.....	463	separador vesical Walker-Thomson.....	552	discos intervertebral.....	344, 344/2
separador para el cuerpo mandibular Hargis.....	463/6	separador Volkman.....	153-156	Smith-Petersen cincel.....	261
separador para el ramo Nasalis-Spina.....	461	separador Weitlaner.....	169	Smith-Petersen gubia.....	261
separador para el ramo Ramus.....	461	separador Weitlaner-Wullstein.....	169	Smith-Petersen pinza gubia.....	238
separador para el ramo Spina-Nasalis.....	461	separador Wullstein.....	171	Smith-Potts pinza de diseccion.....	81, 81/2
separador para la glandula tiroidea Schoenborn.....	479	separador Wullstein-Weitlaner.....	169	Smith-Potts tijera vascular.....	61
separador para la raiz de nervios D'Errico.....	329/2	separador Yancoskie.....	198	Smithwick gancho para nervio.....	329
separador para la raiz de nervios Hess.....	329/1	separador Zenker.....	161	Smithwick pinza aplicadora.....	326
separador para la raiz de nervios Holsher.....	329/1	Serpentine Grasper pinza para biopsia.....	593	Snellen asa.....	378
separador para la raiz de nervios Love.....	329/2, 330	serra-fina Dieffenbach.....	104	Snellen pinza muscular.....	393
separador para la raiz de nervios Scoville.....	329/1, 330	serra-fina Hopkins-Johns.....	104	Socket and Ball pinza para campo.....	133
separador para labios y mejillas.....	453	serra-fina Johns-Hopkins.....	104	Somer pinza para el utero.....	585
separador para labios y mejillas Sternberg.....	453	Seutin tijera para vendaje.....	69/2	sonda abotonada Jacobson.....	335
separador para laminectomia Cherry.....	488	Sexton cuchillo auricular.....	408	sonda acanalada.....	199
separador para laminectomia Haverfield-Scoville.....	196	Shambaugh gancho.....	419	sonda acanalada Brodie.....	199
separador para laminectomia Scoville.....	196	Shapleigh asa.....	410	sonda auricular Stacke.....	199
separador para laminectomia Scoville-Haverfield.....	196	Shea tijera auricular micro.....	413	sonda conductora Brunner.....	221, 221/1
separador para mamaria.....	486/1	Sheehan cincel nasal.....	441	sonda conductora Kirschner.....	221
separador para menisco Smillie.....	291	Sheets canula.....	394/2	sonda conductora Koenig.....	221/1
separador para paladar Nager.....	465	Sherman-Stille perforador de mano.....	298	sonda conductora Payr.....	221/1
separador para partes blandas Obwegeser.....	460	Siebold tijera ginecologica.....	62	sonda conductora Payr-Schmieden.....	221
separador para pilar Hofer.....	465	Siegle especulo auricular.....	402	sonda conductora Reda.....	221/1
separador para piloro Benson.....	544	sierra hilo Olivecrona.....	332	sonda conductora Schmieden.....	221

sonda conductora Schmieden-Payr.....	221	Strauss pinza para el pene.....	553/1	tijera de diseccion Weller.....	53/2
sonda conductora Vienna.....	221/1	Struempel pinza para polipos.....	412	tijera de incision.....	52
sonda Fish.....	199	Strully tijera para neurocirugia.....	65	tijera DeBakey.....	60
sonda Harms.....	381	Struycken pinza nasal.....	427	tijera duramadre Schmieden-Taylor.....	65/1
sonda lacrimal Bowman.....	381	Subramanian pinza para la aorta.....	521	tijera duramadre Taylor-Schmieden.....	65/1
sonda lacrimal Worst.....	381	Subramanian-Miniature pinza para la aorta.....	521	tijera Enucleation.....	58
sonda metalica Walther.....	555	supercut tijera.....	71, 72	tijera face lift Freeman.....	73
sonda Nelaton.....	199	supercut tijera Baby Metzenbaum.....	71	tijera face lift Gorney.....	73
sonda para bocio Kocher.....	479	supercut tijera Iris.....	72	tijera face lift Joseph Peck.....	73
sonda para calculos biliares Mayo.....	534	supercut tijera Kilner/Ragnell.....	72	tijera face lift Kaye.....	73
sonda para fistula Lockhart-Mummary.....	200	supercut tijera La Grange.....	72	tijera face lift Peck Joseph.....	73
sonda para fistula Mummary-Lockhart.....	200	supercut tijera Lister.....	72	tijera face lift Rees.....	73
sonda para fistula Pratt.....	563	supercut tijera Mayo.....	71	tijera ginecologica Doyen.....	63
sonda para mesurar House.....	420	supercut tijera Mayo-Stille.....	71	tijera ginecologica Dubois.....	63
sonda para sinoscopia Sinus.....	438	supercut tijera Metzenbaum.....	71	tijera ginecologica Siebold.....	62
soporte de esterilizacion para alambres de Kirschner.....	305	supercut tijera Metzenbaum Baby.....	71	tijera ginecologica Sims.....	62
soporte de pecho Negus.....	459	supercut tijera Ragnell/Kilner.....	72	tijera ginecologica Wertheim.....	63
soporte pectoral Kleinsasser.....	36	supercut tijera Reynolds.....	72	tijera Martin-Cartilage.....	65/1
Spencer tijera para ligadura.....	66	supercut tijera Stevens.....	72	tijera nasal.....	428, 429
Spencer-Wells pinza hemostatica.....	109	supercut tijera Stille-Mayo.....	71	tijera nasal Cottle.....	59
Spinal cucharilla cortante.....	253	supercut tijera wagner.....	72	tijera nasal Fomon.....	58
Spina-Nasalis separador para el ramo.....	461	Sweet pinza aplicadora.....	326	tijera nasal Heymann.....	58
Spratt cucharilla cortante.....	251	Systrunk tijera para cirugia.....	66	tijera nasal Watson-Williams.....	428
Spurling pinza cortante para laminectomia.....	340			tijera nasal Williams-Watson.....	428
St. Marks separador de pelvis.....	165	T		tijera Northbent.....	66
St. Martin pinza para sutura.....	392	Tabb cuchillo.....	418	tijera para alambre y laminas Universal.....	67
St. Clair-Thomson cuchillo para vegetaciones adenoides.....	450	Takahashi pinza nasal.....	427	tijera para amigdalas.....	59
Stacke sonda auricular.....	199	taladros.....	302	tijera para amigdalas Boettcher.....	59
Stamm pinza cortante para huesos.....	241	tambores para esterilizacion Schimmelbusch.....	622	tijera para amigdalas Dean.....	59
Standard (Nelson) trocar abdominal.....	204	tamponeador LUniatschek.....	465	tijera para amigdalas Good.....	59
Standard estuche para sutura.....	226	Tarnier cranioclasto.....	607	tijera para capsula Pesano.....	53/2
Standard pinza de diseccion.....	81, 81/1	Tarnier forceps obstetrico.....	604	tijera para cartilago McIndoe.....	65/1
Standard tijera para cirugia.....	51	tarros.....	620	tijera para cirugia Cottle.....	56
Staude-Moore pinza uterina.....	582	Taylor martillo de percusion.....	24	tijera para cirugia Graeffe.....	56
Steinmann alambre.....	307, 308	Taylor pinza de diseccion.....	87	tijera para cirugia Iris.....	54/2
Steinmann pinza de agarre para tendones.....	292	Taylor separador espinal.....	291	tijera para cirugia Joseph.....	54/1
Stellbrink pinza gubia.....	234	Taylor-Cushing pinza de diseccion.....	87	tijera para cirugia Kilner.....	54/1
Sternberg separador para labios y mejillas.....	453	Taylor-Schmieden tijera duramadre.....	65/1	tijera para cirugia Knapp.....	55
Stevens gancho para cristalino.....	375	Teale pinza uterina.....	583	tijera para cirugia Littler.....	55
Stevens pinza para iris.....	383	Tebbetts separador para cirugia plastica.....	197	tijera para cirugia Metzenbaum.....	54
Stevens porta aguja.....	214	tensor de cierra-hilo Demel.....	315	tijera para cirugia Reynolds.....	54/1
Stevens tijera para tenotomia.....	58	tensor de cierra-hilo Loute.....	315	tijera para cirugia Sanvenero.....	54/1
Stevens tijera supercut.....	72	tensor de taladros.....	313	tijera para cirugia Standard.....	51
Stevenson blearostato.....	371	Terson pinza capsular.....	391	tijera para cirugia Systrunk.....	66
Stieglitz pinza para espinas.....	92	Tessier separador de mobilizacion.....	463/3	tijera para cirugia Waldmann.....	64
Stille (Leksell) pinza gubia.....	240	Thierry forceps obstetricos.....	603	tijera para cordon umbilical Busch.....	64
Stille cincel.....	260	Thomas cureta uterina.....	599	tijera para cordon umbilical Mod. USA.....	64
Stille cizalla para yesos.....	229	Thomas-Gaylor pinza para biopsia.....	588	tijera para cordon umbilical Schuhmacher.....	64
Stille costotomo.....	480	Thomas-Price pinza bronquial.....	490	tijera para cordon umbilical USA Mod.....	64
Stille gubia.....	260	Thoms-Allis pinza intestinal.....	538	tijera para corneales Castroviejo.....	79
Stille osteotomo.....	260	Thomson-St. Clair cuchillo para vegetaciones adenoides.....	450	tijera para encias Fox-Goldman.....	67
Stille perforador de mano.....	298	Thomson-Walker separador vesical.....	552	tijera para encias Goldman-Fox.....	67
Stille pinza de diseccion.....	81, 81/1	Thorax (Coryllos) separador.....	166	tijera para encias LaGrange.....	69
Stille pinza hemostatica.....	122	Thorex tijera vesicula biliar.....	65/2	tijera para encias Locklin.....	69
Stille-Barraya pinza de diseccion.....	88	Thudichum especulo nasal.....	421	tijera para encias Quinby.....	67
Stille-Giertz costotomo.....	481	Tieck-Halle especulo nasal.....	423	tijera para enterotomo.....	66
Stille-Haglund separador para yesos.....	232	tijera Adson-Tonnies.....	65	tijera para episiotomia Braun-Stadler.....	64
Stille-Horsley pinza cortante para huesos.....	242	tijera auricular micro Bellucci.....	413, 417	tijera para episiotomia Stadler-Braun.....	64
Stille-Liston pinza cortante para huesos.....	242	tijera auricular micro Shea.....	413	tijera para esternon Schumacher.....	481
Stille-Luer pinza gubia.....	239	tijera Cartilage-Martin.....	65/1	tijera para gaza Smith Us Army.....	69/1
Stille-Mayo tijera de diseccion.....	52/1	tijera corneal Aebli.....	58	tijera para gaza US Army Smith.....	69/1
Stille-Mayo tijera supercut.....	71	tijera cuticular.....	610	tijera para intestino Fergusson.....	66
Stille-Ruskin pinza gubia.....	239	tijera de diseccion Baby Lexer.....	53	tijera para iridectomia Castroviejo.....	79
Stille-Sherman perforador de mano.....	298	tijera de diseccion Deaver.....	52	tijera para iridectomia Vannas.....	79
Stille-Strandell separador.....	157	tijera de diseccion Jorgensen.....	53	tijera para iris Noyes.....	75
Stockmann pinza para el pene.....	553/1	tijera de diseccion Lexer.....	53	tijera para iris Wecker.....	75
Stone pinza para cerrar clamps.....	545	tijera de diseccion Lexner.....	53	tijera para ligadura Heath.....	66
Stone-Watt manguito de cierre.....	545	tijera de diseccion Mayo.....	52/1	tijera para ligadura Littauer.....	66
Stone-Watt pinza intestinal.....	545	tijera de diseccion Mayo-Noble.....	52/1	tijera para ligadura Spencer.....	66
Strabismus tijera.....	58	tijera de diseccion Mayo-Stille.....	52/1	tijera para ligaduras Waucut.....	54
Strandell-Stille separador.....	157	tijera de diseccion Metzenbaum.....	53/1	tijera para neurocirugia.....	65
Strassburger pinza de diseccion.....	89	tijera de diseccion Noble-Mayo.....	52/1	tijera para neurocirugia Strully.....	65
Stratte porta aguja.....	212	tijera de diseccion Stille-Mayo.....	52/1	tijera para oftalmologia.....	57, 75, 79

tijera para oftalmología Barraquer Colibri.....	75	Townsend-Down-Mini pinza para biopsia.....	591	uretrotomo Otis	553
tijera para oftalmología Colibri Barraquer.....	75	Townsend-Up-Mini pinza para biopsia.....	591	Us Army / Parker-Langenbeck separador.....	141
tijera para oftalmología Gradle.....	57	Toybee especulo auricular.....	399	Us Army Smith tijera para gaza.....	69/1
tijera para parametrium.....	63	tractor Barton.....	603/2	USA Mod. tijera para cordón umbilical.....	64
tijera para preparación.....	65	tractor Bill.....	604	USA pinza de disección.....	81, 81/1
tijera para rinoplastia Fomon.....	65/1	tractor Bill-Luikart.....	604		
tijera para septo Killian.....	471	tractor Luikart-Bill.....	604	V	
tijera para tendón Westcott.....	75	transformador para mango de pila para laringoscopio.....	34	V. Petz aparato para suturar estómago y intestinos.....	549
tijera para tenotomía Stevens.....	58	Travers separador.....	172	vaina para tornillos.....	324
tijera para uñas.....	609, 614	treфина para aorta.....	528	Valleix histerometro.....	586
tijera para vasija Klinkenbergh-Loth.....	65/2	Trelat especulo vaginal.....	571	Van Buren buja dilatadora.....	554
tijera para vasija Loth-Klinkenbergh.....	65/2	trepano Keyes.....	608	Van Buren pinza para secuestros.....	249
tijera para vendaje.....	69/1, 69/2, 70	Tréthowan Lane elevador.....	290	Van Doren pinza para biopsia.....	588
tijera para vendaje Bergmann.....	69/1	trocar abdominal Nelson (Standard).....	204	Vannas tijera para iridectomía.....	79
tijera para vendaje Bruns.....	70	trocar abdominal Standard (Nelson).....	204	Varady instrumento para varices.....	202
tijera para vendaje Esmarch.....	69/2	trocar Douglas.....	204	vasos graduados.....	621
tijera para vendaje Excenter Reda.....	69/2	trocar Nelson.....	205	vendaje de compresión Esmarch.....	296
tijera para vendaje Knowles.....	70	trocar Ochsner.....	205	Verbrugge pinza para hueso.....	245
tijera para vendaje Lister.....	69/1	trocar para seno maxilar Coakley.....	204	Verbrugge-Müller elevador.....	286/2
tijera para vendaje Lorenz.....	70	trocar para seno maxilar Lichtwitz.....	204	Vernet-Gil separador.....	152
tijera para vendaje Reda Excenter.....	69/2	trocar para seno maxilar Pierce.....	204	Verres aguja para neumoperitoneo.....	206
tijera para vendaje Seutin.....	69/2	trocar Universal.....	204	Vienna especulo nasal.....	421
tijera para vendaje Universal.....	70	Troeltsch (Wilde) pinza auricular.....	410	Vienna Mod. especulo nasal.....	421
tijera para vesícula biliar Thorek.....	65/2	Troeltsch pinza nasal.....	424	Vienna sonda conductora.....	221/1
tijera pulmonares Crafoord.....	65/2	Troemner martillo de percusión.....	24	Virchow cuchillo para autopsia.....	48
tijera Strabismus.....	58	Trousseau-Baby dilatador traqueal.....	476	Virchow cuchillo para cerebro.....	48
tijera supercut.....	71, 72	Troutman (Colibrí) pinza para iris.....	384	Volkmann cucharilla cortante.....	251, 257
tijera supercut Baby Metzenbaum.....	71	Troutman pinza para iris.....	389	Volkmann separador.....	153-156
tijera supercut Iris.....	72	Tübingen Mod. pinza para ligadura.....	392	Voltolini especulo nasal.....	421
tijera supercut Kilner/Ragnell.....	72	Tübingen Mod. pinza para sutura.....	386	Voss-Krause polipotomo.....	433/2
tijera supercut La Grange.....	72	Tübingen pinza para ligadura.....	392	Vu-More especulo vaginal.....	569
tijera supercut Lister.....	72	Tübingen pinza para sutura.....	386		
tijera supercut Mayo.....	71	tubo de aspiración.....	27, 28, 337, 337/2, 338	W	
tijera supercut Mayo-Stille.....	71	tubo de aspiración Adson.....	337	Wachenfeldt pinza para aplicar agujas.....	224
tijera supercut Metzenbaum.....	71	tubo de aspiración Andrew-Pynchon.....	28	Wadsworth-Todd cauterio.....	378
tijera supercut Ragnell/Kilner.....	72	tubo de aspiración Baby-Yankauer.....	27	Wagener gancho abotonado.....	409
tijera supercut Reynolds.....	72	tubo de aspiración Ferguson.....	337	Wagener-Mosher canula para traqueotomía.....	477
tijera supercut Stevens.....	72	tubo de aspiración Ferguson/Frazier.....	337	Wagner pinza cortante para laminectomía.....	343
tijera supercut Stille-Mayo.....	71	tubo de aspiración Frazier/Ferguson.....	337	Wagner tijera.....	67
tijera supercut Wagner.....	72	tubo de aspiración House.....	337/2	Wagner tijera supercut.....	72
tijera Toennis-Adson.....	65	tubo de aspiración Plester.....	338	Waldmann tijera para cirugía.....	64
tijera vascular.....	59-61	tubo de aspiración Poole.....	27	Walker-Thomson separador vesical.....	552
tijera vascular DeBakey.....	61	tubo de aspiración Pynchon-Andrew.....	28	Wallich cucharilla para aborto.....	607
tijera vascular DeMartel-Potts.....	59	tubo de aspiración Rosen.....	338	Walsham pinza para enderezar el tabique nasal.....	449
tijera vascular Dietrich.....	60	tubo de aspiración Yankauer.....	27	Walther cateter.....	555
tijera vascular Favalaro.....	61	tubo de aspiración Yankauer-Baby.....	27	Walther sonda metálica.....	555
tijera vascular Kelly.....	61	tubo de aspiración Yankauer-Baby.....	27	Walton gubia para cuerpos extraños.....	374
tijera vascular Potts-DeMartel.....	59	tubo de aspiración Yasargil.....	337/1	Walton saca comedones.....	608
tijera vascular Potts-Smith.....	61	tubo de extensión Bruenings.....	472	Walton serra para abrir anillos.....	297
tijera vascular Smith-Potts.....	61	Tucker-Luikart-McLean forceps obstétrico.....	603/1	Wangensteen pinza de disección.....	89
tijera vasija Satinsky.....	65/2	Tuffier pinza hemostática.....	110	Wangensteen porta aguja.....	210
tijera Wagner.....	67	Tuffier separador.....	147	Wartenberg sensímetro.....	25
Tilley pinza auricular.....	411	Tuffier separador costal.....	487	Watson dermatomo.....	50
tirabuzón para fibroma Doyen.....	594	Turnbull alicata para cortar uñas.....	609	Watson-Cheyne disecador.....	199
Tischler-Down pinza para biopsia.....	591	Turrel pinza para biopsia rectal.....	567	Watson-Cheyne elevador.....	283
Tischler-Kevorkian pinza para biopsia.....	592	Tyding amigdalotomo.....	469	Watson-Williams pinza nasal.....	428
Tischler-Morgan pinza para biopsia.....	590, 591	Tyding pinza para coger amígdalas.....	468	Watt-Stone manguito de cierre.....	545
Tischler-Up pinza para biopsia.....	591			Watt-Stone pinza intestinal.....	545
Tobold baja-lengua.....	453	U		Waugh pinza de disección.....	83
Tobold porta-algodón.....	203	U.S. Kirschner estribo para extensión.....	312	Wavecuc tijera para ligaduras.....	54
Todd-Wadsworth cauterio.....	378	Uckermann porta-algodón.....	203	Weber asa.....	378
Toennis elevador para duramadre.....	332	Ulrich pinza para hueso.....	248	Weber pinza para la aorta.....	501
Toennis pinza hemostática.....	117	Ulrich pinza para tapones.....	135	Webster porta aguja.....	208
Toennis-Adson tijera.....	65	Uni I estuche de diagnóstico / otoscopio.....	13	Wecker espátula para iris.....	378
Toennis-Olivcrona pinza aplicadora.....	326	Uni II estuche de diagnóstico/ oftalmoscopio May.....	14	Wecker tijera para iris.....	75
Tohoku pinza de campo.....	132	Uni III estuche de diagnóstico.....	15	Week blefarostato.....	370
tonómetro Schioetz.....	394/2	Universal pinza para esterilización.....	227	Weil-Blakesley pinza nasal.....	426
Took cuchillo corneal.....	373	Universal tijera para alambre y láminas.....	67	Weiss-Dupuy aguja para sutura amígdalas.....	466
torniquete pneumático.....	295	Universal tijera para vendaje.....	70	Weitlaner separador.....	169
tourniquete Belmont-Rumel.....	528	Universal trocar.....	204	Weitlaner-Wullstein separador.....	169
tourniquete Rumel-Belmont.....	528	Unna saca comedones.....	608	Weller tijera de disección.....	53/2
Townley calibre.....	26	Up-Mini-Townsend pinza para biopsia.....	591	Wells espátula para enucleación.....	378
Townsend pinza para biopsia.....	591	Up-Tischler pinza para biopsia.....	591	Wells-Spencer pinza hemostática.....	109

Wertheim pinza para histerectomia.....	124, 128	Zielke gubia	264
Wertheim tijera ginecologica	63		
Wertheim-Cullen pinza para histerectomia	125		
West cincel nasal	442/1		
Westcott tijera para tendon	75		
Westmacott pinza nasal	424		
Wheeler cuchillo para discision	373		
Wheeler espátula para ciclodialisis	379		
White pinza para coger amígdalas.....	467		
Wieder baja-lengua	452		
Wiener escofina nasal	443		
Wiener gancho para iris	375		
Wigmore cuchillo para vendajes enyesados.....	229		
Wikstroem pinza hemostatica	117		
Wilde (Troeltsch) pinza auricular.....	410		
Wilde cierra-nudo auricular	411		
Wilde polipotomo	433/2		
Wilder asa	378		
Wilder dilatador lacrimal.....	381		
Williams destornillador	323		
Willet Martel pinza hemostatica	110		
Williams blefarostato	370		
Williams pinza para tejido	539		
Williams-Watson pinza nasal.....	428		
Williger cucharilla cortante.....	255, 257		
Williger martillo	271		
Williger periestotomo	276		
Winter pinza para aborto.....	606		
Wittner pinza para biopsia	589		
Wolff pinza para arrancar vendaje enyesado	233		
Wolfson-DeMartel pinza para anastomosis	546		
Wolfson-DeMartel pinza para cerrar clamps	546		
Wolfson-DeMartel porta-clamps	546		
Wood-Crile porta aguja	209		
Woodson elevador para duramadre.....	333		
Worst sonda lacrimal.....	381		
Wrigley forceps obstetrico	602		
Wulstein cuchillo.....	418		
Wulstein mango de aspiracion	338		
Wulstein pinza auricular micro	416		
Wulstein separador.....	171		
Wulstein-Hartmann pinza para polipos	412		
Wulstein-Weitlaner separador	169		
Wylie dilatador uterino.....	581		
Wylie pinza para la aorta	501/1, 501/2		
Y			
Yancoskie separador.....	198		
Yankauer elevador para amígdalas	465		
Yankauer tubo de aspiracion	27		
Yankauer-Baby tubo de aspiracion	27		
Yasargil clips para aneurisma	345-356		
Yasargil gancho para galea	330		
Yasargil pinza para tumores	97		
Yasargil tubo de aspiracion.....	337/1		
Yeoman cierra-nudo rectal	566		
Yeoman pinza para biopsia rectal	566, 567		
Young Boomerang aguja	220		
Young Boomerang porta aguja	220		
Young pinza de agarre para prostata.....	550		
Young pinza tira-lengua.....	453		
Young separador prostático.....	550		
Z			
Zaufal elevador auricular	409		
Zaufal-Jansen elevador auricular	409		
Zaufal-Jansen pinza gubia.....	238		
Zenker pinza hemostatica	118		
Zenker separador	161		
Ziegler blefarostato.....	371		
Ziegler cuchillo para discision.....	373		
Ziegler cuchillo para iris	372		
Ziegler dilatador lacrimal	381		

ADENOTOMO LA FORCE.....	450	AGO, KOENIG.....	223	AXENFELD CURETTA DA CALAZIO.....	377
AGRAFES, MICHEL.....	224	AGO, REVERDIN.....	220	AYER PINZA PER CALAZIO.....	393
ABBASSALINGUA.....	451	AGO, ROSEN.....	419		
ABBASSALINGUA DAVIS-BOYLE.....	455	AGO, YOUNG-BOOMERANG.....	220	B	
ABBASSALINGUA DOUGHTY.....	458	ALAN-PARKS DIVARICATORE ANALE.....	561	BABCOCK PINZA PER AFFERRARE INTESTINI.....	539
ABBASSALINGUA RUSSEL-DAVIS.....	458	ALDERDYCE ELEVATORE.....	282	BABINSKI MARTELLO DA PERCUSSIONE.....	24
ABBASSALINGUA, ANDREW.....	452	ALESATORE PER FEMORE, KUENTSCHER.....	321	BABY BURKE PINZA PER BIOPSIA.....	590
ABBASSALINGUA, BRUENINGS.....	451	ALESATORE PER L'APERTURA DEL MIDOLLO, KUENTSCHER.....	321	BABY GOSSET DIVARICATORE ADDOMINALE.....	181
ABBASSALINGUA, BUCHWALD.....	451	ALEXANDER PERIOTOTOMO.....	276	BABY METZENBAUM SUPERCUT FORBICI.....	71
ABBASSALINGUA, DINGMANN.....	456	ALEXANDER PINZA PER BIOPSIA.....	589	BABY TISCHLER PINZA PER BIOPSIA.....	592
ABBASSALINGUA, FRENZEL.....	451	ALEXANDER SCALPELLO.....	259	BABY WEBSTER PORT'AGHI.....	208
ABBASSALINGUA, HARTMANN.....	452	ALEXANDER SGORBIA.....	259	BABY YANKAUER CANNULA D'ASPIRAZIONE.....	27
ABBASSALINGUA, KILNER-DOUGHTY.....	456	ALGESIMETRO, WARTENBERG.....	25	BABY-KOCHER PINZA INTESTINALE.....	540
ABBASSALINGUA, KROENIG.....	451	ALLEN PINZA PER L'APPENDICE.....	544	BABY-OLSEN-HEGAR PORT'AGHI.....	212
ABBASSALINGUA, MAYO.....	451	ALLIS PINZA PER AFFERRARE INTESTINI.....	537	BABYPHON SFGIMOMANOMTERO.....	10
ABBASSALINGUA, MORITZ-SCHMIDT.....	452	ALLIS-ADAIR PINZA PER AFFERRARE INTESTINI.....	537	BACINELLA.....	619, 620
ABBASSALINGUA, TOBOLD.....	453	ALLIS-BABY PINZA PER AFFERARE INTESTINI.....	537	BACINELLA PER PLACENTA.....	621
ABBASSALINGUA, WIEDER.....	452	ALM DIVARICATORE.....	168	BACINELLA RENIFORMA.....	619
ABRAHAM COLTELLO PER TONSILLE.....	466	ALVIS CURETTA PER CORPI ESTRANEI.....	374	BACKHAUS PINZA FISSATELI.....	132
ABRAHAM PINZA PER TONSILLE.....	468	AMNIOSCOPO.....	601	BAILEY APPROSSIMATORE COSTALE.....	489
ACCESSORI DI FISSAZIONE, ANELLI E BARRE.....	195	AMNIOTOMO, BEACHAM.....	586	BAILEY-BABY APPROSSIMATORE COSTALE.....	489
ACCESSORI PER SEGA PER AUTOPSIA.....	231/2, 231/3	ANDERSON ADSON DIVARICATORE.....	172	BAILEY-GIBBON APPROSSIMATORE COSTALE.....	489
ADATTATORE DI ILLUMINAZIONE.....	601	ANDREW ABASSALINGUA.....	452	BAINBRIDGE PINZA EMOSTATICA.....	119/2
ADLERKREUTZ PINZA VASCOLARE.....	84	ANDREW-PYNCHON TUBO D'ASPIRAZIONE.....	28	BAINBRIDGE PINZA VASCOLARE.....	495
ADSON DIVARICATORE.....	173	ANELLI DI GOMMA PER LEGATURA.....	568	BAKES DILATATORE BILIARE.....	532
ADSON PINZA ANATOMICA.....	82	ANOSCOPO, HIRSCHMANN.....	562	BALFOUR BABY DIVARICATORE ADDOMINALE.....	182
ADSON PINZA ANATOMICA.....	82	ANSA AURICOLARE, BILLEAU.....	409	BALFOUR DIVARICATORE ADDOMINALE.....	182
ADSON PINZA CHIRURGICA.....	82	ANSA AURICOLARE, SHAPLEIGH.....	410	BALFOUR DIVARICATORE ADDOMINALE.....	183
ADSON BABY PINZA EMOSTATICA.....	113	ANSA PER CATERATTA, ARLT.....	378	BALFOUR-US DIVARICATORE ADDOMINALE.....	184
ADSON DIVARICATORE.....	172	ANSA PER CATERATTA, SNELLEN.....	378	BALL AND SOCKET PINZA FISSATELI.....	133
ADSON MICRO PINZA ANATOMICA.....	82	ANSA PER CATERATTA, WEBER.....	378	BALLENGER COLTELLO PER SETTO.....	436
ADSON MICRO PINZA CHIRURGICA.....	82	ANSA PER CATERATTA, WILDER.....	378	BALLENGER ELEVATORE PER SETTO.....	439
ADSON PERIOTOTOMO.....	282	ANSA PER POLIPI.....	411	BALLENGER PINZA PER TONSILLE.....	467
ADSON PINZA EMOSTATICA.....	112	ANSE PER TONSILLE.....	468	BANE-HARTMANN PINZA SGORBIA.....	237
ADSON PINZA PER IPOFISI.....	334	ANTRUM-CURETTA.....	435	BANGERTER SPATOLA PER CICLODIALISI.....	379
ADSON PINZA SGORBIA.....	236	ANVIL TRONCHESINA PER UNGHIE.....	613	BARACANI INSERTO.....	472
ADSON PORT'AGHI.....	211	APPARECCHIATURA DI SUTURA GASTRO-INTESTINALE, V.PETZ.....	549	BARANY ASSORDITORE.....	405
ADSON TENAGLIA PER OSSA.....	298	APPROSSIMATORE COSTALE, BAILEY.....	489	BARBARA AGO.....	419
ADSON TUBO D'ASPIRAZIONE.....	337	APPROSSIMATORE COSTALE, BAILEY-BABY.....	489	BARBARA UNCINO.....	419
ADSON UNCINO PER DURAMADRE.....	329	APPROSSIMATORE COSTALE, BAILEY-GIBBON.....	489	BARKAN COLTELLO PER GONIOTOMIA.....	373
ADSON, DIVARICATORE.....	174	APPROSSIMATORE, BIEMER.....	366	BARNHILL COLTELLO ADENOIDE.....	450
ADSON-BROWN PINZA CHIRURGICA.....	82	APPROSSIMATORE, BIEMER-MÜLLER.....	363	BARON CANNULA D'ASPIRAZIONE.....	336
AEBLI FORBICI PER OFTALMOLOGIA.....	58	APRIBOCCA DI LEGNO MAUNDER.....	459	BARR SPECULO RETTALE.....	559
AGHI PER SUTURE.....	222, 223	APRIBOCCA, DAVIS-BOYLE.....	455	BARRAQUER (COLIBRI) PINZA PER IRIDE.....	384
AGO PER BIOPSIA,FRANKLIN-SILVER.....	206	APRIBOCCA, DAVIS-MEYER.....	457	BARRAQUER BLEFAROSTATO.....	370
AGO DI GUIDA, IOWA.....	206	APRIBOCCA, DENHART,12CM.....	454	BARRAQUER COLTELLO PER CHERATOPLASTICA.....	373
AGO DI GUIDA, REDON.....	207	APRIBOCCA, DINGMANN.....	456	BARRAQUER FORBICI OCULISTICHE.....	75
AGO DI INTRODUZIONE, OBWEGESER.....	463	APRIBOCCA, HEISTER.....	454	BARRAQUER PINZA DA FISSAZIONE.....	390
AGO DI INTRODUZIONE, OBWEGESER.....	463/3	APRIBOCCA, JENNINGS.....	454	BARRAQUER PINZA DEPILETORIA.....	395
AGO PASSAFILI, DEMEL.....	315	APRIBOCCA, KILNER-DOUGHTY.....	456	BARRAQUER PORT'AGHI.....	216, 217
AGO PER CORPI ESTRANEI.....	374	APRIBOCCA, MCIVOR.....	457	BARRAQUER-KATZIN PINZA PER IRIDE.....	384
AGO PER CORPI ESTRANEI, DAVIS.....	374	APRIBOCCA, ROSEK-KOENIG 16CM.....	454	BARRAQUER-TROUTMAN PORT'AGHI.....	216
AGO PER CORPI ESTRANEI, FRANCIS.....	374	APRIBOCCA,DOYEN-JANSEN(MOLT).....	454	BARRET PINZA PER ABBASSARE IL COLLO DELL'UTERO.....	582
AGO PER CORPI ESTRANEI, LA FORCE.....	374	ARCHER PINZA PER SCHEGGE.....	92	BARTON FORCIPE.....	603
AGO PER CORPI ESTRANEI, LEVINSON.....	374	ARCO PER ESTENSIONE, BOEHLER.....	312	BARTON TRATTORE.....	603
AGO PER DISCISIONE.....	374	ARCO PER ESTENSIONE, KIRSCHNER.....	312	BAUMGARTNER PORT'AGHI.....	208
AGO PER DISCISIONE, BOWMAN.....	374	ARCO PER ESTENSIONE, KIRSCHNER US.....	312	BEACHAM AMNIOTOMO.....	586
AGO PER INSUFFLAZIONE, VERESS.....	206	ARLT ANSA PER CATERATTA.....	378	BECHERT ROTATORE PER NUCLEO.....	379
AGO PER LEGATURE.....	218	ARRUGA BLEFAROSTATO.....	370	BECK PINZA PER ANASTOMOSI.....	520
AGO PER LEGATURE SCHMIEDEN-DICK.....	219	ARRUGA CUCCHIAIO PER ASPORTAZIONE RETINALE.....	378	BECK PINZA VASCOLARI.....	516
AGO PER LEGATURE, COOPER.....	219			BECKER CISTOTOMO.....	375
AGO PER LEGATURE, DESCHAMPS.....	218	ARRUGA PINZA CAPSULARE.....	391	BECKMANN COLTELLO ADENOIDE.....	450
AGO PER LEGATURE, KRONECKER.....	219	ARRUGA PORT'AGHI.....	214	BECKMANN DIVARICATORE.....	176
AGO PER LEGATURE, NELSON.....	219	ARRUGA UNCINO ESTRATTORE.....	375	BECKMANN-ADSON DIVARICATORE.....	175
AGO PER PARACENTESI, LUCAE.....	408	ASCH PINZA PER LA PLASTICA NASALE.....	449	BECKMANN-EATON DIVARICATORE.....	176
AGO PER PARACENTESI, POLITZER.....	408	ASSORDITORE, BARANY.....	405	BEEBEE FORBICI PER CORONA.....	68
AGO PER TONSILLE.....	470	AUFBRANC-COBRA DIVARICATORE.....	289	BEER PINZA DEPILETORIA.....	395
AGO PER TONSILLE, CLAUS.....	466	AUFRICHT RASPA NASALE.....	443	BEESON DIVARICATORE PER GESSI.....	232
AGO PER TONSILLE, DUPUY-WEISS.....	466	AUFRICHT UNCINO NASALE.....	447	BEESON DIVARICATORE PER GESSI.....	232
AGO PER TONSILLE, NAGER.....	466	AUVARD SPECULO VAGINALE.....	576	BELLUCCI MICRO FORBICI AURICOLARI.....	413
AGO POST MORTEM.....	268			BELLUCCI MICRO FORBICINE.....	417
AGO, BARBARA.....	419			BENDA PER COMPRESSIONE ESMARCH.....	297
AGO, KEITH.....	223				

BENDER MODELLATORE PER CHIODI.....	322	BOYNTON PORT'AGHI.....	214	CANNULA D'ASPIRAZIONE PER BIOPSIA, BUIE.....	566
BENGOLEA PINZA EMOSTATICA.....	112	BOZEMANN PINZA PER TAMPONI.....	138	CANNULA D'ASPIRAZIONE POOLE.....	27
BENNETT ELEVATORE PER OSSA.....	283	BOZEMANN PORT'AGHI.....	211	CANNULA D'ASPIRAZIONE ZÖLLNER.....	337/1
BENSAUDE PROCTOSCOPO.....	565	BOZEMANN-DOUGLAS PINZA PER TAMPONI.....	138	CANNULA D'ASPIRAZIONE, ADSON.....	337
BENSON DIVARICATORE PER PILORO.....	544	BRACCIALE.....	295	CANNULA D'ASPIRAZIONE, ANDREW-PYNCHON.....	28
BERENS CHERATOMO.....	372	BRACCIO PORTALAREINGOSCOPIO KLEINSASSER.....	36	CANNULA D'ASPIRAZIONE, BABY-YANKAUER.....	27
BERGMANN FORBICI PER BENDAGGI.....	69/1	BRAND ENUCLEATORE PER TENDINI.....	294	CANNULA D'ASPIRAZIONE, COOLEY.....	28
BERGMANN MARTELLO.....	272	BRAND STRUMENTI PER AFFERRARE TENDINI.....	293	CANNULA D'ASPIRAZIONE, DE BAKEY.....	28
BERKE PINZA MUSCOLARE.....	389	BRAUN CRANIOCLASTO.....	607	CANNULA D'ASPIRAZIONE, FERGUSSON.....	337
BERLINER MARTELLO DA PERCUSSIONE.....	24	BRAUN DEPRESSORE UTERINO.....	586	CANNULA D'ASPIRAZIONE, FRAZIER/FERGUSSON.....	337
BERNHARD PINZA FISSATELI.....	133	BRAUN PINZA PER ABBASSARE IL COLLO		CANNULA D'ASPIRAZIONE, PLESTER.....	338
BERRY PINZA TORCIFILI.....	319	DELL'UTERO.....	582	CANNULA D'ASPIRAZIONE, ROSEN.....	338
BETHUNE COSTOTOMO.....	481	BRAUN UNCINO SPEZZATORE.....	607	CANNULA D'ASPIRAZIONE, YASARGIL.....	337/1
BICCHIERE GRADUATO.....	620	BRAUN-STADLER FORBICI PER EPISIOTOMIA.....	64	CANNULA D'ASPIRAZIONE, HOUSE.....	337/2
BICCHIERE PER MEDICINALI.....	621	BREAST DIVARICATORE PER CHIRURGIA PLASTICA.....	198	CANNULA LARINGEA.....	470
BIEMER APPROSSIMATORE.....	366	BREISKY SPECOLO VAGINALE.....	577	CANNULA OCULISTICA JENSEN.....	394
BIEMER CLIPS PER VASI.....	361	BRIDGE PINZA EMOSTATICA.....	116	CANNULA OCULISTICA MCINTYRE.....	394
BIEMER PINZA POSA CLIPS.....	361, 363, 364, 366	BRISTOW ELEVATORE PER OSSA.....	290	CANNULA OCULISTICA PER IRRIGAZIONE ED	
BIEMER-MÜLLER APPROSSIMATOR.....	363	BRODIE SPECILLO.....	199	ASPIRAZIONE BISHOP-HARMON.....	394/1
BIER SEGA PER AMPUTAZIONE.....	296	BROPHY PINZA ANATOMICA.....	84	CANNULA OCULISTICA, LACRIMAL.....	394
BILL TRATTORE.....	604	BROPHY PINZA CHIRURGICA.....	84	CANNULA PER ASPIRAZIONE GUILLEN.....	433/1
BILLEAU ANSA AURICOLARE.....	409	BROWN PINZA PER TESSUTI.....	83	CANNULA PER BIOPSIA, MENGHINI.....	206
BIRCHER-GANSKE TENAGLIA PER OSSA.....	246	BROWN PORT'AGHI.....	209	CANNULA PER IRRIGAZIONE KILLIAN.....	433, 433/1
BIRKETT PINZA EMOSTATICA.....	116	BRUENINGS COLTELLO PER TONSILLE.....	466	CANNULA PER IRRIGAZIONE SHEETS.....	394/2
BISHOP-HARMAN PINZA PER IRIDE.....	386	BRUENINGS ABBASSALINGUA.....	451	CANNULA PER IRRIGAZIONE, HARTMANN.....	433
BISHOP-HARMON CANNULA OCULISTICA PER		BRUENINGS INSERTO.....	472	CANNULA PER IRRIGAZIONE, SCHMID.....	338
IRRIGAZIONE ED ASPIRAZIONE.....	394/1	BRUENINGS PINZA PER SETTO NASALE.....	425	CANNULA PER IRRIGAZIONE, SIMENMANN.....	433
BISTURI MONOUSO, STERILI.....	43	BRUENINGS SPECOLO AURICOLARE.....	401	CANNULA PER IRRIGAZIONE, SIBCOE.....	394
BISTURI PER FIBROMI, SEGOND.....	594	BRUNETTI SCALPELLO.....	268	CANNULA TRACHEALE, LUER.....	479
BISTURI, MANICO DI METALLO.....	46	BRÜNNINGS-LUCAS SCALPELLO.....	260	CANNULA TRACHEALE, WAGENER-MOSHER.....	477
BLAKE CURETTA UTERINA.....	595	BRÜNNINGS-LUCAS SCALPELLO.....	260	CANNULA TRACHEALE, CHEVALIER-JACK.....	479
BLAKE PINZA PER CALCOLI BILIARI.....	531	BRÜNNINGS-LUCAS SGORBIA.....	260	CANNULA, LICHTWITZ.....	433
BLEFAROSTATO CLARK.....	370	BRUNNER COSTOTOMO.....	481	CAPLAN PINZA NASALE.....	428
BLEFAROSTATO LIEBERMANN.....	371	BRUNNER DIVARICATORE.....	167	CARMALT PINZA PER SCHEGGE.....	91
BLEFAROSTATO, ARRUGA.....	370	BRUNNER PINZA INTESTINALE.....	543	CAROLL PINZA PER AFFERRARE TENDINI.....	293
BLEFAROSTATO, BARRAQUER.....	370	BRUNNER SONDE CONDUITTRICE.....	221	CARPENTER COLTELLO PER TONSILLE.....	465
BLEFAROSTATO, BOWMAN.....	370	BRUNNER SONDE CONDUITTRICE.....	221	CASPAR DIVARICATORE PER SPINA CERVICALE.....	179
BLEFAROSTATO, CASTROVIEJO.....	371	BRUNS CURETTA TAGLIENTE.....	251, 254	CASPAR DIVARICATORE PER SPINA CERVICALE.....	180
BLEFAROSTATO, CRITCHETT.....	370	BRUNS FORBICI PER BENDAGGI.....	70	CASPAR PISTONI.....	258
BLEFAROSTATO, GRAEFE.....	370	BRYANT PINZA PER MEDICATURA.....	137	CASTANEDA NEONATAL PINZA VASCOLARE.....	527
BLEFAROSTATO, LANCASTER.....	371	BUCHWALD ABBASSALINGUA.....	451	CASTROVIEJO BLEFAROSTATO.....	371
BLEFAROSTATO, LISTER-BURCH.....	370	BUCK CURETTA AURICOLARE.....	407	CASTROVIEJO COLTELLO LANCEOLARE.....	372
BLEFAROSTATO, MELLINGER.....	370	BUCK LEVA PER CORPI ESTRANEI.....	412	CASTROVIEJO COMPASSO.....	380
BLEFAROSTATO, MELLINGER-AXENFELD.....	370	BUCK MARTELLO DA PERCUSSIONE.....	24	CASTROVIEJO FORBICI CORNEALI.....	79
BLEFAROSTATO, MUELLER.....	371	BUCK-GRAMCKO ELEVATORE PER OSSA.....	285	CASTROVIEJO PINZA CAPSULARE.....	391
BLEFAROSTATO, MURDOCK.....	370	BUIE CANNULA D'ASPIRAZIONE RETTALE.....	566	CASTROVIEJO PINZA FISSATRICE.....	390
BLEFAROSTATO, PARK.....	371	BULLDOG PINZA MINI DIETRICH.....	101	CASTROVIEJO PINZA PER SUTURA.....	392
BLEFAROSTATO, SMITH.....	370	BULLDOG PINZA, JOHNS-HOPKINS.....	104	CASTROVIEJO PORT'AGHI.....	215
BLEFAROSTATO, STEVENSON.....	371	BULLDOG PINZE ATRAUMATICHE.....	100	CASTROVIEJO ROMPIAMETTE.....	45
BLEFAROSTATO, WEEK.....	370	BÜLOW-GUNAR-HEY PINZA SERRATUBI A RULLI.....	130	CASTROVIEJO SPATOLA PER CICLODIALISI.....	379
BLEFAROSTATO, WILLIAMS.....	370	BUMM CURETTE UTERINI.....	597	CASTROVIEJO-MICRO PORT'AGHI.....	215
BLEFAROSTATO, ZIEGLER.....	371	BUNELL ENUCLEATORE PER TENDINI.....	292	CASTROVIEJO-STANDARD PORT'AGHI.....	216
BLOHMKE PINZA PER TONSILLE.....	467	BUNELL GUIDA PER TENDINI.....	294	CATETERE AURICOLARE, HARTMANN.....	408
BLOUNT ELEVATORE PER GINOCCHIO.....	289	BUNELL PERFORATORE A MANO.....	299	CATETERE METALLICO.....	555
BLOUNT ELEVATORE PER OSSA.....	288	BUNGE CUCCHIAIO PER ESTENTERAZIONE.....	378	CATETERE METALLICO, COXETER.....	555
BLUMENTHAL PINZA SGORBIA.....	236	BUNT PINZA PER STERILIZZAZIONE.....	227	CATLUN AMPUTATIONSMESSN.....	44
BODENHAMMER SPECOLO RETTALE.....	559	BURCH UNCINO DI FISSAZIONE.....	373	CAUTERIO WADSWORTH-TODD.....	378
BOEHLER ARCO PER ESTENSIONE.....	312	BURKE PINZA PER BIOPSIA.....	590	CAVO BIPOLORE.....	633
BOERMA FORCIPE.....	604	BUSHE CURETTA TAGLIANTE.....	256	CESIOIA PER GESSI, STILLE.....	229
BOETTCHER FORBICI PER TONSILLE.....	59			CESIOIA PER OSSA STILLE-HORSLEY.....	242
BÖHLER CESIOIA PER OSSA.....	241	C		CESIOIA PER OSSA STILLE-LISTON.....	242
BÖHLER PINZA SGORBIA.....	238	CACCIAVITE WILLIAMS.....	323	CESIOIA PER OSSA, BOEHLER.....	241
BOIES ELEVATORE.....	277	CACCIAVITE, LANE.....	323, 324	CESIOIA PER OSSA, LISTON.....	241
BONACCOLTO PINZA PER STRABISMO.....	385	CALAMITA OCULISTICA, REDA.....	395	CESIOIA PER OSSA, MCINDOE.....	241
BONN PINZA PER IRIDE.....	387	CALIBRO.....	26	CESIOIA PER OSSA, RUSKIN-LISTON.....	241
BONNEY PINZA ANATOMICA.....	88	CAMERA D'ARIA.....	295	CESIOIA PER OSSA, SEMB.....	242
BONNEY PINZA CHIRURGICA.....	88	CANDELETTA DILATATRICE, DITTEL.....	554	CESIOIA PER OSSA, COTTLE-K.....	241
BOSE DIVARICATORE TRACHEALE.....	476	CANDELETTA DILATATRICE, GUYON.....	554	CESTELLO.....	623
BOUCHERON SPECOLO AURICOLARE.....	399	CANDELETTA DILATATRICE, VAN BUREN.....	554	CESTELLO PER ENDOSCOPI.....	623
BOWMAN AGO PER DISCISIONE.....	374	CANFIELD COLTELLO PER TONSILLE.....	466	CESTELLO PER STERILIZZAZIONE.....	622
BOWMAN BLEFAROSTATO.....	370	CANNULA DA INIEZIONE.....	36	CHANDLER ELEVATORE.....	282
BOWMAN CHERATOMO.....	372	CANNULA D'ASPIRAZIONE.....	337/1	CHAPUT PINZA PER AFFERRARE TESSUTI.....	110
BOWMAN SPECILLO PER CANALE LACRIMALE.....	381	CANNULA D'ASPIRAZIONE KLEINSASSER.....	36	CHARNLEY DIVARICATORE ADDOMINALE.....	289

CHARRIERE SEGA PER AMPUTAZIONE.....	296	COLTELLO PER AMPUTAZIONE, CATLIN.....	44	CORONAL BLOW DIVARICATORE PER CHIRURGIA PLASTICA.....	198
CHEATLE PINZA PER STERILIZZAZIONE.....	227	COLTELLO PER AMPUTAZIONE, LANGENBECK.....	44	CORWIN-HEGAR PINZA TORCIFILO.....	319
CHELSEA-EATON PROCTOSCOPO.....	563	COLTELLO PER AMPUTAZIONE, REDA.....	44	CORYLLOS COSTOTOMO.....	480
CHERON PINZA PER MEDICATURA.....	137	COLTELLO PER CARTILAGINE E DISSEZIONE, VIRCHOW.....	48	CORYLLOS DIVARICATORE.....	166
CHERRY DIVARICATORE PER LAMINECTOMIA.....	488	COLTELLO PER CARTILAGINI, LANGENBECK.....	47	COS MIKRO-PINZA AURICOLARE.....	414
CHEVALIER-JACKSON CANNULA TRACHEALE.....	479	COLTELLO PER CATARATTA, DEUTSCHMANN.....	371	COSCIALE.....	295
CHEVALIER-JACKSON PINZA PER BRONCO-ESOFAGOSOFIA.....	473	COLTELLO PER CATARATTA, GRAEFE.....	371	COSTOTOMO.....	480
CHIAVE.....	266	COLTELLO PER CERVELLO.....	48	COSTOTOMO SAUERBRUCH-FREY.....	481
CHIAVI.....	313	COLTELLO PER CHERATOPLASTICA, BARRAQUER.....	373	COSTOTOMO, BETHUNE.....	481
CHILDE PINZA PER AGRAFES.....	224	COLTELLO PER CHERATOPLASTICA, PAUFIQUE.....	373	COSTOTOMO, BRUNNER.....	481
CHIODI PER OSSA.....	309	COLTELLO PER DURA MADRE, KOOS.....	335	COSTOTOMO, CORYLLOS.....	480
CHIODI STEINMANN.....	307, 308	COLTELLO PER FALANGI.....	44	COSTOTOMO, GIERTZ-STILLE.....	481
CINELLI SCALPELLO PER SETTO.....	441	COLTELLO PER GESSI, ESMARCH.....	233	COSTOTOMO, GLUCK.....	480
CISTOTOMO, BECKER.....	375	COLTELLO PER GESSI, HOPKINS.....	233	COSTOTOMO, SAUERBRUCH.....	481
CISTOTOMO, GRAEFE.....	375	COLTELLO PER GESSI, REINER.....	233	COSTOTOMO, STILLE.....	480
CITELLI PINZA TAGLIANTE PER SETTO NASALE.....	430	COLTELLO PER GESSI, WIGMORE.....	229	COTTLE COLUMELLA PINZA.....	448
CLAR LAMPADA FRONTALE.....	22	COLTELLO PER GONIOTOMIA, BARKAN.....	373	COTTLE BULLDOG-FORBICI.....	56
CLARK BLEFAROSTATO 8CM.....	370	COLTELLO PER GONIOTOMIA, SCHEIE.....	373	COTTLE COLTELLO NASALE.....	435
CLAUS AGO PER TONSILLE.....	466	COLTELLO PER IRIDE, DEAN.....	372	COTTLE ELEVATORE PER SETTO.....	439
CLAYMAN UNCINO.....	376	COLTELLO PER IRIDE, KNAPP.....	372	COTTLE FORBICI NASALI.....	59
CLEVELAND PINZA SGOBRIA.....	235	COLTELLO PER IRIDE, ZIEGLER.....	372	COTTLE MARTELLO.....	273
CLIPS PER ANEURISMA YASARGIL.....	345- 356	COLTELLO PER MENISCO, NEFF.....	292	COTTLE PINZA DA PRESA.....	410
CLIPS PER VASI, BIEMER.....	361	COLTELLO PER MENISCO, SMILLIE.....	292	COTTLE SCALPELLO PER SETTO.....	440
CLIPS PER VASI, MEHDORN.....	362	COLTELLO PER ORGANI.....	48	COTTLE SPECOLO NASALE.....	423
CLIPS PER VASI, MUELLER.....	364, 365	COLTELLO PER PERIOSTIO CON RASCHINO.....	47	COTTLE UNCINO NASALE.....	447
CLOWARD DIVARICATORE.....	178	COLTELLO PER RESEZIONE.....	47	COTTLE-JOSEPH ELEVATORE PER SETTO.....	439
CLOWARD DIVARICATORE PER CORPI VERTEBRALI.....	339	COLTELLO PER SETTO NASALE, FREER.....	434	COTTLE-KAZANJIAN CESOIA PER OSSA.....	241
CLOWARD PINZA TAGLIANTE PER LAMINECTOMIA.....	342	COLTELLO PER SETTO, BALLENGER.....	436	COTTLE-NEIVERT UNCINO NASALE.....	448
COAKLEY ANTRUM CURETTA.....	449	COLTELLO PER TONSILLE, ABRAHAM.....	466	COXETER CATETERE METALLICO.....	555
COAKLEY TREQUARTO PER SENO MASCELLARE.....	204	COLTELLO PER TONSILLE, BRUENINGS.....	466	CRAFOOD-SELLORS PINZA EMOSTATICA.....	119
COBB CURETTA.....	252	COLTELLO PER TONSILLE, CANFIELD.....	466	CRAFOOD FORBICI POLMONARE.....	65/2
COBB PERIOSTOTOMO.....	280	COLTELLO PER TONSILLE, CARPENTER.....	465	CRAFOOD PINZA EMOSTATICA.....	118
COBB SGOBRIA.....	262	COLTELLO PER TONSILLE, DOUGLAS.....	466	CRANIOCLASTO, BRAUN.....	607
COLCLOUGH PINZA TAGLIANTE PER DISCHI INTERVERTEBRALI.....	344/1	COLTELLO PER TONSILLE, FISHER.....	466	CRANIOCLASTO, TARNIER.....	607
COLLER-CRILE PINZA EMOSTATICA.....	106	COLTELLO, PLESTER.....	418	CREGO ELEVATORE.....	282
COLLIER PELVIMETRO.....	605	COLTELLO, ROSEN.....	418	CRILE DIVARICATORE.....	140
COLLIER PORT'AGHI.....	208	COLTELLO, SCHUKNECHT.....	418	CRILE PINZA EMOSTATICA.....	107
COLLIN DINAMOMETRO.....	25	COLTELLO, TABB.....	418	CRILE PORT'AGHI.....	213
COLLIN DIVARICATORE.....	139	COLTELLO, WULLSTEIN.....	418	CRILE UNCINO PER NERVI.....	328
COLLIN DIVARICATORE ADDOMINALE.....	189/1	COLUMELLA PINZA, COTTLE.....	448	CRILE-MURRAY PORT'AGHI.....	209
COLLIN DIVARICATORE ADDOMINALE.....	190	COLVER PINZA PER TONSILLE.....	467	CRILE-RANKIN PINZA EMOSTATICA.....	107
COLLIN ISTEROMETRO.....	586	COMBINAZIONE PER DIAGNOSTICA CON ILLUMINAZIONE ALOGENA, RI-MINI.....	17	CRILE-WOOD PORT'AGHI.....	209
COLLIN LOKITTE DIVARICATORE ADDOMINALE.....	191	COMBINAZIONE PER DIAGNOSTICA CON ILLUMINAZIONE STANDARD ECO "T".....	16	CRITCHETT BLEFAROSTATO.....	370
COLLIN MARTELLO.....	270	COMBINAZIONE PER DIAGNOSTICA CON ILLUMINAZIONE STANDARD UNI I.....	13	CRUTCHFIELD PERFORATORE.....	327
COLLIN PELVIMETRO.....	605	COMBINAZIONE PER DIAGNOSTICA CON ILLUMINAZIONE STANDARD UNI II.....	14	CRUTCHFIELD PINZA PER TRAZIONE CRANIALE.....	327
COLLIN PINZA OMBELICALE.....	605	COMBINAZIONE PER DIAGNOSTICA CON ILLUMINAZIONE STANDARD UNI III.....	15	CUCCHIAIO AURICOLARE, GROSS.....	409
COLLIN PINZA PER AFFERRARE INTESTINI.....	539	COMPASSO, CASTROVIEJO.....	380	CUCCHIAIO OSTETRICO, SELLHEIM.....	607
COLLIN PINZA PER AFFERRARE L'UTERO.....	585	COMPASSO, IWANSON.....	624	CUCCHIAIO PER ABORTO, CUZZI.....	606
COLLIN PINZA PER AFFERRARE TESSUTI.....	110	COMPRESSORE STONE-WATT.....	545	CUCCHIAIO PER ABORTO, WALLICH.....	607
COLLIN PINZA PER AGRAFES.....	224	CONE PINZA PER CRANIOTOMIA.....	331	CUCCHIAIO PER ASPORTAZIONE RETINALE, ARRUGA.....	378
COLLIN PINZA PER MEDICATURA.....	137	CONNIN-AMSLER MARCATORE.....	380	CUCCHIAIO PER CALCOLI BILIARI MOOR.....	532
COLLIN PINZA TIRILINGUA.....	453	CONVERSE COLTELLO NASALE.....	435	CUCCHIAIO PER CALCOLI BILIARI, DESJARDINS.....	534
COLLIN SPECOLO VAGINALE.....	570	COOLEY DILATATORE.....	528	CUCCHIAIO PER CALCOLI BILIARI, FERGUSON.....	533
COLLIN-DUVAL PINZA DA PRESA.....	85	COOLEY CANNULA D'ASPIRAZIONE.....	28	CUCCHIAIO PER CALCOLI BILIARI, LUER-KOERTE.....	533
COLLIN-HARTMANN DIVARICATORE.....	141	COOLEY DIVARICATORE.....	148	CUCCHIAIO PER CALCOLI BILIARI, MAYO.....	534
COLTELLO ADENOIDE BECKMANN.....	450	COOLEY DIVARICATORE COSTALE.....	487	CUCCHIAIO PER CATERATTA, DAVIEL.....	377
COLTELLO ADENOIDE, BARNHILL.....	450	COOLEY PINZA CARDIOVASCOLARE ATRAUMATICA.....	518, 519, 522	CUCCHIAIO PER CATERATTA, GRAEFE.....	377
COLTELLO ADENOIDE, ST. CLAIR-THOMSON.....	450	COOLEY PINZA PER CATETERI.....	510	CUCCHIAIO PER CATERATTA, KNAPP.....	378
COLTELLO AURICOLARE, POLITZER.....	408	COOLEY-DERRA PINZA PER ANASTOMOSI.....	519	CUCCHIAIO PER CATERATTA, WELLS.....	378
COLTELLO AURICOLARE, SEXTON.....	408	COOLEY-NEONATAL DIVARICATORE COSTALE.....	485	CUCCHIAIO PER ESTENTERAZIONE, BUNGE.....	378
COLTELLO FALCATO REDA.....	435	COOPER AGO PER LEGATURE.....	219	CUCCHIAIO PER MEDICINALI.....	621
COLTELLO INTEROSSEO.....	44	COPERCHIO PER PADELLA.....	621	CUCCHIAIO PER SANGUE.....	268
COLTELLO LANCEOLARE, BERENS.....	372	CORDA DI TRAZIONE.....	201	CUCCHIAIO UTERINO GOURDET.....	599
COLTELLO LANCEOLARE, BOWMAN.....	372	CORDES INSERTO.....	472	CUCCHIAIO UTERINO SCHRÖDER.....	595
COLTELLO LANCEOLARE, CASTROVIEJO.....	372			CUCCHIAIO UTERINO, SIMON.....	594
COLTELLO LANCEOLARE, JAEGER.....	372			CULLER SPATOLA PER IRIDE.....	378
COLTELLO LANCEOLARE, WHEELER.....	373			CURETTA ANTRUM.....	435
COLTELLO LANCEOLARE, ZIEGLER.....	373			CURETTA ANTRUM, COAKLEY.....	449
COLTELLO NASALE, CONVERSE.....	435			CURETTA AURICOLARE, BUCK.....	407
COLTELLO NASALE, COTTLE.....	435			CURETTA COBB.....	252
COLTELLO PER AMPUTAZIONE LISTON.....	44			CURETTA DA CALAZIO, AXENFELD.....	377

CURETTA DA CALAZIO, HEBRA	377	DE BAKEY PINZA VASCOLARE	493, 494, 495, 496, 497, 498, 499, 500, 505, 507, 508, 514, 515, 516, 517,	DILATATORE UTERINO PRATT	580
CURETTA DA CALAZIO, MEYHOEFER	377	DE BAKEY PORT'AGHI	210	DILATATORE UTERINO SIMS	581
CURETTA PER ABORTO, PESTALOZZA	606	DE BAKEY, PINZA ATRAUMATICA BULLDOG	100	DILATATORE UTERINO WYLIE	581
CURETTA PER BIOPSIA ED ASPIRAZIONE	600	DE BAKEY, PINZE ATRAUMATICHE	98	DILATATORE VASCOLARE DEBAKEY	529
CURETTA PER BIOPSIA, HEANY	587	DE BOER DIVARICATORE COSTALE	486	DINAMOMETRO, COLLIN	25
CURETTA PER BIOPSIA, KEVORKIAN	587	DE LEE FORCIPE	602	DINGMAN ELEVATORE	463/3
CURETTA PER BIOPSIA, MOD.MÜNCHEN	587	DE MARTEL STRUMENTO CONDUTTRICE	330	DINGMANN ABBASSALINGUA	456
CURETTA PER BIOPSIA, NOVAK	587	DE MARTEL STRUMENTO CONDUTTRICE	330	DINGMANN APRIBOCCA	456
CURETTA PER BIOPSIA, RANDALL	587	DE MARTEL-WOLFSON PINZA PER ANASTOMOSI	546	DINGMANN DIVARICATORE	463
CURETTA PER CORPI ESTRANEI ALVIS	374	DEAN COLTELLO PER IRIDE	372	DINGMANN PERIOSTOTOMO	463
CURETTA PER IPOFISI	334	DEAN FORBICI PER TONSILLE	59	DINGMANN TENAGLIA PER OSSA	246
CURETTA PER LUPUS, FOX	608	DEAVER DIVARICATORE	145	DIPLOMAT SFIGMOMANOMETRO	5
CURETTA PER LUPUS, PIFFARD	608	DEAVER FORBICI PER DISSEZIONE	52	DISSETTORE CORNEALE, PATON	373
CURETTA TAGLIENTE BRUNS	251, 254	DEAVER-GRIP DIVARICATORE	146	DISSETTORE CORNEALE, ELSCHNIG	373
CURETTA TAGLIENTE DOPPIA VOLKMANN	257	DEBAKEY FORBICI VASCOLARI	61	DISSETTORE CORNEALE, GILL	373
CURETTA TAGLIENTE VOLKMANN	251	DEBAKEY FORBICI VASCOLARI TC	60	DISSETTORE CORNEALE, GREEN	374
CURETTA TAGLIENTE WILLIGER	255	DEBAKEY PINZA PER ANASTOMOSI	505	DISSETTORE CORNEALE, SATO	373
CURETTA TAGLIENTE, BUSHE	256	DEBAKEY-BAHNSON PINZA ANEURISMA	506	DISSETTORE CORNEALE, TOOK	373
CURETTA TAGLIENTE, DAUBENSPECK	255	DEBAKEY-DIETHRICH MINI PINZA BULLDOG	101	DISSETTORE CORNEALE, GORNEY	277
CURETTA TAGLIENTE, HALLE	253	DEBAKEY-MOSQUITO PINZA EMOSTATICA	509	DISSETTORE PER SACCO LACRIMALE, LANG	378
CURETTA TAGLIENTE, JACOBSON	257	DEBAKEY-PEAN PINZA EMOSTATICA	513	DISSETTORE PER TONSILLE, HURD	465
CURETTA TAGLIENTE, JANSEN	257	DEBAKEY-RANKIN PINZA EMOSTATICA	512	DISSETTORE PER TONSILLE, LOPEZ-REINKE	465
CURETTA TAGLIENTE, LEMPERS	256	DEBAKEY-SATINSKY PINZA PER OCCLUSIONE TANGENZIALE	502	DISSETTORE PER TONSILLE, YANKAUER	465
CURETTA TAGLIENTE, MARTINI	257	DEJERINE MARTELLO DA PERCUSSIONE	24	DISSETTORE, FISCH	420
CURETTA TAGLIENTE, SCHEDE	251	DELEE DIVARICATORE	574	DISSETTORE, PENFIELD	333
CURETTA TAGLIENTE, SCOVILLE	253	DELEM AGO PASSAFILI	315	DISTRIBUTORE PER PERFORATORI FILIFORME	310
CURETTA TAGLIENTE, SPINAL	253	DELEM STRUMENTO TENDIFILI	315	DISTRIBUTORE PER SPAZZOLINI	611
CURETTA TAGLIENTE, SPRATT	251	DENHART APRIBOCCA	454	DITTEL CANDELETTA DILATATRICE	554
CURETTA, FAULKNER	449	DEHART APRIBOCCA	454	DIVARICATORE	463/3
CURETTA, HOUSE	420	DENIS-BROWNE DIVARICATORE ADDOMINALE	185	DIVARICATORE ADDOMINALE BABY GOSSET	181
CURETTE UTERINI, BLAKE	595	DEPRESSORE PER EPIGLOTTIDE, REICHERT	471	DIVARICATORE ADDOMINALE BALFOUR	182
CURETTE UTERINI, BUMM	597	DEPRESSORE UTERINO, BRAUN	586	DIVARICATORE ADDOMINALE BALFOUR BABY	182
CURETTE UTERINI, RECAMIER	597	DEPRESSORE UTERINO, SIMS	586	DIVARICATORE ADDOMINALE BALFOUR-US	184
CURETTE UTERINI, SIMS	597, 598	DERF PORT'AGHI	208	DIVARICATORE ADDOMINALE CHARNELY	289
CURETTE UTERINI, THOMAS	599	DERMATOMO, HUMBY	50	DIVARICATORE ADDOMINALE COLLIN	190
CUSCO SPECOLO VAGINALE	570, 571	DERMATOMO, SILVER	50	DIVARICATORE ADDOMINALE COLLIN-LOKITTLE	191
CUSHING (TAYLOR) PINZA TC	87	DERMATOMO, SCHINK	49	DIVARICATORE ADDOMINALE COMPLETO KIRSCHNER 187/1	
CUSHING DIVARICATORE	151	DERRA PINZA CARDIOVASCOLARE ATRAUMATICA	515	DIVARICATORE ADDOMINALE DENIS-BROWNE	185
CUSHING DIVARICATORE	152	D'ERRICO UNCINO PER NERVI	329/2	DIVARICATORE ADDOMINALE FRAZIER	181
CUSHING DIVARICATORE	153	DESCHAMPS AGO PER LEGATURE	218	DIVARICATORE ADDOMINALE GELPI	189/2
CUSHING PERFORATORE	299	DESJARDINS CUCCHIAIO PER CALCOLI BILIARI	534	DIVARICATORE ADDOMINALE GOSSET	181
CUSHING PINZA ANATOMICA	83	DESJARDINS PINZA EMOSTATICA	121	DIVARICATORE ADDOMINALE HORGAN	183
CUSHING PINZA CHIRURGICA	83	DESJARDINS PINZA PER CALCOLI BILIARI	531	DIVARICATORE ADDOMINALE JACKSON BURROWS 189/2	189/2
CUSHING PINZA TAGLIENTE PER LAMINECTOMIA	340	DESJARDINS SONDA PER CALCOLI BILIARI	532	DIVARICATORE ADDOMINALE KIRSCHNER	185
CUSHING SPATOLA CEREBRALE	369	DESMARRES DIVARICATORE	151	DIVARICATORE ADDOMINALE RICARD	191
CUSHING UNCINO PER NERVI	328	DESMARRES PINZA PER CALAZIO	393	DIVARICATORE ADDOMINALE RIGBY	189/2
CUZZI CUCCHIAIO PER ABORTO	606	DEUTSCHMANN COLTELLO PER CATARATTA	371	DIVARICATORE ADDOMINALE RICHARD	186
CZERNY PINZA PER ABBASSARE IL COLLO DELL'UTERO	584	DEVILBISS PINZA PER CRANIOTOMIA	332	DIVARICATORE ADDOMINALE, DE BAKEY	189/1
CZERNY SPECOLO RETTALE	559	DIAPASON	404	DIVARICATORE ADDOMINALE, DOYEN	189/1
D		DIAPASON, HARTMANN	403	DIVARICATORE ADDOMINALE, GELPI	189/1
DANDY PINZA EMOSTATICA	109	DIAPASON, LUCAE	404	DIVARICATORE ADDOMINALE, SET COMPLETO, CON MORSETTI E VALVE	193
DANDY UNCINO PER NERVI	328	DIAPASON, REDA	403	DIVARICATORE ADDOMINALE, SET COMPLETO, CON SISTEMA DI MONTAGGIO	192
DARLING DIVARICATORE	178	DIAPASONN, RYDEL-SEIFFERT	404	DIVARICATORE ADSON	172
DARTIGUES PINZA PER AFFERRARE L'UTERO	585	DIFFENBACH PINZA VASCOLARE	104	DIVARICATORE ADSON	174
DASTOOR PINZA PER STRABISMO	386	DIETER MIKRO-PINZA AURICOLARE	414	DIVARICATORE ANALE, SMITH-BUIE	561
DAUBENSPECK CURETTA TAGLIENTE	255	DIETRICH PINZA MINI BULLDOG	101	DIVARICATORE AUFRANC-COBRA	289
DAVIDSON(SCAPULA) DIVARICATORE	166	DIETRICH FORBICI VASCOLARI	60	DIVARICATORE COLLIN	139
DAVIEL CUCCHIAIO PER CATERATTA	377	DIETRICH PINZA AORTA	510	DIVARICATORE COSTALE, COOLEY	487
DAVIS AGO PER CORPI ESTRANEI	374	DILATATOR TRACHEALE LABORDE	476	DIVARICATORE COSTALE, COOLEY-NEONATAL	485
DAVIS DURA DISSETTORE	332	DILATATORE COOLEY	528	DIVARICATORE COSTALE, DE BOER	486
DAVIS PINZA PER STERILIZZAZIONE	227	DILATATORE PER CANALE LACRIMALE, WILDER	381	DIVARICATORE COSTALE, FINOCHIETTO-BURFORD	483
DAVIS SPATOLA CEREBRALE	337	DILATATORE PER CANALE LACRIMALE, ZIEGLER	381	DIVARICATORE COSTALE, HAIGHT	487
DAVIS-BOYLE ABBASSALINGUA	455	DILATATORE PER CANALE LACRIMALE, CASTROVIEJO	381	DIVARICATORE COSTALE, MORSE	484
DAVIS-BOYLE APRIBOCCA	455	DILATATORE PER CONDOTTI BILIARI, BAKES	532	DIVARICATORE COSTALE, MORSE-FAVALORO	484
DAVIS-MEYER APRIBOCCA	457	DILATATORE PER SENO FRONTALE RITTER-HALLE	433	DIVARICATORE COSTALE, MORSE-FAVALORO	484
DAY UNCINO	409	DILATATORE TRACHEALE, TROUSSEAU-BABY	476	DIVARICATORE COSTALE, RIEHNSOFF-FINOCHIETTO	486
DE BAKEY PINZE ATRAUMATICHE BULLDOG	103	DILATATORE TRACHEALE, TROUSSEAU	476	DIVARICATORE COSTALE, TUFFIER	487
DE BAKEY PINZE ATRAUMATICHE IN TITANIO	99	DILATATORE TUBBS	528	DIVARICATORE CUSHING	152
DE BAKEY CANNULA D'ASPIRAZIONE	28	DILATATORE UTERINO GOODELL	581	DIVARICATORE CUSHING	153
DE BAKEY DILATATORE VASCOLARE	529	DILATATORE UTERINO HANK	580	DIVARICATORE DELEE	574
DE BAKEY DIVARICATORE ADDOMINALE	189/1	DILATATORE UTERINO HEGAR	578, 579		

DIVARICATORE FINSEN	168	DIVARICATORE, COOLEY.....	148	DOYEN PINZA INTESTINALE	540
DIVARICATORE HARRINGTON-PEMBERTON	147	DIVARICATORE, CORYLLOS	166	DOYEN PINZA PER POLIPI UTERINI	585
DIVARICATORE KIRSCHNER.....	187	DIVARICATORE, CRILE	140	DOYEN SPECILLO SCANALATO	199
DIVARICATORE KOCHER	155	DIVARICATORE, CUSHING.....	151	DOYEN SPECOLO VAGINALE	574
DIVARICATORE KOCHER	159	DIVARICATORE, DARLING.....	178	DOYEN TIRAMIOMI.....	594
DIVARICATORE KOCHER	160	DIVARICATORE, DAVIDSON (SCAPULA).....	166	DOYEN-BABY PINZA INTESTINALE	540
DIVARICATORE KOCHER	163	DIVARICATORE, DEAYER.....	145	DOYEN-JANSEN(MOLT) APRIBOCCA.....	454
DIVARICATORE KÖNIG	153	DIVARICATORE, DEAYER GRIP	146	DOYEN-JANSEN(MOLT) APRIBOCCA.....	454
DIVARICATORE LANGENBECK	158	DIVARICATORE, DESMARRRES	151	DOYEN-STILLE	167
DIVARICATORE LANGENBECK	159	DIVARICATORE, DINGMANN.....	463	DUBOIS FORBICI GINECOLOGICHE.....	63
DIVARICATORE MARTIN.....	175/1	DIVARICATORE, DOYEN.....	163	DUPLAY PINZA PER ABBASSARE IL COLLO	
DIVARICATORE MAYO-ADAMS	171	DIVARICATORE, DOYEN-STILLE	167	DELL'UTERO	582
DIVARICATORE MEYERDING	157	DIVARICATORE, FARABEU.....	139	DUPLAY PINZA PER MEDICATURA	134
DIVARICATORE MEYERDING	177	DIVARICATORE, FRITSCH	163	DUPLEX STETOSCOPIO.....	23
DIVARICATORE MURPHY	156	DIVARICATORE, GIL-VERNET	152	DUPUY-WEISS AGO PER TONSILLE	466
DIVARICATORE NORFOLK-NORDWICH	172	DIVARICATORE, GOELET	141	DURA DISSETTORE.....	332
DIVARICATORE OBWEGESER.....	460, 461	DIVARICATORE, GREEN	160	DURA DISSETTORE, DAVIS.....	332
DIVARICATORE PELVICO, ST.MARKS.....	165	DIVARICATORE, HARRINGTON.....	147	DURA DISSETTORE, FRAZIER	333
DIVARICATORE PER CHIRURGIA PLASTICA BREAST	198	DIVARICATORE, HEANEY.....	164	DURA DISSETTORE, HOEN.....	333
DIVARICATORE PER CHIRURGIA PLASTICA CORONAL		DIVARICATORE, HENLEY	170	DURA DISSETTORE, HORSLEY	333
BLOW	198	DIVARICATORE, HIBBS	164	DURA DISSETTORE, MILLIGAN	332
DIVARICATORE PER CHIRURGIA PLASTICA FERRIERA	197	DIVARICATORE, HOESEL	167	DURA DISSETTORE, OLIVECRONA	332
DIVARICATORE PER CHIRURGIA PLASTICA FREEMAN	198	DIVARICATORE, HOFER.....	465	DURA DISSETTORE, SACHS	332
DIVARICATORE PER CHIRURGIA PLASTICA TEBBETS	197	DIVARICATORE, HOLZHEIMER.....	168	DURA DISSETTORE, TOENNIS	332
DIVARICATORE PER CHIRURGIA PLASTICA		DIVARICATORE, ISRAEL	162	DURA DISSETTORE, WOODSON	333
YANCOSKIE	198	DIVARICATORE, JANSEN	168	DURANTE PINZA DA PRESA.....	88
DIVARICATORE PER CORPI VERTREBRALI, CLOWARD	339	DIVARICATORE, KELLY	164	DUVAL PINZA DA PRESA.....	85
DIVARICATORE PER CORPI VERTREBRALI, INGE	339	DIVARICATORE, KELLY GRIP	142	DUVAL PINZA PER AFFERRARE INTESTINI	539
DIVARICATORE PER GESSI REDA	232	DIVARICATORE, KOCHER-LANGENBECK.....	159		
DIVARICATORE PER GESSI, BEESON	232	DIVARICATORE, KOERTE	162		
DIVARICATORE PER GESSI, HAGLUND-STILLE	232	DIVARICATORE, LAHEY	157		
DIVARICATORE PER GESSI, HENNING.....	232	DIVARICATORE, LITTLE	157		
DIVARICATORE PER GUANCE, STERNBERG.....	453	DIVARICATORE, LOVE	465		
DIVARICATORE PER LA PROSTATA, YOUNG	550	DIVARICATORE, MATHIEU.....	141		
DIVARICATORE PER LABBRA	453	DIVARICATORE, MEYERDING	180		
DIVARICATORE PER LAMINECTOMIA SCOVILLE	196	DIVARICATORE, MIDDELDORPF	160		
DIVARICATORE PER LAMINECTOMIA		DIVARICATORE, MIKULICZ	163		
SCOVILLE-HAVERFIELD	196	DIVARICATORE, MOLLISON	171		
DIVARICATORE PER LAMINECTOMIA, CHERRY	488	DIVARICATORE, MORRIS	164		
DIVARICATORE PER SPINA CERVICALE CASPAR	179	DIVARICATORE, NAGER	465		
DIVARICATORE PER SPINA CERVICALE CASPAR	180	DIVARICATORE, OLLIER	162		
DIVARICATORE PER TIROIDE, SCHOENBORN	479	DIVARICATORE, PARKER	139		
DIVARICATORE PER TORACE, MERCEDES	489	DIVARICATORE, PLESTER.....	171		
DIVARICATORE PERKINS	168	DIVARICATORE, RAGNELL	140		
DIVARICATORE ROSE	140	DIVARICATORE, RAMUS	461		
DIVARICATORE SAUERBRUCH.....	164	DIVARICATORE, RICHARDSON	142		
DIVARICATORE SAUERBRUCH.....	166	DIVARICATORE, RICHARDSON GRIP	142		
DIVARICATORE SCALP-CONTOUR	169	DIVARICATORE, RICHARDSON-EASTMAN	142		
DIVARICATORE SPINALE, TAYLOR	291	DIVARICATORE, ROUX	139		
DIVARICATORE STRANDELL-STILLE	157	DIVARICATORE, ROUX-BABY	140		
DIVARICATORE TESSIER.....	463/3	DIVARICATORE, ROUX-MINI	140		
DIVARICATORE TRACHEALE	476	DIVARICATORE, SENN-GREEN	153		
DIVARICATORE TRACHEALE, ITERSON.....	477	DIVARICATORE, SENN-MILLER	143		
DIVARICATORE TRACHEALE, JACKSON.....	476	DIVARICATORE, SIMON.....	164		
DIVARICATORE TRACHEALE, NEWS	477	DIVARICATORE, SPINA-NASALIS	461		
DIVARICATORE TRAVERS	172	DIVARICATORE, VOLKMANN	153		
DIVARICATORE TUFFIER.....	147	DIVARICATORE, VOLKMANN	154		
DIVARICATORE VESCICALE, LEGUE	553	DIVARICATORE, WEITLANER	169		
DIVARICATORE VESCICALE, MILLIN	552	DIVARICATORE, WEITLANER-WULLSTEIN.....	169		
DIVARICATORE VESCICALE, MILLIN	553	DIVARICATORE, ZENKER	161		
DIVARICATORE VESCICALE, THOMSON-WALKER.....	552	DIVARICATORE, US-ARMY PARKER-LANG.....	141		
DIVARICATORE VESCICALE, JUDD-MASSON	552	DIVISORE PER CRANIO	267		
DIVARICATORE VOLKMANN	156	DIX SGORBIA PER CORPI ESTRANEI	374		
DIVARICATORE WULLSTEIN	171	DIX STRUMENTI PER CORPI ESTRANEI	380		
DIVARICATORE, ADSON	173	DOUGHTY ABBASSALINGUA	458		
DIVARICATORE, ALM.....	168	DOUGLAS COLTELLO PER TONSILLE	466		
DIVARICATORE, ANDERSON-ADSON.....	172	DOUGLAS PINZA DEPILATORIA	395		
DIVARICATORE, BECKMANN.....	176	DOYEN DIVARICATORE	163		
DIVARICATORE, BECKMANN-ADSON	175	DOYEN DIVARICATORE ADDOMINALE	189/1		
DIVARICATORE, BECKMANN-EATON	176	DOYEN FORBICI GINECOLOGICHE	63		
DIVARICATORE, BRUNNER	167	DOYEN PERIOSTOTOMO	278		
DIVARICATORE, CLOWARD	178	DOYEN PERIOSTOTOMO	278		
DIVARICATORE, COLLIN HARTMANN	141	DOYEN PINZA FISSATELI.....	133		

ELEVATORE QUERVAIN.....	275	FISCH UNCINO.....	335	FORBICI PER DISSEZIONE, LEXER.....	53
ELEVATORE SEBILEAU.....	275	FISCH DISSETTORE.....	420	FORBICI PER DISSEZIONE, LEXER-BABY.....	53
ELEVATORE, ALDERDYCE.....	282	FISCHER PINZA PER IRIDE.....	384	FORBICI PER DISSEZIONE, LEXER-BABY TC.....	53
ELEVATORE, BOIES.....	277	FISH SPECILLO.....	199	FORBICI PER DISSEZIONE, MAYO-NOBLE.....	52
ELEVATORE, CREGO.....	282	FISHER COLTELLO PER TONSILLE.....	466	FORBICI PER DISSEZIONE, METZENBAUM.....	53/1
ELEVATORE, FREER.....	434	FOERSTER PINZA PER IRIDE.....	383	FORBICI PER DISSEZIONE, METZENBAUM FINO.....	53/1
ELEVATORE, KEY.....	282	FOERSTER PINZA PER MEDICATURA.....	136	FORBICI PER DISSEZIONE, METZENBAUM TC.....	53/1
ELEVATORE, LEMPERT.....	420	FOMON FORBICI NASALI.....	58	FORBICI PER DISSEZIONE, TOENNIS-ADSON.....	65
ELEVATORE, MCDONALD, 19CM.....	283	FOMON FORBICI PER RINOPLASTICA.....	65/1	FORBICI PER DISSEZIONE, WELLER.....	53/2
ELEVATORE, MURPHY-LANE.....	283	FOMON PERIOSTOTOMO.....	277	FORBICI PER DISSEZIONE, METZENBAUM FINO TC.....	53/1
ELEVATORE, SAYRE.....	281	FOMON RASPA NASALE.....	444	FORBICI PER DURAMADRE, SCHMIEDEN-TAYLOR.....	65/1
ELEVATORE, WATSON-CHEYNE.....	283	FOMON SCALPELLO PER SETTO.....	441	FORBICI PER ENTEROTOMIA.....	66
ELLIOT FORCIPE.....	602	FOMON TC RASPA NASALE.....	445	FORBICI PER EPISIOTOMIA, BRAUN-STADLER.....	64
ELLIS SGORBIA PER CORPI ESTRANEI.....	374	FOMON UNCINO PER LA PELLE.....	447/1	FORBICI PER EPISIOTOMIA, WALDMANN.....	64
ELSCHING DISSETTORE CORNEALE.....	373	FORBICE PER IL SETTO NASALE, KILLIAN.....	471	FORBICI PER FILO DI METALLO E LAMIERA, UNIVERSAL.....	67
ELSCHING SPATOLA PER CICLODIALISI.....	379	FORBICE PER LE UNGHIE.....	609	FORBICI PER INCISIONE.....	52
ELSCHNIG PINZA CAPSULARE.....	391	FORBICE PER PELLE.....	610	FORBICI PER ISTERECTOMIA, WERTHEIM.....	63
ELSCHNIG PINZA FISSATRICE.....	389	FORBICI BULLDOG COTTLE.....	56	FORBICI PER LEGATURE, HEATH.....	66
EMMETT UNCINO PER FISTOLE.....	594	FORBICI CORNEALI, CASTROVIEJO.....	79	FORBICI PER LEGATURE, LITTAUER.....	66
ENDOSPECOLO KOGAN.....	577	FORBICI GINECOLOGICHE, DOYEN.....	63	FORBICI PER LEGATURE, NORTHBENT.....	66
ENGEL SEGA PER GESSI.....	229	FORBICI GINECOLOGICHE, DUBOIS.....	63	FORBICI PER LEGATURE, SPENCER.....	66
ENUCLATORE PER TENDINI, BRAND.....	294	FORBICI GINECOLOGICHE, SIEBOLD.....	62	FORBICI PER NEUROCHIRURGIA.....	65
ENUCLATORE PER TENDINI, BUNELL.....	292	FORBICI GINECOLOGICHE, SIMS.....	62	FORBICI PER NEUROCHIRURGIA, STRULLY.....	65
EPKER OSTEOTOMI.....	464/2	FORBICI GINGIVALI, GOLDMAN-FOX.....	67	FORBICI PER OFTALMOLOGIA.....	57
EPPENDORFFER PINZA PER BIOPSIA.....	590	FORBICI GINGIVALI, LA GRANGE.....	69	FORBICI PER OFTALMOLOGIA GRADLE.....	57
ERRICO PERFORATORE.....	299	FORBICI GINGIVALI, LOCKLIN.....	69	FORBICI PER OFTALMOLOGIA, AEBLI.....	58
ESMARCH BENDA PER COMPRESSIONE.....	297	FORBICI GINGIVALI, QUINBY.....	67	FORBICI PER OFTALMOLOGIA, STEVENS.....	58
ESMARCH COLTELLO PER GESSI.....	233	FORBICI GRAEFE.....	56	FORBICI PER PARAMETRIO.....	63
ESMARCH FORBICI PER BENDAGGI.....	69/2	FORBICI NASALI.....	429	FORBICI PER RINOPLASTICA FOMON.....	65/1
ESTENSIONE DELL'ARTICOLAZIONE.....	188	FORBICI NASALI, COTTLE.....	59	FORBICI PER STERNO SCHUMACHER.....	481
ESTRATTATORE, KUENTSCHER.....	322	FORBICI NASALI, FOMON.....	58	FORBICI PER STRABISMO.....	58
ETHICON PINZA APPLICATORE CLIPS.....	524, 525	FORBICI NASALI, HEYMANN.....	58	FORBICI PER STRABISMO.....	58
EVES SERRANODI PER TONSILLE.....	468	FORBICI OCULISTICHE WESTCOTT.....	79	FORBICI PER TONSILLE.....	59
EXACTA SFIGMOMANOMETRO.....	8	FORBICI OCULISTICHE, BARRAQUER.....	75	FORBICI PER TONSILLE, BOETTCHER.....	59
		FORBICI OCULISTICHE, NOYES.....	75	FORBICI PER TONSILLE, DEAN.....	59
F		FORBICI OCULISTICHE, VANNAS.....	79	FORBICI PER TONSILLE, GOOD.....	59
FACE LIFT FORBICI FREEMAN.....	74	FORBICI OCULISTICHE, WECKER.....	75	FORBICI PER TONSILLE, PRINCE.....	59
FACE LIFT FORBICI GORNEY.....	73	FORBICI PER BENDAGGI.....	70	FORBICI POLMONARE, CRAFTOORD.....	65/2
FACE LIFT FORBICI KAYE.....	73	FORBICI PER BENDAGGI, BERGMANN.....	69/1	FORBICI TORACALI, THOREK.....	65/2
FACE LIFT FORBICI REES.....	73	FORBICI PER BENDAGGI, BRUNS.....	70	FORBICI VASCOLARI DEBAKEY TC.....	60
FANSLER PROCTOSCOPO.....	565	FORBICI PER BENDAGGI, ESMARCH.....	69/2	FORBICI VASCOLARI, DE BAKEY.....	61
FARABEUF DIVARICATORE.....	139	FORBICI PER BENDAGGI, KNOWLES.....	70	FORBICI VASCOLARI, DIETRICH.....	60
FARABEUF PERIOSTOTOMO.....	274	FORBICI PER BENDAGGI, LISTER.....	69/1	FORBICI VASCOLARI, FAVALORO.....	61
FARABEUF TENAGLIA PER OSSA.....	243	FORBICI PER BENDAGGI, LORENZ.....	70	FORBICI VASCOLARI, KELLY.....	61
FARABEUF-COLLIN PERIOSTOTOMO.....	274	FORBICI PER BENDAGGI, REDA EXCENTER.....	69/2	FORBICI VASCOLARI, KLINCKENBERG-LOTH.....	65/2
FARABEUF-LAMBOTTE TENAGLIA PER OSSA.....	243	FORBICI PER BENDAGGI, SEUTIN.....	69/2	FORBICI VASCOLARI, POTTS-DE MARTEL.....	59
FARRELL PORTACOTONE.....	203	FORBICI PER BENDAGGI, SMITH US ARMY.....	69/1	FORBICI VASCOLARI, POTTS-SMITH.....	61
FAULKNER CURETTA.....	449	FORBICI PER BENDAGGI, UNIVERSAL.....	70	FORBICI VASCOLARI, SATINSKY.....	65/2
FAURE PINZA PER BIOPSIA.....	588	FORBICI PER CAPSULA, RESANO.....	53/2	FORBICI WAGNER.....	67
FAURE PINZA PERITONEALE.....	123	FORBICI PER CARTILAGINE, MARTIN.....	65/1	FORCIPE, BARTON.....	603
FAVALORO FORBICI VASCOLARI.....	61	FORBICI PER CARTILAGINE, MCINDOE.....	65/1	FORCIPE, BOERMA.....	604
FEHLAND PINZA INTESTINALE.....	542	FORBICI PER CHIRURGIA FINE, IRIS.....	54	FORCIPE, DE LEE.....	602
FEILCHENFELD PINZA PER SCHEGGE.....	91	FORBICI PER CHIRURGIA FINE, JOSEPH.....	54	FORCIPE, ELLIOT.....	602
FELDHEIM PINZA PER OSSA.....	249	FORBICI PER CHIRURGIA FINE, KILNER.....	54	FORCIPE, KIELLAND.....	602
FERGUSSON CUCCHIAIO PER CALCOLI BILIARI.....	533	FORBICI PER CHIRURGIA FINE, REYNOLDS.....	54	FORCIPE, KIELLAND-LUIKART.....	603
FERGUSSON FORBICI PER CHIRURGIA.....	66	FORBICI PER CHIRURGIA FINE, SANVENERO.....	54	FORCIPE, LUIKART.....	603
FERGUSSON FRAZIER CANNULA D'ASPIRAZIONE.....	337	FORBICI PER CHIRURGIA STANDARD.....	51	FORCIPE, MCLEAN.....	603
FERGUSSON PINZA EMORROIDALE.....	109	FORBICI PER CHIRURGIA, FERGUSSON.....	66	FORCIPE, MCLEAN-LUIKART.....	603
FERGUSSON TENAGLIA PER OSSA.....	243	FORBICI PER CHIRURGIA, METZENBAUM.....	54	FORCIPE, MCLEAN-TUCKER.....	603
FERRIERA DIVARICATORE PER CHIRURGIA PLASTICA.....	197	FORBICI PER CHIRURGIA, SYSTRUNK.....	66	FORCIPE, MCLEAN-TUCKER-LUIKART.....	603
FERRIS-SMITH PINZA CHIRURGICA.....	84	FORBICI PER CORDA OMBELICALE, BUSCH.....	64	FORCIPE, NAEGELE.....	602
FERRIS-SMITH PINZA TAGLIANTE PER LAMINECTOMIA.....	343	FORBICI PER CORDA OMBELICALE, MOD.USA.....	64	FORCIPE, PIPER.....	604
FERRIS-SMITH-KERRISON PINZA TAGLIANTE PER DISCHI INTERVERTEBRALI.....	344, 344/2	FORBICI PER CORDA OMBELICALE, SCHUMACHER.....	64	FORCIPE, SIMPSON.....	602
FICHOCHIETTO-BABY DIVARICATORE COSTALE.....	482	FORBICI PER CORONA, BEEBEE.....	68	FORCIPE, SIMPSON-BRAUN.....	602
FILO PER OSSA.....	314	FORBICI PER DISSEZIONE.....	52	FORCIPE, SIMPSON-LUIKART.....	603
FINOCCHIETTO DIVARICATORE COSTALE.....	482, 484	FORBICI PER DISSEZIONE DEAYER.....	52	FORCIPE, WRIGLEY.....	602
FINOCCHIETTO PINZA PER BRONCHI.....	490	FORBICI PER DISSEZIONE MAYO.....	52	FOREGGER LARINGSOCOPIO.....	29
FINOCCHIETTO DIVARICATORE COSTALE.....	484	FORBICI PER DISSEZIONE MAYO, TC.....	52	FOREGGER LARINGSOCOPIO SET.....	31
FINOCCHIETTO PORT'AGHI.....	211	FORBICI PER DISSEZIONE MAYO-STILLE.....	52	FOX CURETTA PER LUPUS.....	608
FINOCCHIETTO-BURFORD DIVARICATORE COSTALE.....	483	FORBICI PER DISSEZIONE MAYO-STILLE, TC.....	52	FRAENKEL INSERTO.....	472
FINSEN DIVARICATORE.....	168	FORBICI PER DISSEZIONE METZENBAUM.....	53/1	FRAENKEL PINZA PER POLIPI LARINGEI.....	471
		FORBICI PER DISSEZIONE, JORGENSEN.....	53	FRANCIS AGO PER CORPI ESTRANEI.....	374

FRANKLIN-SILVERMANN AGO PER BIOPSIA	206	GRAFFA PER IL CUOIO CAPELLUTO, RANEY	327	HEIFETZ SPATOLA CEREBRALE	369
FRAZIER DIVARICATORE ADDOMINALE	181	GRAHAM UNCINO PER NERVI	329	HEIMING PINZA PER CALCOLI RENALI	536
FRAZIER DURA DISSETTORE	333	GRAIG PINZA NASALE	426	HEISS PINZA EMOSTATICA	112
FRAZIER UNCINO PER LA PELLE	149	GRAVE SPECOLO VAGINALE	570	HEISTER APRIBOCCA	454
FREEMAN DIVARICATORE PER CHIRURGIA PLASTICA	198	GRAY PINZA EMOSTATICA	121	HENKE ELEVATORE PER TONSILLE	465
FREEMAN FACE LIFT FORBICI	74	GREEN DISSETTORE CORNEALE	374	HENLEY DIVARICATORE	170
FREER COLTELLO PER SETTO NASALE	434	GREEN DIVARICATORE	160	HENNIG DIVARICATORE PER GESSI	232
FREER ELEVATORE	434	GREEN PINZA FISSATRICE	390	HEPP-SCHEIDEL MICRO FORBICI	78
FREER ELEVATORE PER SETTO	437	GREEN UNCINO PER IL STRABISMO	375	HERRICK PINZA PER PUNCOLO RENALE	123
FREER SCALPELLO PER SETTO	GREEN-ARMYTAGE PINZA UTERINA PER EMOSTASI	605	HESS PINZA CAPSULARE	391
FREER UNCINO PER LA PELLE	448	GREGORY PINZA CARDIOVASCOLARE ATRAUMATICA	517	HESS PINZA PER IRIDE	384
FRENZEL ABBASSALINGUA	451	GREVEN MIKRO-PINZA AURICOLARE	414	HESS UNCION PER NERVI	329/1
FRENZEL OCCHIALI NISTAGMO	20	GROSS CUCCHIAIO AURICOLARE	409	HEYMANN PINZA PER SETTO NASALE	425
FRIEDMANN MINI PINZA SGORBIA	234	GROSS-MAIER PINZA PER MEDICATURA	134	HEYMANN FORBICI NASALI	58
FRIEDMANN SPECOLO VAGINALE	577	GRUBER SPECOLO AURICOLARE	399	HEYMANN-KNIGHT PINZA AURICOLARE	425
FRI TSCH DIVARICATORE	163	GUAINA PER VITI	325	HEYWOOD-SMITH PINZA PER EMORROIDI	567
FRYKHOLM PINZA SGORBIA	240	GUIDA CONDUTTRICE	321	HIBBS OSTEOTOMO	265
FUCHS PINZA CAPSULARE	391	GUIDA TENDINI, BUNELL	294	HIBBS DIVARICATORE	164
FUCHSIG PINZA EMOSTATICA	113	GULEN CANNULA PER ASPIRAZIONE	433/1	HIBBS SCALPELLO	265
G		GUTHRIE UNCINO PER LA PELLE	149	HIBBS SGORBIA	265
GALLAHER RASPA NASALE	446	GUYON CANDELETTA DILATATRICE	554	HILL-FERGUSON SPECOLO RETTALE	560
GASS UNCINO	376	GUYON INTRODUTTORE PER CATETERI	554	HIRSCHMAN SPATOLA PER CICLODIALISI	379
GAUSS PINZA PER IL CUOIO CAPELLUTO	605	GUYON PINZA EMOSTATICA	122	HIRSCHMANN ANOSCOPO	562
GELPI DIVARICATORE ADDOMINALE	189/1	GUYON PINZA RENALE	122	HOEN DURA DISSETTORE	333
GELPI DIVARICATORE ADDOMINALE	189/2	GUYTON-LUNDSGAARD SCLEROTOMO	373	HOESEL PORT'AGHI	213
GEMINI PINZA EMOSTATICA	115	H		HOESEL PORT'AGHI	213
GERALD PINZA ANATOMICA	86	HABERER SPATOLA ADDOMINALE E INTESTINALE	143/1	HOFER DIVARICATORE	465
GERALD PINZA CHIRURGICA	87	HAGLUND-STILLE DIVARICATORE PER GESSI	232	HOFFMANN PINZA SERRATUBI	624
GERSTER PINZA PER OSSA	250	HAIGHT DIVARICATORE COSTALE	487	HOHMANN MINI ELEVATORE PER OSSA	286
GERZOG MARTELLO	270	HAJEK MARTELLO	273	HOLINGER LARINGOSCOPIO PER OPERAZIONE	37
GHIGLIOTTINA PER TAGLIARE FILI 32CM	320	HAJEK SCALPELLO PER SETTO	442/1	HOLLINGER PORTATORE DI LUCE	37
GIERTZ-STILLE COSTOTOMO	481	HAJEK-BALLENGER ELEVATORE PER SETTO	439	HOLSHER UNCINO PER RADICI DEI NERVI	329/1
GIGLI SEGA	332	HAJEK-KOFLER PINZA SFENOIDALE	430, 431	HOLTH PINZA TAGLIANTE PER CAPSULA	380
GILL DISSETTORE CORNEALE	373	HALLE CURETTA TAGLIANTE	253	HOLZBACH PINZA PER ISTERECTOMIA	126
GILL PINZA PER IRIDE	384	HALLE ELEVATORE PER SETTO	437	HOLZBACH PINZA PER ISTERECTOMIA	126
GILL-ARRUGA PINZA CAPSULARE	390	HALSEY PORT'AGHI	208	HOLZHEIMER DIVARICATORE	168
GILL-HESS PINZA PER IRIDE	384	HALSTED-MOSQUITO PINZA EMOSTATICA	105	HOPKINS COLTELLO PER GESSI	233
GILLIES PINZA CHIRURGICA	86	HANK DILATATORE UTERINO	580	HORGAN DIVARICATORE ADDOMINALE	183
GILLIES PORT'AGHI	212	HARGIS ELEVATORE PER PERIOSTIO	463/2	HORIZON PINZA APPLICATORE CLIPS	524, 525
GILLIES UNCINO PER LA PELLE	448	HARGIS SEPERATORE PER IL CORPO		HORSLEY DURA DISSETTORE	333
GIL-VERNET DIVARICATORE	152	MANDIBOLARE	463/6	HÖSEL DIVARICATORE	167
GIUNTO DI PROLUNGAMENTO	299	HARKEN PINZA AURICOLA	503	HOUSE CANNULA D'ASPIRAZIONE	337/2
GLOVER BULLDOG PINZA ATRAUMATICA	100	HARMS, SONDA	381	HOUSE CURETTA	420
GLOVER BULLDOG PINZA ATRAUMATICA	103	HARRINGTON DIVARICATORE	147	HOWARTH ELEVATORE PER SETTO	438
GLOVER PINZA VASCOLARE	515	HARRINGTON PINZA PER BRONCHI	490	HUBER MANICO UNIVERSALE	472
GLUCK COSTOTOMO	480	HARRINGTON-PEMBERTON DIVARICATORE	147	HUDSON MANICO A T	300
GOELT DIVARICATORE	141	HARTMANN ABBASSALINGUA	452	HUDSON PERFORATORE A MANO	299
GOLDMANN-FOX FORBICI GINGIVALI	67	HARTMANN CANNULA PER IRRIGAZIONE	433	HULKA PINZA PER ABBASSARE IL COLLO	
GOMEL MICRO FORBICI	80	HARTMANN CATETERE AURICOLARE	408	DELL'UTERO	583
GOMEL MICROPINZA CHIRURGICA	96	HARTMANN DIAPASON	403	HUMBY DERMATOMO	50
GONIOMETRO PER LE DITA	25	HARTMANN PINZA PER CORPI ESTRANEI	412	HUNTER PINZA PER SCHEGGE	91
GONIOMETRO, MOELTGEN	25	HARTMANN PINZA EMOSTATICA	104	HURD DISSETTORE PER TONSILLE	465
GOOD FORBICI PER TONSILLE	59	HARTMANN PINZA PER POLIPI	424	I	
GOODELL DILATATORE UTERINO	581	HARTMANN SPECOLO AURICOLARE	399	I.U.D. PINZA DA PRESA FLESSIBILE, SERPENTINE	593
GORNEY DISSETTORE	277	HARTMANN SPECOLO NASALE	422	I.U.D. UNCINO ESTRATTORE	593
GORNEY FACE LIFT FORBICI	73	HARTMANN-HALLE SPECOLO NASALE	421	IMPATTATORE	322
GOSSET DIVARICATORE ADDOMINALE	181	HARTMANN-HOFFMANN PINZA PER CORPI		IMPATTATORE / ESTRATTORE	322
GOURDET CUCCHIAIO UTERINO	599	ESTRANEI	412	IMPATTATORE FINALE, KUENTSCHER	321
GRADLE FORBICI PER OFTALMOLOGIA	57	HARTMANN-WULLSTEIN PINZA PER CORPI		INGE DIVARICATORE PER CORPI VERTTEBRALI	339
GRADLE PINZA DEPILTORIA	395	ESTRANEI	412	INSERTO, BARACANI	472
GRAEFTE BLEFAROSTATO	370	HAUGH MIKRO-PINZA AURICOLARE	414	INSERTO, BRUENINGS	472
GRAEFTE CISTOTOMO	375	HAYES PINZA PER ANASTOMOSI DEL RETTO	545	INSERTO, CORDES	472
GRAEFTE COLTELLO LANCEOLARE	372	HEANEY PINZA PER ISTERECTOMIA	126	INSERTO, FRAENKEL	472
GRAEFTE COLTELLO LANCEOLARE	372	HEANEY PORT'AGHI	210	INSERTO, FRAENKEL	472
GRAEFTE COLTELLO PER CATARATTA	371	HEANY CURETTA PER BIOPSIA	587	INSERTO, KRAUSE	472
GRAEFTE CUCCHIAIO PER CATERATTA	377	HEANY DIVARICATORE	164	INSERTO, LANGE	472
GRAEFTE FORBICI	56	HEANY-BALLENTINE PINZA PER ISTERECTOMIA	127	INSERTO, SCHEINMANN	472
GRAEFTE PINZA DA PRESA	83	HEATH FORBICI PER LEGATURE	66	INSERTO, SCHUMACHER	472
GRAEFTE PINZA FISSATRICE	389	HEATH MARTELLO	273	INSERTO, SEIFERT	472
GRAEFTE PINZA PER IRIDE	382	HEBRA CURETTA DA CALAZIO	377	INSOFFIATORE D'ARIA, POLITZER	406
GRAEFTE UNCINO	149	HEGAR DILATATORE UTERINO	578, 579	INSOFFIATORE PER POLVERE, KABIERSKE	405
GRAEFTE UNCINO PER IL STRABISMO	375	HEGENBARTH PINZA PER AGRAFES	224	INSTRU-CARE OLIO PER STRUMENTI	634

INTRODUTTORE PER CATETERI GUYON554
IOWA AGO DI GUIDA.....206
IOWA PINZA PER ABBASSARE IL COLLO DELL'UTERO584
IRIS FORBICI54
IRIS FORBICI, KNAPP.....55
IRIS FORBICI, LITTLER.....55
IRIS SUPERCUT FORBICI72
ISRAEL DIVARICATORE.....162
ISTEROMETRO VALLEIX586
ISTEROMETRO, COLLIN586
ISTEROMETRO, MARTIN.....586
ISTEROMETRO, SIMS.....586
ITERSON DIVARICATORE TRACHEALE.....477
IVES-FANSLER ANOSCOPO562, 563
IWANSON COMPASSO.....624

J
JACKSON BURROWS DIVARICATORE ADDOMINALE...189/2
JACKSON DIVARICATORE TRACHEALE.....476
JACKSON LARINGOSCOPIO PER OPERAZIONE37
JACKSON PINZA PER AFFERRARE TENDINI DA PRESA.....292
JACKSON PINZA PER POLIPI LARINGEI.....471
JACKSON SPECOLO VAGINALE.....573
JACOBS PINZA PER ABBASSARE IL COLLO
DELL'UTERO583
JACOBSON CURETTA TAGLIENTE.....257
JACOBSON PINZA EMOSTATICA105
JACOBSON PORT'AGHI.....215
JACOBSON SONDA BOTTUNUTA.....335
JACOBSON UNCINO PER DURA MADRE.....335
JAEGER COLTELLO LANCEOLARE.....372
JAEGER PLACCA PER PALPEBRE.....371
JAMESON PINZA PER STRABISMO.....385
JAMESON UNCINO PER IL STRABISMO.....375
JANSEN CURETTA TAGLIENTE.....257
JANSEN DIVARICATORE.....168
JANSEN PINZA AURICOLARE.....424
JANSEN PINZA SGORBIA.....237
JARCHO PINZA PER ABBASSARE IL COLLO
DELL'UTERO583
JAVID PINZA PER CAROTIDE.....511
JENNINGS APRIBOCCA.....454
JENSEN CANNULA OCULISTICA394
JOBSON-HORNE PORTACOTONE.....203
JOHNS-HOPKINS BULLDOG PINZA.....104
JOHNS-HOPKINS PINZA APPLICATRICE.....104
JOHNS-HOPKINS PINZA EMOSTATICA.....120
JOHNSON PORT'AGHI.....211
JONES PINZA FISSATELI132
JORGENSEN FORBICI PER DISSEZIONE.....53
JOSEPH (LEWIS) RASPA NASALE.....443
JOSEPH COLTELLO NASALE.....434
JOSEPH ELEVATORE PER SETTO.....437
JOSEPH FORBICI PER CHIRURGIA.....54
JOSEPH PERIOTOTOMO.....277
JOSEPH RASPA NASALE.....443
JOSEPH SEGA NASALE.....446
JOSEPH UNCINO PER LA PELLE.....149
JUDD-ALLIS PINZA PER AFFERRARE INTESTINI.....538
JUDD-MASSON DIVARICATORE VESCICALE.....552
JUERS MIKRO-PINZA AURICOLARE.....414
JURASZ PINZA PER POLIPI LARINGEI.....471

K
KABIERSKE INSOFFIATORE PER POLVERE.....405
KADER SPATOLA ADDOMINALE ED INTESTINALE143/1
KALLMORGEN SPECOLO VAGINALE.....573
KALT PINZA CAPSULARE.....391
KALT, PORT'AGHI,214
KALT-ARRUGA PORT'AGHI.....214
KANE PINZA OMBELICALE.....605
KANTROWITZ PINZA EMOSTATICA.....119/1
KAYE FACE LIFT FORBICI.....73

KEINSASSER LARINGOSCOPIO PER OPERAZIONE.....35
KEITH AGO.....223
KELLY DIVARICATORE.....164
KELLY FORBICI VASCOLARI.....61
KELLY GRIP DIVARICATORE.....142
KELLY PINZA EMOSTATICA.....106
KELLY PINZA PER POLIPI UTERINI.....585
KELLY PROCTOSCOPIO.....562, 563
KELLY-RANKIN PINZA EMOSTATICA.....106
KERN TENAGLIA PER OSSA.....244
KERRISON PINZA TAGLIENTE NASALE.....428
KEVORKIAN CURETTA PER BIOPSIA.....587
KEVORKIAN PINZA PER BIOPSIA.....589
KEVORKIAN-PACIFIC PINZA PER BIOPSIA.....592
KEY ELEVATORE.....282
KEYES TREFINA CUTANEA.....608
KIELLAND FORCIPE.....602
KIELLAND-LUIKART FORCIPE.....603
KILLIAN PER IRRIGAZIONE.....433, 433/1
KILLIAN CANNULA PER IRRIGAZIONE.....433, 433/1
KILLIAN FORBICE PER IL SETTO NASALE.....471
KILLIAN SGORBIA.....442/1
KILLIAN SPECOLO NASALE.....423
KILLIAN-CLAUS SGORBIA PER SETTO.....442/1
KILNER FORBICI PER CHIRURGIA.....54
KILNER PORT'AGHI.....212
KILNER SUPERCUT FORBICI.....72
KILNER UNCINO NASALE.....447/1
KILNER UNCINO PER LA PELLE.....608
KILNER-DOUGHTY APRIBOCCA.....456
KIRBY-ARTHUR PINZA PER IRIDE.....385
KIRK MARTELLO.....270
KIRSCHNER ARCO PER ESTENSIONE.....312
KIRSCHNER DIVARICATORE ADDOMINALE.....185
KIRSCHNER DIVARICATORE ADDOMINALE.....187
KIRSCHNER DIVARICATORE ADDOMINALE
COMPLETO.....187/1
KIRSCHNER PERFORATORE A MANO.....299
KIRSCHNER PERFORATORI FILIFORME.....306, 307
KIRSCHNER SPECILLO DI GUIDA SCANALATO.....221
KIRSCHNER US ARCO PER ESTENSIONE.....312
KIRSCHNER TELAIO PIEGABILE.....187
KIT PER AUTOPSIA IN ASTUCCIO DI LEGNO.....269
KLAPP DIVARICATORE.....150
KLEINERT-KUTZ PINZA PER AFFERRARE TENDINI.....294
KLEINERT-KUTZ PINZA SGORBIA.....237
KLEINERT-KUTZ UNCINO PER LA PELLE.....149
KLEINSASSER BRACCIO PORTALARINGOSCOPIO
STERNALE.....36
KLEINSASSER CANNULA D'INIEZIONE.....36
KLEINSASSER CANNULA D'ASPIRAZIONE.....36
KLEINSASSER PORTATORE DI LUCE FREDDA A FIBRE
DI VETRO.....36
KLEINSCHMIDT PINZA PER APPENDICE.....544
KLINKENBERGH-LOTH.....65/2
KNAPP COLTELLO PER IRIDE.....372
KNAPP CUCCHIAIO PER CATERATTA.....378
KNAPP IRIS FORBICI.....55
KNAPP UNCINO DIVARICATORE.....375
KNAPP-LUER PINZA PER TRACOMA.....393
KNIGHT PINZA PER SETTO NASALE.....425
KNOWLES FORBICI PER BENDAGGI.....70
KOCHER DIVARICATORE.....155
KOCHER DIVARICATORE.....159
KOCHER DIVARICATORE.....160
KOCHER DIVARICATORE.....163
KOCHER PINZA EMOSTATICA.....108
KOCHER PINZA INTESTINALE.....540
KOCHER SONDA PER GOZZO.....479
KOCHER SPATOLA VESCICALE.....552
KOCHER-LANGENBECK DIVARICATORE.....159
KOENIG AGO.....223
KOERTE DIVARICATORE.....162

KOGAN ENDOSPECOLO.....577
KÖNIG DIVARICATORE.....153
KÖNIG ELEVATORE PER OSSA.....284
KÖNIG PERIOTOTOMO.....276
KÖNIG SPECILLO DI GUIDA SCANALATO.....221
KOOS COLTELLO PER DURA MADRE.....335
KÖRTE SPATOLA ADDOMINALE ED INTESTINALE143/1
KRAUSE INSERTO.....471
KRAUSE SERRANODI.....412
KRAUSE SERRANODI.....433/2
KRAUSE-VOSS SERRANODI.....433/2
KRAYENBÜHL UNCINO PER NERVI.....336
KRISTELLER SPECOLO VAGINALE.....572
KROENIG ABBASSALINGUA.....451
KRONECKER AGO PER LEGATURE.....219
KUGLEN UNCINO.....376
KUHNIT RASCHIATOIO CORNEALE.....373
KÜMMEL SPATOLA ADDOMINALE.....144
KÜMMEL SPATOLA ADDOMINALE E INTESTINALE143/2
KÜNTSCHER ALESATORE PER FEMORE.....321
KÜNTSCHER ALESATORE PER L'APERTURA
DEL MIDOLLO.....321
KÜNTSCHER ESTRATTATORE.....322
KÜNTSCHER IMPATTATORE FINALE.....321

L
LA FORCE AGO PER CORPI ESTRANEI.....374
LA FORCE COLTELLO ADENOIDE.....450
LA GRANGE FORBICI GINGIVALI.....69
LABORDE DILATATORE TRACHEALE.....476
LACRIMAL CANNULA OCULISTICA394
LAHEY DIVARICATORE.....157
LAHEY PINZA EMOSTATICA.....119/2
LAHEY PINZA PER GOZZO.....479
LAHEY UNCINO ACUTO.....149
LAMA DI RASOIO.....45
LAMA DI RICAMBIO.....49
LAMA DI RICAMBIO, STERILE.....50
LAMA PER OSTEOTOMI.....266
LAMA PER SCALPELLI.....266
LAMBERT PINZA PER CALAZIO.....393
LAMBERT-KAY PINZA PER ANASTOMOSI.....505
LAMBERT-LOWMAN PINZA PER OSSA.....249
LAMBOTTE OSTEOTOMO.....261
LAMBOTTE TENAGLIA PER OSSA.....244
LAME PER BISTURI, STERILI.....42
LAME PER BISTURI, STERILI.....42
LAMPADA FRONTALE, CLAR.....22
LANCASTER BLEFAROSTATO.....371
LANDAU SPECOLO VAGINALE.....577
LANDOLT PINZA DA PRESA PER TUMORI.....341
LANE CACCIAVITE.....323, 324
LANE ELEVATORE PER OSSA.....290
LANE PIEGAPLACCHE.....325
LANE PINZA CHIRURGICA.....84
LANE PINZA FISSATELI.....133
LANE PINZA PORTAPLACCHE.....325
LANE PINZA PORTAVITI.....325
LANE PINZA STOMACALE.....547
LANE TENAGLIA PER OSSA.....244
LANE TRETOWAN ELEVATORE PER OSSA.....290
LANG DISSETTORE PER SACCO LACRIMALE.....378
LANGE INSERTO.....472
LANGE UNCINO PER LE PINNE NASALI.....448
LANGE-HOHMANN ELEVATORE PER OSSA.....286
LANGENBECK ANSA AURICOLARE.....409
LANGENBECK COLTELLO PER AMPUTAZIONE.....44
LANGENBECK COLTELLO PER CARTILAGINI.....47
LANGENBECK DIVARICATORE.....158
LANGENBECK DIVARICATORE.....159
LANGENBECK PERIOTOTOMO.....275
LANGENBECK PORT'AGHI.....213
LANGENBECK SEGA PER DITA.....296

LANGENBECK TENAGLIA PER OSSA	243	LOWMAN-HOGLUND PINZA PER OSSA	249	MATHIEU PINZA PER CORPI ESTRANEI	553/1
LANGENBECK-GREEN DIVARICATORE	153	LUBET-BARBON PINZA NASALE PER TAMPONI	424	MATHIEU PORT'AGHI	213
LARINGOSCOPIO MC INTOSH	29	LUC PINZA PER SETTO NASALE	426	MATHIEU SPECCHIO RETTALE	560
LARINGOSCOPIO MILLER	30	LUCAE AGO PER PARACENTESI	408	MATHIEU-OLSEN PORT'AGHI	212
LARINGOSCOPIO PER OPERAZIONE KLEINSASSER	35	LUCAE DIAPASON	404	MATSON PERIOSTOTOMO	279
LARINGOSCOPIO FOREGGER	29	LUCAE MARTELLO	271	MATSON-ALEXANDER PERIOSTOTOMO	279
LARSEN PINZA PER AFFERRARE TENDINI	292	LUCAE PINZA AURICOLARE	410	MAUNDER APRIBOCCA DI LEGNO	459
LAWRENCE PINZA EMOSTATICA	119	LUCAE UNCINO	409	MAXI GRASPER PINZA PER BIOPSIA	593
LEBSCHÉ SCALPELLO PER STERNO	267	LUER CANNULA TRACHEALE	479	MAYFIELD PINZA SGORBIA	238
LEES PINZA PER BRONCHI	504	LUER DIVARICATORE	140	MAYO ABBASSALINGUA	451
LEGATORE EMORROIDALE, MC GIVNEY	568	LUER PINZA SGORBIA	236	MAYO CUCCHIAIO PER CALCOLI BILIARI	534
LEGATORE EMORROIDALE, RUDD	568	LUER-KOERTE CUCCHIAIO PER CALCOLI BILIARI	533	MAYO FORBICI PER DISSEZIONE	52
LEGUE DIVARICATORE VESCICALE	553	LUJKART FORCIPE	603	MAYO PINZA	89
LEGUEU SPATOLA VESCICALE	552	LUJKART-BILL TRATTORE	604	MAYO SONDA PER CALCOLI BILIARI	534
LEKSELL(STILLE) PINZA SGORBIA	240	LUNDSGAARD SCLEROTOMO	373	MAYO SPILLONE PER STERILIZZAZIONE	227
LELAND-JONES PINZA VASCOLARE	494	LUNIATSCHKEK TAMPONATORE	465	MAYO SUPERCUT FORBICI	71
LEMPERT CURETTA TAGLIANTE	256			MAYO-ADAMS DIVARICATORE	171
LEMPERT ELEVATORE	420	M		MAYO-BLAKE PINZA PER CALCOLI BILIARI	531
LEMPERT PINZA SGORBIA	237	MAGILL PINZA PER INTRODUZIONE SONDE	28	MAYO-COLLINS DIVARICATORE	141
LERCHE PINZA DA PRESA	83	MAGLIA METALLICA PER ESTENSIONE	311	MAYO-COLLINS DIVARICATORE-SET	141
LERICHE PINZA EMOSTATICA	111	MALTZ (COTTE) RASPA NASALE	444	MAYO-HABERISSER PINZA TORCIFILI	319
LERICHE SPATOLA ADDOMINALE E INTESTINALE	143/2	MALTZ RASPA NASALE	443	MAYO-HEGAR PORT'AGHI	209
LESINA	304	MANICI PER LAMA BISTURI	38	MAYON-GUYON PINZA EMOSTATICA	122
LESINA, PERTHES	304	MANICI PER LAMA BISTURI	39	MAYO-NOBLE FORBICI PER DISSEZIONE	52
LESTER PINZA FISSATRICE	389	MANICI PER LAMA BISTURI	39/1	MAYO-ROBSON PINZA INTESTINALE	541
LEVA PER CORPI ESTRANEI, BUCK	412	MANICI PER LAMA BISTURI	39/2	MAYO-STILLE FORBICI PER DISSEZIONE	52
LEVA PER CORPI ESTRANEI, QUIRE	412	MANICI PER LAMA BISTURI	40	MAYO-STILLE SUPERCUT FORBICI	71
LEVA PIEGAPLACCHE, LANE	325	MANICI PER LAMA BISTURI	41	MC DONALD ELEVATORE	283
LEVINSON AGO PER CORPI ESTRANEI	374	MANICO	266	MC INDOE CESOIA PER OSSA	241
LEWIN TENAGLIA PER OSSA	246	MANICO	266	MC INTOSH LARINGOSCOPIO	29
LEXER BABY FORBICI PER DISSEZIONE	53	MANICO	300	MC INTOSH LARINGOSCOPIO SET	31
LEXER FORBICI PER DISSEZIONE	53	MANICO A BATTERIA PER LUCE CALDA	32	MC KENZIE PERFORATORE	299
LEXER MINI SGORBIA	263	MANICO A BATTERIA PER LUCE CALDA	34	MC CULLOUGH PINZA PER STRABISMO	385
LEXER OSTEOTOMO	263	MANICO A BATTERIA PER LUCE FREDDA	33	MC GEE MIKRO-PINZA AURICOLARE	414
LEYLA SISTEMA DI FISSAGGIO		MANICO A T, HUDSON	300	MC GEE UNCINO	419
.....368, 368/1, 368/2, 368/3, 368/4		MANICO CON ATTACCO RAPIDO	301	MC GIVNEY LEGATORE EMORROIDALE	568
LICHTENBERG PORT'AGHI	213	MANICO D'ASPIRAZIONE WULLSTEIN	338	MC GIVNEY PINZA EMORROIDALE	568
LICHTWITZ CANNULA	433	MANICO PER STRUMENTI MICROLARINGEI	475	MCINDOE FORBICI PER CARTILAGINE	65/1
LICHTWITZ TREQUARTO PER SENO MASCELLARE	204	MANICO UNIVERSALE, HUBER	472	MCINDOE PINZA CHIRURGICA	85
LIEBERMANN BLEFAROSTATO	371	MANO DI PIOMBO	250	MCINTYRE CANNULA OCULISTICA	394
LIMA PER OSSA	294	MARCATORE, CONNIN-AMSLER	380	MCIVOR APRIBOCCA	457
LIMA PER OSSA	612/1	MARQUARDT PINZA SGORBIA	239	MCKENY ELEVATORE PER SETTO	437
LIMETTA PER LE UNGHIE	610	MARSHIK PINZA PER TONSILLE	468	MCKENZIE PINZA POSA CLIPS	326
LISTER FORBICI PER BENDAGGI	69/1	MARTEL PINZA DA PRESA	110	MCCLEAN FORCIPE	603
LISTER SUPERCUT FORBICI	72	MARTELLO DI PERCUSSIONE, BABINSKY	24	MCCLEAN-LUIKART FORCIPE	603
LISTER(SINUS) TUPFERZA	137	MARTELLO DI PERCUSSIONE, BERLINER	24	MCCLEAN-TUCKER-LUIKART FORCIPE	603
LISTER-BURCH BLEFAROSTATO	370	MARTELLO DI PERCUSSIONE, BUCK	24	MCPHERSON PINZA PER FILO	392
LISTON CESOIA PER OSSA	241	MARTELLO DI PERCUSSIONE, TAYLOR	24	MEAD MARTELLO	271
LISTON COLTELLO PER AMPUTAZIONE	44	MARTELLO DI PERCUSSIONE, TROEMNER	24	MEAD PINZA SGORBIA	235
LITTAUER FORBICI PER LEGATURE	66	MARTELLO IN PLASTICA	271	MEEKER PINZA EMOSTATICA	119
LITTAUER PINZA AURICOLARE	411	MARTELLO, BERGMANN	272	MEHDORN CLIPS PER VASI	362
LITTAUER PINZA DEPIILATORIA	395	MARTELLO, COLLIN	270	MEHDORN PINZA POSA CLIPS	362
LITTAUER PINZA PER POLIPI	425	MARTELLO, COTTLE	273	MELLINGER BLEFAROSTATO	370
LITTLE DIVARICATORE	157	MARTELLO, GERZOG	270	MELLINGER-AXENFELD BLEFAROSTATO	370
LITTLEL IRIS FORBICI	55	MARTELLO, HAJEK	273	MENGHINI AGO PER BIOPSIA	206
LITTLEWOOD PINZA PER AFFERRARE INTESTINI	538	MARTELLO, HEATH	273	MERCEDES DIVARICATORE PER TORACE	489
LOCKHART-MUMMERY SPECILLO PER FISTOLE	200	MARTELLO, KIRK	270	MERIAM PINZA DENTALE	93
LOCKLIN FORBICE GINGIVALI	69	MARTELLO, LUCAE	271	METZENBAUM FINO TC FORBICI PER DISSEZIONE	53/1
LOCKWOOD-ALLIS PINZA PER AFFERRARE INTESTINI	538	MARTELLO, MEAD	271	METZENBAUM FORBICI PER CHIRURGIA	54
LONDON-COLLEGE PINZA DENTALE	93	MARTELLO, OMBREDANNE	273	METZENBAUM FORBICI PER DISSEZIONE	53/1
LOPEZ-REINKE DISSETTORE PER TONSILLE	465	MARTELLO, PARTSCH	271	METZENBAUM PORT'AGHI	211
LORENZ FORBICI PER BENDAGGI	70	MARTELLO, QUISLING	271	METZENBAUM SUPERCUT FORBICI	71
LORNA PINZA FISSATELI	133	MARTELLO, WILLIGER	271	METZENBAUM TC FORBICI PER DISSEZIONE	53/1
LOUTE STRUMENTO TENDIFILI	315	MARTIN DIVARICATORE	175/1	MEYERDING DIVARICATORE	157
LOVE DIVARICATORE	465	MARTIN FORBICI PER CARTILAGINE	65/1	MEYERDING DIVARICATORE	177
LOVE UNCINO PER NERVI	329/2	MARTIN ISTEROMETRO	586	MEYERDING DIVARICATORE	180
LOVE UNCINO PER RADICI DEI NERVI	330	MARTIN PELVIMETRO	605	MEYHOEFER CURETTA DA CALAZIO	377
LOVE-GRUENWALD PINZA TAGLIANTE PER		MARTIN TENAGLIA PER OSSA	246	MICHEL AGRAFES	224
LAMINECTOMIA	340	MARTINI CURETTA TAGLIANTE	257	MICHEL PINZA PER AGRAFES	224
LOVELACE PINZA EMOSTATICA	109	MASING-NEIVERT UNCINO NASALE	447/1	MICHEL SPECCHIO LARINGEO	423
LOVELACE PINZA PER AFFERRARE IL POLMONE	490	MASSON PORT'AGHI	210	MICRO FORBICI	76
LOWER PINZA EMOSTATICA	120	MASTIN PINZA MUSCOLARE	479	MICRO FORBICI	77
LOWMAN PINZA PER OSSA	249	MATHIEU DIVARICATORE	141	MICRO FORBICI	78

MICRO FORBICI AURICOLARI, BELLUCCI.....	413	MUSEUX PINZA PER ABBASSARE IL COLLO		O'SULLIVAN-O'CONNOR SPECOLO VAGINALE.....	576
MICRO FORBICI AURICOLARI, SHEA.....	413	DELL'UTERO.....	583	OTIS URETROTOMO.....	553
MICRO FORBICI, GOMEL.....	80	MYLES PINZA NASALE.....	427	OVERHOLT PINZA EMOSTATICA.....	114
MICRO FORBICI, HEPP-SCHEIDEL.....	78			OVERHOLT-BABY PINZA EMOSTATICA.....	114
MICRO FORBICINE, BELLUCCI.....	417	N		OVERHOLT-GEISENDOERFER PINZA EMOSTATICA.....	114
MICRO FRIEDMANN PINZA SGORBIA.....	234	NABATOFF SET PER VARICI IN SCATOLA DI METALLO ...	201	OVERHOLT-MIXER PINZA EMOSTATICA.....	115
MICRO PINZA AURICOLARE.....	415	NAEGELE FORCIPE.....	602		
MICRO PINZA AURICOLARE A CUCCHIAIO		NAGER AGO PER TONSILLE.....	466	P	
WULLSTEIN.....	416	NAGER DIVARICATORE.....	465	PADELLA.....	621
MICRO-HARTMANN PINZA EMOSTATICA.....	104	NEFF COLTELLO PER MENISCO.....	292	PARK BLEFAROSTATO.....	371
MICROPINZA CHIRURGICA, GOMEL.....	96	NEGUS PINZA PER TONSILLE.....	467	PARKER DIVARICATORE.....	139
MICROVASCULAR PORT'AGHI.....	210	NEGUS SUPPORTO PER PETTO.....	459	PARTSCH MARTELLO.....	271
MIDDELDORPF DIVARICATORE.....	160	NEIVERT PORT'AGHI.....	208	PARTSCH SCALPELLO.....	259
MIDDLETON-JANSEN PINZA PER SETTO NASALE.....	430	NEIVERT-ANDERSON OSTEOTOMO NASALE.....	442	PARTSCH SGORBIA.....	259
MIKRO COLTELLO FALCATO.....	475	NELATON SPECILLO SCANALATO.....	199	PASSOW PESTELLO DA TAMPONARE.....	260
MIKRO SEPERATORE.....	475	NELSON AGO PER LEGATURE.....	219	PATON DISETTORE CORNEALE.....	373
MIKRO UNCINO.....	475	NELSON STANDARD TREQUARTO.....	204	PAUFIQUE COLTELLO PER CHERATOPLASTICA.....	373
MIKRO-PINZA AURICOLARE.....	413	NELSON TREQUARTO.....	205	PAUFIQUE PINZA PER FILO.....	392
MIKRO-PINZA AURICOLARE, COS.....	414	NEONATAL PINZA VASCOLARE CASTANEDA.....	527	PAYR SCHIACCIATORE PER L'INTESTINO E LO	
MIKRO-PINZA AURICOLARE, DIETER.....	414	NEWS DIVARICATORE TRACHEALE.....	477	STOMACO.....	548
MIKRO-PINZA AURICOLARE, GREVEN.....	414	NISSEN PINZA EMOSTATICA.....	113	PAYR SPECILLO DI GUIDA SCANALATO.....	221
MIKRO-PINZA AURICOLARE, HAUGH.....	414	NORFOLK-NORWICH DIVARICATORE.....	172	PEAN PINZA DA PRESA.....	110
MIKRO-PINZA AURICOLARE, JUERS.....	414	NORTHBENT FORBICI PER LEGATURE.....	66	PEAN PINZA EMOSTATICA.....	108
MIKRO-PINZA AURICOLARE, MCGEE.....	414	NOTO PINZA PER POLIPI UTERINI.....	585	PECK-JOSEPH FACE LIFT FORBICI.....	74
MIKULICZ DIVARICATORE.....	163	NOVA, SFIGMOMANOMETRO.....	6,7	PECK-JOSEPH FACE LIFT FORBICI.....	74
MIKULICZ PINZA INTESTINALE.....	543	NOVAK CURETTA PER BIOPSIA.....	587	PEDESON SPECOLO VAGINALE.....	570
MIKULICZ PINZA PERITONEALE.....	123	NOYES FORBICI OCULISTICHE.....	75	PEENFIELD DISSETTORE.....	333
MIKULICZ-BABY PINZA PERITONEALE.....	123	NOYES PINZA PER POLIPI.....	425	PEERS PINZA FISSATELI.....	132
MILLER LARINGOSCOPIO.....	30			PEET PINZA PER SCHEGGE.....	92
MILLER RASPA NASALE.....	444	O		PEET RASPA NASALE.....	446
MILLIGAN DURA DISSETTORE.....	332	OBWEGESER AGO DI INTRODUZIONE.....	463	PELKMANN PINZA PER MEDICATURA.....	137
MILLIN DIVARICATORE VESICALE.....	552	OBWEGESER AGO DI INTRODUZIONE.....	463/3	PELVIMETRO, COLLIER.....	605
MILLIN DIVARICATORE VESICALE.....	553	OBWEGESER DIVARICATORE.....	460, 461	PELVIMETRO, COLLIN.....	605
MILLIN PINZA CAPSULARE DA PRESA.....	551	OBWEGESER OSTEOTOMO A LAMA.....	464/1	PELVIMETRO, MARTIN.....	605
MILLIN PINZA DA PRESA PER LA PROSTATA.....	551	OBWEGESER PERIOSTOTOMO.....	461, 462, 463	PENNINGTON ELEVATORE PER SETTO.....	438
MINI MANICO CON ATTACCO RAPIDO.....	301	OCCHIALI NISTAGMO FRENZEL.....	20	PENNINGTON PINZA EMOSTATICA.....	109
MINI-LAMBOTTE OSTEOTOMO.....	262	OCHSNER TREQUARTO.....	205	PERCY RETRATTORE.....	296
MINIMUS II, SFIGMOMANOMETRO.....	11	O'CONNER UNCINO PER IRIDE.....	375	PERFORATORE A MANO, BUNELL.....	299
MINIMUS III, SFIGMOMANOMETRO.....	12	OEHLER PINZA CHIRURGICA.....	81/1	PERFORATORE A MANO, HUDSON KPLT.....	299
MIXTER PINZA CURVA AD "S".....	116	OLDBERG PINZA TAGLIENTE PER LAMINECTOMIA.....	341	PERFORATORE A MANO, KIRSCHNER.....	299
MIXTER PINZA PER CALCOLI BILIARI.....	531	OLIO PER STRUMENTI INSTRU CARE.....	634	PERFORATORE A MANO, MOORE.....	298
MIXTER-BABY PINZA EMOSTATICA.....	119/1	OLIVA NASALE POLITZER.....	406	PERFORATORE A MANO, RALK.....	300
MIXTER-O'SHAUGNESSY PINZA EMOSTATICA.....	119/2	OLIVECRONA DURA DISSETTORE.....	332	PERFORATORE A MANO, STILLE.....	298
MOD. BONN PINZA PER IRIDE.....	387	OLIVECRONA PINZA SGORBIA.....	237	PERFORATORE A MANO, STILLE-SHERMAN.....	298
MOD. TÜBINGEN PINZA PER IRIDE.....	387	OLIVECRONA SEGA IN FILO D'ACCIAIO.....	332	PERFORATORE ELICOIDALE.....	302
MOD.MÜNCHEN CURETTA PER BIOPSIA.....	587	OLIVECRONA SPATOLA CEREBRALE.....	336	PERFORATORE INTRAMIDOLLARE.....	322
MOD.VIENNA SPECOLO NASALE.....	421	OLIVECRONA-TOENNIS (SCOVILLE).....	326	PERFORATORE, CRUTCHFIELD.....	327
MODELLATORE PER CHIODI, BENDER.....	322	OLIVECRONA-TOENNIS PINZA POSA CLIPS.....	326	PERFORATORE, CUSHING.....	299
MODELLO RUSSO, PINZA DA PRESA.....	85	OLLIER DIVARICATORE.....	162	PERFORATORE, ERRICO.....	299
MODELLO STRASSBURG PINZA CHIRURGICA.....	89	OLSEN-HEGAR PORT'AGHI.....	212	PERFORATORE, MC KENZIE.....	299
MOELTGEN GONIOMETRO.....	25	OMBREDANNE MARTELLO.....	273	PERFORATORE, SMELLIE.....	607
MOGEN STRUMENTO PER CIRCONCISIONE.....	556	OSTEOTOME, COTTLE.....	440	PERFORATORI FILIFORME KIRSCHNER.....	306, 307
MOLLISON DIVARICATORE.....	171	OSTEOTOMI.....	259	PERIOSTOTOMO.....	279
MOLT PERIOSTOTOMO.....	276	OSTEOTOMI.....	464	PERIOSTOTOMO MOLT.....	276
MONOPOLAR ELEKTRODEN ANSAN.....	628, 629	OSTEOTOMI EPKER.....	464/2	PERIOSTOTOMO SELDIN.....	277
MOOR CUCCHIAIO PER CALCOLI BILIARI.....	532	OSTEOTOMO A LAMA OBWEGESER.....	464/1	PERIOSTOTOMO, ADSON.....	282
MOORE PERFORATORE A MANO.....	298	OSTEOTOMO LEXER.....	263	PERIOSTOTOMO, ALEXANDER.....	276
MOORFIELD PINZA PER SUTURA.....	392	OSTEOTOMO MINI-LAMBOTTE.....	262	PERIOSTOTOMO, COBB.....	280
MORGAN PROCTOSCOPIO.....	565	OSTEOTOMO NASALE NEIVERT-ANDERSON.....	442	PERIOSTOTOMO, DINGMANN.....	463
MORITZ-SCHMIDT ABBASSALINGUA.....	452	OSTEOTOMO PER SETTO, COTTLE.....	440	PERIOSTOTOMO, DOYEN.....	278
MORRIS DIVARICATORE.....	164	OSTEOTOMO PER SETTO, FOMON.....	441	PERIOSTOTOMO, FARABEUF.....	274
MORRIS-DEBAKEY PINZA AORTA.....	506	OSTEOTOMO PER SETTO, SHEEHAN.....	441	PERIOSTOTOMO, FARABEUF-COLLIN.....	274
MORSE DIVARICATORE COSTALE.....	484	OSTEOTOMO, HIBBS.....	265	PERIOSTOTOMO, FOMON.....	277
MORSE-FAVALORO DIVARICATORE COSTALE.....	484	OSTEOTOMO, LAMBOTTE.....	261	PERIOSTOTOMO, JOSEPH.....	277
MORSETTO PER SISTEMA BRACCIO.....	189	OSTEOTOMO, SMITH-PETERSEN.....	261	PERIOSTOTOMO, KOENIG.....	276
MOYNIHAN PINZA EMOSTATICA.....	120	OSTEOTOMO, STILLE.....	260	PERIOSTOTOMO, LAMBOTTE.....	274
MOYNIHAN PINZA FISSATELI.....	133	OSTEOTOMO PER SETTO RUBIN.....	440	PERIOSTOTOMO, LANGENBECK.....	275
MOYNIHAN SONDA PER CALCOLI BILIARI.....	532	OSTROEM PINZA TAGLIENTE PER SETTO NASALE.....	430	PERIOSTOTOMO, MATSON.....	279
MUELLER BLEFAROSTATO.....	371	OSTROEM PINZA TAGLIENTE PER SETTO NASALE.....	430	PERIOSTOTOMO, MATSON-ALEXANDER.....	279
MÜLLER CLIPS PER VASI.....	364, 365	O'SULLIVAN-O'CONNOR DIVARICATORE		PERIOSTOTOMO, OBWEGESER.....	461, 462, 463
MURDOCK BLEFAROSTATO.....	370	ADDOMINALE.....	181	PERIOSTOTOMO, SEMB.....	278
MURPHY DIVARICATORE.....	156	O'SULLIVAN-O'CONNOR DIVARICATORE		PERIOSTOTOMO, WILLIGER.....	276
MURPHY-LANE ELEVATORE.....	283	ADDOMINALE.....	181	PERKINS DIVARICATORE.....	168

PERTHES LESINA.....	304	PINZA CHIRURGICA, ADSON-BROWN	82	PINZA EMOSTATICA, KELLY-RANKIN.....	106
PESTALOZZA CURETTA PER ABORTO	606	PINZA CHIRURGICA, BONNEY	88	PINZA EMOSTATICA, LAHEY	119/2
PESTELLO DA TAMPONARE, PASSOW	260	PINZA CHIRURGICA, BROPHY	84	PINZA EMOSTATICA, LAWRENCE	119
PETZ APPARECCHIATURA DI SUTURA		PINZA CHIRURGICA, CUSHING	83	PINZA EMOSTATICA, LERICHE.....	111
GASTRO-INTESTINALE	549	PINZA CHIRURGICA, FERRIS-SMITH.....	84	PINZA EMOSTATICA, LOVELACE.....	109
PHANEUF PINZA PERITONEALE	123	PINZA CHIRURGICA, GILLIES	86	PINZA EMOSTATICA, LOWER	120
PIERCE ELEVATORE PER SETTO	438	PINZA CHIRURGICA, LANE	84	PINZA EMOSTATICA, MAYO-GUYON	122
PIERCE TREQUARTO PER SENO MASCELLARE	204	PINZA CHIRURGICA, MCINDOE	85	PINZA EMOSTATICA, MEEKER	119
PIFFARD CURETTA PER LUPUS	608	PINZA CHIRURGICA, MOD.USA	81/1	PINZA EMOSTATICA, MICRO-HARTMANN.....	104
PILLING PINZA APPLICATORE CLIPS SMAL	524, 525	PINZA CHIRURGICA, OEHLER TC.....	81/1	PINZA EMOSTATICA, MIXTER	119/1
PINARD STETOSCOPIO	23	PINZA CHIRURGICA, SEMKEN	86	PINZA EMOSTATICA, MIXTER-BABY.....	119/1
PINZA PER CORPI ESTRANEI, HARTMANN	412	PINZA CHIRURGICA, STILLE	81/1	PINZA EMOSTATICA, MOYNIHAN.....	120
PINZA PER CORPI ESTRANEI, HARTMANN-HOFFMANN	412	PINZA CHIRURGICA, TAYLOR	87	PINZA EMOSTATICA, O'SHAUGNESSY	119/2
PINZA PER CORPI ESTRANEI, HARTMANN-WULLSTEIN	412	PINZA COPERCHIO REDA	615	PINZA EMOSTATICA, PENNINGTON.....	109
PINZA VASCOLARE, WANGENSTEEN.....	89	PINZA CURVA AD "S" MIXTER.....	116	PINZA EMOSTATICA, PROVIDENCE-HOSPITAL.....	106
PINZA AD ASTA TUBOLARE PER MICROCHIRURGIA.....	474	PINZA DA PRESA.....	316,317	PINZA EMOSTATICA, ROBERTS	117
PINZA ANATOMICA STANDARD	81	PINZA DA PRESA COTTELE	410	PINZA EMOSTATICA, ROCHESTER-CARMALT	109
PINZA ANATOMICA, ADSON.....	82	PINZA DA PRESA PER FILI KIRSCHNER.....	305	PINZA EMOSTATICA, ROCHESTER-OCHSNER	108
PINZA ANATOMICA, ADSON MICRO.....	82	PINZA DA PRESA PER LA PROSTATI, MILLIN.....	551	PINZA EMOSTATICA, ROCHESTER-PEAN	108
PINZA ANATOMICA, BONNEY	88	PINZA DA PRESA PER TONSILLE ABRAHAM.....	468	PINZA EMOSTATICA, RUMEL	117
PINZA ANATOMICA, BONNEY	88	PINZA DA PRESA PER TUMORI, LANDOLT	341	PINZA EMOSTATICA, SAROT	118
PINZA ANATOMICA, BROPHY	84	PINZA DA PRESA, COLLIN-DUVAL	85	PINZA EMOSTATICA, SPENCER-WELLS.....	109
PINZA ANATOMICA, CUSHING.....	83	PINZA DA PRESA, DURANTE	88	PINZA EMOSTATICA, STILLE	122
PINZA ANATOMICA, GERALD	86	PINZA DA PRESA, DUVAL	85	PINZA EMOSTATICA, TOENNIS.....	117
PINZA ANATOMICA, MCINDOE.....	85	PINZA DA PRESA, GRAEFE	83	PINZA EMOSTATICA, ZENKER	118
PINZA ANATOMICA, MOD.USA.....	81	PINZA DA PRESA, LERCHE	83	PINZA EMOSTATICA, OVERHOLT-BABY.....	114
PINZA ANATOMICA, POTTS-SMITH	81	PINZA DA PRESA, MARTEL	110	PINZA EMOSTATICA, OVERHOLT-GEISSENDÖRFER.....	114
PINZA ANATOMICA, SEMKEN	86	PINZA DA PRESA, MODELLO RUSSO	85	PINZA EMOSTATICA, OVERHOLT-MIXTER.....	115
PINZA ANATOMICA, STILLE	81	PINZA DA PRESA, PEAN.....	110	PINZA FISSATELI	133
PINZA ANATOMICA, TAYLOR.....	87	PINZA DA PRESA, PRATT.....	110	PINZA FISSATELI BALL AND SOCKET	133
PINZA ANATOMICA, TC.....	81	PINZA DA PRESA, WILLET MARTEL	110	PINZA FISSATELI, BACKHAUS	132
PINZA ANEURISMA DEBAKEY-BAHNSON	506	PINZA DENTALE LONDON-COLLEGE	93	PINZA FISSATELI, BERNHARD.....	133
PINZA AORTA DIETRICH	510	PINZA DENTALE MERIAM	93	PINZA FISSATELI, DOYEN	133
PINZA AORTA MORRIS-DEBAKEY	506	PINZA DEPILATORIA BEER	395	PINZA FISSATELI, JONES	132
PINZA ATRAUMATICA BULLDOG, DE BAKEY.....	100	PINZA DEPILATORIA, BARRAQUER	395	PINZA FISSATELI, LANE	133
PINZA ATRAUMATICA BULLDOG, GLOVER.....	100	PINZA DEPILATORIA, DOUGLAS	395	PINZA FISSATELI, LORNA	133
PINZA ATRAUMATICA IN TITANIO, DEBAKEY	99	PINZA DEPILATORIA, GRADLE	395	PINZA FISSATELI, MOYNIHAN	133
PINZA ATRAUMATICA PER NEONATI E BAMBINI	523	PINZA DEPILATORIA, LITTAUER	395	PINZA FISSATELI, PEERS.....	132
PINZA ATRAUMATICA TC DEBAKEY	99	PINZA DEPILATORIA, REDA	395	PINZA FISSATELI, PEERS.....	132
PINZA AURICOLARE, HARTMANN	411	PINZA EMORROIDALE FERGUSSON	109	PINZA FISSATELI, ROEDER.....	132
PINZA AURICOLARE, HEYMANN-KNIGHT.....	425	PINZA EMORROIDALE, MCGIVNEY.....	568	PINZA FISSATELI, SACHAEL	132
PINZA AURICOLARE, JANSEN	424	PINZA EMOSTATICA BIRKETT	116	PINZA FISSATELI, TOHOKU.....	132
PINZA AURICOLARE, LITTAUER	411	PINZA EMOSTATICA BRIDGE.....	116	PINZA FISSATRICE, BARRAQUER	390
PINZA AURICOLARE, LUCAE.....	410	PINZA EMOSTATICA COLLER-CRILE	106	PINZA FISSATRICE, CASTROVIEJO.....	390
PINZA AURICOLARE, TILLEY.....	411	PINZA EMOSTATICA DEBAKEY-MOSQUITO	509	PINZA FISSATRICE, ELSCHNIG	389
PINZA AURICOLARE, TROELTSCH.....	424	PINZA EMOSTATICA DEBAKEY-PEAN	513	PINZA FISSATRICE, GRAEFE	389
PINZA AURICOLARE, WILDE (TROELTSCH).....	410	PINZA EMOSTATICA DEBAKEY-RANKIN	512	PINZA FISSATRICE, GREEN	390
PINZA AURICOLA, HARKEN.....	503	PINZA EMOSTATICA FUCHSIG	113	PINZA FISSATRICE, LESTER.....	389
PINZA BIPOLARE.....	630, 631	PINZA EMOSTATICA KANTROWITZ	119/1	PINZA INTESTINALE BRUNNER	543
PINZA BIPOLARE A BAIONETTA.....	631, 632	PINZA EMOSTATICA KOCHER	108	PINZA INTESTINALE PER BIOPSIA, TURREL	567
PINZA CAPSULARE DA PRESA, MILLIN.....	551	PINZA EMOSTATICA NISSEN	113	PINZA INTESTINALE PER BIOPSIA, YEOMAN	566, 567
PINZA CAPSULARE, ARRUGA	391	PINZA EMOSTATICA OVERHOLT	114	PINZA INTESTINALE SCUDDER	541
PINZA CAPSULARE, CASTROVIEJO	391	PINZA EMOSTATICA PEAN.....	108	PINZA INTESTINALE, BABY-KOCHER	540
PINZA CAPSULARE, ELSCHNIG	391	PINZA EMOSTATICA WIKSTROEM	117	PINZA INTESTINALE, DOYEN	540
PINZA CAPSULARE, FUCHS.....	391	PINZA EMOSTATICA, ADSON	112	PINZA INTESTINALE, FEHLAND	542
PINZA CAPSULARE, GILL-ARRUGA	390	PINZA EMOSTATICA, ADSON-BABY	113	PINZA INTESTINALE, KOCHER.....	540
PINZA CAPSULARE, HESS	391	PINZA EMOSTATICA, BAINBRIDGE	119/2	PINZA INTESTINALE, MAYO-ROBSON.....	541
PINZA CAPSULARE, KALT	391	PINZA EMOSTATICA, BENGOLEA.....	112	PINZA INTESTINALE, MIKULIC	543
PINZA CAPSULARE, SCHWEIGGER.....	391	PINZA EMOSTATICA, CRAFOORD.....	118	PINZA INTESTINALE, RESANO	542
PINZA CAPSULARE, TERSON	391	PINZA EMOSTATICA, CRAFOORD-SELLORS.....	119	PINZA INTESTINALE, STONE-WATT	545
PINZA CARDIOVASCOLARE ATRAUMATICA	526	PINZA EMOSTATICA, CRILE	107	PINZA MAYO	89
PINZA CARDIOVASCOLARE ATRAUMATICA COOLEY	518, 519, 522	PINZA EMOSTATICA, CRILE-RANKIN	107	PINZA MODELLO STRASSBURG	89
PINZA CARDIOVASCOLARE ATRAUMATICA DERRA.....	515	PINZA EMOSTATICA, DANDY.....	109	PINZA MUSCOLARE, BERKE	389
PINZA CARDIOVASCOLARE ATRAUMATICA GREGORY.....	517	PINZA EMOSTATICA, DESJARDINS	121	PINZA MUSCOLARE, MASTIN	479
PINZA CHIRURGICA GERALD.....	87	PINZA EMOSTATICA, GEMINI	115	PINZA MUSCOLARE, PRINCE	387
PINZA CHIRURGICA POTTS SMITH	81	PINZA EMOSTATICA, GRAY	121	PINZA NASALE GRAIG	426
PINZA CHIRURGICA STANDARD	81/1	PINZA EMOSTATICA, GUYON	122	PINZA NASALE PER TAMPONI LUBET-BARBON	424
PINZA CHIRURGICA WAUGH	83	PINZA EMOSTATICA, HALSTED-MOSQUITO	105	PINZA NASALE PER TAMPONI WESTMACOTT	424
PINZA CHIRURGICA, ADSON	82	PINZA EMOSTATICA, HARTMANN	104	PINZA NASALE WEIL-BLAKESLEY	426
PINZA CHIRURGICA, ADSON MICRO	82	PINZA EMOSTATICA, HEISS.....	112	PINZA NASALE, CAPLAN	428
		PINZA EMOSTATICA, JACOBSON	105	PINZA NASALE, HARTMANN	427
		PINZA EMOSTATICA, JOHNS-HOPKINS.....	120	PINZA NASALE, MYLES	427
		PINZA EMOSTATICA, KELLY	106	PINZA NASALE, SCHMEDEN	427
				PINZA NASALE, TAKAHASHI.....	427

PINZA NASALE, WATSON-WILLIAMS.....	428	PINZA PER AGRAFES, RICHTER-HEATH	224	PINZA PER IRIDE, GRAEFEE	382
PINZA NASALE, STRUYCKEN.....	427	PINZA PER ANASTOMOSI DEL RETTO, HAYES	545	PINZA PER IRIDE, HESS	384
PINZA OMBELICALE, COLLIN.....	605	PINZA PER ANASTOMOSI, BECK	516	PINZA PER IRIDE, KIRBY-ARTHUR.....	385
PINZA OMBELICALE, KANE.....	605	PINZA PER ANASTOMOSI, BECK	520	PINZA PER IRIDE, MOD. BONN	387
PINZA PER ABBASSARE IL COLLO DELL'UTERO		PINZA PER ANASTOMOSI, COOLEY-DERRA	519	PINZA PER IRIDE, MOD. TUEBINGEN	387
CZERNY	584	PINZA PER ANASTOMOSI, DE MARTEL-WOLFSON	546	PINZA PER IRIDE, TROUTMAN	389
PINZA PER ABBASSARE IL COLLO DELL'UTERO		PINZA PER ANASTOMOSI, DEBAKEY	505	PINZA PER IRIDE, STEVENS	383
SCHRÖDER	583, 584	PINZA PER ANASTOMOSI, LAMBERT-KAY	505	PINZA PER ISTERECTOMIA SEGOND	125
PINZA PER ABBASSARE IL COLLO DELL'UTERO,		SUBRAMANIAN-MINIATURE	521	PINZA PER ISTERECTOMIA SEGOND-LANDAU	125
BARRET	582	PINZA PER AORTA, WEBER	501	PINZA PER ISTERECTOMIA, HEANEY	126
PINZA PER ABBASSARE IL COLLO DELL'UTERO,		PINZA PER AORTA, APPENDICE, ALLEN	544	PINZA PER ISTERECTOMIA, WERTHEIM	127
BRAUN	582	PINZA PER APPENDICE, KLEINSCHMIDT	544	PINZA PER ISTERECTOMIA, ROGERS	127
PINZA PER ABBASSARE IL COLLO DELL'UTERO,		PINZA PER BIOPSIA BABY BURKE	590	PINZA PER ISTERECTOMIA, WERTHEIM	124
DUPLAY	582	PINZA PER BIOPSIA BABY TISCHLER	592	PINZA PER ISTERECTOMIA, RADOLF	128
PINZA PER ABBASSARE IL COLLO DELL'UTERO,		PINZA PER BIOPSIA SCHUMACHER	588, 589	PINZA PER LACERAZIONE UNGHIE, RADOLF	297
HULKA	583	PINZA PER BIOPSIA TOWNSEND	591	PINZA PER MEDICATURA	135
PINZA PER ABBASSARE IL COLLO DELL'UTERO,		PINZA PER BIOPSIA, ALEXANDER	589	PINZA PER MEDICATURA, BRYANT	137
IOWA	584	PINZA PER BIOPSIA, BURKE	590	PINZA PER MEDICATURA, CHERON	137
PINZA PER ABBASSARE IL COLLO DELL'UTERO,		PINZA PER BIOPSIA, SCHUBERT	590	PINZA PER MEDICATURA, COLLIN	137
JACOBS	583	PINZA PER BIOPSIA, EPPENDORFER	590	PINZA PER MEDICATURA, DUPLAY	134
PINZA PER ABBASSARE IL COLLO DELL'UTERO,		PINZA PER BIOPSIA, FAURE	588	PINZA PER MEDICATURA, FOERSTER	136
JARCHO	583	PINZA PER BIOPSIA, KEVORK-PACIFIC	592	PINZA PER MEDICATURA, GROSS-MAIER	134
PINZA PER ABBASSARE IL COLLO DELL'UTERO,		PINZA PER BIOPSIA, KEVORKIAN	589	PINZA PER MEDICATURA, LISTER (SINUS)	137
MUSEUX	583	PINZA PER BIOPSIA, KEVORKIAN	591	PINZA PER MEDICATURA, PELKMANN	137
PINZA PER ABBASSARE IL COLLO DELL'UTERO,		PINZA PER BIOPSIA, MAXI GRASPER	593	PINZA PER MEDICATURA, RAMPLEY	136
PRATT	584	PINZA PER BIOPSIA, THOMAS-GAYLOR	588	PINZA PER MEDICATURA, SIMS-MAIER	134
PINZA PER ABBASSARE IL COLLO DELL'UTERO,		PINZA PER BIOPSIA, TISCHLER	591	PINZA PER MEDICATURA, ULRICH	135
SCHROEDER	583, 584	PINZA PER BIOPSIA, TISCHLER-KEVORK	592	PINZA PER MICROCHIRURGIA	94
PINZA PER ABBASSARE IL COLLO DELL'UTERO,		PINZA PER BIOPSIA, TISCHLER-MORGAN	590, 591	PINZA PER OCCLUSIONE TANGENZIALE,	
SCHROEDER (POZZI)	582	PINZA PER BIOPSIA, VAN DOREN	588	DEBAKEY-SATINSKY	502
PINZA PER ABBASSARE IL COLLO DELL'UTERO,		PINZA PER BIOPSIA, WITTFNER	589	PINZA PER OSSA LAMBERT-LOWMAN	249
SKENE	582	PINZA PER BIOPSIA, TISCHLER-MORGAN	590	PINZA PER OSSA, FELDHEIM	249
PINZA PER ABBASSARE IL COLLO DELL'UTERO,		PINZA PER BRONCHI, FINOCCHIETTO	490	PINZA PER OSSA, GERSTER	250
TEALE	583	PINZA PER BRONCHI, HARRINGTON	490	PINZA PER OSSA, LOWMAN	249
PINZA PER ABBASSARE IL COLLO DELL'UTERO,		PINZA PER BRONCHI, LEES	504	PINZA PER OSSA, LOWMAN-HOGLUND	249
STAUDE-MOORE	582	PINZA PER BRONCHI, PRICE-THOMAS	490	PINZA PER PATELLA	248
PINZA PER ABORTO, SAENGER	606	PINZA PER BRONCHI, SEMB	491	PINZA PER PEDUNCOLO RENALE, HERRICK	123
PINZA PER ABORTO, WINTER	606	PINZA PER BRONCO-ESOFAGOSCOPIA,		PINZA PER PEDUNCOLO RENALE,	
PINZA PER AFFERRARE IL POLMONE, LOVELACE	490	CHEVALIER-JACK	473	WERTHEIM-CULLEN	125
PINZA PER AFFERRARE INTESTINI DOYEN-BABY	540	PINZA PER CALAZIO, AYER	393	PINZA PER PILORO, BENSON	544
PINZA PER AFFERRARE INTESTINI		PINZA PER CALAZIO, DESMARRES	393	PINZA PER POLIPI LARINGEI FRAENKEL	471
LOCKWOOD-ALLIS	538	PINZA PER CALAZIO, LAMBERT	393	PINZA PER POLIPI LARINGEI JURASZ	471
PINZA PER AFFERRARE INTESTINI, ALLIS	537	PINZA PER CALCOLI BILIARI BLAKE	531	PINZA PER POLIPI LARINGEI, JACKSON	471
PINZA PER AFFERRARE INTESTINI, ALLIS-ADAIR	537	PINZA PER CALCOLI BILIARI DESJARDINS	531	PINZA PER POLIPI UTERINI, DOYEN	585
PINZA PER AFFERRARE INTESTINI, ALLIS-BABY	537	PINZA PER CALCOLI BILIARI MAYO-BLAKE	531	PINZA PER POLIPI UTERINI, KELLY	585
PINZA PER AFFERRARE INTESTINI, ATRAUMA	111	PINZA PER CALCOLI BILIARI MIXTER	531	PINZA PER POLIPI UTERINI, NOTO	585
PINZA PER AFFERRARE INTESTINI, BABCOCK	539	PINZA PER CALCOLI RENALI, HEIMING	536	PINZA PER POLIPI, HARTMANN	424
PINZA PER AFFERRARE INTESTINI, COLLIN	539	PINZA PER CALCOLI RENALI, RANDALL	511	PINZA PER POLIPI, LITTAUER	425
PINZA PER AFFERRARE INTESTINI, DUVAL	539	PINZA PER CAROTIDE JAVID	511	PINZA PER POLIPI, NOYES	425
PINZA PER AFFERRARE INTESTINI, JUDD-ALLIS	538	PINZA PER CATETERI COOLEY	510	PINZA PER RADDRIZZARE IL SETTO NASALE, ASCH	449
PINZA PER AFFERRARE INTESTINI, LITTLEWOOD	538	PINZA PER COARTAZIONE E ANASTOMOSI POTTS	492, 493	PINZA PER RADDRIZZARE IL SETTO NASALE,	
PINZA PER AFFERRARE INTESTINI, THOMS-ALLIS	538	PINZA PER CORPI ESTRANEI STRUEMPEL	412	WALSHAM	449
PINZA PER AFFERRARE INTESTINI, WILLIAMS	539	PINZA PER CORPI ESTRANEI, MATHIEU	553/1	PINZA PER RIFIUTI SAUERBRUCH	227
PINZA PER AFFERRARE L'UTERO, COLLIN	585	PINZA PER CRANIOTOMIA CONE	331	PINZA PER RIPOSIZIONE, ROWE	459
PINZA PER AFFERRARE L'UTERO, DARTIGUES	585	PINZA PER EMORROIDI, HEYWOOD-SMITH	567	PINZA PER ROVESCiare PALPEBRE, SNELLEN	393
PINZA PER AFFERRARE L'UTERO, SOMER	585	PINZA PER FILO, MCPHERSON	392	PINZA PER SCHEGGE	91
PINZA PER AFFERRARE TENDINI	293	PINZA PER FILO, MOD. TUEBINGEN	392	PINZA PER SCHEGGE, ARCHER	92
PINZA PER AFFERRARE TENDINI JACKSON	292	PINZA PER FILO, PAUFIQUE	392	PINZA PER SCHEGGE, CARMALT	91
PINZA PER AFFERRARE TENDINI KLEINERT-KUTZ	294	PINZA PER GOZZO, LAHEY	479	PINZA PER SCHEGGE, FELCHENFELD	91
PINZA PER AFFERRARE TENDINI, BRAND	293	PINZA PER IL CUIOIO CAPELLUTO, GAUSS	605	PINZA PER SCHEGGE, HUNTER	91
PINZA PER AFFERRARE TENDINI, CAROLL	293	PINZA PER INTRODUZIONE SONDE MAGILL	28	PINZA PER SCHEGGE, PEET	92
PINZA PER AFFERRARE TENDINI, LARSEN	292	PINZA PER IPOFISI	341	PINZA PER SCHEGGE, VIRTUS (RALK)	92
PINZA PER AFFERRARE TENDINI, STEINMANN	292	PINZA PER IPOFISI, ADSON	334	PINZA PER SETTO NASALE, BRUENINGS	425
PINZA PER AFFERRARE TESSUTI, BROWN	83	PINZA PER IRIDE BARRAQUER (COLIBRI)	384	PINZA PER SETTO NASALE, HEYMANN	425
PINZA PER AFFERRARE TESSUTI, CHAPUT	110	PINZA PER IRIDE, BARRAQUER-KATZIN	384	PINZA PER SETTO NASALE, MIDDLETON-JANSEN	430
PINZA PER AFFERRARE TESSUTI, COLLIN	110	PINZA PER IRIDE, BISHOP-HARMAN	386	PINZA PER SETTO NASALE, RUBIN	428
PINZA PER AFFERRARE TESSUTI, SINGLEY	88	PINZA PER IRIDE, BONN	387	PINZA PER SINUSCOPIA	431
PINZA PER AFFERRARE TESSUTI, TUFFIER	110	PINZA PER IRIDE, FISCHER	384	PINZA PER SETTO NASALE, STIEGLITZ	92
PINZA PER AGRAFES, CHILDE	224	PINZA PER IRIDE, FOERSTER	383	PINZA PER SETTO NASALE, BRUENINGS	425
PINZA PER AGRAFES, COLLIN	224	PINZA PER IRIDE, GILL	384	PINZA PER SETTO NASALE, HEYMANN	425
PINZA PER AGRAFES, HEGENBARTH	224	PINZA PER IRIDE, GILL-HESS	384	PINZA PER SETTO NASALE, LUC	426
PINZA PER AGRAFES, MICHEL	224			PINZA PER SETTO NASALE, MIDDLETON-JANSEN	430
PINZA PER AGRAFES, WACHENFELDT	224			PINZA PER SETTO NASALE, RUBIN	428

PINZA PER STERILIZZAZIONE, UNIVERSAL.....	227	PINZA TAGLIENTE PER DISCHI INTERVERTEBRALI, FERRIS-SMITH-KERRISON.....	344, 344/2	PORT'AGHI, DE BAKEY.....	210
PINZA PER STRABISMO, BONACCOLTO.....	385	PINZA TAGLIENTE PER LAMINECTOMIA, CLOWARD.....	342	PORT'AGHI, DERF.....	208
PINZA PER STRABISMO, DASTOOR.....	386	PINZA TAGLIENTE PER LAMINECTOMIA, OLDBERG.....	341	PORT'AGHI, FINOCCHIETTO.....	211
PINZA PER STRABISMO, JAMESON.....	385	PINZA TAGLIENTE PER LAMINECTOMIA, SCHLESINGER.....	342	PORT'AGHI, GILLIES.....	212
PINZA PER STRABISMO, MCCULLOUGH.....	385	PINZA TAGLIENTE PER LAMINECTOMIA, SPURLING.....	340	PORT'AGHI, HALSEY.....	208
PINZA PER SUTURA, CASTROVIEJO.....	392	PINZA TAGLIENTE PER LAMINECTOMIA, WAGNER.....	343	PORT'AGHI, HALSEY.....	208
PINZA PER SUTURA, MOORFIELD.....	392	PINZA TAGLIENTE PER LAMINECTOMIA, CUSHING.....	340	PORT'AGHI, HEANEY.....	210
PINZA PER SUTURA, ST. MARTIN.....	392	PINZA TAGLIENTE PER LAMINECTOMIA, FERRIS-SMITH.....	343	PORT'AGHI, HOESEL.....	213
PINZA PER TAMPONI, BOZEMANN.....	138	PINZA TAGLIENTE PER LAMINECTOMIA, LOVE-GRUENWALD.....	340	PORT'AGHI, JOHNSON.....	215
PINZA PER TAMPONI, BOZEMANN-DOUGLAS.....	138	PINZA TAGLIENTE PER SETTO NASALE, CITELLI.....	430	PORT'AGHI, JOHNSON.....	211
PINZA PER TONSILLE COLVER.....	467	PINZA TIRALINGUA, COLLIN.....	453	PORT'AGHI, KALT-ARRUGA.....	214
PINZA PER TONSILLE, BALLENGER.....	467	PINZA TIRALINGUA, YOUNG.....	453	PORT'AGHI, KILNER.....	212
PINZA PER TONSILLE, BLOHMKE.....	467	PINZA TORCIFILI, BERRY TC.....	319	PORT'AGHI, LANGENBECK.....	213
PINZA PER TONSILLE, MARSCHIK.....	468	PINZA TORCIFILI, CORWIN-HEGAR TC.....	319	PORT'AGHI, LICHTENBERG.....	213
PINZA PER TONSILLE, NEGUS.....	467	PINZA TORCIFILI, MAYO-HABERISSER TC.....	319	PORT'AGHI, MASSON.....	210
PINZA PER TONSILLE, SAWTELL.....	467	PINZA ULTRA LIGHT.....	95	PORT'AGHI, MATHIEU.....	213
PINZA PER TONSILLE, SCHNIDT.....	467	PINZA UTERINA PER EMOSTASI, GREEN-ARMYTAGE.....	605	PORT'AGHI, MATHIEU-OLSEN.....	212
PINZA PER TONSILLE, TYDING.....	467, 468	PINZA VASCOLARE BAINBRIDGE.....	495	PORT'AGHI, MAYO-HEGAR.....	209
PINZA PER TONSILLE, WHITE.....	467	PINZA VASCOLARE GLOVER.....	515	PORT'AGHI, METZENBAUM.....	211
PINZA PER TRACOMA, KNAPP-LUER.....	393	PINZA VASCOLARE, ADLERKREUTZ.....	84	PORT'AGHI, NEIVERT.....	208
PINZA PER TRAZIONE CRANIALE, CRUTCHFIELD.....	327	PINZA VASCOLARE, DIEFFENBACH.....	104	PORT'AGHI, OLSEN-HEGAR.....	212
PINZA PER TUMORI, YASARGIL.....	97	PINZA VASCOLARE, LELAND-JONES.....	494	PORT'AGHI, RYDER.....	210
PINZA PERITONEALE, FAURE.....	123	PINZA VASCOLARE, SATINSKY.....	491	PORT'AGHI, SAROT.....	211
PINZA PERITONEALE, MIKULICZ, 20CM.....	123	PINZA VASCOLARE, STILLE-BARRAYA.....	88	PORT'AGHI, STEVENS.....	214
PINZA PERITONEALE, MIKULICZ-BABY.....	123	PINZA, DAVIS.....	227	PORT'AGHI, WANGENSTEEN.....	210
PINZA PERITONEALE, PHANEUF.....	123	PINZE ATRAUMATICHE BULLDOG DE BAKEY.....	103	PORT'AGHI, WEBSTER.....	208
PINZA PORTAPLACCHE, LANE.....	325	PINZE ATRAUMATICHE BULLDOG GLOVER.....	103	PORT'AGHI, BABY-OLSEN-HEG.....	212
PINZA PORTAVITI, LANE.....	325	PINZE ATRAUMATICHE BULLDOG IN TITANIO.....	102	PORT'AGHI, STRATTE.....	212
PINZA POSA CLIPS BIEMER.....	361,363,364,366	PINZE ATRAUMATICHE, DE BAKEY.....	98	PORTATORE DI LUCE FREDDA A FIBRE DI VETRO KLEINSASSER.....	36
PINZA POSA CLIPS, MEHDORN.....	362	PINZE PER SCHEGGE.....	90	POSA CLIPS.....	357,358, 359, 360
PINZA POSA CLIPS, RANEY.....	327	PIPER FORCIPE.....	604	POSA CLIPS JOHNS-HOPKINS.....	104
PINZA RENALE GUYON.....	122	PISTOLA LAVATRICE.....	626	POSA CLIPS, MC KENZIE.....	326
PINZA SERRAPENE, STOCKMANN.....	553/1	PISTONI.....	258, 259	POSA CLIPS, SMITHWICK.....	326
PINZA SERRAPENE, STRAUSS.....	553/1	PISTONI CASPAR.....	258	POSA CLIPS, SWEET.....	326
PINZA SERRATUBI.....	129	PLACCA PER PALPEBRE JAEGER.....	371	POST MORTEM AGO.....	268
PINZA SERRATUBI, HOFFMANN.....	624	PLACCA PER STENDIPELLE.....	49	POTTS PINZA PER COARTAZIONE E ANASTOMOSI	492, 493
PINZA SERRATUBI, SIMPLEX.....	624	PLESTER CANNULA D'ASPIRAZIONE.....	338	POTTS SMITH PINZA CHIRURGICA.....	81
PINZA SERRATUBI, BÜLOW-GUNAR-HEY.....	130	PLESTER COLTELLO.....	418	POTTS-DE MARTEL FORBICI VASCOLARI.....	59
PINZA SFENOIDALE HAJEK-KOFLER.....	430, 431	PLESTER DIVARICATORE.....	171	POTTS-SMITH FORBICI VASCOLARI.....	61
PINZA SGORBIA BANE-HARTMANN.....	237	POLITZER AGO PER PARACENTESI.....	408	POTTS-SMITH PINZA ANATOMICA.....	81
PINZA SGORBIA MAYFIELD.....	238	POLITZER COLTELLO AURICOLARE.....	408	PRATT DILATATORE UTERINO.....	580
PINZA SGORBIA SMITH-PETERSEN.....	238	POLITZER INSOFFIATORE D'ARIA.....	406	PRATT PINZA DA PRESA.....	110
PINZA SGORBIA, ADSON.....	236	POLITZER OLIVA NASALE.....	406	PRATT PINZA PER ABBASSARE IL COLLO DELL'UTERO.....	584
PINZA SGORBIA, BLUMENTHAL.....	236	POLITZER SPECOLO AURICOLARE.....	399	PRATT SPECILLO PER FISTOLE.....	563
PINZA SGORBIA, BOEHLER.....	238	POMPA D'ARIA.....	295	PRATT SPECILO RETTALE.....	559
PINZA SGORBIA, CLEVELAND.....	235	POOLE CANNULA D'ASPIRAZIONE.....	27	PRECISA SFIGMOMANOMETRO.....	9
PINZA SGORBIA, ECHLIN.....	240	PORTA AGRAFES.....	326	PRICE-THOMAS PINZA PER BRONCHI.....	490
PINZA SGORBIA, FRIEDMAN-MICRO.....	234	PORTACOTONE, FARRELL.....	203	PRINCE FORBICI PER TONSILLE.....	59
PINZA SGORBIA, FRIEDMAN-MINI.....	234	PORTACOTONE, JOBSON-HORNE.....	203	PRINCE PINZA MUSCOLARE.....	387
PINZA SGORBIA, FRYKHOLM.....	240	PORTACOTONE, REDA.....	203	PROTEGGIDITA, LANGENBECK.....	311
PINZA SGORBIA, JANSEN.....	237	PORTACOTONE, TOBOLD.....	203	PROCTOSCOPO BENSAUDE.....	565
PINZA SGORBIA, KLEINERT-KUTZ.....	237	PORTACOTONE, UCKERMANN.....	203	PROCTOSCOPO MORGAN.....	565
PINZA SGORBIA, LEMPERS.....	237	PORT'AGHI BARRAQUER.....	216, 217	PROCTOSCOPO, CHELSEA-EATON.....	563
PINZA SGORBIA, LUER.....	236	PORT'AGHI CASTROVIEJO.....	216	PROCTOSCOPO, FANSLER.....	565
PINZA SGORBIA, MARQUARDT.....	239	PORT'AGHI MICROVASCULAR.....	210	PROCTOSCOPO, KELLY.....	563
PINZA SGORBIA, MEAD.....	235	PORT'AGHI, ADSON.....	211	PROVIDENCE-HOSPITAL PINZA EMOSTATICA.....	106
PINZA SGORBIA, OLIVECROWNA.....	237	PORT'AGHI, ARRUGA.....	214	PUNTE PER SPECILLI.....	201
PINZA SGORBIA, RUSKIN.....	239	PORT'AGHI, BABY-WEBSTER.....	208	PUTTI RASPA PER OSSA.....	294
PINZA SGORBIA, SAUERBRUCH.....	240	PORT'AGHI, BARRAQUER-TROUTMAN.....	216	Q QUERVAIN ELEVATORE.....	275
PINZA SGORBIA, SCAGLIETTI.....	240	PORT'AGHI, BAUMGARTNER.....	208	QUINBY FORBICI GINGIVALI.....	67
PINZA SGORBIA, SEMB.....	240	PORT'AGHI, BOYNTON.....	214	QUIRE LEVA PER CORPI ESTRANEI.....	412
PINZA SGORBIA, STELLBRINK.....	234	PORT'AGHI, BOZEMANN.....	211	QUISLING MARTELLO.....	271
PINZA SGORBIA, ZAUFBAL-JANSEN.....	238	PORT'AGHI, BROWN.....	209		
PINZA SGORBIA, LEKSELL-STILLE.....	240	PORT'AGHI, CASTROVIEJO.....	215		
PINZA SGORBIA, STILLE-LUER.....	239	PORT'AGHI, CASTROVIEJO MICRO.....	215		
PINZA SGORBIA, STILLE-RUSKIN.....	239	PORT'AGHI, COLLIER, 12,5CM.....	208		
PINZA STOMACALE LANE.....	547	PORT'AGHI, CRILE.....	213		
PINZA STRAPPAGESSI, WOLFF.....	233	PORT'AGHI, CRILE-MURRAY.....	209		
PINZA TAGLIENTE CIRCOLARE.....	432	PORT'AGHI, CRILE-WOOD TC.....	209		
PINZA TAGLIENTE NASALE, KERRISON.....	428				
PINZA TAGLIENTE PER CAPSULA, HOLTH.....	380				
PINZA TAGLIENTE PER DISCHI INTERVERTEBRALI, COLCLOUGH.....	344/1				

R			
RACCORDO DI LAVAGGIO.....	626	ROBB SPATOLA.....	530
RACHITOMO.....	267	ROBERTS PINZA EMOSTATICA.....	117
RADOLF PINZA PER LACERAZIONE UNGHIE.....	297	ROCHARD DIVARICATORE ADDOMINALE.....	186
RAGNELL DIVARICATORE.....	140	ROCHARD SUPPORTO.....	186
RALK PERFORATORE A MANO.....	300	ROCHESTER-CARMALT.....	109
RAMPLEY PINZA PER MEDICATURA.....	136	ROCHESTER-OCHSNER PINZA EMOSTATICA.....	108
RAMUS DIVARICATORE.....	461	ROCHESTER-PEAN PINZA EMOSTATICA.....	108
RANDALL CURETTA PER BIOPSIA.....	587	ROEDER PINZA FISSATELI.....	132
RANDALL PINZA PER CALCOLI RENALI.....	535	ROGER ELEVATORE PER SETTO.....	437, 438
RANEY GRAFFA PER IL CUOIO CAPELLUTO.....	327	ROGERS PINZA PER ISTERECTOMIA.....	127
RANEY PINZA POSA CLIPS.....	327	ROGGE PINZA PER STERILIZZAZIONE.....	227
RASCHIATOIO CORNEALE, KUHNIT.....	373	ROLLET SCALPELLO ESTIRPATORE.....	374
RASOIO.....	49	ROLLET UNCINO DIVARICATORE.....	375
RASPA NASALE FOMON TC.....	445	ROMPILAMETTE, CASTROVIEJO.....	45
RASPA NASALE GALLAHER.....	446	ROMPILAMETTE, REDA.....	45
RASPA NASALE MILLER.....	444	ROMPILAMETTE, TROUTMAN-CHRIS.....	45
RASPA NASALE PEET.....	446	ROSE DIVARICATORE.....	140
RASPA NASALE, FOMON.....	444	ROSEN AGO.....	419
RASPA NASALE, JOSEPH.....	443	ROSEN CANNULA D'ASPIRAZIONE.....	338
RASPA NASALE, JOSEPH (LEWIS).....	443	ROSEN COLTELLO.....	418
RASPA NASALE, MALTZ.....	443	ROSER-KOENIG APRIBOCCA.....	454
RASPA NASALE, MALTZ (COTTLE).....	444	ROTATORE PER NUCLEO BECHERT.....	379
RASPA NASALE, WIENER.....	443	ROUX MINI DIVARICATORE.....	140
RASPA PER OSSA.....	294	ROUX DIVARICATORE.....	139
RASPA PER OSSA PUTTI.....	294	ROUX-BABY DIVARICATORE.....	140
RECAMIER CURETTE UTERINI.....	597	ROWE PINZA PER RIPOSIZIONE.....	459
RECIPIENTE CILINDRICO.....	620	RUBIN OSTEOTOMO PER SETTO.....	440
REDA DIAPASON.....	403	RUBIN PINZA PER SETTO NASALE.....	428
REDA CALAMITA OCULISTICA.....	395	RUDD LEGATORE EMORROIDALE.....	568
REDA COLTELLO FALCATO.....	435	RUMEL PINZA EMOSTATICA.....	117
REDA COLTELLO PER AMPUTAZIONE.....	44	RUMEL-BELMONT TOURNIQUET.....	528
REDA CURETTA TAGLIANTE.....	256	RUSKIN PINZA SGORBIA.....	239
REDA DIVARICATORE PER GESSI.....	232	RUSKIN-LISTON CESOIA PER OSSA.....	241
REDA EXCENTER FORBICI PER BENDAGGI.....	69/2	RUSSEL-DAVIS ABBASSALINGUA.....	458
REDA PERFORATORE A MANO.....	300	RYDEL-SEIFFERT DIAPASON.....	404
REDA PINZA COPERCHIO.....	615	RYDER PORT AGHI.....	210
REDA PINZA DEPIPARATORIA.....	395		
REDA PINZA PER AFFERRARE INTESTINI.....	111	S	
REDA PORTACOTONE.....	203	SAALFELD SCHIACCIAMEDONI.....	608
REDA ROMPILAMETTE.....	45	SACHS DURA DISSETTORE.....	332
REDA SEGA TAGLIA ANELLI.....	297	SACHS UNCINO PER NERVI.....	329
REDA SONDA CONDOTTRICE A FORCHETTA.....	221	SAENGER PINZA PER ABORTO.....	606
REDA SPECOLO NASALE.....	423	SALPINGOGRAFO.SCHULTZE.....	596
REDA UNCINO PER LA PELLE.....	150	SANVENERO FORBICI PER CHIRURGIA.....	54
REDON AGO DI GUIDA.....	207	SAROT PINZA EMOSTATICA.....	118
REES FACE LIFT FORBICI.....	73	SAROT PORT AGHI.....	211
REGOLO DI METALLO.....	25	SATINSKY FORBICI VASCOLARI.....	65/2
REICHERT DEPRESSORE PER EPIGLOTTIDE.....	471	SATINSKY PINZA VASCOLARE.....	491
REILL TENAGLIA PER OSSA.....	248	SATO DISSETTORE CORNEALE.....	373
REINER COLTELLO PER GESSI.....	233	SATTERLEE SEGA PER AMPUTAZIONE.....	296
REINER SIRINGA AURICOLARE.....	406	SAUERBRUCH COSTOTOMO.....	481
RESANO PINZA INTESTINALE.....	542	SAUERBRUCH DIVARICATORE.....	164
RESANO, FORBICI PER CAPSULA.....	53/2	SAUERBRUCH DIVARICATORE.....	166
RETRATTORE, PERCY.....	296	SAUERBRUCH PINZA PER RIFIUTI.....	227
RETRATTORI INTRAORALI.....	463/1	SAUERBRUCH PINZA SGORBIA.....	240
RETRATTORI INTRAORALI.....	463/4	SAUERBRUCH-FREY COSTOTOMO.....	481
REVERDIN AGO.....	220	SAWTELL PINZA PER TONSILLE.....	467
REVERDIN SPATOLA ADDOMINALE E INTESTINALE.....	143/1	SAWYER SPECOLO RETTALE.....	560
REYNOLDS FORBICI PER CHIRURGIA.....	54	SAYRE ELEVATORE.....	281
REYNOLDS SUPERSCUT FORBICI.....	72	SCAGLIETTI PINZA SGORBIA.....	240
RIBBON SPATOLA ADDOMINALE E INTESTINALE.....	143	SCALP-CONTOUR DIVARICATORE.....	169
RICARD DIVARICATORE ADDOMINALE.....	191	SCALPELLI.....	259
RICHARDSON DIVARICATORE.....	142	SCALPELLO ESTIRPATORE, ROLLET.....	374
RICHARDSON-EASTMAN DIVARICATORE.....	142	SCALPELLO PARTSCH.....	259
RICHARDSON-GRIP DIVARICATORE.....	142	SCALPELLO PER SETTO, CINELLI.....	441
RICHNAU-HOLMGREN SPECOLO AURICOLARE.....	400	SCALPELLO PER SETTO, COTTLE.....	440
RICHTER-HEATH PINZA PER AGRAFES.....	224	SCALPELLO PER SETTO, FREER.....	439
RIENHOFF-FINOCHIETTO DIVARICATORE COSTALE.....	486	SCALPELLO PER SETTO, SILVER.....	442
RIGBY DIVARICATORE ADDOMINALE.....	189/2	SCALPELLO, ALEXANDER.....	259
RI-MINI COMBINAZIONE PER DIAGNOSTICA		SCALPELLO, BRUNETTI.....	268
CON ILLUMINAZIONE ALOGENA.....	17	SCALPELLO, HIBBS.....	265
RITTER-HALLE DILATATORE PER SENSO FRONTALE.....	433	SCALPELLO, STILLE.....	260
		SCATOLA PER STERILIZZARE AGHI.....	615
		SCATOLA PER STRUMENTI.....	616, 617, 618
		SCHAEDEL PINZA FISSATELI.....	132
		SCHAMBERG SCHIACCIAMEDONI.....	608
		SCHAEDE CURETTA TAGLIANTE.....	251
		SCHIEFE COLTELLO PER GONIOTOMIA.....	373
		SCHNEIMANN INSERTO.....	472
		SCHERBAK SPECOLO VAGINALE.....	575
		SCHIACCIAMEDONI, SAALFELD.....	608
		SCHIACCIAMEDONI, SCHAMBERG.....	608
		SCHIACCIAMEDONI, UNNA.....	608
		SCHIACCIAMEDONI, WALTON.....	608
		SCHIACCIATORE PER L'INTESTINO E LO STOMACO, PAYR.....	548
		SCHIMMELBUSCH TAMBURO.....	622
		SCHINK DERMATOMO.....	49
		SCHIOFETZ TONOMETRO.....	394/2
		SCHLESINGER PINZA TAGLIANTE PER LAMINECTOMIA.....	342
		SCHMEDEN PINZA NASALE.....	427
		SCHMID CANNULA PER IRRIGAZIONE.....	338
		SCHMIEDEN SPECILLO DI GUIDA SCANALATO.....	221
		SCHMIEDEN-DICK AGO PER LEGATURE.....	219
		SCHMIEDEN-TAYLOR FORBICI PER DURAMADRE.....	65/1
		SCHNIDT PINZA PER TONSILLE.....	467
		SCHOENBORN DIVARICATORE PER TIROIDE.....	479
		SCHRÖDER CUCCHIAIO UTERINO.....	595
		SCHROEDER(POZZI) PINZA PER ABBASSARE IL COLLO DELL'UTERO.....	582
		SCHUBERT PINZA PER BIOPSIA.....	588
		SCHUKNECHT COLTELLO.....	418
		SCHULTZE SALPINGOGRAFO.....	596
		SCHULZE-BERGAMANN SPECOLO RETTALE.....	560
		SCHUMACHER FORBICI PER STERNO.....	481
		SCHUMACHER INSERTO.....	472
		SCHUMACHER PINZA PER BIOPSIA.....	588, 589
		SCHWIGGER PINZA CAPSULARE.....	391
		SCLEROTOMO, GUYTON-LUNDSGAARD.....	373
		SCLEROTOMO, LUNDAAGD.....	373
		SCOVILLE CURETTA TAGLIANTE.....	253
		SCOVILLE DIVARICATORE PER LAMINECTOMIA.....	196
		SCOVILLE UNCINI PER RADICI DEI NERVI.....	330
		SCOVILLE VALVE.....	196
		SCOVILLE-HAVERFIELD DIVARICATORE PER LAMINECTOMIA.....	196
		SCUDDER PINZA INTESTINALE.....	541
		SEBILAU ELEVATORE.....	275
		SEDLITT PERIOTOTOMO.....	274, 275
		SEGA , GIGLI.....	332
		SEGA ELETTRICA PER GESSI.....	230
		SEGA IN FILO D'ACCIAIO, OLIVECRONA.....	332
		SEGA NASALE , JOSEPH.....	446
		SEGA OSCILLANTE PER GESSI CON ASPIRAZIONE.....	231
		SEGA PER AMPUTAZIONE BIER.....	296
		SEGA PER AMPUTAZIONE, CHARRIERE.....	296
		SEGA PER AMPUTAZIONE, SATTERLEE.....	296
		SEGA PER AUTOPSIA.....	231/1
		SEGA PER DITA, LANGENBECK.....	296
		SEGA PER GESSI, ENGEL.....	229
		SEGA TAGLIA ANELLI, REDA.....	297
		SEGA TAGLIA ANELLI, WALTON.....	297
		SEGOND BISTURI PER FIBROMI.....	594
		SEGOND PINZA PER ISTERECTOMIA.....	125
		SEGOND-LANDAU PINZA PER ISTERECTOMIA.....	125
		SEIFERT INSERTO.....	472
		SELDIN PERIOTOTOMO.....	277
		SELLHEIM CUCCHIAIO OSTETRICO.....	607
		SEMB CESOIA PER OSSA.....	242
		SEMB PERIOTOTOMO.....	278
		SEMB PINZA PER BRONCHI.....	491
		SEMB PINZA SGORBIA.....	240
		SEMB TENAGLIA PER OSSA.....	243
		SEMKEN PINZA ANATOMICA.....	86

SEMKEN PINZA CHIRURGICA.....	86	SINGLEY PINZA PER AFFERRARE TESSUTI.....	88	SPECILLO DI GUIDA SCANALATO, SCHMIEDEN.....	221
SEMM SPECILO VAGINALE.....	571	SINSKEY UNCINO.....	376	SPECILLO DI GUIDA, VIENNA.....	221
SENN-GREEN DIVARICATORE.....	153	SINUS ELEVATORE PER SETTO.....	438	SPECILLO FOGLIA MIRTE.....	199
SENN-MILLER DIVARICATORE.....	143	SIRINGA AURICOLARE.....	407	SPECILLO PER CANALE LACRIMALE BOWMAN.....	381
SEPERATORE PER IL CORPO MANDIBOLARE HARGIS.....	463/6	SIRINGA AURICOLARE, REINER.....	406	SPECILLO PER FISTOLE LOCKHART-MUMMERY.....	200
SEPERATORI SAGITTALI SMITH.....	463/5	SIRINGA PER TONSILLE.....	470	SPECILLO PER FISTOLE, PRATT.....	563
SEPTENZANGE KNIGHT.....	425	SISTEMA DI FISSAGGIO, LEYLA.....	368, 368/1, 368/2, 368/3, 368/4	SPECILLO SCANALATO.....	199
SERPENTINE PINZA PER BIOPSIA.....	593	SISTEMA RETRATTORE.....	188	SPECILLO SCANALATO, BRODIE.....	199
SERRANODI KRAUSE.....	433/2	SKENE PINZA PER ABBASSARE IL COLLO.....	582	SPECILLO SCANALATO, DOYEN.....	199
SERRANODI KRAUSE-VOSS.....	433/2	DELL'UTERO.....	582	SPECILLO SCANALATO, NELATON.....	199
SERRANODI PER TONSILLE, BRUENINGS.....	468	SLS PINZA APPLICATORE CLIPS MICRO.....	524, 525	SPECILLO, FISH.....	199
SERRANODI PER TONSILLE, EVES.....	468	SLUDER-BALLENGER TONSILLOTOMO.....	470	SPECILLO, WATSON-CHEYNE.....	199
SERRANODI RETTALE, WESTON.....	566	SMELLIE PERFORATORE.....	607	SPECILO AURICOLARE RICHNAU-HOLMGREN.....	400
SERRANODI WILDE.....	433/2	SMELLIE UNCINO.....	605	SPECILO AURICOLARE, BOUCHERON.....	399
SET LARINGOSCOPIO FOREGGER.....	31	SMELLIE COLTELLO PER MENISCO.....	292	SPECILO AURICOLARE, BRUENINGS.....	401
SET LARINGOSCOPIO MC INTOSH.....	31	SMILLIE ELEVATORE PER OSSA.....	291	SPECILO AURICOLARE, GRUBER.....	399
SET PER INFERMERIA.....	609	SMITH BLEFAROSTATO.....	370	SPECILO AURICOLARE, HARTMANN.....	399
SET PER SUTURA IN ASTUCCIO DI METALLO.....	225, 226	SMITH SEPARATORI SAGITTALI.....	463/5	SPECILO AURICOLARE, POLITZER.....	399
SET PER TRACHEOTOMIA.....	478	SMITH US ARMY FORBICI PER BENDAGGI.....	69/1	SPECILO AURICOLARE, SIEGLE.....	402
SET PER VARICI IN SCATOLA DI METALLO, NABATOFF.....	201	SMITH-BUIE DIVARICATORE ANALE.....	561	SPECILO AURICOLARE, TOYNBEE.....	399
SEUTIN FORBICI PER BENDAGGI.....	69/2	SMITH-PETERSEN OSTEOTOMO.....	261	SPECILO LATERALE.....	569
SEXTON COLTELLO AURICOLARE.....	408	SMITH-PETERSEN PINZA SGORBIA.....	238	SPECILO NASALE HARTMANN.....	422
SFIGMOMANOMETRO, BABYPHON.....	10	SMITHWICK PINZA POSA CLIPS.....	326	SPECILO NASALE REDA.....	423
SFIGMOMANOMETRO, DIPLOMAT.....	5	SMITHWICK UNCINO PER NERVI.....	329	SPECILO NASALE, COTTLE.....	423
SFIGMOMANOMETRO, EXACTA.....	8	SNELLEN ANSA PER CATERATA.....	378	SPECILO NASALE, HARTMANN-HALLE.....	421
SFIGMOMANOMETRO, MINIMUS II.....	11	SNELLEN PINZA PER ROVESCIARE PALPEBRE.....	393	SPECILO NASALE, KILLIAN.....	423
SFIGMOMANOMETRO, MINIMUS III.....	12	SOMER PINZA PER AFFERRARE L'UTERO.....	585	SPECILO NASALE, MOD.VIENNA.....	421
SFIGMOMANOMETRO, NOVA.....	6.7	SONDA BOTTUNUTA, JACOBSON.....	335	SPECILO NASALE, THUDICHUM.....	421
SFIGMOMANOMETRO, PRECISA.....	9	SONDA CONDUTTRICE A FORCHETTA.....	475	SPECILO NASALE, TIECK-HALLE.....	423
SGORBIA.....	264	SONDA CONDUTTRICE A FORCHETTA REDA.....	221	SPECILO NASALE, VOLTOLINI.....	421
SGORBIA, PARTSCH.....	259	SONDA PER CALCOLI BILIARI DESJARDINS.....	532	SPECILO RETTALE HILL-FERGUSON.....	560
SGORBIA ALEXANDER.....	259	SONDA PER CALCOLI BILIARI MOYNIHAN.....	532	SPECILO RETTALE SAWYER.....	560
SGORBIA BRÜNINGS-LUCAS.....	260	SONDA PER CALCOLI BILIARI, MAYO.....	534	SPECILO RETTALE, ALAN-PARKS.....	561
SGORBIA KILLIAN.....	442/1	SONDA PER GOZZO, KOCHER.....	479	SPECILO RETTALE, BARR.....	559
SGORBIA PER CORPI ESTRANEI, DIX.....	374	SONDA, WORST.....	381	SPECILO RETTALE, BODENHAMMER.....	559
SGORBIA PER CORPI ESTRANEI, ELLIS.....	374	SONDA, WORST.....	381	SPECILO RETTALE, CZERNY.....	559
SGORBIA PER CORPI ESTRANEI, WALTON.....	374	SPATOLA ADDOMINALE.....	144	SPECILO RETTALE, MATHIEU.....	560
SGORBIA PER SETTO FREER.....	442/1	SPATOLA ADDOMINALE E INTESTINALE LERICHE.....	143/2	SPECILO RETTALE, PRATT.....	559
SGORBIA PER SETTO, HAJEK.....	442/1	SPATOLA ADDOMINALE E INTESTINALE, HABERER.....	143/1	SPECILO RETTALE, SIMS.....	559
SGORBIA PER SETTO, KILLIAN-CLAUS.....	442/1	SPATOLA ADDOMINALE E INTESTINALE, REVERDIN.....	143/1	SPECILO RETTALE, SCHULZE-BERG.....	560
SGORBIA WEST.....	442/1	SPATOLA ADDOMINALE E INTESTINALE, RIBBON.....	143	SPECILO VAGINALE, JACKSON.....	573
SGORBIA, COBB.....	262	SPATOLA ADDOMINALE ED INTESTINALE KADER.....	143/1	SPECILO VAGINALE, AUWARD.....	576
SGORBIA, HIBBS.....	265	SPATOLA ADDOMINALE ED INTESTINALE KÖRTE.....	143/1	SPECILO VAGINALE, BREISKY.....	577
SGORBIA, LEXER MINI.....	263	SPATOLA ADDOMINALE ED INTESTINALE KÜMMEL.....	143/2	SPECILO VAGINALE, COLLIN.....	570
SGORBIA, ZIELKE.....	264	SPATOLA CEREBRALE CUSHING.....	369	SPECILO VAGINALE, CUSCO.....	570, 571
SGORBIA, STILLE.....	260	SPATOLA CEREBRALE DAVIS.....	337	SPECILO VAGINALE, DOYEN.....	574
SGORBIE.....	259	SPATOLA CEREBRALE HEIFETZ.....	369	SPECILO VAGINALE, FRIEDMANN.....	577
SHAMBAUGH UNCINO.....	419	SPATOLA CEREBRALE, CUSHING.....	336	SPECILO VAGINALE, GRAVE.....	570
SHAPLEIGH ANSA AURICOLARE.....	410	SPATOLA CEREBRALE, OLIVECRONA.....	336	SPECILO VAGINALE, KALLMORGEN.....	573
SHEA MICRO FORBICI AURICOLARI.....	413	SPATOLA PER CICLODIALISI, HIRSCHMAN.....	379	SPECILO VAGINALE, KRISTELLER.....	572
SHEEHAN OSTEOTOMO PER SETTO.....	441	SPATOLA PER CICLODIALISI, BANGERTER.....	379	SPECILO VAGINALE, LANDAU.....	577
SHEETS CANNULA PER IRRIGAZIONE.....	394/2	SPATOLA PER CICLODIALISI, ELISCHNIG.....	379	SPECILO VAGINALE, O'SULLIVAN-O'CONNOR.....	576
SIEBENMANN CANNULA PER IRRIGAZIONE.....	433	SPATOLA PER CICLODIALISI, WHEELER.....	379	SPECILO VAGINALE, PEDERSON.....	570
SIEBOLD FORBICI GINECOLOGICHE.....	62	SPATOLA PER CICLODIALISI, CASTROVIEJO.....	379	SPECILO VAGINALE, SEMM.....	571
SIEGLE SPECILO AURICOLARE.....	402	SPATOLA PER IRIDE, CULLER.....	378	SPECILO VAGINALE, SIMS.....	573
SILVER DERMATOMO.....	50	SPATOLA PER IRIDE, CULLER.....	378	SPECILO VAGINALE, TRELAT.....	571
SILVER SCALPELLO PER SETTO.....	442	SPATOLA PER IRIDE, WECKER.....	378	SPECILO VAGINALE, VU-MORE.....	569
SIMCOE CANNULA PER IRRIGAZIONE.....	394	SPATOLA PER PEDICURE.....	612	SPECILO VAGINALE, SCHERBAK.....	575
SIMON CUCCHIAIO UTERINO.....	594	SPATOLA PER POLMONE, ALLISON.....	489	SPENCER FORBICI PER LEGATURE.....	66
SIMON DIVARICATORE.....	164	SPATOLA ROBB.....	530	SPENCER-WELLS PINZA EMOSTATICA.....	109
SIMPLEX PINZA SERRATUBI.....	624	SPATOLA VESCICALE, KOCHER.....	552	SPEZZATORE UNGHIE.....	612/1
SIMPSON FORCIPE.....	602	SPATOLA VESCICALE, LEGUEU.....	552	SPILLONE PER STERILIZZAZIONE, BUNT.....	227
SIMPSON-BRAUN FORCIPE.....	602	SPAZZOLA PER UNGHIE.....	611	SPILLONE PER STERILIZZAZIONE, MAYO.....	227
SIMPSON-LUIKART FORCIPE.....	603	SPECCHIO FRONTALE ZIEGLER.....	21	SPINAL CURETTA TAGLIANTE.....	253
SIMS CURETTE UTERINI.....	597, 598	SPECCHIO LARINGEO.....	473	SPINA-NASALIS DIVARICATORE.....	461
SIMS DEPRESSORE UTERINO.....	586	SPECCHIO LARINGEO, MICHEL.....	423	SPRATT CURETTA TAGLIANTE.....	251
SIMS DILATATORE UTERINO.....	581	SPECILLO AURICALE, STACKE.....	199	SPRATT CURETTA TAGLIANTE PER LAMINECTOMIA.....	340
SIMS FORBICI GINECOLOGICHE.....	62	SPECILLO DI GUIDA SCANALATO KÖNIG.....	221	SPUTACCHIERA.....	621
SIMS ISTEROMETRO.....	586	SPECILLO DI GUIDA SCANALATO BRUNNER.....	221	ST. CLAIR-THOMSON COLTELLO ADENOIDE.....	450
SIMS SPECILO RETTALE.....	559	SPECILLO DI GUIDA SCANALATO KIRSCHNER.....	221	ST. MARKS DIVARICATORE PELVICO.....	165
SIMS SPECILO VAGINALE.....	573	SPECILLO DI GUIDA SCANALATO SCHMIEDEN-PAYR.....	221	ST. MARTIN PINZA PER SUTURA.....	392
SIMS-MAIER PINZA PER MEDICATURA.....	134	SPECILLO DI GUIDA SCANALATO, BRUNNER.....	221	STACKE SPECILO AURICALE.....	199
		SPECILLO DI GUIDA SCANALATO, PAYR.....	221	STANDARD FORBICI PER CHIRURGIA.....	51

STAUDE-MOORE PINZA PER ABBASSARE IL COLLO				TOWNSEND MANICO SOLO	591
DELL'UTERO	582			TOYNBEE SPECOLO AURICOLARE	399
STEINMANN CHIODI	307, 308			TRASFORMATORE RICARICA BATTERIA	34
STEINMANN PINZA PER AFFERRARE TENDINI	292			TRATTORE, BARTON	603
STELLBRINK PINZA SGORBIA	234			TRATTORE, BILL	604
STERNBERG DIVARICATORE PER GUANCE	453			TRATTORE, LUIKART-BILL	604
SCALPELLO PER STERNO, LEBSCH	267			TRAVERS DIVARICATORE	172
STETOSCOPIO, ANESTOPHON	23			TREFINA CUTANEA, KEYES	608
STETOSCOPIO, DUPLEX	23			TRELAT SPECOLO VAGINALE	571
STETOSCOPIO, PINARD	23			TREQUARTO PER SENO MASCELLARE, COAKLEY	204
STETOSCOPIO	23			TREQUARTO PER SENO MASCELLARE, LICHTWITZ	204
STEVENS FORBICI PER OFTALMOLOGIA	58			TREQUARTO PER SENO MASCELLARE, PIERCE	204
STEVENS PINZA PER IRIDE	383			TREQUARTO PER SINOSCOPIA	205
STEVENS PORT'AGHI	214			TREQUARTO PER SINOSCOPIA	205
STEVENS SUPERCUT FORBICI	72			TREQUARTO, NELSON	205
STEVENS UNCINO PER TENOTOMIA	375			TREQUARTO, OCHSNER	205
STEVENSON BLEFAROSTATO	371			TREQUARTO, UNIVERSAL	204
STIEGLITZ PINZA PER SCHEGGE	92			TREQUARTO, STANDARD (NELSON)	204
STILLE CESOIA PER GESSI	229			TROELTSCH PINZA AURICOLARE	424
STILLE COSTOTOMO	480			TROEMNER PERKUSSIONSMARTELLO	24
STILLE OSTEOTOMO	260			TRONCHESINA PER PELLE	610
STILLE PERFORATORE A MANO	298			TRONCHESINA PER UNGHIE	612/1, 613
STILLE PINZA ANATOMICA	81			TRONCHESINA PER UNGHIE ANVIL	613
STILLE PINZA CHIRURGICA	81/1			TRONCHESINA PER UNGHIE, TURNBULL	609
STILLE PINZA EMOSTATICA	122			TROUSSEAU DILATATORE TRACHEALE	476
STILLE SCALPELLO	260			TROUSSEAU-BABY DILATATORE TRACHEALE	476
STILLE SGORBIA	260			TROUTMAN PINZA PER IRIDE	389
STILLE-BARRAYA PINZA VASCOLARE	88			TROUTMAN-CHRIS ROMPLAMETTE	45
STILLE-HORSLEY CESOIA PER OSSA	242			TUBBS DILATATORE	528
STILLE-LISTON CESOIA PER OSSA	242			TUBINGEN PINZA PER FILO	392
STILLE-LUER PINZA SGORBIA	239			TUBO DI PROLUNGAMENTO, BRUENINGS	472
STILLE-RUSKIN PINZA SGORBIA	239			TUFFIER DIVARICATORE	147
STILLE-SHERMAN PERFORATORE A MANO	298			TUFFIER DIVARICATORE COSTALE	487
STOCKMANN PINZA SERRAPENE	553/1			TUFFIER PINZA PER AFFERRARE TESSUTI	110
STONE-WATT COMPRESSORE	545			TURNBULL TRONCHESINA PER UNGHIE	609
STRANDELL-STILLE DIVARICATORE	157			TURREL PINZA INTESTINALE PER BIOPSIA	567
STRATTE PORT'AGHI	212			TYDING PINZA PER TONSILLE	467, 468
STRAUSS PINZA SERRAPENE	553/1			TYDING TONSILLOTOMO	469
STRUJEMPEL PINZA PER CORPI ESTRANEI	412				
STRULLY FORBICI PER NEUROCHIRURGIA	65			U	
STRUMENTI PER CORPI ESTRANEI, DIX	380			UCKERMANN PORTACOTONE	203
STRUMENTO PER CIRCONCISIONE	556			ULRICH PINZA PER MEDICATURA	135
STRUMENTO PER MISURE	594			ULRICH TENAGLIA PER OSSA	248
STRUMENTO PER VARICI VARADY	202			ULTRA-LIGHT-PINZA, ATRAUMATICA	95
STRUMENTO TENDIFILI, DEMEL	315			UNCINO ACUTO LAHEY	149
STRUMENTO TENDIFILI, LOUTE	315			UNCINO DI FISSAZIONE, BURCH	373
STRUYCKEN PINZA NASALE	427			UNCINO DIVARICATORE, KNAPP	375
STUOIA IN SILICONE	616			UNCINO DIVARICATORE, ROLLET	375
SUBRAMANIAN-MINIATURE PINZA PER AORTA				UNCINO ESTRATTORE	322
PEDIATRICA	521			UNCINO ESTRATTORE, ARRUGA	375
SUPERCUT FORBICI	71			UNCINO GALEA, YASARGIL	330
SUPERCUT FORBICI IRIS	72			UNCINO GASS	376
SUPERCUT FORBICI KILNER	72			UNCINO KUGLEN	376
SUPERCUT FORBICI LISTER	72			UNCINO NASALE AUFRICHT	447
SUPERCUT FORBICI REYNOLDS	72			UNCINO NASALE CONVERSE	448
SUPERCUT FORBICI STEVENS	72			UNCINO NASALE UNCINO	447
SUPERCUT FORBICI WAGNER	72			UNCINO NASALE, COTTLE	447
SUPERCUTFORBICI MAYO	71			UNCINO NASALE, MASING-NEIVERT	447
SUPERCUTFORBICI MAYO-STILLE	71			UNCINO PER DURA MADRE, JACOBSON	335
SUPERCUTFORBICI METZENBAUM	71			UNCINO PER DURAMADRE	335
SUPERCUTFORBICI, BABY METZENBAUM	71			UNCINO PER DURAMADRE, ADSON	329
SUPPORTO PER PETTO NEGUS	459			UNCINO PER FISTOLE, EMMETT	594
SUPPORTO PER STERILIZZAZIONE FILI KIRSCHNER	305			UNCINO PER IL STRABISMO, GRAEFE	375
SUPPORTO PER TUBO	188			UNCINO PER IL STRABISMO, GREEN	375
SUPPORTO UNIVERSALE PER DIVARICATORI	188			UNCINO PER IL STRABISMO, JAMESON	375
SUPPORTO UNIVERSALE PER ENDOSCOPIO	188			UNCINO PER IRIDE, O'CONNOR	375
SUPPORTO, ROCHARD	186			UNCINO PER IRIDE, WIENER	375
SWEET PINZA POSA CLIPS	326			UNCINO PER LA PELLE, GRAEFE	149
SYSTRUNK FORBICI PER CHIRURGIA	66			UNCINO PER LA PELLE, COTTLE-NEIVERT	448
				UNCINO PER LA PELLE, FOMON	447/1
				UNCINO PER LA PELLE, FRAZIER	149
				UNCINO PER LA PELLE, FREER	448
				UNCINO PER LA PELLE, GILLIES	448
T					
TABB COLTELLO	418				
TAKAHASHI PINZA NASALE	427				
TAMBURO, SCHIMMELBUSCH	622				
TAMPONATORE, LUNIATSCHKEK	465				
TARNIER CRANIOCLASTO	607				
TARNIER FORCIPE	604				
TAYLOR - USA MARTELLO DA PERCUSSIONE	24				
TAYLOR DIVARICATORE SPINALE	291				
TAYLOR PINZA CHIRURGICA	87				
TC FORBICI PER CHIRURGIA FINE, REYNOLDS TC	54				
TC FORBICI PER CHIRURGIA STANDARD	51				
TC PINZA ANATOMICA	81				
TC PINZA CHIRURGICA	81				
TC PINZA CUSHING	83				
TC PINZA CUSHING TAYLOR	87				
TC PINZA GILLIES	86				
TC PINZA SEMKEN	86				
TC PINZA WANGENSTEEN	89				
TEALE PINZA PER ABBASSARE IL COLLO					
DELL'UTERO	583				
TEBBETS DIVARICATORE PER CHIRURGIA PLASTICA	197				
TELAIO PIEGABILE KIRSCHNER	187				
TENAGLIA PER OSSA	247				
TENAGLIA PER OSSA	249				
TENAGLIA PER OSSA BIRCHER-GANSKE	246				
TENAGLIA PER OSSA, ADSON	298				
TENAGLIA PER OSSA, LANE	246				
TENAGLIA PER OSSA, FARABEUF	243				
TENAGLIA PER OSSA, FARABEUF-L.	243				
TENAGLIA PER OSSA, FERGUSSON	243				
TENAGLIA PER OSSA, KERN	244				
TENAGLIA PER OSSA, LAMBOTTE	244				
TENAGLIA PER OSSA, LANE	244				
TENAGLIA PER OSSA, LANGENBECK	243				
TENAGLIA PER OSSA, LEWIN	246				
TENAGLIA PER OSSA, MARTIN	246				
TENAGLIA PER OSSA, REILL	248				
TENAGLIA PER OSSA, SEMB	243				
TENAGLIA PER OSSA, ULRICH	248				
TENAGLIA PER OSSA, VAN BUREN	249				
TENAGLIA PER OSSA, VERBRUGGE	245				
TENAGLIE TAGLIAFILII	317, 318				
TERSON PINZA CAPSULARE	391				
TESSIER DIVARICATORE	463/3				
THOMAS CURETTE UTERINI	599				
THOMAS-GAYLOR PINZA PER BIOPSIA	588				
THOMAS-ALLIS PINZA PER AFFERRARE INTESTINI	538				
THOMSON-WALKER DIVARICATORE VESCICALE	552				
THOREK, FORBICI TORACALI	65/2				
THUDICHUM SPECOLO NASALE	421				
TIECK-HALLE SPECOLO NASALE	423				
TILLEY PINZA AURICOLARE	411				
TIRAMIOMI, DOYEN	594				
TIRAVENE	202				
TISCHLER PINZA PER BIOPSIA	591				
TISCHLER-KEVORKIAN PINZA PER BIOPSIA	592				
TISCHLER-MORGAN PINZA PER BIOPSIA	590, 591				
TITAN PINZA EMOSTATICA, CRILE	107				
TITAN PINZA EMOSTATICA, KELLY	106				
TOBOLD ABBASSALINGUA	453				
TOBOLD PORTACOTONE	203				
TOENNIS DURA DISSETTORE	332				
TOENNIS PINZA EMOSTATICA	117				
TOENNIS-ADSON FORBICI PER NEUROCHIRURGIA	65				
TOGLILAMA	42				
TOHUKU PINZA FISSATELI	132				
TONOMETRO, SCHIOETZ	394/2				
TONSILLOTOMO, SLUDER-BALLENGER	470				
TONSILLOTOMO, TYDING	469				
TOOK DISSETTORE CORNEALE	373				
TOURNIQUET RUMEL-BELMONT	528				
TOWNSEND PINZA PER BIOPSIA	591				

UNCINO PER LA PELLE, GUTHRIE.....	149
UNCINO PER LA PELLE, JOSEPH.....	149
UNCINO PER LA PELLE, KILNER.....	608
UNCINO PER LA PELLE, KLEINERT-KUTZ.....	149
UNCINO PER LA PELLE, REDA.....	150
UNCINO PER LE PINNE NASALI LANGE.....	448
UNCINO PER MUSCOLI.....	267
UNCINO PER NERVI D'ERRICO.....	329/2
UNCINO PER NERVI, CRILE.....	328
UNCINO PER NERVI, CUSHING.....	328
UNCINO PER NERVI, DANDY.....	328
UNCINO PER NERVI, GRAHAM.....	329
UNCINO PER NERVI, HESS.....	329/1
UNCINO PER NERVI, KRAYENBUEHL.....	336
UNCINO PER NERVI, LOVE.....	329/2
UNCINO PER NERVI, SACHS.....	329
UNCINO PER NERVI, SMITHWICK.....	329
UNCINO PER RADICI DEI NERVI, HOLLSHER.....	329/1
UNCINO PER RADICI DEI NERVI, LOVE.....	330
UNCINO PER RADICI DEI NERVI, SCOVILLE.....	330
UNCINO PER TENOTOMIA, STEVENS.....	375
UNCINO SHAMBAUGH.....	419
UNCINO SINSKEY.....	376
UNCINO SPEZZATORE, BRAUN.....	607
UNCINO, BARBARA.....	419
UNCINO, DAY.....	409
UNCINO, FISCH.....	335
UNCINO, LUCAE.....	409
UNCINO, MCGEE.....	419
UNCINO, SMELLIE.....	605
UNCINO, WAGENER.....	409
UNI I COMBINAZIONE PER DIAGNOSTICA CON ILLUMINAZIONE STANDARD.....	13
UNI II COMBINAZIONE PER DIAGNOSTICA CON ILLUMINAZIONE STANDARD.....	14
UNI III COMBINAZIONE PER DIAGNOSTICA CON ILLUMINAZIONE STANDARD.....	15
UNIVERSAL FORBICI PER BENDAGGI.....	70
UNIVERSAL FORBICI PER FILO DI METALLO E LAMIERA.....	67
UNIVERSAL PINZA PER STERILIZZAZIONE.....	227
UNIVERSAL TREQUARTO.....	204
UNNA SCHIACCIACOMEDONI.....	608
URETROTOMO OTIS.....	553
US ARMY DIVARICATORE.....	141
USA PINZA ANATOMICA.....	81
V	
VACUMENTRO PER VUOTI DI SANGUE.....	295
VALLEIX ISTEROMETRO.....	586
VALVE CON ADATTATORI AL TELAIO.....	194
VALVE, SCOVILLE.....	196
VAN BUREN CANDELETTA DILATATRICE.....	554
VAN BUREN TENAGLIA PER OSSA.....	249
VAN DOREN PINZA PER BIOPSIA.....	588
VANNAS FORBICI OCULISTICHE.....	79
VARADY STRUMENTO PER VARICI.....	202
VASSOIO PER PASTIGLIE.....	621
VERBRUGGE TENAGLIA PER OSSA.....	245
VERBRUGGE-MÜLLER ELEVATORE PER OSSA.....	286/2
VERESS AGO DI GUIDA.....	206
VIENNA SPECILLO DI GUIDA SCANALATO.....	221
VIRCHOW, COLTELLO PER CARTILAGINE E DISSEZIONE.....	48
VIRTUS(IRALK) PINZA PER SCHEGGE.....	92
VOLKMANN CURETTA TAGLIENTE.....	251
VOLKMANN CURETTA TAGLIENTE.....	257
VOLKMANN DIVARICATORE.....	153
VOLKMANN DIVARICATORE.....	154
VOLKMANN DIVARICATORE.....	156
VOLTOLINI SPECOLO NASALE.....	421
VU-MORE SPECOLO VAGINALE.....	569

W	
WACHENFELDT PINZA PER AGRAFES.....	224
WADSWORTH-TODD CAUTERIO.....	378
WAGENER-MOSHER CANNULA TRACHEALE.....	477
WAGENR UNCINO.....	409
WAGNER FORBICI GINGIVALI.....	67
WAGNER PINZA TAGLIENTE PER LAMINECTOMIA.....	343
WAGNER SUPERCUT FORBICI.....	72
WALLICH CUCCHIAIO PER ABORTO.....	607
WALSHAM PINZA PER RADDRIZZARE IL SETTO NASALE.....	449
WALTON SGORBIA PER CORPI ESTRANEI.....	374
WALTON SCHIACCIACOMEDONI.....	608
WALTON SEGA TAGLIA ANELLI.....	297
WANGENSTEEN PINZA VASCOLARE.....	89
WANGENSTEEN PORT'AGHI.....	210
WARTENBERG ALGESIMETRO.....	25
WATSON DERMATOMO.....	50
WATSON-CHEYNE ELEVATORE.....	283
WATSON-CHEYNE SPECILLO.....	199
WATSON-WILLIAMS PINZA NASALE.....	428
WAUGH PINZA CHIRURGICA.....	83
WEBER ANSA PER CATERATTA.....	378
WEBER PINZA PER AORTA.....	501
WEBSTER PORT'AGHI.....	208
WECKER FORBICI OCULISTICHE.....	75
WECKER SPATOLA PER IRIDE.....	378
WEEK BLEFAROSTATO.....	370
WEIL-BLAKESLEY PINZA NASALE.....	426
WEITLANER DIVARICATORE.....	169
WEITLANER-WULLSTEIN DIVARICATORE.....	169
WELLER, FORBICI PER DISSEZIONE.....	53/2
WELLS CUCCHIAIO PER ENUCLEAZIONE.....	378
WERTHEIM FORBICI PER ISTERECTOMIA.....	63
WERTHEIM PINZA PER ISTERECTOMIA.....	124
WERTHEIM PINZA PER ISTERECTOMIA.....	128
WERTHEIM-CULLEN PINZA PER PEDUNCOLO RENALE.....	125
WESTCOTT FORBICI OCULISTICHE.....	75
WESTMACOTT PINZA NASALE PER TAMPONI.....	424
WESTON SERRANODI RETTALE.....	566
WHEELER COLTELLO LANCEOLARE.....	373
WHEELER SPATOLA PER CICLODIALISI.....	379
WHITE PINZA PER TONSILLE.....	467
WIEDER ABBASSALINGUA.....	452
WIENER RASPA NASALE.....	443
WIENER UNCINO PER IRIDE.....	375
WIGMORE COLTELLO PER GESSI.....	229
WIKSTROEM PINZA EMOSTATICA.....	117
WILDE SERRANODI.....	411
WILDE SERRANODI.....	433/2
WILDE(TROELTSCH) PINZA AURICOLARE.....	410
WILDER ANSA PER CATERATTA.....	378
WILLET MARTEL PINZA DA PRESA.....	110
WILLIAMS BLEFAROSTATO.....	370
WILLIAMS CACCIAVITE.....	323
WILLIAMS PINZA PER AFFERRARE INTESTINI.....	539
WILLIGER CURETTA TAGLIENTE.....	255
WILLIGER MARTELLO.....	271
WILLIGER PERIOTOTOMO.....	276
WINTER PINZA PER ABORTO.....	606
WITTNER PINZA PER BIOPSIA.....	589
WOLFF PINZA STRAPPAGESSI.....	233
WOODSON DURA DISSETTORE.....	333
WORST, SONDA.....	381
WRIGLEY FORCIPE.....	602
WULLSTEIN COLTELLO.....	418
WULLSTEIN DIVARICATORE.....	171
WULLSTEIN MANICO D'ASPIRAZIONE.....	338
WULLSTEIN MICRO PINZA AURICOLARE A CUCCHIAIO.....	416
WYLLIE DILATATORE UTERINO.....	581

Y	
YANCOSKIE DIVARICATORE PER CHIRURGIA PLASTICA.....	198
YANKAUER DISSETTORE PER TONSILLE.....	465
YASARGIL CANNULA D'ASPIRAZIONE.....	337/2
YASARGIL CLIPS PER ANEURISMA.....	345 - 356
YASARGIL PINZA PER TUMORI.....	97
YASARGIL UNCINO GALEA.....	330
YEOMAN PINZA INTESTINALE PER BIOPSIA.....	566, 567
YOUNG BOOMERANG PER SUTURE.....	220
YOUNG DIVARICATORE PER LA PROSTATA.....	550
YOUNG PINZA TIRALINGUA.....	453
Z	
ZAUFAL ELEVATORE AURICOLARE.....	409
ZAUFAL-JANSEN ELEVATORE AURICOLARE.....	409
ZAUFAL-JANSEN PINZA SGORBIA.....	238
ZENKER DIVARICATORE.....	161
ZENKER PINZA EMOSTATICA.....	118
ZIEGLER BLEFAROSTATO.....	371
ZIEGLER COLTELLO LANCEOLARE.....	373
ZIEGLER COLTELLO PER IRIDE.....	372
ZIEGLER DILATATORE PER CANALE LACRIMALE.....	381
ZIEGLER SPECCHIO FRONTALE.....	21
ZIELKE SGORBIA.....	264
ZÖLLNER CANNULA D'ASPIRAZIONE.....	337/2