

Anexa nr. 52 Centrifuga de laborator (8-12 tuburi) viteza redusa 150940**EBA 200, Andreas Hettich, Germania****DM000739296**

Specificații solicitate	Specificații oferite
Centrifuga de laborator (8-12 tuburi) viteza redusa 150940 Cod 150940 Descriere Centrifugele de laborator sunt destinate pentru a centrifuga sângele. Parametrul Specificația Viteza de rotație Minimală, rpm 1000 Maximală, rpm 4500 Setări setarea vitezei Capacitatea Tipul tuburilor tuburi de 10 - 15 ml Numărul de tuburi 8-12 tuburi Timer Diapazon minim de timp 1 - ≥ 60 min Incrementarea ≤ 1 min Securitatea Blocarea capacului în timpul lucrului obligatoriu Indicatori Indicarori vizual și acustic obligatoriu Debalansare obligatoriu Pornire/oprire obligatoriu Capac deschis obligatoriu Display Digital obligatoriu Nivelul de zgomot ≤ 70 dB obligatoriu Fereastra, orificiu sau alt acces, necesar pentru efectuarea procedurii de verificare periodica, conform normelor si standartelor in vigoare obligatoriu	Centrifuga de laborator (8-12 tuburi) viteza redusa 150940 Cod 150940 Descriere Centrifugele de laborator sunt destinate pentru a centrifuga sângele. Parametrul Specificația Viteza de rotație Minimală, rpm 200 Maximală, rpm 6000 Setări setarea vitezei Capacitatea Tipul tuburilor tuburi de 4 - 15 ml Numărul de tuburi 8 tuburi Timer Diapazon minim de timp 1 - 99 min, sau continuu Incrementarea 1 min Securitatea Blocarea capacului în timpul lucrului obligatoriu Indicatori Indicarori vizual și acustic obligatoriu Debalansare obligatoriu Pornire/oprire obligatoriu Capac deschis obligatoriu Display Digital obligatoriu Nivelul de zgomot 50 dB obligatoriu Fereastra pentru efectuarea procedurii de verificare periodica, conform normelor si standartelor in vigoare obligatoriu

Small centrifuges

EBA 200 | 200 S

Top performance for small laboratories

The EBA 200 and EBA 200 S are practical, compact centrifuges for small sample sizes. The high speed S model can deliver reliable PPP results in 3 minutes or less. Included an 8-place fixed angle rotor to hold standard blood and urine tubes up to 15 ml in capacity.



ROTOR
INCLUDED



— Highlights

- max. RPM: 200 - 6,000 min⁻¹ | 8,000 min⁻¹
Adjustable in increments of 10
- max. RCF: 3,461 | 6,153
- max. capacity: 8 x 15 ml
- small centrifuge including 8-place angle rotor
- compact design
- IVDR-conform according to regulation (EU) 2017/746
- maximum noise level of ≤ 50 dB(A) | ≤ 55 dB(A)
- impulse key for short cycle mode
- 2 individual acceleration and deceleration stages
- easy operation with keypad

— Features

- plastic housing
- metal lid
- viewing port in the lid
- one-hand lid lock
- lid dropping protection
- emergency lid lock release
- light alloy chamber
- brushless drive
- error display
- imbalance monitoring and switch-off
- backlit panel with actual values of all parameters
- 3 adjustable messages after completion of the centrifugation run (audio + visual)

Technical data

	EBA 200	EBA 200 S
voltage ^{*)}	200 – 240 V 1 ~	200 – 240 V 1 ~
frequency	50 – 60 Hz	50 – 60 Hz
consumption	100 VA	160 VA
emission, immunity	EN/IEC 61326-1, class B	EN/IEC 61326-1, class B
max. capacity	8 x 15 ml	8 x 15 ml
max. RPM	6,000 min ⁻¹	8,000 min ⁻¹
max. RCF	3,461	6,153
running time	1 – 99 min, ∞ continuous run, short cycle mode (impulse button)	1 – 99 min, ∞ continuous run, short cycle mode (impulse button)
dimensions (WxDxH)	261 x 353 x 228 mm	261 x 353 x 228 mm
weight	approx. 9 kg	approx. 11 kg
max. noise level	≤ 50 dB (A)	≤ 55 dB (A)
Cat. No.	1800	1802
100 – 127 V 1 ~ / 50–60 Hz	1800-01	1802-01
emission, immunity	FCC class B	FCC class B

^{*)} Other voltages on request.

Available Rotors

ANGLE ROTORS	angle	max. RPM	max. capacity	Cat. No	page
 angle rotor, 8-place	33°	6,000 min ⁻¹ 8,000 min ⁻¹	8 x 15 ml	INCLUSIVE	3

Angle rotor, 8-place

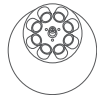

Rotor

max. RPM	EBA 200 200 S	6,000 min ⁻¹ 8,000 min ⁻¹
max. RCF		3,461 6,153
max. capacity		8 x 15 ml
run up / run down, braked in sec		17 / 12 37 / 17
angle		33°

Cat. No.	INCLUSIVE
-----------------	------------------

	Pediatric	microliter tubes			tubes ²⁾				blood collection / urine tubes						-
Vessels															
capacity in ml	0.5	1.5	2	4	5	6	15	1.1-1.4	2.6-3.4	2.7-3	4.5-5	4.9	7.5-8.2	9-10	15
Ø x L in mm	10.7 x 46	11 x 38	11 x 38	12 x 60	13 x 75	12 x 82	17 x 100	8 x 66	13 x 65	11 x 66	11 x 92	13 x 90	15 x 92	16 x 92	17 x 120
max. RCF ²⁾	EBA 200	2,214	2,173	2,173	2,656	2,697	2,697	3,461	2,697	2,697	2,697	3,461	3,461	3,461	3,461
max. RCF ²⁾	EBA 200 S	3,935	3,864	3,864	5,009	4,794	4,794	6,153	4,794	4,794	4,794	6,153	6,153	6,153	6,153
radius in mm	55	54	54	66	67	67	86	67	67	67	86	86	86	86	86
+															
Adapter															
boring Ø x L in mm	11 x 35	11 x 35	11 x 35	13,5 x 60	13,5 x 60	13,5 x 60	17,7 x 88	13,5 x 60	13,5 x 60	13,5 x 60	17,7 x 88	17,7 x 88	17,7 x 88	17,7 x 88	17,7 x 88
vessels per rotor	8	8	8	8	8	8	8	8	8	8	8	8	8	8	4
Cat. No.		1063-8 (8 pcs.)			6305	1054-A	1054-A	-	1054-A	1054-A	1054-A	-	-	-	-

	blood collection / urine tubes					
Vessels						
capacity in ml	10	1.6-5	4-7	8	8.5-10	12
Ø x L in mm	15 x 102	13 x 75	13 x 100	16 x 125	16 x 100	17 x 102
max. RCF ²⁾	EBA 200	3,461	2,697	3,461	3,461	3,461
max. RCF ²⁾	EBA 200 S	6,153	4,794	6,153	6,153	6,153
radius in mm	86	69	86	86	86	86
+						
Adapter						
boring Ø x L in mm	17,7 x 88	13,5 x 60	17,7 x 88	17,7 x 88	17,7 x 88	17,7 x 88
vessels per rotor	8	8	8	4	8	8
Cat. No.	-	1059	-	-	-	-

2) Please note that the RCF values indicated refer only to rotor performance. The max. permissible RCF of tubes used should be verified with the individual manufacturers. The max. RCF for glass tubes annotated with footnote 2) is 4,000.

12) For the EBA 200 only! Model EBA 200 S is supplied as standard with an adapter for these tubes.

Certifications / Registrations

Product certification:



Product registration:



Company certifications:



Dimensions – EBA 200 | 200 S

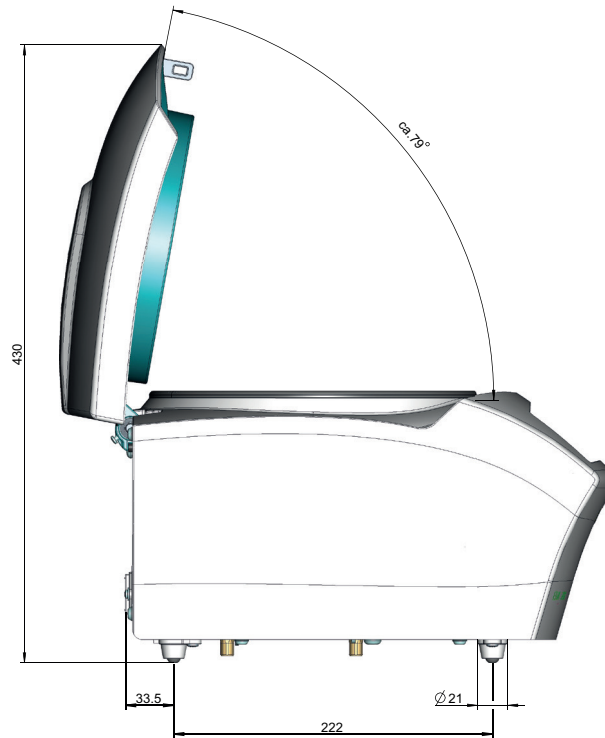

Déclaration de conformité UE

EU Declaration of conformity

du fabricant

of the manufacturer

Andreas Hettich GmbH • Föhrenstrasse 12 • D-78532 Tuttlingen • Germany
SRN: DE-MF-000010680

Par la présente, nous déclarons sous notre responsabilité, sans participation d'un organisme notifié, que le dispositif désigné :

We hereby declare under our responsibility without involvement of a notified body that the designated device:

Type de dispositif **Petite centrifugeuse**
Nom **EBA 200**
EBA 200 S
Basic UDI-DI **040506740100069U**
GMDN **36465**
Classification **Dispositif de diagnostic in vitro, classe A (annexe VIII, règle 5)**
Conformément au **règlement (UE) 2017/746 annexe IX**

Type of device **Small centrifuges**
Name **EBA 200**
EBA 200 S
Basic UDI-DI **040506740100069U**
GMDN **36465**
Classification **in vitro diagnostic, class A (Annex VIII, Rule 5)**
according to **Regulation (EU) 2017/746 Annex IX**

avec les accessoires évalués comme conformes au dispositif d'après la liste d'accessoires de la documentation technique correspondante, satisfait aux dispositions pertinentes du règlement (UE) 2017/746 relatif aux dispositifs de diagnostic in vitro.

and its accessories, which are listed in the related technical documentation and whose conformity has been assessed together with the device, complies with the relevant provisions of the Regulation (EU) 2017/746 on in vitro diagnostic devices.

utilisation conforme aux dispositions

L'appareil **EBA 200 / 200 S** est un dispositif médical de diagnostic in vitro conformément au règlement relatif aux dispositifs médicaux de diagnostic in vitro (UE) 2017/746.

Intended use

The **EBA 200 / 200 S** is an in vitro diagnostic device in accordance with the Regulation on *in vitro* diagnostic medical devices (EU) 2017/746 .

L'appareil est une centrifugeuse non automatique destinée à séparer les composants d'échantillons liquides d'origine humaine par la force centrifuge.

The device is a non-automatic centrifuge for separating the components of liquid samples of human origin using centrifugal force.

La centrifugeuse est spécifiquement destinée à la préparation d'échantillons dans le cadre de procédures de diagnostic in vitro et garantit la fonctionnalité des dispositifs médicaux de diagnostic in vitro ultérieurs, conformément à leur destination prévue. Elle constitue ainsi un élément indispensable dans la préparation des échantillons et l'aide au diagnostic.

The centrifuge is specifically intended for sample preparation in *in vitro* diagnostic procedures and ensures the functionality of downstream *in vitro* diagnostic devices within the scope of their intended purpose. It is therefore an indispensable part of sample preparation and diagnostic support.

La centrifugeuse ne peut être utilisée que par du personnel qualifié, dans des salles de laboratoire fermées de laboratoires et cliniques.

The centrifuge may only be operated by qualified personnel in laboratories and clinics in closed laboratory rooms.

Le dispositif satisfait également aux dispositions applicables des directives et règlements européens suivants

The device also complies to the applicable provisions of the following European directives, ordinances and standards

- 2011/65/UE « Directive RoHS »
(sans intervention d'un organisme notifié)
- (CE) 1907/2006 « Règlement REACH »
(sans intervention d'un organisme notifié)

- 2011/65/EC "RoHS Directive"
(without involvement of a notified body)
- (EC) 1907/2006 „Regulation on REACH“
(without involvement of a notified body)

Normes appliquées :
voir la liste des normes appliquées qui fait partie de la documentation technique.

Standards applied:
See the list of applied standards that forms part of the technical documentation.

Tuttlingen, 25.10.2025



Ralf Ledda
Gérant, Chief Executive Officer



La présente déclaration de conformité est valable du 25/10/2025

This declaration of conformity is valid from 25.10.2025

Operating instructions

EBA 200 / 200 S



Translation of the original operating instructions



©2023 - All rights reserved

Andreas Hettich GmbH

Föhrenstraße 12

D-78532 Tuttlingen, Germany

Telephone: +49 (0)7461/705-0

Fax: +49 (0)7461/705-1125

Email: info@hettichlab.com, service@hettichlab.com

Internet: www.hettichlab.com

Table of contents

1	About this document.	5
1.1	Use of this document.	5
1.2	Gender reference.	5
1.3	Symbols and labels in this document.	5
2	Safety.	5
2.1	Intended use.	5
2.2	Personnel requirements.	6
2.3	Operator's responsibility.	7
2.4	Safety instructions.	7
3	Device overview.	9
3.1	Technical data.	9
3.2	Certifications and logos.	11
3.3	European registration.	12
3.4	Important labels on the packaging.	12
3.5	Important labels on the device.	13
3.6	Operating and indicator elements.	14
3.6.1	Control.	14
3.6.2	Indicator elements.	14
3.6.3	Controls.	14
3.7	Original spare parts.	15
3.8	Scope of delivery.	15
3.9	Returns.	15
4	Transport and storage.	16
4.1	Transport and storage conditions.	16
4.2	Fastening the transport lock.	17
5	Commissioning.	17
5.1	Unpacking the centrifuge.	17
5.2	Removing the transport lock.	18
5.3	Setting up and connecting the centrifuge.	18
5.4	Switching the centrifuge on and off.	20
6	Operation	20
6.1	Opening and closing the lid.	20
6.2	Removing and installing the rotor.	21
6.3	Loading.	22
6.4	Centrifugation.	23
6.4.1	Centrifugation in continuous operation.	23
6.4.2	Centrifugation with time preselection.	23
6.4.3	Short-term centrifugation.	24
6.5	Quick stop function.	24
7	Software operation.	25
7.1	Centrifugation parameters.	25
7.1.1	Input with the SELECT button.	25
7.1.2	Runtime t.	26

7.1.3	Speed, RPM.	27
7.1.4	Relative centrifugal force, RCF.	27
7.1.5	Relative centrifugal force RCF and centrifuging radius RAD	27
7.1.6	Centrifugation of substances or mixtures of substances with a density higher than 1.2 kg/dm ³	28
7.2	Machine Menu.	28
7.2.1	Querying system information.	28
7.2.2	Cycle counter.	29
7.2.3	Querying operating hours and centrifugation runs.	30
7.2.4	Audible signal.	30
7.2.4.1	General.	30
7.2.4.2	Setting an audible signal.	30
7.2.5	Visual signal.	31
7.2.6	Automatic unlocking of the lid.	32
7.2.7	Indicator backlight.	32
8	Cleaning and care.	33
8.1	Overview table.	33
8.2	Instructions for cleaning and disinfection.	33
8.3	Cleaning.	34
8.4	Disinfection.	34
8.5	Maintenance.	35
9	Troubleshooting.	36
9.1	Fault description.	36
9.2	Performing a MAINS RESET.	37
9.3	Emergency release.	38
9.4	Replacing the mains input fuse.	38
10	Disposal.	39
10.1	General instructions.	39
11	Index.	41

1 About this document

1.1 Use of this document

- Read this document carefully and in full before commissioning the device for the first time.
Observe other enclosed instruction sheets where necessary.
- This document is part of the device and must be kept within easy reach.
- This document must be included if the device is passed on to a third party.
- The current version of the document in the available languages can be found on the manufacturer's website: ➔ <https://www.hettichlab.com/de/download-center/>







1.2 Gender reference

The employed masculine or feminine language form is to facilitate reading. In the spirit of equal treatment, corresponding terms apply in principle to all genders and do not imply any valuation.

1.3 Symbols and labels in this document

General symbols

The following markers are used in this document to highlight instructions, results, listings, references and other elements:

Marker	Explanation
1.  2.  3.  ... 	Step-by-step instructions
	Results of action steps
	References to sections of the document and other applicable documents
■ ... ■ ...	Listings without a fixed order
<i>[Buttons]</i>	Controls (for example: buttons, switches)
<i>'Indicator'</i>	Indicator elements (for example: signal lights, screen elements)

2 Safety

2.1 Intended use

Intended use

The centrifuge **EBA 200 / 200 S** is an in vitro diagnostic medical device according to the In Vitro Diagnostic Medical Devices Regulation (EU) 2017/746.

The device is used to separate samples of human origin into their constituent parts for subsequent further processing. The user can set each of the variable physical parameters within the limits set by the device.

The centrifuge may only be used by qualified personnel in closed laboratories. The centrifuge is only intended for the use referred to above. Intended use also includes observing all instructions in the user manual and compliance with inspection and maintenance. Any other use or use beyond this scope is considered improper. Andreas Hettich GmbH shall not be liable for any damage arising from such non-compliant use.

Non-intended use

- The centrifuge is not suitable for use in explosive or radioactive, or biologically or chemically-contaminated atmospheres.
- The user must take appropriate actions when centrifuging hazardous substances or mixtures of substances that are toxic, radioactive or contaminated with pathogenic microorganisms.
The manufacturer generally recommends using only centrifuge tubes with special screw caps designed for use with hazardous substances. Use sealable centrifuge tubes with a biosafety system for materials of risk groups 3 and 4.
- The manufacturer does not recommend centrifugation of flammable or explosive materials.
- The manufacturer does not recommend centrifugation of materials that react chemically with one another with high activation energy.

Foreseeable misuse

The manufacturer recommends using only accessories approved that it has approved for the intended purpose.

Only operate the centrifuge under supervision.

2.2 Personnel requirements

Required qualifications

The user has read the Operating Manual in full and familiarised themselves with the device.



NOTICE

Damage to the device by unauthorised personnel

- Tampering with and modifications to devices by unauthorised persons are at the operating organisation's own risk and will result in the loss of all warranty and liability claims.

Trained user

The user has been educated and trained in laboratory work and is able to carry out the work assigned to them, and to recognise and prevent potential hazards independently.

Personal protective equipment

Lack of personal protective equipment or unsuitable personal protective equipment increases the risk of impaired health and injury.

- Only use personal protective equipment that is in proper condition.
- Only use personal protective equipment that is adapted to the person (correct size, for example).
- Observe instructions on other protective equipment for specific activities.

2.3 Operator's responsibility



Follow the instructions in this document for proper and safe use of the device.

Keep the user manual for future reference.

Provide information

- Following the instructions in this document will help:
 - To avoid dangerous situations.
 - To minimise repair costs and downtime.
 - To increase the reliability and service life of the device.
- The operator is responsible for compliance with company regulations, standards and national laws.
- Note and keep the revision of the document separate from the document. If lost, the document can be replaced in the correct revision.
- Keep the user manual available at the place where the device is used.
- Pass the user manual on to the buyer when the device is sold.

Personnel training

Lack of knowledge when working with the device may result in serious injury or death.

- Instruct personnel on their tasks and the associated risks in accordance with the instruction.

2.4 Safety instructions



Reporting of events and incidents

In the event of incidents or notifiable events involving the device or its accessories, these must be reported to the manufacturer and, where applicable, to the competent authority where the user and/or the patient is registered.

Manufacturer:

Andreas Hettich GmbH

Föhrenstrasse 12

78532 Tuttlingen, Germany

Phone: +49 7461 705 0

E-mail: info@hettichlab.com



DANGER

Risk of contamination

Inadequate cleaning or failure to observe the cleaning instructions can lead to contamination risks.

- Observe national and local regulations on safety and accident prevention.
- Observe cleaning instructions.
- Wear personal protective equipment when cleaning the device.
- Comply with laboratory regulations (e.g. TRBAs, the German Protection against Infection Act, hygiene plan) for handling biological agents.

**DANGER****Risk of fire and explosion**

Risk of accidents, injuries or damage to property due to fire or explosion.

- Observe regulations and directives for handling chemicals and hazardous substances.
- Do not use corrosive chemicals.
- Do not use dangerous chemicals.
- Do not use corrosive extraction agents.
- Do not use strong acids.

**WARNING****Risk of injury**

Inadequate or late maintenance can result in injuries.

- Observe maintenance intervals.
- Check the device for visible damage or defects.
If any visible damage or defects are present, immediately remove the device from service and inform a service technician.

 **WARNING****Risk of electric shock**

Liquids that penetrate the device may cause electric shocks.

- The device must be protected from external contact with liquids.
- Do not pour any liquids inside the device.
- The original transport packaging must be used when transporting the device.

 **WARNING****Contamination with hazardous substances and substance mixtures**

Observe the following actions for substances and substance mixtures that are toxic, radioactive and/or contaminated with pathogenic microorganisms:

- As a rule, use only centrifuge tubes with special screw caps for hazardous substances.
- Use sealable centrifuge tubes with a biosafety system for materials of risk groups 3 and 4.
- If no biosafety system is used, the device is not micro-biologically tight in the sense of standard EN / IEC 61010-2-020.
- Contact the manufacturer if necessary.

WARNING
Risk of injury and device damage due to the rotor

A loose rotor can cause injuries and device damage.

- Check that the rotor is firmly seated.
- Follow maintenance intervals.

CAUTION
Risk of injury

Long hair and clothing can get caught in the rotor during manual movement.

- Tie long hair back.
- Do not allow garments to hang in the centrifuging chamber.

NOTICE
Damage

Incorrect voltage or frequency.

- Only operate the device according to the specifications on the rating plate.
Compliance with the instructions for use.

NOTICE
Damage

Aborting the program early can cause damage to the device and samples.

- Do not switch off, perform an emergency release or pull out the mains plug.

3 Device overview

3.1 Technical data

Manufacturer	Andreas Hettich GmbH D-78532 Tuttlingen			
Model	EBA 200		EBA 200 S	
Type	1800	1800-01	1802	1802-01
Mains voltage ($\pm 10\%$)	200-240 V 1~	100-127 V 1~	200-240 V 1~	100-127 V 1~
Mains frequency	50-60 Hz	50-60 Hz	50-60 Hz	50-60 Hz
power consumption	100 VA	100 VA	160 VA	160 VA
Power consumption	0.5 A	1.0 A	0.75 A	1.5 A
max. capacity	8 x 15 ml			
max. permissible density	1.2 kg/dm ³			

max. speed (RPM)	6000	8000		
max. acceleration (RCF)	3461	6153		
max. kinetic energy	750 Nm	1750 Nm		
Obligation to perform checks (DGUV Rules 100-500) (valid only in Germany)	No			
Ambient conditions (EN / IEC 61010-1):				
Installation site	indoors only			
Altitude	up to 2000 m above sea level			
Ambient temperature	2 °C to 40 °C			
Humidity	maximum relative humidity 80% for temperatures up to 31 °C, decreasing linearly to 50% relative humidity at 40 °C.			
Overvoltage category (IEC 60364-4-443)	II			
Pollution level	2			
Device protection class	I not suitable for use in potentially explosive atmospheres			
EMC:				
Emitted EM interference, EM interference immunity	EN / IEC 61326-1 Class B	FCC Class B	EN / IEC 61326-1 Class B	FCC Class B
Noise level (rotor-dependent)	≤50 dB(A)		≤55 dB(A)	
Dimensions:				
Width	261 mm			
Depth	353 mm			
Altitude	228 mm			
Weight	approx. 9 kg		approx. 11 kg	

Rating plate

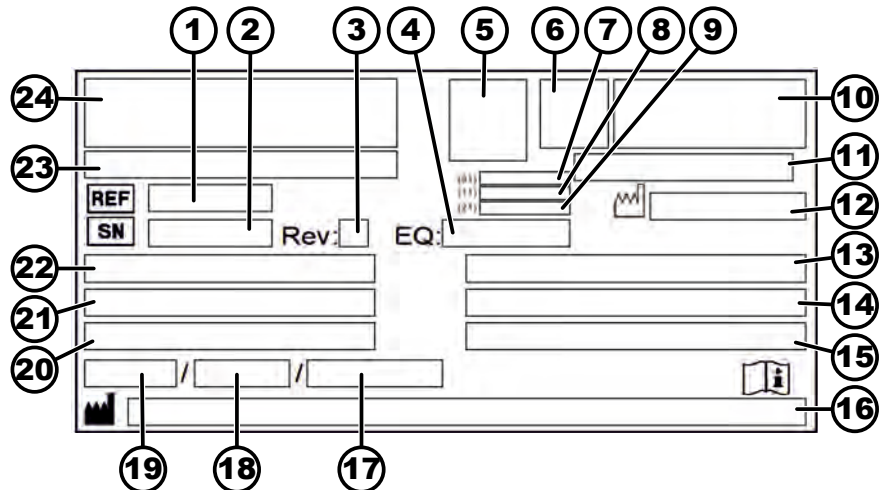

Fig. 1: Rating plate

- 1 Item number
- 2 Serial number
- 3 Revision
- 4 Equipment number
- 5 Data matrix code
- 6 any labelling indicating whether medical device or in vitro diagnostic medical device
- 7 Global Trade Item Number (GTIN)
- 8 Date of manufacture
- 9 Serial number
- 10 any EAC mark, CE mark
- 11 Country of manufacture
- 12 Date of manufacture
- 13 Mains frequency
- 14 Maximum kinetic energy
- 15 Maximum permissible density
- 16 Manufacturer's address
- 17 any Coolant circuit pressure
- 18 any Coolant capacity
- 19 any Coolant type
- 20 Revs per minute
- 21 Performance values
- 22 Mains voltage
- 23 any Device designation
- 24 Manufacturer's logo

3.2 Certifications and logos

Certifications



ISO 9001

Quality management system in accordance with ISO 9001

 <p>ISO 14001 Certified Environmental Management System www.tuvsud.com/ms-cert</p>	<p>ISO 14001 Environmental management in accordance with ISO 14001</p>
--	--

 <p>Certified Quality System ISO 13485 mdc</p>	<p>EN ISO 13485 Quality management in accordance with ISO 13485</p>
--	---

Logos

 <p>MADE IN GERMANY</p>	<p>Made in Germany Device was developed and made in Germany.</p>
--	--

3.3 European registration

Device conformity Device conformity according to EU directives.



Single Registration Number SRN: DE-MF-000010680

Basic-UDI-DI	Basic-UDI-DI	Device assignment
	040506740100069U	EBA 200 / 200 S (in vitro diagnostic medical device)

3.4 Important labels on the packaging

	<p>TOP This is the correct upright position of the shipping container for transport and/or storage.</p>
---	--

	<p>FRAGILE GOODS The contents of the shipping container are fragile, so it must be handled with care.</p>
---	--

PROTECT FROM MOISTURE

Protect the transport packaging from moisture and keep it in a dry environment.

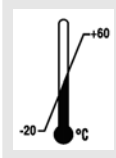
TEMPERATURE LIMITATION

The shipping container must be stored, transported and handled within the indicated temperature range (-20 °C to +60 °C).

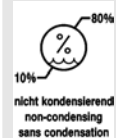
HUMIDITY LIMITATION

The shipping container must be stored, transported and handled within the indicated air humidity range (10 % to 80 %, non-condensing).

STACK LIMITATION BASED ON QUANTITY

Maximum number of identical packages that may be stacked on the lowest package, "n" standing for the number of packages allowed. The lowest package is not included in "n".

3.5 Important labels on the device



The signs on the device must not be removed or covered, or have anything pasted over them.



Attention, general danger area.

Ensure you read the instructions for commissioning and operation and observe the safety instructions before using the device.



Biohazard warning.



Direction of rotation of the rotor.

The orientation of the arrow indicates the rotor's direction of rotation.



Direction of rotation of the emergency release.



Symbol for the separate collection of electrical and electronic equipment, in accordance with Directive 2012/19/EU (WEEE).
Use in European Union countries, Norway and Switzerland.

3.6 Operating and indicator elements

3.6.1 Control

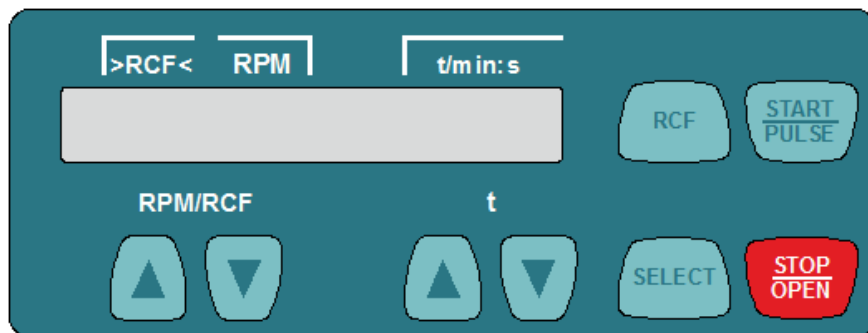

Fig. 2: Control

3.6.2 Indicator elements



Fig. 3: 'Lid unlocked' indicator

- The indicator appears when the lid is unlocked.



Fig. 4: 'Lid locked' indicator

- The indicator appears when the lid is locked.



Fig. 5: 'Rotation' indicator

- The indicator light rotates when the rotor is turning.

3.6.3 Controls



Fig. 6: [Mains switch]

- Switch the device on and off.



Fig. 7: [RPM/RCF] button

- Enter speed.
- The value changes at an increasing rate if the button is held down.

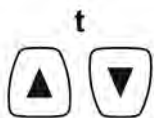

Fig. 8: [t] button



Fig. 9: [RCF] button



Fig. 10: [SELECT] button



Fig. 11: [START/PULSE] button



Fig. 12: [STOP/OPEN] button

- Enter runtime.
Adjustable up to 1 minute in 1 second increments and from 1 minute in 1 minute increments.
- Enter the centrifugation parameters.
- The value changes at an increasing rate if the button is held down.
- Toggle between RCF indicator and RPM indicator.
- Relative centrifugal force, RCF.
The RCF is displayed in brackets } {.
- Speed, RPM.
- Selecting the individual parameters.
- Open 'MACHINE MENU'.
- Scroll forward in the menus.
- Start centrifugation run.
- Short-term centrifugation. The centrifugation run takes place as long as the button is being pressed.
- Open submenus.
- End the centrifugation run.
The rotor ramps down to a stop at the preselected brake level.
- Pressing the button twice triggers the quick stop function.
- Unlock the lid.

3.7 Original spare parts

Use only original spare parts from the manufacturer and approved accessories.

3.8 Scope of delivery

The following accessories are supplied with the centrifuge:

- 2 Fuse link
- 1 hex key (SW5 x 100)
- 8 Adapter 1059 (EBA 200 S only)
- 1 Rotor
- 1 power cable
- 1 user manual
- 1 instruction sheet, transport lock
- 1 Emergency release instruction sheet

3.9 Returns

An original Return Material Authorisation (RMA) form from the manufacturer must always be requested for a return. Secure and reliable acceptance and booking in of the goods with the manufacturer is not possible without an original RMA form from the manufacturer. The Return Material Authorisation (RMA) form contains a Declaration of No Objection (UBE), which must be completed in full and enclosed with the return.

If the device and/or accessories are returned to the manufacturer, the complete return shipment must be cleaned and decontaminated by the sender. If returns are not cleaned and/or decontaminated or are insufficiently cleaned and/or decontaminated, this will be performed by the manufacturer and charged to the sender.

The original transport locks must be attached for return shipment, see → Chapter 4 'Transport and storage' on page 16. The device must be shipped in its original packaging.

4 Transport and storage

4.1 Transport and storage conditions

Transport conditions



NOTICE

Damage

- The device may be damaged if it is not secured during transport.
 - Secure the transport locks before transport.
 - Observe the transport instructions.



NOTICE

Danger due to condensation in the event of temperature differences

Moisture may damage electrical components.

- Ensure that all surfaces are dry prior to commissioning or maintenance.
- If the temperature changes, wait until the device or component has become acclimatised.
- Prevent moisture from penetrating into sensitive components.
- If moisture forms, switch off the device immediately and allow it to dry properly.

- Before transporting, fasten the transport lock and disconnect the device from the mains socket.
- The transport temperature must be between -20 °C and +60 °C.
- Humidity must not be condensing. Humidity must be between 10% and 80%.
- Be aware of the weight of the device.
- When transporting using a transport aid (e.g., a pallet truck), the transport aid must be able to carry at least 1.6 times the transport weight of the device.
- Secure the device to prevent it tipping over and falling down during transport.
- Never transport the device sideways or upside down.

Storage conditions

- The device must be stored in the original packaging.
- Only store the device in dry rooms.
- The storage temperature must be between -20 °C and +60 °C.
- Humidity must not be condensing. Humidity must be between 10% and 80%.

4.2 Fastening the transport lock

Personnel:

- Trained user

The lid is closed.

The mains cable is disconnected from the device.

1. ➤ Tilt the device on the back of the device.
2. ➤ Insert 2 spacer sleeves (1).
3. ➤ Screw in 2 screws (2).

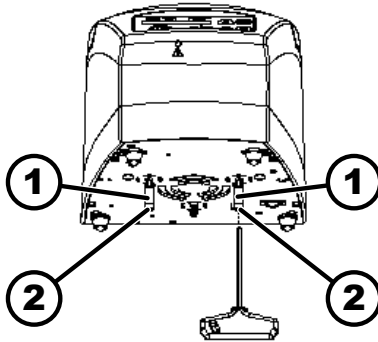

Fig. 13: Transport lock

- 1 Spacer sleeves
- 2 Screws

5 Commissioning

5.1 Unpacking the centrifuge



CAUTION

Danger of crushing due to parts falling out of the transport packaging.

- Keep the device balanced during the unpacking process.
- Only open the packaging at the points provided for this purpose.



CAUTION

Risk of injury from lifting heavy loads.

- Provide an adequate number of helpers.
- Note the weight. See ➔ Chapter 3.1 'Technical data' on page 9.



NOTICE

Damage to the device due to improper lifting.

- Do not lift the centrifuge by the control panel or the control panel holder.

Personnel:

- Trained user

1. ➤ Open the box at the top.
2. ➤ Remove the padding.
3. ➤ Remove the device and accessories by lifting them up out of the box.
4. ➤ Place the device on a stable and level surface.

5.2 Removing the transport lock

Personnel:

- Trained user

The lid is closed.

The mains cable is disconnected from the device.

1. ➤ Tilt the device on the back of the device.
2. ➤ Unscrew 2 screws (2).
3. ➤ Remove 2 spacer sleeves (1).
4. ➤ Keep the screws and spacer sleeves in a safe place.

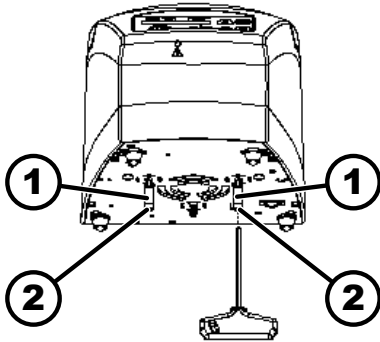

Fig. 14: Transport lock

- 1 Spacer sleeve
- 2 Screw

5.3 Setting up and connecting the centrifuge

Setting up the centrifuge



WARNING

Risk of injury

Due to insufficient clearance from the centrifuge.

- As per EN / IEC 61010-2-020, no persons, hazardous materials or objects may be present within a safety zone of 300 mm around the centrifuge during a centrifugation run.
- Maintain a distance of 300 mm from the ventilation slots and ventilation openings of the centrifuge.
- The centrifuge's ventilation openings must never be blocked.



CAUTION

Risk of crushing and damage

Changes in position caused by vibration may cause the device to fall.

- Place the device on a stable and level surface.
- Select an installation area that is capable of bearing the weight of the device.
- Observe national and local regulations on safety and accident prevention.

**NOTICE****Damage**

Any deviation from the external temperature conditions will result in damage to the samples and device.

- Comply with the maximum and minimum permissible ambient temperatures.
- Avoid placing the device next to heat sources.
- Do not place the device in direct sunlight.
- Protect the device from frost.
- Maintain the required clearance around the device.

Personnel:

- Trained user

1. Place the device on a stable and level surface.
2. Maintain a distance of 300 mm around the device.
3. Comply with the ambient conditions in the technical data (→ *Chapter 3.1 'Technical data' on page 9*).

Connecting the centrifuge**NOTICE****Damage**

Property damage caused by unauthorised personnel.

- Do not allow persons without the appropriate authorisation to perform any work on or make changes to devices.
- Only authorised personnel may carry out maintenance and repairs.
- Obtain the manufacturer's approval or guidance before carrying out any work on the device.

**NOTICE****Danger due to condensation in the event of temperature differences**

Moisture may damage electrical components.

- Ensure that all surfaces are dry prior to commissioning or maintenance.
- If the temperature changes, wait until the device or component has become acclimatised.
- Prevent moisture from penetrating into sensitive components.
- If moisture forms, switch off the device immediately and allow it to dry properly.

Personnel:

- Trained user

1. A type B residual current circuit breaker must be used if the device is additionally protected with a residual current circuit breaker in the building installation.

When using a different type, the residual current circuit breaker may either not switch off the unit if there is a fault on the unit, or it may switch off the unit even though there is no fault on the unit.

2. → Check whether the mains voltage and mains frequency match the specification on the rating plate.
3. → Connect the device to a standard mains socket using the mains cable.

5.4 Switching the centrifuge on and off.

Switching the centrifuge on

Personnel:

- Trained user

→ Set the mains switch to *///*.

- ➔ The buttons flash, depending on the centrifuge type.

The following indicators appear one after the other, depending on the centrifuge type:

- the centrifuge model
- the machine type and program version
- The last centrifugation data used.

The lid opens.

Switching off the centrifuge

The rotor is stationary.

→ Set the mains switch to */0/*.

6 Operation

6.1 Opening and closing the lid

Opening the lid

Personnel:

- Trained user

The centrifuge is switched on.

The rotor is stationary.

→ Press the *[STOP/OPEN]* button.

- ➔ The lid unlocks by means of a motor.

The *'Lid unlocked'* indicator appears.

Closing the lid



CAUTION

Crushing hazard when closing the lid.

Danger of fingers getting crushed when the closing motor pulls the lid against the seal.

- No parts of the operator's body should be in the hazard zone of the lid when closing the lid.
- To close the lid, press on the lid from above.



NOTICE

Damage to the device caused by the lid slamming.

- Close the lid slowly.
- Do not slam the lid.

Personnel:

- Trained user

- Close the lid and press the front edge of the lid down gently.
 - The lid locks using a motor.
 - The 'Lid locked' indicator appears.

6.2 Removing and installing the rotor



The rotor of the EBA 200 S must only be installed and removed by customer service.

Removing the rotor of the EBA 200

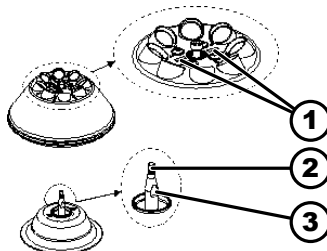

Fig. 15: Rotor installation and removal

- 1 Marker bar
- 2 Motor shaft
- 3 Surfaces

Personnel:

- Trained user

1. ➤ Open the lid.
2. ➤ Loosen the rotor clamping nut using the spanner supplied by turning it anticlockwise.
 - After passing the working point for lifting the rotor, the rotor detaches from the cone of the motor shaft (2).
3. ➤ Turn the clamping nut until the rotor can be lifted off the motor shaft.
4. ➤ Remove the rotor.

Installing the rotor of the EBA 200

Personnel:

- Trained user

The lid is open.

1. ➤ Clean the motor shaft (2) and rotor hole.
2. ➤ Lightly grease the motor shaft (2), see ➔ Chapter 8.2 'Instructions for cleaning and disinfection' on page 33.
3. ➤ Place the rotor vertically on the motor shaft (2).

The two marker bars (1) on the rotor must be parallel to the two surfaces (3) on the motor shaft.
4. ➤ Tighten the rotor clamping nut hand-tight by turning it clockwise using the hex key provided.
5. ➤ Check that the rotor is firmly seated.
6. ➤ A test run must be performed if a different rotor has been installed.

For the test run, the adjustment weight supplied (7g) must be placed in a rotor location and a centrifugation run with a runtime of 1 minute must be performed at a speed of 6000 RPM.

 - The drive must not switch off.



The adjustment weight must be removed from the rotor location again before the next centrifugation run.

6.3 Loading

Filling centrifuge tubes



WARNING

Risk of injury from contaminated sample material.

Contaminated sample material escapes from the sample tube during centrifugation.

- Use centrifuge tubes with special screw caps for hazardous substances.
- For risk group 3 and 4 materials, use a biosafety system in addition to the sealable centrifuge tubes (see WHO's 'Laboratory Biosafety Manual').



NOTICE

Damage to the device due to highly corrosive substances.

Highly corrosive substances may impair the mechanical strength of rotors, buckets and accessories.

- Do not centrifuge highly corrosive substances.



Standard glass centrifuge tubes can be loaded up to RCF 4000 (DIN 58970 part 2).

Personnel:

- Trained user

→ Fill centrifuge tubes outside the centrifuge.

The maximum capacity of the centrifuge tubes specified by the manufacturer must not be exceeded.

With angle rotors, the centrifuge tubes must only be filled to the extent that no liquid can be ejected from the tubes during the centrifugation run.



It must be ensured that there is a uniform fill level in the tubes in order to keep the weight differences in the centrifuge tubes as low as possible.

Loading the angle rotors

Personnel:

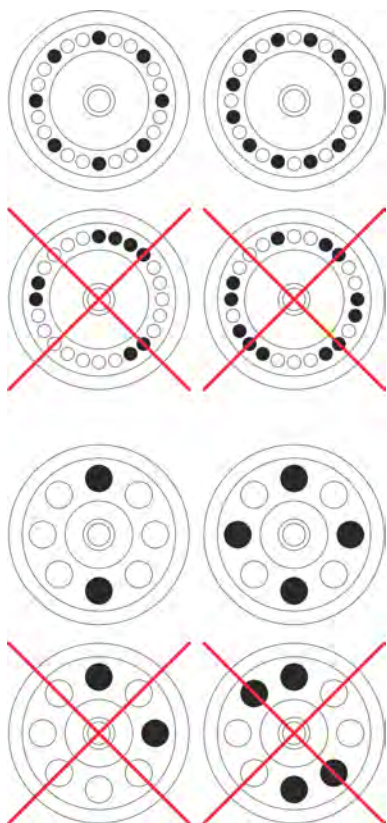
- Trained user



1.  Check that the rotor is firmly seated.
2.  The centrifuge tubes must be distributed evenly over all locations on the rotor.

No liquid must be allowed to enter the rotor and the centrifuging chamber when loading the rotor.

With rotors, the centrifuge tubes must only be filled to the extent that no liquid can be ejected from the tubes during the centrifugation run.





The weight of the permissible filling capacity is indicated on each rotor. The weight must not be exceeded.

6.4 Centrifugation

6.4.1 Centrifugation in continuous operation

Personnel:





- Trained user

1.  If required: Press the *[RCF]* button.
 - The parameter RCF (*'>RCF<'*) or RPM (*'RPM'*) is displayed. Press the *[RCF]* button to toggle between the two parameters.
2.  Enter the desired speed (RPM) or relative centrifugal force (RCF).
3.  Set the parameters t/min and t/sec to zero.
 - *'--:--'* is displayed.
4.  Press the *[START/PULSE]* button.
 - The centrifugation run is started.
The timing starts at *'0:00'*.
The rotor speed or the resulting RCF value and the elapsed time are displayed during the centrifugation run.
5.  Press the *[STOP/OPEN]* button to cancel the centrifugation run.
 - Ramp-down takes place with the set brake level. The brake level is displayed.
When the rotor is at a standstill, the lid opens, an audible signal sounds and the remaining number of run cycles (centrifugation runs) is displayed.

6.4.2 Centrifugation with time preselection

Personnel:

- Trained user

1.  If required: Press the *[RCF]* button.
 - The parameter RCF ('>RCF<') or RPM ('RPM') is displayed. Press the *[RCF]* button to toggle between the two parameters.
2.  Enter the desired speed (RPM) or relative centrifugal force (RCF).
3.  Set the parameters t/min and t/sec to the desired value.
4.  Press the *[START/PULSE]* button.
 - The centrifugation run is started.

The rotor speed or the resulting RCF value and the remaining time are displayed during the centrifugation run.
5.  Press the *[STOP/OPEN]* button to cancel the centrifugation run.

or

Wait for the centrifugation time to elapse.



 - Ramp-down takes place with the set brake level. The brake level is displayed.

When the rotor is at a standstill, the lid opens, an audible signal sounds and the remaining number of run cycles (centrifugation runs) is displayed.

6.4.3 Short-term centrifugation

Personnel:

- Trained user

1.  If required: Press the *[RCF]* button.
 - The parameter RCF ('>RCF<') or RPM ('RPM') is displayed. Press the *[RCF]* button to toggle between the two parameters.
2.  Enter the desired centrifugation parameters.
3.  Press and hold the *[START/PULSE]* button.
 - The centrifugation run is started.

The timing starts at '0:00'.

The rotor speed or the resulting RCF value and the elapsed time are displayed during the centrifugation run.
4.  Release the *[START/PULSE]* button to end the centrifugation run.
 - Ramp-down takes place with the set brake level. The brake level is displayed.

When the rotor is at a standstill, the lid opens, an audible signal sounds and the remaining number of run cycles (centrifugation runs) is displayed.

6.5 Quick stop function

Personnel:

- Trained user

-  Press the *[STOP/OPEN]* button twice.
 - Ramp-down with brake level "fast" (shortest ramp-down time) is displayed and executed.

7 Software operation

7.1 Centrifugation parameters

7.1.1 Input with the SELECT button





The number of centrifugation parameters that can be set differs depending on whether the RPM indicator or the RCF indicator is selected.

This chapter describes input of the centrifugation parameters with the RPM indicator and RCF indicator selected, one after the other.





The display returns to the previous values if no button is pressed for 8 seconds after parameter selection or during parameter entry. The parameters must then be entered again.

RPM indicator

1.  If required: Press the *[RCF]* button to select the RPM indicator.
 - Press the *[RCF]* button to toggle between the two parameters RPM ('*RPM*') and RCF ('*>RCF<*').
2.  Press the *[SELECT]* button.
 - Runtime in '*t/min*' is displayed
3.  Use the *[t]* buttons to set the desired value.



Adjustable from 1 to 99 minutes in 1 minute increments.

The parameters t/min and t/sec must be set to zero to set continuous operation.



 - '*--:--*' is displayed.
4.  Press the *[SELECT]* button.
 - Runtime in '*t/sec*' is displayed.
5.  Use the *[t]* buttons to set the desired value.

Adjustable from 1 to 59 seconds, in 1 second increments.

The parameters t/min and t/sec must be set to zero to set continuous operation.

 - '*--:--*' is displayed.
6.  Press the *[SELECT]* button.
 - Speed '*RPM*' is displayed.
7.  Use the *[t]* buttons to set the desired value.

A numerical value from 200 RPM to the maximum rotor speed can be set.

Adjustable in 10 second increments.
8.  Press the *[SELECT]* button.
 - Brake level DEC is displayed.
 - fast: short ramp-down time
 - slow = long ramp-down time
9.  Use the *[t]* buttons to set the desired value.

10. ➤ Press the *[START/PULSE]* button.
 - The settings are stored.

RCF indicator

1. ➤ If required: Press the *[RCF]* button to select the RCF indicator.
 - Press the *[RCF]* button to toggle between the two parameters RPM (*'RPM'*) and RCF (*'>RCF<'*).
2. ➤ Press the *[SELECT]* button.
 - Runtime in *'t/min'* is displayed
3. ➤ Use the *[t]* buttons to set the desired value.

Adjustable from 1 to 99 minutes in 1 minute increments.

The parameters t/min and t/sec must be set to zero to set continuous operation.

 - *'--:--'* is displayed.
4. ➤ Press the *[SELECT]* button.
 - Runtime in *'t/sec'* is displayed.
5. ➤ Use the *[t]* buttons to set the desired value.

Adjustable from 1 to 59 seconds, in 1 second increments.

The parameters t/min and t/sec must be set to zero to set continuous operation.

 - *'--:--'* is displayed.
6. ➤ Press the *[SELECT]* button.
 - Centrifuging radius *'RAD/mm'* is displayed.
7. ➤ Use the *[t]* buttons to set the desired value.

A numerical value from 10 mm to 250 mm can be set.

Adjustable in 1 millimetre increments
8. ➤ Press the *[SELECT]* button.
 - Relative centrifugal force *'RCF'* is displayed.
9. ➤ Use the *[t]* buttons to set the desired value.

A numerical value can be set that gives a speed between 200 RPM and the maximum rotor speed.



Adjustable in 1 second increments.
10. ➤ Press the *[SELECT]* button.
 - Brake level DEC is displayed.
 - fast: short ramp-down time
 - slow = long ramp-down time
11. ➤ Use the *[t]* buttons to set the desired value.
12. ➤ Press the *[START/PULSE]* button.
 - The settings are stored.

7.1.2 Runtime t

1. ➤ Use the *[t]* buttons to set the desired value
 - The value is set up to 1 minute in 1 second increments.
 - The value is set from 1 minute in 1 minute increments.
 - Adjustable from 1 to 99 minutes and 1 to 59 seconds.

2.  The parameters t/min and t/sec must be set to zero to set continuous operation.
 - '---:--' is displayed.

7.1.3 Speed, RPM

1.  Press the *[RCF]* button to select the RPM indicator.
 - Press the *[RCF]* button to toggle between the two parameters RPM ('*RPM*') and RCF ('*>RCF<*').
2.  Use the *[RPM/RCF]* buttons to set the desired value.

A numerical value from 200 RPM to the maximum rotor speed can be set.

Adjustable in 10 second increments.

7.1.4 Relative centrifugal force, RCF

The relative centrifugal force RCF is dependent on the speed and the centrifuging radius.

The relative centrifugal force RCF is stated as a multiple of the acceleration due to gravity (g).

The relative centrifugal force RCF is a dimensionless numerical value and is used to compare the separation and sedimentation performance.

$$RCF = \left(\frac{RPM}{1000} \right)^2 * r * 1,118$$

$$RPM = \sqrt{\frac{RCF}{r * 1,118}} * 1000$$



RCF = relative centrifugal force

RPM = Speed

r = centrifuging radius in mm = distance from the centre of the axis of rotation to the bottom of the centrifuge tube.

7.1.5 Relative centrifugal force RCF and centrifuging radius RAD

The relative centrifugal force (RCF) is dependent on the centrifuging radius (RAD). After entering the RCF, check that the correct centrifuging radius is set.

1.  If required: Press the *[RCF]* button to select the RCF indicator.
 - Press the *[RCF]* button to toggle between the two parameters RPM ('*RPM*') and RCF ('*>RCF<*').
2.  Use the *[RPM/RCF]* buttons to set the desired value.

A numerical value can be set that gives a speed between 200 RPM and the maximum rotor speed.

Adjustable in 1 second increments.

 - The centrifuging radius (RAD) is displayed during setting.
3.  If required: Use the *[t]* buttons to set the desired centrifuging radius.

A numerical value from 10 mm to 250 mm can be set.

Adjustable in 1 millimetre increments

7.1.6 Centrifugation of substances or mixtures of substances with a density higher than 1.2 kg/dm³

The density of the substances or mixtures of substances must not exceed 1.2 kg/dm³ during centrifugation at maximum speed. The maximum permissible speed must be reduced for substances or substance mixtures with a higher density. The permissible speed can be calculated using the following formula:

$$\text{Reduced speed } (n_{red}) = \sqrt{\frac{1,2}{\text{Greater density [kg/dm}^3\text{]}}} * \text{maximum speed [RPM]}$$

For example: Maximum speed 4000 RPM, density 1.6 kg/dm³

$$n_{red} = \sqrt{\frac{1,2(\text{kg/dm}^3)}{1,6(\text{kg/dm}^3)}} * 4000 \text{ RPM} = 3464 \text{ RPM}$$

If, in exceptional cases, the maximum load indicated on the bucket is exceeded, the speed must also be reduced. The permissible speed can be calculated using the following formula:

$$\text{Reduced speed } (n_{red}) = \sqrt{\frac{\text{maximum load [g]}}{\text{actual load [g]}}} * \text{maximum speed [RPM]}$$

For example: Maximum speed 4000 RPM, maximum load 300 g, actual load 350 g

$$n_{red} = \sqrt{\frac{300 \text{ g}}{350 \text{ g}}} * 4000 \text{ RPM} = 3703 \text{ RPM}$$

Please contact the manufacturer if you are not sure.

7.2 Machine Menu







7.2.1 Querying system information

The following system information can be queried:

- Centrifuge model
- Centrifuge program version
- Centrifuge type number
- Date of manufacture of the centrifuge
- Centrifuge serial number
- Frequency converter type
- Program version for the frequency inverter

The rotor is stationary.

1. **→** Press and hold the *[SELECT]* button.
 - *“MACHINE MENU”* is displayed after 8 seconds.
2. **→** Press the *[SELECT]* button.
 - *‘-> Info’* is displayed.
3. **→** Press the *[START/PULSE]* button.
 - The centrifuge model is displayed.
4. **→** Press the *[SELECT]* button.
 - The centrifuge program version *‘CP FW=’* is displayed.

5.  Press the *[SELECT]* button.
 - The centrifuge type number '*Type#1:*' is displayed.
6.  Press the *[SELECT]* button.
 - The continuation of the centrifuge type number '*Type#2:*' is displayed.
7.  Press the *[SELECT]* button.
 - The date of manufacture '*Date:*' of the centrifuge is displayed.
8.  Press the *[SELECT]* button.
 - The centrifuge serial number '*Serial#:*' is displayed.
9.  Press the *[SELECT]* button.
 - The type of frequency converter '*FC type*' of the centrifuge is displayed.
10.  Press the *[SELECT]* button.
 - The program version of the frequency converter '*FC FW=*' of the centrifuge is displayed.
11.  Press the *[STOP/OPEN]* button twice to exit the '*-> Info*' menu
or
Press the *[STOP/OPEN]* button three times to exit the '**MACHINE MENU**'.

7.2.2 Cycle counter



The cycle counter is switched off for the EBA 200 S because there is no set limit for the rotor's period of use.







The centrifuge is equipped with a cycle counter. The cycle counter counts the run cycles (centrifugation cycles). The remaining number of run cycles (centrifugation runs) is displayed briefly after each centrifugation run.

If the maximum permissible number of rotor run cycles entered is exceeded, '*Cycles passed*' is displayed after each start of a centrifugation run. The centrifugation run must be restarted. The rotor must be replaced with a new one.

Once the rotor has been replaced, the cycle counter must be reset to '0'.

Resetting the cycle counter

The cycle counter must be reset to '0' after installing a new rotor.

1.  Press and hold the *[SELECT]* button.
 - '**MACHINE MENU**' is displayed after 8 seconds.
2.  Press the *[SELECT]* button repeatedly until '*-> Time & Cycles*' is displayed.
3.  Press the *[START/PULSE]* button.
4.  Press the *[SELECT]* button repeatedly until '*Cyc sum=...*' is displayed.
5.  Press the *[RCF]* button.
6.  Press the *[t ▼]* button.
 - The number of run cycles completed is reset to '0'.
7.  Press the *[START/PULSE]* button.
 - '*Store cycles...*' is displayed.







8.  Press the *[STOP/OPEN]* button twice to exit the '*-> Time & Cycles*' menu
or
Press the *[STOP/OPEN]* button three times to exit the '***MACHINE MENU**'.

7.2.3 Querying operating hours and centrifugation runs

The operating hours are divided into internal and external operating hours.

- Internal operating hours: Total time for which the device has been switched on.
- External operating hours: Total time of centrifugation runs to date.

The rotor is stationary.

1.  Press and hold the *[SELECT]* button.
 - ➔ '***MACHINE MENU**' is displayed after 8 seconds.
2.  Press the *[SELECT]* button repeatedly until '*-> Time & Cycles*' is displayed.
3.  Press the *[START/PULSE]* button.
 - ➔ '*TimeExt=*' is displayed.
TimeExt: External operating hours
4.  Press the *[SELECT]* button.
 - ➔ '*TimeInt=*' is displayed.
TimeInt: Internal operating hours
5.  Press the *[SELECT]* button.
 - ➔ '*Starts=*' is displayed.
Starts: Number of all centrifugation runs
6.  Press the *[STOP/OPEN]* button twice to exit the '*-> Time & Cycles*' menu
or
Press the *[STOP/OPEN]* button three times to exit the '***MACHINE MENU**'.

7.2.4 Audible signal



7.2.4.1 General







The audible signal sounds:

- after a problem occurs in the 2 s interval.
- after completion of the centrifugation run and rotor standstill in the 30 s interval.

Opening the lid or pressing any button stops the audible signal.

7.2.4.2 Setting an audible signal







1.  Press and hold the *[SELECT]* button.
 - ➔ '***MACHINE MENU**' is displayed after 8 seconds.
2.  Press the *[SELECT]* button repeatedly until '*-> Settings*' is displayed.
3.  Press the *[START/PULSE]* button.
 - ➔ '*End beep = on*' or '*End beep = off*' is displayed.

4.  Use the *[t]* buttons to set 'off' or 'on'.
off: Audible signal after completion of the centrifugation run is disabled.
on: Audible signal after completion of the centrifugation run is enabled.
5.  Press the *[SELECT]* button.
➔ 'Error beep = on' or 'Error beep = off' is displayed.
6.  Use the *[t]* buttons to set 'off' or 'on'.
off: Audible signal after the occurrence of a malfunction is disabled.
on: Audible signal after the occurrence of a malfunction is enabled.
7.  Press the *[SELECT]* button.
➔ 'Beep volume = min', 'Beep volume = mid' or 'Beep volume = max' is displayed.
8.  Use the *[t]* buttons to set 'min', 'mid' or 'max'.
min: The volume of the audible signal is set to low.
mid: The volume of the audible signal is set to medium.
max: The volume of the audible signal is set to loud.
9.  Press the *[START/PULSE]* button.
➔ The setting is stored.
 'Store Settings...' is displayed briefly.
 '-> Settings' is then displayed.
10.  Press the *[STOP/OPEN]* button once to exit the '-> Settings' menu
or
Press the *[STOP/OPEN]* button twice to exit the *"*MACHINE MENU*"*.

7.2.5 Visual signal

The indicator backlight flashes as a visual signal after the centrifugation run is finished.







Switching on and off

1.  Press and hold the *[SELECT]* button.
➔ *"*MACHINE MENU*"* is displayed after 8 seconds.
2.  Press the *[SELECT]* button repeatedly until '-> Settings' is displayed.
3.  Press the *[START/PULSE]* button.
➔ 'End beep = on' or 'End beep = off' is displayed.
4.  Press the *[SELECT]* button repeatedly until 'End blinking=off' or 'End blinking =on' is displayed.
5.  Use the *[t]* buttons to set 'off' or 'on'.
off: Backlight does not flash.
on: Backlight flashes.
6.  Press the *[START/PULSE]* button.
➔ The setting is stored.
 'Store Settings...' is displayed briefly.
 '-> Settings' is then displayed.
7.  Press the *[STOP/OPEN]* button once to exit the '-> Settings' menu
or
Press the *[STOP/OPEN]* button twice to exit the *"*MACHINE MENU*"*.

7.2.6 Automatic unlocking of the lid

Setting whether or not the lid unlocks automatically after the centrifugation run.







The rotor is stationary.

1.  Press and hold the *[SELECT]* button.
 - **MACHINE MENU** is displayed after 8 seconds.
2.  Press the *[SELECT]* button repeatedly until *'-> Settings'* is displayed.
3.  Press the *[START/PULSE]* button.
 - *'End beep = on'* or *'End beep = off'* is displayed.
4.  Press the *[SELECT]* button repeatedly until *'Lid AutoOpen=off'* or *'Lid AutoOpen=on'* is displayed.
5.  Use the *[t]* buttons to set *'off'* or *'on'*.
 - off: Lid does not unlock automatically.
 - on: Lid unlocks automatically.
6.  Press the *[START/PULSE]* button.
 - The setting is stored.
 - 'Store Settings...'* is displayed briefly.
 - '-> Settings'* is then displayed.
7.  Press the *[STOP/OPEN]* button once to exit the *'-> Settings'* menu
or
Press the *[STOP/OPEN]* button twice to exit the **MACHINE MENU**.

7.2.7 Indicator backlight

The indicator backlight can be switched off after 2 minutes to save energy.

The rotor is stationary.

1.  Press and hold the *[SELECT]* button.
 - **MACHINE MENU** is displayed after 8 seconds.
2.  Press the *[SELECT]* button repeatedly until *'-> Settings'* is displayed.
3.  Press the *[START/PULSE]* button.
 - *'End beep = on'* or *'End beep = off'* is displayed.
4.  Press the *[SELECT]* button repeatedly until *'Power save=off'* or *'Power save=on'* is displayed.
5.  Use the *[t]* buttons to set *'off'* or *'on'*.
 - off: Backlight is switched off.
 - on: Backlight is switched on.
6.  Press the *[START/PULSE]* button.
 - The setting is stored.
 - 'Store Settings...'* is displayed briefly.
 - '-> Settings'* is then displayed.
7.  Press the *[STOP/OPEN]* button once to exit the *'-> Settings'* menu
or
Press the *[STOP/OPEN]* button twice to exit the **MACHINE MENU**.

8 Cleaning and care

8.1 Overview table

Chap.	Task to execute	if required	daily	weekly	Annually	Page
8	Cleaning and care					33
8.3	Cleaning					34
8.3	Cleaning the device		X			34
8.3	Cleaning accessories			X		34
8.4	Disinfection					34
8.4	Disinfecting the device	X				35
8.4	Disinfecting the accessories	X				35
8.5	Maintenance					35
8.5	Greasing the rubber seal of the centrifuging chamber			X		35
8.5	Checking the accessories			X		35
8.5	Centrifuging chamber damage inspection				X	35
8.5	Greasing the motor shaft				X	36
8.5	Accessories with a limited service life	X				36
8.5	Replacing centrifuge tubes	X				36

8.2 Instructions for cleaning and disinfection



DANGER

Risk of contamination

Inadequate cleaning or failure to observe the cleaning instructions can lead to contamination risks.

- Observe national and local regulations on safety and accident prevention.
- Observe cleaning instructions.
- Wear personal protective equipment when cleaning the device.
- Comply with laboratory regulations (e.g. TRBAs, the German Protection against Infection Act, hygiene plan) for handling biological agents.

- The device and its accessories must not be cleaned in dishwashers.
- Only perform hand cleaning and liquid disinfection.

- The water temperature must not exceed 25 °C.
- To prevent any corrosion due to use of detergents or disinfectants, it is essential to follow the special application instructions provided by the manufacturers of the detergent or disinfectant.

Disinfectant:

- Surface disinfectant (not disinfectant for hands or instruments)
- Ethanol as the sole active substance.
Do not use an ethanol-propanol mixture to disinfect the viewing window in the lid of the device.
- Concentration is not less than 30 %
- pH: 6 – 8
- Non-corrosive

8.3 Cleaning

Cleaning the device

1. ➤ Open the lid.
2. ➤ Switch off the device and disconnect it from the power supply.
3. ➤ Remove accessories.
4. ➤ Clean the centrifuge housing and the centrifuging chamber with soap or a mild detergent and a damp cloth.
5. ➤ Remove any detergent residues with a damp cloth after using detergents.
6. ➤ The surfaces must be dried immediately after cleaning.
7. ➤ Dry the centrifuging chamber with an absorbent cloth if condensation forms.

Cleaning accessories

1. ➤ Clean the accessories using the detergent and a damp cloth.
2. ➤ Remove any detergent residues with a damp cloth after using detergents.
3. ➤ Dry the accessories immediately after cleaning using a lint-free cloth and oil-free compressed air. Dry all cavities completely using oil-free compressed air.

8.4 Disinfection



Disinfection must always be preceded by cleaning of the components concerned.

See ➔ Chapter 8.3 'Cleaning' on page 34



Disinfectant concentration and application time according to the manufacturer's instructions.

Disinfecting the device**CAUTION**

Risk of injury due to ingress of water or other liquids.

- Protect the device against external liquids.
- Do not disinfect the device using spray.

1. Open the lid.
2. Switch off the device and disconnect it from the power supply.
3. Remove accessories.
4. Clean the housing and centrifuging chamber using disinfectant.
5. Remove any disinfectant residues with a damp cloth after using disinfectants.
6. The surfaces must be dried immediately after cleaning.

Disinfecting the accessories

1. Disinfect the accessories using the disinfectant.
2. Wet all cavities with bubble-free disinfectant.
3. Remove the disinfectant residues or leave them to dry after using disinfectants.

Autoclaving

No statement can be made about the resulting degree of sterility.

Autoclaving accelerates the ageing of materials. It may cause changes to colours. After autoclaving, the rotors and accessories are to be visually inspected for damage and any damaged parts are to be replaced immediately.

EBA 200 S**NOTICE**

Damage to the device due to autoclaving.

- The rotor and accessories must not be autoclaved.

EBA 200**NOTICE**

Damage to the device due to autoclaving.

- Do not autoclave the rotor more than 10 times.
The rotor must then be replaced.

The rotor may be autoclaved at 121 °C / 250 °F (20 min).

8.5 Maintenance**Greasing the rubber seal of the centrifuging chamber**

- Rub the sealing ring lightly with a rubber care product.

Checking the accessories

1. The accessories shall be checked for wear and corrosion damage.
2. Check that the rotor is firmly seated.

Centrifuging chamber damage inspection

- Check the centrifuging chamber for damage.

Greasing the motor shaft



*The rotor may only be removed from the EBA 200.
For this reason, the motor shaft can only be greased on the EBA 200.*

1. ➤ Remove accessories.
2. ➤ Clean the motor shaft.
3. ➤ Remove any detergent residues with a damp cloth after using detergents.
4. ➤ Grease the motor shaft with Hettich Tubenfett 4051.
5. ➤ Excess grease in the centrifuging chamber must be removed.

Accessories with a limited service life

The use of certain accessories is time-limited. For safety reasons, the accessories must no longer be used when either the maximum number of permissible run cycles marked on them or the expiry date marked on them has been reached.

- The maximum permissible number of run cycles or the expiry date can be seen on the accessories.
- The centrifuge is equipped with a cycle counter.

Replacing centrifuge tubes



CAUTION

Risk of injury from broken glass.

Broken glass may cause glass splinters and contaminated liquids to be found inside the centrifuge.

- Wear cut-resistant gloves.
- Wear protective goggles and a face mask.

Broken parts of the tube, glass splinters and spilled centrifuge material must be removed completely in the event of leakage or if a centrifuge tube breaks. Glass splinters that are not removed will cause further glass breakage.

The rubber inserts and the plastic sleeves of the rotors must be replaced after a glass breakage.

Disinfection must be carried out if the material is infectious.

9 Troubleshooting

9.1 Fault description



Customer service must be notified if the fault cannot be rectified based on the fault table. State the centrifuge type and serial number. Both numbers can be seen on the type plate of the centrifuge.

* Error number does not appear on the display.

Fault description	Cause	Remedy
no display	No power. Mains input fuses defective.	<ul style="list-style-type: none"> ■ Check the supply voltage. ■ Check mains input fuses. ■ The mains switch is in switch position <i>///</i>

Fault description	Cause	Remedy
IMBALANCE	The rotor is unevenly loaded.	<ul style="list-style-type: none"> ■ Open the lid. ■ Check the loading of the rotor. ■ Repeat the centrifugation run.
MAINS INTER 11, MAINS INTERRUPT	Loss of mains power during the centrifugation run. The centrifugation run was not completed.	<ul style="list-style-type: none"> ■ Open the lid. ■ Press the <i>[START/PULSE]</i> button. ■ If required: Repeat the centrifugation run.
TACHO - ERROR 1, 2	Speed pulse failure.	<ul style="list-style-type: none"> ■ Perform a MAINS RESET.
LID ERROR 4.1 - 4.127	Lid lock error.	<ul style="list-style-type: none"> ■ Perform a MAINS RESET.
OVER SPEED 5	Overspeed.	<ul style="list-style-type: none"> ■ Perform a MAINS RESET.
VERSION-ERROR 12	Wrong centrifuge model detected. Error/defect in electronics.	<ul style="list-style-type: none"> ■ Perform a MAINS RESET.
UNDER SPEED 13	Underspeed.	<ul style="list-style-type: none"> ■ Perform a MAINS RESET.
CTRL-ERROR 25.1-25.2	Error/defect in electronics.	<ul style="list-style-type: none"> ■ Perform a MAINS RESET.
CRC ERROR 27.1	Error/defect in electronics.	<ul style="list-style-type: none"> ■ Perform a MAINS RESET.
COM ERROR 31-36	Error/defect in electronics.	<ul style="list-style-type: none"> ■ Perform a MAINS RESET.
FC ERROR 60, 61.1-61.21, 61.64-61.142	Error/defect in electronics.	<ul style="list-style-type: none"> ■ Perform a MAINS RESET.
FC ERROR 61.23	Speed measurement error.	<ul style="list-style-type: none"> ■ Do not switch off the device while <i>'Rotation'</i> is displayed. ■ Perform a MAINS RESET if <i>'Lid locked'</i> is displayed.
TACHO ERR 61.22	Speed measurement error.	<ul style="list-style-type: none"> ■ Do not switch off the device while <i>'Rotation'</i> is displayed. ■ Perform a MAINS RESET if <i>'Lid locked'</i> is displayed.
FC ERROR 61.153	Error/defect in electronics.	<ul style="list-style-type: none"> ■ Perform a MAINS RESET. ■ Open the lid. ■ Check the loading of the rotor. ■ Repeat the centrifugation run.
 The left half of the display lights up.	-	<ul style="list-style-type: none"> ■ Notify customer service.

9.2 Performing a MAINS RESET

1.  Set the mains switch to *[0]*.
2.  Wait 10 seconds.
3.  Set the mains switch to *///*.

9.3 Emergency release

The lid cannot be unlocked by the motor in the event of a power failure. Emergency unlocking by hand must be performed.



! WARNING

Risk of electric shock due to maintenance and servicing work on live device.

- Disconnect the device from the mains before carrying out repairs and maintenance.



WARNING

Danger of cutting and crushing due to moving rotor.

- Do not open the lid until the rotor has stopped.

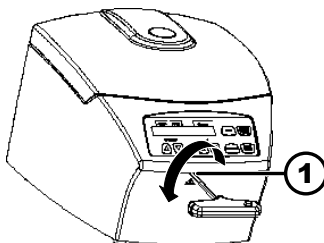

Fig. 16: Emergency release

1 Hole

Personnel:

- Trained user

1. Look through the window in the lid to ensure that the rotor is stationary.
2. Insert the hex key horizontally into the hole (1) and turn anticlockwise until the lid opens.
3. Remove the hex key from the hole (1).

9.4 Replacing the mains input fuse



! WARNING

Risk of electric shock due to maintenance and servicing work on live device.

- Disconnect the device from the mains before carrying out repairs and maintenance.

Personnel:

- Trained user

The mains fuses are located next to the mains switch.

The mains switch is in switch position [O]

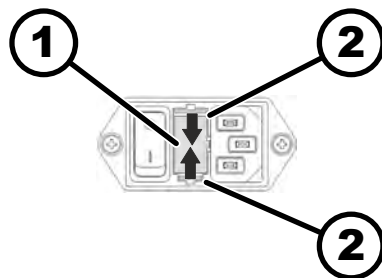

Fig. 17: Mains input fuse

1 Fuse holder
2 Snap lock

1. Disconnect the mains cable from the device plug.
2. Press the snap locks (2) against the fuse holder (1) and pull them out.
3. Replace the defective mains input fuses.
Only use fuses with the nominal value specified for the type: see the table below.
4. Push in the fuse holder (1) until the snap lock engages.
5. Reconnect the device to the mains.

Model	Type	Fuse	Order no.
EBA 200	1800	T 1.6 AH/250 V	E891
EBA 200	1800-01	T 3.15 AH/250 V	E997
EBA 200 S	1802	T 3.15 AH/250 V	E997
EBA 200 S	1802-01	T 6.3 AH/250 V	2266

10 Disposal

10.1 General instructions



The device can be disposed of via the manufacturer.

A Return Material Authorisation (RMA) form must always be requested for a return.

If necessary, contact the Technical Service Department of the manufacturer:

- **Andreas Hettich GmbH**
- *Föhrenstraße 12*
- *78532 Tuttlingen, Germany*
- *Phone: +49 7461 705 1400*
- *E-Mail: service@hettichlab.com*



WARNING

Risk of soiling and contamination

Damage to the environment and health due to improper disposal.

- Observe national and local environmental protection and disposal regulations to ensure proper disposal or recycling. Separate metals, non-metals, composite materials and auxiliary materials by type and dispose of them in an eco-friendly manner.
- The device may only be disassembled and disposed of by trained and authorised service technicians.

The device is intended for the commercial sector ("Business to Business" - B2B).

According to Directive 2012/19/EU, the devices may no longer be disposed of with household waste.

The devices are assigned to the following groups according to the Stiftung Elektro-Altgeräte Register (EAR (German foundation under civil law)):

- Group 5 (small devices)



The crossed-out wheelie bin symbol indicates that the device must not be disposed of with household waste. Regulations governing disposal of such devices may differ in individual countries. If necessary, contact the supplier.



Fig. 18: Household waste ban

11 Index

A

Accessories.	15
biosafety systems.	34
disinfection.	35
the rotor.	35
with limited service life.	36

Audible signal

an audible signal.	30
----------------------------	----

Autoclaving.	35
----------------------	----

C

Care

Intervals.	33
--------------------	----

Centrifugation

in continuous operation.	23
with higher substance density.	28
with time preselection.	23

Centrifuging chamber

inspection.	35
---------------------	----

Centrifuging radius

RAD.	27
--------------	----

Certifications.	11
-------------------------	----

Cleaning.	34
-------------------	----

Cleaning and disinfection

Instructions.	33
-----------------------	----

Connecting the centrifuge.	19
------------------------------------	----

Continuous operation.	23
-------------------------------	----

Cycle counter.	29
------------------------	----

the cycle counter.	29
----------------------------	----

D

Device

biosafety systems.	34
disinfection.	35

Disinfection.	34
-----------------------	----

Disposal.	39
-------------------	----

F

Fastening

removal.	18
the transport lock.	17

Filling.	22
------------------	----

Foreseeable misuse.	6
-----------------------------	---

G

General safety instructions.	7
--------------------------------------	---

Greasing

the rubber seal.	35
--------------------------	----

I

Intended use.	5
-----------------------	---

L

Labels

on the device.	13
on the packaging.	12

Lid

the lid.	20
------------------	----

Loading.	22
Logos.	11

M

MAINS RESET.	37
----------------------	----

Maintenance.	35
----------------------	----

Intervals.	33
--------------------	----

Motor shaft

the rubber seal.	36
--------------------------	----

N

Non-intended use.	6
---------------------------	---

O

Operator's responsibility.	7
------------------------------------	---

Original spare parts.	15
-------------------------------	----

P

Personal protective equipment.	6
--	---

Personnel qualifications.	6
-----------------------------------	---

Personnel training.	7
-----------------------------	---

Protective equipment.	6
-------------------------------	---

Q

Querying

system information.	28, 30
-----------------------------	--------

R

Rating plate.	11
-----------------------	----

Relative centrifugal force

RCF.	27
--------------	----

Removing

the rotor.	21, 22
--------------------	--------

Replacing

centrifuge tubes.	36
---------------------------	----

Return.	15
-----------------	----

S

Safety instructions.	7
------------------------------	---

Scope of delivery.	15
----------------------------	----

Setting up the centrifuge.	18
------------------------------------	----

Short-term centrifugation.	24
------------------------------------	----

Spare parts.	15
----------------------	----

Speed, RPM.	27
---------------------	----

Storage conditions.	16
-----------------------------	----

Switching off.	20
------------------------	----

Switching the unit on.	20
--------------------------------	----

Symbols.	5
------------------	---

T

Transport condition.	16
------------------------------	----

U

Unpacking.	17
--------------------	----

V

Visual signal.	31
------------------------	----

