

OPERATING MANUAL ELECTROSURGICAL UNIT



BOWA
ARCO
350

Contents

1.	Using this operating manual	7
1.1.	Revision index	7
1.2.	Validity	7
1.3.	Other applicable documents	7
1.4.	Icons and labeling	7
1.4.1.	Structure of warning instructions	7
1.4.2.	Risk levels in warning instructions	8
1.4.3.	Tips	8
1.4.4.	Other symbols and marks	8
2.	Safety	9
2.1.	Intended use	9
2.2.	General safety instructions	10
2.3.	Personal safety instructions	11
2.3.1.	Ambient conditions	11
2.3.2.	Patients with pacemakers	11
2.3.3.	Hazard-free patient positioning	12
2.3.4.	Correct connection of the HF device	12
2.3.5.	Correct use of the HF device	12
2.3.6.	Configuring HF device settings and using accessories	13
2.4.	Product-related safety instructions	14
2.5.	Safe handling (general instructions)	14
2.5.1.	Operation area: avoiding ignition and explosions	15
2.5.2.	Applying the neutral electrode	15
3.	Description	18
3.1.	User interface components	18
3.1.1.	Front panel user interface components	18
3.1.2.	Monopolar connector module (left)	18
3.1.3.	Bipolar connector module (right)	19
3.1.4.	Rear panel user interface components	20
3.2.	Symbols used on the device	21
3.2.1.	Rating label	22
3.3.	Scope of delivery	22
3.4.	Components required for operation	22
3.5.	Operating conditions	22

4.	Prearrangement	23
4.1.	Setting up the HF device	23
4.2.	Switching on the HF device	24
4.3.	Connecting instruments	24
4.3.1.	Instruments for monopolar use	25
4.3.2.	Instruments for bipolar applications	25
4.3.3.	Connecting a foot switch.....	25
4.4.	Functional test.....	26
4.4.1.	Auto test function	26
4.4.2.	Functional testing.....	26
4.4.3.	Actions in case of problems.....	27
4.5.	Neutral electrode monitoring.....	27
4.5.1.	General information	27
4.5.2.	EASY neutral electrode monitoring (EASY monitoring)	28
5.	Operation.....	29
5.1.	Connecting power	29
5.2.	Program overview	29
5.2.1.	Display	30
5.3.	Activating and deactivating connectors.....	31
5.4.	Configuring output currents.....	31
5.4.1.	Selecting the mode	31
5.4.2.	Specifying power limits	33
5.4.3.	Selecting the effect	33
5.4.4.	Assigning the foot pedal	34
5.4.5.	Selecting the neutral electrode	35
5.4.6.	Plug'n Cut COMFORT	37
5.5.	Mode overview	38
5.5.1.	Monopolar modes	38
5.5.2.	Bipolar modes.....	39
5.6.	Monopolar cutting modes.....	40
5.6.1.	Standard	40
5.6.2.	Micro	40
5.6.3.	Dry	40
5.6.4.	Argon	41
5.6.5.	Resection	41
5.6.6.	MetraLOOP.....	42

5.6.7.	Laparoscopy	42
5.6.8.	GastroLOOP 1 (optional)	42
5.6.9.	GastroLOOP 2 (optional)	43
5.6.10.	GastroLOOP 3 (optional)	43
5.6.11.	GastroKNIFE 1 (optional)	44
5.6.12.	GastroKNIFE 2 (optional)	44
5.6.13.	GastroKNIFE 3 (optional)	45
5.7.	Monopolar coagulation modes	45
5.7.1.	Moderate	45
5.7.2.	Forced coag	46
5.7.3.	Forced mixed	46
5.7.4.	Forced cutting	46
5.7.5.	Spray	47
5.7.6.	Argon open	47
5.7.7.	Argon flexible (optional)	48
5.7.8.	Argon flex. pulse (optional)	48
5.7.9.	Resection	49
5.7.10.	Cardiac Mammary	49
5.7.10.	Cardiac Thorax	49
5.7.11.	SimCoag	50
5.7.12.	Gastro Coag (optional)	50
5.7.13.	Laparoscopy	50
5.8.	Bipolar cutting modes	51
5.8.1.	Standard	51
5.8.2.	Bipolar resection (optional)	51
5.8.3.	Bipolar scissors	52
5.9.	Bipolar coagulation modes	52
5.9.1.	Standard forceps	52
5.9.2.	Standard forceps AUTO	52
5.9.3.	Micro forceps	53
5.9.4.	Forceps forced	53
5.9.5.	LIGATION (optional)	54
5.9.6.	TissueSeal PLUS (optional)	54
5.9.7.	Bipolar scissors	55
5.9.8.	Laparoscopy	55
5.9.9.	Bipolar resection (optional)	55

5.10.	Menu dialogs	56
5.10.1.	Overview	56
5.10.2.	"System Settings" dialog	56
5.10.3.	"Neutral electrode" dialog	57
5.10.4.	"Program" dialog	58
5.10.5.	"Language" dialog	60
5.10.6.	"System messages" dialog	60
5.10.7.	"System information" dialog	61
5.10.8.	"Service" dialog	61
5.10.9.	"Argon" dialog	63
6.	Detecting and correcting faults	64
6.1.	System informations	64
6.2.	Fault indications for EASY monitoring	69
7.	Preparation	70
7.1.	Preparation of the accessories	70
7.2.	Disinfection and cleaning	70
8.	Maintenance and repair	71
8.1.	Maintenance	71
8.1.1.	Safety inspection	71
8.2.	Repairs	72
9.	Storage	73
9.1.	Technical service	73
10.	Technical specifications	74
10.1.	ARC 350 technical data	74
10.2.	Output, voltage and current diagrams	81
11.	Accessories and replacement parts	119
12.	EMC	120
12.1.	Guidelines and manufacturer's declaration in accordance with IEC 60601-1-2 Section 6.8.3.201	120
13.	Disposal	123

1. Using this operating manual

This operating manual is part of the device.

BOWA-electronic GmbH & Co. KG, referred to in the following simply as BOWA, assume no liability nor provide any warranty whatsoever for damage and consequential damages that arise due to non-compliance with the operating manual.

- ▶ Read the operating manual carefully and thoroughly before using this device.
- ▶ Store the operating manual in a safe place throughout the service life of the device.
- ▶ Keep the operating manual accessible to operating room personnel.
- ▶ Give the operating manual to each successive owner and/or user of this device.
- ▶ Always update the operating manual whenever you receive additional information from the manufacturer.

1.1. Revision index

Unit version	Last revised
Valid from version 2.0.0	2014/02

1.2. Validity

This operating manual applies only to the devices designated on the title page.

1.3. Other applicable documents

- ▶ Comply with other applicable documents in the appendix or in the other sections.

1.4. Icons and labeling

1.4.1. Structure of warning instructions



⚠ SIGNAL WORD

"Risk type, source and consequences there of" (Personal injury)!

- ▶ Measure for risk prevention.
-







❗ NOTE

"Risk type, source and consequences there of" (Property damage)!

- ▶ Measure.
-

1.4.2. Risk levels in warning instructions

Symbol	Risk level	Probability of occurrence	Consequences of non-compliance
	DANGER	Immediate risk	Death, serious injuries
	WARNING	Possible risk	Death, serious injuries
	CAUTION	Possible risk	Minor injuries
	NOTE	Possible risk	Property damage

1.4.3. Tips



Tips and additional information to facilitate tasks

1.4.4. Other symbols and marks

Symbol or mark	Meaning
<input checked="" type="checkbox"/>	Prerequisite for an activity
▶	Activity with one step
1. 2. 3.	Activity with several steps in a binding sequence
↪	Result of preceding activity
•	List (first level)
•	List (second level)
Emphasis	Emphasis
....., see Section xxx, page xxx	Cross reference

2. Safety

2.1. Intended use

The HF device is intended exclusively for the generation of electrical power for monopolar and bipolar cutting and coagulation on tissue structures in surgical operations.

It is used in the following areas:

- General surgery
- Endoscopy (GastroCut mode)
- Gynecology
- Hand surgery
- ENT
- Cardiac surgery (including open-heart surgery)
- Neurosurgery
- Paediatric surgery
- Plastic surgery and dermatology
- Thoracic surgery
- Orthopedics
- Urology, including transurethral resection (TUR)

Do not use the HF device if, in the opinion of an experienced physician or according to current professional literature, such use would endanger the patient, due for example to the general condition of the patient, or if other contraindications are present.



BOWA requires that the HF device is operated under the supervision of qualified and authorized personnel. The surgeon and medical staff must be trained in the fundamental principles, rules for use and risks of HF surgery and must be familiar with these in order to safely and reliably prevent putting patients, staff and equipment at risk. Contact your BOWA distributor for trainings and training material.



Any other use is neither intended nor proper and must be effectively prevented.

2.2. General safety instructions

- ▶ Ensure that no electronic devices that are subject to interference from electromagnetic fields are set up in the vicinity of the HF device.
- ▶ Observe the instructions on electromagnetic compatibility provided in section EMC, page 120.
- ▶ Always connect the HF device to a mains power system with a protective earth lead in order to prevent electric shock.

Additional devices that are connected to electrical medical devices must satisfy relevant IEC or ISO standards (e.g. IEC 60950 for data processing devices). Furthermore, all configurations must comply with the standardised requirements for medical systems (see IEC 60601-1-1 or Section 16 of the 3rd edition of IEC 60601-1 as relevant). Anyone who connects additional devices to electrical medical devices is automatically a system configurator and thus responsible for meeting standardised system requirements. Please note that local laws prevail over the aforementioned standard requirements. In case of questions, please contact your local dealer or Technical Service, see section Technical service, page 73.



To protect personnel, BOWA recommends the use of a smoke evacuator to extract electrosurgical smoke, e.g. BOWA SHE SHA.

2.3. Personal safety instructions

2.3.1. Ambient conditions

- ▶ Do not use the HF device in the immediate vicinity of the patient. Observe the minimum distances recommended by BOWA, as shown in the following figure.

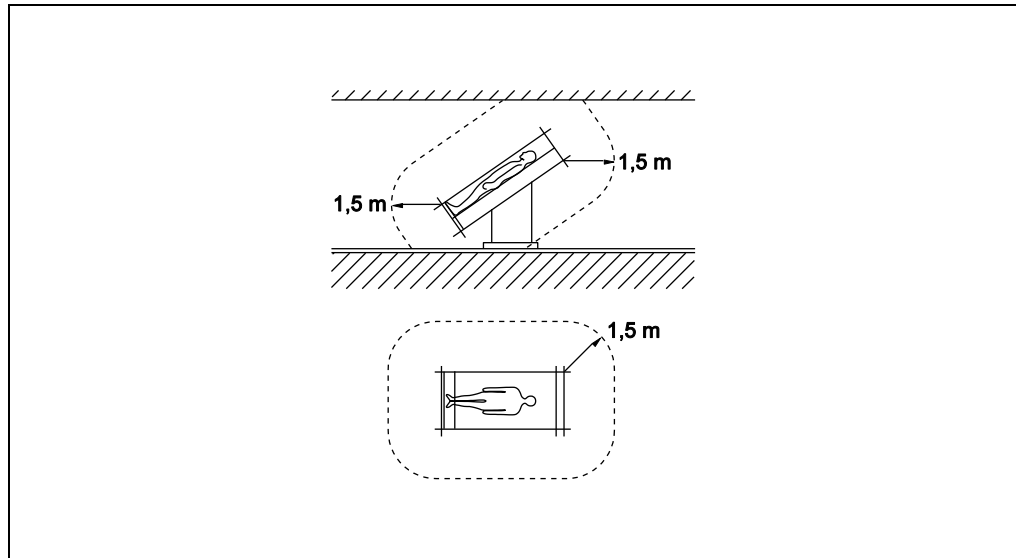

2.3.2. Patients with pacemakers

Malfunction or destruction of the pacemaker can endanger the life of the patient or result in irreversible injuries to the patient.

- ▶ In the case of patients with pacemakers, consult the cardiologist before carrying out HF surgery.
- ▶ Use bipolar HF methods.
- ▶ Attach the HF neutral electrode close to the operating field.
- ▶ Set the demand pacemaker to a fixed frequency.
- ▶ Ensure that the pacemaker does not come into contact with the HF electrode.
- ▶ Keep a fully operational defibrillator within reach.
- ▶ Carry out a postoperative pacemaker check.

2.3.3. Hazard-free patient positioning

- ▶ Position patients so that they are not touching any metal parts that are grounded or have considerable capacitance relative to ground (e.g. operating table brackets). If necessary, place anti-static cloths between the patient and the bedding.
- ▶ Ensure that the patient does not touch any wet clothes or bedding.
- ▶ Place anti-static cloths between areas with heavy sweating and skin-to-skin contact areas on the patient's torso.
- ▶ Ensure that the patient is resting on a suitable surface in order to prevent pressure necrosis.
- ▶ Drain urine via a catheter.

2.3.4. Correct connection of the HF device

- ▶ Always ground the HF device to the equipotential rail. Also observe the requirements in Section 8.6.7 of IEC 60601-1 regarding medical electrical systems.
- ▶ Do not use needle electrodes for monitoring.
- ▶ Attach electrodes of physiological monitoring devices without protective resistors or HF chokes as far away from the HF electrodes as possible.
- ▶ Place lines from monitoring devices so that they do not lie on the patient's skin.
- ▶ Keep the leads to the HF electrodes as short as possible and position them so that they do not touch the patient or other leads.
- ▶ Do not place any objects on the HF device.

2.3.5. Correct use of the HF device

Inadvertent activation of the HF device outside the user's field of vision can injure the patient.

- ▶ Activate the HF device only when the electrode is in your field of vision and you can quickly deactivate the HF device at all times.
- ▶ If the HF device is activated inadvertently, switch it off immediately using the on/off switch.
- ▶ Take particular care when using a foot switch or manual switch.

Improper preparation, user errors or faults in the HF device can cause damage to the HF device.

- ▶ Use the automatic monitoring functions to ensure that the HF device is working properly. See Section Functional testing, page 26 for information on the auto test functions.
- ▶ Ensure that no conductive fluids (e.g. blood or amniotic fluid) have penetrated the foot switch or the manual switch.
- ▶ Ensure that the cables for the foot switch and the manual switch are free from short circuits and broken leads.

2.3.6. Configuring HF device settings and using accessories

Setting the output power too high can injure the patient. Therefore, before you increase the output power, ensure that:

- the neutral electrode is attached properly;
- the working electrodes are clean;
- the plug connections are all correct.

Setting the HF device correctly

- ▶ To prevent inadvertent (thermal) tissue damage during operations on body parts with small cross sections and in areas with high resistance (bones or joints), use the bipolar method in these areas.
- ▶ Set the level of the acoustic signal that sounds when the electrode is activated so that it is always clearly audible.

Risk of nerve or muscle excitation by low-frequency currents.

During HF surgical operations (especially when an arc is formed), part of the HF current is converted into a low-frequency current. This current can trigger muscle contractions in the patient.

- ▶ To minimize the risk of injury to the patient, set the power and the effect as low as possible.

Correct use of accessories

- ▶ Use only insulated accessories.
- ▶ Check all electrodes for sharp edges and projecting parts before use.
- ▶ Use only electrodes that are free of defects and in good working order.
- ▶ Never place active electrodes on or near the patient.
- ▶ Do not remove hot electrodes from the patient's body directly after cutting or coagulation.
- ▶ Ensure that there is sufficient distance between the patient cables and the cables of the HF device.
- ▶ Do not run the patient cable across the patient.

2.4. Product-related safety instructions

Devices manufactured by BOWA are developed in accordance with the current state of technology and generally accepted safety rules. Despite this, using these products can lead to risks to the life and health of the user or third parties and/or damage to the device or other objects.

- ▶ Use only accessories approved by BOWA, see Section Accessories and replacement parts, page 119.
- ▶ Use the device only when it is in free of technical defects and in good working order and only for the intended purpose, always remaining aware of safety requirements and risks and complying with this operating manual.
- ▶ Have malfunctions that can adversely affect safety (e.g. deviations from the permissible operating conditions) repaired without delay.
- ▶ Wipe down the HF device only with cleaning agents and disinfectants that are approved in the country of use for surface cleaning. See Section Disinfection and cleaning, page 70.
- ▶ Never immerse the device in water or cleaning agents.
- ▶ Never boil the device and never disinfect it mechanically.
- ▶ If any fluids penetrate the device, drain them immediately.

Damage to the device can lead to an undesirable increase in output power due to improper operation of the device.

Certain units or accessories can cause danger in lower power settings. For example, the risk of gas embolism in argon assisted coagulation rises, if the hf-power is insufficient for the fast creation of an impenetrable eschar layer on the target tissue.

2.5. Safe handling (general instructions)

- ▶ Before each use of the device, check to ensure that it is functioning properly and is in good working order and connected properly.
- ▶ Observe the instructions on intended use in conformance with standards (see Section Fault indications for EASY monitoring , page 69).
- ▶ During use, always observe and comply with the acoustic signals and/or error messages of the HF device (see Section Fault indications for EASY monitoring , page 69).
- ▶ The device and accessories may be operated and used only by people who have the necessary training, knowledge and experience.
- ▶ Regularly inspect the accessories, especially the electrode cables, endoscopic accessories and neutral electrodes, for damage to the insulation, proper operation and expiration date.
- ▶ Ensure that no instruments are being cleaned when AUTOSTART is activated.
- ▶ Wear suitable gloves during operations.

2.5.1. Operation area: avoiding ignition and explosions

Sparks are generated when the HF device is used as intended.

- ▶ Do not use the HF device in areas where there is a risk of explosion.
- ▶ Do not use any flammable or explosive liquids.
- ▶ If the display fails, do not use the HF device any longer.
- ▶ During operations (e.g. in the head or thoracic regions), avoid using ignitable anesthetics and gases that support combustion (e.g. nitrous oxide or oxygen) or extract them using a vacuum system.
- ▶ Use exclusively non-flammable cleaning agents, disinfectants and solvents (for adhesives). If you use flammable cleaning agents, disinfectants or solvents, ensure that they have fully evaporated before using HF surgical equipment.
- ▶ Ensure that no flammable liquids collect beneath the patient or in body cavities (e.g. the vagina). Suction and/or flush body cavities before activating the device.
- ▶ Wipe off all liquids before using the HF device.
- ▶ Ensure that no ignitable endogenous gases are present.
- ▶ Ensure that all materials saturated with oxygen (e.g. cotton or gauze) are kept far enough away from the HF environment that they cannot ignite.

2.5.2. Applying the neutral electrode



Observe the instructions on the use of the neutral electrode in the user guide and the information on the package of the neutral electrode.

In the monopolar HF method, the neutral electrode feeds the current introduced into the patient's body at the surgical site back to the HF device.

- ▶ To prevent a rise in temperature at the current exit point, the following conditions must be ensured:
 - sufficiently large contact surface between the neutral electrode and the patient's body;
 - high electrical conductivity between the neutral electrode and the patient's body.

- ▶ To prevent the patient being burned by the neutral electrode, you must comply with the following conditions:
 - Select the application point for the neutral electrode so that the current paths between the active and neutral electrodes are as short as possible and run longitudinally or diagonally through the patient's body (because muscles are more conductive in the direction of the fibrils).

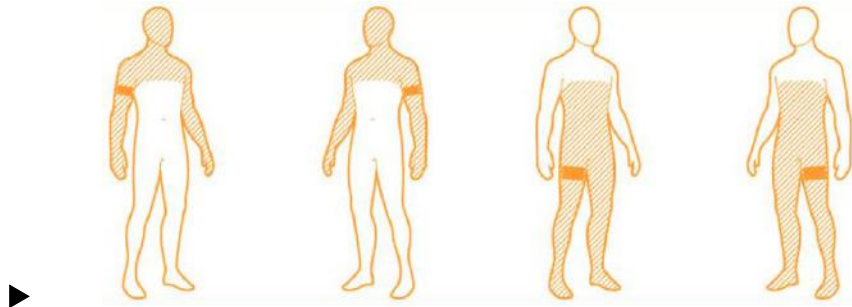

▶ *Figure 2-1: Application point of neutral electrode*

- For surgery in the thoracic region, do not run the current path transversely across the patient's body and ensure that the patient's heart is never in the current path.
- Depending on the surgical site, apply the neutral electrode to the nearest upper arm or thigh if possible, but never closer than 20 cm.
- In the case of self-adhesive disposable electrodes, comply with any further manufacturer instructions regarding the point of application.
- Ensure that the application area is free of scar tissue, bony protuberances, surface hair and ECG electrodes.
- Ensure that there are no implants (e.g. bone nails, bone plates or endoprotheses) in the current path.
- Ensure that no short circuits can occur at the neutral electrode connection.
- Avoid areas where fluids may collect.
- Use split neutral electrodes with a sufficiently large surface area (patient age and max. output power during operation have to be considered).

Before applying the neutral electrode

- ▶ Shave the area where the neutral electrode will be applied.
- ▶ Clean the application site, but do not use any alcohol, since it dries out the skin and increases the contact resistance.
- ▶ If the patient has poor circulation, massage or brush the application site.

- ▶ Attach the neutral electrode over the entire contact surface evenly. Secure reusable neutral electrodes with rubber bands or elastic straps so that they do not loosen when the patient moves. Ensure that the patient's circulation is not impaired (risk of necrosis).
- ▶ Never use wet clothes or conductive pastes.
- ▶ Ensure that no liquids (e.g. cleaning fluids, disinfectants, blood or urine) penetrate between the patient and the neutral electrode.
- ▶ Do not place the neutral electrode under the patient's buttocks or back.
- ▶ Ensure that there are no ECG electrodes in the current path of the HF device.
- ▶ Check the neutral electrode before and after use for damage and to ensure that they are working properly.
Replace defective accessories immediately

Example application using a disposable electrode

- ▶ Remove the protective film and attach the self-adhesive disposable electrode to the patient. Ensure that the long edge of the disposable electrode faces the operation site and the electrode is fully in contact with the skin. This avoids excessive current concentration on the short edge.
- ▶ Using both hands, press the self-adhesive disposable electrode firmly against the patient's skin.
- ▶ Clamp the electrode tab to the neutral electrode cable.
- ▶ After the operation, remove the disposable electrode carefully to avoid skin damage.

With a one-piece neutral electrode

- ▶ Check the one-piece neutral electrode during surgery.
- ▶ Ensure that the one-piece electrode is not blocked at the device.

With a split neutral electrode

- ▶ Apply the split neutral electrode correctly and without any additional objects, as otherwise the HF device may detect a path between the two sections due to other objects.
- ▶ See that the current flows equally to both parts of the split neutral electrode.



See Section Fault indications for EASY monitoring, page 69 regarding monitoring of the neutral electrode.

3. Description

3.1. User interface components

3.1.1. Front panel user interface components

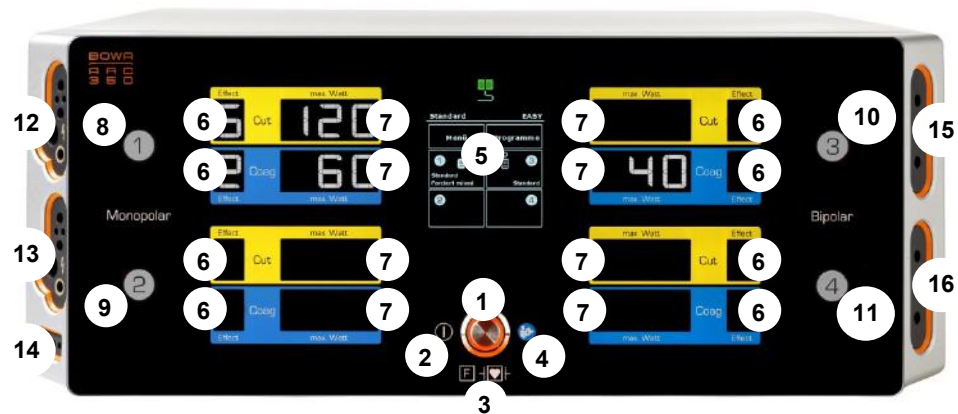

- 1 On/Off button
- 2 "CF-type device with defibrillation protection" icon
- 3 "Observe use instructions" icon
- 4 Touchscreen
- 6 Button Effect
- 7 Button maximum output power
- 8 Activation indication Monopolar 1
- 9 Activation indication Monopolar 2
- 10 Activation indication Bipolar 3
- 11 Activation indication Bipolar 4



While activating an instrument, the Activation indication of the corresponding socket illuminates yellow or blue.

3.1.2. Monopolar connector module (left)

- 12 Monopolar 1
Socket connector for monopolar instruments with hand or foot switch*
- 13 Monopolar 2
Socket connector for monopolar instruments with hand or foot switch*
- 11 Socket connector for neutral electrode *

* Applied part type F according to IEC 60601-1

Monopolar connection sockets



Alternative 1

- a** BOWA COMFORT 3-Pin US type
- b** Bovie (footswitch)
- c** 4 mm Socket (footswitch)

Alternative 2

- a** BOWA COMFORT 3-Pin US type
- b** Erbe 5 mm
- c** 4 mm socket (footswitch)

Connection socket for neutral electrode



- 14** Neutral (US type)

3.1.3. Bipolar connector module (right)

- 15** Bipolar 3
Socket connector for bipolar instruments with foot switch, finger switch or AUTOSTART*
- 16** Bipolar 4
Socket connector for bipolar instruments with foot switch, finger switch or AUTOSTART*

Bipolar connection sockets

Alternative 1:

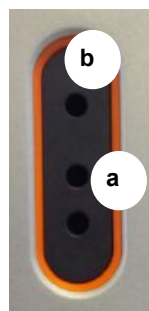

- a** BOWA COMFORT
- b** 2-pin US type (28.58 mm)

Alternative 2:



- a** BOWA COMFORT
- b** 2-pin US type (28.58 mm)
- c** Erbe VIO/ICC

* Applied part type F according to IEC 60601-1

3.1.4. Rear panel user interface components



- 17** Foot switch socket connector 1
- 18** Foot switch socket connector 2
- 19** Equipotential bonding terminal
- 20** IEC power cord connector
- 21** Fiber-optic signal input connector
- 22** Fiber-optic signal output socket connector

Use the following connections only for service and training purposes:



















- 23** Ethernet connector
- 24** USB connector
- 25** Audio In (not occupied)
- 26** UART communication interface
- 27** Power switch



The USB connector can be used to perform software updates.

The maximum voltage at the SIP/SOP ports is 15 V_{DC}.

3.2. Symbols used on the device

Symbol	Designation
	Foot switch connector
	Neutral electrode isolated from ground for HF
	CF-type device with defibrillation protection
	Alternating current
	On/off button
	During activation (of the HF device) RF energy in the radio frequency range 9 kHz to 400 GHz is applied, which produces electromagnetic radiation.
	Labeling of electrical and electronic devices in accordance with Directive 2002/96/EC (WEEE); see "Disposal"
	(Active) HF output; caution: hazardous voltage
	Manufacturer
	Date of manufacture
	Observe use instructions
	Equipotentiality connection
	Fiber-optic signal input
	Fiber-optic signal output
	Ethernet connector
	USB connector
	Audio In
	UART communication interface

3.2.1. Rating label



Figure 3-1: ARC 350 rating label

(Here: ARC 350 incl. options LIGATION and Bipolar Resektion, ARC 350 with option LIGATION bipolar output power changes to 200W, ARC 350 basic version provides a bipolar output power of 120W.)

3.3. Scope of delivery

You'll find detailed information on the scope of delivery in the current catalogues.

3.4. Components required for operation

- Power cable
- Foot switch
- Neutral electrode for monopolar applications
- Connection cable for neutral electrode or instrument
- Instrument (monopolar or bipolar)

3.5. Operating conditions

Temperature:	+10 °C to +40 °C
Relative humidity:	30 to 75%, non-condensing
Atmospheric pressure:	700 to 1060 hPa
Operating altitude (max.):	4000 m above sea level

4. Prearrangement

4.1. Setting up the HF device



NOTE

Electromagnetic fields are generated during normal use of the HF device. This can adversely affect other devices.

- ▶ Ensure that no electronic devices are placed in the vicinity of the HF device.



WARNING

Shock hazard

- ▶ Always connect the HF device to a grounded power distribution system in order to prevent electric shock.



DANGER

Risk of burns to patients due to excessive leakage current

- ▶ Locate the HF device outside the immediate vicinity of the patient, see section Ambient conditions, page 11.



HF devices may be used only in rooms used for medical purposes that meet the requirements of DIN VDE 0100-710.



If the HF device was previously stored or transported at temperatures below +10 °C or a relative humidity above 75%, non-condensing, it will take approximately three hours to adjust to room temperature.

1. Observe the specified operating conditions (see Section Operating conditions, page 22).
2. Place the HF device on one of the following platforms:
 - a table;
 - an equipment trolley;
 - a console suspended from a ceiling support or wall-mounted brackets.
3. Place the HF device a sufficient distance away from other electronic equipment, see Section EMC, page 120.
4. Position the HF device with the front of the device facing the patient and surgeon.
5. Do not place any other device on the HF device.

6. Do not place any other objects on or above the HF device.
7. Place the HF device on top of ARC PLUS only, do not place it on other devices.
8. Connect the power cord.

4.2. Switching on the HF device



Do not use the HF device if the display components are not working. See Section faults Detecting and correcting faults, page 63 for troubleshooting instructions.

1. Switch the HF device on using the on/off switch.
 - ↪ The HF unit performs a self-testing: All user interface components light up.
2. Check all controls and indicators for proper operation:
 - Power switch
 - Touchscreen
 - Monopolar socket connectors
 - Bipolar socket connectors
 - Activation indication for monopolar and bipolar sockets
- ↪ The main screen appears, and the HF device is ready for use.
- ↪ The parameters of the most recently selected program appear on the display.

4.3. Connecting instruments

- ▶ Before connecting instruments, ensure that the following conditions are met:
 - Combinations of accessories not mentioned in the operating manual may be used only if they are explicitly designed for the intended use. Always observe performance characteristics and safety requirements.
 - The insulation of the accessories (e.g. HF cables and instruments) must be sufficient for the maximum peak output voltage (see IEC 60601-2-2 and IEC 60601-2-18).
 - Do not use accessories with defective insulation.

4.3.1. Instruments for monopolar use

1. Plug the neutral electrode cable into the socket for the neutral electrode and choose the corresponding neutral electrode type, see chapter Selecting the neutral electrode, page 35.
 - ↪ The socket illumination goes dark.
 - ↪ The neutral electrode button changes from grey to the measurement colour (green, yellow or red).
2. Connect the electrode handle to one of the two monopolar socket connectors.
 - or –
 - In the case of an accessory without a finger button, connect a footswitch to the socket connector. Connect the Bovie connector of the monopolar cable to the socket connector.
 - or –
 - Connect the monopolar cable for endoscopy to one of the two monopolar socket connectors for monopolar instruments.

4.3.2. Instruments for bipolar applications

1. Connect the bipolar cable to the instrument (e.g. forceps).
 2. Connect the bipolar cable to one of the two bipolar socket connectors.
 3. For bipolar use without AUTOSTART, connect a footswitch to the socket connector.
 - or –
 - Use the AUTOSTART mode for the appropriate socket connector.
- ↪ Once the instrument is connected, the application starts after the configured delay time.

4.3.3. Connecting a foot switch

In addition to the manual switch, a foot switch can be used to activate various operating modes.

- ▶ Connect the desired foot switch only during operation to one of the two socket connectors for foot switches.
- ↪ The HF device automatically detects the connected foot switch and indicates this on the front panel display, including the selected socket connector.



One double-pedal foot switch and one single pedal foot switch can be connected. Foot switches without an orange changeover switch cannot be used. Only foot switch and fibre optics may be connected to the rear panel during operation.

The following foot switch systems can be connected to the HF device:

Item no.	Designation
901-011	Single-pedal foot switch with switch
901-031	Double-pedal foot switch with switch
901-032	Double-pedal foot switch with switch and clip

4.4. Functional test

4.4.1. Auto test function

The HF device automatically performs cyclic testing during operation. If any faults occur, see Section Detecting and correcting faults, page 63.

4.4.2. Functional testing

Perform the following functional test before putting the device into service:



The accessories must be designed for the specified maximum voltage.

1. Connect the neutral electrode and attach it securely to the patient's arm.
 - ↪ The EASY neutral electrode indicator changes to green.
2. Remove the neutral electrode.
 - ↪ The indicator changes to red, acoustic signals sound.



The neutral electrode used for this test may not later be used for an operation.

3. Connect a monopolar HF handle to a monopolar socket connector if there is a green EASY indicator and use the manual switch and footswitch to individually activate "Cut" and "Coag".
4. Check the settings on the display.
5. Now change to the bipolar output and connect bipolar forceps.
6. Select a mode with AUTOSTART, grasp moist gauze with the forceps, and check the display.
7. Now change to a mode without AUTOSTART and use the footswitch to activate the bipolar output. Check the settings and indicators in the bipolar section.

4.4.3. Actions in case of problems

Proceed as follows in case of functional problems:

1. Immediately disconnect the patient from the HF device.
2. Inspect the HF device and perform a functional test.
3. Report incidents and near-accidents to the German Federal Institute for Medications and Medical Products in accordance with Section 3 of the German Ordinance on the Installation, Operation and Use of Medical Products (MPBetreibV). Observe the provisions of the in-house reporting system in this regard.
4. Consult the Technical Service department, see Section Technical service, page 73.



The HF device can be switched off at any time by using on/off switch **27** as an emergency stop switch.

4.5. Neutral electrode monitoring



Always use the largest possible electrode when attaching a neutral electrode.

4.5.1. General information



BOWA recommends using split neutral electrodes, since only this type of electrode allows the HF device to detect detachment of the neutral electrode if this occurs.

Monitoring of the neutral electrode minimizes the risk of burns at the site where the neutral electrode is attached.

Two types of neutral electrodes can be monitored:

- Split electrodes for infants (for use with reduced power)
- Split neutral electrodes

The type of neutral electrode and its contact quality are selected and/or shown in Neutral Electrode Modes menu.

Faults related to the neutral electrode and possible remedies are shown on the display, see Section Detecting and correcting faults, page 63.

4.5.2. EASY neutral electrode monitoring (EASY monitoring)



The maximum output power of monopolar current types is reduced to 50 W when a children's electrode is selected.

The EASY monitoring function measures changes in the resistance between the patient and the high-frequency surgery device before and during HF activation. If necessary, it generates visual and audible alarms to request staff intervention. This requires using a split neutral electrode with appropriate contact areas and suitable contact resistance, attached to the patient according to the manufacturer's instructions. The EASY system does not monitor the currents through the individual contact surfaces of the split neutral electrode.

For the programs "Resection" and "Moderate Coagulation" a BOWA electrode with a surface area of at least 90 cm² must be used.

If an error message is generated, the display changes from green via yellow to red, depending on the type of fault.



NOTE

Risk of incorrect application of the neutral electrode

- ▶ Ensure compliance with the specifications for correct attachment of the neutral electrode with regard to size, adhesive properties and full-surface contact of the complete electrode.
-

5. Operation

5.1. Connecting power

☑ The line voltage must match the voltage specified on the rating label.
Connect the power cord to the generator and plug the cord into a grounded AC power outlet.

Use the power switch **27** on the rear side of the unit to switch on the device.



Use the on/off switch on the front panel to switch on the device.

- ↪ The device performs a functional test.
- ↪ The activation indicators illuminate.
- ↪ Full functionality of the loudspeaker is indicated by the start melody.

5.2. Program overview



Figure 5-1: Program overview

In the middle of the screen is the display to control the menu.

The activation indications and buttons to set the maximum output power and the effect are allocated next to the corresponding sockets.

The effect of electrosurgical cutting or coagulation can be set using the button "Effect".

The "max. Watt" button is used to set the maximum output power.

5.2.1. Display

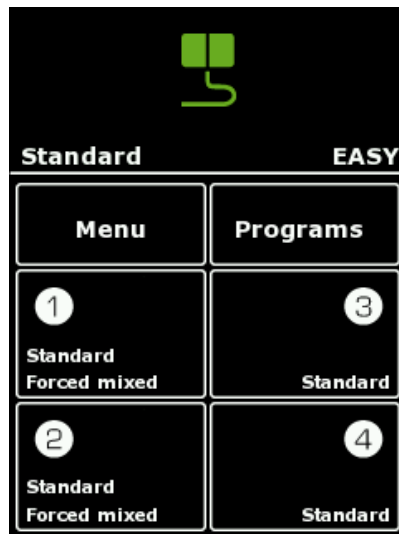

Figure 5-2: Standard display

In the upper segment of the display the "EASY" button is allocated.

In the lower part of the display the program name, the neutral electrode type, as well as the buttons "Menu", "Programs" and settings of the current type and pedal for the four sockets are allocated.

In combination with ARC PLUS and the selection of Argon modes, instead of the button "Programs" the "Argon" menu is shown.



In this case the program can be selected using Menu "Select program".

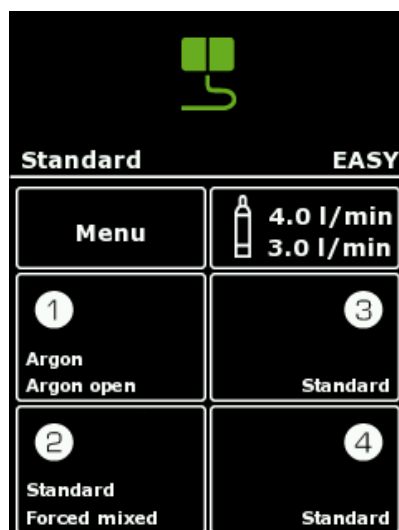

Figure 5-3: Argon display

5.3. Activating and deactivating connectors

- ▶ To activate a deactivated socket connector, plug a connecting cable into the connector.
– or –
Tap the activation indication of the associated socket.
- ↪ The selection field and the activation indication lights up.
- ▶ When detaching the instrument, the activation indicator extinguishes.
- ▶ To hide sockets tap the activation display of the associated socket.
- ↪ The parameters for maximum power and effect are grayed out.

5.4. Configuring output currents



All selection windows are closed after 30 seconds without assumption of the modification.



If selection screens are present, buttons outside the screen stay active and when being touched close the present screen without modification. In addition, activations not possible in this case.



A change to the currently loaded program, e.g. by adjusting the power level, is indicated by a red illuminated program name.

5.4.1. Selecting the mode

1. To select the type of current, select the setting of the respective socket.
- ↪ A menu appears to select the program, the foot switch assignment as well as the modes for cutting or coagulation.

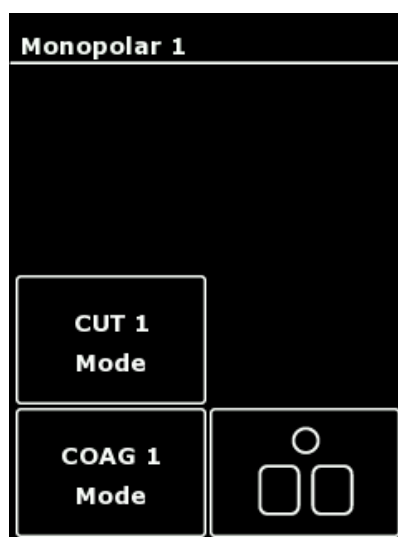

Figure 5-4: Menu Monopolar 1

2. Choose the menu of the required current type using the "Mode" button.
- ↪ A selection screen appears for the available modes.
- ↪ The active mode is indicated with an orange arrow.



Figure 5-5: Modes monopolar cutting

3. Select the required mode using the arrow keys.
 - or -
 - Deactivate the mode by selecting "Off".
 4. Confirm the selection with the "OK" button.
- ↪ The main screen is displayed.
- or -
- To return to the main screen without changing the selection, select "Back" or tap any button outside the selection menu.



If a mode is changed within a socket, the set parameters e.g. effect and max. Watt, remain the same for the respective mode. However, if, for example, the factory default setting of a mode is adapted and subsequently changed to a different mode and then back again, the user changes are not undone.

5.4.2. Specifying power limits

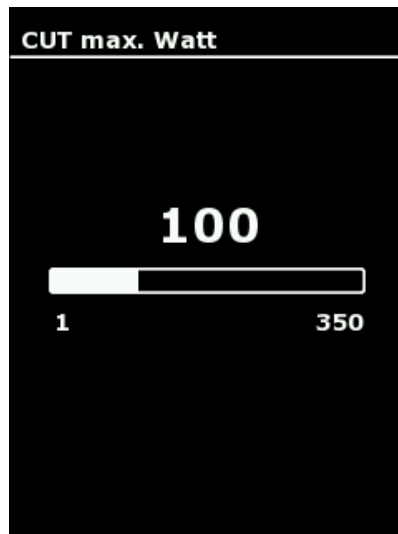

Figure 5-6: Power limit monopolar cutting

1. To select the maximum power tap the parameters below the display "max. Watt".
2. Use the "+" and "-" buttons to adjust the power level.
3. Confirm your selection by pressing the "OK" button.
- or -
To return to the main screen without changing the selection, tap any button outside the selection menu.

5.4.3. Selecting the effect

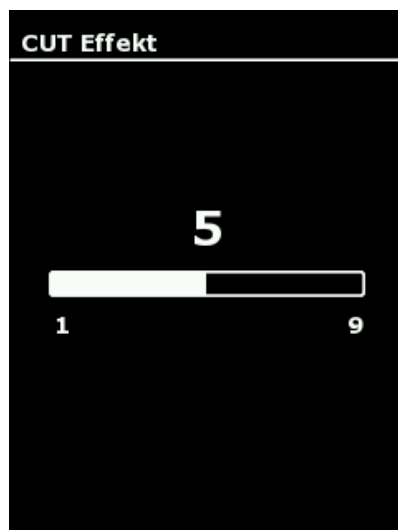

Figure 5-7: Effect monopolar cutting

1. To select the maximum power tap the parameters below the display "Effect".
2. Use the "+" and "-" buttons to adjust the effect.

3. Confirm your selection by pressing the "OK" button.
 - or -
 To return to the main screen without changing the selection, tap any button outside the selection menu.

5.4.4. Assigning the foot pedal



Handles and instruments with manual switches can be activated without a configuration setting.

A single-pedal foot switch and/or double-pedal foot switch, each with a changeover switch, can be connected,

The changeover switch enables switching between pedal levels.

1. Select the foot switch menu using the selection of the respective socket
 ↪ A menu appears for selecting the program, foot switch assignment as well as modes for cutting or coagulation.
2. Enter the selection menu of the footswitch using the "Pedal" button on.

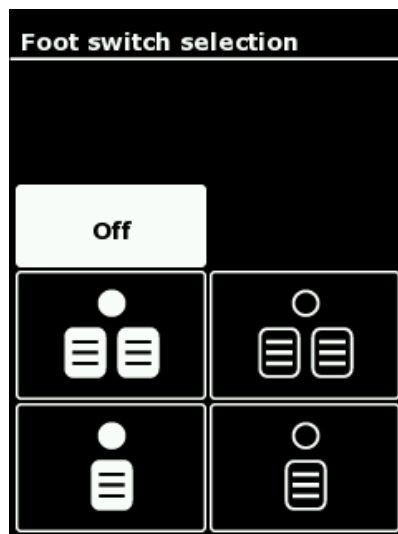

Figure 5-8: Foot switch selection

3. Select the required foot switch by pressing the corresponding button.
 For example, you could select the active pedal level for cutting, and coagulation for the top, left-hand socket.
 - or -
 Deactivate the footswitch using the "Off" button.
4. Confirm the selection by pressing the "OK" button.
 - or -
 To return to the main screen without changing the selection, tap any button outside the selection menu.

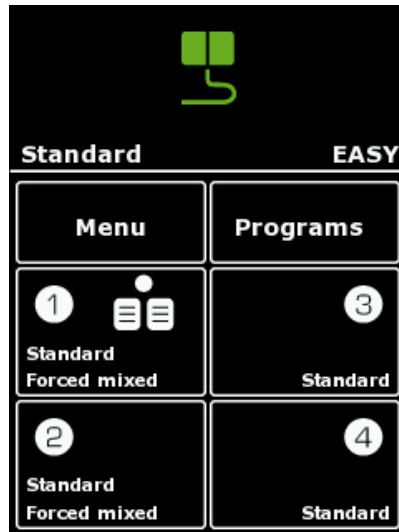

Figure 5-9: Foot switch changeover

- Pedal levels can be changed using the foot switches. Press the orange button to change the socket.



If two footswitches are connected, either a single-pedal footswitch or a double-pedal footswitch can be selected for coagulation.

5.4.5. Selecting the neutral electrode

- Press the "EASY" button in the upper segment of the display to select the neutral electrode.
- or -
Alternatively, use "Menu" "neutral electrode" to select the neutral electrode.
- ↪ The neutral electrode menu with a display of contact quality as well as selection of the neutral electrode types is shown.
 - ↪ The selected neutral electrode type is displayed in white.

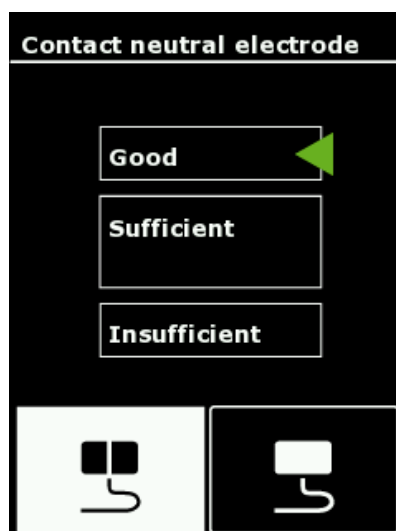

Figure 5-10: Neutral electrode menu

2. Select the type of connected electrode by selecting the icon for split or non-split neutral electrodes.
3. In the selection of split neutral electrodes there is also a reduced power mode for children electrodes available



The maximum power output of monopolar current types is reduced to 50 W when a children's electrode is selected.

4. Confirm your selection by pressing the "OK" button.
- or -
To return to the main screen without changing the selection, tap any button outside the selection menu.
- ↪ The selected type of neutral electrode in connection with a colour-indicator for the contact quality is shown in the status bar.



When using the "EASY" and "BABY" mode, no non-split electrodes are accepted. Using the "MONO" mode, no split electrodes are accepted.

According to the contact quality, several icons are shown for neutral electrodes:

Icon / Button	Description	Icon / Button	Description
	Split neutral electrode contact quality OK		Non-split neutral electrode contact quality OK
	Split neutral electrode contact quality not optimum		Not Detected non-split neutral electrode or connected or contact quality insufficient
	Split neutral electrode not connected or contact quality insufficient		Display the contact quality.

5.4.6. Plug'n Cut COMFORT

The automatic instrument identification Plug'n Cut COMFORT recognises the connected BOWA COMFORT instrument and selects the default parameters automatically.

1. Insert the COMFORT instrument into a socket of ARC 350.
↳ The accepted parameters are displayed

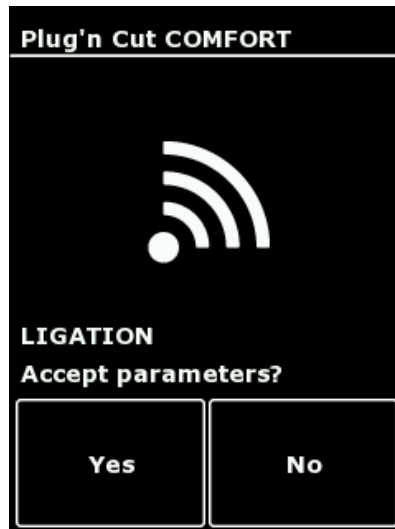

Figure 5-11: Plug'n Cut COMFORT

2. Confirm the selection of preferred parameters with "Yes".
- or -
Return to the main screen without accepting the preferred parameters with "No".



This function is available if the device has an option Argon / GastroCut, Bipolar Resection or LIGATION.

5.5. Mode overview

An overview of the programs that can be executed with the HF device is shown below.

5.5.1. Monopolar modes

Monopolar Cutting	Monopolar Coagulation
Standard	Moderate
Micro	Forced coag
Dry	Forced mixed
MetraLOOP	Forced cutting
Resection	Spray
Laparoscopy	Laparoscopy
Argon *	Argon open*
GastroLOOP 1 ^G	Argon flexible ^{*G}
GastroLOOP 2 ^G	Argon flex. pulse ^{*G}
GastroLOOP 3 ^G	Gastro Coag ^G
GastroKNIFE 1 ^G	Resection
GastroKNIFE 2 ^G	Mammary
GastroKNIFE 3 ^G	Thorax
	SimCoag



* These modes can only be used in connection with the argon coagulation unit ARC PLUS (900-001).

^G These modes are available with the option Argon / GastroCut (900-391).

5.5.2. Bipolar modes

Bipolar Cutting	Bipolar Coagulation
Bipolar Cutting	Standard
Bipolar Resection ^R	Standard AUTO
Bipolar Scissors	Micro
	Forced
	LIGATION ^L
	TissueSeal PLUS ^L
	Bipolar Scissors
	Laparoscopy
	Bipolar Resection ^R



^R These modes are available with the option Bipolar Resection (900-395).

^L These modes are available with the option LIGATION (900-396).



The information and data regarding settings, application points, application duration and instrument use are based on clinical practice. However, these are only basic guidelines which must be tested for suitability by the operator. Depending on individual conditions, it may be necessary to deviate from the provided data.

Medical practice is continuously evolving as a result of R&D and clinical experience. This may also make deviations from the provided data necessary.

5.6. Monopolar cutting modes

5.6.1. Standard

In this mode a high-performance HF current with a low crest factor is used for cutting biological tissue. ARC CONTROL quickly adjusts the power output to the minimum required level in response to variations in tissue type and changes in the cutting area or speed.

Application areas

Cutting tissue with low electrical resistance, such as muscle tissue or vascular tissue.

Cutting or preparing fine structures

Suitable instruments

- Needle electrodes
- Knife electrodes
- Spatula electrodes
- Sling electrodes

5.6.2. Micro

This mode is used for electrosurgical cutting using micro-electrodes. It enables extremely fine control of the power level and precise work.

Application areas

Paediatric surgery, neurosurgery, plastic surgery

Suitable instruments

- Micro needle electrodes

5.6.3. Dry

This mode is used for monopolar dry cutting. A large, controlled arc is generated, which allows significantly deeper coagulation to be obtained.

Application areas

Cardiac surgery and blood coagulation in retracting blood vessels in the sternum region.

Suitable instruments

- Knife electrodes

5.6.4. Argon

This mode is used to perform open surgical interventions in combination with the ARC PLUS companion device for argon-assisted cutting. With suitable instruments connected, argon-assisted cutting can be performed using rigid electrodes.

Application areas

Visceral surgery

Suitable instruments

- Rigid argon electrodes
- Argon handles

5.6.5. Resection

This mode is used in gynaecology and urology. ARC control generates the cutting effect with simultaneously minimized output power. ARC control facilitates direct cutting and prevents electrode adhesion.



Use non-conductive irrigation fluids.

Application areas

Hysteroscopy, transurethral prostate resection (TUR-P), surgical treatment of bladder tumors (TUR-B), vaporization of prostate tissue (TUR-VAP).

Suitable instruments

- Resectoscope (monopolar)
- Resection snare
- Rollerblade electrode

5.6.6. MetraLOOP

This mode is used in gynaecology for laparoscopic hysterectomy. Removal of the uterus can be achieved by applying monopolar cutting current and pulling on the snare at the same time.

Application areas

Gynaecology; laparoscopic hysterectomy

Suitable instruments

- Gynaecological laparoscopic snares

5.6.7. Laparoscopy

This mode is used in laparoscopy and arthroscopy for monopolar cutting.

Application areas

Laparoscopy, arthroscopy

Suitable instruments

- Arthroscopy electrodes
- Laparoscopy electrodes

5.6.8. GastroLOOP 1 (optional)

This mode is used in gastroenterology. Polypectomy snares are used for cutting and coagulation. ARC control generates the cutting effect with simultaneously minimized output power. This mode consists of a series of cutting current pulses followed by a coagulation phase. With a relatively slow pulse rate of 1 cutting pulse per second, this mode is suitable for especially cautious work.

Application areas

Polyp removal using polypectomy snares and flexible endoscopy

Suitable instruments

- Polypectomy snares



This function is available if the device has the options argon / GastroCut (900-391).

5.6.9. GastroLOOP 2 (optional)

This mode is used in gastroenterology. Polypectomy snares are used for cutting and coagulation. ARC control generates the cutting effect with simultaneously minimized output power. This mode consists of a series of cutting current pulses followed by a coagulation phase. With an accelerated pulse rate of 1.8 cutting pulses per second, this mode is suitable for experienced users.

Application areas

Polyp removal using polypectomy snares and flexible endoscopy, with accelerated pulse rate for experienced users.

Suitable instruments

- Polypectomy snares



This function is available if the device has the options argon / GastroCut (900-391).

5.6.10. GastroLOOP 3 (optional)

This mode is used in gastroenterology. Polypectomy snares are used for cutting and coagulation. ARC control generates the cutting effect with simultaneously minimized output power. This mode consists of a series of cutting current pulses followed by a coagulation phase. With an accelerated fast pulse rate of 3.2 - 5 cutting pulses per second, this mode is suitable for advanced users.

Application areas

Polyp removal using polypectomy snares and flexible endoscopy, with accelerated fast pulse rate for advanced users.

Suitable instruments

- Polypectomy snares



This function is available if the device has the options argon / GastroCut (900-391).

5.6.11. GastroKNIFE 1 (optional)

This mode is used in gastroenterology. Instruments for papillotomy and endoscopic resections are used for cutting and coagulation. ARC control generates the cutting effect with simultaneously minimized output power. This mode consists of a pulse sequence of cutting current and coagulation phase. With a relatively slow pulse rate of 1.3 cutting pulse per second, this mode is suitable for especially cautious work.

Application areas

Papilla incision using a papillotome and flexible endoscopy, resection with needle knives; slow pulse rate for cautious work.

Suitable instruments

- Papillotome
- Needle knives



This function is available if the device has the options argon / GastroCut (900-391).

5.6.12. GastroKNIFE 2 (optional)

This mode is used in gastroenterology. Instruments for papillotomy and endoscopic resections are used for cutting and coagulation. ARC control generates the cutting effect with simultaneously minimized output power. This mode consists of a pulse sequence of cutting current and coagulation phase. With an accelerated pulse rate of 1.7 cutting pulses per second, this mode is suitable for experienced users.

Application areas

Papilla incision using a papillotome and flexible endoscopy, resection with needle knives; accelerated pulse rate for experienced users.

Suitable instruments

- Papillotomes
- Needle knives



This function is available if the device has the options argon / GastroCut (900-391).

5.6.13. GastroKNIFE 3 (optional)

This mode is used in gastroenterology. Instruments for papillotomy and endoscopic resections are used for cutting and coagulation. ARC control generates the cutting effect with simultaneously minimized output power. This mode consists of a pulse sequence of cutting current and coagulation phase. With an accelerated fast pulse rate of 2.2 cutting pulses per second, this mode is suitable for advanced users.

Application areas

Papilla incision using a papillotome and flexible endoscopy, resection with needle knives; accelerated fast pulse rate for advanced users.

Suitable instruments

- Papillotome
- Needle knives



This function is available if the device has the options argon / GastroCut (900-391).

5.7. Monopolar coagulation modes

5.7.1. Moderate

This mode is used with contact coagulation to stop hemorrhagic oozing, for hemostasis of relatively large tissue areas, and for small-area coagulation. Tissue carbonization is prevented and electrode adhesion to the tissue is strongly reduced. Greater coagulation depth is achieved in this mode than in other coagulation modes. The degree of surface scabbing can be controlled by adjusting the "Effect" setting in the range of 1 to 3.

Application areas

Coagulation with relatively high penetration depth; low electrode adhesion to tissue

Suitable instruments

- Electrodes with large contact areas, such as ball electrodes

5.7.2. Forced coag

This mode is used for contact coagulation with low tissue penetration, preferably using fine electrodes and electrodes with small contact areas. It achieves a high degree of coagulation with low cutting tendency.

Application areas

Fast coagulation with small penetration depth

Suitable instruments

- Ball electrodes
- Knife electrodes
- Spatula electrodes

5.7.3. Forced mixed

This mode is used for contact coagulation with low tissue penetration, preferably using fine electrodes and electrodes with small contact areas. It achieves a high degree of coagulation with moderate cutting tendency.

Application areas

Fast coagulation with small penetration depth and moderate cutting tendency

Suitable instruments

- Knife electrodes
- Spatula electrodes
- Insulated monopolar forceps

5.7.4. Forced cutting

This mode is used for contact coagulation with low tissue penetration, preferably using fine electrodes and electrodes with small contact areas. It achieves good hemostasis with very good cutting tendency.

Application areas

Fast coagulation with small penetration depth and very good cutting tendency

Suitable instruments

- Knife electrodes
- Spatula electrodes
- Needle electrodes

5.7.5. Spray

This mode is used with non-contact surface coagulation using an arc, for hemostasis in parenchymal tissue, in poorly accessible crevices, and in conjunction with argon coagulation.

Application areas

Promoting coagulation of diffuse bleeding

Suitable instruments

- Ball electrodes
- Knife electrodes
- Spatula electrodes
- Needle electrodes

5.7.6. Argon open

This mode is used for open surgical interventions in conjunction with the ARC PLUS accessory device for argon-assisted electrocoagulation.

This is the current type Spray.

With suitable instruments connected, argon-assisted coagulation can be performed using rigid electrodes.

Application areas

Visceral surgery

Suitable instruments

- Rigid argon electrodes
- Argon handpiece

5.7.7. Argon flexible (optional)

This mode is used for argon-assisted electrosurgery in conjunction with the ARC PLUS accessory device.

This is the current type Spray.

For argon-assisted coagulation, flexible probes are used in combination with endoscopes.

Application areas

Gastroenterology, homogeneous surface coagulation

Suitable instruments

- Flexible argon probes



This function is available if the device has the options argon / GastroCut (900-391).

5.7.8. Argon flex. pulse (optional)

This mode is used for argon-assisted electrosurgery in conjunction with the ARC PLUS accessory device.

This is the current type Spray.

For argon-assisted coagulation, flexible probes are used in combination with endoscopes.

The puls frequency changes with the effect setting. The higher the effect level, the faster the pulse sequence.

Application areas

Gastroenterology, homogeneous surface coagulation

Suitable instruments

- Flexible argon probes



This function is available if the device has the options argon / GastroCut (900-391).

5.7.9. Resection

This mode is used for monopolar hemostasis in gynaecology and urology.



Use non-conductive irrigation fluids.

Application areas

Hysteroscopy, transurethral prostate resection (TUR-P), surgical treatment of bladder tumors (TUR-B), vaporization of prostate tissue (TUR-VAP).

Suitable instruments

- Resectoscope (monopolar)
- Resection snare
- Rollerblade electrode

5.7.10. Cardiac Mammary

This mode is used in mammary surgery and cardiac surgery. It produces forced coagulation.

Application areas

Mammary surgery and cardiac surgery

Suitable instruments

- Knife electrodes

5.7.10. Cardiac Thorax

This mode is used in thoracic surgery. It produces forced coagulation.

Application areas

Thoracic surgery

Suitable instruments

- Knife electrodes

5.7.11. SimCoag

This mode is used for simultaneous preparation. Two monopolar socket connectors can be activated at the same time to enable the simultaneous use of two manually switched instruments. Both handles can be switched on and off independently.

The current type changes with the effect setting:

Effect 1: Forced cutting

Effect 2: Forced mixed

Effect 3: Spray



The output power setting applies to both output sockets, and the power is distributed according to the tissue structure.

Application areas

Simultaneous coagulation and preparation, e.g. for cardiac or mammary surgery

Suitable instruments

- Ball electrodes
- Knife electrodes
- Spatula electrodes

5.7.12. Gastro Coag (optional)

This mode is used in gastroenterology with contact coagulation for the coagulation of small areas.

Application areas

After bleeding associated with polypectomy or papillotomy.

Suitable instruments

- Polypectomy snares
- Papillotome



This function is available if the device has the options argon / GastroCut (900-391).

5.7.13. Laparoscopy

This mode is used in laparoscopy and arthroscopy for monopolar coagulation.

Application areas

Laparoscopy, arthroscopy

Suitable instruments

- Arthroscopy electrodes
- Laparoscopy electrodes

5.8. Bipolar cutting modes

5.8.1. Standard

This mode is used for cutting with bipolar laparoscopic instruments.

Application areas

Laparoscopic cutting

Suitable instruments

- Laparoscopic instruments

5.8.2. Bipolar resection (optional)

This bipolar mode is used in gynaecology and urology for cutting under saline. ARC control technology generates the cutting effect with simultaneously minimized output power. ARC Control facilitates immediate cutting and prevents electrode adhesion.



Make sure that NaCl is used as an irrigation medium.
Secure a continuous irrigation during the application.
Always use conductive lubricants to avoid damages of the urethra.
Avoid continuous activations.

Application areas

Hysteroscopy, transurethral prostate resection (TUR-P), surgical treatment of bladder tumors (TUR-B), vaporization of prostate tissue (TUR-VAP).

Suitable instruments

- Resectoscope (bipolar)
- Resection snare
- Rollerblade electrode



This function is available if the device has the options Bipolar Resection (900-395).



Optimum results are provided exclusively when using BOWA COMFORT resection cables.

5.8.3. Bipolar scissors

This mode is used with bipolar scissors. It can be used for coagulation before or during cutting, point coagulation, coagulation of cuts and surface coagulation.

Application areas

Preparation, coagulation and cutting of tissue

Suitable instruments

- Bipolar scissors



Bipolar scissors should only be operated with the current type bipolar scissors cutting or bipolar scissors coagulation.

5.9. Bipolar coagulation modes

5.9.1. Standard forceps

This mode is used for arcless contact coagulation with forceps.

Application areas

Bipolar coagulation

Suitable instruments

- Bipolar forceps

5.9.2. Standard forceps AUTO

This mode is used for arcless contact coagulation with forceps. Activation starts automatically on contact with tissue.

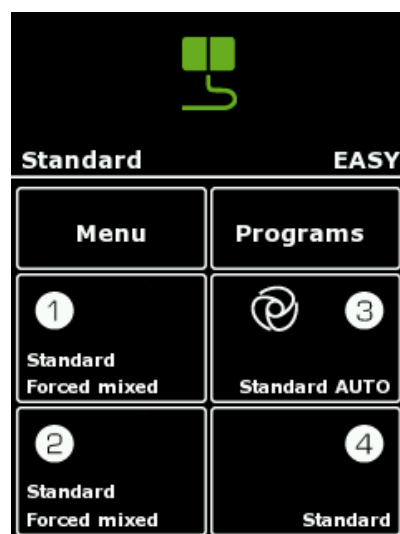

Figure 5-12: AUTOSTART at socket 3

The adjustable delay time can be set under MENU – SYSTEM SETTINGS – AUTOSTART DELAY.



Setting the AUTOSTART mode can result in unintentional coagulations, e.g. when bipolar forceps are used for gripping while the AUTOSTART Mode is on.

Application areas

Bipolar coagulation with AUTOSTART

Suitable instruments

- Bipolar forceps

5.9.3. Micro forceps

This mode is used for arcless contact coagulation with micro forceps. It enables extremely fine control of power output down to 0.1 W and precise work for tightly restricted bipolar contact coagulation.

Application areas

Bipolar coagulation in paediatric surgery, neurosurgery, plastic surgery, etc.

Suitable instruments

- Bipolar forceps
- Micro forceps

5.9.4. Forceps forced

This mode is used for forced coagulation with forceps.

Application areas

Fast bipolar coagulation

Suitable instruments

- Bipolar forceps

5.9.5. LIGATION (optional)

This mode is used for the permanent sealing of veins, arteries and tissue bundles. Conventional instruments cannot be used in this mode. The output power is preconfigured and automatically regulated.

Application areas

Vessel sealing open and laparoscopic

Suitable instruments

- TissueSeal®
- TissueSeal® PLUS
- NightKNIFE®
- LIGATOR®



This function is available if the device has the option LIGATION (900-396)

5.9.6. TissueSeal PLUS (optional)

This mode is used for the permanent sealing of veins, arteries and tissue bundles with TissueSeal PLUS® for open surgical applications. Conventional instruments cannot be used in this mode. The output power is preconfigured and automatically regulated.

Application areas

Vessel sealing in open surgery

Suitable instrument

- TissueSeal PLUS®



This function is available if the device has the option LIGATION (900-396)

5.9.7. Bipolar scissors

This mode is used with bipolar scissors. It can be used for coagulation before or during cutting, point coagulation, coagulation of cuts and surface coagulation.

Application areas

Preparation, coagulation and cutting of tissue

Suitable instruments

- Bipolar scissors



Bipolar scissors should only be operated with the current type bipolar scissors cutting or bipolar scissors coagulation.

5.9.8. Laparoscopy

This mode is used for coagulation in combination with bipolar laparoscopic instruments.

Application areas

Laparoscopic coagulation

Suitable instruments

- Laparoscopic instruments

5.9.9. Bipolar resection (optional)

This mode is used for bipolar haemostasis in gynaecology and in urology for cutting under saline.



Use NaCl as irrigation fluid.

Application areas

Hysteroscopy, transurethral prostate resection (TUR-P), surgical treatment of bladder tumours (TUR-B), vaporization of prostate tissue (TUR-VAP)

Suitable instruments

- Resectoscope
- Resection snare
- Rollerblade electrode



Make sure that the instrument has contact with the tissue while activating bipolar coagulation to avoid an unintended heating of the irrigation fluid.



This function is available if the device has the option Bipolar Resection (900-395)

5.10. Menu dialogs



The menu dialogs specify the settings of basic parameters, such as the user interface language and audio, display and memory options.

5.10.1. Overview

The following menu dialogs are available:

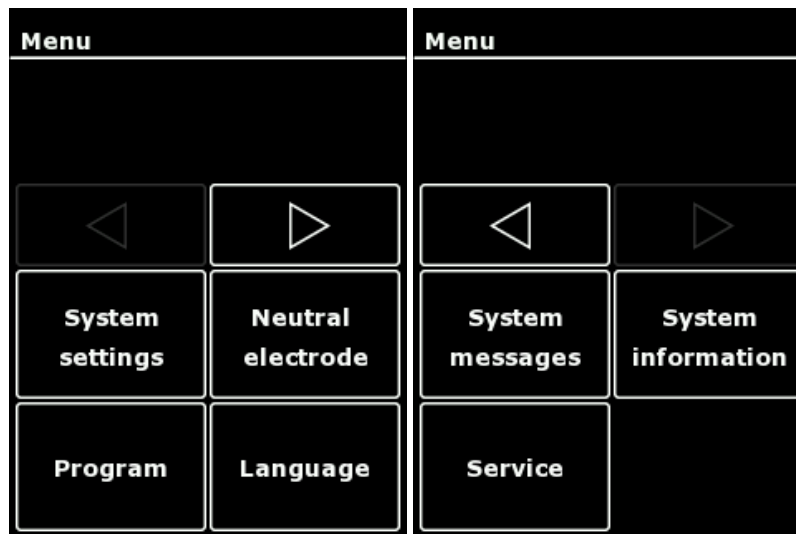

Figure 5-13: Menu dialogs

Selecting a dialog

- ▶ Switch to the required function with the horizontal arrow keys, and press the appropriate selection button to open the menu.

Exiting a dialog

- ▶ Press the "OK" button to return to the main screen.

5.10.2. "System Settings" dialog

The "System" menu allows settings for brightness and volume of the alarm activation and key tones, as well as autostart delay.

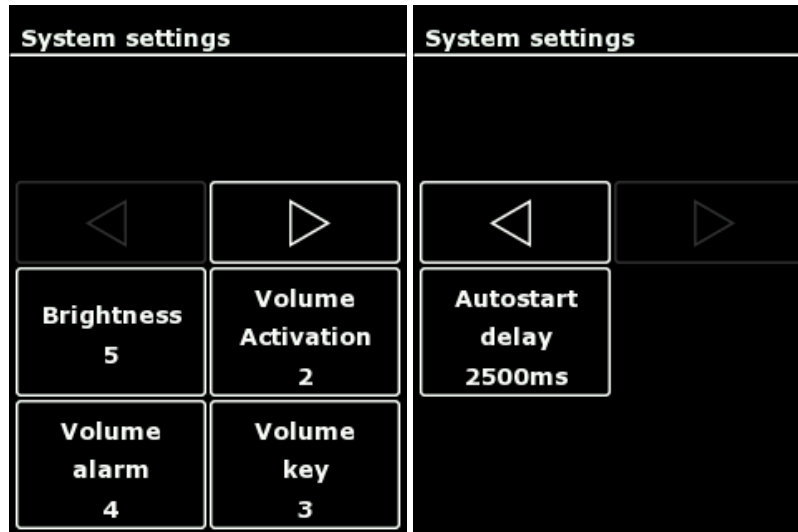

Figure 5-14: "System settings" dialog

1. To change the system settings, tap the desired parameter.
2. Change the setting in single steps with the keys "+" and "-"
3. Confirm the selection with the "OK" button.
- or -
To return to the main screen without changing the selection, tap any button outside the selection menu.



The volume of the activation signal should be increased as necessary for use in relatively noisy surroundings. The alarm tones have a minimum volume and limited changeability.

Mode	Category	Frequency (Hz)	Signal type
Monopolar Cut	Activation tones	635	Continuous sound
Monopolar Coag	Activation tones	475	Continuous sound
Bipolar Cut	Activation tones	565	Continuous sound
Bipolar Coag	Activation tones	505	Continuous sound
Sim Coag	Activation tones	755	Continuous sound
GastroCut /LIGATION end	Alarm tones	-	alternating sound
Error	Alarm tones	-	Signal tone
Warning	Alarm tones	-	Signal tone
Note	Alarm tones	-	Signal tone

5.10.3. "Neutral electrode" dialog

In the "Neutral electrode" menu the connected neutral electrode type is selected and the contact quality is displayed, see chapter Selecting the neutral electrode, page 35.

5.10.4. “Program“ dialog

In the “program“ dialog it is possible to choose, delete, sort and save programs.



Figure 5-15: Menu "Program"

Select program

1. Tap "Select program" to enter the program list.

Fast settings of this menu are possible by tapping the socket menu on the main screen, see chapter Selecting the mode, page 31.

↪ A list of saved programs appears.

↪ The currently loaded program is visualized by the orange arrow.

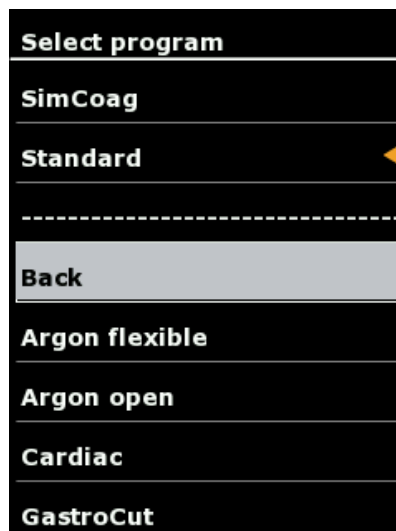

Figure 5-16: "Select program" dialog

2. Select the desired program by using the arrow keys.
3. Confirm the selection with the “OK“ button

↪ The main screen is displayed

- or -

To return to the main screen without changing the selection, select "Back" or tap any button outside the selection menu.

Delete Program

1. Tap "Delete program" to enter the program list
 - ↪ The system displays a red highlighted list of stored programs.
 - ↪ The currently loaded program is visualized by the orange arrow.
 4. Select the program to be deleted with the arrow keys.
 5. Confirm the selection with the "OK" button.
 - ↪ The main screen is displayed.
- or -
- To return to the main screen without changing the selection, select "Back" or tap any button outside the selection menu.

Sort program

1. Tap "Sort program" to sort the programs alphabetically, by favourites or by storage date.
2. Select the required order by tapping on the desired parameter.
- ↪ The "Program" dialog is displayed.

Save program

1. Tap "Save program" to save the current setting under the same or another program name.
 2. Choose "Save" to maintain the same program name for the current setting.
- or -
- Select "Save As" to place a new program name for the current setting.

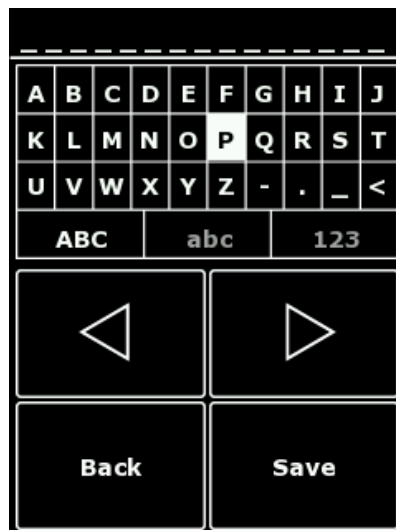

Figure 5-17: "Save program" dialog

In this menu, program names can be created. Several symbols, capital or small letters or numbers are selection options.

The navigation is possible using the arrow keys.

Select the letter with "OK".

The selection is confirmed using "Save".

Use the "Back" button to return to the main screen



The following basic programs are provided with the full version of ARC 350 (incl. the options GastroCut, Bipolar Resection and LIGATION): Argon flex, Argon, Cardiac, GastroCut, Laparoscopy, Macro, Micro, Open Surgery, Resection bipolar, Resection monopolar, SimCoag, Standard

5.10.5. "Language" dialog

The following languages are selectable in „language selection“:
 German, English, French, Italian, Spanish, Russian, Polish, Turkish, Czech, Portuguese

5.10.6. "System messages" dialog

In the "System messages" dialog, it is possible to open the saved system messages which have occurred since switching on the HF device.

These messages are not saved when switching off the HF device.

Opening saved system messages:

1. Select a system message.
2. Tap "OK" to open the system message again.
3. Press again "OK" to return to the overview.
4. To return to the main screen without changing the selection, tap any button outside the selection menu.

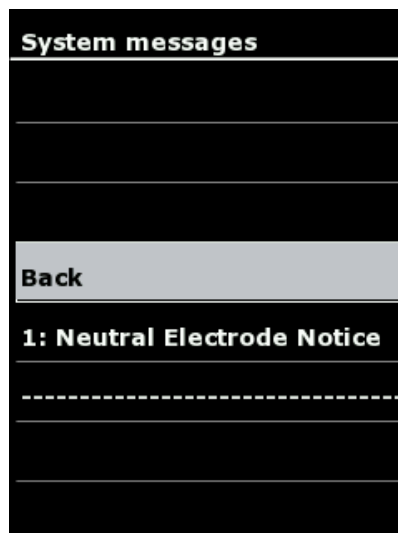

Figure 5-18: "System messages" dialog

5.10.7. "System information" dialog

The "System information" dialog displays various system parameters such as version, serial number, TSI dates for ARC 350 and ARC PLUS, as well as options.



Figure 5-19: "System information" dialog

See also technical safety inspection (TSI), page 71.

5.10.8. "Service" dialog

In the "Service" dialog contact detail are displayed, after entering a password, you can use the dialog to access additional options.

With the password **001224** you enter the service level.



Figure 5-20: "Service tools" dialog

Saving device settings

With the function "Backup device" device settings can be saved on the BOWA USB Stick (REF 900-402). This includes all stored programs and system settings.

Transferring device settings

Use "Restore device" to transfer saved device settings from a BOWA USB Stick (REF 900-402) to the ARC 350 unit.

EASY resistance monitor

With "EASY monitor" the resistance at the neutral electrode is displayed.

Configuring the startup screen

In ARC 350 is a possibility to create a personalized startup screen. This appears after switching on the device for a selectable duration.

1. Create a folder with the name "arc_logo" on the USB flash drive (REF 900-402).
 2. Open the Windows program " Notepad.exe " and enter a number between 5 and 60 for the displayed duration in seconds.
 3. Save this file on the USB flash drive in the folder "arc_logo" under the name "KH_Logo.conf". Make sure that the file is stored as type "All Files (*. *)" and encoding "UTF -8".
 4. Create a startup screen with a resolution of 240 x 320 pixels and save it under the name "KH_Logo_arc350.png" in the folder "arc_logo".
 5. Plug the USB flash drive with the files created in the USB port of the ARC 400 and turn the unit on using the main switch.
 6. Wait until the ARC 350 is fully booted and the user interface appears.
 7. Turn on the ARC 350 and remove your USB flash drive.
- ☞ Now your generated startup screen is permanently stored in the device and appears after every switching-on for the specified duration.

In the service menu, the stored startup screen can be deleted using "Remove logo".

Resetting to factory settings

The "Reset to default" function allows you to reset all settings and programs to factory settings.

5.10.9. "Argon" dialog

In case of the selection of an argon mode and a successful connection to ARC PLUS, the main screen displays an argon dialog with currently stored flow rates for cutting and coagulation.

The "Argon" dialog enables the selection of argon flow rates for cutting and coagulation, as well as the selection of argon bottles and the display of filling levels.

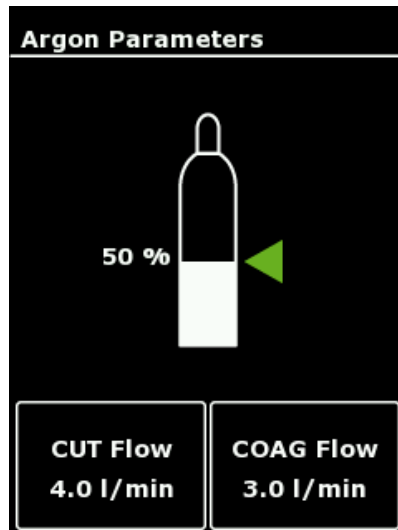

Figure 5-21: "Argon" dialog

1. Select the "Argon" menu by tapping the display of the flow rates.
 - ↳ The current filling level of the argon gas bottle is displayed when using a pressure reducer with electronic pressure sensor.
2. Select the variable flow rate for cutting (CUT flow) or coagulation (COAG flow).
3. Set the argon flow rate by using the arrow keys.
4. Confirm your selection by pressing the "OK" button.
 - or -
 - Press the "Back" button to return to the main screen without changing the selection.



Default settings for argon flow rates according to the different modes are selected automatically:

Argon open:
CUT flow rate: 4.0 l/min
COAG flow rate: 3.0 l/min

Argon flexible:
COAG flow rate: 0.4 l/min

6. Detecting and correcting faults

Two types of faults can occur:

- system faults
- EASY monitoring faults

6.1. System informations

A warning message appears on the display when a system fault occurs.

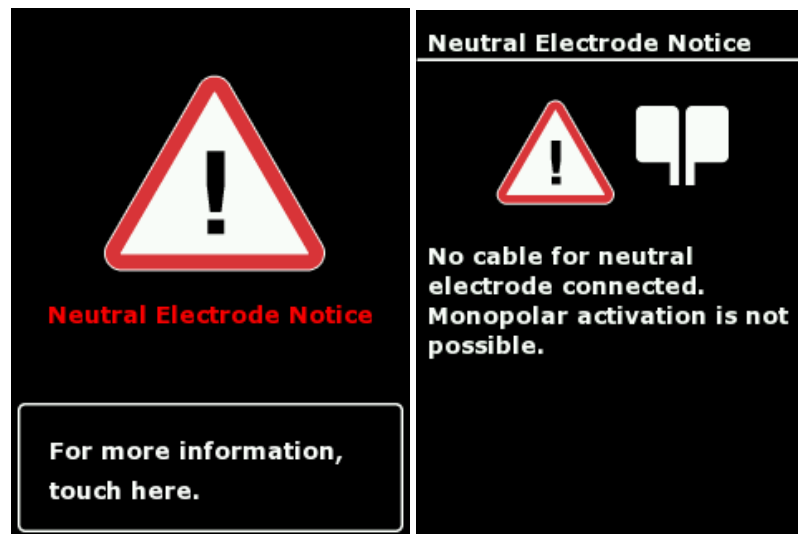

Figure 6-1: Confirmation neutral electrode

Further information to the cause and corrective measures for this message are available pressing the lower area of the screen.

System informations have three different categories:

- Notice (grey screen)
- Warning (orange screen)
- Error (red screen)

While an error is present, activations are prohibited.

The message is available using the orange marked „?“ in the system bar.

Moreover, these messages are available in the menu program system settings and will be deleted when switching off the unit.

The following table describes the cause of the fault and the appropriate corrective action.

Heading	Fault message
Confirmation of AUTOSTART Mode	You have selected an AUTOSTART mode. Setting the AUTOSTART mode can result in unintentional coagulations, e.g. when bipolar forceps are used for gripping while the AUTOSTART Mode is on.
AUTOSTART Error	The instrument is in contact with tissue. AUTOSTART cannot be selected when the instrument is in contact with tissue. Open up the instrument.
TSI Warning	The annual Technical Safety Inspection (TSI) is due.
Neutral Electrode Error	No neutral electrode connected. No neutral electrode connected. Connect a neutral electrode.
Neutral Electrode Error	Wrong neutral electrode connected.. The selection does not match the neutral electrode connected. Connect the neutral electrode which matches the selected mode, or change the mode to match the neutral electrode.
Neutral Electrode Error	Poor contact with the patient. The resistance between the neutral electrode and the patient is too high. Establish better contact of the neutral electrode.
Neutral Electrode Warning	Poor contact with the patient. The contact resistance between the neutral electrode and the patient is increasing. Establish better contact of the neutral electrode.
Neutral Electrode Error	No cable for neutral electrode connected. No cable for neutral electrode connected. Connect a cable for neutral electrodes.
Neutral Electrode Notice	No cable for neutral electrode connected. The cable for neutral electrode has been removed. Monopolar activation is not possible.
Mode Error	No mode selected. No mode was selected for this type of activation. Select the desired mode or change the foot switch assignment.
Mode Error	This mode is not allowed for baby neutral electrodes. Use split neutral electrodes with a large conductive surface for this mode.
Mode Error	This mode is not allowed for this socket. The current mode remains active. Choose another socket for this mode.
Foot Switch Error	Foot switch not assigned to a socket. The foot switch has not been assigned to a socket yet. Assign a socket to the foot switch using the "Pedal" button.

Heading	Fault message
Foot Switch Notice	The assignation of the foot switch has been changed. The orange button on the foot switch enables switching from socket A to B and back. The active foot switch assignation is displayed in the form of an orange dot.
Foot Switch Warning	Second foot switch assignment has not been set. There is no second foot switch assignment in place. The current assignment remains active. To allocate the second foot switch assignment press the "Pedal" push button on the desired socket.
Foot Switch Error	Fault on foot switch connection. Check the foot switch. If this message appears again, please contact the Technical Support. Internet: www.bowa.de Telephone: +49707260020
Finger Switch Error	Fault on finger switch connection. Check the handle and the connection cable. Please replace them if damaged. If this message appears again please contact the Technical Support. Internet: www.bowa.de Telephone: +49707260020
Finger Switch Error	Fault on finger switch connection. Check the handle and the connection cable. Please replace them if damaged. Instruments with one pin have to be connected to the marked socket. If this message appears again please contact the Technical Support. Internet: www.bowa.de Telephone: +49707260020
Finger Switch Error	Fault on finger switch connection. Check the handle and the connection cable. Please replace them if damaged. If this message appears again please contact the Technical Support. Internet: www.bowa.de Telephone: +49707260020
Temperature Warning	The temperature of the device is higher than normal. The temperature of the device is elevated. This leads to a reduction of the maximum power.
Limitation of Continuous Activation	The maximum activation time has been exceeded. Please only activate the generator in short intervals, in order to avoid harming the patient and damaging the connected instruments or the generator.
Mains Voltage Error	The mains voltage is too low. Please ensure a constant mains voltage. If necessary, connect a UPS (Uninterrupted Power Supply).
Activation Error	While switching on the device, there is an activation by foot switch, finger switch or AUTOSTART. Check the handles or foot switches for malfunctions. Disconnect the handles / foot switches from the device. If the error persists, please contact the Technical Support. Internet: www.bowa.de Telephone: +49707260020

Heading	Fault message
Activation Error	There is an activation while connecting the foot switch or finger switch. Check the handles or foot switches for malfunctions. Disconnect the handles / foot switch from the device. If the error persists, please contact the Technical Support. Internet: www.bowa.de Telephone: +49707260020
Activation Error	There is no instrument connected on the activated socket. Connect an instrument on the designated socket.
Activation Warning	The mode for safety inspections is active. Activation is not possible. Quit this mode before activating again.
Bipolar Resection Warning	No activation of the bipolar resection. Check the irrigation medium, the connection cable, the instrument and the selected settings. Make sure that NaCl is used as an irrigation medium.
GastroCut Notice	The polypectomy has been completed.
GastroCut Warning	Polypectomy snare not in contact with tissue, or check connection cable at snare or generator. Please apply the snare and reactivate. First of all establish contact between tissue and polypectomy snare, or check the connection cable at the snare or the generator. Then activate with the yellow foot pedal.
LIGATION Notice	The LIGATION has been completed.
LIGATION Warning	There is a short-circuit in the area of the sealing instrument. Please check the instrument for foreign material or contact with other objects. The sealing point must be free of foreign objects.
LIGATION Warning	The sealing instrument is not in contact with tissue. Please grasp tissue and reactivate LIGATION. Check the connection between instrument and generator. To perform LIGATION of vessel and tissue bundles it is necessary to grasp tissue and close the sealing instrument before activating.
ARC PLUS Fault	Please check if the argon bottles are connected and open. Empty bottles should be replaced. Subsequently restart ARC PLUS by activating the flashing "Purge" button.
ARC PLUS Fault	The argon inlet pressure is too high. Max. inlet pressure: <4.5bar Close a source of argon gas in the appropriate pressure range. Subsequently restart ARC PLUS by activating the flashing "Purge" button.
ARC PLUS Fault	The argon inlet pressure has exceeded the permissible limits. Inlet pressure range: 2 - 4.5bar Close a source of argon gas in the appropriate pressure range. Subsequently restart ARC PLUS by activating the flashing "Purge" button.
ARC PLUS Warning	Please check if the argon bottles are connected and open. Empty bottles should be replaced. Subsequently restart ARC PLUS by activating the flashing "Purge" button.

Heading	Fault message
ARC PLUS Warning	Mixed operation of argon bottles with and without an electric bottle pressure gauge is not recommended Connect two identical pressure reducers.
ARC PLUS Warning	Please check if the instrument is free of adhesions, and purge it with argon. If repeated purging does not solve the problem, the instrument and cable must be replaced.
ARC PLUS Warning	The argon flow settings at ARC 350 are invalid
ARC PLUS Warning	The filling level of the argon bottle is low. Please make sure that a replacement is available. You can connect two argon bottles. The unit shifts automatically to the second bottle.
ARC PLUS Fault	The argon bottle is empty. Connect a replacement bottle to enable activation. You can connect two argon bottles. The unit shifts automatically to the second bottle
ARC PLUS Notice	The argon bottle is empty. The unit has shifted automatically to the replacement bottle. Please make sure that a replacement is available
TSI ARC PLUS Warning	The annual Technical Safety Inspection (TSI) for ARC PLUS is due.
Plug'n Cut COMFORT Notice	The lifetime of the instrument is ending soon. Please order a replacement in good time. Any use of the instrument beyond its lifetime is not covered by warranty. Please contact your BOWA dealer in good time to purchase a new instrument.
Plug'n Cut COMFORT Warning	The maximum lifetime of the instrument has been reached. Any further use is not covered by warranty. The maximum service lifetime of the instruments must not be exceeded, in order to guarantee safe usage. Any further use is at the user's risk.
Plug'n Cut COMFORT Notice	You have connected a BOWA RFID instrument. X applications remain available. The maximum lifetime of the instruments must not be exceeded, in order to guarantee safe usage. Any further use is at the user's risk.
Dr. Dongle Notice	You can save up to six of your preferred programs on your Dr. Dongle and run them in a flexible way. With the "Load" button you can call a selected program. You can use the "Save" button to enter an explanatory text for the selected program.
Plug'n Cut COMFORT Warning	A software update is necessary to use Plug'n Cut COMFORT with this instrument. Only carry out manual settings at this instrument. Please contact the Technical Support. Internet: www.bowa.de Telephone: +49707260020
Internal Error 4177	If this message appears again, please contact the Technical Support. Internet: www.bowa.de Telephone: +49707260020

Internal Errors have a number next to the description.
Please advise the Technical Service of this number.

6.2. Fault indications for EASY monitoring

Fault indications are displayed in three stages (green, yellow and red) when problems occur.

When working with a split neutral electrode, the following faults may occur:

EASY monitoring	Cause	Indication	Corrective measures
Flashes yellow	Significant increase in resistance Depending on the indication, there may be heating under the neutral electrode	–	Stopping the application is not necessary. Check the proper application of the neutral electrode.
Switches from green to continuous red	A significant problem occurred when the monopolar current was activated	An acoustic signal sounds. A warning message appears on the display	<ul style="list-style-type: none"> ▶ Check the neutral electrode and neutral electrode cable (see Section EASY neutral electrode monitoring (EASY monitoring), page 28. ▶ Check the neutral electrode cable for proper connection and external damage.
	Loosened electrode	An acoustic signal sounds. A warning message appears on the display	▶ Reattach the neutral electrode. If the fault persists, replace the neutral electrode.

7. Preparation

7.1. Preparation of the accessories

- ▶ Prepare the accessories (e.g. surgical handles, instruments, active electrodes, neutral electrodes and cables) as described in the corresponding operating manuals.
- ▶ Check the accessories before and after use for damage and to ensure that they are working properly.

7.2. Disinfection and cleaning



NOTE

Incorrect handling of the HF device can cause damage to the unit!

- ▶ Never sterilize the ARC 350 device. Instead, clean or disinfect it.
-



WARNING

Risk of electric shock and fire!

- ▶ Unplug the power connection before cleaning the device.
 - ▶ For cleaning surfaces, use the approved cleaning agents/disinfectants only as specified by the manufacturer.
 - ▶ Ensure that no liquid penetrates the device.
 - ▶ Ensure that the AUTOSTART function is deactivated.
-

1. Apply the cleaning agent and disinfectant.
2. Wipe the agent off with a sponge moistened with clean water or with a cloth.
3. Dry the device using a clean, lint-free cloth.

8. Maintenance and repair

8.1. Maintenance



DANGER

Infection hazard!

- ▶ Carry out a surface disinfection and wrap the device in addition to the shipping packaging material before allowing the device to leave the hospital or office to avoid spreading germs and infections.

- ▶ Check the device, the device trolley and the accessories (e.g. foot switch, cable) after each use for damage or defects. In particular, make sure that the insulation is intact on all cables.
- ▶ Do not use any damaged device, damaged device trolley or damaged accessories.
- ▶ Replace defective accessories immediately.
- ▶ Have the safety inspection for the device performed once a year. Please consult and comply with the respective service instructions for additional technical information.

8.1.1. Safety inspection

Safety inspections must be performed once a year.

- ▶ The next safety inspection date of ARC 400 can be displayed in the dialog, see "BOWA Service" dialog, page 61
- ↪ A warning message appears during system start-up if a safety inspection is due. Further work is still possible, confirm this with "OK".



Any shorter safety inspection cycles specified in national regulations must be observed.

- ▶ The device and accessories may be inspected only by persons who have the required training, knowledge or experience and who can perform the inspection independently.
- ▶ With regard to the safety inspection, you must comply with the country-specific rules and regulations.

The inspector documents the inspection results and measured values corresponding to the printed inspection protocol.

In the case of severe deviations from the values of the attached final acceptance report, or if the specified maximum values were exceeded:

- ▶ Send the HF device to the service centre, see section Technical service, page 73.

8.2. Repairs



NOTE

You can damage the HF device by doing your own repairs and modifications of medical equipment!

- ▶ If a repair is necessary, contact the service address mentioned in chapter 9.1.
 - ▶ Never carry out any repairs yourself.
-

BOWA is liable for safety, reliability and performance of the HF device under the following conditions:

- Full compliance with all instructions regarding the installation and proper use for the intended purpose contained in this operating manual was maintained.
 - Changes, repairs, new settings and similar procedures were carried out only by persons authorized to do this work by BOWA.
 - The electrical installations in the relevant room meet the local requirements and statutory provisions.
-



Fast and satisfactory repairs can only be guaranteed when all required data have been supplied in full.

The following information is required for returning the device:

- complete address
 - model number
 - serial number
 - software version
 - ▶ Describe the problem, the appropriate application and the accessories used.
- or –
- ▶ Describe the repairs to be made.
-

9. Storage

- ▶ If you store the HF device for longer than one year, pay specific attention to the indicators during automatic functional testing, see section Functional test, page 26.
- ▶ Clean the HF device thoroughly before you put it into storage.
- ▶ Store the HF device in a clean, dry place in accordance with the storage conditions.

Storage conditions:

- Temperature: -20 °C to +50 °C
- Relative humidity 0 to 75 %, non-condensing
- Atmospheric pressure: 500 to 1060 hPa

9.1. Technical service

Contact the following service center for maintenance and repair work:

BOWA-electronic GmbH & Co. KG

Heinrich-Hertz-Strasse 4–10

72810 Gomaringen, Germany

Phone +49 (0) 7072-6002-0

Fax +49 (0) 7072-6002-33

Email service@bowa.de

or visit our website:

www.bowa.de

10. Technical specifications

10.1. ARC 350 technical data

Insulation type / Classification	
EMC	IEC 60601-1-2
Level of protection provided by the housing	IP 21
Protection class according to EN 60601-1	I
Application component type according to EN 60601-1	CF
Standards compliance	IEC 60601-1: 2005, IEC 60601-1-2: 2007, IEC 60601-2-2: 2009, ISO 14971: 2007, ISO 13485: 2003 + Cor.1_2009
Classification according to EC Directive 93/42/EEC	IIb

Power connection	220 V - 240 V	100 V - 115 V
Power consumption in standby mode	3 W / 40 VA	3 W / 40 VA
Current consumption in standby mode	200 mA	400 mA
Maximum power consumption (at 350 W)	700 W / 1150 VA	700 W / 1150 VA
Maximum current consumption (at 350 W)	5 A	10 A
Line fuses	2 x 5 A slow-blow	2 x 10 A slow-blow
Input voltage range	198 V to 264 V	90 V to 130 V
Line frequency	50 / 60 Hz	50 / 60 Hz
Terminal for potential equalization	√	√

Dimensions and weight	
External dimensions: width x height x depth (mm)	430 x 180 x 475
Weight	approx. 12.5 kg

Programs	
Number of programs in the device	350
Default programs, factory set	√
Individually programmable	√
Program number and data shown on the display	√

Neutral electrode monitoring	
EASY (Electrode Application System)	√
Display indication of one-piece or split or Baby electrode in the main and neutral electrode menu	√
Contact resistance between individual sections of split neutral electrodes shown on display with column for control	√
Lead resistance shown on the display when a one-piece neutral electrode is used	√
Maximum allowable resistance between the sections of a split electrode	300 Ω
Warning signal for hazardous conditions beneath the neutral electrode	Visual, acoustic
Warning messages on display:	Text messages with further information

Safety features	
ISSys (Integrated Safety System)	√
Continuous monitoring of HF leakage current with fault indication	Text messages with further information
Dosage monitoring with fault indication on the display	√
Continuous self-test	√
Continuous status indication on the display	√
Operating errors shown on the display	Text messages with further information
System faults shown on the display	Text messages with further information

Documentation	
Data acquisition and storage in the device	System information with date
Fault states	√
Operating errors	√
Data retrieval via the display	Text messages with further information

Communication	
External interface for communication with ARC PLUS (light wire cables)	√
USB interface for software updates	√
External PC interface, UART, using BOWA software	√
Service support using BOWA software	√

Service support	
Network port for service support	√
Service support by service programs integrated in the device	√
Service support via ISSys	√

Cooling	
Convection	√
Temperature-controlled fan	√

Duty factor	
Intermittent	10 s / 30 s (on/off)

Characteristics	
Max. CUT Power (at 500 Ω)	350 W
Max. COAG Power (at 25 Ω)	350 W
Monopolar sockets	2 x international / Erbe
Bipolar sockets	2 x international / Erbe
Connection for footswitch	2 x
AUTOSTART	√
Bipolar finger switch	√
Plug'n Cut COMFORT instrument identification	√

Optionen	
Argon / GastroCut	REF 900-391
Bipolar Resection	REF 900-395
LIGATION	REF 900-396

Umweltbedingungen	Betrieb	Transport und Lagerung
Temperature	+10°C to +40°C	-20°C to +50°C
Relative humidity	30 to 75%, non-condensing	0 to 90%, non-condensing
Atmospheric pressure	700 to 1060 hPa	500 to 1060 hPa
Operating altitude (max)	4000 m a. sea level	

Description	CCS	ARC CONTROL	Form of HF voltage	Max. power output		Peak voltage	Default values	
				Effect	Power range		Effect	Max. Watt
Modes Monopolar Cutting								
Standard	Yes	Yes	sinusoidal constant	1 2 3 4 5 6 7 8 9	1 W - 350 W	400 Vp 450 Vp 560 Vp 650 Vp 650 Vp 700 Vp 700 Vp 700 Vp 750 Vp	5	100
Micro	Yes	yes	sinusoidal constant	1 2 3 4 5 6 7 8 9	1 W - 50 W	280 Vp 340 Vp 380 Vp 400 Vp 400 Vp 400 Vp 450 Vp 450 Vp 450 Vp	5	20
Dry	Yes	yes	sinusoidal modulated	1 2 3 4 5 6 7 8 9	1 W - 200 W	1.4 kVp 1.4 kVp 1.4 kVp 1.4 kVp 1.5 kVp 1.6 kVp 1.6 kVp 1.6 kVp 1.6 kVp	5	100
Argon	Yes	yes	sinusoidal constant	1 2 3 4 5 6 7 8 9	1 W - 300 W	400 Vp 450 Vp 560 Vp 650 Vp 650 Vp 700 Vp 700 Vp 700 Vp 750 Vp	5	100
Resection	Yes	yes	sinusoidal constant	1 2 3 4 5	250 W	650 Vp 700 Vp 700 Vp 700 Vp 750 Vp	2	---
MetraLOOP	Yes	Yes	sinusoidal constant	1 2 3	100 W 150 W 200 W	650 Vp	1	---
Laparoscopy	Yes	Yes	sinusoidal constant	1 2 3 4 5 6 7 8 9	1 W - 200W	400 Vp 450 Vp 560 Vp 650 Vp 650 Vp 700 Vp 700 Vp 700 Vp 750 Vp	5	100
GastroLOOP 1	Yes	Yes	sinusoidal alternating Coag, Cut and break phases	1 2 3 4 5 6 7 8 9	-	750 Vp	5	---
GastroLOOP 2	Yes	Yes	sinusoidal alternating Coag, Cut and break phases	1 2 3 4 5 6 7 8 9	-	750 Vp	5	---

Description	CCS	ARC CONTROL	Form of HF voltage	Max. power output		Peak voltage	Default values	
				Effect	Power range		Effect	Max. Watt
Modes Monopolar Cutting								
GastroLOOP 3	Yes	Yes	sinusoidal alternating Coag, Cut and break phases	1	-	750 Vp	5	---
				2				
				3				
				4				
				5				
				6				
				7				
				8				
				9				
GastroKNIFE E 1	Yes	Yes	sinusoidal alternating Coag and Cut phases	1	-	650 Vp	5	---
				2				
				3				
				4				
				5				
				6				
				7				
				8				
				9				
GastroKNIFE 2	Yes	Yes	sinusoidal alternating Coag and Cut phases	1	-	650 Vp	5	---
				2				
				3				
				4				
				5				
				6				
				7				
				8				
				9				
GastroKNIFE 3	Yes	Yes	sinusoidal alternating Coag and Cut phases	1	-	650 Vp	5	---
				2				
				3				
				4				
				5				
				6				
				7				
				8				
				9				
Modes Monopolar Coagulation								
Moderate			sinusoidal constant	1 2 3	1 W - 120 W	250 Vp	2	60
Forced non cutting			pulsed modulated	-	1 W - 80 W	3.5 kVp	---	50
Forced mixed			sinusoidal modulated	1 2 3	1 W - 120 W	2.3 kVp 2.5 kVp 2.8 kVp	2	60
Forced cutting			sinusoidal modulated	1 2 3 4	1 W - 250 W	1.5 kVp 1.5 kVp 1.3 kVp 1.3 kVp	2	80
Spray			pulsed modulated	1 2 3 4	1 W - 120 W	3.0 kVp 3.8 kVp 4.6 kVp 5.0 kVp	2	80
Argon open			pulsed modulated	-	1 W - 120 W	4.6 kVp	---	80
Argon flexible			pulsed modulated	-	1 W - 120 W	4.4 kVp	---	40

Description	CCS	ARC CONTROL	Form of HF voltage	Max. power output		Peak voltage	Default values	
				Effect	Power range		Effect	Max. Watt
Modes Monopolar Coagulation								
Argon flex. pulse			pulsed modulated	1 2 3	1 W – 80 W	4.4 kVp	2	20
Resection			sinusoidal modulated	-	1 W -120 W	2.6 kVp	---	60
Cardiac Mammary			sinusoidal modulated	-	1 W - 60 W	2.3 kVp	---	15
Cardiac Thorax			sinusoidal modulated	-	1 W - 100 W	2.3 kVp	---	40
SimCoag			sinusoidal modulated pulsed modulated pulsed modulated	1 2 3	1 W - 120 W	1.5 kVp 2.3 kVp 4.6 kVp	2	60
Gastro Coag			sinusoidal modulated	1 2 3	1 W - 50 W	2.3 kVp 2.6 kVp 3.1 kVp	2	15
Laparoscopy			sinusoidal modulated	-	1 W - 120 W	1.8 kVp	---	60
Modes Bipolar Cutting								
Standard	Yes	Yes	sinusoidal constant	-	1 W - 200 W	400 Vp	---	100
Bipolar resection	Yes	Yes	sinusoidal constant	1 2 3	250 W	500 Vp	2	---
Bipolar scissors			sinusoidal constant	-	1 W - 120 W	200 Vp	---	60
Modes Bipolar Coagulation								
Standard forceps			sinusoidal constant	-	1 W - 120 W	150 Vp	---	40
Standard forceps AUTO			sinusoidal constant	-	5 W - 120 W	150 Vp	---	40

Description	CCS	ARC CONTROL	Form of HF voltage	Max. power output		Peak voltage	Default values	
				Effect	Power range		Effect	Max. Watt
Modes Bipolar Coagulation								
Micro forceps			sinusoidal constant	-	0.1 W - 20 W	150 Vp	---	10
Forceps forced			sinusoidal modulated	-	1 W - 100 W	550 Vp	---	70
LIGATION			sinusoidal modulated	-	200 W	190 Vp	---	---
TissueSeal PLUS			sinusoidal modulated	-	200 W	190 Vp	---	---
Bipolar scissors			sinusoidal constant	-	1 W - 120 W	200 Vp	---	60
Laparoscopy			sinusoidal constant	-	1 W - 120 W	150 Vp	---	50
Bipolar resection			sinusoidal constant	-	1 W - 350 W	190 Vp	---	200



The max. values are not necessarily created at rated load resistance.
 The HF power is subject to a tolerance limit of $\pm 20\%$.

10.2. Output, voltage and current diagrams

Monopolar Cutting – Standard

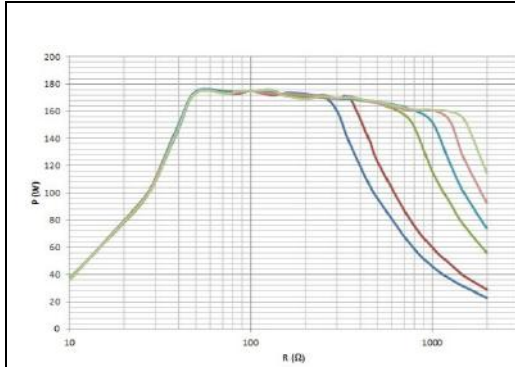

Measurement at ohmic resistances

- Diagram of power output P [W] as a function of the load resistance R [Ω] for the setting "Monopolar Cutting Standard" = 175 W

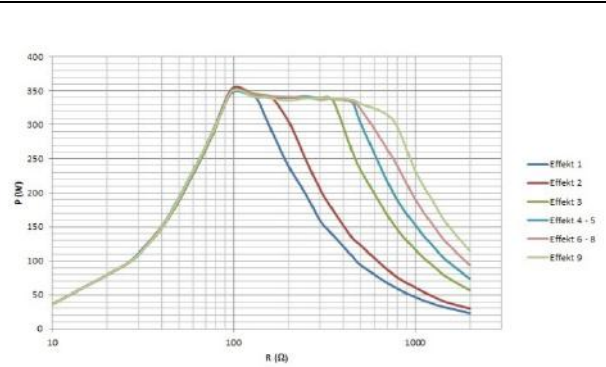

Measurement at ohmic resistances

- Diagram of power output P [W] as a function of the load resistance R [Ω] for the setting "Monopolar Cutting Standard" = 350 W

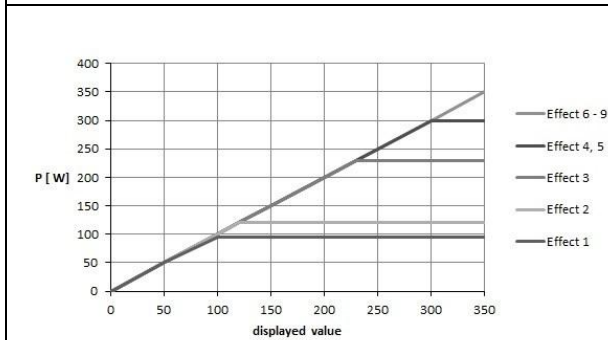

- Diagram of power output P [W] as a function of the setting "Monopolar Cutting Standard" Rated load resistance = 500 Ω

Effect	U (Vp)
1	400
2	450
3	560
4	650
5	650
6	700
7	700
8	700
9	750

- Table of HF output voltage U [Vp] as a function of the setting "Monopolar Cutting Standard" (idle mode)

Monopolar Cutting – Micro

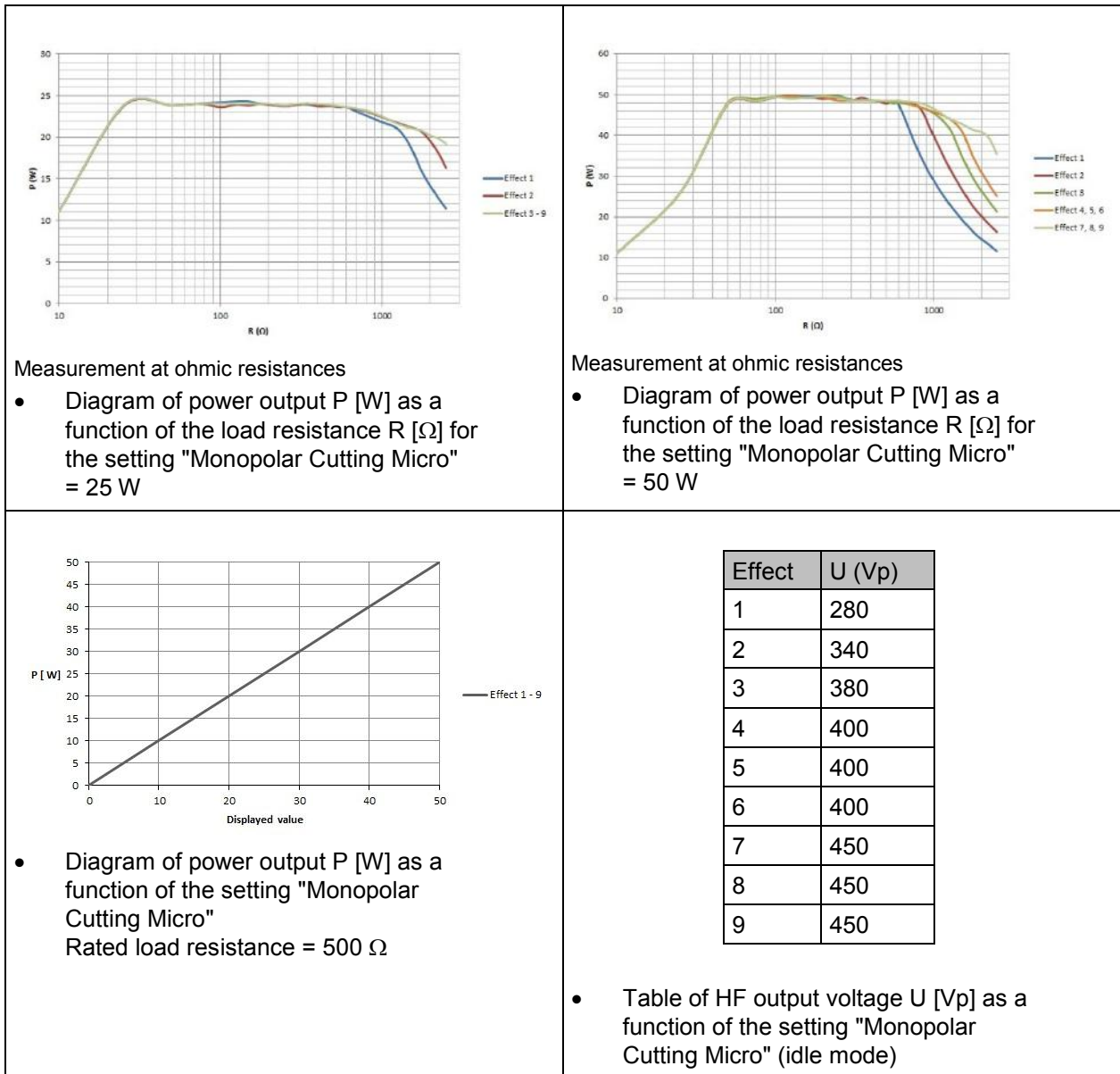

Monopolar Cutting – Dry

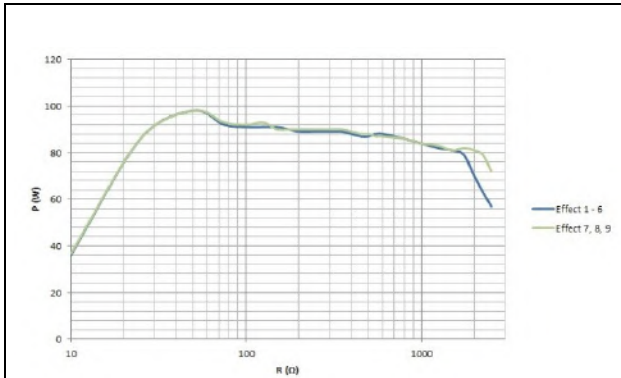

Measurement at ohmic resistances

- Diagram of power output P [W] as a function of the load resistance R [Ω] for the setting "Monopolar Cutting Dry" = 100 W

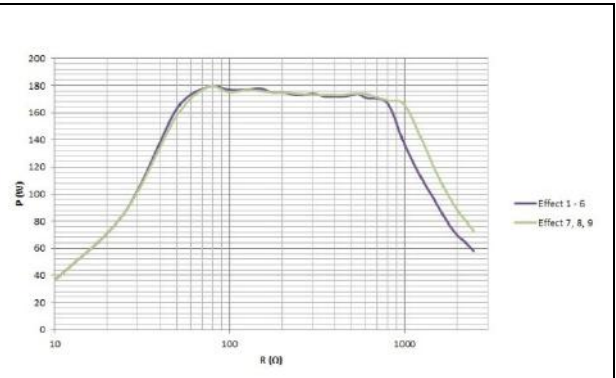

Measurement at ohmic resistances

- Diagram of power output P [W] as a function of the load resistance R [Ω] for the setting "Monopolar Cutting Dry" = 200 W

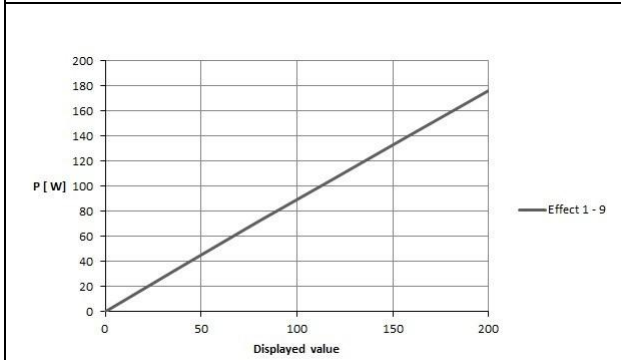

- Diagram of power output P [W] as a function of the setting "Monopolar Cutting Dry" Rated load resistance = 500 Ω

Effect	U (Vp)
1	1400
2	1400
3	1400
4	1400
5	1500
6	1600
7	1600
8	1600
9	1600

- Table of HF output voltage U [Vp] as a function of the setting "Monopolar Cutting Dry" (idle mode)

Monopolar Cutting – Argon

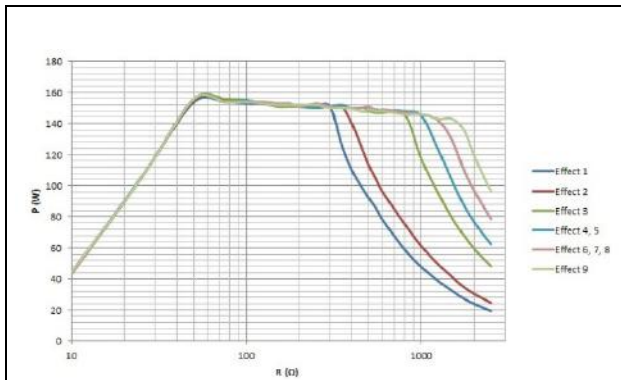

Measurement at ohmic resistances

- Diagram of power output P [W] as a function of the load resistance R [Ω] for the setting "Monopolar Cutting Argon" = 150 W

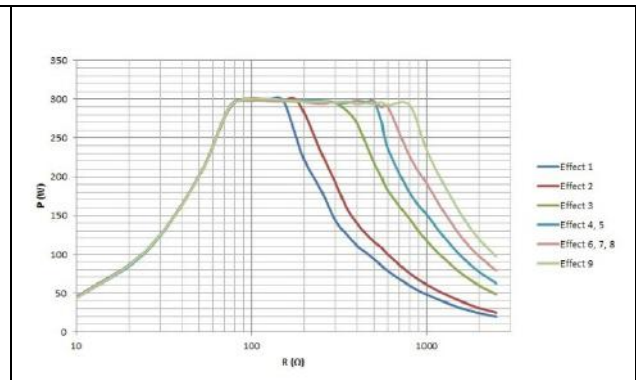

Measurement at ohmic resistances

- Diagram of power output P [W] as a function of the load resistance R [Ω] for the setting "Monopolar Cutting Argon" = 300 W

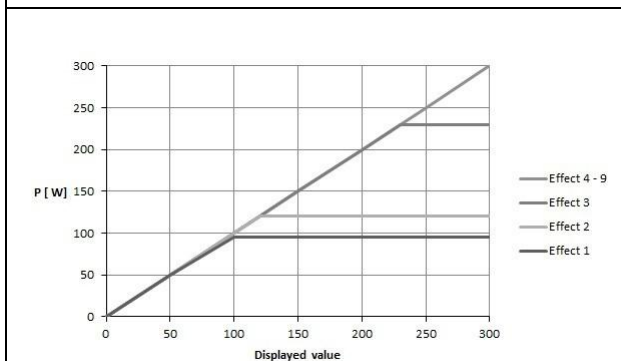

- Diagram of power output P [W] as a function of the setting "Monopolar Cutting Argon" Rated load resistance= 500 Ω

Effect	U [Vp]
1	400
2	450
3	560
4	650
5	650
6	700
7	700
8	700
9	750

- Table of HF output voltage U [Vp] as a function of the setting "Monopolar Cutting Argon" (idle mode)

Monopolar Cutting – Resection

<p>Measurement at ohmic resistances</p> <ul style="list-style-type: none"> Diagram of power output P [W] as a function of the load resistance R [Ω] for the setting "Monopolar Cutting Resection" 																									
<table border="1" data-bbox="384 952 635 1216"> <thead> <tr> <th>Effect</th> <th>P (W)</th> </tr> </thead> <tbody> <tr> <td>1</td> <td>250</td> </tr> <tr> <td>2</td> <td>250</td> </tr> <tr> <td>3</td> <td>250</td> </tr> <tr> <td>4</td> <td>250</td> </tr> <tr> <td>5</td> <td>250</td> </tr> </tbody> </table> <ul style="list-style-type: none"> Table of power output P [W] as a function of the setting "Monopolar Cutting Resection" Rated load resistance= 500 Ω 	Effect	P (W)	1	250	2	250	3	250	4	250	5	250	<table border="1" data-bbox="1010 952 1260 1216"> <thead> <tr> <th>Effect</th> <th>U (Vp)</th> </tr> </thead> <tbody> <tr> <td>1</td> <td>650</td> </tr> <tr> <td>2</td> <td>700</td> </tr> <tr> <td>3</td> <td>700</td> </tr> <tr> <td>4</td> <td>700</td> </tr> <tr> <td>5</td> <td>750</td> </tr> </tbody> </table> <ul style="list-style-type: none"> Table of HF output voltage U [Vp] as a function of the setting "Monopolar Cutting Resection" (idle mode) 	Effect	U (Vp)	1	650	2	700	3	700	4	700	5	750
Effect	P (W)																								
1	250																								
2	250																								
3	250																								
4	250																								
5	250																								
Effect	U (Vp)																								
1	650																								
2	700																								
3	700																								
4	700																								
5	750																								

Monopolar Cutting – MetraLOOP

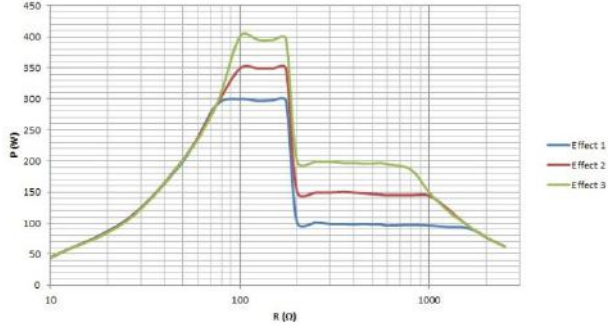
 <p>Measurement at ohmic resistances</p> <ul style="list-style-type: none"> Diagram of power output P [W] as a function of the load resistance R [Ω] for the setting "Monopolar Cutting MetraLOOP" 	<ul style="list-style-type: none"> 																
<table border="1" data-bbox="384 965 632 1111"> <thead> <tr> <th>Effect</th> <th>P (W)</th> </tr> </thead> <tbody> <tr> <td>1</td> <td>100</td> </tr> <tr> <td>2</td> <td>150</td> </tr> <tr> <td>3</td> <td>200</td> </tr> </tbody> </table> <ul style="list-style-type: none"> Table of power output P [W] as a function of the setting "Monopolar Cutting MetraLOOP" Rated load resistance= 500 Ω 	Effect	P (W)	1	100	2	150	3	200	<table border="1" data-bbox="1011 965 1259 1111"> <thead> <tr> <th>Effect</th> <th>U (Vp)</th> </tr> </thead> <tbody> <tr> <td>1</td> <td>650</td> </tr> <tr> <td>2</td> <td>650</td> </tr> <tr> <td>3</td> <td>650</td> </tr> </tbody> </table> <ul style="list-style-type: none"> Table of HF output voltage U [Vp] as a function of the setting "Monopolar Cutting MetraLOOP" (idle mode) 	Effect	U (Vp)	1	650	2	650	3	650
Effect	P (W)																
1	100																
2	150																
3	200																
Effect	U (Vp)																
1	650																
2	650																
3	650																

Monopolar Cutting – Laparoscopy

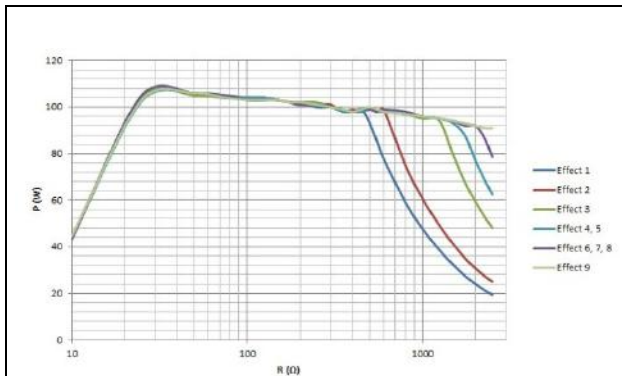

Measurement at ohmic resistances

- Diagram of power output P [W] as a function of the load resistance R [Ω] for the setting "Monopolar Cutting Laparoscopy" = 100 W

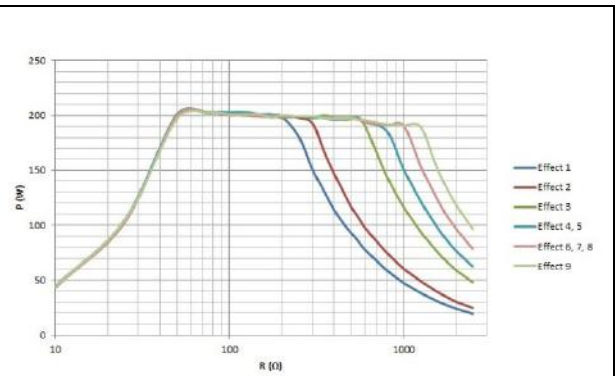

Measurement at ohmic resistances

- Diagram of power output P [W] as a function of the load resistance R [Ω] for the setting "Monopolar Cutting Laparoscopy" = 200 W

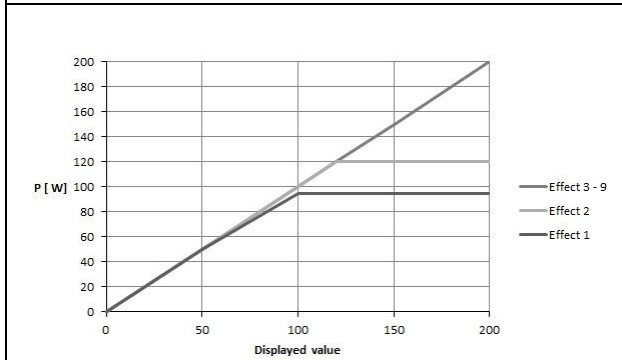

- Diagram of power output P [W] as a function of the setting "Monopolar Cutting Laparoscopy" Rated load resistance= 500 Ω

Effect	U (Vp)
1	400
2	450
3	560
4	650
5	650
6	700
7	700
8	700
9	750

- Table of HF output voltage U [Vp] as a function of the setting "Monopolar Cutting Laparoscopy" (idle mode)

Monopolar Cutting – GastroLOOP 1

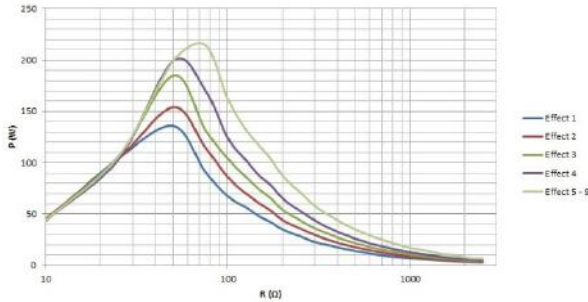
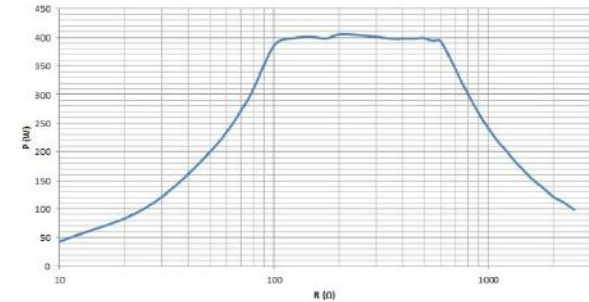
 <p>Measurement at ohmic resistances</p> <ul style="list-style-type: none"> Diagram of power output P [W] as a function of the load resistance R [Ω] for the setting "Monopolar Cutting GastroLOOP 1" coag phase 	 <p>Measurement at ohmic resistances</p> <ul style="list-style-type: none"> Diagram of power output P [W] as a function of the load resistance R [Ω] for the setting "Monopolar Cutting GastroLOOP 1" cut phase 																																																		
<table border="1" style="width: 100%; border-collapse: collapse; text-align: center;"> <thead> <tr> <th style="width: 15%;">Effect</th> <th style="width: 20%;">P (W) coag phase</th> <th style="width: 20%;">P (W) cut phase</th> </tr> </thead> <tbody> <tr><td>1</td><td>14</td><td>400</td></tr> <tr><td>2</td><td>18</td><td>400</td></tr> <tr><td>3</td><td>22</td><td>400</td></tr> <tr><td>4</td><td>26</td><td>400</td></tr> <tr><td>5</td><td>35</td><td>400</td></tr> <tr><td>6</td><td>35</td><td>400</td></tr> <tr><td>7</td><td>35</td><td>400</td></tr> <tr><td>8</td><td>35</td><td>400</td></tr> <tr><td>9</td><td>35</td><td>400</td></tr> </tbody> </table> <ul style="list-style-type: none"> Table of power output P [W] as a function of the setting "Monopolar Cutting GastroLOOP 1" Rated load resistance= 500 Ω 	Effect	P (W) coag phase	P (W) cut phase	1	14	400	2	18	400	3	22	400	4	26	400	5	35	400	6	35	400	7	35	400	8	35	400	9	35	400	<table border="1" style="width: 100%; border-collapse: collapse; text-align: center;"> <thead> <tr> <th style="width: 15%;">Effect</th> <th style="width: 20%;">U (Vp)</th> </tr> </thead> <tbody> <tr><td>1</td><td>750</td></tr> <tr><td>2</td><td>750</td></tr> <tr><td>3</td><td>750</td></tr> <tr><td>4</td><td>750</td></tr> <tr><td>5</td><td>750</td></tr> <tr><td>6</td><td>750</td></tr> <tr><td>7</td><td>750</td></tr> <tr><td>8</td><td>750</td></tr> <tr><td>9</td><td>750</td></tr> </tbody> </table> <ul style="list-style-type: none"> Table of HF output voltage U [Vp] as a function of the setting "Monopolar Cutting GastroLOOP 1" (idle mode) 	Effect	U (Vp)	1	750	2	750	3	750	4	750	5	750	6	750	7	750	8	750	9	750
Effect	P (W) coag phase	P (W) cut phase																																																	
1	14	400																																																	
2	18	400																																																	
3	22	400																																																	
4	26	400																																																	
5	35	400																																																	
6	35	400																																																	
7	35	400																																																	
8	35	400																																																	
9	35	400																																																	
Effect	U (Vp)																																																		
1	750																																																		
2	750																																																		
3	750																																																		
4	750																																																		
5	750																																																		
6	750																																																		
7	750																																																		
8	750																																																		
9	750																																																		

Monopolar Cutting – GastroLOOP 2

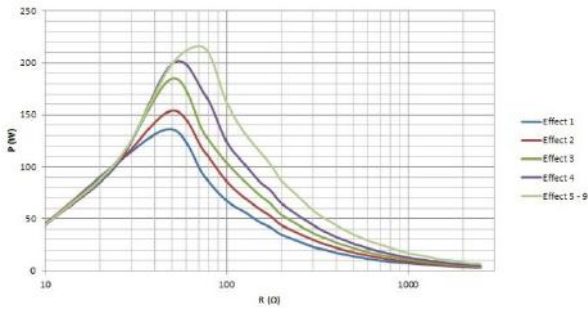
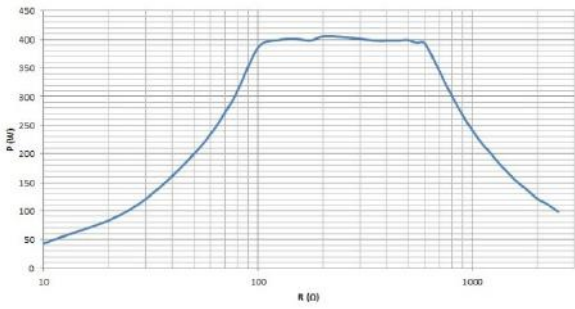
 <p>Measurement at ohmic resistances</p> <ul style="list-style-type: none"> Diagram of power output P [W] as a function of the load resistance R [Ω] for the setting "Monopolar Cutting GastroLOOP 2" coag phase 	 <p>Measurement at ohmic resistances</p> <ul style="list-style-type: none"> Diagram of power output P [W] as a function of the load resistance R [Ω] for the setting "Monopolar Cutting GastroLOOP 2" cut phase 																																																		
<table border="1" data-bbox="255 920 700 1391"> <thead> <tr> <th>Effect</th> <th>P (W) coag phase</th> <th>P (W) cut phase</th> </tr> </thead> <tbody> <tr><td>1</td><td>14</td><td>400</td></tr> <tr><td>2</td><td>18</td><td>400</td></tr> <tr><td>3</td><td>22</td><td>400</td></tr> <tr><td>4</td><td>26</td><td>400</td></tr> <tr><td>5</td><td>35</td><td>400</td></tr> <tr><td>6</td><td>35</td><td>400</td></tr> <tr><td>7</td><td>35</td><td>400</td></tr> <tr><td>8</td><td>35</td><td>400</td></tr> <tr><td>9</td><td>35</td><td>400</td></tr> </tbody> </table> <ul style="list-style-type: none"> Table of power output P [W] as a function of the setting "Monopolar Cutting GastroLOOP 2" Rated load resistance= 500 Ω 	Effect	P (W) coag phase	P (W) cut phase	1	14	400	2	18	400	3	22	400	4	26	400	5	35	400	6	35	400	7	35	400	8	35	400	9	35	400	<table border="1" data-bbox="991 920 1214 1359"> <thead> <tr> <th>Effect</th> <th>U (Vp)</th> </tr> </thead> <tbody> <tr><td>1</td><td>750</td></tr> <tr><td>2</td><td>750</td></tr> <tr><td>3</td><td>750</td></tr> <tr><td>4</td><td>750</td></tr> <tr><td>5</td><td>750</td></tr> <tr><td>6</td><td>750</td></tr> <tr><td>7</td><td>750</td></tr> <tr><td>8</td><td>750</td></tr> <tr><td>9</td><td>750</td></tr> </tbody> </table> <ul style="list-style-type: none"> Table of HF output voltage U [Vp] as a function of the setting "Monopolar Cutting GastroLOOP 2" (idle mode) 	Effect	U (Vp)	1	750	2	750	3	750	4	750	5	750	6	750	7	750	8	750	9	750
Effect	P (W) coag phase	P (W) cut phase																																																	
1	14	400																																																	
2	18	400																																																	
3	22	400																																																	
4	26	400																																																	
5	35	400																																																	
6	35	400																																																	
7	35	400																																																	
8	35	400																																																	
9	35	400																																																	
Effect	U (Vp)																																																		
1	750																																																		
2	750																																																		
3	750																																																		
4	750																																																		
5	750																																																		
6	750																																																		
7	750																																																		
8	750																																																		
9	750																																																		

Monopolar Cutting – GastroLOOP 3

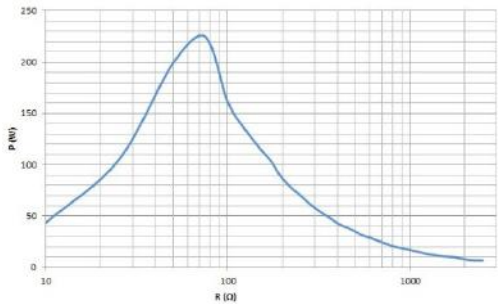
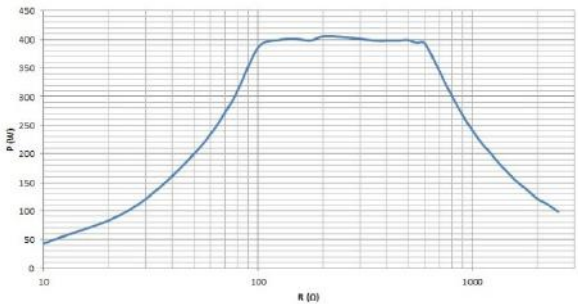
 <p>Measurement at ohmic resistances</p> <ul style="list-style-type: none"> Diagram of power output P [W] as a function of the load resistance R [Ω] for the setting "Monopolar Cutting GastroLOOP 3" coag phase 	 <p>Measurement at ohmic resistances</p> <ul style="list-style-type: none"> Diagram of power output P [W] as a function of the load resistance R [Ω] for the setting "Monopolar Cutting GastroLOOP 3" cut phase 																																																		
<table border="1" data-bbox="256 965 700 1435"> <thead> <tr> <th>Effect</th> <th>P (W) coag phase</th> <th>P (W) cut phase</th> </tr> </thead> <tbody> <tr><td>1</td><td>35</td><td>400</td></tr> <tr><td>2</td><td>35</td><td>400</td></tr> <tr><td>3</td><td>35</td><td>400</td></tr> <tr><td>4</td><td>35</td><td>400</td></tr> <tr><td>5</td><td>35</td><td>400</td></tr> <tr><td>6</td><td>35</td><td>400</td></tr> <tr><td>7</td><td>35</td><td>400</td></tr> <tr><td>8</td><td>35</td><td>400</td></tr> <tr><td>9</td><td>35</td><td>400</td></tr> </tbody> </table> <ul style="list-style-type: none"> Table of power output P [W] as a function of the setting "Monopolar Cutting GastroLOOP 3" Rated load resistance= 500 Ω 	Effect	P (W) coag phase	P (W) cut phase	1	35	400	2	35	400	3	35	400	4	35	400	5	35	400	6	35	400	7	35	400	8	35	400	9	35	400	<table border="1" data-bbox="994 965 1214 1402"> <thead> <tr> <th>Effect</th> <th>U (Vp)</th> </tr> </thead> <tbody> <tr><td>1</td><td>750</td></tr> <tr><td>2</td><td>750</td></tr> <tr><td>3</td><td>750</td></tr> <tr><td>4</td><td>750</td></tr> <tr><td>5</td><td>750</td></tr> <tr><td>6</td><td>750</td></tr> <tr><td>7</td><td>750</td></tr> <tr><td>8</td><td>750</td></tr> <tr><td>9</td><td>750</td></tr> </tbody> </table> <ul style="list-style-type: none"> Table of HF output voltage U [Vp] as a function of the setting "Monopolar Cutting GastroLOOP 3" (idle mode) 	Effect	U (Vp)	1	750	2	750	3	750	4	750	5	750	6	750	7	750	8	750	9	750
Effect	P (W) coag phase	P (W) cut phase																																																	
1	35	400																																																	
2	35	400																																																	
3	35	400																																																	
4	35	400																																																	
5	35	400																																																	
6	35	400																																																	
7	35	400																																																	
8	35	400																																																	
9	35	400																																																	
Effect	U (Vp)																																																		
1	750																																																		
2	750																																																		
3	750																																																		
4	750																																																		
5	750																																																		
6	750																																																		
7	750																																																		
8	750																																																		
9	750																																																		

Monopolar Cutting – GastroKNIFE 1

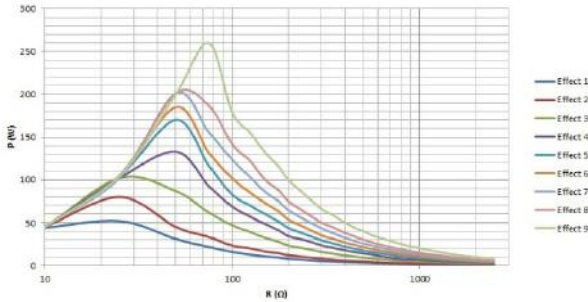
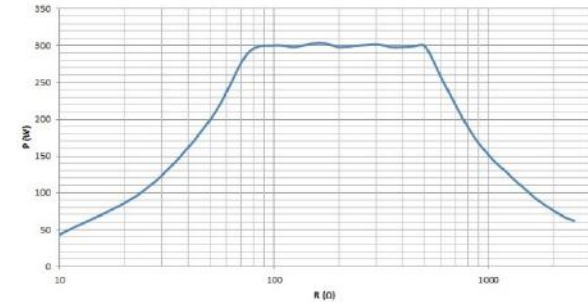
 <p>Measurement at ohmic resistances</p> <ul style="list-style-type: none"> Diagram of power output P [W] as a function of the load resistance R [Ω] for the setting "Monopolar Cutting GastroKNIFE 1" coag phase 	 <p>Measurement at ohmic resistances</p> <ul style="list-style-type: none"> Diagram of power output P [W] as a function of the load resistance R [Ω] for the setting "Monopolar Cutting GastroKNIFE 1" cut phase 																																																		
<table border="1" style="width: 100%; border-collapse: collapse; text-align: center;"> <thead> <tr> <th>Effect</th> <th>P (W) coag phase</th> <th>P (W) cut phase</th> </tr> </thead> <tbody> <tr><td>1</td><td>3</td><td>300</td></tr> <tr><td>2</td><td>5</td><td>300</td></tr> <tr><td>3</td><td>9</td><td>300</td></tr> <tr><td>4</td><td>14</td><td>300</td></tr> <tr><td>5</td><td>17</td><td>300</td></tr> <tr><td>6</td><td>22</td><td>300</td></tr> <tr><td>7</td><td>26</td><td>300</td></tr> <tr><td>8</td><td>30</td><td>300</td></tr> <tr><td>9</td><td>40</td><td>300</td></tr> </tbody> </table> <ul style="list-style-type: none"> Table of power output P [W] as a function of the setting "Monopolar Cutting GastroKNIFE 1" Rated load resistance= 500 Ω 	Effect	P (W) coag phase	P (W) cut phase	1	3	300	2	5	300	3	9	300	4	14	300	5	17	300	6	22	300	7	26	300	8	30	300	9	40	300	<table border="1" style="width: 100%; border-collapse: collapse; text-align: center;"> <thead> <tr> <th>Effect</th> <th>U (Vp)</th> </tr> </thead> <tbody> <tr><td>1</td><td>650</td></tr> <tr><td>2</td><td>650</td></tr> <tr><td>3</td><td>650</td></tr> <tr><td>4</td><td>650</td></tr> <tr><td>5</td><td>650</td></tr> <tr><td>6</td><td>650</td></tr> <tr><td>7</td><td>650</td></tr> <tr><td>8</td><td>650</td></tr> <tr><td>9</td><td>650</td></tr> </tbody> </table> <ul style="list-style-type: none"> Table of HF output voltage U [Vp] as a function of the setting "Monopolar Cutting GastroKNIFE 1" (idle mode) 	Effect	U (Vp)	1	650	2	650	3	650	4	650	5	650	6	650	7	650	8	650	9	650
Effect	P (W) coag phase	P (W) cut phase																																																	
1	3	300																																																	
2	5	300																																																	
3	9	300																																																	
4	14	300																																																	
5	17	300																																																	
6	22	300																																																	
7	26	300																																																	
8	30	300																																																	
9	40	300																																																	
Effect	U (Vp)																																																		
1	650																																																		
2	650																																																		
3	650																																																		
4	650																																																		
5	650																																																		
6	650																																																		
7	650																																																		
8	650																																																		
9	650																																																		

Monopolar Cutting – GastroKNIFE 2

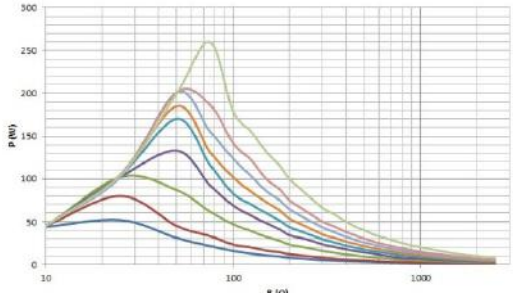
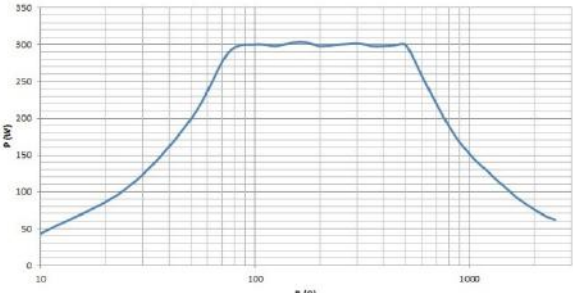
 <p>Measurement at ohmic resistances</p> <ul style="list-style-type: none"> Diagram of power output P [W] as a function of the load resistance R [Ω] for the setting "Monopolar Cutting GastroKNIFE 2" coag phase 	 <p>Measurement at ohmic resistances</p> <ul style="list-style-type: none"> Diagram of power output P [W] as a function of the load resistance R [Ω] for the setting "Monopolar Cutting GastroKNIFE 2" cut phase 																																																		
<table border="1" style="width: 100%; border-collapse: collapse; text-align: center;"> <thead> <tr> <th>Effect</th> <th>P (W) coag phase</th> <th>P (W) cut phase</th> </tr> </thead> <tbody> <tr><td>1</td><td>3</td><td>300</td></tr> <tr><td>2</td><td>5</td><td>300</td></tr> <tr><td>3</td><td>9</td><td>300</td></tr> <tr><td>4</td><td>14</td><td>300</td></tr> <tr><td>5</td><td>17</td><td>300</td></tr> <tr><td>6</td><td>22</td><td>300</td></tr> <tr><td>7</td><td>26</td><td>300</td></tr> <tr><td>8</td><td>30</td><td>300</td></tr> <tr><td>9</td><td>40</td><td>300</td></tr> </tbody> </table> <ul style="list-style-type: none"> Table of power output P [W] as a function of the setting "Monopolar Cutting GastroKNIFE 2" Rated load resistance= 500 Ω 	Effect	P (W) coag phase	P (W) cut phase	1	3	300	2	5	300	3	9	300	4	14	300	5	17	300	6	22	300	7	26	300	8	30	300	9	40	300	<table border="1" style="width: 100%; border-collapse: collapse; text-align: center;"> <thead> <tr> <th>Effect</th> <th>U (Vp)</th> </tr> </thead> <tbody> <tr><td>1</td><td>650</td></tr> <tr><td>2</td><td>650</td></tr> <tr><td>3</td><td>650</td></tr> <tr><td>4</td><td>650</td></tr> <tr><td>5</td><td>650</td></tr> <tr><td>6</td><td>650</td></tr> <tr><td>7</td><td>650</td></tr> <tr><td>8</td><td>650</td></tr> <tr><td>9</td><td>650</td></tr> </tbody> </table> <ul style="list-style-type: none"> Table of HF output voltage U [Vp] as a function of the setting "Monopolar Cutting GastroKNIFE 2" (idle mode) 	Effect	U (Vp)	1	650	2	650	3	650	4	650	5	650	6	650	7	650	8	650	9	650
Effect	P (W) coag phase	P (W) cut phase																																																	
1	3	300																																																	
2	5	300																																																	
3	9	300																																																	
4	14	300																																																	
5	17	300																																																	
6	22	300																																																	
7	26	300																																																	
8	30	300																																																	
9	40	300																																																	
Effect	U (Vp)																																																		
1	650																																																		
2	650																																																		
3	650																																																		
4	650																																																		
5	650																																																		
6	650																																																		
7	650																																																		
8	650																																																		
9	650																																																		

Monopolar Cutting – GastroKNIFE 3

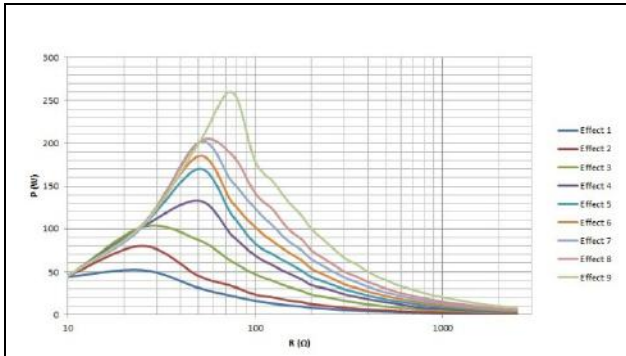

Measurement at ohmic resistances

- Diagram of power output P [W] as a function of the load resistance R [Ω] for the setting "Monopolar Cutting GastroKNIFE 3" coag phase

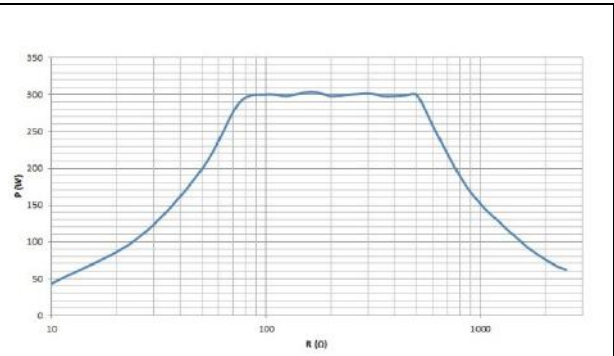

Measurement at ohmic resistances

- Diagram of power output P [W] as a function of the load resistance R [Ω] for the setting "Monopolar Cutting GastroKNIFE 3" cut phase

Effect	P (W) coag phase	P (W) cut phase
1	3	300
2	5	300
3	9	300
4	14	300
5	17	300
6	22	300
7	26	300
8	30	300
9	40	300

- Table of power output P [W] as a function of the setting "Monopolar Cutting GastroKNIFE 3" Rated load resistance= 500 Ω

Effect	U (Vp)
1	650
2	650
3	650
4	650
5	650
6	650
7	650
8	650
9	650

- Table of HF output voltage U [Vp] as a function of the setting "Monopolar Cutting GastroKNIFE 3" (idle mode)

Monopolar Coagulation – Moderate

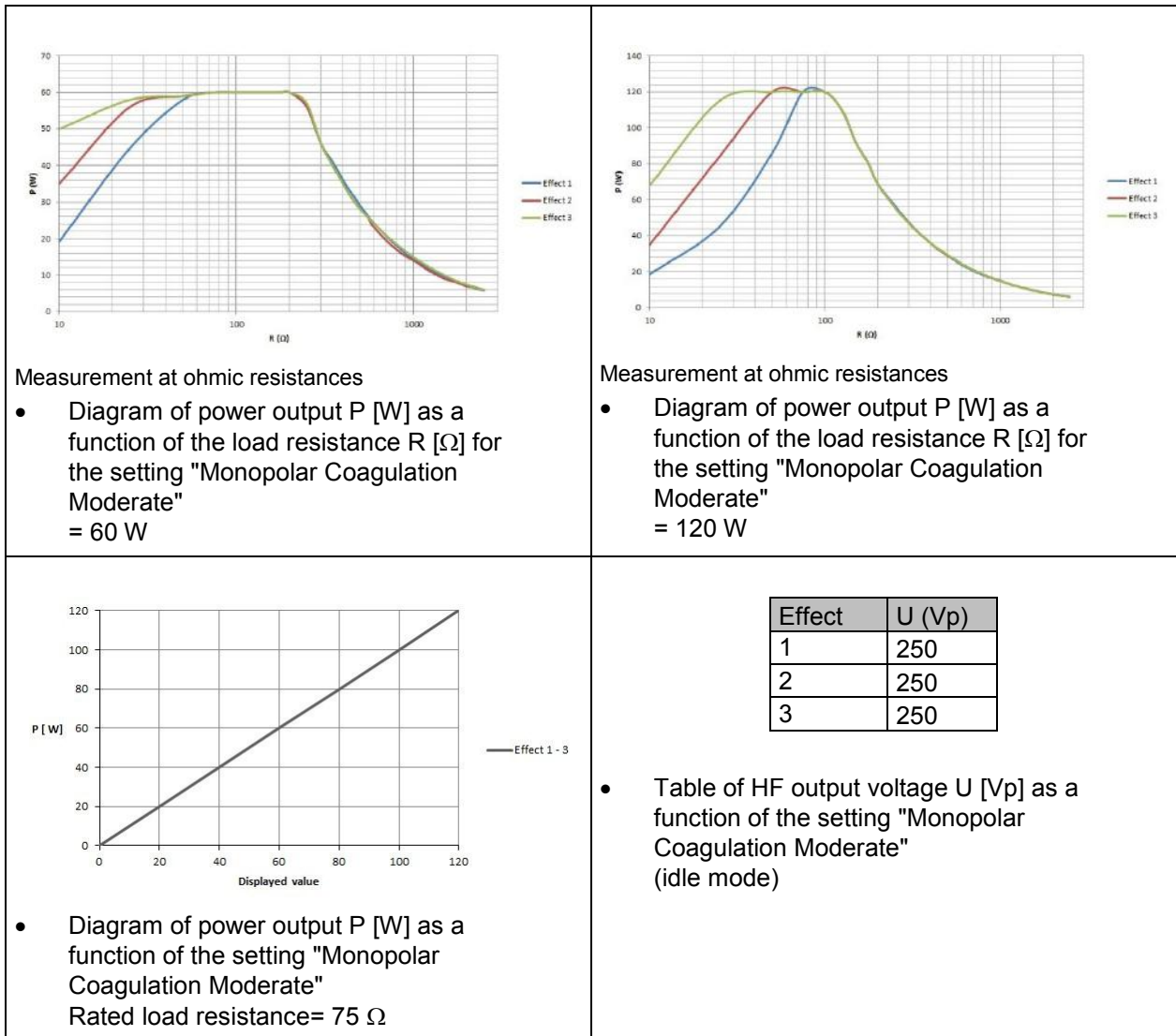

Monopolar Coagulation – Forced non cutting

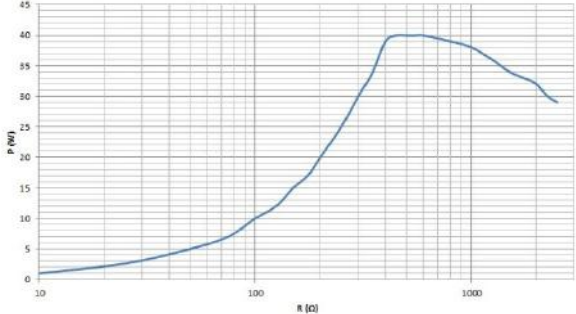
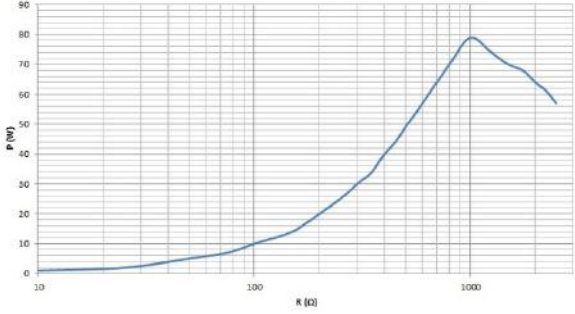
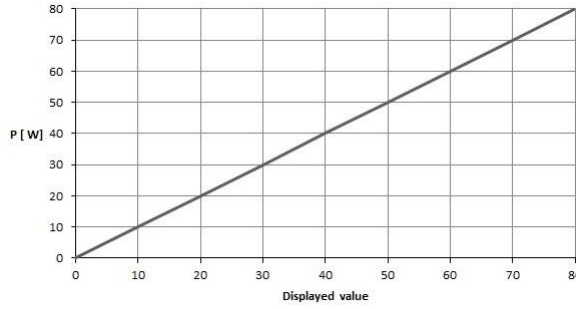
 <p>Measurement at ohmic resistances</p> <ul style="list-style-type: none"> • Diagram of power output P [W] as a function of the load resistance R [Ω] for the setting "Monopolar Coagulation Forced non cutting" = 40 W 	 <p>Measurement at ohmic resistances</p> <ul style="list-style-type: none"> • Diagram of power output P [W] as a function of the load resistance R [Ω] for the setting "Monopolar Coagulation Forced non cutting" = 80 W
 <ul style="list-style-type: none"> • Diagram of power output P [W] as a function of the setting "Monopolar Coagulation Forced non cutting" Rated load resistance = 1000 Ω 	<ul style="list-style-type: none"> • HF output voltage U [Vp] for the setting "Monopolar Coagulation Moderate" (idle mode) = 3500 Vp

Monopolar Coagulation – Forced mixed

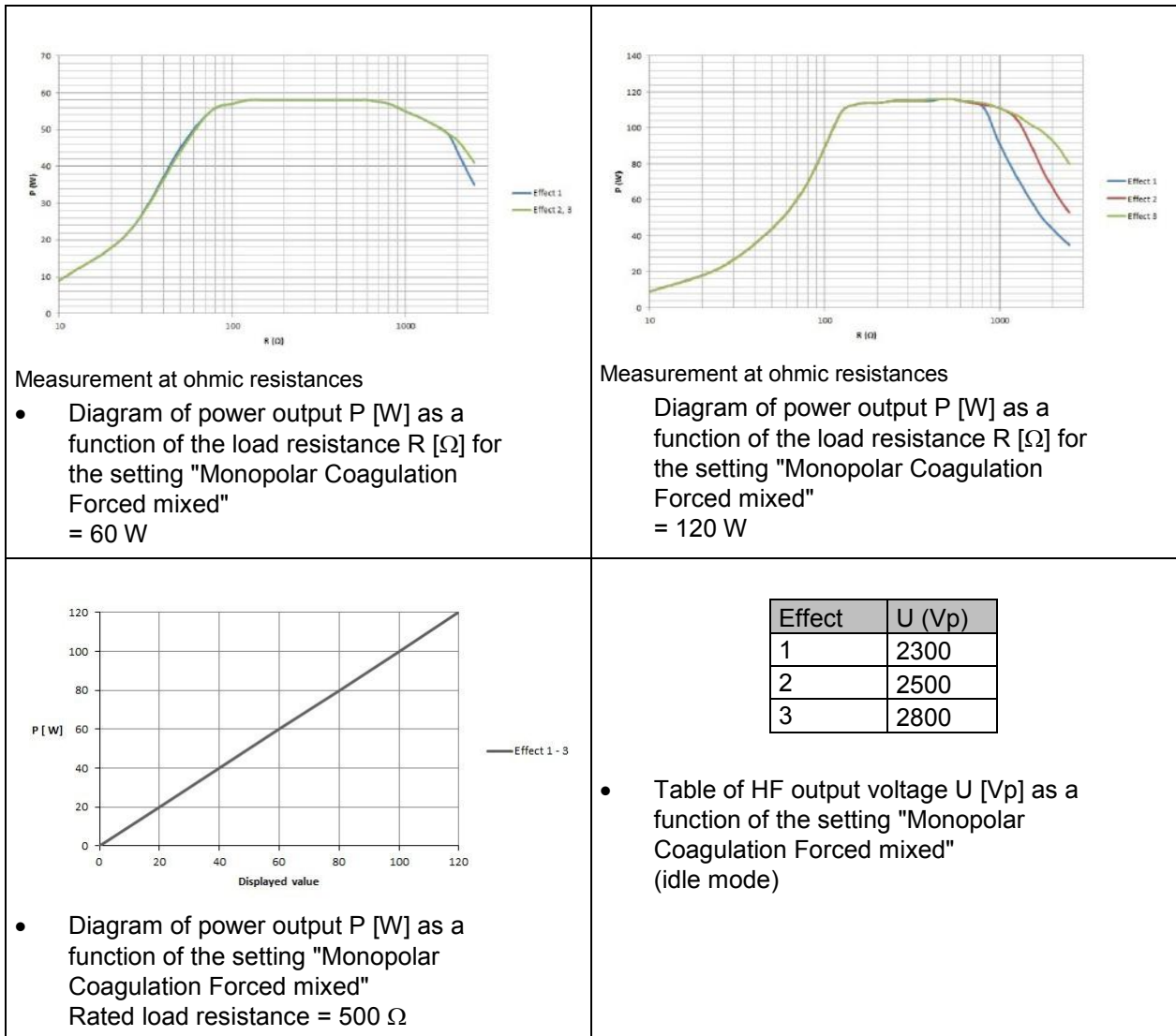

Monopolar Coagulation – Forced cutting

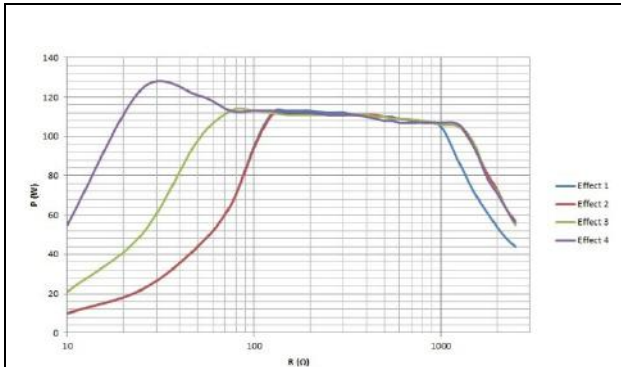

Measurement at ohmic resistances

- Diagram of power output P [W] as a function of the load resistance R [Ω] for the setting "Monopolar Coagulation Forced cutting" = 125 W

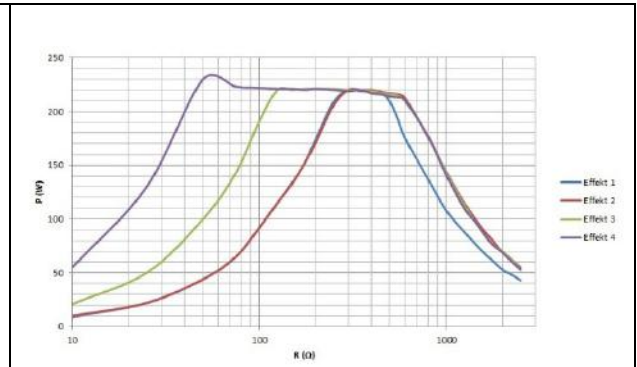

Measurement at ohmic resistances

- Diagram of power output P [W] as a function of the load resistance R [Ω] for the setting "Monopolar Coagulation Forced cutting" = 250 W

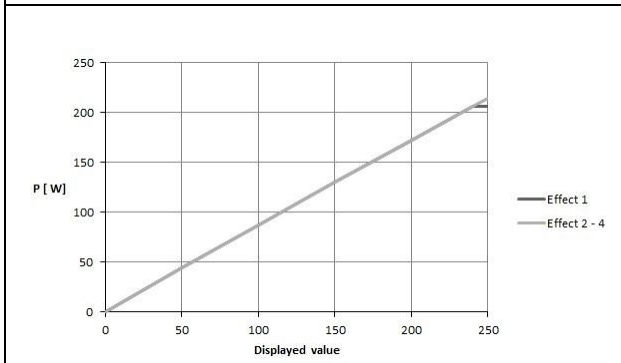

- Diagram of power output P [W] as a function of the setting "Monopolar Coagulation Forced cutting" Rated load resistance = 500 Ω

Effect	U (Vp)
1	1500
2	1500
3	1300
4	1300

- Table of HF output voltage U [Vp] as a function of the setting "Monopolar Coagulation Forced cutting" (idle mode)

Monopolar Coagulation – Spray

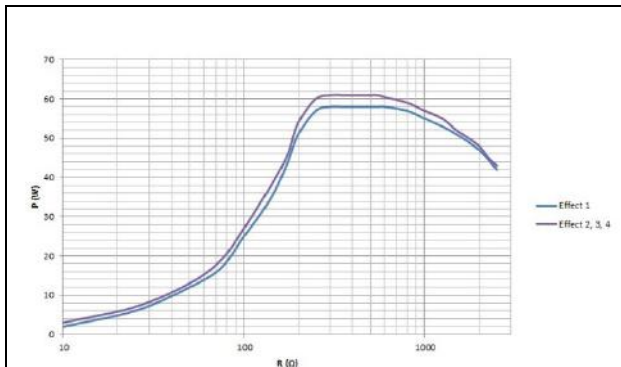

Measurement at ohmic resistances

- Diagram of power output P [W] as a function of the load resistance R [Ω] for the setting "Monopolar Coagulation Spray" = 60 W

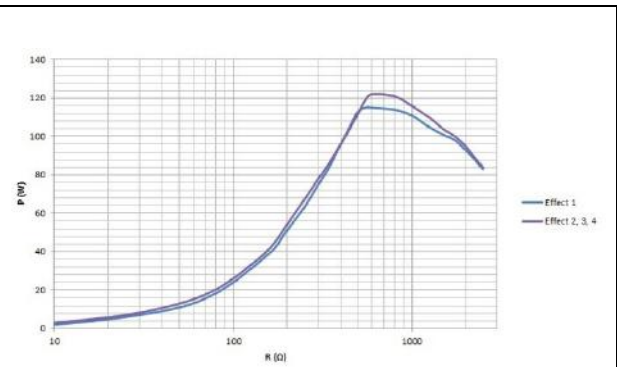

Measurement at ohmic resistances

- Diagram of power output P [W] as a function of the load resistance R [Ω] for the setting "Monopolar Coagulation Spray" = 120 W

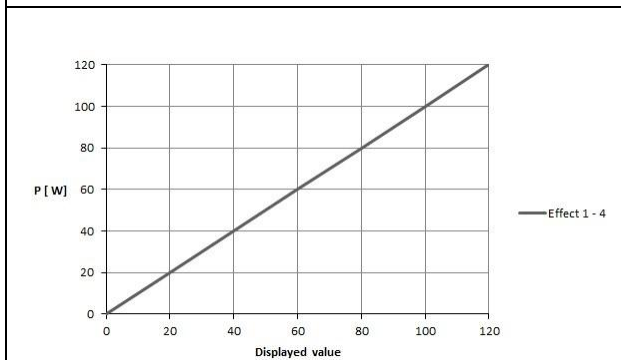

- Diagram of power output P [W] as a function of the setting "Monopolar Coagulation Spray" Rated load resistance = 500 Ω

Effect	U (Vp)
1	3000
2	3800
3	4600
4	5000

- Table of HF output voltage U [Vp] as a function of the setting "Monopolar Coagulation Spray" (idle mode)

Monopolar Coagulation – Argon open

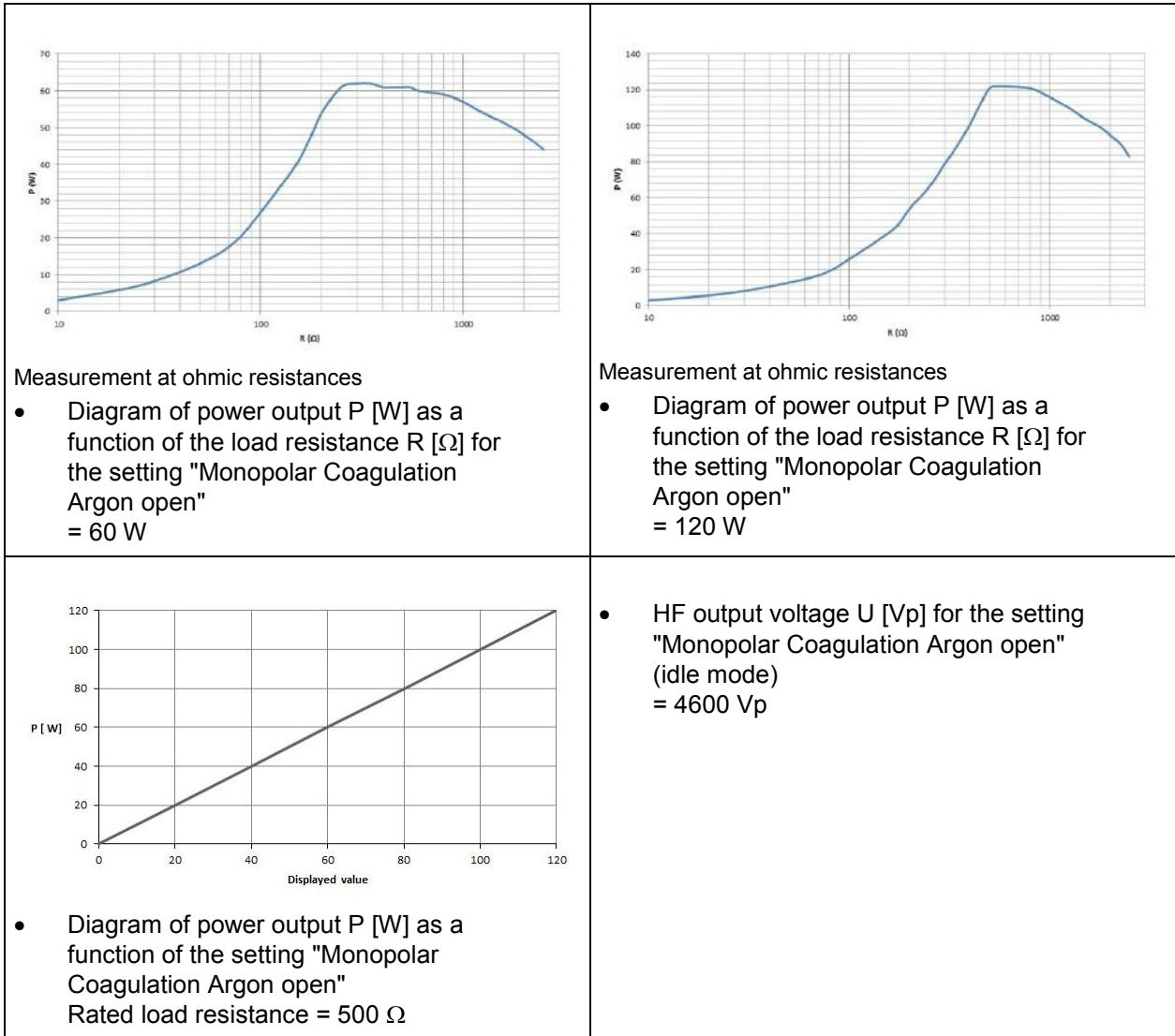

Monopolar Coagulation – Argon flexible

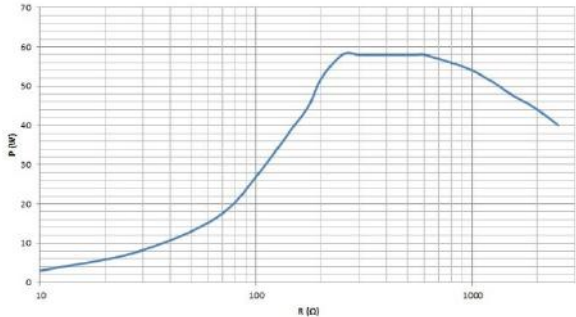
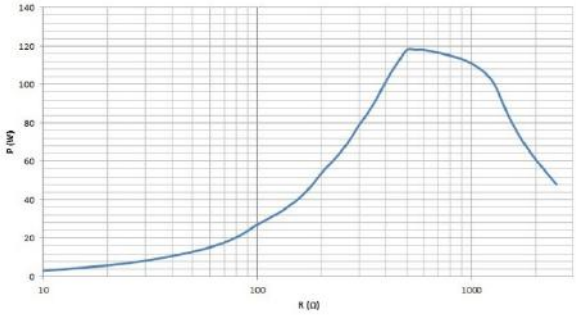
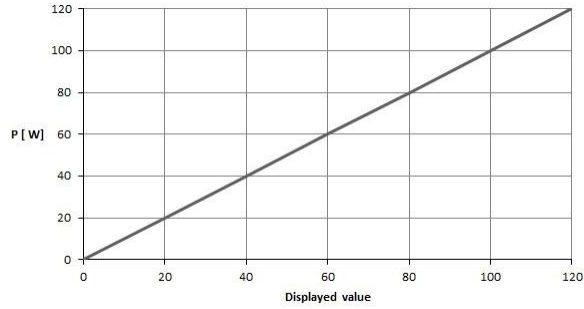
 <p>Measurement at ohmic resistances</p> <ul style="list-style-type: none"> • Diagram of power output P [W] as a function of the load resistance R [Ω] for the setting "Monopolar Coagulation Argon flexible" = 60 W 	 <p>Measurement at ohmic resistances</p> <ul style="list-style-type: none"> • Diagram of power output P [W] as a function of the load resistance R [Ω] for the setting "Monopolar Coagulation Argon flexible" = 120 W
 <ul style="list-style-type: none"> • Diagram of power output P [W] as a function of the setting "Monopolar Coagulation Argon flexible" Rated load resistance = 500 Ω 	<ul style="list-style-type: none"> • HF output voltage U [Vp] for the setting "Monopolar Coagulation Argon flexible" (idle mode) = 4400 Vp

Monopolar Coagulation – Argon flex. pulse

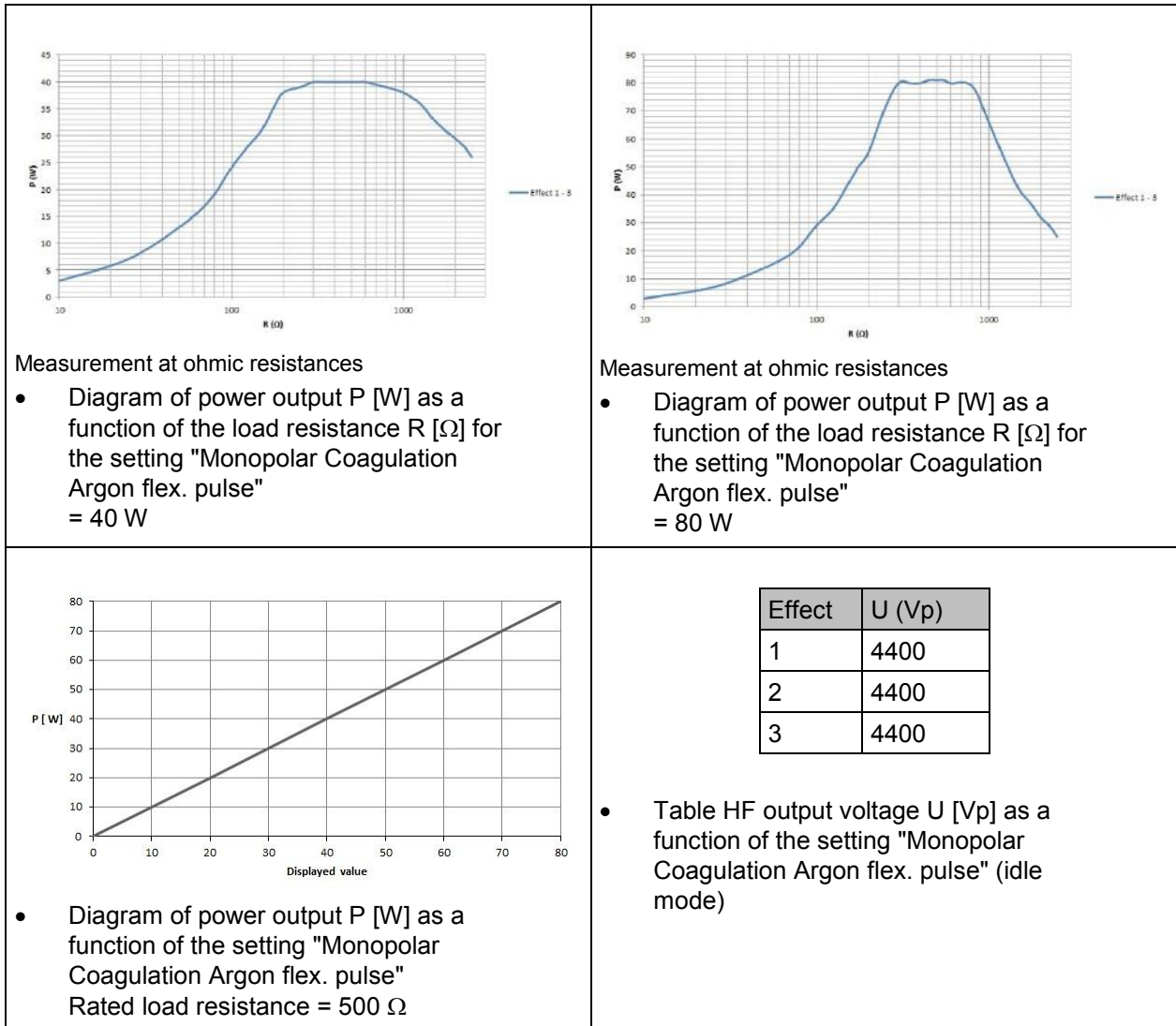

The puls frequency changes with the effect setting. The higher the effect level, the faster the pulse sequence.
 Effect 1: 1 Hz, effect 2: 5 Hz, effect 3: 10 Hz
 The mode "Argon flexible" is paused due to the pulse sequence.

Monopolar Coagulation – Resection

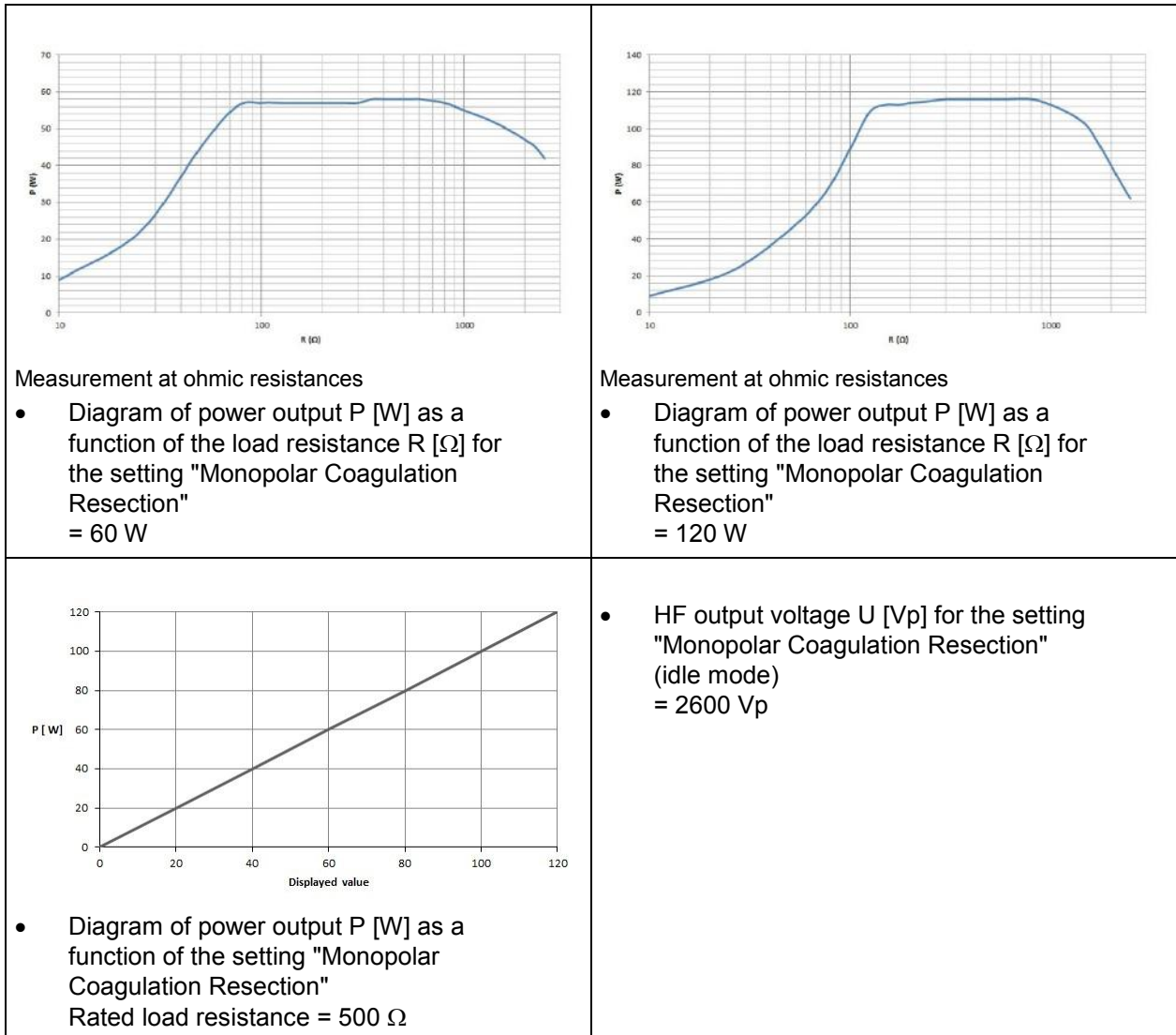

Monopolar Coagulation – Cardiac Mammary

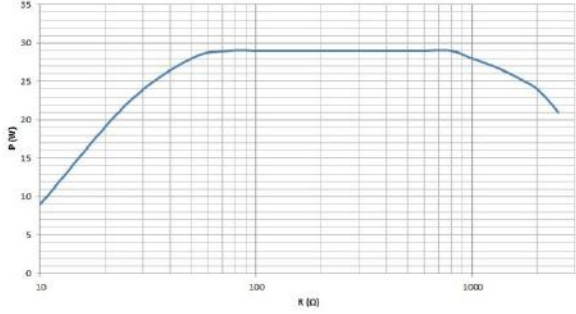
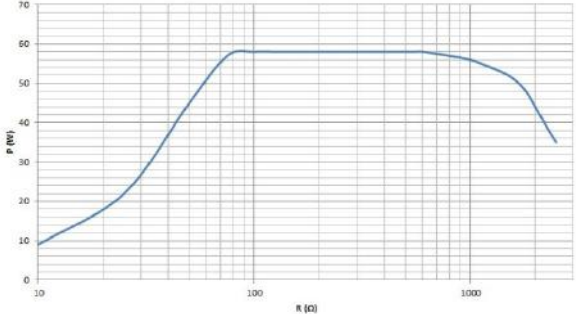
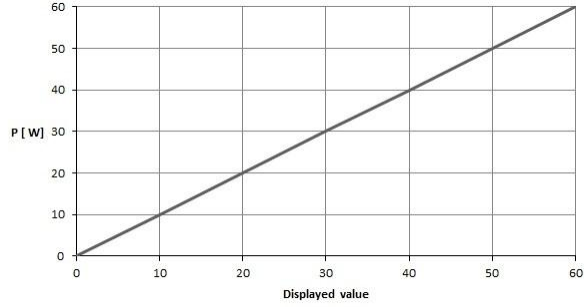
 <p>Measurement at ohmic resistances</p> <ul style="list-style-type: none"> • Diagram of power output P [W] as a function of the load resistance R [Ω] for the setting "Monopolar Coagulation Cardiac Mammary" = 30 W 	 <p>Measurement at ohmic resistances</p> <ul style="list-style-type: none"> • Diagram of power output P [W] as a function of the load resistance R [Ω] for the setting "Monopolar Coagulation Cardiac Mammary" = 60 W
 <ul style="list-style-type: none"> • Diagram of power output P [W] as a function of the setting "Monopolar Coagulation Cardiac Mammary" Rated load resistance = 500 Ω 	<ul style="list-style-type: none"> • HF output voltage U [Vp] for the setting "Monopolar Coagulation Cardiac Mammary" (idle mode) = 2300 Vp

Monopolar Coagulation – Cardiac Thorax

<p>Measurement at ohmic resistances</p> <ul style="list-style-type: none"> • Diagram of power output P [W] as a function of the load resistance R [Ω] for the setting "Monopolar Coagulation Cardiac Thorax" = 50 W 	<p>Measurement at ohmic resistances</p> <ul style="list-style-type: none"> • Diagram of power output P [W] as a function of the load resistance R [Ω] for the setting "Monopolar Coagulation Cardiac Thorax" = 100 W
	<ul style="list-style-type: none"> • HF output voltage U [Vp] for the setting "Monopolar Coagulation Cardiac Thorax" (idle mode) = 2300 Vp

Monopolar Coagulation – SimCoag

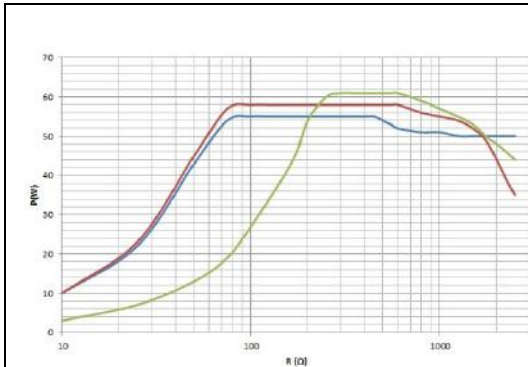

Measurement at ohmic resistances

- Diagram of power output P [W] as a function of the load resistance R [Ω] for the setting "Monopolar Coagulation SimCoag" = 60 W

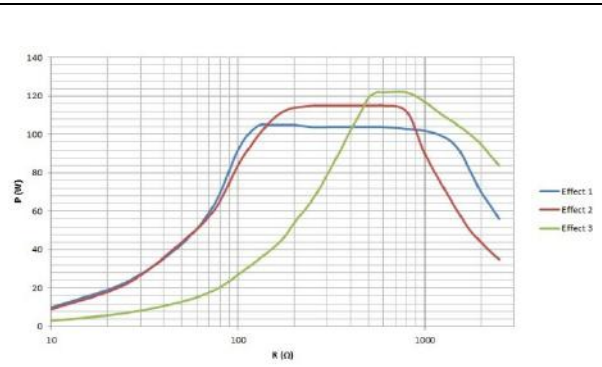

Measurement at ohmic resistances

- Diagram of power output P [W] as a function of the load resistance R [Ω] for the setting "Monopolar Coagulation SimCoag" = 120 W

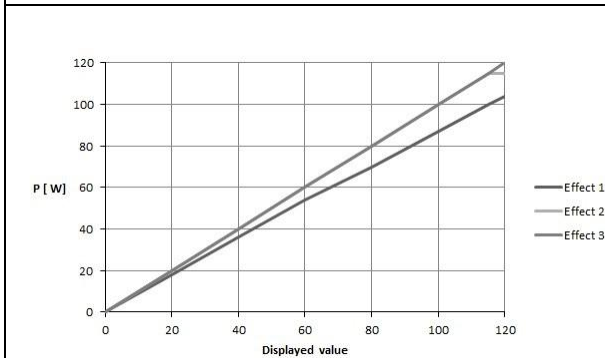

- Diagram of power output P [W] as a function of the setting "Monopolar Coagulation SimCoag" Rated load resistance = 500 Ω

Effect	U (Vp)
1	1500
2	2300
3	4600

- Table of HF output voltage U [Vp] as a function of the setting "Monopolar Coagulation SimCoag" (idle mode)

Monopolar Coagulation – Gastro Coag

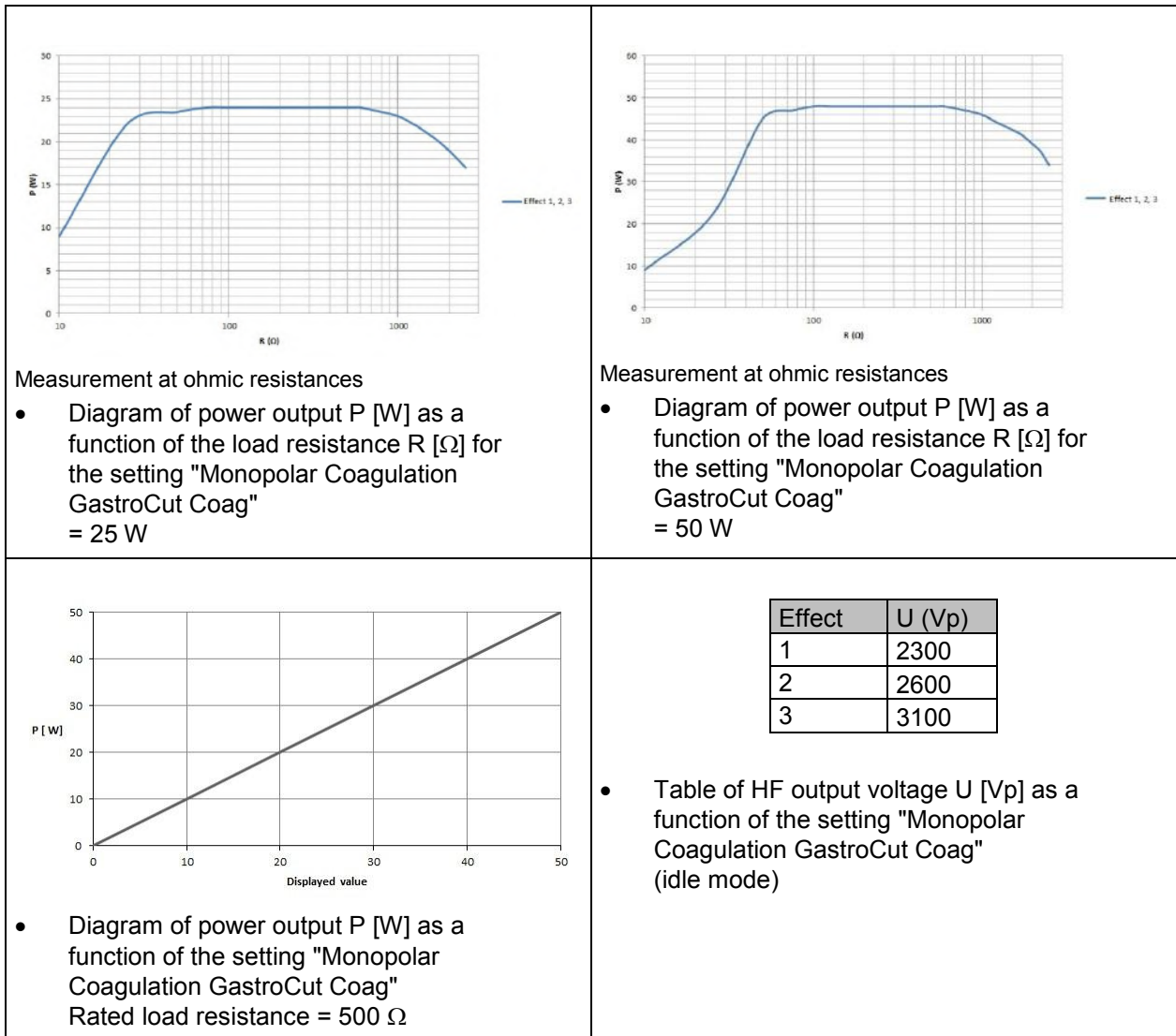

Monopolar Coagulation – Laparoscopy

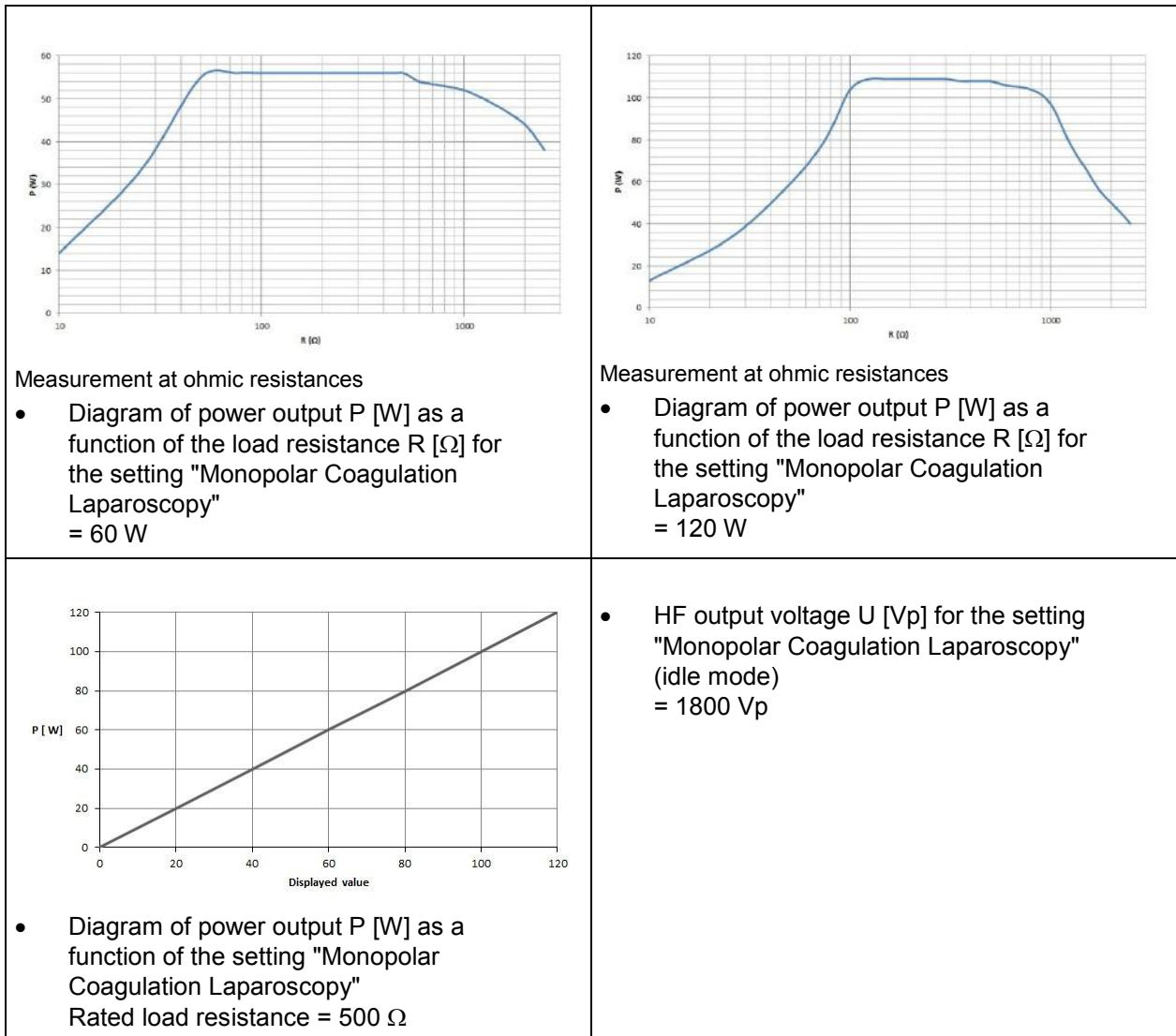

Bipolar Cutting – Standard

<p>Measurement at ohmic resistances</p> <ul style="list-style-type: none"> • Diagram of power output P [W] as a function of the load resistance R [Ω] for the setting "Bipolar Cutting Standard" = 100 W 	<p>Measurement at ohmic resistances</p> <ul style="list-style-type: none"> • Diagram of power output P [W] as a function of the load resistance R [Ω] for the setting "Bipolar Cutting Standard" = 200 W
	<ul style="list-style-type: none"> • HF output voltage U [Vp] for the setting "Bipolar Cutting Standard" (idle mode) = 400 Vp

Bipolar Cutting – Resection

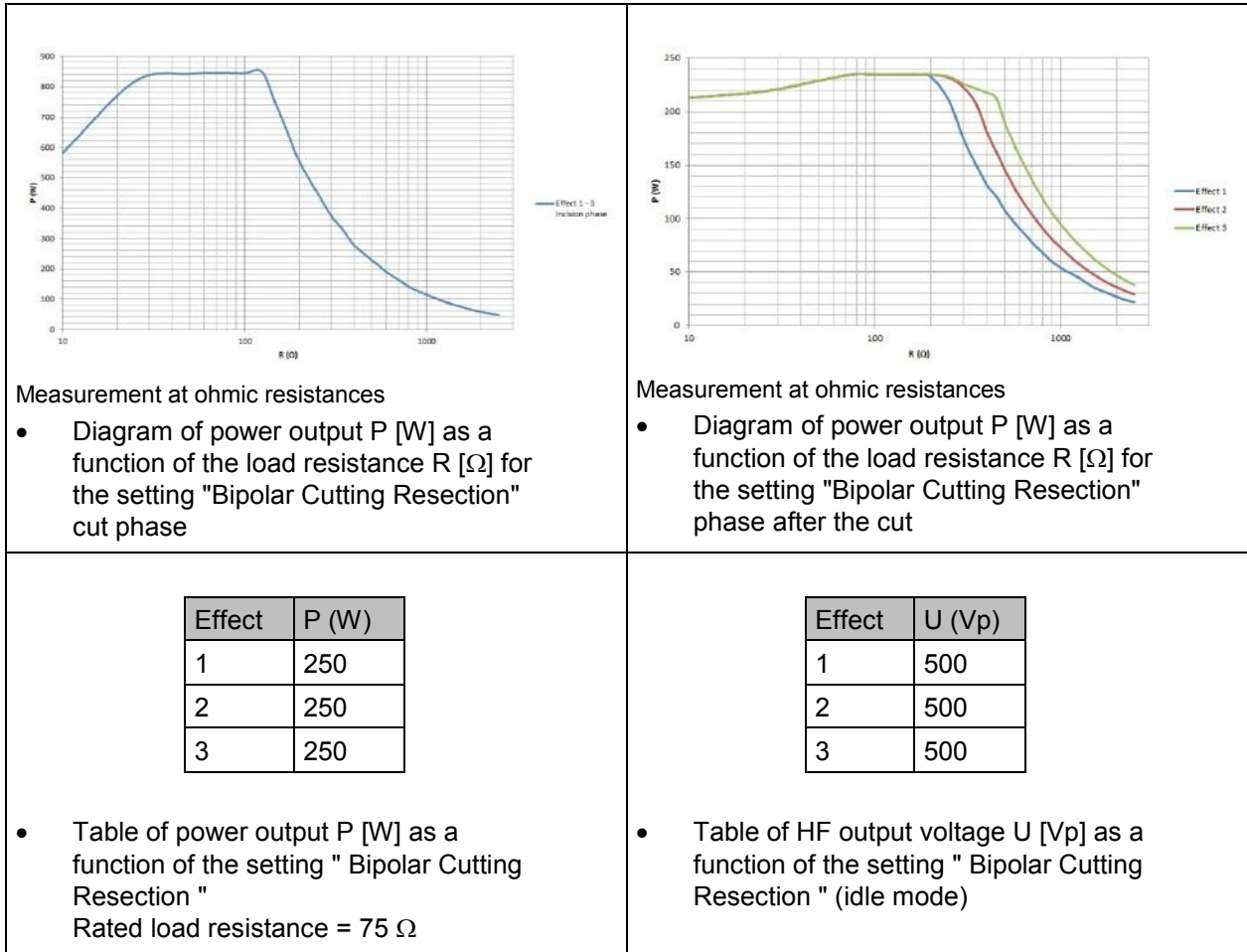

Bipolar Cutting – Bipolar scissors

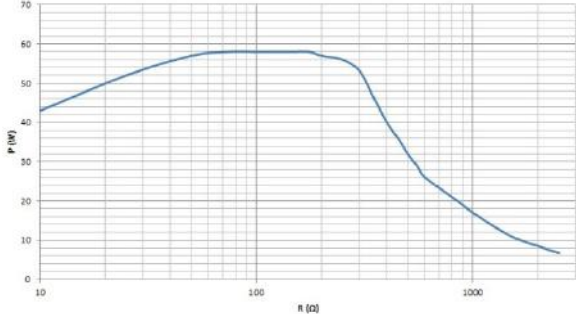
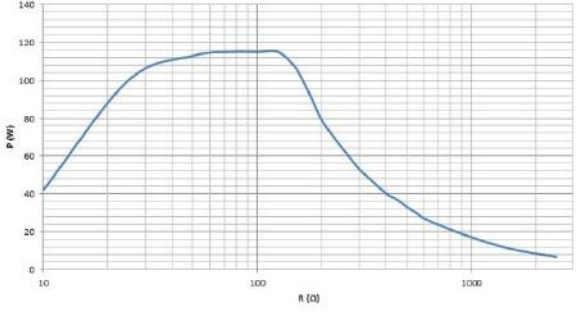
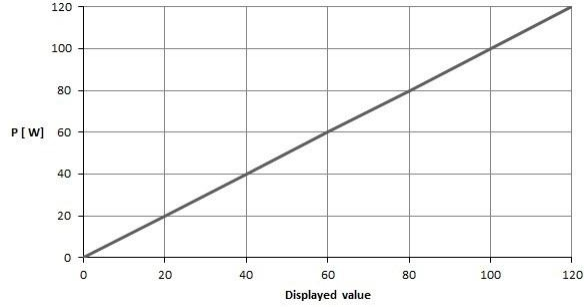
 <p>Measurement at ohmic resistances</p> <ul style="list-style-type: none"> • Diagram of power output P [W] as a function of the load resistance R [Ω] for the setting "Bipolar Cutting n bipolar scissors" = 60 W 	 <p>Measurement at ohmic resistances</p> <ul style="list-style-type: none"> • Diagram of power output P [W] as a function of the load resistance R [Ω] for the setting "Bipolar Cutting bipolar scissors" = 120 W
 <ul style="list-style-type: none"> • Diagram of power output P [W] as a function of the setting " Bipolar Cutting bipolar scissors " Rated load resistance = 75 Ω 	<ul style="list-style-type: none"> • HF output voltage U [Vp] for the setting " Bipolar Cutting Bipolar scissors " (idle mode) = 200 Vp

Bipolar Coagulation – Standard forceps

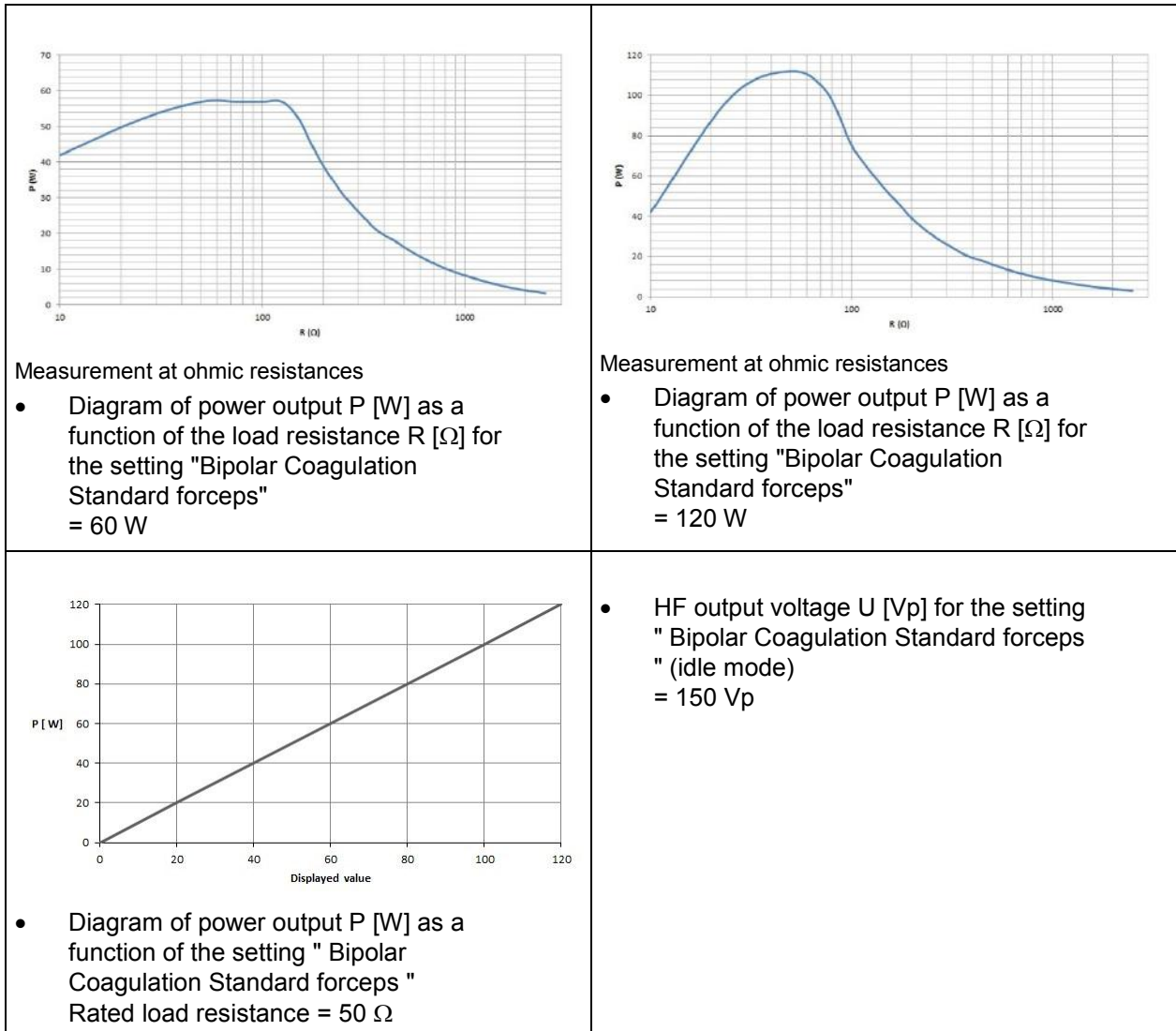

Bipolar Coagulation – Standard forceps AUTOSTART

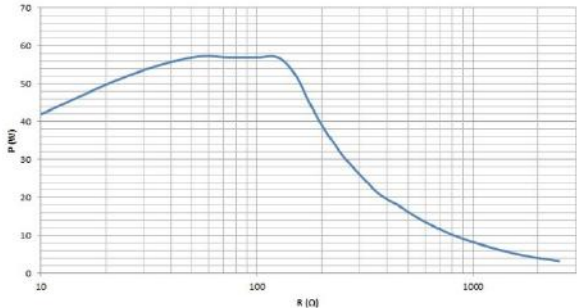
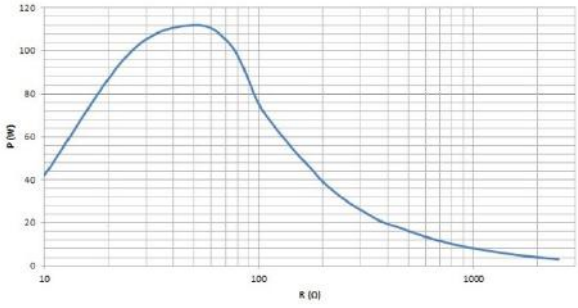
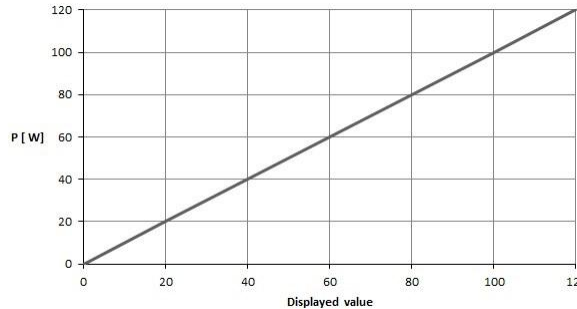
 <p>Measurement at ohmic resistances</p> <ul style="list-style-type: none"> • Diagram of power output P [W] as a function of the load resistance R [Ω] for the setting "Bipolar Coagulation Standard forceps AUTOSTART" = 60 W 	 <p>Measurement at ohmic resistances</p> <ul style="list-style-type: none"> • Diagram of power output P [W] as a function of the load resistance R [Ω] for the setting "Bipolar Coagulation Standard forceps AUTOSTART" = 120 W
 <ul style="list-style-type: none"> • Diagram of power output P [W] as a function of the setting " Bipolar Coagulation Standard forceps AUTOSTART" Rated load resistance = 50 Ω 	<ul style="list-style-type: none"> • HF output voltage U [Vp] for the setting " Bipolar Coagulation Standard forceps AUTOSTART" (idle mode) = 150 Vp

Bipolar Coagulation – Micro forceps

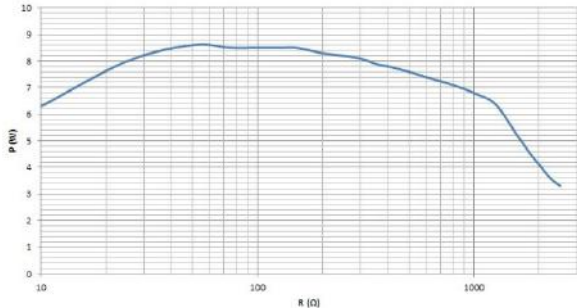
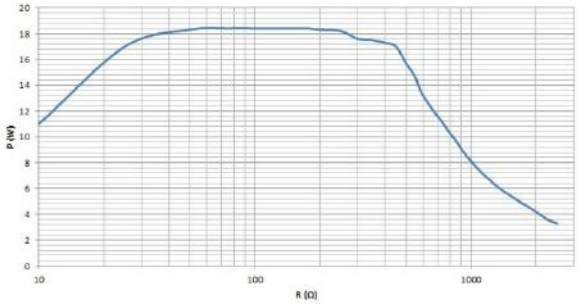
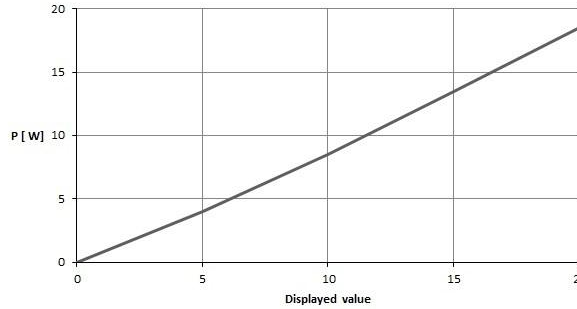
 <p>Measurement at ohmic resistances</p> <ul style="list-style-type: none"> • Diagram of power output P [W] as a function of the load resistance R [Ω] for the setting "Bipolar Coagulation Micro forceps" = 10 W 	 <p>Measurement at ohmic resistances</p> <ul style="list-style-type: none"> • Diagram of power output P [W] as a function of the load resistance R [Ω] for the setting "Bipolar Coagulation Micro forceps" = 20 W
 <ul style="list-style-type: none"> • Diagram of power output P [W] as a function of the setting " Bipolar Coagulation Micro forceps " Rated load resistance = 50 Ω 	<ul style="list-style-type: none"> • HF output voltage U [Vp] for the setting " Bipolar Coagulation Micro forceps " (idle mode) = 150 Vp

Bipolar Coagulation – Forceps forced

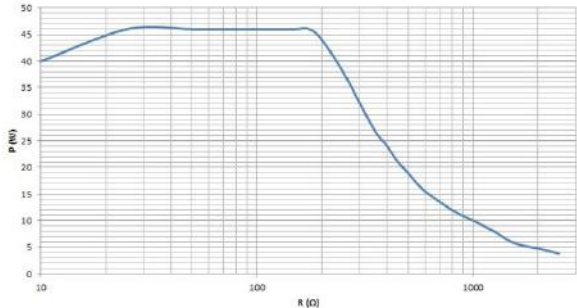
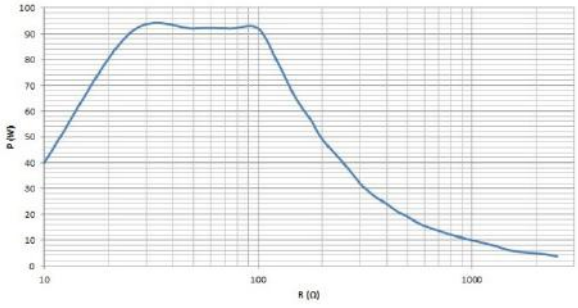
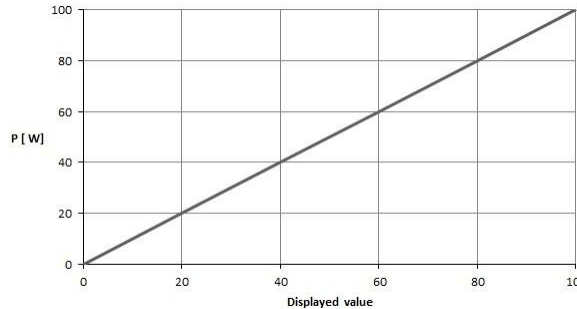
 <p>Measurement at ohmic resistances</p> <ul style="list-style-type: none"> • Diagram of power output P [W] as a function of the load resistance R [Ω] for the setting "Bipolar Coagulation forceps forced" = 50 W 	 <p>Measurement at ohmic resistances</p> <ul style="list-style-type: none"> • Diagram of power output P [W] as a function of the load resistance R [Ω] for the setting "Bipolar Coagulation forceps forced" = 100 W
 <ul style="list-style-type: none"> • Diagram of power output P [W] as a function of the setting " Bipolar Coagulation forceps forced " Rated load resistance = 50 Ω 	<ul style="list-style-type: none"> • HF output voltage U [Vp] for the setting " Bipolar Coagulation forceps forced " (idle mode) = 550 Vp

LIGATION / TissueSeal PLUS

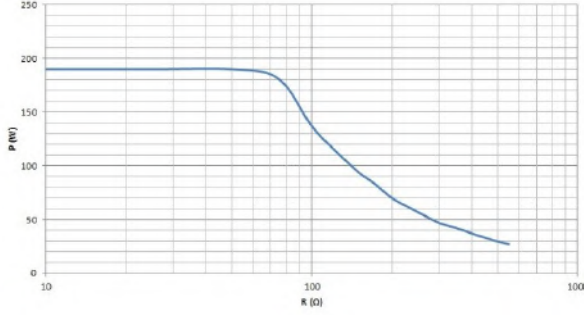
 <p>Measurement at ohmic resistances</p> <ul style="list-style-type: none"> • Diagram of power output P [W] as a function of the load resistance R [Ω] for the setting "LIGATION" 	
<ul style="list-style-type: none"> • Power output P [W] as a function of the setting " LIGATION " Rated load resistance (25 Ω) = 200 W 	<ul style="list-style-type: none"> • HF output voltage U [Vp] for the setting " LIGATION " (idle mode) = 190 Vp

Bipolar Coagulation – Bipolar scissors

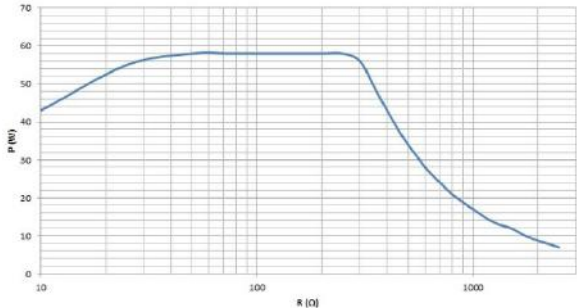
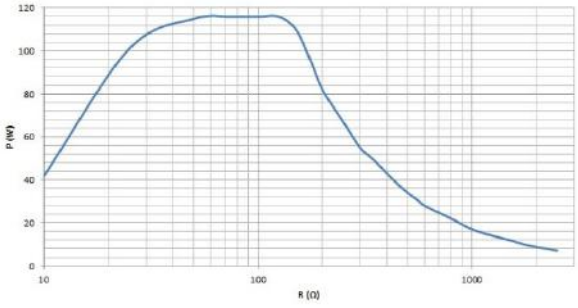
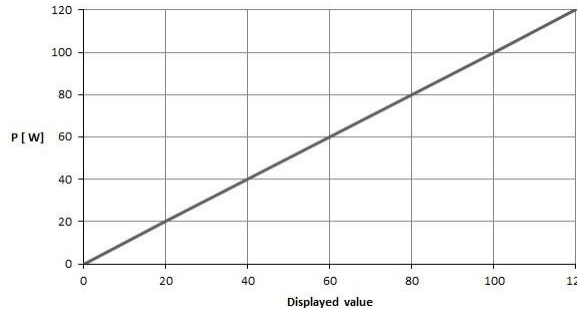
 <p>Measurement at ohmic resistances</p> <ul style="list-style-type: none"> • Diagram of power output P [W] as a function of the load resistance R [Ω] for the setting "Bipolar Coagulation bipolar scissors" = 60 W 	 <p>Measurement at ohmic resistances</p> <ul style="list-style-type: none"> • Diagram of power output P [W] as a function of the load resistance R [Ω] for the setting "Bipolar Coagulation bipolar scissors" = 120 W
 <ul style="list-style-type: none"> • Diagram of power output P [W] as a function of the setting " Bipolar Coagulation bipolar scissors" Rated load resistance = 75 Ω 	<ul style="list-style-type: none"> • HF output voltage U [Vp] for the setting " Bipolar Coagulation Bipolar scissors " (idle mode) = 200 Vp

Bipolar Coagulation– Laparoscopy

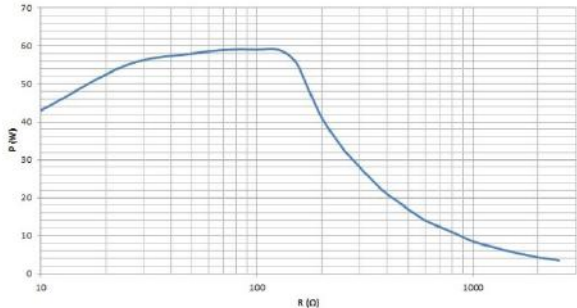
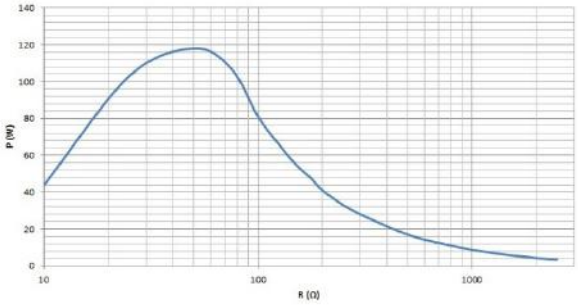
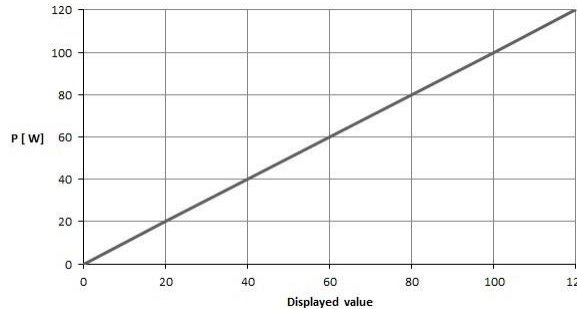
 <p>Measurement at ohmic resistances</p> <ul style="list-style-type: none"> • Diagram of power output P [W] as a function of the load resistance R [Ω] for the setting "Bipolar Coagulation Laparoscopy" = 60 W 	 <p>Measurement at ohmic resistances</p> <ul style="list-style-type: none"> • Diagram of power output P [W] as a function of the load resistance R [Ω] for the setting "Bipolar Coagulation Laparoscopy" = 120 W
 <ul style="list-style-type: none"> • Diagram of power output P [W] as a function of the setting " Bipolar Coagulation Laparoscopy " Rated load resistance = 50 Ω 	<ul style="list-style-type: none"> • HF output voltage U [Vp] for the setting " Bipolar Coagulation Laparoscopy " (idle mode) = 150 Vp

Bipolar Coagulation – Bipolar Resection

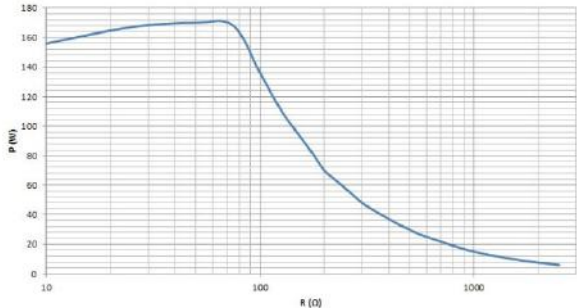
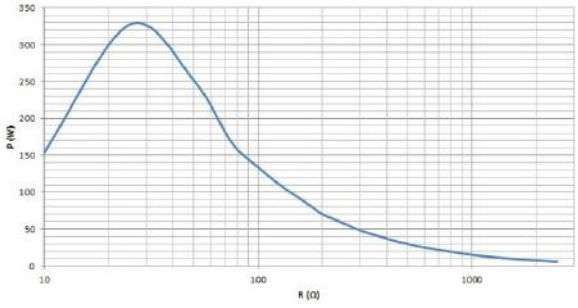
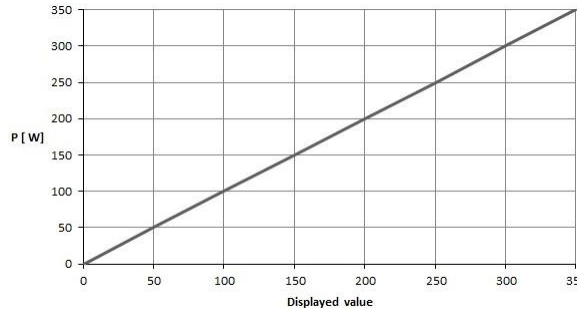
 <p>Measurement at ohmic resistances</p> <ul style="list-style-type: none"> • Diagram of power output P [W] as a function of the load resistance R [Ω] for the setting "Bipolar Coagulation Bipolar Resection" = 175 W 	 <p>Measurement at ohmic resistances</p> <ul style="list-style-type: none"> • Diagram of power output P [W] as a function of the load resistance R [Ω] for the setting "Bipolar Coagulation Bipolar Resection" = 350 W
 <ul style="list-style-type: none"> • Diagram of power output P [W] as a function of the setting " Bipolar Coagulation Bipolar Resection " Rated load resistance = 25 Ω 	<ul style="list-style-type: none"> • HF output voltage U [Vp] for the setting " Bipolar Coagulation Bipolar Resection " (idle mode) = 190 Vp

11. Accessories and replacement parts

Original BOWA accessories are suitable for use with the ARC Series and ARC PLUS devices. When using accessories made by other manufacturers, the user must ensure that they are designed for and compatible with the maximum HF peak voltage of the HF device.

For the use and correct preparation of the autoclavable devices, compliance with the relevant instruction manuals accompanying these devices is required.

Detailed information on accessories and replacement parts is available in the current accessories catalog.

12. EMC

12.1. Guidelines and manufacturer's declaration in accordance with IEC 60601-1-2 Section 6.8.3.201

Emission of electromagnetic interference (IEC 60601-1-2, Table 201)		
The ARC 350 is intended for operation in an electromagnetic environment as described below. The customer or user of the ARC 350 should ensure that it is operated in such an environment.		
Interference emission measurement	Conformity	Electromagnetic environment guideline
HF emissions according to CISPR 11	Group 2	The ARC 350 must emit electromagnetic energy in order to perform its intended function. Nearby electronic devices may be affected.
HF emissions according to CISPR 11	Class A	The ARC 350 is suitable for use in facilities other than those suitable for a residential environment or those connected directly to the public power grid, which also supplies power to buildings used for residential purposes.
Emission of harmonics according to IEC 61000-3-2	Classes A and D	
Emission of voltage fluctuations and flickere according to IEC 61000-3-3	Conforms	

Immunity to electromagnetic interference (IEC 60601-1-2, Table 202)			
The ARC 350 is intended for operation in an electromagnetic environment as described below. The customer or user of the ARC 350 should ensure that it is operated in such an environment.			
Interference immunity test	IEC 60601 test level	Conformity level	Electromagnetic environment guidelines
Electrostatic discharge (ESD) according to IEC 61000-4-2	±6 kV contact discharge	±6 kV contact discharge	Floors should be wooden or concrete or finished with ceramic tiles. If the floor is finished with a synthetic material, the relative humidity must be at least 30%.
	±8 kV air discharge	±8 kV air discharge	
Fast transient electrical noise or bursts according to IEC 61000-4-4	±2 kV on AC supply lines	±2 kV on AC supply lines	The quality of the AC power should correspond to that of a typical business or hospital environment.
	±1 kV on input and output lines	±1 kV on input and output lines	
Surges according to IEC 61000-4-5	±1 kV between external conductors	±1 kV between external conductors	The quality of the AC power should correspond to that of a typical business or hospital environment.
	±2 kV between external conductor and ground	±2 kV between external conductor and ground	
Voltage dropouts, brief interruptions and supply voltage fluctuations according to IEC 61000-4-11	< 5% U_T for one half-cycle (> 95% dropout) 40% U_T for 5 cycles (60% dropout) 70% U_T for 25 cycles (30% dropout) < 5% U_T for 5 s (> 95% dropout)	< 5% U_T for one half-cycle (> 95% dropout) 40% U_T for 5 cycles (60% dropout) 70% U_T for 25 cycles (30% dropout) < 5% U_T for 5 s (> 95% dropout)	The quality of the AC power should correspond to that of a typical business or hospital environment. If the ARC 400 user requires it to continue operating in the event of a power dropout, it is recommended to power the ARC 400 from an uninterruptible power supply or a battery.
Note: U_T is the AC supply voltage before the test level is applied.			

Immunity to electromagnetic interference (IEC 60601-1-2, Table 204)			
The ARC 350 is intended for operation in an electromagnetic environment as described below. The customer or user of the ARC 350 should ensure that it is operated in such an environment.			
Interference immunity test	IEC 60601 test level	Conformity level	Electromagnetic environment guidelines
Conducted HF interference according to IEC 61000-4-6	3 Vrms 150 kHz to 80 MHz	10 V	<p>Portable and mobile wireless devices should not be used inside the recommended protective distance from the ARC 400 and its cables, as calculated using the equation for the relevant transmission frequency.</p> <p>Recommended protective distance:</p> $d = 0.35 \times \sqrt{P}$ $d = 0.35 \times \sqrt{P} \text{ for } 80 \text{ MHz to } 800 \text{ GHz}$ $d = 0.75 \times \sqrt{P} \text{ for } 80 \text{ MHz to } 2.5 \text{ GHz}$ <p>where P is the rated transmitter output power in watts (W) as specified by the transmitter manufacturer and d is the recommended protective distance in meters (m).</p> <p>The field strength of stationary transmitters as determined by on-site measurements^a should be lower than the compliance level^b at all frequencies.</p> <p>Interference is possible in the vicinity of devices that bear the following symbol:</p> <div style="text-align: right;"></div>
Radiated HF interference according to IEC 61000-4-3	3 V/m 80 MHz to 2.5 GHz	10 V/m	
Note 1	The higher frequency range applies in case of 80 MHz and 800 MHz.		
Note 2	These guidelines may not be applicable in all cases. The propagation of electromagnetic waves is influenced by absorption and reflection by buildings, objects and people.		
^a	Field strengths from stationary transmitters, such as base stations for radio telephones, land mobile radios, amateur radio, AM and FM radio broadcasting and TV broadcasting, cannot be predicted accurately based on theoretical considerations. A survey of the electromagnetic conditions at the site should be performed to determine the electromagnetic environment resulting from stationary transmitters. If the measured field strength at the location where the ARC 400 is used exceeds the stated compliance level, the ARC 400 should be monitored to verify that it operates correctly. Additional measures, such as altering the orientation or location of the ARC 400, may be necessary if abnormal operation is observed.		
^b	The field strength should be lower than 10 V/m over the frequency range of 150 kHz to 80 MHz.		

Recommended protective distances between portable and mobile HF telecommunication devices and the ARC 400 (IEC 60601-1-2, Table 206)			
<p>The ARC 350 is designed for operation in an electromagnetic environment in which HF interference is monitored. The customer or user of the ARC 350 can help to prevent electromagnetic interference by complying with the minimum distance between portable and mobile HF telecommunication devices (transmitters) and the ARC 400. This distance depends on the output power of the communication device, as specified below.</p>			
Rated transmitter power (W)	Protective distance (m) at various transmission frequencies		
	150 kHz to 80 MHz $d = 0.35 \times \sqrt{P}$	80 MHz to 800 GHz $d = 0.35 \times \sqrt{P}$	800 MHz to 2.5 GHz $d = 0.7 \times \sqrt{P}$
0.01	0.035	0.035	0.07
0.1	0.11	0.11	0.22
1	0.35	0.35	0.70
10	1.1	1.1	2.2
100	3.5	3.5	7.0
<p>For transmitters whose maximum rated power is not specified in the table above, the recommended protective distance d in meters (m) can be determined using the equation in the corresponding column, where P is the maximum rated output power of the transmitter in watts (W) as specified by the transmitter manufacturer.</p>			
Note 1	The higher frequency range applies in case of 80 MHz and 800 MHz.		
Note 2	These guidelines may not be applicable in all cases. The propagation of electromagnetic waves is influenced by absorption and reflection by buildings, objects and people.		

13. Disposal



Always comply with the national regulations of the relevant country when disposing of or recycling the device or its components.

Symbol	Designation
	<p>A device marked with this symbol must be put into the separate waste collection for electrical and electronic devices. Disposal is carried out free of charge by the manufacturer within the European Union.</p>

- ▶ If you have any questions regarding product disposal, contact the service center, see section Technical service, page 73

BOWA
EINFACH SICHER

BOWA-electronic GmbH & Co. KG
Heinrich-Hertz Strasse 4–10
D-72810 Gomaringen | Germany

Phone: +49 (0) 7072-6002-0
Fax: +49 (0) 7072-6002-33
info@bowa-medical.com | www.bowa-medical.com



CE marked according to
Medical Device 93/42/EWG