

# **pact**® 3D METAL MULTI-HOLE THIN

HEMISPHERICAL CEMENTLESS CUP SYSTEM

EVOLVING SAFETY

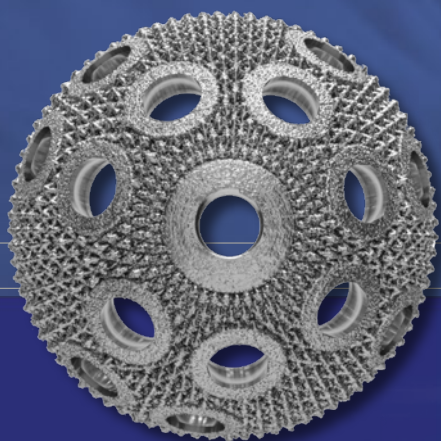

## Surgical Technique

Joint

Spine

Sports Med



## TABLE OF CONTENTS

|  |           |
|--|-----------|
| <b>1. INTRODUCTION</b>   | <b>4</b>  |
| 1.1 Indications  | 4         |
| 1.2 Contraindications  | 4         |
| 1.3 Pre-operative planning   | 4         |
| 1.4 Surgical approach  | 4         |
| <b>2. REAMING</b>  | <b>5</b>  |
| <b>3. TRIALS</b>   | <b>6</b>  |
| <b>4. IMPACTION OF THE ACETABULAR SHELL</b>  | <b>7</b>  |
| <b>5. PLUG AND SCREW FIXATION (OPTIONS)</b>  | <b>8</b>  |
| <b>6. STABILITY TEST</b>   | <b>9</b>  |
| <b>7. POSITIONING OF THE DEFINITIVE LINER</b>  | <b>10</b> |
| 7.1 Positioning of the definitive UHMWPE liner   | 10        |
| <b>8. REMOVAL AND REVISION PROCEDURE</b>   | <b>11</b> |
| 8.1 Liner removal  | 11        |
| 8.2 Shell and screws removal   | 11        |
| <b>9. MPACT POLYETHYLENE LINER OPTIONS</b>   | <b>12</b> |
| <b>10. INSTRUMENT DETAILS</b>  | <b>13</b> |
| 10.1 Assembling the cup with the cup impactor (ref. 01.32.10.0183)   | 13        |
| 10.2 Disassembling the cup with the cup impactor (ref. 01.32.10.0183)  | 13        |
| 10.3 Assembling the alignment guide (ref. 33.22.0066 and 01.32.10.0072) with cup impactor (ref. 01.32.10.0183) | 14        |
| <b>11. IMPLANTS NOMENCLATURE</b>   | <b>15</b> |

## 1. INTRODUCTION

The Mpact 3D Metal Multi-hole Thin is part of the Mpact product family, an acetabular shell system offering different shell and liner options, ranging from primary to complex revision solutions.



This document describes the Surgical Technique for the Mpact 3D Metal Multi-hole Thin to be used with cancellous bone screws to enhance the primary fixation.

The Mpact 3D Metal Multi-hole Thin shell is available in 7 sizes, from 48 to 60 mm. The shells can be coupled with Highcross UHMWPE liners. It allows the head size  $\varnothing 36$  mm from the shell size  $\varnothing 50$  mm and the head size  $\varnothing 40$  mm from the shell size  $\varnothing 56$  mm.

For more details about other Mpact System acetabular shells please see the dedicated Surgical Techniques.

The Mpact 3D Metal Multi-hole Thin is realized using an additive manufacturing technology. This production method offers a high friction and scratch-fit feel for the initial stability, without the need of any additional coating. Moreover, the high porosity of the 3D Metal structure creates a favourable environment for bone thus providing secondary fixation.

Carefully read the instructions for use and if you have any questions concerning product compatibility please contact your local Medacta representative.

### 1.1 INDICATIONS

The Mpact 3D Metal Multi-hole Thin acetabular shell is designed to be used in total hip arthroplasty, for primary or revision surgery.

Total hip arthroplasty is indicated in the following cases:

- Severely painful and/or disabled joint as a result of arthrosis, traumatic arthritis, rheumatoid polyarthritis, or congenital hip dysplasia.
- Avascular necrosis of the femoral head.
- Acute traumatic fracture of the femoral head or neck.
- Failure of previous hip surgery: joint reconstruction, internal fixation, arthrodesis, partial hip arthroplasty, hip resurfacing replacement, or total hip arthroplasty.

### 1.2 CONTRAINDICATIONS

The Mpact 3D Metal Multi-hole Thin acetabular shell contraindications are the standard contraindications for total hip replacement:

- Acute, systemic or chronic infection.
- Skeletal immaturity.
- Severe muscular, neurological, vascular deficiency or other pathologies of the affected limb that may compromise the function of the implant.
- Bone condition that may compromise the stability of the implant.

Mental or neuromuscular disorders may create an unacceptable risk to the patient and can be a source of postoperative complications.

It is the surgeon's responsibility to ensure that the patient has no known allergy to the materials used.

### 1.3 PRE-OPERATIVE PLANNING

The goal is to determine the optimum acetabular implant size. Using the X-ray templates to the scale of 1.15:1 (with an X-ray of the same magnification) it will be possible to determine:

- The implant size.
- The ideal position for optimal coverage of the metal back.

#### **WARNING**

The Mpact 3D Metal Multi-hole Thin shell cannot be used with the Compression Polyaxial Locking Screws.

#### **WARNING**

The final implant will be selected intra operatively, because of possible discrepancies between actual conditions and templating. The choice will be determined by the size of the final reamer used and the trial cup evaluations.

### 1.4 SURGICAL APPROACH

The surgical approach is up to the surgeon. The instrumentation has been developed for a standard approach. Specific instrumentation for the anterior approach is available on request (for further information see the AMIS dedicated surgical technique).

## 2. REAMING

Following the osteotomy of the femoral neck, expose and prepare the acetabular cavity and remove osteophytes.

Start reaming using the acetabular reamers.



The ideal reaming axis has an inclination of  $40^{\circ}/45^{\circ}$  and an anteversion of  $15^{\circ}/20^{\circ}$  (anteversion recommended for posterior approaches).

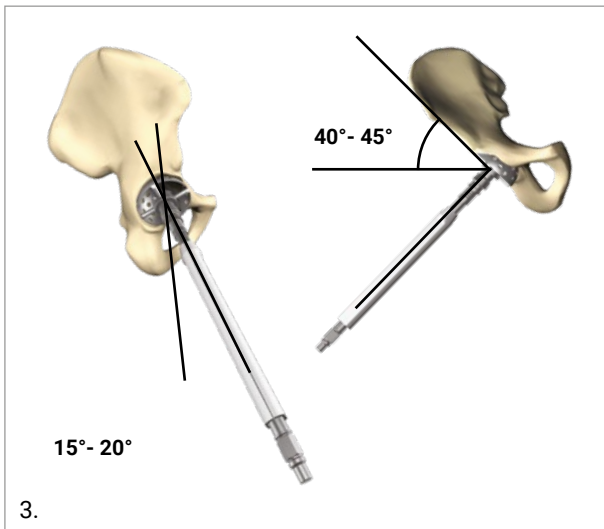

Start reaming the acetabulum progressively, increasing the reamer size until a hemispherical cavity has been obtained and there is presence of bleeding subchondral bone. The preoperative plan can also be used as a reference.

### **WARNING**

During final reaming, avoid changing the reamer axis, in order to avoid making the prepared bed oval, which may affect or prevent the primary seating of the implant.

The size shown on the implant box is the outer diameter of the Mpart shell. For example, a box displaying "52mm shell" contains a shell with an outer diameter of 52mm.

The press-fit should be determined intra-operatively depending on bone quality: the denser the bone, the less press-fit required. In average conditions, an under-reaming of 1 mm should provide an appropriate pressfit of the Mpart acetabular shell.

As a general rule the correct final reamed diameter corresponds to 4 or 6 mm more than the femoral head diameter size. Take care to retain, as much as possible, the bone stock to the level of anterior and posterior columns.

Reamed bone may be used to fill the void between the implant and the acetabulum.

### 3. TRIALS

Trial cups should be used to assess shape and orientation of the cavity. A trial cup of the same diameter of the last reamer (or 1mm smaller in case of odd-size reaming) should be used.

Place the trial cup chosen onto the multifunction handle.

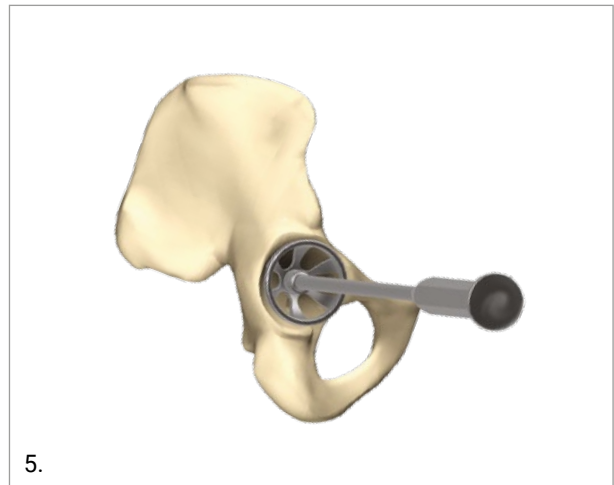
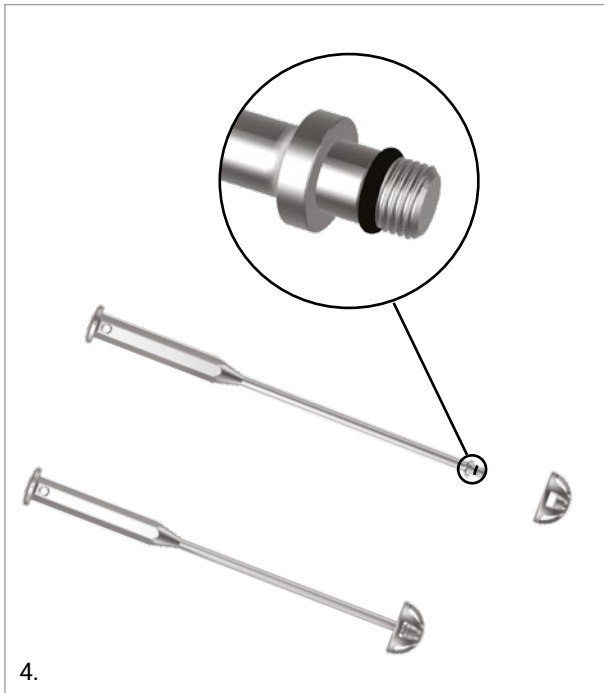

Trial cups:

- Are smooth and have the same dimensions as the even reamers to avoid damaging the socket
- Are the exact size specified.
- Have several openings to permit a direct visualization of the underlying acetabular surface.

#### TIP

As a general rule, soft bone is suitable for a greater press-fit than dense sclerotic bone. Moreover, the bigger the size of the acetabulum, the greater the suitable press-fit.

## 4. IMPACTION OF THE ACETABULAR SHELL

After a satisfactory trial the final acetabular shell can be positioned.

Assemble the impactor handle onto the acetabular shell and ensure it is completely locked to avoid damaging the impactor screw thread during impaction.

### OPTION

The impactor handle (Ref. 01.32.10.0183) is available upon request. For detailed instructions see chapter 10 – INSTRUMENTS DETAILS.

Impact the implant, at the desired angle of orientation, into the prepared acetabulum.

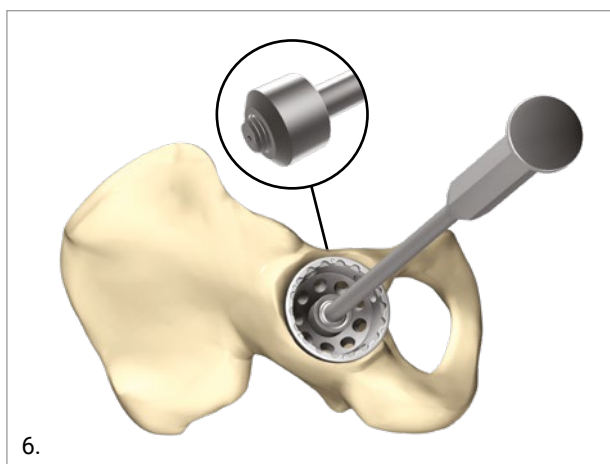

### OPTION

An orientation guide is available to aid in the positioning of the acetabular shell and to establish satisfactory orientation as tested during trials: the orientation guide should be positioned on the top of the impactor handle - the inclination of the anteversion rods is 20° and the inclination rod is 45°.



A mechanical engraving on the rim of the acetabular shell is designed to aid in identifying the screw holes for desired implant position.

Impact the acetabular shell with the aid of a hammer, until it is completely stable.

### CAUTION

Following impaction never use the impactor handle to reposition or rotate the acetabular shell as this may damage the threads. If required, use only the acetabular shell correction impactor, assembled with the multifunction handle.

Remove the handle.

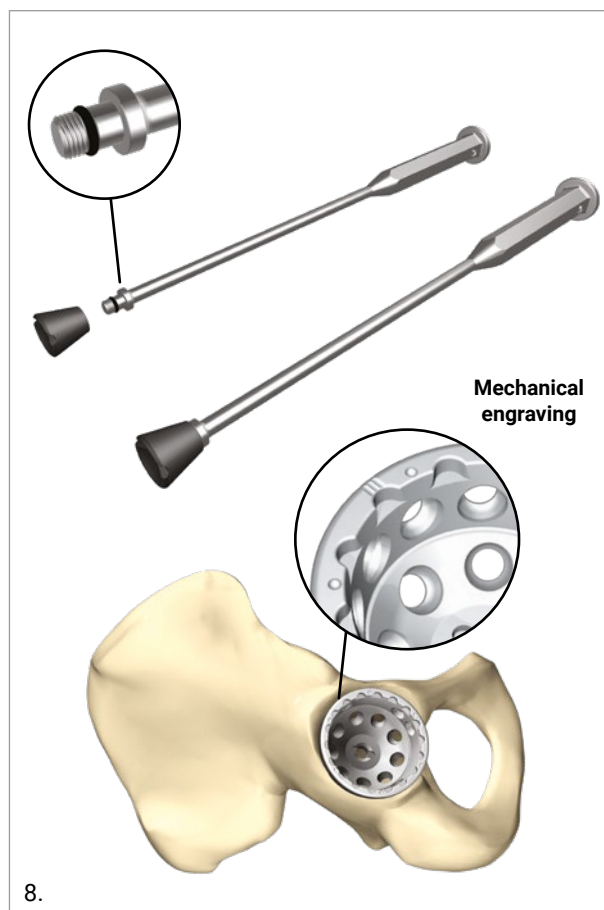

### CAUTION

After impaction of the acetabular shell, ensure osteophytes have been properly removed in order to avoid any impingement.

### TIP

In order to ensure the correct depth of the definitive acetabular shell use the shell holes to see the acetabulum floor.

## 5. PLUG AND SCREW FIXATION (OPTIONS)

The Mpact 3D Metal Multi-hole Thin acetabular shell allows the surgeon to use bone screws to provide additional fixation.

### WARNING

The Mpact 3D Metal Multi-hole Thin shell cannot be used with the Compression Polyaxial Locking Screws.

Screws should be located in the Posterior-Superior acetabular quadrant once final impaction is done, to minimize the potential for neurologic and vascular injury. Additional screw holes are located in the other acetabular quadrants if increased fixation is necessary. Screw placement is at the discretion of the surgeon.

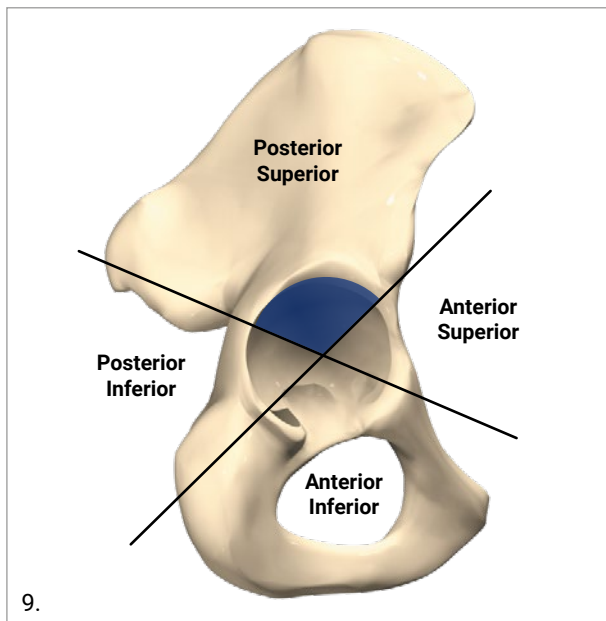

The Mpact Multi-hole Thin allows the surgeon to use cancellous bone screws (with flat head and Ø 6.5 mm), to be placed on the dome of the shell.

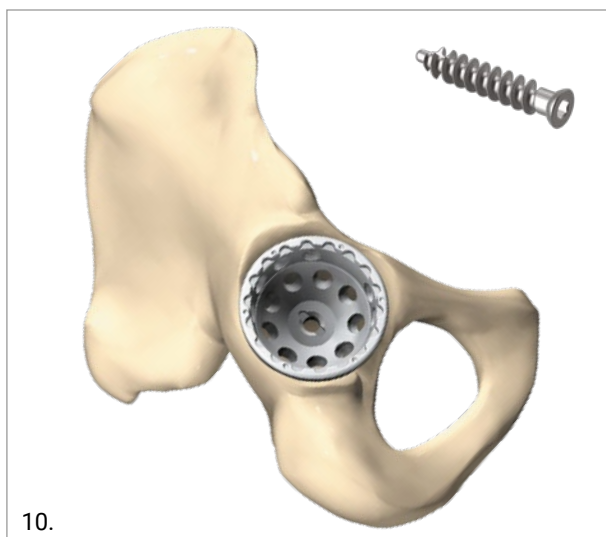

To insert cancellous bone screws, drill through the acetabular shell holes using a Ø 3.2 mm drill bit with the help of a drill guide. If appropriate, a flexible shaft bit driver is available in order to facilitate the drilling procedure.

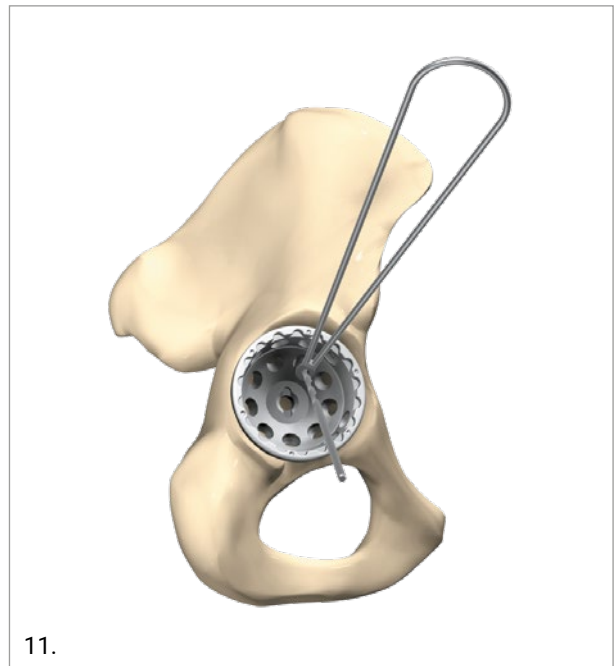

Two different screw versions are available:

- Cancellous Bone Screw Flat Head Ø 6.5 (01.32.6515 - 01.32.6570) offering a wider angular range
- Cancellous Bone Screw Ø 6.5 (01.43.0015 - 01.43.0070) offering higher mechanical resistance

### CAUTION

The Cancellous Bone Screw Ø 6.5 (01.43.0015 - 01.43.0070) requires a dedicated drill guide (01.10.10.372). Color coding has been introduced for easier identification. The dedicated drill guide has a gold colored tip and a gold colored band is present on the screw label.

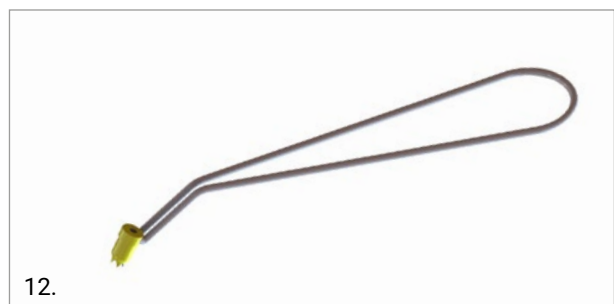

A depth gauge is available in order to measure the drilling depth and select a self-tapping screw of appropriate length.



Screwing is performed with the aid of a 3.5 mm hex-head screwdriver.



### OPTION

The cardan flexible screwdriver (Ref. 01.32.10.0290) is available upon request.

### CAUTION

Always use Medacta flat head screws (see chapter 11 - IMPLANTS NOMENCLATURE) and check that the screws are fully seated (ensure that the screw heads do not protrude from the inner surface of the acetabular shell).

**NOTE:** The central impaction threaded hole may be closed with titanium plug if desired. The titanium plug (ref. 01.31.55TP) is packaged separately from the Mpaact 3D Metal Multi-hole acetabular shell.

## 6. STABILITY TEST

During stability tests, the choice between a flat and a hooded liner can be made according to the surgeon's preference.

Offset and Face-changing liners are also available (see chapter 9 - MPACT POLYETHYLENE LINER OPTIONS).



Clean the interior surface of the acetabular shell.

Assemble the multifunction handle with the trial liner corresponding to the acetabular shell size and femoral head diameter.

Position the assembly gently in the acetabular shell at the desired rotational position taking care to align the anti-rotation tabs with the indentions on the shell.

Unscrew the multifunction handle and reduce the hip in order to test the joint stability and limb length.

After checking and testing mobility, joint stability and lower limb length, remove the trial liner with the aid of the multifunction handle.

### TIP

If using a hooded trial liner, use electrocautery to mark the satisfactory position of the hood.

### WARNING

Stability tests must be performed with trial heads and not with definitive heads. The head sizes XL (for Ø28 mm, Ø32 mm) and XXL (for Ø28 mm, Ø32 mm, Ø36 mm, Ø40 mm) have a collar which may decrease the Range of Motion in comparison to smaller sizes. Always perform trial reduction with the chosen head size.

### WARNING

The internal sleeves of the Mectacer Biolox Option 28 heads size XL may not completely cover the 12/14 EuroCone taper. This may cause slight increase in wear of the liner.

## 7. POSITIONING OF THE DEFINITIVE LINER

The external diameter of the liner will be the same as the internal diameter of the acetabular shell implanted following the letter code; the internal diameter of the liner will be the same as the head chosen.

Before inserting the liner, clean the interior surface of the acetabular shell, carefully remove any bone debris and tissue residues to avoid damaging the mechanical bearing.

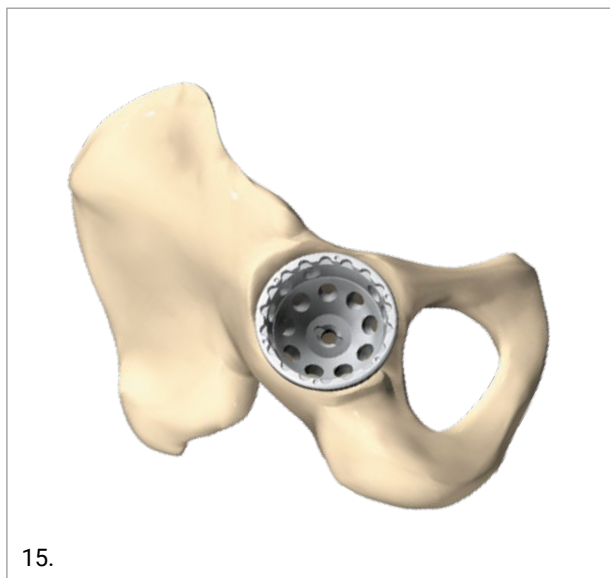

### 7.1 POSITIONING OF THE DEFINITIVE UHMWPE LINER

Place carefully by hand the UHMWPE liner in the acetabular shell along its axis taking care to align the anti-rotation tabs with the indentions on the shell.

Ensure the hooded liner is positioned in the correct location, as determined by the trial.

Check that the liner has been positioned correctly.

Once the liner is in the correct position, secure it by pushing it in with your thumb.

To perform the final impaction, assemble the impaction sphere (of the correct liner) onto the multifunction straight impactor.

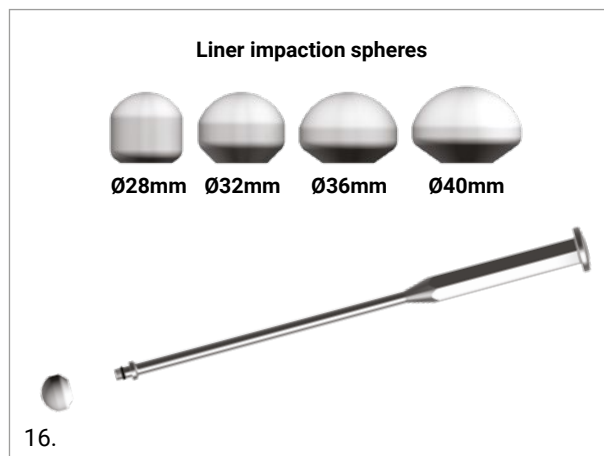

Insert the sphere into the UHMWPE liner and impact it using a hammer, until completely fixed. Remove the multifunction hammer with the liner impaction sphere.

#### **WARNING**

Impaction should follow the "axis" of the cup, i.e. should be in a direction perpendicular to the plane of equator. In order to do so, the offset AMIS impactor may facilitate negotiating soft tissues when an AMIS approach is being performed.

#### **TIP**

In order to ensure the correct placement of flat liners and the flat part of the hooded liner check that the outside rim of the acetabular shell is exactly aligned with the outside rim of the liner with the tabs in the corresponding indentions.

Position the definitive head and reduce the hip.

#### **OPTION**

Metallic impaction washers (for each liner size), to impact the UHMWPE liners, are available upon request for use with the multifunction handle. Also available upon request is a washer release key to unlock the impaction washer from the multifunction handle.

## 8. REMOVAL AND REVISION PROCEDURE

This chapter provides some options if removal of the Mpace component is required.

### 8.1 LINER REMOVAL

If a liner must be removed from the Mpace shell we recommend using the Bone screw method:

- Locate the 3.2 mm drill bit and drill a hole into the dome of the liner avoiding the shell hole areas
- Use a cancellous bone screw and insert it inside the hole. Drive the screw by hand until the liner is lifted out of the shell

#### **WARNING**

While removing the liner, take care to avoid damaging the shell taper or its locking mechanism.

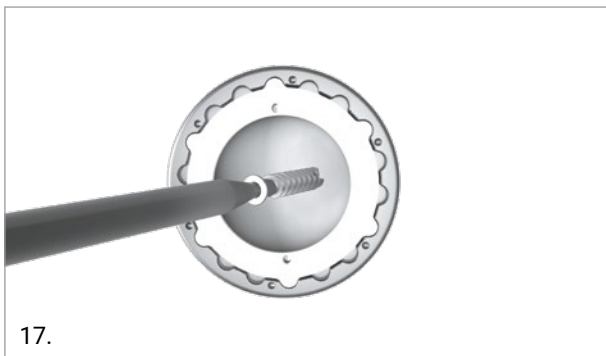

### 8.2 SHELL AND SCREWS REMOVAL

The Mpace instruments can be used for the removal of the acetabular shell and screws.

To remove the cancellous bone screws you can use the ratchet handle together with the screwdriver to unscrew them.



If the acetabular shell is loose you can use the impactor handle to remove it.



For well fixed acetabular shells you should use specific revision instrumentation, available on request.

## 9. MPACT POLYETHYLENE LINER OPTIONS

Within the MPACT Acetabular System, a variety of liner designs are available:

- Flat liner offers concentric inner and outer spheres and maximum ROM
- Hooded liner offers additional head coverage in a specific, limited area
- + 4mm Offset liner lateralizes and distalizes the centre of rotation by 4 mm along the cup axis
- + 10° Face-Changing liner modifies anteversion and inclination. The preferred anteversion and inclination can be achieved by rotating the liner in the shell taking care to align the antirotation tabs with the indentations on the shell. The centre of rotation is lateralized and distalized along the cup axis by the distance shown in the table below

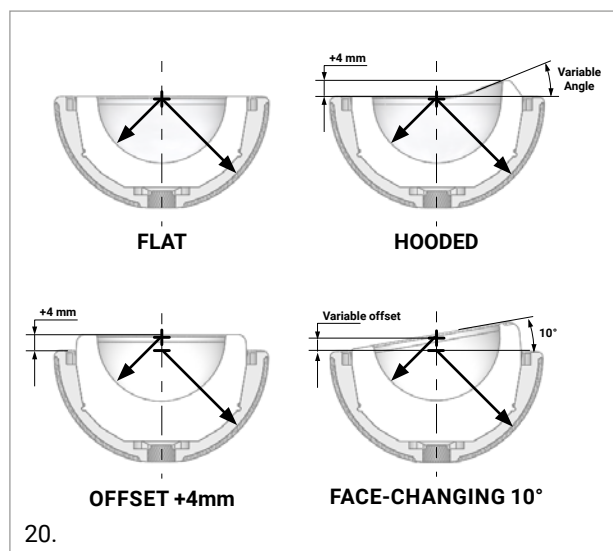

In the hooded liners, the hood makes an angle which is size dependant:

| LINER SIZE | HEAD | ANGLE |
|------------|------|-------|
| B          | 22   | 16    |
|            | 28   | 20    |
| C          | 22   | 16    |
|            | 28   | 20    |
|            | 32   | 20    |
| D          | 22   | 16    |
|            | 28   | 19    |
|            | 32   | 20    |
| E          | 22   | 16    |
|            | 28   | 20    |
|            | 32   | 20    |
|            | 36   | 20    |
| F          | 22   | 16    |
|            | 28   | 20    |
|            | 32   | 20    |
|            | 36   | 20    |
| G          | 22   | 16    |
|            | 28   | 20    |
|            | 32   | 20    |
|            | 36   | 20    |
| J          | 22   | 16    |
|            | 28   | 20    |
|            | 32   | 20    |
|            | 36   | 20    |
| K          | 22   | 20    |
|            | 28   | 20    |
|            | 32   | 20    |
|            | 36   | 20    |

In the face changing liners, the position of the centre of rotation is offset from the neutral position by the distance listed below (size dependant):

| FACE-CHANGING LINER SIZE | OFFSET (mm) |
|--------------------------|-------------|
| B                        | 4           |
| C                        | 4           |
| D                        | 4           |
| E                        | 4.5         |
| F                        | 4.5         |
| G                        | 5           |
| J                        | 5.5         |
| K                        | 6           |

Each design has specific benefits. The choice of the correct liner is at the discretion of the surgeon.

For each design, dedicated trial liners are available to perform the stability test properly. The positioning of the definitive liners is equal for all designs. In the face changing liners, the multifunction handle must be aligned with the cup axis.

## 10. INSTRUMENT DETAILS

### 10.1 ASSEMBLING THE CUP WITH THE CUP IMPACTOR (REF. 01.32.10.0183)

**Step 1:** Remove the anvil from the handle by pushing the button.



**Step 2:** Position the tip of the cup impactor in the acetabular shell taking care to align the teeth of the impactor with the dedicated sockets near the central hole of the acetabular shell. Screw the central hole of the cup impactor by hand until fully tightened.

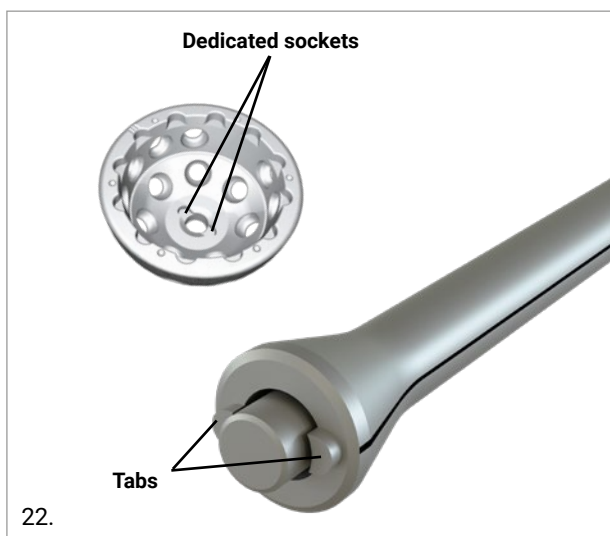

#### TIP

The black line on the distal shaft of the handle indicates the position of the tabs. Aligning the black line on the handle with the mechanical engravings on the shell will align the tabs to the socket.

**NOTE:** Do not over tighten.



**Step 3:** Assemble the anvil and screw it until fully tightened.



**NOTE:** Do not impact on the central rod, but always impact on the anvil.

### 10.2 DISASSEMBLING THE CUP WITH THE CUP IMPACTOR (REF. 01.32.10.0183)

Unscrew the anvil from the impactor handle to release.



**10.3 ASSEMBLING THE ALIGNMENT GUIDE (REF. 33.22.0066 AND 01.32.10.0072) WITH CUP IMPACTOR (REF. 01.32.10.0183)**

**Step 1:** Screw the inclination rod and the anteversion rod onto the alignment guide.



**Step 2:** Assemble the alignment guide onto the cup impactor.

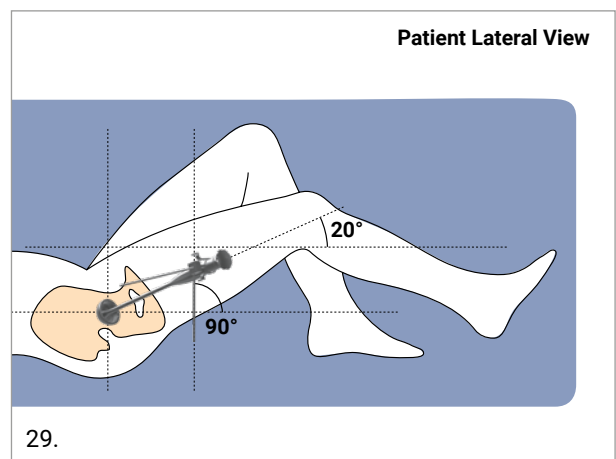
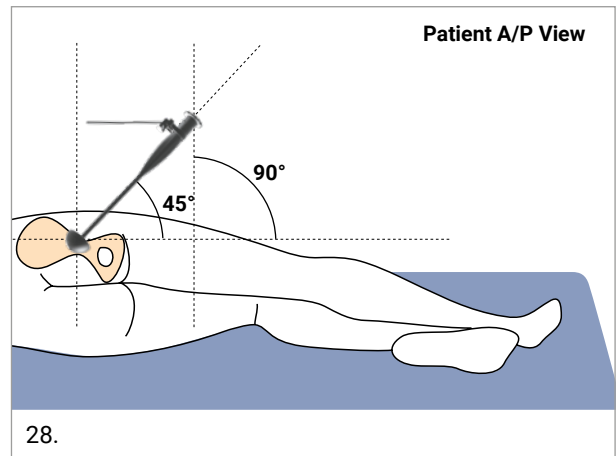
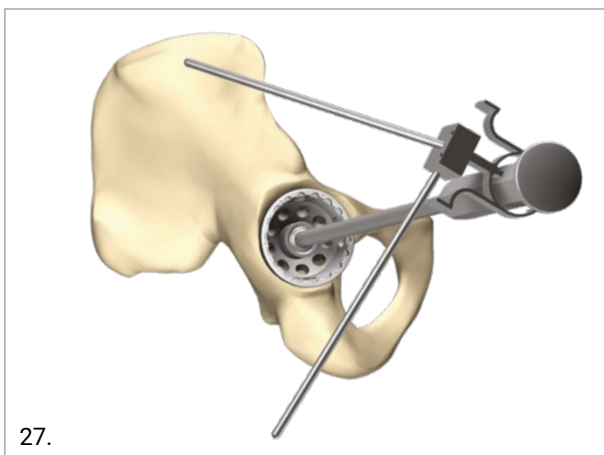

Example of use in decubitus lateralis

## 11. IMPLANTS NOMENCLATURE

### MPACT 3D METAL ACETABULAR SHELL MULTI-HOLE THIN

| DIAMETER (mm) | REF.        | LINER SIZE |
|---------------|-------------|------------|
| 48            | 01.38.348MH | C          |
| 50            | 01.38.350MH | D          |
| 52            | 01.38.352MH | E          |
| 54            | 01.38.354MH | E          |
| 56            | 01.38.356MH | F          |
| 58            | 01.38.358MH | F          |
| 60            | 01.38.360MH | G          |

### CANCELLOUS BONE SCREWS (Ø 6.5 mm)\*

| LENGTH (mm) | REF.        |
|-------------|-------------|
| 15          | 01.43.0015  |
| 20          | 01.43.0020  |
| 25          | 01.43.0025  |
| 30          | 01.43.0030  |
| 35          | 01.43.0035  |
| 40          | 01.43.0040  |
| 45          | 01.43.0045  |
| 50          | 01.43.0050' |
| 55          | 01.43.0055' |
| 60          | 01.43.0060' |
| 65          | 01.43.0065' |
| 70          | 01.43.0070' |

### CANCELLOUS BONE SCREWS (FLAT HEAD - Ø 6.5mm)\*

| LENGTH (mm) | REF.        |
|-------------|-------------|
| 15          | 01.32.6515  |
| 20          | 01.32.6520  |
| 25          | 01.32.6525  |
| 30          | 01.32.6530  |
| 35          | 01.32.6535  |
| 40          | 01.32.6540  |
| 45          | 01.32.6545  |
| 50          | 01.32.6550' |
| 55          | 01.32.6555' |
| 60          | 01.32.6560' |
| 65          | 01.32.6565' |
| 70          | 01.32.6570' |

### MPACT ACETABULAR SHELL CENTRAL SCREW PLUG

| DESCRIPTION | REF.       |
|-------------|------------|
| Plug        | 01.31.55TP |

' On demand

\* For further details, please see page 8

**HIGHCROSS UHMWPE FLAT LINER**

| LINER SIZE | HEAD Ø 22 mm   | HEAD Ø 28 mm   | HEAD Ø 32 mm   | HEAD Ø 36 mm   | HEAD Ø 40 mm   |
|------------|----------------|----------------|----------------|----------------|----------------|
| B          | 01.32.2237HCT' | 01.32.2837HCT  | 01.32.3237HCT  | -              | -              |
| C          | 01.32.2239HCT' | 01.32.2839HCT  | 01.32.3239HCT  | -              | -              |
| D          | 01.32.2241HCT' | 01.32.2841HCT  | 01.32.3241HCT  | 01.32.3641HCT  | -              |
| E          | 01.32.2244HCT' | 01.32.2844HCT  | 01.32.3244HCT  | 01.32.3644HCT  | -              |
| F          | 01.32.2248HCT' | 01.32.2848HCT' | 01.32.3248HCT  | 01.32.3648HCT  | 01.32.4048HCT  |
| G          | 01.32.2252HCT' | 01.32.2852HCT' | 01.32.3252HCT  | 01.32.3652HCT  | 01.32.4052HCT  |
| J          | 01.32.2256HCT' | 01.32.2856HCT' | 01.32.3256HCT  | 01.32.3656HCT  | 01.32.4056HCT  |
| K          | 01.32.2260HCT' | 01.32.2860HCT' | 01.32.3260HCT' | 01.32.3660HCT' | 01.32.4060HCT' |

**HIGHCROSS UHMWPE HOODED LINER**

| LINER SIZE | HEAD Ø 22 mm    | HEAD Ø 28 mm    | HEAD Ø 32 mm    | HEAD Ø 36 mm    |
|------------|-----------------|-----------------|-----------------|-----------------|
| B          | 01.32.2237HCAT' | 01.32.2837HCAT  | -               | -               |
| C          | 01.32.2239HCAT' | 01.32.2839HCAT  | 01.32.3239HCAT  | -               |
| D          | 01.32.2241HCAT' | 01.32.2841HCAT  | 01.32.3241HCAT  | -               |
| E          | 01.32.2244HCAT' | 01.32.2844HCAT  | 01.32.3244HCAT  | 01.32.3644HCAT  |
| F          | 01.32.2248HCAT' | 01.32.2848HCAT' | 01.32.3248HCAT  | 01.32.3648HCAT  |
| G          | 01.32.2252HCAT' | 01.32.2852HCAT' | 01.32.3252HCAT  | 01.32.3652HCAT  |
| J          | 01.32.2256HCAT' | 01.32.2856HCAT' | 01.32.3256HCAT  | 01.32.3656HCAT  |
| K          | 01.32.2260HCAT' | 01.32.2860HCAT' | 01.32.3260HCAT' | 01.32.3660HCAT' |

' On demand

**HIGHCROSS UHMWPE OFFSET LINERS 4 mm - ON DEMAND**

| LINER SIZE | HEAD Ø 22 mm   | HEAD Ø 28 mm   | HEAD Ø 32 mm   | HEAD Ø 36 mm  | HEAD Ø 40 mm  |
|------------|----------------|----------------|----------------|---------------|---------------|
| B          | 01.32.2237HC4" | 01.32.2837HC4  | -              | -             | -             |
| C          | 01.32.2239HC4" | 01.32.2839HC4  | 01.32.3239HC4  | -             | -             |
| D          | 01.32.2241HC4" | 01.32.2841HC4" | 01.32.3241HC4  | 01.32.3641HC4 | -             |
| E          | 01.32.2244HC4" | 01.32.2844HC4" | 01.32.3244HC4  | 01.32.3644HC4 | -             |
| F          | 01.32.2248HC4" | 01.32.2848HC4" | 01.32.3248HC4" | 01.32.3648HC4 | 01.32.4048HC4 |
| G          | 01.32.2252HC4" | 01.32.2852HC4" | 01.32.3252HC4" | 01.32.3652HC4 | 01.32.4052HC4 |
| J          | 01.32.2256HC4" | 01.32.2856HC4" | 01.32.3256HC4" | 01.32.3656HC4 | 01.32.4056HC4 |
| K          | 01.32.2260HC4" | 01.32.2860HC4" | 01.32.3260HC4" | 01.32.3660HC4 | 01.32.4060HC4 |

**HIGHCROSS UHMWPE FACE-CHANGING LINERS 10° - ON DEMAND**

| LINER SIZE | HEAD Ø 22 mm     | HEAD Ø 28 mm     | HEAD Ø 32 mm     | HEAD Ø 36 mm    | HEAD Ø 40 mm    |
|------------|------------------|------------------|------------------|-----------------|-----------------|
| B          | 01.32.2237HC10A" | 01.32.2837HC10A  | -                | -               | -               |
| C          | 01.32.2239HC10A" | 01.32.2839HC10A  | 01.32.3239HC10A  | -               | -               |
| D          | 01.32.2241HC10A" | 01.32.2841HC10A  | 01.32.3241HC10A  | -               | -               |
| E          | 01.32.2244HC10A" | 01.32.2844HC10A" | 01.32.3244HC10A  | 01.32.3644HC10A | -               |
| F          | 01.32.2248HC10A" | 01.32.2848HC10A" | 01.32.3248HC10A" | 01.32.3648HC10A | 01.32.4048HC10A |
| G          | 01.32.2252HC10A" | 01.32.2852HC10A" | 01.32.3252HC10A" | 01.32.3652HC10A | 01.32.4052HC10A |
| J          | 01.32.2256HC10A" | 01.32.2856HC10A" | 01.32.3256HC10A" | 01.32.3656HC10A | 01.32.4056HC10A |
| K          | 01.32.2260HC10A" | 01.32.2860HC10A" | 01.32.3260HC10A" | 01.32.3660HC10A | 01.32.4060HC10A |

" Availability upon approved special request only







Part numbers subject to change.

## **NOTE FOR STERILIZATION**

The instrumentation is not sterile upon delivery. It must be cleaned before use and sterilized in an autoclave in accordance with the regulations of the country, EU directives where applicable and following the instructions for use of the autoclave manufacturer. For detailed instructions please refer to the document "Recommendations for cleaning decontamination and sterilisation of Medacta International orthopaedic devices" available at [www.medacta.com](http://www.medacta.com).



---

**REDEFINING BETTER  
IN ORTHOPAEDICS  
AND SPINE SURGERY**

---

MEDACTA.COM



**Medacta International SA**  
Strada Regina, 34 - 6874 Castel San Pietro - Switzerland  
Phone +41 91 696 60 60 - Fax +41 91 696 60 66  
info@medacta.ch

Find your local dealer at: [medacta.com/locations](https://medacta.com/locations)

All trademarks are property of their respective owners and are registered at least in Switzerland.  
This document is not intended for the US market.  
Please verify approval of the devices described in this document with your local Medacta representative.  
Not all products are currently available/standard in all countries.

Mpact® 3D Metal Multi-hole Thin  
Surgical Technique

ref: 99.70R3DT.12  
rev. 01

Last update: July 2022  
**CE 0476**