



TEST REPORT

Test Report No.: 801441-01/02

Issued: 27. 7. 2018

Name of product: Fixed general purpose luminaires, street lighting
Type of product: URBINO PREMIUM LED variants: class I
130252.6L14X.0X1 (99 W, Ta +55°C, IP 66, IK 09)
130252.6L17X.0X1 (128 W, Ta +40°C, IP 66, IK 09)
130252.6L20X.0X1 (157 W, Ta +35°C, IP 66, IK 09)
Ratings: 220-240 V, 50/60 Hz
Serial number: -
Manufacturer: LUG Light Factory Sp. z o.o.
ul. Gorzowska 11, 65-127 Zielona Góra,
the Republic of Poland
Production site: LUG Light Factory Sp. z o.o., ul. Gorzowska 11, 65-127
Zielona Góra, Poland
Ordering firm: LUG Light Factory Sp. z o.o.
ul. Gorzowska 11, 65-127 Zielona Góra,
the Republic of Poland
Number of tested samples: 1
Samples submitted on: 4. 7. 2018
Location of testing: Elektrotechnický zkušební ústav, s. p.
Tests performed from 17. 7. 2018 through 24. 7. 2018
Other data: Type representative: 130252.6L201.031
Tested according to: ČSN EN 55015 ed. 4:14 (idt EN 55015:13)
ČSN EN 61547 ed. 2:10 (idt EN 61547:09)
ČSN EN 61000-3-3 ed. 3:14 (idt EN 61000-3-3:13)
ČSN EN 61000-3-2 ed. 4:15 (idt EN 61000-3-2:14)

Compiled by: David Nádherný



Approved by: Miroslav Vondra
Testing laboratory technical manager

No. of pages: 34

No. of annexes: 0

No. of annexes pages: 0

Test results stated in the test report apply only to the tested subject and unless specified otherwise in the test report, the tests were performed using the method and under the conditions determined in the test regulations, technical norm, instructions for use and information provided by the manufacturer on the tested subject and using accessories required by the manufacturer.
Without written consent of Elektrotechnický zkušební ústav, s. p., this report must not be reproduced in any other way than as a whole.

1. Emission

- EN 55015:2013 *Limits and methods of measurement of radio disturbance characteristics of electrical lighting and similar equipment*
- EN 61000-3-2:2014 *Electromagnetic compatibility (EMC) - Limits - Limits for harmonic current emission*
- EN 61000-3-3:2013 *Electromagnetic compatibility (EMC) - Part 3-3: Limits - Limitation of voltage changes, voltage fluctuations and flicker in public low-voltage supply systems, for equipment with rated current $\leq 16A$ per phase and not subject to conditional connection*

Product: Fixed general purpose luminaires, street lighting

Type: URBINO PREMIUM LED (variants: class I)

Type representative: 130252.6L201.031

Requirements at tests:

Standard	Frequency band	Allowed values	Note
EN 55015 Art. 4.3.3	f [MHz] 0.15 - 0.5 0.05 - 30	QP / AV [dB(μ V)] 84 - 74 / 74 - 64 74 / 64	Pass
EN 55015 Art. 4.3.1	f [MHz] 0.009 - 0.05 0.05 - 0.15 0.15 - 0.5 0.5 - 5 5 - 30	QP / AV [dB(μ V)] 110 / --- 90-80 / --- 66-56 / 56-46 56 / 46 60 / 50	Pass
EN 55015 Art. 4.4.1 (d=2m)	f [MHz] 0.009 - 0.07 0.07 - 0.15 0.15 - 3 3 - 30	QP [dB(μ A)] 88 88-58 58-22 22	Pass
EN 55015 Art. 4.4.2	f [MHz] 30 - 230 230 - 300	QP [dB(μ V/m)] 30 d=10m 37	Pass
EN 61000-3-2 Art. 7.3	0 - 2 kHz	Class C	Pass
EN 61000-3-3	50 Hz	---	Not applicable *1)

Notes:

The results of the tests specified in the protocol relating to device with electronic ballasts:
130252.6L201.031: TRIDONIC LCA 160W 350-1050mA one4all C PRE OTD

*1) According to EN 61000-3-3, Art. A2 (LED luminaires with power input $\leq 200W$)

Test result: Pass

Compiled by: Nádherný

Measured at: Elektrotechnický zkušební ústav, s.p.

*Measurement of interference voltages introduced into the mains
According to: EN 55015 art. 4.3.1*

Product: Fixed general purpose luminaires, street lighting

Type: URBINO PREMIUM LED (variants: class I)

Operating conditions:

230V, 50Hz, minimally 15 minutes in operation

Temperature: 24°C Rel. humidity: 35 – 45 %

Applied limits:

Pásmo - Band	Limits dB(μV), quasi-peak/average
9kHz - 50kHz	110 /--
50kHz - 150kHz	90 - 80 /--
150kHz - 0,5MHz	66 - 56 / 56 - 46
0,5MHz - 5,0MHz	56 / 46
5,0MHz - 30MHz	60 / 50

Measuring arrangement:

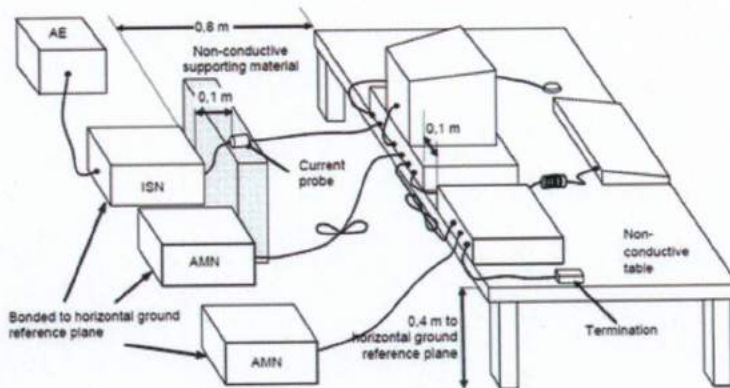

Notes:

For measured values see next pages

Test result: Pass

Measured by: Nádherný Date: 17. 7. 2018

Measured at: Elektrotechnický zkušební ústav, s.p.

EMI Measurement

Common Information

EUT Name: Fixed general purpose luminaires, street lighting
 Type: URBINO PREMIUM LED (130252.6L201.031)
 Test Description: EN 55015
 Operating Conditions: 230V, 50Hz, Pmax
 Operator Name: Nadherny
 Comment: Mains L, N

Voltage EN 55015tab2a

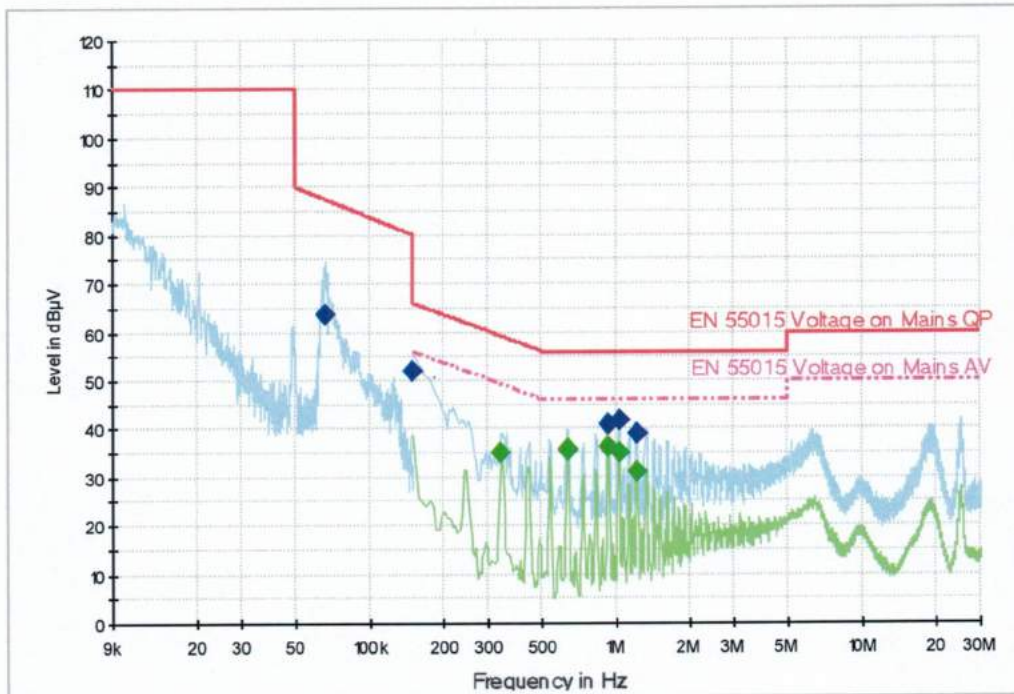

Final Result 1

Frequency (MHz)	QuasiPeak (dBµV)	Meas. Time (ms)	Bandwidth (kHz)	PE	Line	Corr. (dB)	Margin (dB)	Limit (dBµV)
0.066020	63.6	1000.0	0.200	GN	N	10.3	23.9	87.5
0.150000	52.0	1000.0	9.000	GN	L1	10.3	14.0	66.0
0.150000	51.8	1000.0	9.000	GN	L1	10.3	14.2	66.0
0.925500	40.9	1000.0	9.000	GN	L1	10.4	15.1	56.0
1.033500	41.6	1000.0	9.000	GN	L1	10.4	14.4	56.0
1.210500	38.9	1000.0	9.000	GN	L1	10.5	17.1	56.0

Final Result 2

Frequency (MHz)	Average (dBµV)	Meas. Time (ms)	Bandwidth (kHz)	PE	Line	Corr. (dB)	Margin (dB)	Limit (dBµV)
0.341500	35.0	1000.0	9.000	GN	L1	10.3	14.2	49.2
0.637500	35.3	1000.0	9.000	GN	L1	10.4	10.7	46.0
0.637500	35.9	1000.0	9.000	GN	N	10.4	10.1	46.0
0.934500	36.2	1000.0	9.000	GN	N	10.4	9.8	46.0
1.033500	34.9	1000.0	9.000	GN	L1	10.4	11.1	46.0
1.214500	31.2	1000.0	9.000	GN	L1	10.5	14.8	46.0

EMI Measurement

Common Information

EUT Name: Fixed general purpose luminaire, street lighting
 Type: URBINO PREMIUM LED (130252.6L201.031)
 Test Description: EN 55015
 Operating Conditions: 230V, 50Hz, Pmin
 Operator Name: Nadherny
 Comment: Mains L, N

Vo Itage EN 55015tab2a

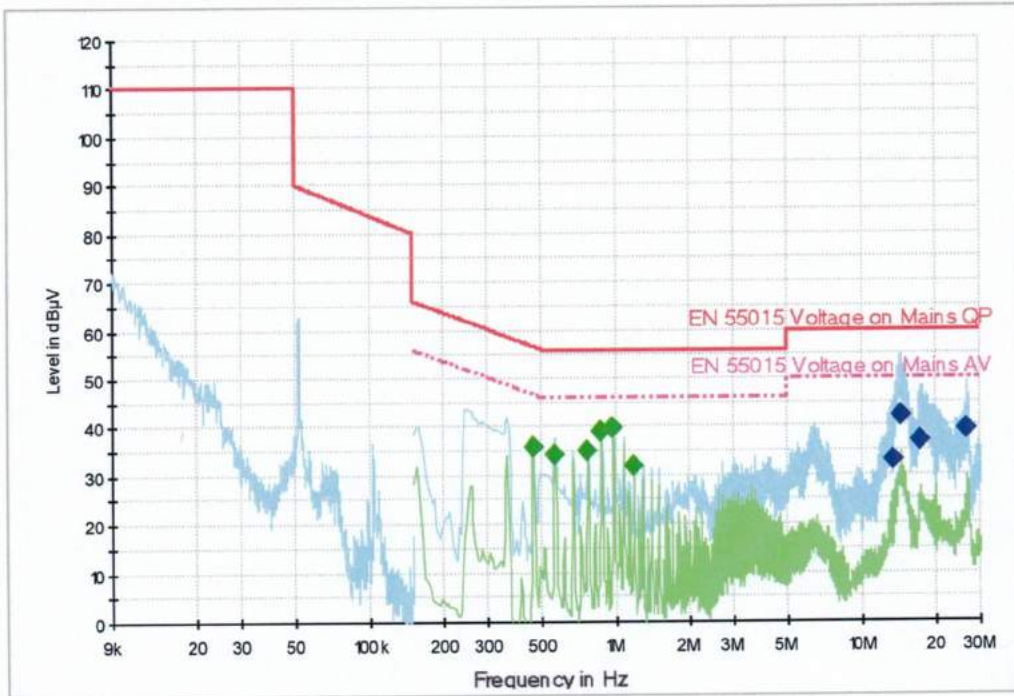

Final Result 1

Frequency (MHz)	QuasiPeak (dBµV)	Meas. Time (ms)	Bandwidth (kHz)	PE	Line	Corr. (dB)	Margin (dB)	Limit (dBµV)
0.869500	39.1	1000.0	9.000	GN	N	10.4	16.9	56.0
0.973500	39.9	1000.0	9.000	GN	N	10.4	16.1	56.0
13.330500	33.0	1000.0	9.000	GN	L1	11.6	27.0	60.0
14.333500	42.0	1000.0	9.000	GN	L1	11.7	18.0	60.0
17.273500	37.0	1000.0	9.000	GN	L1	11.9	23.0	60.0
26.645500	39.2	1000.0	9.000	GN	L1	12.5	20.8	60.0

Final Result 2

Frequency (MHz)	Average (dBµV)	Meas. Time (ms)	Bandwidth (kHz)	PE	Line	Corr. (dB)	Margin (dB)	Limit (dBµV)
0.461500	35.7	1000.0	9.000	GN	N	10.3	11.0	46.7
0.561500	34.4	1000.0	9.000	GN	L1	10.4	11.6	46.0
0.769500	35.1	1000.0	9.000	GN	N	10.4	10.9	46.0
0.869500	38.9	1000.0	9.000	GN	N	10.4	7.1	46.0
0.973500	39.8	1000.0	9.000	GN	N	10.4	6.2	46.0
1.177500	31.7	1000.0	9.000	GN	N	10.5	14.3	46.0

Measurement of interference voltages on the control terminals
According to: EN 55015 art. 4.3.3

Product: Fixed general purpose luminaires, street lighting

Type: URBINO PREMIUM LED (variants: class I)

Operating conditions:

230V, 50Hz, minimally 15 minutes in operation

Temperature: 24°C Rel. humidity: 35 – 45 %

Applied limits:

Band	Limits dB(μV), quasi-peak/average
150kHz - 0,5MHz	84 - 74 / 74 - 64
0,5MHz - 30,0MHz	74 / 64

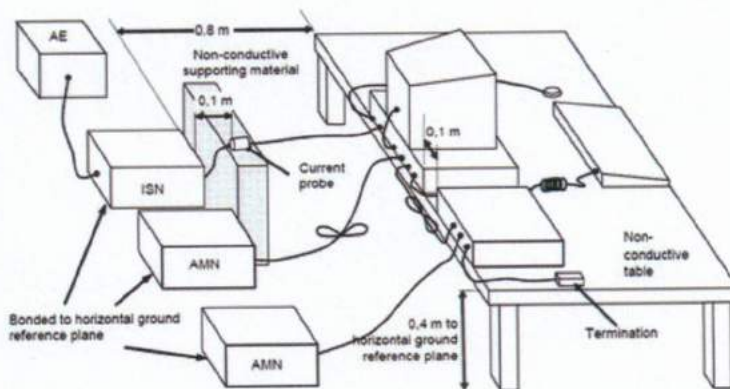

Notes:

For measured values see next pages.

Test result: Pass

Measured by: Nádherný Date: 17. 7. 2018

Measured at: Elektrotechnický zkušební ústav, s.p.

EMI Measurement

Common Information

EUT Name:	Fixed general purpose luminaires, street lighting
Type	URBINO PREMIUM LED (130252.6L201.031)
Test Description	EN 55015
Operating Conditions	230V, 50Hz, Pmax
Operator Name:	Nadhery
Comment:	DALI terminals

EN 55022 VoltageA EMC O

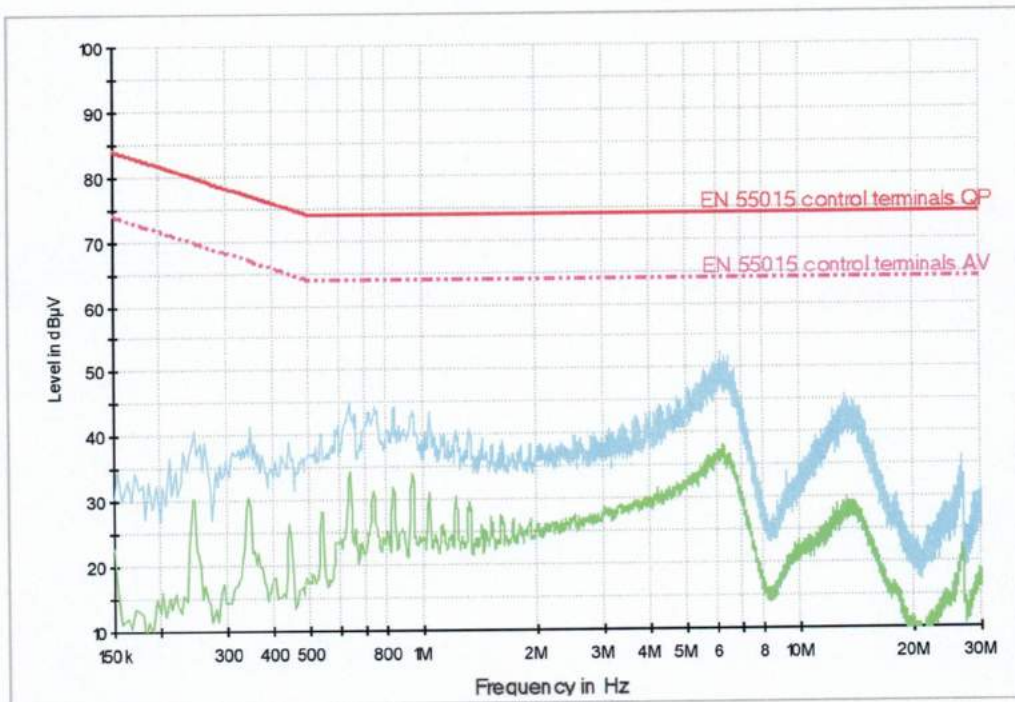

EMI Measurement

Common Information

EUT Name: Fixed general purpose luminaires, street lighting
 Type: URBINO PREMIUM LED (130252.6L201.031)
 Test Description: EN 55015
 Operating Conditions: 230V, 50Hz, Pmin
 Operator Name: Nadherny
 Comment: DALI terminals

EN 55022 Volt ageA EMC O

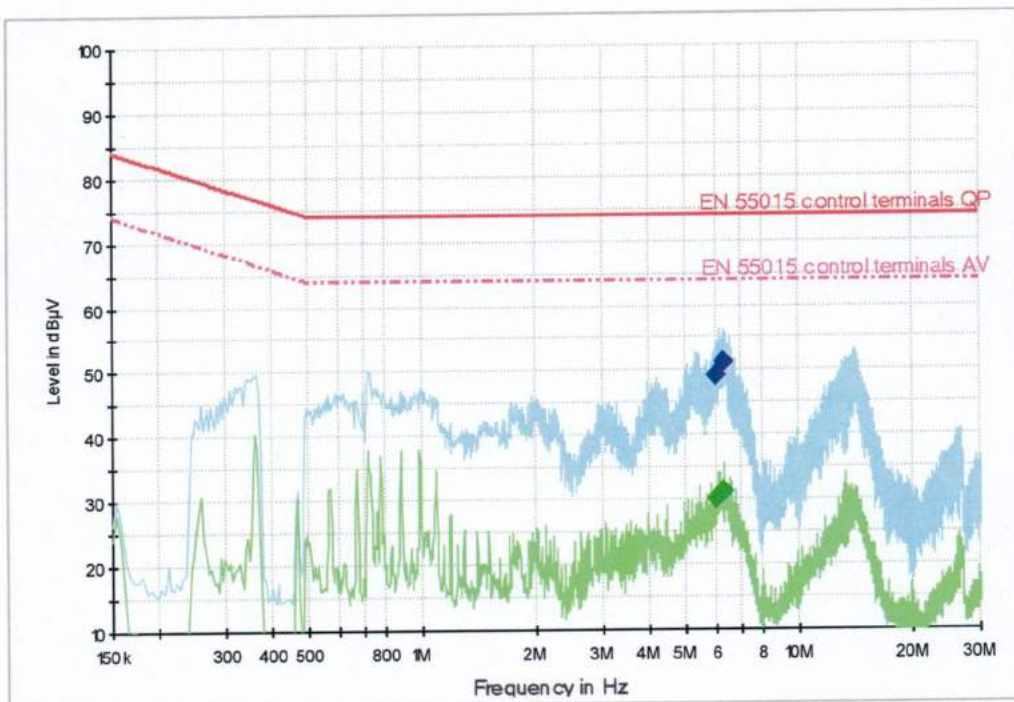

Final Result 1

Frequency (MHz)	QuasiPeak (dBµV)	Meas. Time (ms)	Bandwidth (kHz)	PE	Line	Corr. (dB)	Margin (dB)	Limit (dBµV)	Comment
6.026000	49.4	1000.0	9.000	FL	N	10.5	24.6	74.0	
6.278000	51.3	1000.0	9.000	FL	N	10.5	22.7	74.0	

Final Result 2

Frequency (MHz)	Average (dBµV)	Meas. Time (ms)	Bandwidth (kHz)	PE	Line	Corr. (dB)	Margin (dB)	Limit (dBµV)	Comment
6.026000	30.1	1000.0	9.000	FL	N	10.5	33.9	64.0	
6.278000	31.3	1000.0	9.000	FL	N	10.5	32.7	64.0	

**Measurement of interfering radiation in the 9 kHz - 30 MHz band
According to: EN 55015 art 4.4.1**

Product: Fixed general purpose luminaires, street lifting
Type: URBINO PREMIUM LED (variants: class I)

Operating conditions:
230V, 50Hz, minimally 15 minutes in operation
Temperature: 25°C Rel. humidity: 35 – 45 %

Applied limits:

Band	Limits dB(μA), quasi-peak
9 - 70 kHz	88
70 - 150 kHz	88 - 58
150 kHz - 3 MHz	58 - 22
3 - 30 MHz	22

Measuring arrangement:

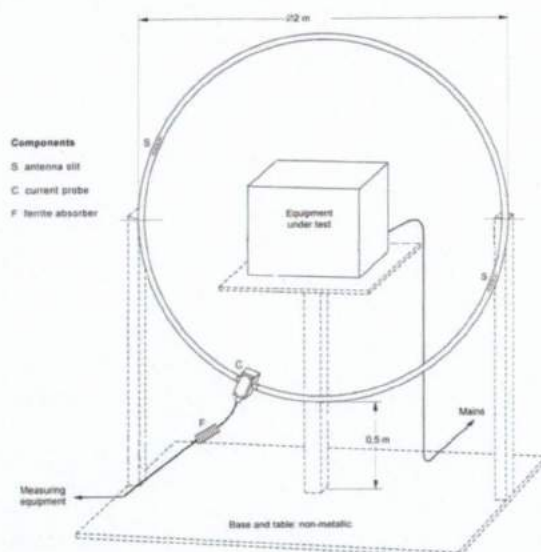

Notes:

For measured values see next page – the worst case is introduced.

Test result: Pass

Measured by: Nádherný Date: 20. 7. 2018

Measured at: Elektrotechnický zkušební ústav, s.p.

EMI Measurement

Common Information

EUT Name:	Fixed general purpose luminaires, street lighting
Type	URBINO PREMIUM LED (130252.6L201.031)
Test Description	EN 55015
Operating Conditions	230V, 50Hz
Operator Name:	Nadhery
Comment:	Axis X

EFS with Scans EZU KRUH2M2

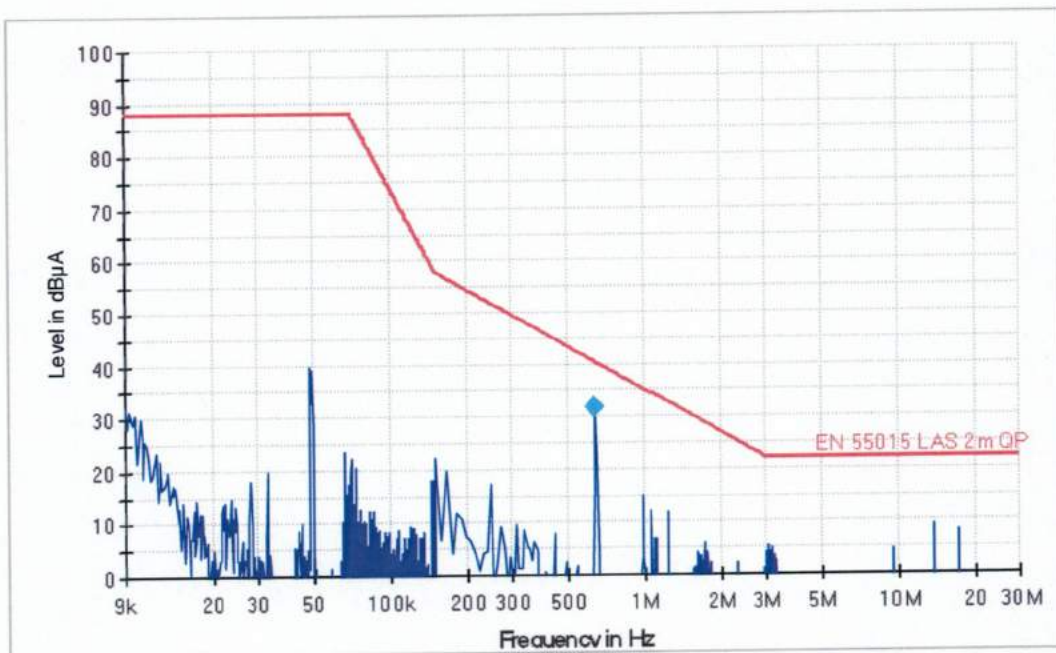

Final Result 1

Frequency (MHz)	QuasiPeak (dBµA)	Meas. Time (ms)	Bandwidth (kHz)	Corr. (dB)	Margin (dB)	Limit (dBµA)
0.638000	32.0	1000.00	9.000	1.1	8.6	40.6

EMI Measurement

Common Information

EUT Name:	Fixed general purpose luminaires, street lighting
Type	URBINO PREMIUM LED (130252.6L201.031)
Test Description	EN 55015
Operating Conditions	230V, 50Hz
Operator Name:	Nadhery
Comment:	Axis Y

EFS with Scans EZU KRUH2M2

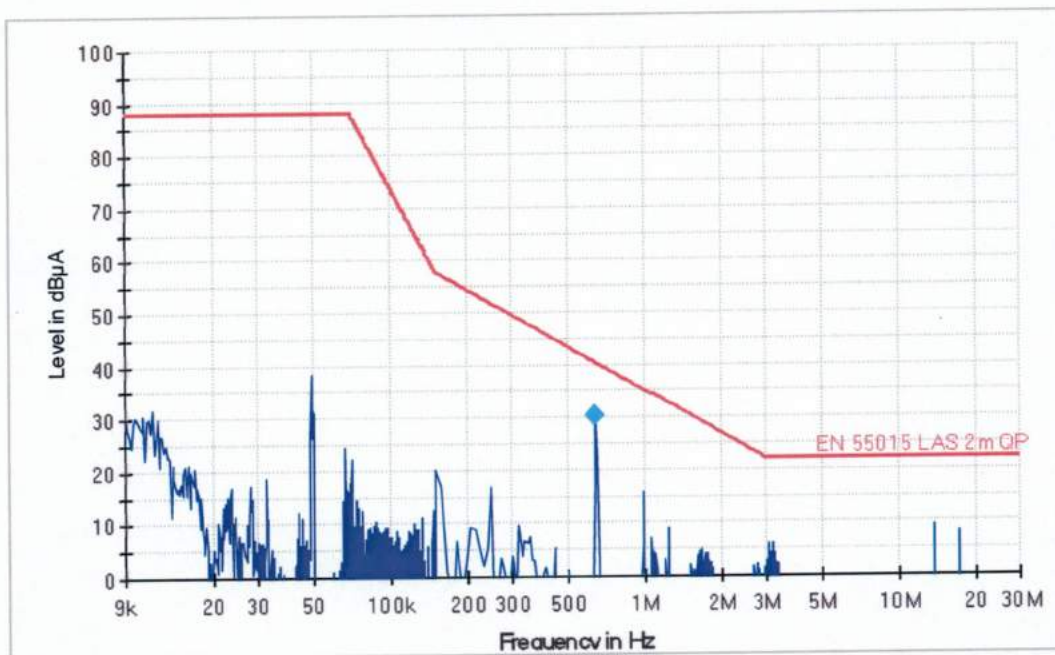

Final Result 1

Frequency (MHz)	QuasiPeak (dBµA)	Meas. Time (ms)	Bandwidth (kHz)	Corr. (dB)	Margin (dB)	Limit (dBµA)
0.638000	30.6	1000.00	9.000	1.1	10.0	40.6

EMI Measurement

Common Information

EUT Name:	Fixed general purpose luminaires, street lighting
Type	URBINO PREMIUM LED (130252.6L201.031)
Test Description	EN 55015
Operating Conditions	230V, 50Hz
Operator Name:	Nadhery
Comment:	Axis Z

EFS with Scans EZU KRUH2M2

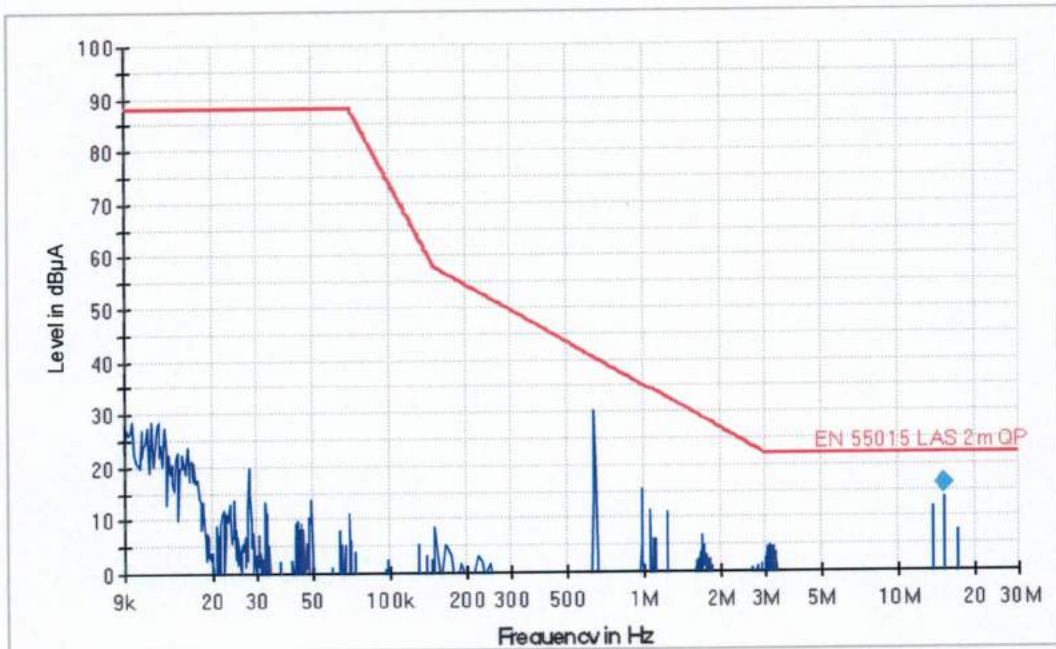

Final Result 1

Frequency (MHz)	QuasiPeak (dBµA)	Meas. Time (ms)	Bandwidth (kHz)	Corr. (dB)	Margin (dB)	Limit (dBµA)
15.198000	16.4	1000.00	9.000	0.9	5.6	22.0

**Measurement of interfering radiation in the 30 - 300 MHz band
According to: EN 55015 čl. 4.4.2**

Product: Fixed general purpose luminaires, street lighting

Type: URBINO PREMIUM LED (variants: class I)

Operating conditions:

230V, 50Hz, minimally 15 minutes in operation

Temperature: 24°C Rel. humidity: 35 – 45 %

Applied limits:

Band (MHz)	Limits dB(μ V/m), quasi-peak	
30 - 300	*)	30 (d=10m)
230 - 300	*)	37 (d=10m)

Measuring arrangement:

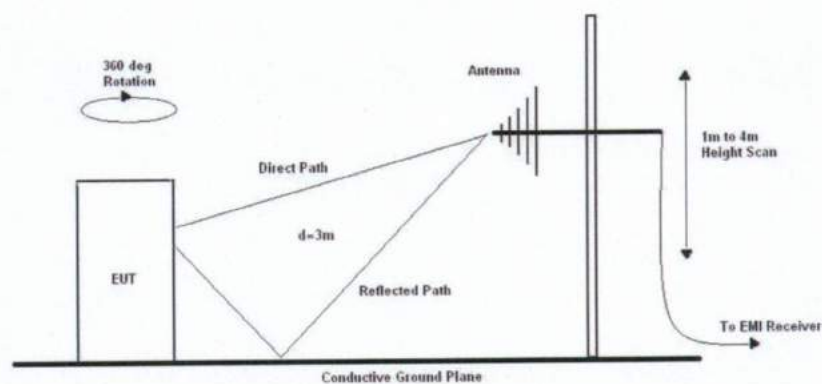

Notes:

For measured values see next pages

*) Limits and values converted to 3 m measuring distance

Test result: Pass

Measured by: Nádherný Date: 24. 7. 2018

Measured at: Elektrotechnický zkušební ústav, s.p.

EMI Measurement

Common Information

EUT Name:	Fixed general purpose luminaires, street lighting
Type	URBINO PREMIUM LED (130252.6L201.031)
Test Description	EN 55015
Operating Conditions	230V, 50Hz, Pmax
Operator Name:	Nadhery
Comment:	V, H polarization

EFS EZ U Luminaire

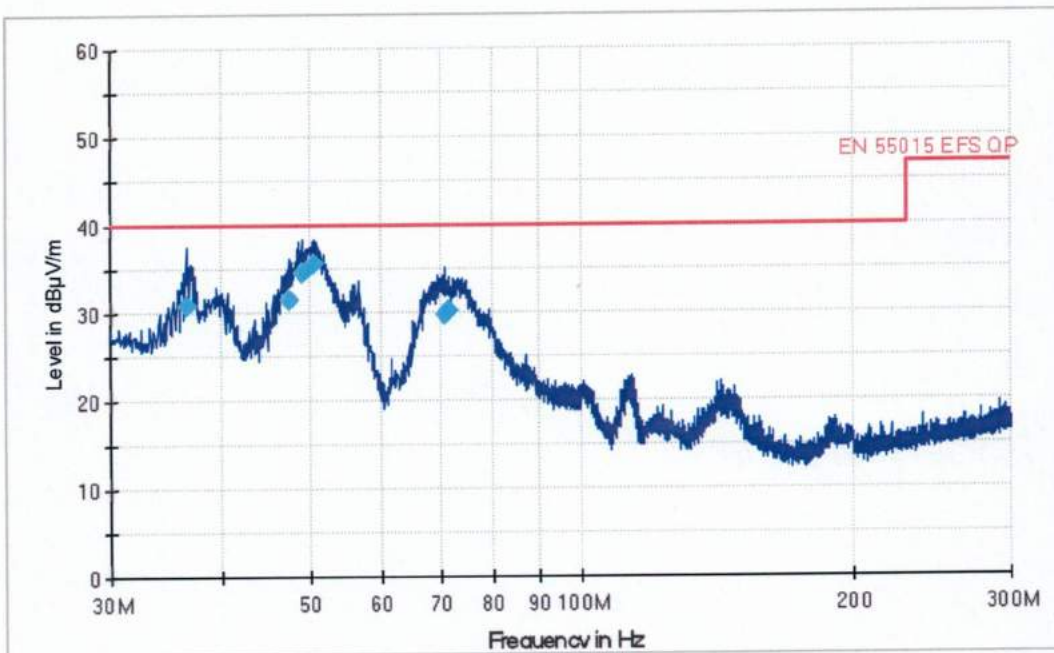

Final Result 1

Frequency (MHz)	QuasiPeak (dBµV/m)	Antenna height (cm)	Polarity	Turntable position (deg)	Corr. (dB)	Margin (dB)	Limit (dBµV/m)
36.480000	30.9	153.0	V	356.0	24.4	9.1	40.0
47.340000	31.5	110.0	V	77.0	20.4	8.5	40.0
49.020000	34.7	110.0	V	0.0	20.1	5.3	40.0
50.460000	35.8	110.0	V	356.0	19.7	4.2	40.0
70.620000	29.7	130.0	V	315.0	10.6	10.3	40.0
71.400000	30.3	110.0	V	8.0	10.4	9.7	40.0

EMI Measurement

Common Information

EUT Name:	Fixed general purpose luminares, street lighting
Type	URBINO PREMIUM LED (130252.6L201.031)
Test Description	EN 55015
Operating Conditions	230V, 50Hz, Pmin
Operator Name:	Nadhery
Comment:	V, H polarization

EFS EZU Luminaire

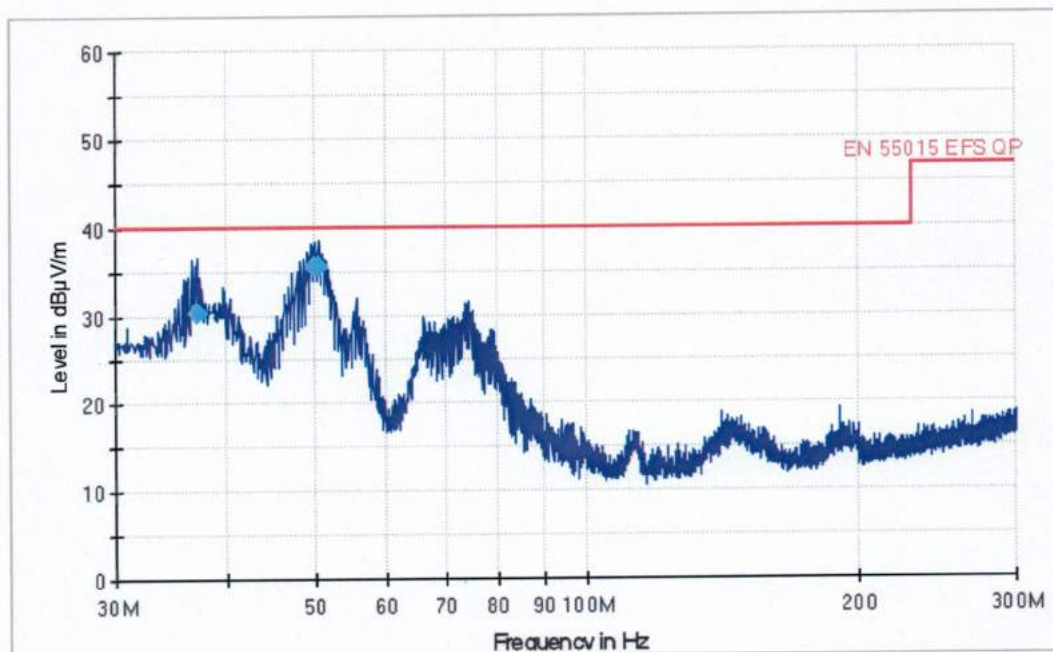

Final Result 1

Frequency (MHz)	QuasiPeak (dBµV/m)	Antenna height (cm)	Polarity	Turntable position (deg)	Corr. (dB)	Margin (dB)	Limit (dBµV/m)
37.020000	30.4	160.0	V	0.0	24.1	9.6	40.0
49.980000	35.7	115.0	V	0.0	20.0	4.3	40.0
50.640000	35.6	110.0	V	270.0	19.5	4.4	40.0

**Electromagnetic compatibility (EMC) - Limits -
Limits for harmonic current emission
According to: EN 61000-3-2 art. 7.3**

Product: Fixed general purpose luminaires, street lighting
Type: URBINO PREMIUM LED (variants: class I)

Operating conditions:
230V, 50Hz, minimally 15 minutes in operation
Temperature: 24°C Rel. humidity: 35 – 45 %

Measuring arrangement:

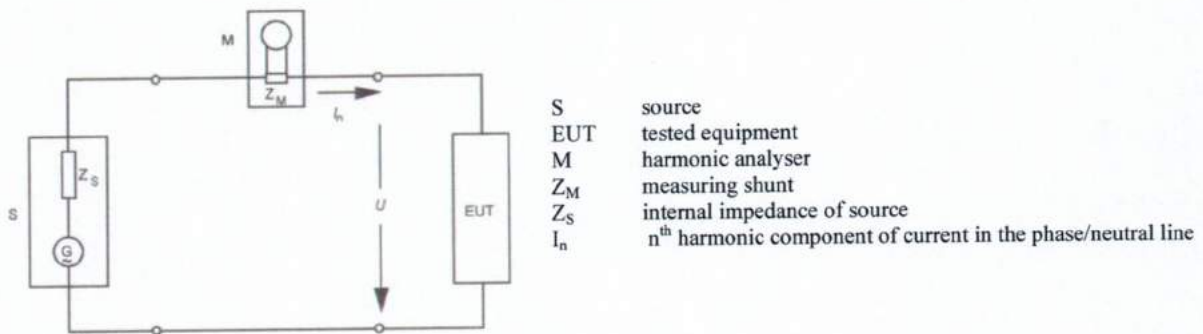

Applied limits:

Order of harmonics	Limit (%I1) P > 25W
2	2
3	30.λ
5	10
7	7
9	5
n 11 - 39 (only odd)	3

λ = power factor

Notes:
Equipment class C
For measured values see next pages

Test result: Pass

Measured by: Nádherný Date: 20. 7. 2018

Measured at: Elektrotechnický zkušební ústav, s.p.

Report title:	801441-01/02
Company Name:	Elektrotechnický zkušební ústav, s.p.
Date of test:	13:43 20.Jul 2018
Measurement file name:	Harmonics_3_2_Ed4.rsd
Tester:	Nádherný
Standard used:	EN/IEC 61000-3-2 Ed.4 Quasi-stationary Equipment class C
Observation time:	10s
Windows width:	10 periods - (EN/IEC 61000-4-7 Edition 2002 + A1:2008)
Customer:	LUG LIGHT FACTORY SP.Z O.O.
E. U. T.:	URBINO PREMIUM LED (variants: class I)
Temperature :	24
Humidity :	39
Comment:	230 V, 50 Hz, 159W (rated 157W)
Measurement smoothed data:	Fund. Current: 0.695A , 0.540A, 0.403A, 0.227A, 0.156A Power Factor: 0.99, 0.986, 0.977, 0.937, 0.866

Test Result	
E. U. T.:	PASS
Power Source:	PASS

20.Jul 2018

(Date)

Nádherný

(Sign)

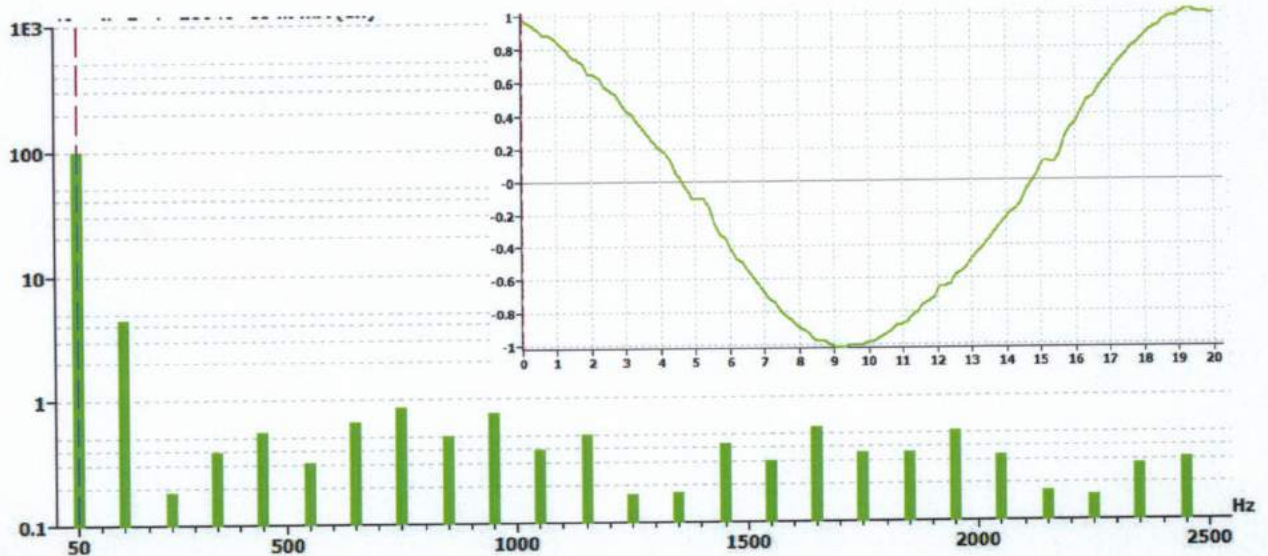

E. U. T. Result

Check harmonics 2..40 [exception odd 21..39]:

Harmonic(s) > 150%:	
Order (n):	None
Harmonic(s) with average > 100%:	
Order (n):	None

Check odd harmonics 21..39:

All Partial Odd Harmonics below partial limits.	
Harmonic(s) > 150%:	
Order (n):	None
Harmonic(s) with average > 150%:	
Order (n):	None

Power Source Result

First dataset out of limit:	
DS (time):	None
Harmonic(s) out of limit:	
Order (n):	None

Average harmonic current results-159W

Hn	I _{eff} [A]	I _{eff} [%]	Limit [%]	Result
1	694.564E-3	99.983		
2	594.544E-6	0.086		PASS
3	30.634E-3	4.410	29.71	PASS
4	599.012E-6	0.086		PASS
5	1.382E-3	0.199		PASS
6	558.427E-6	0.080		PASS
7	2.753E-3	0.396		PASS
8	553.367E-6	0.080		PASS
9	4.006E-3	0.577		PASS
10	548.696E-6	0.079		PASS
11	2.275E-3	0.327		PASS
12	582.882E-6	0.084		PASS
13	4.776E-3	0.687		PASS
14	511.965E-6	0.074		PASS
15	6.094E-3	0.877	3.00	PASS
16	538.513E-6	0.078		PASS
17	3.563E-3	0.513		PASS
18	559.689E-6	0.081		PASS
19	5.215E-3	0.751	3.00	PASS
20	521.774E-6	0.075		PASS
21	2.639E-3	0.380		PASS
22	565.961E-6	0.081		PASS
23	3.695E-3	0.532		PASS
24	598.070E-6	0.086		PASS
25	1.315E-3	0.189		PASS
26	568.583E-6	0.082		PASS
27	1.320E-3	0.190		PASS
28	530.246E-6	0.076		PASS
29	3.020E-3	0.435		PASS
30	539.716E-6	0.078		PASS
31	2.190E-3	0.315		PASS
32	586.544E-6	0.084		PASS
33	4.000E-3	0.576		PASS
34	600.245E-6	0.086		PASS
35	2.491E-3	0.359		PASS
36	584.068E-6	0.084		PASS
37	2.479E-3	0.357		PASS
38	567.992E-6	0.082		PASS
39	3.971E-3	0.572		PASS
40	573.934E-6	0.083		PASS

Harmonic currents less than 0.6% of the input current measured under the test conditions, or less than 5 mA, whichever is greater, are disregarded.

Average harmonic current results-123W

Hn	I _{eff} [A]	I _{eff} [%]	Limit [%]	Result
1	540.188E-3	99.975		
2	540.632E-6	0.100		PASS
3	26.326E-3	4.872	29.59	PASS
4	654.162E-6	0.121		PASS
5	1.868E-3	0.346		PASS
6	645.755E-6	0.120		PASS
7	2.447E-3	0.453		PASS
8	618.028E-6	0.114		PASS
9	3.851E-3	0.713		PASS
10	593.234E-6	0.110		PASS
11	1.325E-3	0.245		PASS
12	625.760E-6	0.116		PASS
13	3.712E-3	0.687		PASS
14	589.604E-6	0.109		PASS
15	4.281E-3	0.792		PASS
16	618.101E-6	0.114		PASS
17	1.848E-3	0.342		PASS
18	600.254E-6	0.111		PASS
19	3.571E-3	0.661		PASS
20	604.939E-6	0.112		PASS
21	1.356E-3	0.251		PASS
22	598.148E-6	0.111		PASS
23	3.629E-3	0.672		PASS
24	620.228E-6	0.115		PASS
25	1.171E-3	0.217		PASS
26	639.044E-6	0.118		PASS
27	1.264E-3	0.234		PASS
28	624.647E-6	0.116		PASS
29	4.031E-3	0.746		PASS
30	636.045E-6	0.118		PASS
31	1.821E-3	0.337		PASS
32	597.173E-6	0.111		PASS
33	4.020E-3	0.744		PASS
34	622.963E-6	0.115		PASS
35	3.305E-3	0.612		PASS
36	604.773E-6	0.112		PASS
37	1.437E-3	0.266		PASS
38	582.669E-6	0.108		PASS
39	3.723E-3	0.689		PASS
40	653.230E-6	0.121		PASS

Harmonic currents less than 0.6% of the input current measured under the test conditions, or less than 5 mA, whichever is greater, are disregarded.

Average harmonic current results-91W

Hn	I _{eff} [A]	I _{eff} [%]	Limit [%]	Result
1	402.462E-3	99.978		
2	583.486E-6	0.145	29.32	PASS
3	22.919E-3	5.693		PASS
4	585.940E-6	0.146		PASS
5	3.500E-3	0.869		PASS
6	574.543E-6	0.143		PASS
7	2.772E-3	0.689		PASS
8	570.599E-6	0.142		PASS
9	3.094E-3	0.768		PASS
10	546.102E-6	0.136		PASS
11	1.430E-3	0.355		PASS
12	524.756E-6	0.130		PASS
13	3.068E-3	0.762		PASS
14	552.408E-6	0.137		PASS
15	5.206E-3	1.293	3.00	PASS
16	559.360E-6	0.139		PASS
17	3.506E-3	0.871		PASS
18	534.786E-6	0.133		PASS
19	3.559E-3	0.884		PASS
20	540.251E-6	0.134		PASS
21	1.989E-3	0.494		PASS
22	569.095E-6	0.141		PASS
23	3.528E-3	0.877		PASS
24	542.272E-6	0.135		PASS
25	1.424E-3	0.354		PASS
26	563.730E-6	0.140		PASS
27	1.196E-3	0.297		PASS
28	549.715E-6	0.137		PASS
29	3.749E-3	0.931		PASS
30	557.065E-6	0.138		PASS
31	1.228E-3	0.305		PASS
32	546.047E-6	0.136		PASS
33	3.156E-3	0.784		PASS
34	547.977E-6	0.136		PASS
35	2.185E-3	0.543		PASS
36	560.062E-6	0.139		PASS
37	1.240E-3	0.308		PASS
38	530.967E-6	0.132		PASS
39	2.588E-3	0.643		PASS
40	539.598E-6	0.134		PASS

Harmonic currents less than 0.6% of the input current measured under the test conditions, or less than 5 mA, whichever is greater, are disregarded.

Average harmonic current results-50W

Hn	I _{eff} [A]	I _{eff} [%]	Limit [%]	Result
1	227.099E-3	99.951		
2	784.296E-6	0.345		PASS
3	19.962E-3	8.786	28.10	PASS
4	735.633E-6	0.324		PASS
5	5.802E-3	2.553	10.00	PASS
6	827.288E-6	0.364		PASS
7	2.128E-3	0.937		PASS
8	809.974E-6	0.356		PASS
9	3.914E-3	1.722		PASS
10	817.402E-6	0.360		PASS
11	2.063E-3	0.908		PASS
12	758.948E-6	0.334		PASS
13	2.992E-3	1.317		PASS
14	697.777E-6	0.307		PASS
15	4.935E-3	2.172		PASS
16	688.559E-6	0.303		PASS
17	3.288E-3	1.447		PASS
18	756.016E-6	0.333		PASS
19	2.810E-3	1.237		PASS
20	868.080E-6	0.382		PASS
21	3.242E-3	1.427		PASS
22	799.957E-6	0.352		PASS
23	2.553E-3	1.124		PASS
24	709.623E-6	0.312		PASS
25	1.936E-3	0.852		PASS
26	653.556E-6	0.288		PASS
27	2.002E-3	0.881		PASS
28	763.110E-6	0.336		PASS
29	1.451E-3	0.639		PASS
30	835.676E-6	0.368		PASS
31	1.312E-3	0.578		PASS
32	741.514E-6	0.326		PASS
33	873.870E-6	0.385		PASS
34	621.794E-6	0.274		PASS
35	2.197E-3	0.967		PASS
36	664.702E-6	0.293		PASS
37	1.790E-3	0.788		PASS
38	717.338E-6	0.316		PASS
39	1.509E-3	0.664		PASS
40	659.930E-6	0.290		PASS

Harmonic currents less than 0.6% of the input current measured under the test conditions, or less than 5 mA, whichever is greater, are disregarded.

Average harmonic current results-31W

Hn	I _{eff} [A]	I _{eff} [%]	Limit [%]	Result
1	155.567E-3	99.951	25.97	PASS
2	725.502E-6	0.466		
3	17.359E-3	11.153		
4	816.101E-6	0.524		
5	2.733E-3	1.756		
6	827.314E-6	0.532		
7	3.547E-3	2.279		
8	809.725E-6	0.520		
9	3.042E-3	1.954		
10	859.893E-6	0.552		
11	2.239E-3	1.439		
12	762.229E-6	0.490		
13	1.766E-3	1.135		
14	806.247E-6	0.518		
15	2.588E-3	1.663		
16	741.381E-6	0.476		
17	3.699E-3	2.377		
18	726.936E-6	0.467		
19	3.825E-3	2.458		
20	736.487E-6	0.473		
21	2.576E-3	1.655		
22	741.173E-6	0.476		
23	2.763E-3	1.775		
24	689.478E-6	0.443		
25	3.345E-3	2.149		
26	699.272E-6	0.449		
27	2.712E-3	1.742		
28	671.311E-6	0.431		
29	2.090E-3	1.343		
30	688.193E-6	0.442		
31	2.009E-3	1.291		
32	701.749E-6	0.451		
33	2.247E-3	1.444		
34	655.684E-6	0.421		
35	3.074E-3	1.975		
36	687.215E-6	0.442		
37	3.641E-3	2.339		
38	657.949E-6	0.423		
39	1.571E-3	1.009		
40	673.219E-6	0.433		

Harmonic currents less than 0.6% of the input current measured under the test conditions, or less than 5 mA, whichever is greater, are disregarded.

2. Immunity

EN 61547 *Equipment for general lighting purposes - EMC - immunity requirements*

Product: Fixed general purpose luminaires, street lighting

Type: URBINO PREMIUM LED (variants: class I)

Type representative: 130252.6L201.031

Requirements at tests:

Generic standard	Level	Allowed error *1)	Note
EN61000-4-2	$\pm 4\text{kV} / \pm 8\text{kV}$	B	Pass
EN61000-4-3	3V/m 80 - 1000 MHz	A	Pass
EN61000-4-4	$\pm 1\text{kV}$ AC power, $\pm 0,5\text{kV}$ signal lines	B	Pass
EN61000-4-5	$\pm 1\text{kV} / \pm 2\text{kV}$ $\pm 0,5\text{kV} / \pm 1\text{kV}$	C	Pass
EN61000-4-6	3 V 0,15 - 80 MHz	A	Pass
EN61000-4-8	3 A/m	A	*2) Pass
EN61000-4-11	200 ms / 70% U_T 10 ms / 0% U_T	C B	Pass

Notes:

The results of the tests specified in the protocol relating to device with electronic ballasts:
130252.6L201.031; TRIDONIC LCA 160W 350-1050mA one4all C PRE OTD

*1) Performance criteria according to EN 61547, art. 4.2

*2) Devices do not contain parts sensitive to the magnetic field

Test result: Pass

Compiled by: Nádherný



Measured at: Elektrotechnický zkušební ústav, s.p.

Test of electric discharge resistance
According to: EN 61000-4-2

Product: Fixed general purpose luminaires, street lighting
Type: URBINO PREMIUM LED (variants: class I)

Operating conditions:
230V, 50Hz, minimally 15 minutes in operation
Temperature: 24°C Rel. humidity: 35 – 45 %

Allowed criterion: B

Number of testing discharges: 10/10 contact/air discharge to every test-places in each polarity, besides indirect contact discharges into a vertical and horizontal coupling plane

Tested points: Contact discharge into the metal parts and to the horizontal and vertical coupling plane. Air discharge into plastic parts, contact discharge into conducted parts.

Testing voltage [kV]: ±4 – contact discharge / ±8 – air discharge

Achieved criterion: A

Measuring arrangement:

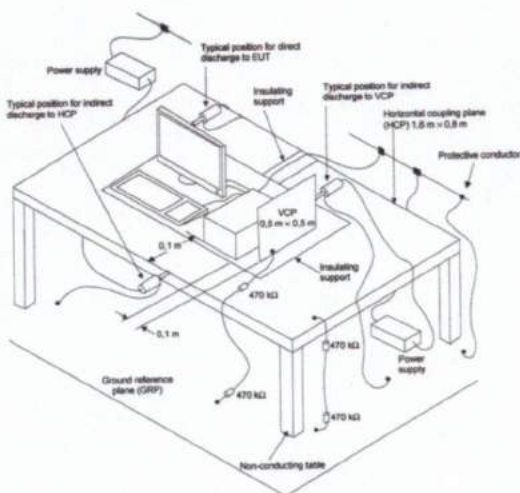

Contact → , air →

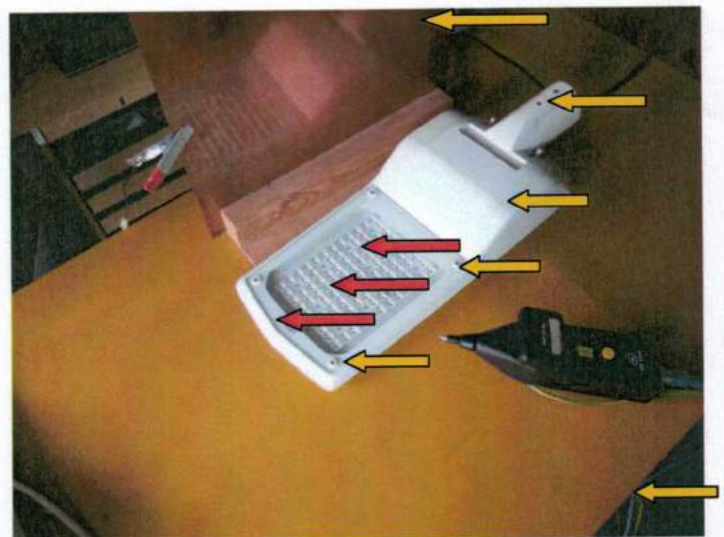

Notes:--

Test result: Pass

Measured by: Nádherný Date: 20. 7. 2018

Measured at: Elektrotechnický zkušební ústav, s.p.

Immunity test - radiated electromagnetic field requirements
According to: EN 61000-4-3

Product: Fixed general purpose luminaires, street lighting
Type: URBINO PREMIUM LED (variants: class I)

Operating conditions:
230V, 50Hz, minimally 15 minutes in operation
Temperature: 24°C Rel. humidity: 35 – 45 %

Applied limits:
Scan spectrum: 80 - 1000 MHz
Intensity of field: 3 V/m (80% AM, 1kHz)

Allowed criterion: A

Achieved criterion: A

Measuring arrangement:

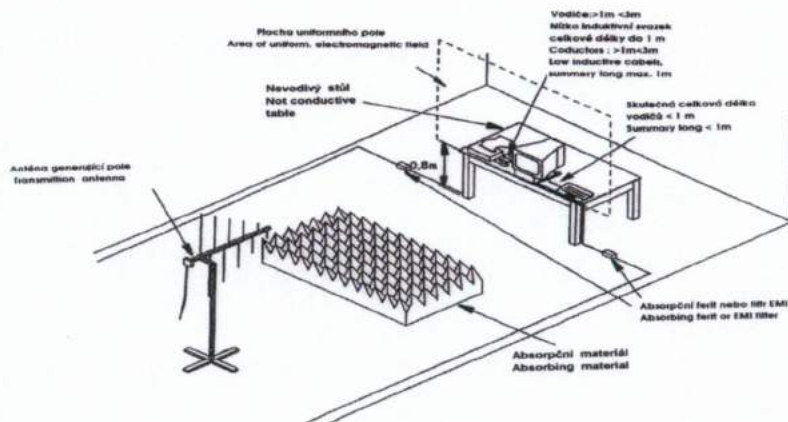

Notes: --

Test result: Pass

Měřil - Measured by: Nádherný Datum - Date: 24. 7. 2018

Místo měření - Measured at: Elektrotechnický zkušební ústav, s.p.

*Test by quick transient burst
According to: EN 61000-4-4*

Product: Fixed general purpose luminaires, street lighting

Type: URBINO PREMIUM LED (variants: class I)

Operating conditions:

230V, 50Hz, minimally 15 minutes in operation

Temperature: 25°C Rel. humidity: 35 – 45 %

Allowed criterion: B

Testing voltage applied:

Applied to	Testing level	Performance criterion	Remark
L,N,L+N	±1kV	A	Coupling networks to power supply
L+PE	±1kV	A	
N+PE	±1kV	A	
L+N+PE	±1kV	A	
DA, DA	±0,5kV	A	By coupling network to DALI terminals

Measuring arrangement:

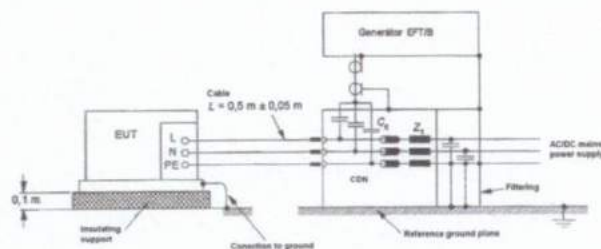

Notes:--

Test result: Pass

Measured by: Nádherný Date: 20. 7. 2018

Measured at: Elektrotechnický zkušební ústav, s.p.

Surge immunity test
According to: EN 61000-4-5

Product: Fixed general purpose luminaires, street lighting

Type: URBINO PREMIUM LED (variants: class I)

Operating conditions:

230V, 50Hz, minimally 15 minutes in operation

Temperature: 25°C Rel. humidity: 35 – 45 %

Allowed criterion: C

Testing voltage applied:

Applied voltage	Testing level	Performance criterion	Remark
L-N	P>25W: ±1kV	B	90°, 270°
L-PE, N-PE, L+N-PE	P>25W: ±2kV	B	90°, 270°

Measuring arrangement:

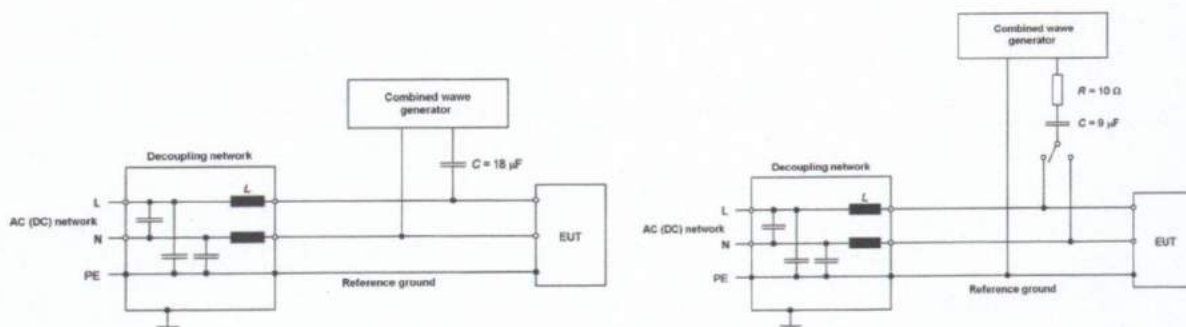

Notes: --

Test result: Pass

Measured by: Nádherný Date: 20. 7. 2018

Measured at: Elektrotechnický zkušební ústav, s.p.

Immunity test - conducted disturbances induced by radio-frequency fields
According to: EN 61000-4-6

Product: Fixed general purpose luminaires, street lighting

Type: URBINO PREMIUM LED (variants: class I)

Operating conditions:

230V, 50Hz, minimally 15 minutes in operation

Temperature: 25 °C Rel. humidity: 35 – 45 %

Allowed criterion: A

Testing voltage applied:

Frequency band	Testing voltage level	Note
150kHz - 80MHz	3V (mod. 80% AM / 1 kHz)	Applied by coupling network to Mains and DALI terminals

Achieved criterion: A

Measuring arrangement:

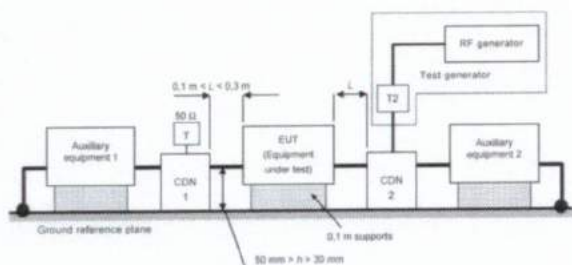

Notes: --

Test result: Pass

Measured by: Nádherný Date: 23. 7. 2018

Measured at: Elektrotechnický zkušební ústav, s.p.

*Voltage dips, short interruptions and voltage variations
According to: EN 61000-4-11*

Product: Fixed general purpose luminaires, street lighting

Type: URBINO PREMIUM LED (variants: class I)

Operating conditions:

230V, 50Hz, minimally 15 minutes in operation

Temperature: 24°C Rel. humidity: 35 – 45 %

Allowed criterion: C, B

Tests requirements:

Test level [%] Ut	Duration 50 / 60Hz [ms]	Allowed criterion	Achieved criterion
0	10 / 8,3	B	B
70	200 / 167	C	A

Notes: --

Test result: Pass

Measured by: Nádherný Date: 23. 7. 2018



Measured at: Elektrotechnický zkušební ústav, s.p.

Measuring equipment used:

<input checked="" type="checkbox"/> Test receiver RaS	ESCI	110213	04.2020
<input checked="" type="checkbox"/> Měřicí přijímač- Test receiver RaS	ESIB26	110097	02.2020
<input checked="" type="checkbox"/> Continuous wave simulátor EM Test	CWS500N1	110232	03.2019
<input checked="" type="checkbox"/> Harmonic analyzer EM TEST	DPA503N	110272	02.2019
<input checked="" type="checkbox"/> Power fail simulator EM Test	PFS 500	98-6040	10.2019
<input checked="" type="checkbox"/> Ultra Compact Simulator EM Test	UCS 500N	110235	02.2019
<input checked="" type="checkbox"/> ESD generator	ESD30N	110196	03.2019
<input type="checkbox"/> ESD generátor	ESD30	110090	12.2018
<input checked="" type="checkbox"/> Artificial mains EMCO	3825/2	95-5852	07.2019
<input type="checkbox"/> Artificial mains Narda	PMM L3-32	110250	11.2019
<input checked="" type="checkbox"/> Artificial mains ESH	ESH4-Z5	5821/1	05.2020
<input checked="" type="checkbox"/> Antenna Frankonia	BTA-M	00-6321	05.2020
<input type="checkbox"/> Antenna Double Ridget	HF 907	110177	08.2020
<input checked="" type="checkbox"/> Burst generátor Haefely	PEFT Junior	5872	12.2018
<input checked="" type="checkbox"/> Surge generator	VCS500-M	110114	04.2020
<input type="checkbox"/> Current Probe R&S	EZ-17	110098	05.2019

Auxiliary equipment:

<input checked="" type="checkbox"/> Supply source EM TEST	HFS300	98-6042	02.2019
<input type="checkbox"/> Ref. impedance SCHAFFNER	LR4	X71773	02.2019
<input checked="" type="checkbox"/> Attenuator 6dB	ATT6	110233/3	05.2020
<input checked="" type="checkbox"/> Electric Field Probe Narda	EP603	110273	01.2019
<input checked="" type="checkbox"/> Amplifier PRÁNA	AP32 LT225	07-110145	
<input type="checkbox"/> Amplifier MILMEGA	AS0822-100	98-6038	
<input type="checkbox"/> Amplifier MILMEGA	AS0204-125	110144	
<input type="checkbox"/> Amplifier MILMEGA (1.8-6GHz)	AS1860-100	110219	
<input checked="" type="checkbox"/> Signal generator RaS	SMF100A	110167	05.2021
<input type="checkbox"/> Multimetr - Multimeter	FLUKE189	550049	02.2020
<input type="checkbox"/> Probe RFT	TK12	700044	06.2020
<input checked="" type="checkbox"/> Coupling/dec. EM TEST	CDN M3N	552097	11.2019
<input checked="" type="checkbox"/> Coupling/dec. EM TEST	CDN M2N	110233/2	11.2019
<input type="checkbox"/> Coupling/SCHAFFNER ISN T4xx	ISN T4xx	110032	
<input type="checkbox"/> Capacitive coupling clamp	Haefely		
<input type="checkbox"/> Current probe	P MP-120		
<input type="checkbox"/> Current probe	AM503	79-4221	
<input checked="" type="checkbox"/> Current probe RFT	SMZ 11 -9076	700459	06.2021
<input type="checkbox"/> Elektromag. kleště- Electromag. injection clamp	EM-101	110233	11.2019
<input type="checkbox"/> Ferrite clamp 1-1000 MHz	EZ-24	10003	
<input checked="" type="checkbox"/> Anechoic chamber - Euroshield Oy	RFMSD-F/A	6341	02.2020
<input type="checkbox"/> Absorbing Clamp	MDS-21	5425	06.2022
<input checked="" type="checkbox"/> Notebook Dell	Dell D351	551492	
<input type="checkbox"/> Multimeter Fluke	289	552550	06.2020
<input checked="" type="checkbox"/> Ocelové pásmo – Metal meter	5m	N400014	12.2020
<input checked="" type="checkbox"/> Pulse Limiter RaS	ESH3-Z2	5424	01.2019
<input checked="" type="checkbox"/> Hygrometer	TESTO 608-H2	551002	10.2018
<input checked="" type="checkbox"/> Hygrometer	TESTO 625	50021821	10.2018

Cables:

- K1
- K22 , ESH3-Z2
- K14 , K15a , K16
- KB01, KB02, KB04
- KB06
- K4 , K19
- K23
- K27
- K25, K2, K4

EZU equipments:

- PR 51 – EN 61000-4-2 – Vertical coupling plane
- Dummy lamp: dle - according to EN55015
- Regulating transformer - ZPA RA20
- PR-21 - Stabilized power supply BS 525
- P10 - EN55015 - Spherical cover
- P11 - EN6100-4-8 - EZÚ test setup
- P13 – Třífázový přepínač - three-phase switch
- PR45 - Loop antenna 2m

Photo-documentation

Product: Fixed general purpose luminaires, street lighting

Type: URBINO PREMIUM LED (variants: class I)

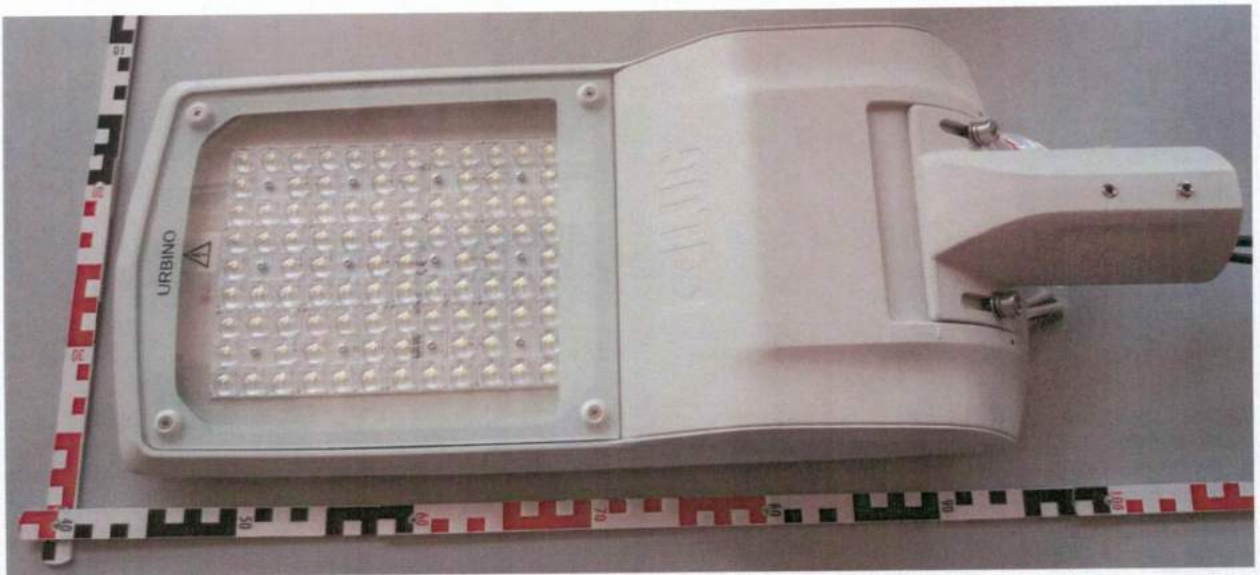

Celkový pohled - Overview: 130252.6L201.031

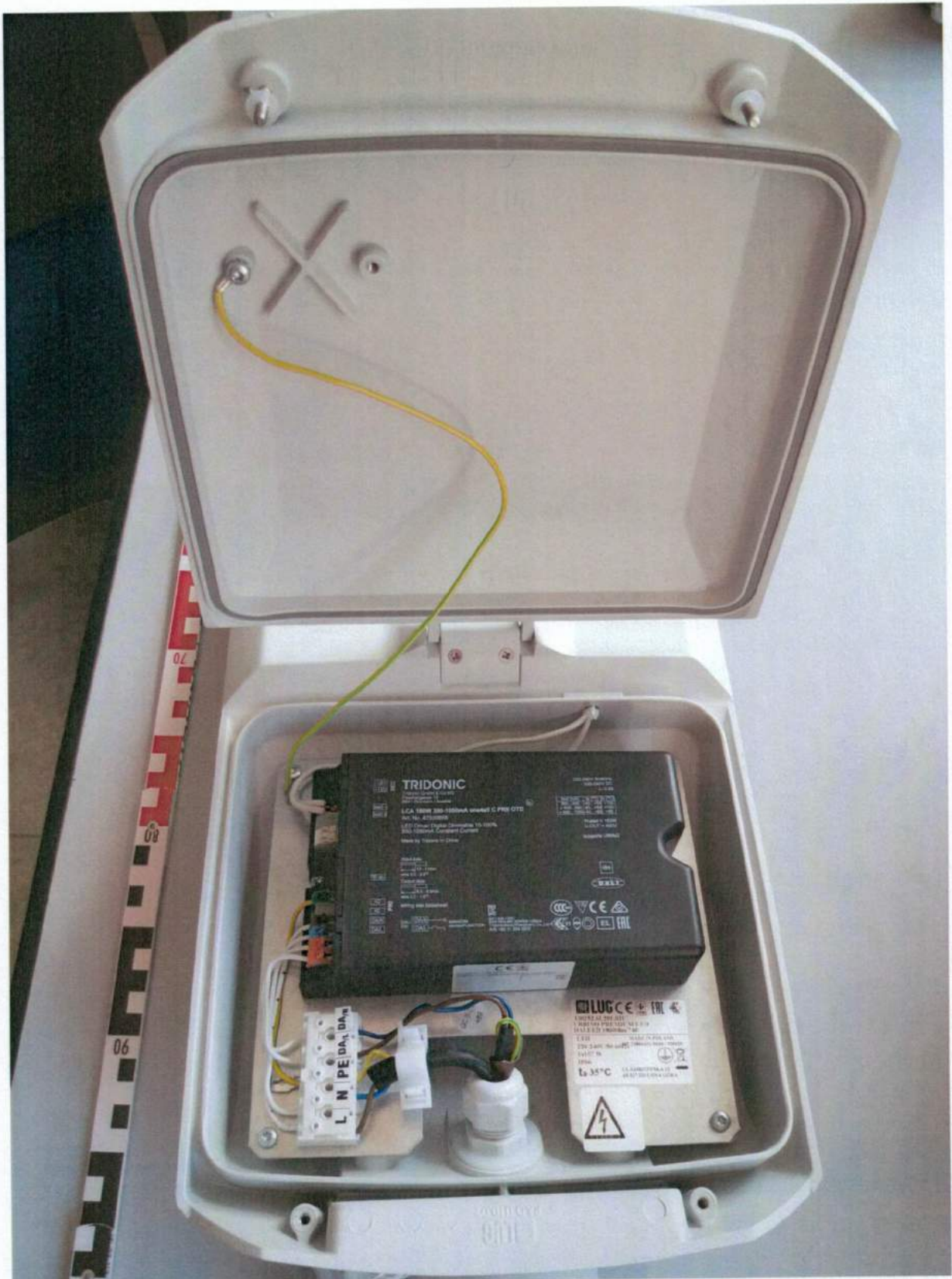

Předřadník - Ballast : TRIDONIC LCA 160W 350-1050mA one4all C PRE OTD

A handwritten signature in blue ink, appearing to be 'Mj'.



Výrobní štítek – Name plate

nj