



Tray ID 97109760
 Tray name SET INTERVENTII CARDIO ADULT
 Speciality filter CARDIOVASCULAR
 Intervention filter Cardiovascular Other
 Hospital filter Tehnomedica SRL

Description	Qty
-------------	-----



Crepe paper 60x60cm 60g/m2 White	1
----------------------------------	---



BNS Thoracic Drape 200/300x330cm, incise area 32x40cm	1
---	---



Mepore film & pad 9x30cm 5x25cm	1
---------------------------------	---



Plastic bag 20x30cm Ziplock Transp.	1
-------------------------------------	---



Instrument cleaner 5x5cm	1
--------------------------	---



Arm Sleeve 17x50cm	1
--------------------	---



Needle counter 20ct Foam/Magnet BR	1
---------------------------------------	---



Light handle cover large Light green/white collar	2
--	---



Adh. split sheet 200x260cm Split
20x102cm Perineal cover

1



Adh. op towel 75x75cm

2



Fluid Collection Pouch 40x35cm

1



Foot cover 36x28cm Ocean

1



Tube holder 2,5x30cm Velcro/Adh

2



Op tape 9x49cm

3



Fluid Collection Pouch 40x35cm

2



BNS Surgical Gown PR HP, XLL

2



Hand towel 18x25cm

2



Table cover 150x190cm
Abs.75x190cm Folded

1



Foot cover 36x28cm Ocean

1

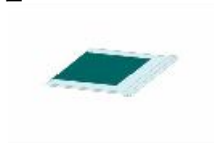

Mayo stand cover Reinf.79x145cm
Abs.65x85cm

1



Surgical gown Primary Standard
Perfomace XL-L

2



Hand towel 18x25cm

4



Surg.glove latex 8.0 PF 2/1 Biogel
Surgeons

1



Surg.glove latex 7.0 PF 2/1 Biogel
Surgeons

1



Surg.glove latex 7.5 PF 2/1 Biogel
Surgeons

1



Surg.glove latex 8.5 PF 2/1 Biogel
Surgeons

1



Reinforced Table Cover 150 x 240
wrapping

1









SA Label 1,6 x 5cm Red
TEHNOMEDICA SRL

1

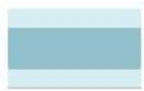
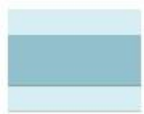

Tray ID	97109781
Tray name	SET INTERVENTII BP
Speciality filter	CARDIOVASCULAR
Hospital filter	Tehnomedica SRL

Description	Qty
-------------	-----

	Table cover 150x240cm Abs.75x240cm Folded	1
	Table cover 150x190cm Abs.75x190cm Folded	1
	Cardiovascular drape 200/300x350 cm Incise 32x40cm and 17x107cm	1
	Adh. op towel 100x100cm	3
	Adh. op towel 75x75cm	2
	Foot cover 36x28cm Ocean	1
	Tube holder 2,5x30cm Velcro/Adh	2
	Adh. perineal drape 18x40cm	1



Fluid Collection Pouch 40x35cm

3



Op tape 9x49cm

3



Mepore film & pad 9x30cm 5x25cm

1



Arm Sleeve 17x50cm

1



Plastic bag 20x30cm Ziplock Transp.

1



Instrument cleaner 5x5cm

1



Light handle cover large Light green/white collar

2



Needle counter 20ct Foam/Magnet BR

1



Foot cover 36x28cm Ocean

1



Mayo stand cover Reinf.79x145cm Abs.65x85cm

1



BNS Surgical Gown PR HP, XLL

2



Surg.glove latex 8.5 PF 2/1 Biogel Surgeons

1



Surgical gown Primary Standard Perfomace XL-L
152cm

2



Surg.glove latex 8.0 PF 2/1 Biogel Surgeons

1



Hand towel 18x25cm

8



Surg.glove latex 7.5 PF 2/1 Biogel Surgeons

1



Surg.glove latex 7.0 PF 2/1 Biogel Surgeons

1



Reinforced Table Cover 190 x280 wrapping

1



SA Label 1,6 x 5cm Red TEHNOMEDICA SRL

1



Tray ID	97030890
Tray name	SET INTERVENTII COPII
Speciality filter	CARDIOVASCULAR
Intervention filter	Cardiovascular Other
Hospital filter	Tehnomedica SRL

Description	Qty
-------------	-----

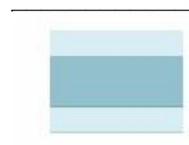

Table cover 150x190cm Abs.75x190cm Folded	1
---	---



BNS Aperture drape 200x300, ap.12x16,5cm	1
--	---



Adh. split sheet 200x260cm Split 20x102cm Perineal cover	1
---	---



Adh. op towel 75x75cm	2
-----------------------	---



Op tape 9x49cm	3
----------------	---

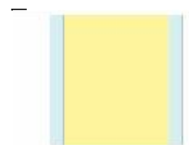

Incise drape 40x40cm Inc.40x34cm	1
----------------------------------	---



Tube holder 2,5x30cm Velcro/Adh	2
---------------------------------	---

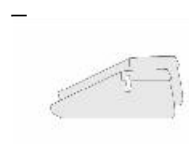

Foot cover 36x28cm Ocean	2
--------------------------	---



Fluid Collection Pouch 40x35cm

1



Mepore film & pad 9x30cm 5x25cm

1



Arm Sleeve 17x50cm

1



Fluid Collection Pouch 40x35cm

2



Needle counter 20ct Foam/Magnet BR

1



Light handle cover large Light green/white collar

2



Plastic bag 20x30cm Ziplock Transp.

1



Instrument cleaner 5x5cm

1



Surg.glove latex 8.0 PF 2/1 Biogel Surgeons

1



Surg.glove latex 8.5 PF 2/1 Biogel Surgeons

1



Surg.glove latex 7.0 PF 2/1 Biogel Surgeons

1



Surg.glove latex 7.5 PF 2/1 Biogel Surgeons

1



BNS Surgical Gown PR HP, XLL

2



Hand towel 18x25cm

2



Surgical gown Primary Standard Performace XL-L

2



Hand towel 18x25cm

4



Mayo stand cover Reinf.79x145cm Abs.65x85cm

1



Reinforced Table Cover 150 x 240 wrapping

1



SA Label 1,6 x 5cm Red TEHNOMEDICA SRL

1

699054

Universal Set Standard

Product details

Descriptive feature: Unassigned

Sterility: Sterile

Images

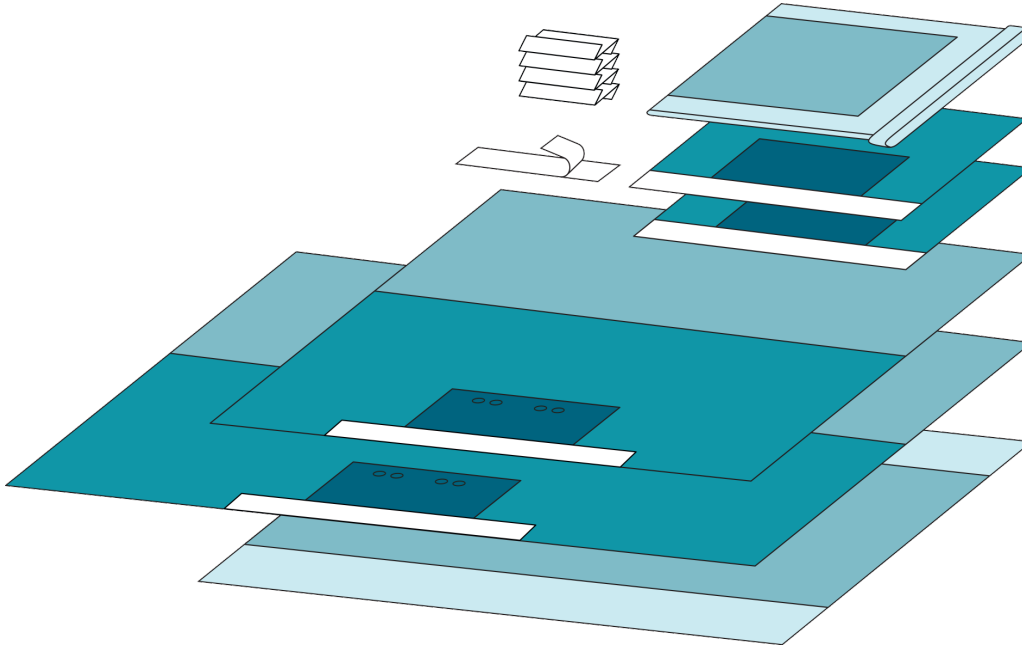

Products included in set

Product ID	Quantity	Product name	Size	Descriptive feature
996106	1,0	Mayo Stand Cover	79cm x 145cm	Absorbent
910200	2,0	Adhesive OP-Towel	90cm x 75cm	3-ply, Adhesive, Patched
26153-20	4,0	Cellulose Towel	18cm x 25cm	
911500	1,0	OP-Tape	9cm x 49cm	Adhesive
967772	1,0	Adhesive OP-Sheet	175cm x 175cm	3-ply, Adhesive, Patched
967773	1,0	Adhesive OP-Sheet	240cm x 150cm	3-ply, Adhesive, Patched
90190	1,0	Table Cover	150cm x 190cm	Absorbent

Delivered items

699054-07

Sales released in: Algeria, Austria, Bahrain, Belgium, Bosnia and Herzegovina, Bulgaria, Chile, Colombia, Croatia, Czechia, Denmark, Estonia, Faroe Islands, Finland, France, Germany, Hong Kong, Hungary, Iceland, Indonesia, Iran (Islamic Republic of), Iraq, Ireland, Israel, Italy, Jordan, Kuwait, Latvia, Libya, Lithuania, Luxembourg, Macedonia (the former Yugoslav Republic of), Madagascar, Malaysia, Mexico, Moldova (the Republic of), Montenegro, Netherlands, New Zealand, Norway, Oman, Philippines, Poland, Portugal, Qatar, Romania, Russian Federation, Saudi Arabia, Serbia, Singapore, Slovakia, Slovenia, South Africa, Spain, Sweden, Switzerland, Syrian Arab Republic, Turkey, United Arab Emirates, United Kingdom of Great Britain and Northern Ireland, Venezuela (Bolivarian Republic of)

Country of origin: Belgium

Shelf life: 5 years

Sterilization method: Beta

Packing information: First packaging layer is a peel-open sterile barrier, plastic/plastic. Once opened the sterile barrier cannot be closed again. Second layer is a corrugated board dispenser box. Third layer is a corrugated board transport box.

Packaging level	Pack count	GS1 code
Consumer pack	1	7332430983794
Dispenser box	6	7332430983787
Transport box	12	7332430983770
Pallet	144	7332430983763

Material

Phthalates:

No

Polyvinyl chloride:

No

Technical

Disposal instructions

Non-hazardous waste used BARRIER products and sterility barriers should, in the majority of cases, be classified as non-hazardous waste. They contain high amounts of energy and are well suited for incineration. BARRIER products do not contain any hazardous substances that can leach out if the products are land filled. Transport boxes are designed to fit existing recovery systems. The new BARRIER packaging system complies with the Packaging Waste Directive of the European Union.

Storage instructions

Mölnlycke Health Care recommends that BARRIER products are stored under normal storage conditions. All layers of packaging should be kept intact until access to the underlying layers is needed. Storage facilities for products only protected by the sterility barrier should be kept under conditions where low level of particulate air contamination prevail, so that it would not constitute a risk to the patient when the package is opened and the product is used.

Classification

Regulation type	MDD Class IS	Locally Regulated	Unregulated
CE Certificate Number:	CE 01966		
Notified body medical devices/PPE:	BSI (0086)		
Intended use MDD:	Surgical drapes, when sterilised, are intended to minimize the spread of micro-organisms, in order to reduce the risk for post operative wound infection.		
Sales released in:	Austria, Belgium, Bulgaria, Croatia, Czechia, Denmark, Estonia, Faroe Islands, Finland, France, Germany, Hungary, Iceland, Ireland, Italy, Latvia, Lithuania, Luxembourg, Netherlands, Norway, Poland, Portugal, Romania, Slovakia, Slovenia, Spain, Sweden, Switzerland, United Kingdom of Great Britain and Northern Ireland	Algeria, Bahrain, Colombia, Indonesia, Israel, Jordan, Kuwait, Malaysia, Mexico, Moldova (the Republic of), New Zealand, Oman, Philippines, Qatar, Russian Federation, Saudi Arabia, Serbia, Singapore, Turkey, United Arab Emirates	Bosnia and Herzegovina, Chile, Hong Kong, Iran (Islamic Republic of), Iraq, Libya, Macedonia (the former Yugoslav Republic of), Madagascar, Montenegro, South Africa, Syrian Arab Republic, Venezuela (Bolivarian Republic of)

Applied standards: The standards presented below is a selection of the most essential standards that are adhered to.

EN 1041, EN 556-1, EN 13795, EN 62366, EN ISO 9001, EN ISO 13485, EN ISO 10993-1, EN ISO 11607-1, EN ISO 11607-2, EN ISO 15223-1, ISO 15223-2, ISO 14001

Removable Label

Yes

GMDN Code (Global Medical Device Nomenclature)

33961

Lot 186.

ANGIOGRAPHY RADIALIS SET

-/10 698260

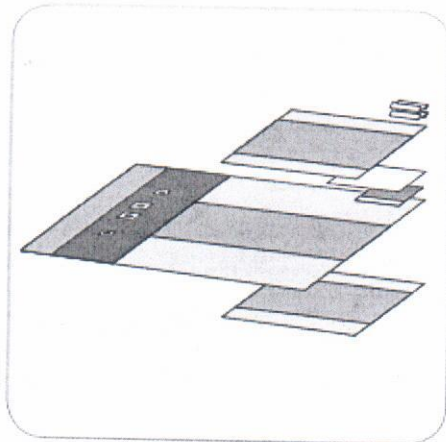









Ref. No.	Qty	Description
90150	1	Table Cover 150x150cm, abs. 75x150cm
-	2	Cellulose Towel 18x25cm
304998	1	Absorbent Towel 56x80cm
947064	1	Adhesive OP-Towel 50x50cm
958284	1	Angiography Drape 240x330cm, ap. 5x7cm (2) and 7x9cm (2)
90150	1	Table Cover 150x150cm, abs. 75x150cm
82275	2	Surg.glove latex 7.5 PF 2/1 Biogel Surgeons
82280	1	Surg.glove latex 8.0 PF 2/1 Biogel Surgeons
		5010783
	1	Angiographic syringe 10 ml
	1	Puncture Needle 1,3 x 70 mm, 18G
	1	Scalpel Cutfix fig. 11
	1	Guidewire J3FC-FS175-035 175cm
	30	Compress gauze 10 x 10 cm, 12-ply
	2	Sterican Cannula 0,80 x 40 mm, 21G
	1	Sterican Cannula 0,70 x 30 mm, 22G
	1	Syringe Omnifix 2 ml, Luer Lock
	1	Syringe Omnifix 5 ml, Luer Lock,
	1	Syringe Omnifix 10 ml, Luer Lock,
	1	Syringe Omnifix 20 ml, Luer Lock,
	1	Guidewire bowl 2500 ml, blue
	1	Cover drape 100 x 150 cm
	1	Combidyn tubing 150 cm, red
	1	Rotator m/m
	1	Manifold 3-fold, OFF, 35 bar
	2	Tape for fixation "Japan"
	1	Contrast Media System 180 cm
	1	Infusionsystem ventilated 190 cm

B | BRAUN



Tray ID 97038757
Tray name SET INTERVENTII RADIOGRAFICE
Speciality filter ENDOVASCULAR
Intervention filter Coronary or Peripher
Hospital filter Tehnomedica SRL

Description		Qty
	Crepe paper 60x60cm 60g/m2 White	1
	Angio drape 240x330cm 2 adh.ap.5x7cm 2 adh.ap.7x9cm Transp. panels	1
	Kidney bowl 800ml Yellow	1
	Adh. op towel 50x50cm	1
	Banded bag 75cm Circ. Elast. Transp.	1
	Absorbent towel 34x50cm	1
	Bowl 250ml Graduated red	1
	Bowl 2500ml Polypropylene Blue Guidewire W/tabs	1



Specimen cup 120ml Polyethylene Transp. Blue screw-on lid 1



Gallipot 120ml Transparent 1



Forceps tweezer plastic green 1



Forceps 12cm plastic green 1



Banded bag 140cm Circ. Elast. Transp. 2



Surg.glove latex 7.5 PF 2/1 Biogel Surgeons 2



Surg.glove latex 8.0 PF 2/1 Biogel Surgeons 1



Surgical gown Primary Standard Perfomance XL 1



Hand towel 47x38cm 2



Surgical gown Primary Standard Perfomance XL 2



Hand towel 47x38cm

2

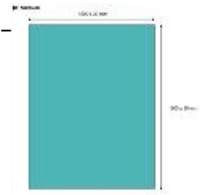

Reinforced Table Cover 150 x 190 wrapping

1

Article number 5010783

B | BRAUN

Angiographic syringe 10 ml

1

Puncture Needle 1,3 x 70 mm, 18G

1

Scalpel Cutfix fig. 11

1

Guidewire J3FC-FS175-035

1

Compress gauze 10 x 10 cm, 12-ply

30

Sterican Cannula 0,80 x 40 mm, 21G

2

Sterican Cannula 0,70 x 30 mm, 22G

1

Syringe Omnifix 2 ml, Luer Lock

1

Syringe Omnifix 5 ml, Luer Lock,

1

Syringe Omnifix 10 ml, Luer Lock,

1

Syringe Omnifix 20 ml, Luer Lock,

1

Guidewire bowl 2500 ml, blue

1

Cover drape 100 x 150 cm

1

Combidyn tubing 150 cm, red

1

Rotator m/m

1

Manifold 3-fold, OFF, 35 bar

1

Tape for fixation "Japan"

2

Contrast Media System 180 cm

1

Infusionsystem ventilated 190 cm

1