

UNIDRIVE® Select System Components

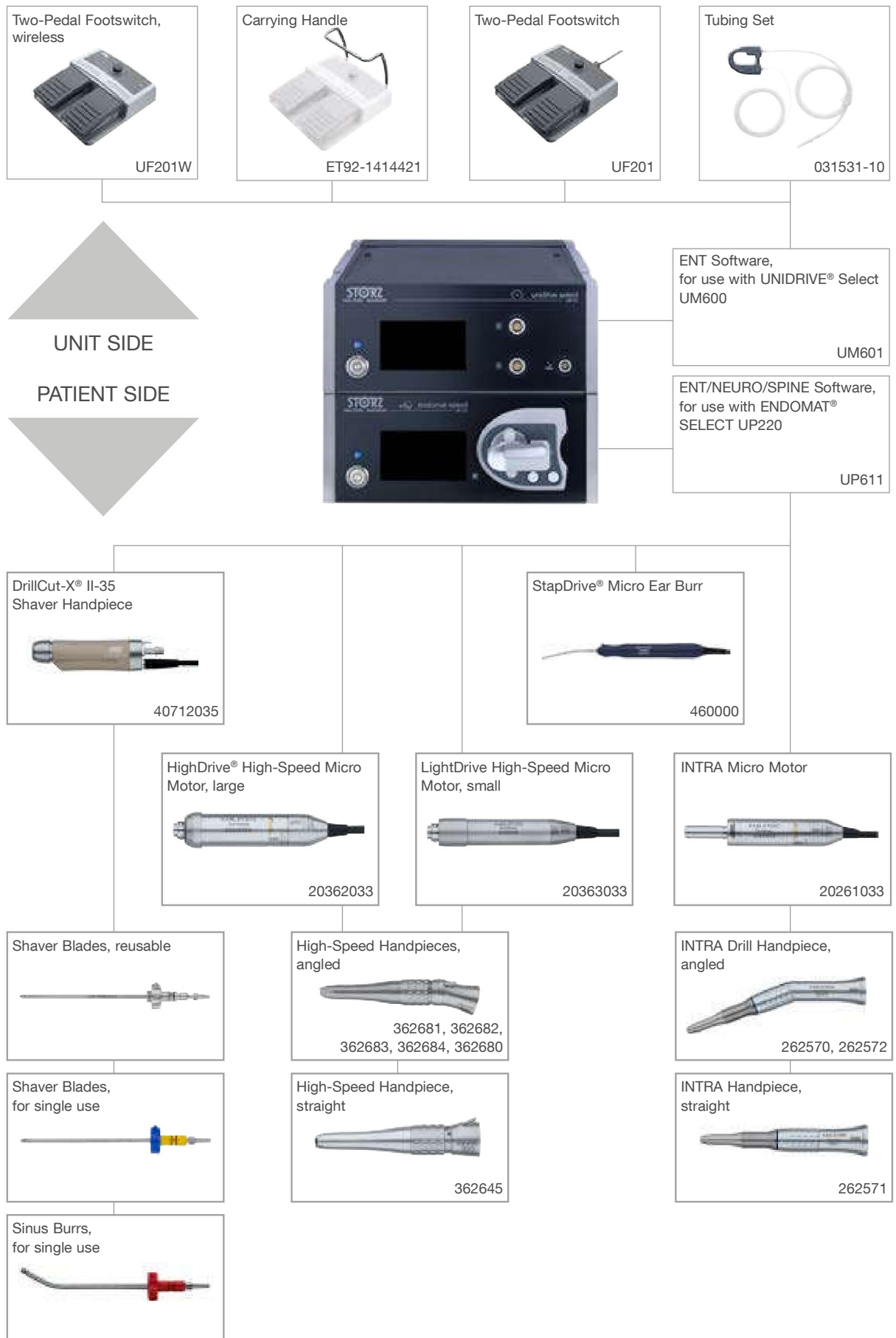

UNIDRIVE® Select



UM600

UNIDRIVE® Select, motor system with color display, touch screen, two motor outputs, power supply 100-240 VAC, 50/60 Hz

UM601

ENT Software, license, allows the use of shaver handpieces, micro ear burrs, high-speed and INTRA motors, for use with UNIDRIVE® Select UM600



UP220

EENDOMAT® SELECT, suction or irrigation pump, incl. mains cord, power supply 100-240 VAC, 50/60 Hz, with integrated unit communication via KS HIVE®

UP611

ENT/NEURO/SPINE Software, license, allows irrigation for the UNIDRIVE® Select UM600 motor system, for use with EENDOMAT® SELECT UP220



UF201

Two-Pedal Footswitch, one-stage

UF201W

Two-Pedal Footswitch, one-stage, wireless, including:
Footswitch
Receiver
Power Supply

ET92-1414421

Spare Part Kit, carrying handle (2-pedal)



031531-10

Tubing Set, irrigation, UNIDRIVE®, sterile, for single use, package of 10, for use with KARL STORZ EENDOMAT® SELECT UP220

Mobile Stands



UG803	Subrack , COR mobile stand, low
UG811	Top Cover Monitor Holder , COR mobile stand
UG823	Special Equipment Shelf , COR mobile stand
UG854	Stainless Steel Tube , COR mobile stand, length 400 mm
UG815	Equipment Rail , COR mobile stand
UG902	Footswitch Holder , for Two-Pedal HF Footswitch UF902
8404HK	Double Hook for Crossbar , height adjustable, for use with crossbar diameter 25 mm
UG891	Multiple Socket Strip Set
Optional:	
UG896	Isolation Transformer , 230 V, 600 VA
UG864	Protective Housing Isolation Transformer
UG898	Earth Leakage Monitor , 230 V, for isolation transformer
2x UG892	Special Mains Cord , length 150 cm

High-Speed Micro Motors – HighDrive® & LightDrive



20362033

HighDrive® High-Speed Micro Motor, large, max. speed 80,000 rpm, for use with UNIDRIVE® Select UM600

consisting of:

20362133 **High-Speed Micro Motor**, without cable

20362233 **Cable for High-Speed Micro Motor**, large



20363033

LightDrive High-Speed Micro Motor, small, max. speed 80,000 rpm, for use with UNIDRIVE® Select UM600

consisting of:

20363133 **High-Speed Micro Motor**, without cable

20363233 **Cable for High-Speed Micro Motor**, small

1 Beschreibung

1 Description

1 Descripción

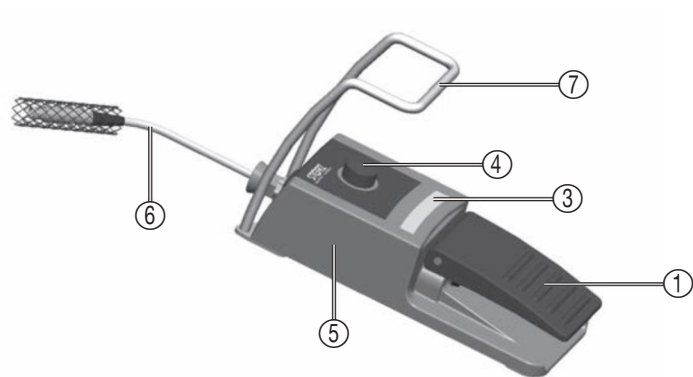

UF101 / UF102

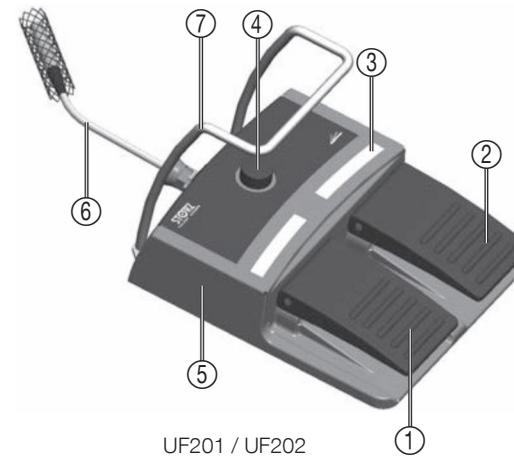

UF201 / UF202

①	Pedal S1
②	Pedal S2
③	LED-Fenster
④	Betätiger
⑤	Grundplatte
⑥	Anschlusskabel
⑦	Tragebügel (optional)

①	Pedal S1
②	Pedal S2
③	LED window
④	Actuator
⑤	Base plate
⑥	Connecting cable
⑦	Carrying handle (optional)

①	Pedal S1
②	Pedal S2
③	Ventana LED
④	Accionador
⑤	Placa de base
⑥	Cable de conexión
⑦	Asa de transporte (opcional)



Item no: 20261033

INTRA Micro Motor 80k

Quantity:



Product details

INTRA micro motor with up to 80,000 rpm

- ISO 3964 (micro) connection
- Automatic cooling prevents overheating

Technical details	Documents & Films	Product group / field of application
-------------------	-------------------	--------------------------------------

Diameter	21 mm
Weight	120 g
Maximum speed	80,000 rpm
Portfolio	INTRA
Mechanical interface	INTRA coupling (ISO 3964)

The DrillCut-X® II-35 Shaver Handpiece



40712035

DrillCut-X® II-35 Shaver Handpiece,
for use with UNIDRIVE® S III ENT/NEURO and
UNIDRIVE® SELECT



40712090

Handle, adjustable, for use with all DrillCut-X® II
shaver handpieces



41200RA

Cleaning Adaptor, LUER-Lock,
for cleaning the inner and outer blades of
DrillCut-X® accessories
consisting of:
41200RA1 **Cleaning Adaptor**, for inner blades
41200RA2 **Cleaning Adaptor**, for outer blades



41250RA

Cleaning Adaptor, LUER-Lock, for cleaning
DrillCut-X® shaver handpieces



39550A

Wire Tray, provides safe storage of accessories
for KARL STORZ paranasal sinus shaver systems
during cleaning and sterilization
For storage of:

- Up to 7 shaver attachment
- Paranasal sinus shaver handpiece
- Connecting cable



280053

Universal Spray, 6x 500 ml bottles,
- HAZARDOUS GOODS - UN 1950
consisting of:
280053B **Universal Spray**, 500 ml
280053C **Spray Nozzle**

INTRA Micro Motor 80k

INTRA Drill Handpieces 80,000 rpm, angled and straight



- 20261033** **INTRA Micro Motor 80k**, for use with UNIDRIVE® Select UM600
Included in delivery:
20261133 **INTRA Micro Motor 80k**, without cable
20261233 **INTRA Connecting Cable**



- 262570** **INTRA Drill Handpiece**, angled, 80,000 rpm, 70 mm,
for use with INTRA Micro Motor 80k 20261033 and
straight shaft burrs



- 262571** **INTRA Drill Handpiece**, straight, 80,000 rpm, 70 mm,
for use with INTRA Micro Motor 80k 20261033 and
straight shaft burrs

- Spare Part:**
ET30-1500096 **Irrigation Cannula PM**, length 70 mm, for use with 262570 and
262571



- 262572** **INTRA Drill Handpiece**, angled, 80,000 rpm, 125 mm,
for use with INTRA Micro Motor 80k 20261033 and
straight shaft burrs

- Spare Part:**
ET30-1500098 **Irrigation Cannula PM**, length 125 mm,
for use with 2625702

Specifications

Speed	4,000-80,000 rpm	Length	100 mm
Weight	120 g (without cable)	Torque	max. 40 mNm
Diameter	21 mm	Cable length	295 +/- 5 cm

Optional Accessories

for UNIDRIVE® S III ENT SCB and UNIDRIVE® S III ECO



280053 **Pana Spray**, 6x 500 ml bottles – HAZARDOUS GOODS – UN 1950
including:
Spray Nozzle

280053 C **Spray Nozzle**, for the reprocessing of INTRA burr handpieces,
for use with Pana Spray 280053 B









031131-10* **Tubing Set**, for irrigation, for single use, sterile,
package of 10









* mtp medical technical promotion gmbh,
Take-Off GewerbePark 46, 78579 Neuhausen ob Eck, Germany









Equipment Carts

Accessories

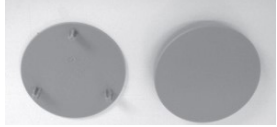
	<p>400 D Mains Cord, mains connector 90° angulated, unit connector straight, length 400 cm</p> <p>400 DM Same, length 250 cm</p>
	<p>29005 KKK Mains Cord, length 50 cm, with cold device plug and socket, with UL approval</p> <p>29005 KKM Same, length 100 cm</p> <p>29005 KKL Same, length 200 cm</p>
	<p>28003 TE Mains Cord Adaptor, for devices with European plugs, for use with Isolation Transformer 29003 TBG/TBK/TBR and 29005 TBG</p>
	<p>28003 TO Mains Cord Adaptor, for devices with fixed mains cord with shockproof plug, for use with Isolation Transformer 29003 TBG/TBK/TBR and 29005 TBG</p>
	<p>29005 KSK Mains Cord Adaptor, for devices with cold device sockets to power box with shockproof socket</p>
	<p>20 0101 70 Potential Equipotential Cable, length 10 m</p> <p>20 0102 70 Potential Equalization Cable, length 500 cm</p> <p>20 0103 70 Potential Equalization Cable, length 200 cm</p> <p>20 0105 70 Potential Equipotential Cable, length 150 cm</p> <p>20 0106 70 Potential Equipotential Cable, length 100 cm</p>
	<p>29005 PA-HNO Potential Equalization Cabling, for configuring equipment carts, including Potential Equipotential Cables 2x 20 0105 70, 1x 20 0106 70 and 1x 20 0102 70 for 3 units</p> <p>29005 PA-GI Potential Equalization Cabling, for configuring equipment carts, including Potential Equipotential Cables 3x 20 0105 70, 1x 20 0106 70 and 1x 20 0102 70 for 4 units</p> <p>29005 PA-AN Potential Equalization Cabling, for configuring equipment carts, including Potential Equipotential Cables 1x 20 0103 70 and 1x 20 0102 70 for 1 unit</p> <p>29005 PA-LAP Potential Equalization Cabling, for configuring equipment carts, including Potential Equipotential Cables 5x 20 0103 70, 2x 20 0105 70 and 1x 20 0102 70 for 7 units</p> <p>29005 PA-GU Potential Equalization Cabling, for configuring equipment carts, including Potential Equipotential Cables 4x 20 0103 70, 1x 20 0105 70 and 1x 20 0102 70 for 5 units</p>

	Art.-Nr.	Artikelbezeichnung	Maße [mm]	Gewicht [kg]
	ET21-1020	COR, T-Nut Gummi für Seitenholm	200x50x250	0,20
	ET21-1021	COR, Abdeckung Geräteschiene	330x90x25	0,10
	ET21-1022	6 fach Steckdosenleiste, Kabel lang	200x50x500	0,90
	ET21-1023	6 fach Steckdosenleiste, Kabel kurz	200x50x500	0,75
	ET21-1042	COR, 6 fach Steckdosenleiste 125 V, US		
	ET21-1024	COR, Montageset	330x90x25	0,30
	ET21-1025	COR, Schraubenset	330x90x25	0,
	ET21-1026	COR, Schlüssel für Schublade	- - -	0,10
	ET21-1030	COR, Antirutschecken	330x90x25	0,

9 Ersatzteile

	Art.-Nr.	Artikelbezeichnung	Maße [mm]	Gewicht [kg]
	ET21-1001	COR, POAG Schiene Bodenmodul	330x90x25	0,15
	ET21-1002	COR, Netzkabel 5 m	200x50x500	0,80
	ET21-1004	COR, POAG Platte Energieholm	200x50x500	0,30
	ET21-1006	COR Kunststoffabdeckung Monitoraufnahme	330x90x25	0,
	ET21-1007	COR, Rasterleiste dunkel	330x90x25	0,06
	ET21-1008	COR, Rasterleiste hell	330x90x25	0,06
	ET21-1009	COR, Service Deckel, schmal	500x430x90	1,60
	ET21-1010	COR, Service Deckel, breit	760x580x100	1,80
	ET21-1011	COR, Abdeckung mit Logo, schmal	720x580x180	3,20

[Home page](#) > [Online Catalog](#) - [Human Medicine](#)



Item no: 40712035

DRILLCUT-X II-35 Shaver Handpiece

Quantity:



Product details

DrillCut-X® II-35 shaver handpiece – Power meets precision

The DrillCut-X® II-35 handpiece achieves speeds of up to 35,000 rotations per minute, which allows rapid bone ablation during drill-intensive interventions. In addition to the drill function, the DrillCut-X® II-35 handpiece also features a shaver function.

- A handpiece for shaver blades and sinus burrs
- Compatible with sinus burrs, up to 35,000 rpm
- Compatible with shaver blades, up to 10,000 rpm
- Optional handle that can be used in various positions

Technical details	Documents & Films	Product group / field of application
-------------------	-------------------	--------------------------------------

Minimum speed	1500 rpm
Weight	371 g
Maximum speed	35,000 rpm
Portfolio	DrillCut-X® II
Mechanical interface	KARL STORZ quick-release coupling
Oscillation min.	900 rpm
Oscillation max.	10000 rpm

Accessories for Burrs

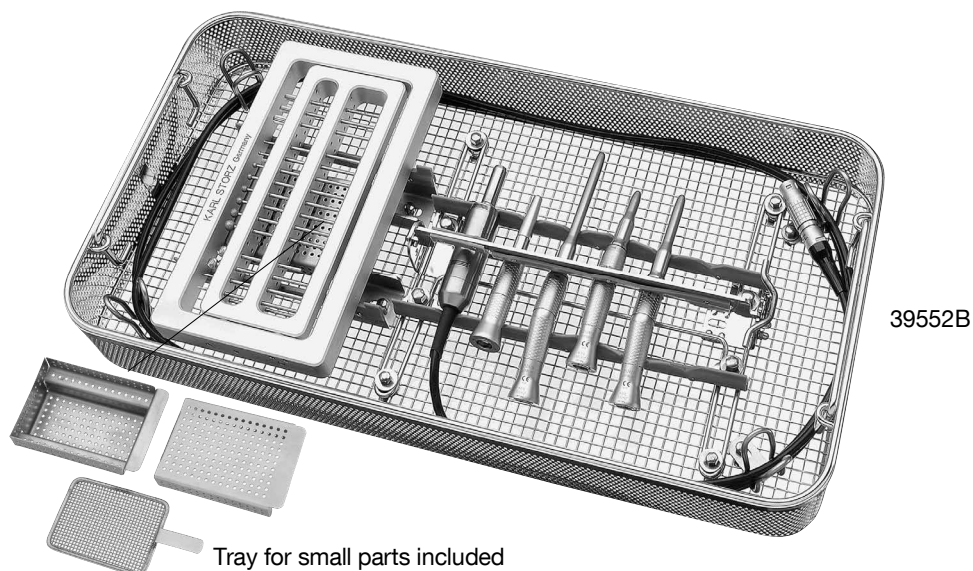

- 39552A **Wire Tray**, provides safe storage of accessories for KARL STORZ drilling/grinding systems during cleaning and sterilization, includes tray for small parts, for use with Rack 280030, rack **not** included
- for storage of:**
- Up to 6 drill handpieces
 - Connecting cable
 - EC micro motor
 - Small parts
- 39552B **Wire Tray**, provides safe storage of accessories for KARL STORZ drilling/grinding systems during cleaning and sterilization, includes tray for small parts, for use with Rack 280030, rack **included**
- for storage of:**
- Up to 6 drill handpieces
 - Connecting cable
 - EC micro motor
 - Up to 36 drill bits and burrs
 - Small parts

Please note: The instruments displayed are not included in the sterilizing and storage trays.