

Data Sheet

RAS-C² Range

Radiator Thermostats for Domestic 2-Pipe Systems

Application



RAS-C² radiator thermostats are designed for use in 2-pipe domestic heating systems.

All RAS-C² Combi Packs comprise of a RA-FS angled or straight pattern bi-directional valve and a RAS-C² sensor designed for 2-pipe heating systems.

Combi Packs are also available with a RLV-D lockshield valve. For further data on the lockshield valve please see separate RLV-D data sheet.

The valves have a 1/2" BSP (R1/2") tail piece connection to the radiator and are available with 15mm, 10mm or 8mm compression fitting or an elbow with 10mm push-fit fitting to connect the valve to the pipe work.

The valve bodies are reversible and bi-directional and include a flow-selectable feature to ensure trouble free installation without any risk of water hammer. For optimum performance, Danfoss recommend the sensor be mounted horizontal where at all possible.

The valve is supplied with a protective cap, which can be used for manual regulation during the construction phase. The cap must not be used as a manual shut of device.

RAS-C² sensors incorporate a "Frost Protection" setting and a "Positive Off" feature for maximum user flexibility. Temperature range is from 8°C to 28°C.

System

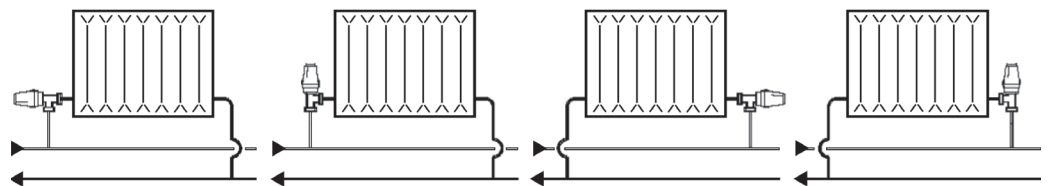













Data Sheet

RAS-C² Range - Radiator Thermostats for Domestic 2-Pipe Systems

Ordering Details

Valve bodies and RAS-C² thermostatic sensors supplied complete in Combi-pack form

Symbol	Type	Comprising	Temp. range °C, Xp = 2 K	Code No.
	RAS-C ² Combi 6050	15 mm angle valve body and thermostatic sensor	8-28	013G6050
	RAS-C ² Combi 6055	10 mm angle valve body and thermostatic sensor	8-28	013G6055
	RAS-C ² Combi 6058	8 mm angle valve body and thermostatic sensor	8-28	013G6058
	RAS-C ² Combi 6060	Angle valve body, RAS-C ² thermostatic sensor and elbow with 10 mm push-fit fitting	8-28	013G6060
	RAS-C ² Combi 6005	15 mm angle valve body, lockshield valve and thermostatic sensor	8-28	013G6005
	RAS-C ² Combi 6006	10 mm angle valve body, lockshield valve and thermostatic sensor	8-28	013G6006
	RAS-C ² Combi 6008	8 mm angle valve body, lockshield valve and thermostatic sensor	8-28	013G6008
	RAS-C ² Combi 6007	Angle valve body, lockshield valve, thermostatic sensor and elbows with 10 mm push-fit fitting	8-28	013G6007
	RAS-C ² Combi Pack	15 mm bi-directional straight valve body and thermostatic sensor, 8/10/15 mm fittings	8-28	013G6051
	RAS-C ² Combi Pack	8/10 mm bi-directional straight valve body and thermostatic sensor, 8/10/15 mm fittings	8-28	013G6056
	RAS-C ² Radiator Pack	15 mm bi-directional straight valve body, lockshield valve, thermostatic sensor, 8/10/15 mm fittings	8-28	013G6003
	RAS-C ² Radiator Pack	8/10 mm bi-directional straight valve body, lockshield valve, thermostatic sensor, 8/10/15 mm fittings	8-28	013G6004

RAS-C² sensors supplied in a separate box

Type	Sensor (Max. sensor temperature 60°C)	Temp. range °C (Xp = 2 K)	Code No.
RAS-C ²	Built-in (includes positive shut-off)	8 - 28	013G6040

Data Sheet

RAS-C² Range - Radiator Thermostats for Domestic 2-Pipe Systems

Specification

RA-FS angle valves supplied in separate boxes

Type	Design	Connection		k _v -value (m ³ /h at Δp = 1 bar), P-band (K)					Max. pressure			Max. temp. °C	Code No.
		Inlet	Outlet	0.5	1.0	2.0	3.0	k _{vs}	Work. press.	Diff. press.	Test press.		
									bar	bar	bar		
RA-FS 15 ^{1) 3)}	Rev. Angle	15 mm	1/2" BSP	0.13	0.27	0.50	0.64	0.73	10	0.6	16	120	013G6281
	Rev. Angle	8/10 mm	1/2" BSP										013G6283
RA-FS 15 ³⁾ with pushfit elbow	Rev. Angle	10 mm	1/2" BSP						3	0.6	6	92	

¹⁾ RA-FS valves must only be used with RAS-C² or RAS-D sensors.

²⁾ As with any device which imposes a pressure drop in the system, noise may occur under certain flow/pressure conditions. To ensure quiet operation, maximum pressure drop should not exceed 45 kPa (0.45 bar). The differential pressure can be reduced using Danfoss automatic by-pass valve AVDO.

³⁾ Only available in Combi packs.

The push-fit fitting is suitable for 10 mm copper pipes manufactured in accordance to BS 2871 part 1 / BS EN 1057 : 1996 and suitable for 10 mm polybuthelene (PB) including Hep₂O, Polyplumb, OsmaGold and 10 mm cross linked polyethylene (PEX) pipes made in accordance to BS 7291 part 1 : 1990 or part 3 : 1990.

Always use plastic pipe inserts of the same brand as the pipe used.

Approved to EN 215



All Danfoss RAS-C² sensors and RA-FS valves are manufactured to the highest standards and are approved to the European standard EN 215, which supersedes BS 6284, 1983.

Quality Standards

All Danfoss radiator thermostats and valves are manufactured in factories, assessed and certified by BSI against ISO 9001 / BS 5750.

Data Sheet

RAS-C² Range - Radiator Thermostats for Domestic 2-Pipe Systems

Capacities

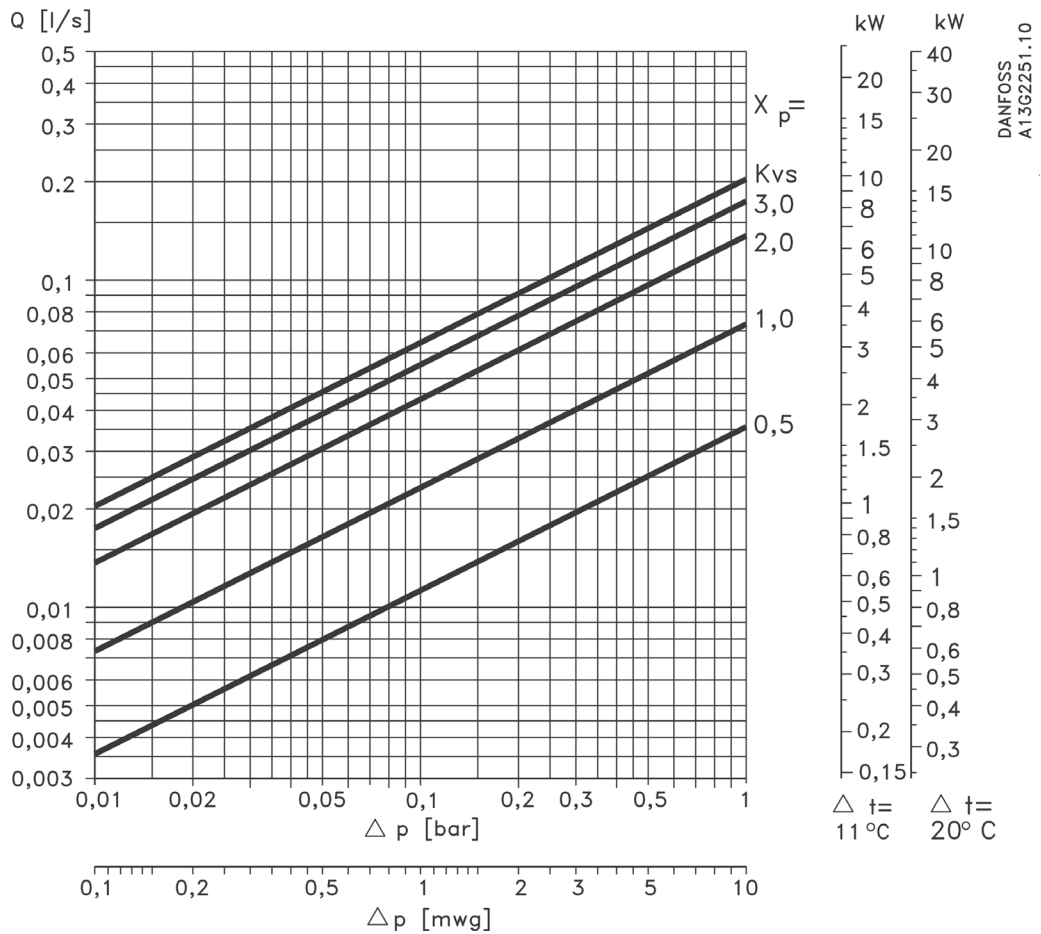

All RAS-C² Combi: capacity with P-band between 0.5K and 3K

Construction

1. Actuator
2. Setting dial
3. Safety spring
4. Gland seal
5. Pressure pin
6. Securing union nut
7. Spindle
8. Bi-directional valve cone
9. Revolver
10. Valve body

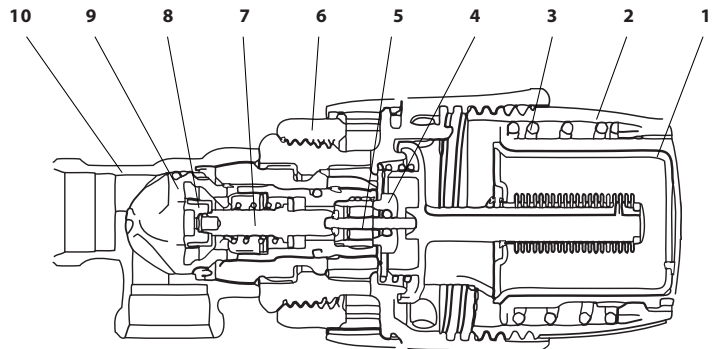

Water in the heating system must be in accordance with the British Standard "Code of Practise". Should water treatment be used it is essential that dosing of the manufacturer are strictly observed. It is recommended that formulations containing mineral oil are avoided.

Valve Setting

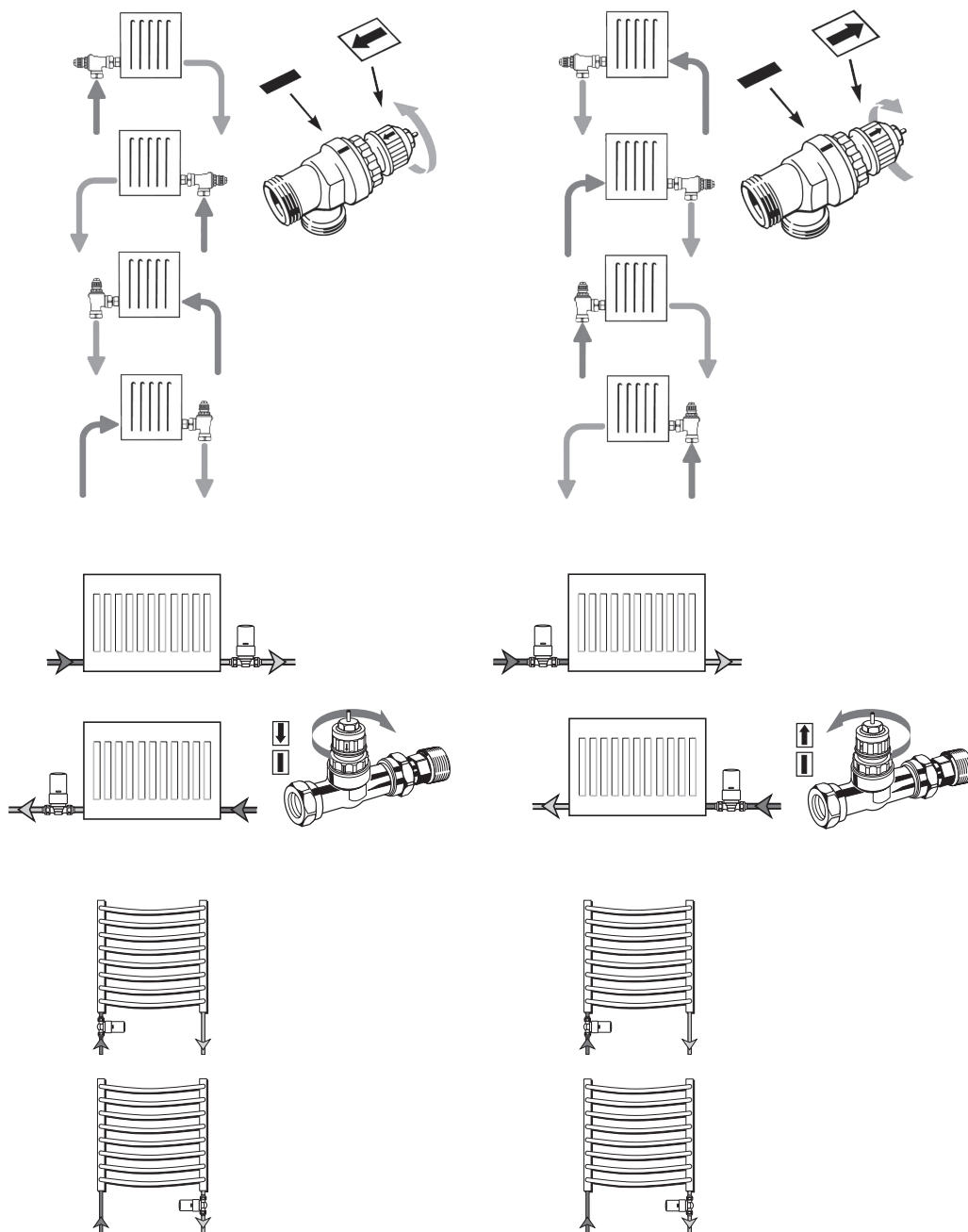
**Commissioning the valve**

The valve is a bi-directional valve with a flow direction selection feature. This feature does not have to be used, although we recommend that it is set during system commissioning.

- Establish the flow direction through the valve using the diagrams above, turning the setting ring as necessary to ensure that water flow through the valve is always in the correct direction and the risk of water hammer is eliminated.
- If the flow direction needs to be changed there is no need to remove the valve, simply turn the setting ring.

Data Sheet

RAS-C² Range - Radiator Thermostats for Domestic 2-Pipe Systems

Dimensions

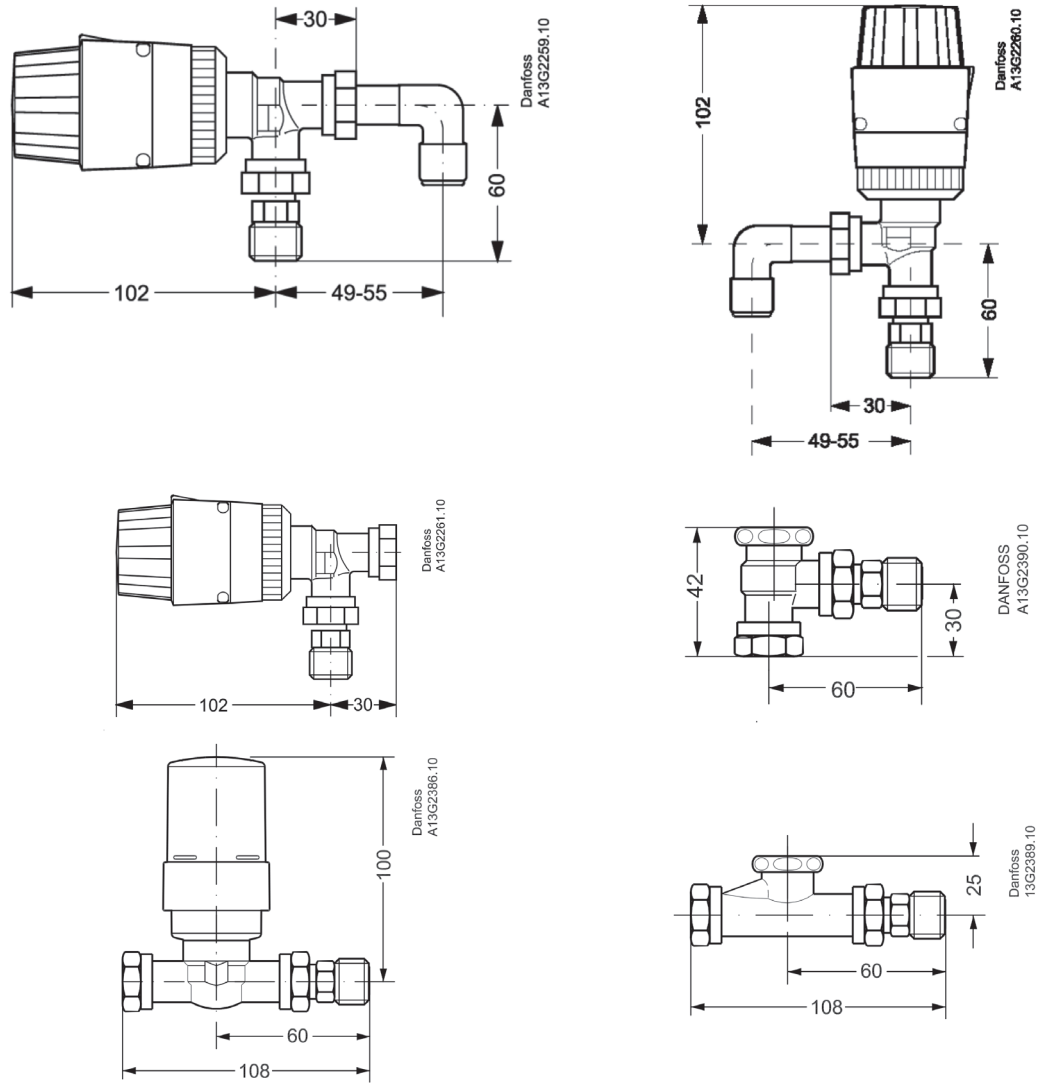



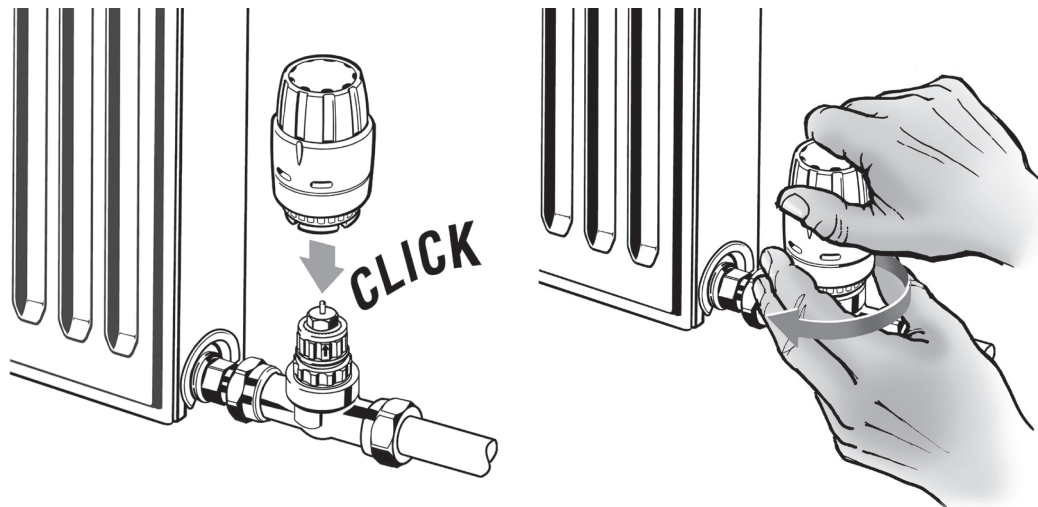

Add 32 mm to allow for sensor removal/fitting

Sensor Mounting



Data Sheet**RAS-C² Range - Radiator Thermostats for Domestic 2-Pipe Systems****Accessories**

Symbol	Description	Code No.
	RA 2000 gland seals (sold in boxes of 10)	013G0290
	Blanking cap (sold singly)	013G5001
	Collet cover for push-fit connection (10pcs.)	013G4912
	Collet clip for push-fit connection (10pcs.)	013G4913

**Danfoss A/S**

Heating Segment • heating.danfoss.com • +45 7488 2222 • E-Mail: heating@danfoss.com

Danfoss can accept no responsibility for possible errors in catalogues, brochures and other printed material. Danfoss reserves the right to alter its products without notice. This also applies to products already on order provided that such alterations can be made without subsequential changes being necessary in specifications already agreed. All trademarks in this material are property of the respective companies. Danfoss and all Danfoss logotypes are trademarks of Danfoss A/S. All rights reserved.
