

OPERATING MANUAL ELECTROSURGICAL UNIT



BOWA
4000

Contents

1.	Using this operating manual	9
1.1.	Revision index.....	9
1.2.	Validity.....	9
1.3.	Other applicable documents	9
1.4.	Icons and labeling	9
1.4.1.	Structure of warning instructions	9
1.4.2.	Risk levels in warning instructions.....	10
1.4.3.	Tips	10
1.4.4.	Other symbols and marks.....	10
2.	Safety.....	11
2.1.	Intended use	11
2.2.	General safety instructions	12
2.3.	Personal safety instructions	13
2.3.1.	Ambient conditions	13
2.3.2.	Patients with pacemakers.....	13
2.3.3.	Hazard-free patient positioning	14
2.3.4.	Correct connection of the HF device	14
2.3.5.	Correct use of the HF device.....	14
2.3.6.	Configuring HF device settings and using accessories.....	15
2.4.	Product-related safety instructions	16
2.5.	Safe handling (general instructions)	16
2.5.1.	Operation area: avoiding ignition and explosions.....	17
2.5.2.	Applying the neutral electrode	17
3.	Description.....	20
3.1.	User interface components	20
3.1.1.	Front panel user interface components	20
3.1.2.	Monopolar connector module (left).....	20
3.1.3.	Bipolar connector module (right)	21
3.1.4.	Rear panel user interface components	22
3.2.	Symbols used on the device	23
3.2.1.	Nameplate	24
3.3.	Scope of delivery	24
3.4.	Components required for operation	25
3.4.1.	OR1 Storz.....	25

3.4.2.	MAQUET TEGRIS:.....	27
3.5.	Operating conditions	28
3.6.	The basis of modern HF surgery	29
4.	Prearrangement.....	30
4.1.	Setting up the HF device.....	30
4.2.	Switching on the HF device	31
4.3.	Connecting instruments	32
4.3.1.	Instruments for monopolar use.....	33
4.3.2.	Instruments for bipolar applications.....	33
4.3.3.	Connecting a foot switch	33
4.4.	Functional test.....	34
4.4.1.	Auto test function.....	34
4.4.2.	Functional testing	34
4.4.3.	Actions in case of problems.....	35
4.5.	Neutral electrode monitoring.....	35
4.5.1.	General information	35
4.5.2.	EASY neutral electrode monitoring (EASY monitoring).....	36
4.6.	Turning the device off	37
5.	Operation.....	38
5.1.	Program overview	38
5.1.1.	Display	38
5.1.2.	Status bar	38
5.2.	Activating and deactivating connectors	39
5.3.	Unlocking the screen	40
5.4.	Configuring output currents.....	41
5.4.1.	Selecting the mode.....	41
5.4.2.	Specifying power limits	42
5.4.3.	Selecting the effect	43
5.4.4.	Assigning the foot pedal	44
5.4.5.	Selecting the neutral electrode	47
5.4.6.	Dr. Dongle®.....	49
5.4.7.	Plug'n Cut COMFORT	51
5.4.8.	Playing videos	52
5.4.9.	Configuring the startup screen	53
5.5.	Mode overview	54
5.5.1.	Monopolar modes.....	54

5.5.2.	Bipolar modes.....	56
5.6.	Monopolar cutting modes.....	58
5.6.1.	Standard	58
5.6.2.	Micro	58
5.6.3.	Dry	59
5.6.4.	Argon	59
5.6.5.	Resection.....	60
5.6.6.	MetraLOOP	60
5.6.7.	Laparoscopy	61
5.6.8.	GastroLOOP 1	61
5.6.9.	GastroLOOP 2.....	62
5.6.10.	GastroLOOP 3.....	62
5.6.11.	GastroKNIFE 1	63
5.6.12.	GastroKNIFE 2	63
5.6.13.	GastroKNIFE 3	64
5.7.	Monopolar coagulation modes.....	64
5.7.1.	Moderate.....	64
5.7.2.	Forced non cutting.....	65
5.7.3.	Forced mixed	65
5.7.4.	Forced cutting	66
5.7.5.	Spray	66
5.7.6.	Argon	67
5.7.7.	Argon flexible	67
5.7.8.	Argon flex. pulse.....	68
5.7.9.	Resection.....	68
5.7.10.	Cardiac Mammary	69
5.7.11.	Cardiac Thorax	69
5.7.12.	SimCoag.....	70
5.7.13.	Gastro Coag	70
5.7.14.	Laparoscopy	71
5.8.	Bipolar cutting modes	71
5.8.1.	Standard	71
5.8.2.	Bipolar resection (optional).....	72
5.8.3.	Bipolar scissors	72
5.8.4.	Vaporisation.....	73
5.9.	Bipolar coagulation modes.....	73
5.9.1.	Standard forceps	73

5.9.2.	Standard forceps AUTO	74
5.9.3.	Micro forceps	74
5.9.4.	Forceps forced.....	75
5.9.5.	LIGATION (optional).....	75
5.9.6.	TissueSeal PLUS (optional)	76
5.9.7.	Bipolar scissors	76
5.9.8.	Laparoscopy	77
5.9.9.	Laparoscopy Micro	77
5.9.10.	Bipolar resection (optional).....	78
5.9.11.	Vaporisation (optional).....	79
5.9.12.	Bipolar SimCoag (optional).....	79
5.10.	Menu dialogs.....	80
5.10.1.	Overview.....	80
5.10.2.	"System Settings" dialog	81
5.10.3.	"Volume" dialog	82
5.10.4.	"Service" dialog	83
5.10.5.	"System information" dialog.....	85
5.10.6.	"Select program" dialog	85
5.10.7.	"Favourites" dialog.....	87
5.10.8.	"Save Program" dialog	87
5.10.9.	Socket extension	88
5.10.10.	ZAP Mode.....	89
5.10.11.	"System messages" dialog.....	92
5.10.12.	"Argon" dialog	93
5.11.	Basic programs	94
6.	Detecting and correcting faults	100
6.1.	System information	100
6.2.	Fault indications for EASY monitoring	106
7.	Preparation.....	107
7.1.	Preparation of the accessories	107
7.2.	Disinfection and cleaning	107
8.	Maintenance and repair	108
8.1.	Maintenance	108
8.1.1.	Safety inspection	108
8.2.	Repairs.....	109
9.	Storage	110
9.1.	Technical service	110

10. Technical specifications	111
10.1. ARC 400 technical data (REF 900-400)	111
10.2. Output, voltage and current diagrams	121
11. Accessories and replacement parts	159
12. EMC	160
12.1. Guidelines and manufacturer's declaration in accordance with IEC 60601-1-2:2007	160
13. Disposal	164

1. Using this operating manual

This operating manual is part of the device.

BOWA-electronic GmbH & Co. KG, referred to in the following simply as BOWA, assume no liability nor provide any warranty whatsoever for damage and consequential damages that arise due to non-compliance with the operating manual.

Read the operating manual carefully and thoroughly before using this device.

Store the operating manual in a safe place throughout the service life of the device.

Keep the operating manual accessible to operating room personnel.

Give the operating manual to each successive owner and/or user of this device.

Always update the operating manual whenever you receive additional information from the manufacturer.

1.1. Revision index

Unit version	Last revised
Valid from version 2.1.0	2016/05

1.2. Validity

This operating manual applies only to the devices designated in chapter 3.2.1 Nameplate (see page 24).

1.3. Other applicable documents

Comply with other applicable documents in the appendix or in the other sections.

1.4. Icons and labeling

1.4.1. Structure of warning instructions



SIGNAL WORD

"Risk type, source and consequences there of" (Personal injury)!

▶ Measure for risk prevention.







NOTE

"Risk type, source and consequences there of" (Property damage)!

▶ Measure.

1.4.2. Risk levels in warning instructions







Symbol	Risk level	Probability of occurrence	Consequences of non-compliance
	DANGER	Immediate risk	Death, serious injuries
	WARNING	Possible risk	Death, serious injuries
	CAUTION	Possible risk	Minor injuries
	NOTE	Possible risk	Property damage

1.4.3. Tips



Tips and additional information to facilitate tasks

1.4.4. Other symbols and marks

Symbol or mark	Meaning
	Prerequisite for an activity
	Activity with one step
	Activity with several steps in a binding sequence
	Result of preceding activity
	List (first level)
	List (second level)
Emphasis	Emphasis
....., see Section xxx, page xxx	Cross reference

2. Safety

2.1. Intended use

The HF device is intended exclusively for the generation of electrical power for monopolar and bipolar cutting and coagulation on tissue structures in surgical operations.

It is used in the following areas:

- General surgery
- Endoscopy (GastroCut mode)
- Gynecology
- Hand surgery
- ENT
- Cardiac surgery (including open-heart surgery)
- Neurosurgery
- Pediatric surgery
- Plastic surgery and dermatology
- Thoracic surgery
- Orthopedics
- Urology, including transurethral resection (TUR)

Do not use the HF device if, in the opinion of an experienced physician or according to current professional literature, such use would endanger the patient, due for example to the general condition of the patient, or if other contraindications are present.



BOWA requires that the HF device is operated under the supervision of qualified and authorized personnel. The surgeon and medical staff must be trained in the fundamental principles, rules for use and risks of HF surgery and must be familiar with these in order to safely and reliably prevent putting patients, staff and equipment at risk. Contact your BOWA distributor for trainings and training material.



Any other use is neither intended nor proper and must be effectively prevented.



When setting up the HF device, ensure easy access to the power cable so it can be disconnected from the device.
(IEC 60601-1:2012, Section 7.9.2.7)

2.2. General safety instructions

- ▶ Ensure that no electronic devices that are subject to interference from electromagnetic fields are set up in the vicinity of the HF device.
- ▶ Observe the instructions on electromagnetic compatibility provided in section EMC, page 159.
- ▶ Always connect the HF device to a mains power system with a protective earth lead in order to prevent electric shock.

Additional devices that are connected to electrical medical devices must satisfy relevant IEC or ISO standards (e.g. IEC 60950 for data processing devices). Furthermore, all configurations must comply with the standardised requirements for medical systems (see IEC 60601-1-1 or Section 16 of the 3rd edition of IEC 60601-1 as relevant). Anyone who connects additional devices to electrical medical devices is automatically a system configurator and thus responsible for meeting standardised system requirements. Please note that local laws prevail over the aforementioned standard requirements. In case of questions, please contact your local dealer or Technical Service, see section Technical service, page 109.



To protect personnel, BOWA recommends the use of a smoke evacuator to extract electrosurgical smoke, e.g. BOWA SHE SHA. (IEC 60601-2-2:2009; section 201.7.9.2.15)

2.3. Personal safety instructions

2.3.1. Ambient conditions

- ▶ Do not use the HF device in the immediate vicinity of the patient. Observe the minimum distances recommended by BOWA, as shown in the following figure.

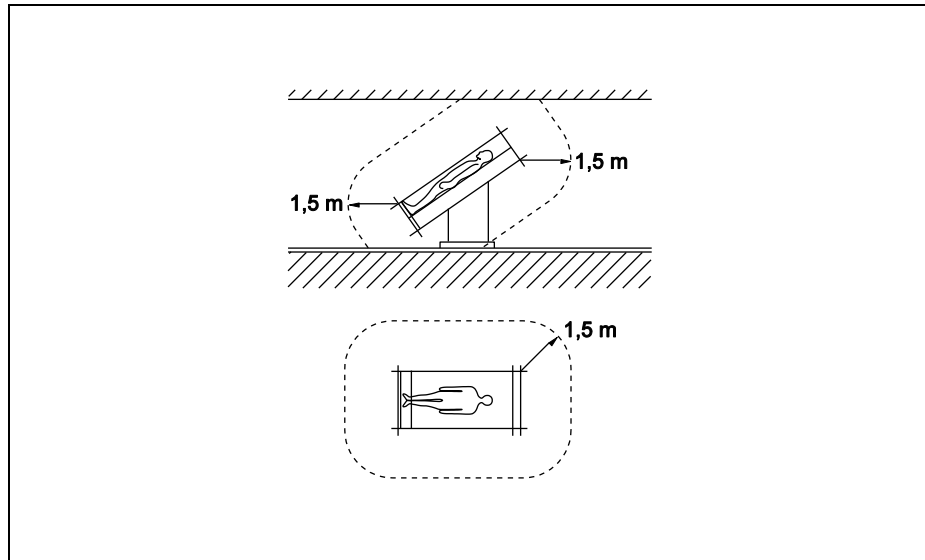

2.3.2. Patients with pacemakers

Malfunction or destruction of the pacemaker can endanger the life of the patient or result in irreversible injuries to the patient.

- ▶ In the case of patients with pacemakers, consult the cardiologist before carrying out HF surgery.
- ▶ Use bipolar HF methods.
- ▶ Attach the HF neutral electrode close to the operating field.
- ▶ Set the demand pacemaker to a fixed frequency.
- ▶ Ensure that the pacemaker does not come into contact with the HF electrode.
- ▶ Keep a fully operational defibrillator within reach.
- ▶ Carry out a postoperative pacemaker check.

2.3.3. Hazard-free patient positioning

- ▶ Position patients so that they are not touching any metal parts that are grounded or have considerable capacitance relative to ground (e.g. operating table brackets). If necessary, place anti-static cloths between the patient and the bedding.
- ▶ Ensure that the patient does not touch any wet clothes or bedding.
- ▶ Place anti-static cloths between areas with heavy sweating and skin-to-skin contact areas on the patient's torso.
- ▶ Ensure that the patient is resting on a suitable surface in order to prevent pressure necrosis.
- ▶ Drain urine via a catheter.

2.3.4. Correct connection of the HF device

- ▶ Always ground the HF device to the equipotential rail. Also observe the requirements in Section 8.6.7 of IEC 60601-1 regarding medical electrical systems.
- ▶ Do not use needle electrodes for monitoring.
- ▶ Attach electrodes of physiological monitoring devices without protective resistors or HF chokes as far away from the HF electrodes as possible.
- ▶ In all cases, monitoring systems containing devices to limit the high-frequency current are recommended.
- ▶ Place lines from monitoring devices so that they do not lie on the patient's skin.
- ▶ Keep the leads to the HF electrodes as short as possible and position them so that they do not touch the patient or other leads.
- ▶ Do not place any objects on the HF device.

2.3.5. Correct use of the HF device

Inadvertent activation of the HF device outside the user's field of vision can injure the patient.

- ▶ Activate the HF device only when the electrode is in your field of vision and you can quickly deactivate the HF device at all times.
- ▶ If the HF device is activated inadvertently, switch it off immediately using the on/off switch.
- ▶ Take particular care when using a foot switch or manual switch.

Improper preparation, user errors or faults in the HF device can cause damage to the HF device.

- ▶ Use the automatic monitoring functions to ensure that the HF device is working properly. See Section Functional testing, page 33 for information on the auto test functions.
- ▶ Ensure that no conductive fluids (e.g. blood or amniotic fluid) have penetrated the foot switch or the manual switch.
- ▶ Ensure that the cables for the foot switch and the manual switch are free from short circuits and broken leads.

For patient protection, avoid touching the patient and any of the following parts at the same time:

- ▶ exposed contacts of plug-and-socket connectors;
- ▶ contacts of fuse holders that are accessible during fuse replacement;
- ▶ contacts of lamp sockets that are accessible when the lamp is removed;
- ▶ parts inside an access cover,
 - which can be opened without using tools or
 - where a tool is necessary but the use instructions instruct any operator who is not a member of maintenance staff to open the cover concerned.

2.3.6. Configuring HF device settings and using accessories

“An obviously low output value or functional failure of the HF surgical device in normal operation may be caused by insufficient skin contact of the neutral electrode or insufficient contact with its connecting cables.”

Therefore, before you increase the output power, ensure that:

- the neutral electrode is attached properly;
- the working electrodes are clean;
- the plug connections are all correct.

Setting the HF device correctly

- ▶ To prevent inadvertent (thermal) tissue damage during operations on body parts with small cross sections and in areas with high resistance (bones or joints), use the bipolar method in these areas.
- ▶ Set the level of the acoustic signal that sounds when the electrode is activated so that it is always clearly audible.

Risk of nerve or muscle excitation by low-frequency currents!

During HF surgical operations (especially when an arc is formed), part of the HF current is converted into a low-frequency current. This current can trigger muscle contractions in the patient.

- ▶ To minimize the risk of injury to the patient, set the power and the effect as low as possible.

Correct use of accessories

- ▶ Use only insulated accessories.
- ▶ Check all electrodes for sharp edges and projecting parts before use.
- ▶ Use only electrodes that are free of defects and in good working order.
- ▶ Never place active electrodes on or near the patient.
- ▶ Do not remove hot electrodes from the patient's body directly after cutting or coagulation.
- ▶ Ensure that there is sufficient distance between the patient cables and the cables of the HF device.
- ▶ Do not run the patient cable across the patient.

2.4. Product-related safety instructions

Devices manufactured by BOWA are developed in accordance with the current state of technology and generally accepted safety rules. Despite this, using these products can lead to risks to the life and health of the user or third parties and/or damage to the device or other objects.

- ▶ Use only accessories approved by BOWA, see Accessories and replacement parts, page 158.
- ▶ Use the device only when it is free of technical defects and in good working order and only for the intended purpose, always remaining aware of safety requirements and risks and complying with this operating manual.
- ▶ Have malfunctions that can adversely affect safety (e.g. deviations from the permissible operating conditions) repaired without delay.
- ▶ Wipe down the HF device only with cleaning agents and disinfectants that are approved in the country of use for surface cleaning. See Section Disinfection and cleaning, page 106.
- ▶ Never immerse the device in water or cleaning agents.
- ▶ Never boil the device and never disinfect it mechanically.
- ▶ If any fluids penetrate the device, drain them immediately.

Damage to the device can lead to an undesirable increase in output power due to improper operation of the device.

Certain units or accessories can cause danger in lower power settings. For example, the risk of gas embolism in argon assisted coagulation rises, if the hf-power is insufficient for the fast creation of an impenetrable eschar layer on the target tissue.

2.5. Safe handling (general instructions)

- ▶ Before each use of the device, check to ensure that it is functioning properly and is in good working order and connected properly.
- ▶ Observe the instructions on intended use in conformance with standards (see Section Fault indications for EASY monitoring , page 105).
- ▶ During use, always observe and comply with the acoustic signals and/or error messages of the HF device (see Section Fault indications for EASY monitoring , page 105).
- ▶ The device and accessories may be operated and used only by people who have the necessary training, knowledge and experience.
- ▶ Regularly inspect the accessories, especially the electrode cables, endoscopic accessories and neutral electrodes, for damage to the insulation, proper operation and expiration date.
- ▶ Instruments must not be laid upon the patient or devices.
- ▶ Ensure that no instruments are being cleaned when AUTOSTART is activated.
- ▶ Wear suitable gloves during operations.

2.5.1. Operation area: avoiding ignition and explosions

Sparks are generated when the HF device is used as intended.

- ▶ Do not use the HF device in areas where there is a risk of explosion.
- ▶ Do not use any flammable or explosive liquids.
- ▶ If the display fails, do not use the HF device any longer.
- ▶ During operations (e.g. in the head or thoracic regions), avoid using ignitable anaesthetics and gases that support combustion (e.g. nitrous oxide or oxygen) or extract them using a vacuum system.
- ▶ Use exclusively non-flammable cleaning agents, disinfectants and solvents (for adhesives). If you use flammable cleaning agents, disinfectants or solvents, ensure that they have fully evaporated before using HF surgical equipment.
- ▶ Ensure that no flammable liquids collect beneath the patient or in body cavities (e.g. the vagina). Suction and/or flush body cavities before activating the device.
- ▶ Wipe off all liquids before using the HF device.
- ▶ Ensure that no ignitable endogenous gases are present.
- ▶ Ensure that all materials saturated with oxygen (e.g. cotton or gauze) are kept far enough away from the HF environment that they cannot ignite.

2.5.2. Applying the neutral electrode



Observe the instructions on the use of the neutral electrode in the user guide and the information on the package of the neutral electrode.

In the monopolar HF method, the neutral electrode feeds the current introduced into the patient's body at the surgical site back to the HF device.

- ▶ To prevent a rise in temperature at the current exit point, the following conditions must be ensured:
 - sufficiently large contact surface between the neutral electrode and the patient's body;
 - high electrical conductivity between the neutral electrode and the patient's body.

- ▶ To prevent the patient being burned by the neutral electrode, you must comply with the following conditions:
 - Select the application point for the neutral electrode so that the current paths between the active and neutral electrodes are as short as possible and run longitudinally or diagonally through the patient's body (because muscles are more conductive in the direction of the fibrils).

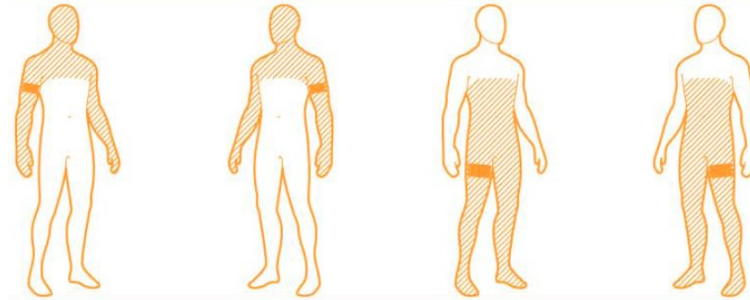

Figure 2-1: Application point of neutral electrode

- For surgery in the thoracic region, do not run the current path transversely across the patient's body and ensure that the patient's heart is never in the current path.
- Depending on the surgical site, apply the neutral electrode to the nearest upper arm or thigh if possible, but never closer than 20 cm.
- In the case of self-adhesive disposable electrodes, comply with any further manufacturer instructions regarding the point of application.
- Ensure that the application area is free of scar tissue, bony protuberances, surface hair and ECG electrodes.
- Ensure that there are no implants (e.g. bone nails, bone plates or endoprostheses) in the current path.
- Ensure that no short circuits can occur at the neutral electrode connection.
- Avoid areas where fluids may collect.
- Use split neutral electrodes with a sufficiently large surface area (patient age and max. output power during operation have to be considered).

Before applying the neutral electrode

- ▶ Shave the area where the neutral electrode will be applied.
- ▶ Clean the application site, but do not use any alcohol, since it dries out the skin and increases the contact resistance.
- ▶ If the patient has poor circulation, massage or brush the application site.

- ▶ Attach the neutral electrode over the entire contact surface evenly. Secure reusable neutral electrodes with rubber bands or elastic straps so that they do not loosen when the patient moves. Ensure that the patient's circulation is not impaired (risk of necrosis).
- ▶ Never use wet clothes or conductive pastes.
- ▶ Ensure that no liquids (e.g. cleaning fluids, disinfectants, blood or urine) penetrate between the patient and the neutral electrode.
- ▶ Do not place the neutral electrode under the patient's buttocks or back.
- ▶ Ensure that there are no ECG electrodes in the current path of the HF device.
- ▶ Check the neutral electrode before and after use for damage and to ensure that they are working properly.
Replace defective accessories immediately

Example application using a disposable electrode

- ▶ Remove the protective film and attach the self-adhesive disposable electrode to the patient. Ensure that the long edge of the disposable electrode faces the operation site and the electrode is fully in contact with the skin. This avoids excessive current concentration on the short edge.
- ▶ Using both hands, press the self-adhesive disposable electrode firmly against the patient's skin.
- ▶ Clamp the electrode tab to the neutral electrode cable.
- ▶ After the operation, remove the disposable electrode carefully to avoid skin damage.

With a one-piece neutral electrode

- ▶ Check the one-piece neutral electrode during surgery.
- ▶ Ensure that the one-piece electrode is not blocked at the device.

With a split neutral electrode

- ▶ Apply the split neutral electrode correctly and without any additional objects, as otherwise the HF device may detect a path between the two sections due to other objects.
- ▶ See that the current flows equally to both parts of the split neutral electrode.
- ▶ When the EASY indicator is illuminated yellow, heating at the current exit point may be present depending on the indication.



See Section EASY neutral electrode monitoring (EASY monitoring) , page 35 regarding monitoring of the neutral electrode.

3. Description

3.1. User interface components

3.1.1. Front panel user interface components



- 1 On/-Off button
- 2 "On/-Off button" icon
- 3 Neutral electrode isolated from ground for HF
- 4 Symbol "Defibrillation-proof type CF applied part"
- 5 Symbol "Observe instructions for use"
- 6 Touchscreen with mode selection buttons
- 7 Activation bar upper monopolar socket
- 8 Activation bar lower monopolar socket
- 9 Activation bar upper bipolar socket
- 10 Activation bar lower bipolar socket



While activating an instrument, the activation bar of the corresponding socket illuminates yellow or blue.

3.1.2. Monopolar connector module (left)

- 11 Socket connector for monopolar instruments with hand or foot switch*
- 12 Socket connector for monopolar instruments with hand or foot switch*
- 13 Socket connector for neutral electrode *

* Applied part type CF according to IEC 60601-1

Monopolar connection socket



Version 1

- 14** 3-pin US type
- 15** Bovie connector (for foot switch)
- 16** 4-mm socket (for foot switch)

Version 2

- 14** 3-pin US type
- 15** Erbe 5 mm
- 16** 4-mm socket (for foot switch)

Connection socket for neutral electrode

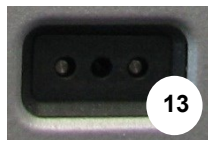

- 13** Neutral (US type)

3.1.3. Bipolar connector module (right)

- 17** Socket connector for bipolar instruments with foot switch, finger switch or AUTOSTART*
- 18** Socket connector for bipolar instruments with foot switch, finger switch or AUTOSTART*

Bipolar connection sockets

Upper bipolar socket:



- 19** 2-pin US type (28.58 mm)
- 20** 1 x Erbe VIO/ICC

Lower bipolar socket:



- 19** 2-pin US type (28.58 mm)
- 20** 2 x Erbe VIO/ICC

* Applied part type CF according to IEC 60601-1

3.1.4. Rear panel user interface components

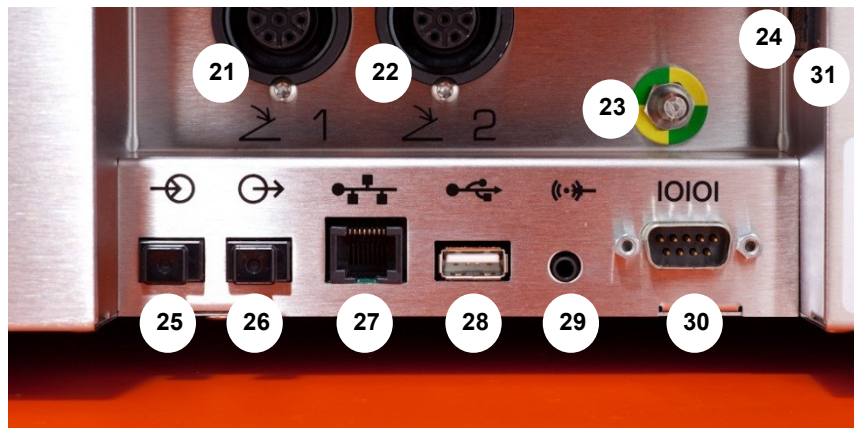

- 21 Foot switch socket connector 1
- 22 Foot switch socket connector 2
- 23 Equipotential bonding terminal
- 24 IEC power cord connector
- 25 Fiber-optic signal input socket connector
- 26 Fiber-optic signal output socket connector
- 27 Ethernet connector
- 31 Power switch

Use the following connections only for service and training purposes:

























- 28 USB connector
- 29 Audio In (not occupied)
- 30 UART communication interface



The USB connector can be used to perform software updates.

The maximum voltage at the SIP/SOP ports is 15 V_{DC}.

3.2. Symbols used on the device

Symbol	Designation
	Foot switch connector
	Neutral electrode isolated from ground for HF
	Defibrillation-proof type CF applied part
	Alternating current
	"ON" / "OFF" (push-push)
	During activation (of the HF device) RF energy in the radio frequency range 9 kHz to 400 GHz is applied, which produces electromagnetic radiation.
	Labeling of electrical and electronic devices in accordance with Directive 2002/96/EC (WEEE); see "Disposal"
	(Active) HF output; caution: hazardous voltage
	Caution!
	Caution: Federal Law restricts this device to sale by or on the order of a licensed practitioner. Only for the attending physician.
	Manufacturer
	Date of manufacture
	Observe use instructions
	Equipotentiality
	Fiber-optic signal input
	Fiber-optic signal output
	Ethernet connector
	USB connector
	Audio In
	UART communication interface
	Catalogue number
	Serial number
	CE-marking with number of notified body Product conforms with the essential requirements in the European Medical Devices Directive 93/42/EEC.
	Protection Class

3.2.1. Nameplate

Depending on the destination country (intended sales destination) or the specific purchase order, the ARC 400 (REF 900-400) is configured for the corresponding necessary voltage range and delivered with the associated nameplate.

Mains voltage 220 – 240 V~

	NETZSPANNUNG LINE VOLTAGE	220-240V~	MONOPOLAR BIPOLAR	400W / 200 Ohm 400W / 75 Ohm
	NETZFREQUENZ LINE FREQUENCY	50/60 Hz	FREQUENZ FREQUENCY	350 kHz / 1 MHz
	NETZSTROM INPUT CURRENT	5 A	BETRIEBSART OPERATION MODE	INT 10s on 30s off
	SICHERUNG LINE FUSE	2x T 5AH 250V		
SCHUTZKLASSE CLASS	I / IP21			
<small>Rev: 05 2016/04 BOWA electronic GmbH & Co. KG, Heinrich-Hertz-Str. 4-10, 72810 Gomaringen, Germany</small>				

Figure 3-1: Nameplate ARC 400 for 220 – 240 V~

(Here: ARC 400 incl. options LIGATION and Bipolar Resection, ARC 400 with option LIGATION bipolar output power changes to 200W, ARC 400 basic version provides a bipolar output power of 120W.)

Mains voltage 100 – 127 V~

	NETZSPANNUNG LINE VOLTAGE	100-127V~	MONOPOLAR BIPOLAR	400W / 200 Ohm 400W / 75 Ohm
	NETZFREQUENZ LINE FREQUENCY	50/60 Hz	FREQUENZ FREQUENCY	350 kHz / 1 MHz
	NETZSTROM INPUT CURRENT	10A@100V 8A@127V	BETRIEBSART OPERATION MODE	INT 10s on 30s off
	SICHERUNG LINE FUSE	2x T 10AH 250V		
SCHUTZKLASSE CLASS	I / IP21			
<small>Rev: 05 2016/04 BOWA electronic GmbH & Co. KG, Heinrich-Hertz-Str. 4-10, 72810 Gomaringen, Germany</small>				

Figure 3-2: Nameplate ARC 400 for 100 – 127 V~

(Here: ARC 400 incl. options LIGATION and Bipolar Resection, ARC 400 with option LIGATION bipolar output power changes to 200W, ARC 400 basic version provides a bipolar output power of 120W.)

3.3. Scope of delivery

You'll find detailed information on the scope of delivery in the current catalogues.

3.4. Components required for operation

- Power cable
- Foot switch
- Neutral electrode for monopolar applications
- Connection cable for neutral electrode or instrument
- Instrument (monopolar or bipolar)
- Dr. Dongle as an individual memory stick

3.4.1. OR1 Storz

When you couple the HF device to an OR system:

- ▶ Correct coupling of the OR system and the HF device can be checked with the “sign of life” (status icon).

The following states are signalled:

1. On the ARC 400 the connection to OR1 is enabled. There is no connection to the OR system.



2. On the ARC 400 the connection to OR1 is enabled. There is a correct connection to the OR system. The device can be adjusted from the OR system. The white bar sweeps cyclically from left to right.



3. On the ARC 400 the connection to OR1 is not enabled. In this case the sign-of-life icon (status icon) is not displayed.



The following points should be observed when integrating the ARC400 into the Karl Storz OR1 system:

- Use the BOWA network cable (ref 900-045).
- Network cable CAT 5e F/UTP or better; maximum total length 100 m
- OR1 ControlNEO Release 200900 01-46 or later
- BOWA ARC 400 Version 2.1.0 or later
- Only one BOWA ARC 400 can be connected to an OR1.
Connection of a second BOWA ARC 400 at the same time is not supported.

Use the network port of the BOWA ARC 400 and the network cable for the connection. Unlike other devices integrated into the OR1 system, there is no SCB connection.

The system operator is responsible for compliance with the applicable EMC requirements for the overall system.

3.4.2. MAQUET TEGRIS:

When you couple the HF device to an OR system:

- ▶ Correct coupling of the OR system and the HF device can be checked with the “sign of life”(status icon).

The following states are signaled:

1. On the ARC 400 the connection to TEGRIS is enabled. There is no connection to the OR system.

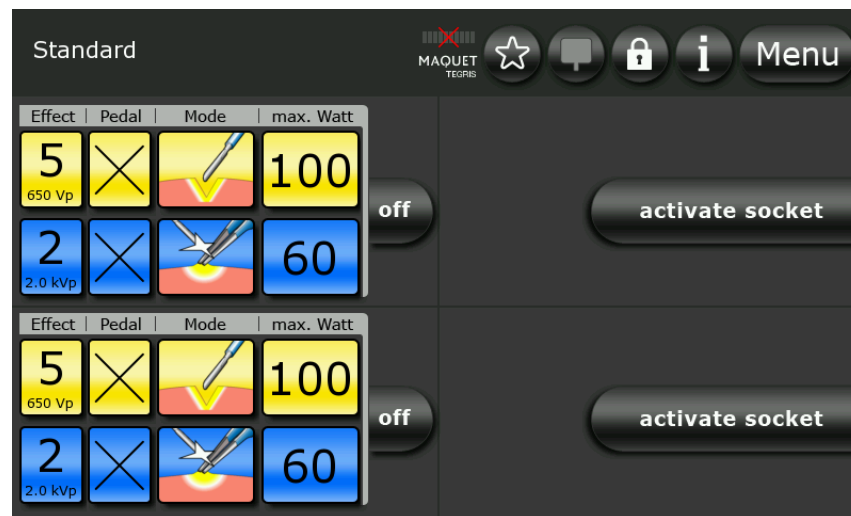

2. On the ARC 400 the connection to TEGRIS is enabled. There is a correct connection to the OR system. The device can be adjusted from the OR system. The white bar sweeps cyclically from left to right.



3. On the ARC 400 the connection to TEGRIS is not enabled. In this case the sign-of-life icon (status icon) is not displayed.

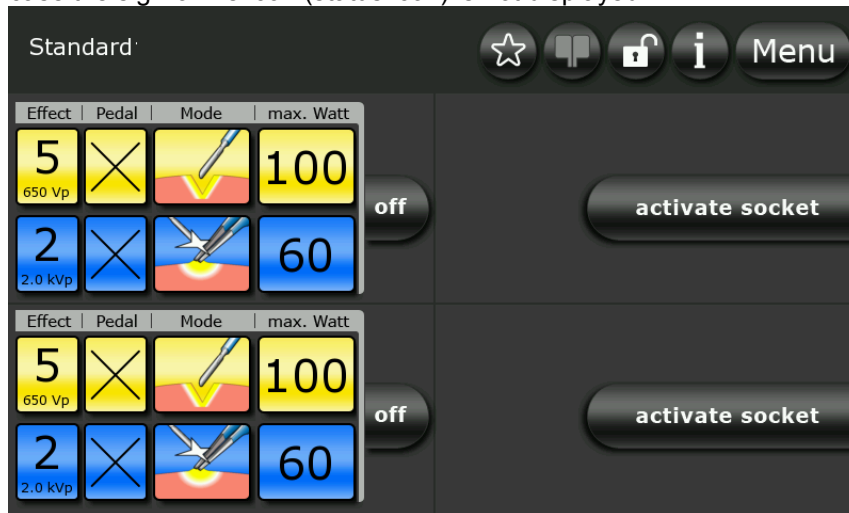

The following points should be observed when integrating the ARC400 into the MAQUET TEGRIS system:

- Use the BOWA network cable (ref 900-045).
- Network cable CAT 5e F/UTP or better; maximum total length 100 m
- BOWA ARC 400 Version 2.1.0 or later
- To activate support for the BOWA ARC 400 by your Maquet TEGRIS system, please contact your Maquet dealer.

Use the network port 27 of the BOWA ARC 400 and the network cable for the connection.

The system operator is responsible for compliance with the applicable EMC requirements for the overall system.

3.5. Operating conditions

Temperature:	+10 °C to +40 °C
Relative humidity:	30 to 75%, non-condensing
Atmospheric pressure:	700 to 1060 hPa
Operating altitude (max.):	3000 m above sea level

3.6. The basis of modern HF surgery

Depending on its nature, value and frequency, the action of electrical current on tissue may be described as electrolytic (destructive), faradic (stimulating muscles and nerves) or thermal. HF surgery is based on alternating currents with a frequency of at least 200 kHz, with the thermal effect dominating. Its effect is primarily dependent on the time for which the tissue is exposed to the current, the current density and the specific resistance of the tissue, which on the whole falls with increasing water content or increasing blood circulation. In practice, it is also necessary to consider that portion of current which flows past the target tissue and can heat up and damage other regions (such as during irrigation, seen more with monopolar techniques than with bipolar ones).

Monopolar Method

Monopolar HF surgery deploys a closed current circuit in which current flows from the active electrode of the instrument through the patient to a neutral electrode with a large surface area and then back to the generator.

The contact area between the tip of the monopolar instrument and the tissue is small so that the highest current density of the current circuit is seen here, and brings about the desired thermal action.

Localized heat build-up is reduced to a minimum through the large surface area and the special design of the neutral electrode.

Bipolar Method

With bipolar HF surgery two active electrodes are integrated into the instrument and current flow is restricted to the tissue between the two electrodes rather than the entire body of the patient.

No neutral electrode is therefore required.

4. Prearrangement

4.1. Setting up the HF device



NOTE

Electromagnetic fields are generated during normal use of the HF device. This can adversely affect other devices.

- ▶ Ensure that no electronic devices are placed in the vicinity of the HF device.



WARNING

Shock hazard

- ▶ Always connect the HF device to a grounded power distribution system in order to prevent electric shock.



DANGER

Risk of burns to patients due to excessive leakage current

- ▶ Locate the HF device outside the immediate vicinity of the patient, see section Ambient conditions, page 12.



HF devices may be used only in rooms used for medical purposes that meet the requirements of DIN VDE 0100-710.



If the HF device was previously stored or transported at temperatures below +10 °C or a relative humidity above 75%, non-condensing, it will take approximately three hours to adjust to room temperature.

1. Observe the specified operating conditions (see Section Operating conditions, page 27).
2. Place the HF device on one of the following platforms:
 - a table;
 - an equipment trolley;
 - a console suspended from a ceiling support or wall-mounted brackets.
3. Place the HF device a sufficient distance away from other electronic equipment, see Section EMC, page 159.
4. Position the HF device with the front of the device facing the patient and surgeon.
5. Do not place any other devices on the HF device.

6. Do not place any other objects on or above the HF device.
7. Place the HF device on top of ARC PLUS only, do not place it on other devices.
8. Connect the power cord.

4.2. Switching on the HF device



Do not use the HF device if the display components are not working. See Section Detecting and correcting faults, page 99 for troubleshooting instructions.

- The line voltage must match the voltage specified on the nameplate. Connect the power cord to the generator and plug the cord into a grounded AC power outlet.

1. Switch the HF device on using the power switch **31** on the rear side of the unit and touch the On/Off button on the front panel.



- ↪ The HF unit performs a self-test: All user interface components light up.
- ↪ The bars of the activation display light up, while the connector surrounds light up orange.
- ↪ Full functionality of the loudspeaker is indicated by the start melody.
- ↪ The individually configurable start screen appears if it has been set up.

2. Check all controls and indicators for proper operation:

- Power switch
- On/off switch
- Touchscreen
- Monopolar socket connectors
- Bipolar socket connectors
- Activation bar for monopolar and bipolar sockets

-
- ↪ The main screen appears, and the HF device is ready for use.
 - ↪ The parameters of the most recently selected program appear on the display.
-

NOTE



Standby mode

The standby mode of the HF device is described as follows:
The power switch 31 on the rear panel of the HF device is switched on and the front-panel On/Off button 1 is switched on, with the on/off button 1 illuminated orange.
(IEC 60601-2-2:2010 Section 201.11.8)

4.3. Connecting instruments

Before connecting instruments, ensure that the following conditions are met:

- Combinations of accessories not mentioned in the operating manual may be used only if they are explicitly designed for the intended use. Always observe performance characteristics and safety requirements.
- The insulation of the accessories (e.g. HF cables and instruments) must be sufficient for the maximum peak output voltage (see IEC 60601-2-2 and IEC 60601-2-18).
- Do not use accessories with defective insulation.

4.3.1. Instruments for monopolar use

1. Plug the neutral electrode cable into the socket for the neutral electrode and choose the corresponding neutral electrode type, see chapter Selecting the neutral electrode, page 46.
 - ↳ The socket illumination goes dark.
 - ↳ The neutral electrode button changes from grey to the measurement colour (green, yellow or red).
2. Connect the electrode handle to one of the two monopolar socket connectors.
 - or –
 - In the case of an accessory without a finger button, connect a footswitch to the socket connector. Connect the Bovie connector of the monopolar cable to the socket connector.
 - or –
 - Connect the monopolar cable for endoscopy to one of the two monopolar socket connectors for monopolar instruments.

4.3.2. Instruments for bipolar applications

1. Connect the bipolar cable to the instrument (e.g. forceps).
2. Connect the bipolar cable to one of the two bipolar socket connectors.
3. For bipolar use without AUTOSTART, connect a footswitch to the socket connector.
 - or –
 - Use the AUTOSTART mode for the appropriate socket connector.
- ↳ Once the instrument is connected, the application starts after the configured delay time.

4.3.3. Connecting a foot switch

In addition to the manual switch, a foot switch can be used to activate various operating modes.

Connect the desired foot switch only during operation to one of the two socket connectors for foot switches.

- ↳ The HF device automatically detects the connected foot switch and indicates this on the front panel display, including the selected socket connector.



One double-pedal foot switch and one single pedal foot switch can be connected. Foot switches without an orange changeover switch cannot be used.

During the operation, the ARC PLUS may only be connected to the foot switch and if necessary to an OP system (see Section 3.4.1/3.4.2) by fibre-optic cables plugged in at the rear of the device.

The following foot switch systems can be connected to the HF device:

Item no.	Designation
901-011	Single-pedal foot switch with switch
901-031	Double-pedal foot switch with switch
901-032	Double-pedal foot switch with switch and clip

4.4. Functional test

4.4.1. Auto test function

The HF device automatically performs cyclic testing during operation. If any faults occur, see Section "Detecting and correcting faults", page 99.

4.4.2. Functional testing

Perform the following functional test before putting the device into service:



The accessories must be designed for the specified maximum voltage.

1. Connect the neutral electrode and attach it securely to the patient's arm.
 - ↳ The EASY neutral electrode indicator changes to green.
2. Remove the neutral electrode.
 - ↳ The indicator changes to red, acoustic signals sound.



The neutral electrode used for this test may not later be used for an operation.

3. Connect a monopolar HF handle to a monopolar socket connector if there is a green EASY indicator and use the manual switch and footswitch to individually activate "Cut" and "Coag".
4. Check the settings on the display.
5. Now change to the bipolar output and connect bipolar forceps.
6. Select a mode with AUTOSTART, grasp moist gauze with the forceps, and check the display.
7. Now change to a mode without AUTOSTART and use the footswitch to activate the bipolar output. Check the settings and indicators in the bipolar section.

4.4.3. Actions in case of problems

Proceed as follows in case of functional problems:

1. Immediately disconnect the patient from the HF device.
2. Inspect the HF device and perform a functional test.
3. Report incidents and near-accidents to the German Federal Institute for Medications and Medical Products in accordance with Section 3 of the German Ordinance on the Installation, Operation and Use of Medical Products (MPBetreibV). Observe the provisions of the in-house reporting system in this regard.
4. Consult the Technical Service department, see Section Technical service, page 109.



In an emergency, the HF device can be switched off at any time by the power switch 31, which fully disconnects the device from the mains.

4.5. Neutral electrode monitoring



Always use the largest possible electrode when attaching a neutral electrode.

4.5.1. General information



BOWA recommends using split neutral electrodes, since only this type of electrode allows the HF device to detect detachment of the neutral electrode if this occurs.

Monitoring of the neutral electrode minimizes the risk of burns at the site where the neutral electrode is attached.

Two types of neutral electrodes can be monitored:

- Split electrodes for infants (for use with reduced power)
- Split neutral electrodes

The type of neutral electrode and its contact quality are selected and/or shown in Neutral Electrode Modes menu.



Figure 4-1: Neutral electrode modes

Faults related to the neutral electrode and possible remedies are shown on the display, see Section "Detecting and correcting faults", page 99.

4.5.2. EASY neutral electrode monitoring (EASY monitoring)



The maximum output power of monopolar current types is reduced to 50 W when a children's electrode is selected.

The EASY monitoring function measures changes in the resistance between the patient and the high-frequency surgery device before and during HF activation. If necessary, it generates visual and audible alarms to request staff intervention. This requires using a split neutral electrode with appropriate contact areas and suitable contact resistance, attached to the patient according to the manufacturer's instructions. The EASY system does not monitor the currents through the individual contact surfaces of the split neutral electrode.

A BOWA electrode with a surface area of at least 90 cm² must be used for the "Resection" programs and the "Moderate Coagulation" mode.

If an error message is generated, the display changes from green via yellow to red, depending on the type of fault.

! NOTE



Risk of incorrect application of the neutral electrode!

- ▶ Ensure compliance with the specifications for correct attachment of the neutral electrode with regard to size, adhesive properties and full-surface contact of the complete electrode.

4.6. Turning the device off

Press the On/Off button (1) to switch off the device. Also switch off the power switch (31) on the rear panel (mains disconnection).

NOTE

Switching off the device with the front panel On/Off button (Suspend Mode)



- ▶ After the medical device has been switched off and on by the On/Off button 1 on the front panel, the last (most recently) saved parameters (defined settings) are reloaded.
- ▶ In an emergency, an enabled output can be disabled at any time by switching off the On/Off button 1 on the front panel.

NOTE

Switching off the device with the power switch on the rear panel (power interruption longer than 15 seconds)



- ▶ After a supply voltage interruption longer than 15 seconds, the parameter settings for the currently selected program that were last saved in non-volatile memory are reloaded.

NOTE

Brief power interruption shorter than 15 seconds



- ▶ After a supply voltage interruption shorter than 15 seconds, the parameter settings for the currently selected program that were last saved in volatile memory are reloaded.
-

5. Operation

5.1. Program overview

5.1.1. Display

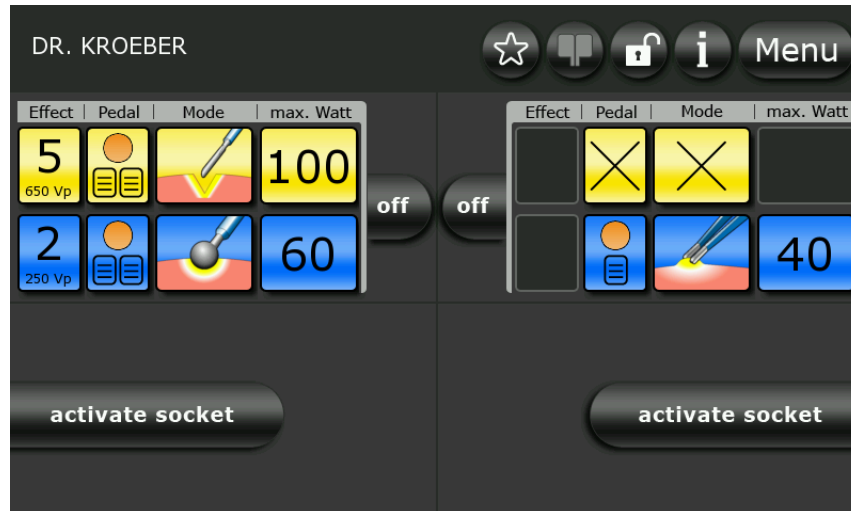

Figure 5-1: Main screen

The status bar is located at the top of the display.

The settings of the four socket connectors are shown below the status bar.

Settings can be configured for each of the connectors.

The "Effect" button is used to set the effect of electrosurgical cutting.

The "Pedal" button allows the activation of specific functions to be assigned to the foot pedal.

The "Mode" button allows the desired type of current to be selected.

The "max. Watt" button is used to set the maximum output power.

The "max. Watt" power settings are relative values. This setting configures the maximum value of the desired upper power limit. Measured power values can and may therefore deviate from the characteristic power curves (see Section 10.2) by $\pm 20\%$.

5.1.2. Status bar



Figure 5-2: Status bar with Favourite

Five buttons are located on the status bar: "Favourite", "EASY", "Keylock", "Help" and "Menu".

The "Argon" button is also displayed in conjunction with ARC PLUS and selection of an Argon mode.



Figure 5-3: Status bar with Argon

5.2. Activating and deactivating connectors



Figure 5-4: Deactivated socket

► To activate a deactivated socket connector, plug a connecting cable into the connector.

– or –

Press the "activate socket" button.

↵ An overview of the connector settings appears.



Figure 5-5: Unused socket

The overview is greyed out if no instrument is connected to the socket connector.



Figure 5-6: Activated socket

The socket illumination extinguishes and connector lights up when an instrument is plugged in.

► To hide the selection, press the "off" button next to the connector settings overview.

The socket cannot be hidden when an instrument is plugged in.

5.3. Unlocking the screen

The device screen is locked automatically. To unlock it, press any key and then drag the slider from left to right. An open padlock icon will appear on the status bar.



Bild 5-7: Unlocking the screen

You can disable key locking or change the time delay for automatic screen locking; see Section Menu "System Settings" dialog", page 80.

5.4. Configuring output currents

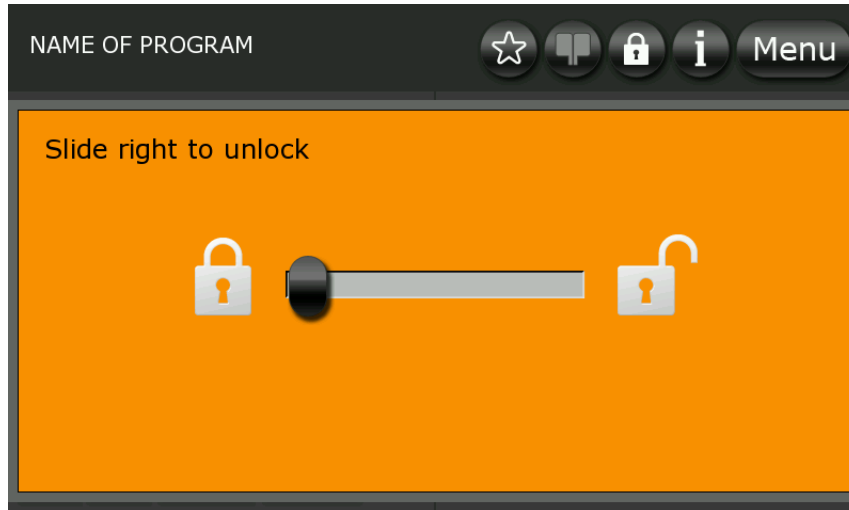

All selection windows are closed 10 seconds after the last screen touch.



If selection windows are open, all screen areas outside this area have the same effect as the "Back" button.
Activations also have the same effect as the "Back" button.



A change to the currently loaded program, e.g. by adjusting the output, is indicated by the information "changed" below the program name.

5.4.1. Selecting the mode

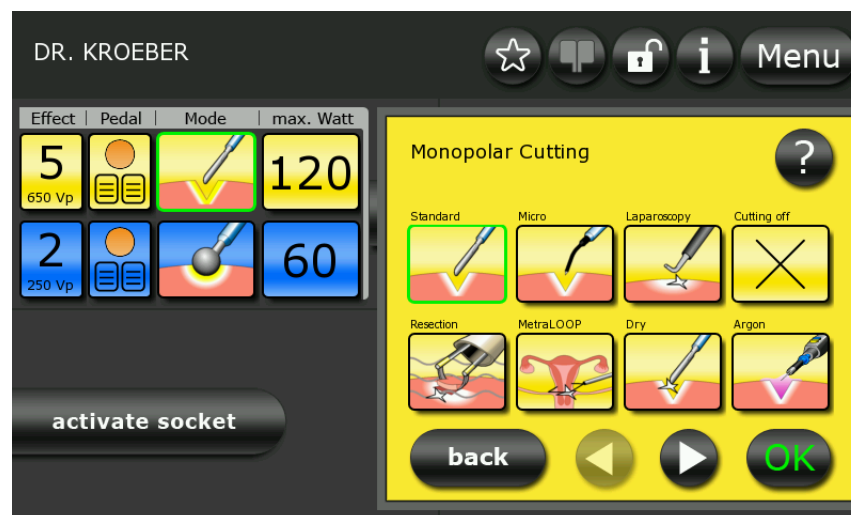

Figure 5-8: Modes monopolar cutting

1. To select the type of current for monopolar cutting, first select one of the two socket connectors on the left side.
2. Press the yellow icon under the "Mode" button.
- ↳ A selection screen appears for the available modes, and the rim of the associated connector starts blinking.
3. Select the desired mode by pressing the corresponding button.
- or -
Deactivate the mode by pressing the button "mode off".
4. Press the "?" button for more information on this selection.
5. Additional options in the selection window can be accessed with the arrow keys..
6. Confirm your selection by pressing the "OK" button.
- ↳ The main screen will be displayed.
- or -
Press the "Back" button to return to the main screen without changing the selection.



If a mode is changed within a socket, the set parameters, e.g. effect and max. Watt, remain the same for the respective mode. However, if, for example, the factory default setting of a mode is adapted and subsequently changed to a different mode and then back again, the user changes are not undone.

5.4.2. Specifying power limits

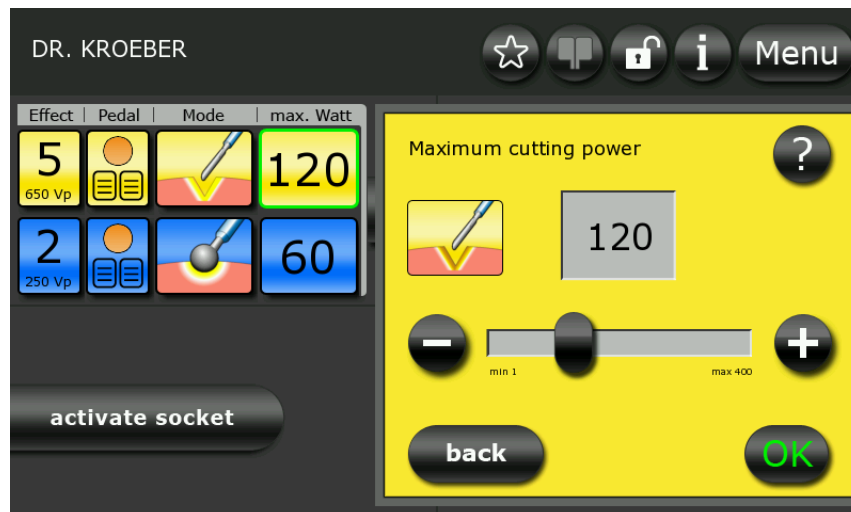

Figure 5-9: Maximum power monopolar cutting

1. To select the maximum current for monopolar cutting, first select one of the two socket connectors on the left side and press the yellow icon under the "max. Watt" button.

The "max. Watt" power settings are relative values. This setting configures the maximum value of the desired upper power limit. Measured power values can and may therefore deviate from the characteristic power curves (see Section 10.2) by $\pm 20\%$.

2. Use the "+" and "-" buttons to adjust the power level in single steps.
- or -
Use the slider to set the power level in steps of 10.
3. Press the "?" button for more information on this selection.
4. Confirm your selection by pressing the "OK" button.
- or -
Press the "Back" button to return to the main screen without changing the selection.

5.4.3. Selecting the effect

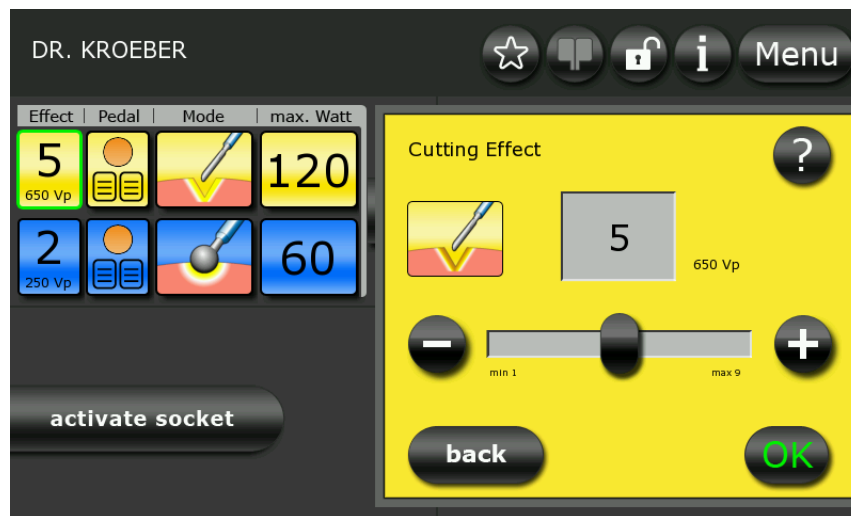

Figure 5-10: Effect monopolar cutting

1. To select the effect for monopolar cutting, first select one of the two socket connectors on the left side and press the yellow icon under the "Effect" button.
2. Use the "+" and "-" buttons to adjust the effect in individual steps.
– or –
Use the slider to set the effect.
3. Press the "?" button for more information on this selection.
4. Confirm your selection by pressing the "OK" button.
- or -
Press the "back" button to return to the main screen without changing the selection.

5.4.4. Assigning the foot pedal



Handles and instruments with manual switches can be activated without a configuration setting.

A single-pedal foot switch and/or double-pedal foot switch, each with a changeover switch, can be connected,

The changeover switch enables switching between pedal levels.

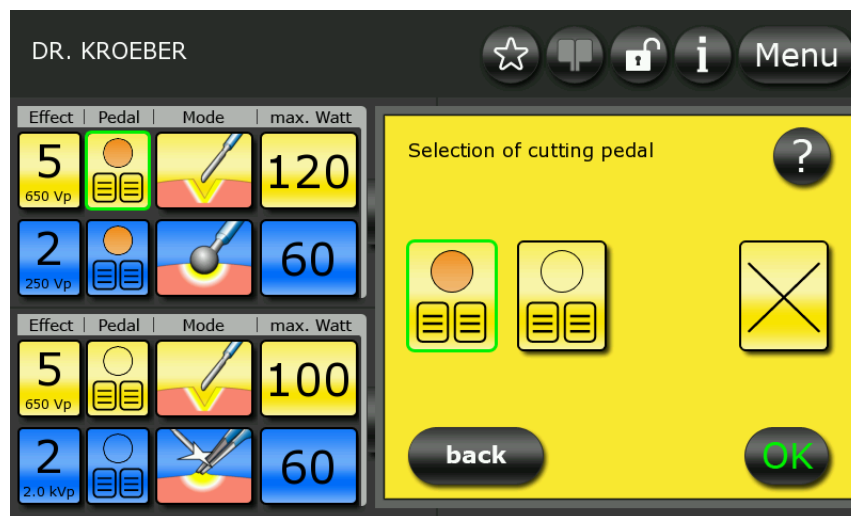

Figure 5-11: Foot switch selection cutting

1. Select the footswitch menu by pressing the button "Pedal".
2. Select the desired foot switch by pressing the corresponding button.
For example, choose the active pedal level for cutting and coagulation of the upper left socket.
- or -
Deactivate the foot switch by pressing the button marked with a „X“.
- ↳ The edge of the selected button lights up green.
3. Confirm the selection by pressing the "OK" button.
- or -
Press the "Back" button to return to the main screen without changing the selection.
- ↳ The socket is assigned to the active pedal level.
4. Pedal levels can be changed using the foot switches. Press the orange button to change the socket.
- ↳ The orange background indicates that the lower left-hand socket is activated.

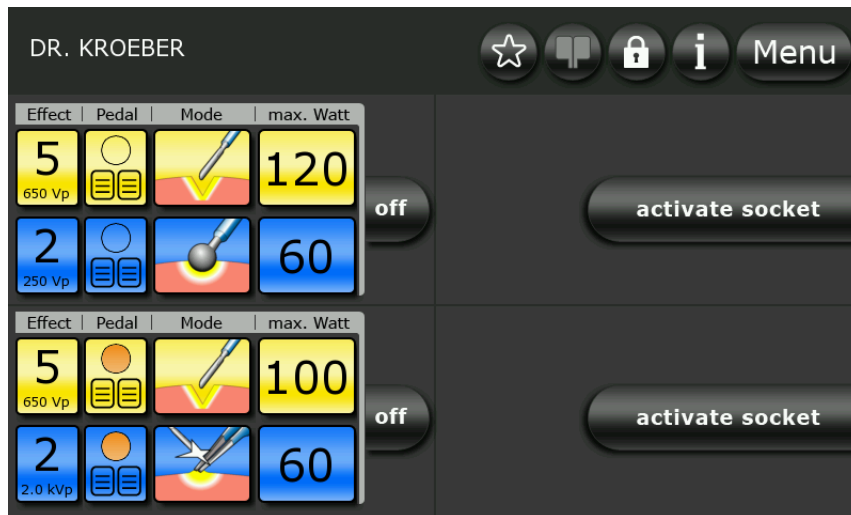

Figure 5-12: Foot switch changeover



If two footswitches are connected, either a single-pedal footswitch or a double-pedal footswitch can be selected for coagulation.

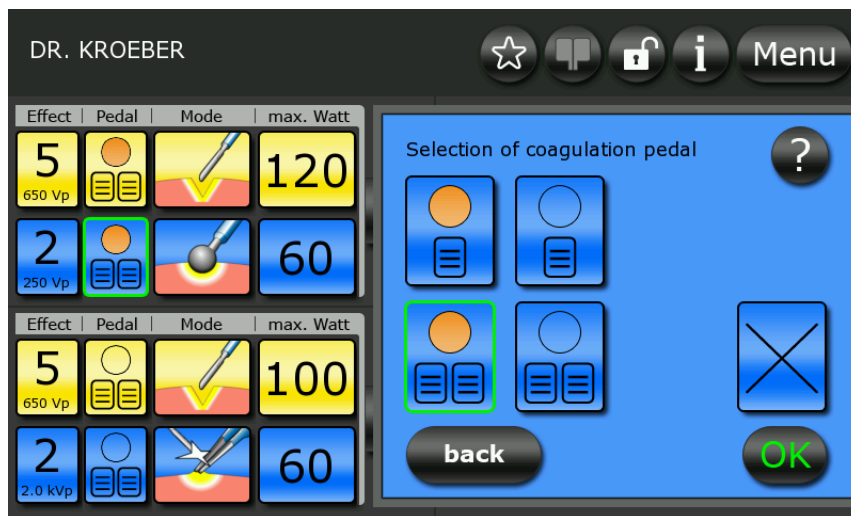





















Figure 5-13: Foot switch selection coagulation

The following pedal icons can be differed:

Icon / Button	Description	Icon / Button	Description	Icon / Button	Description
	Double pedal foot switch CUT active		Double pedal foot switch CUT active not connected		Double pedal foot switch CUT inactive
	Double pedal foot switch not connected		Deactivate foot switch CUT		Deactivate foot switch COAG
	Double pedal foot switch COAG active		Double pedal foot switch COAG active not connected		Double pedal foot switch COAG inactive
	Double pedal foot switch not connected		Single pedal foot switch not connected		Single pedal foot switch COAG inactive
	Single pedal foot switch COAG active		Single pedal foot switch COAG active not connected		
	Double pedal ZAP Mode COAG active		Double pedal ZAP Mode COAG inactive		Single pedal ZAP Mode COAG active
	Single pedal ZAP Mode COAG inactive		Double pedal ZAP Mode CUT active		Double pedal ZAP Mode CUT inactive

5.4.5. Selecting the neutral electrode

1. Press the "EASY" button on the status bar to select the neutral

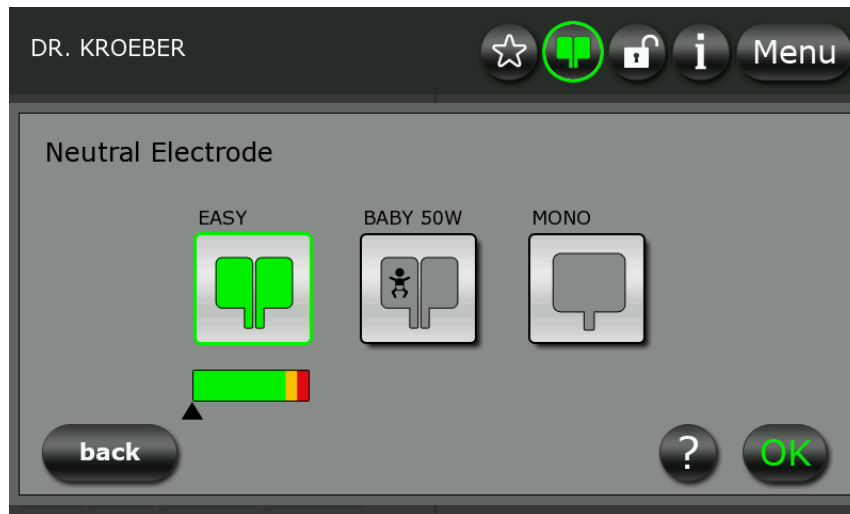

electrode.

Figure 5-14: Neutral electrode



The maximum power output of monopolar current types is reduced to 50 W when a children's electrode is selected.

2. Select the type of connected electrode by pressing the corresponding icon:
 EASY: for monitoring split neutral electrodes
 BABY: for monitoring split neutral electrodes for infants
 MONO: to select a one-piece neutral electrode
 3. Press the "?" button for more information on this selection.
 4. Confirm your selection by pressing the "OK" button.
 - or -
 Press the "Back" button to return to the main screen without changing the selection.
- ↪ The selected type of neutral electrode in connection with a colour-indicator for the contact quality is shown in the status bar.















When using the „EASY“ and „BABY“ mode, no unsplit electrodes are accepted.

Using the „MONO“ mode, no split electrodes are accepted.

The “Monopolar Resection” and “Metraloop” programs are not allowed when the Baby electrode is selected.

According to the contact quality, several icons are shown for neutral electrodes:

Icon / Button	Description	Icon / Button	Description
	Split neutral electrode contact quality OK		Non split neutral electrode contact quality OK
	Split neutral electrode contact quality not optimum		Non split neutral electrode not detected or contact quality insufficient
	Split neutral electrode contact quality insufficient		Non split neutral electrode not connected / recognised
	Split neutral electrode not connected / recognised		Display contact quality
	Split baby neutral electrode contact quality OK		
	Split baby neutral electrode contact quality not optimum		
	Split baby neutral electrode contact quality insufficient		
	Split baby neutral electrode not connected / recognised		

5.4.6. Dr. Dongle®

Dr. Dongle is an individual memory stick on which up to six programs can be saved for subsequent use.

- ▶ Insert your Dr. Dongle with your personal settings into every ARC 400 at any **bipolar socket**.
- ↪ The data is read as soon as you insert Dr. Dongle or after changing a program with Dr. Dongle inserted:

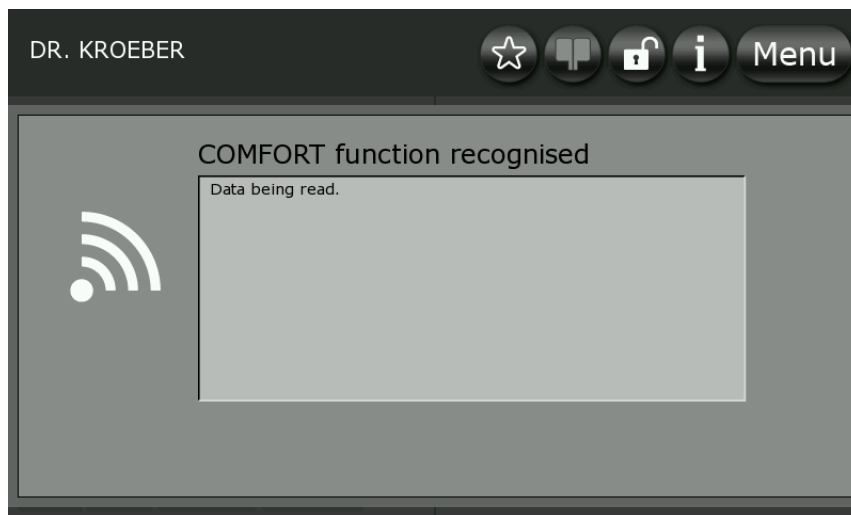

Figure 5-15: COMFORT function detected

- ↪ After a short loading period, an overview of the saved programs appears automatically as a new user interface.

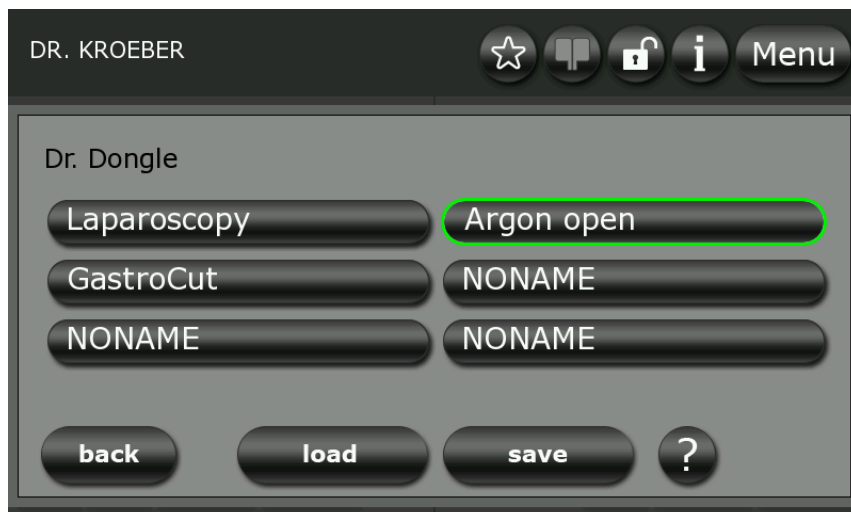

Figure 5-16: Dr. Dongle program selection

Save current program on Dr. Dongle:

The program currently loaded in ARC 400 can be saved on Dr. Dongle:

1. In the overview, select a program storage space to be overwritten.
 2. Press "save" to save the currently loaded program at the selected space.
 3. A keyboard appears which can be used to enter a name for the program.
- ☞ The program is now saved on Dr. Dongle.
4. Press the "back" button to return to the main screen.
- ▶ Dr. Dongle can now be removed



If the Dr. Dongle is plugged in, the Dr. Dongle screen is displayed after you touch the program name, "Program" or "Save program".

Load a program from Dr. Dongle:

A program saved on Dr. Dongle can be loaded onto any ARC 400:

1. Select a program saved on Dr. Dongle from the overview by touching the program name.
 2. Press "load" to load the selected program.
- or -
Press "back" to return to the main screen without carrying out changes to the selection.
- ☞ The selected program is now active in the main screen of ARC 400.
- ▶ Dr. Dongle can be removed
- or -
Save the loaded program in the program list, see "Save program" dialog, page 86.

5.4.7. Plug'n Cut COMFORT

The automatic instrument identification Plug'n Cut COMFORT recognises the connected BOWA COMFORT instrument and selects the default parameters automatically.

1. Insert the COMFORT instrument into a socket of ARC 400.

↳ The instrument data is read



Figure 5-17: Plug'n Cut COMFORT

↳ A description of the instrument appears:

- Instrument name
- Recognised socket
- Item number
- Lot number
- Remaining use cycles with reusable instruments. Remaining use cycles are not displayed with disposable instruments.

↳ The parameters are accepted automatically after 5s and shown on the main screen.

- If the COMFORT instrument is connected to a socket **without preset parameters**, the ideal settings for the BOWA COMFORT instrument are loaded via Plug'n Cut COMFORT.
- If the COMFORT instrument is connected to a socket **with preset parameters**, a plausibility check is carried out. The preset values for the COMFORT instrument are not overwritten if they are within a permissible range. The COMFORT instrument can now be used with the preset parameters.

- or -

Press "OK" to accept the selection.

Press "back" to return to the main screen without carrying changes to the selection.

↳ The COMFORT instrument can now be used.

↳ The permissible parameters for the BOWA COMFORT instrument remain accessible; all other modes are greyed out.

5.4.8. Playing videos

1. Plug the delivered BOWA USB stick into the connection on the rear side of the ARC 400.
2. To play the video, press the “Play” button in the operating manual dialog.

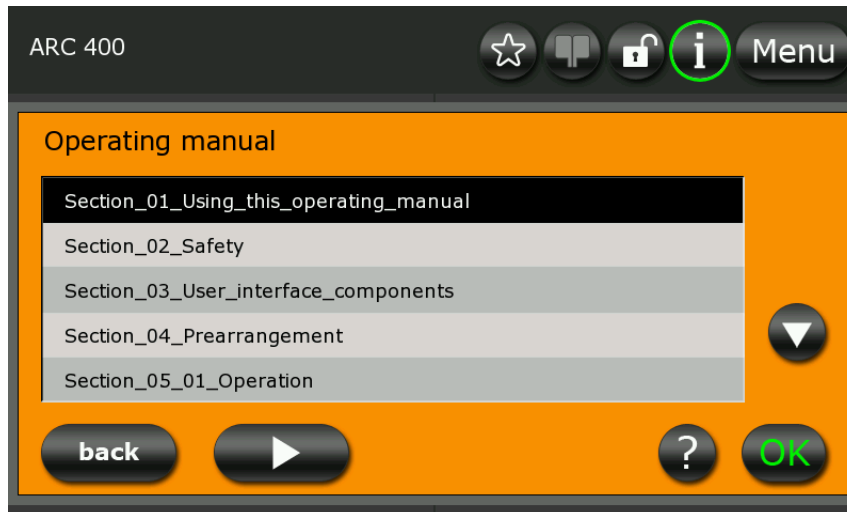

Figure 5-18: Operating manual dialog

3. To stop the video, switch off the device.



The device restarts normally.

5.4.9. Configuring the startup screen







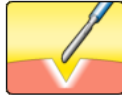
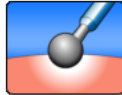
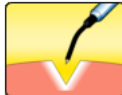
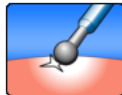

ARC 400 offers the possibility to display a personalized start screen. This start screen appears after each switching on of the unit for a configurable period of time.

1. Create a folder with the name "arc_logo" on the USB flash drive (REF 900-402).
 2. Open the Windows program " Notepad.exe " and enter a number between 5 and 60 for the displayed duration in seconds.
 3. Save this file on the USB flash drive in the folder "arc_logo" under the name "KH_Logo.conf". Make sure that the file is stored as type "All Files (*. *)" and encoding "UTF -8".
 4. Create a startup screen with a resolution of 800 x 480 pixels and save it under the name "KH_Logo_arc400.png" in the folder "arc_logo".
 5. Plug the USB flash drive with the files created in the USB port of the ARC 400 and turn the unit on using the main switch.
Make sure that there are no other data on the USB flash drive.
 6. Wait until the ARC 400 is fully booted and the user interface appears.
 7. To configure the start screen, select Service Level 1 under Menu / Service (see section 5.10.4).
 8. Press the "Add Logo" button to add the start screen.
 9. Switch the ARC 400 off and then on to check correct acceptance.
- Now your generated startup screen is permanently stored in the device and appears after every switching-on for the specified duration.

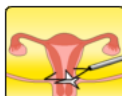
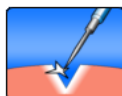
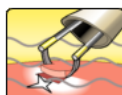
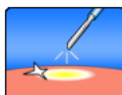
5.5. Mode overview



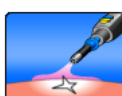
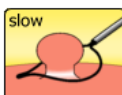
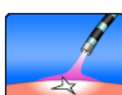
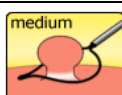

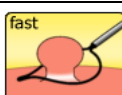
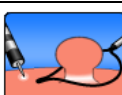
An overview of the programs that can be executed with the HF device is shown below.

5.5.1. Monopolar modes



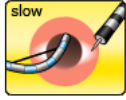

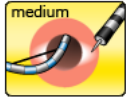
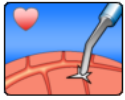
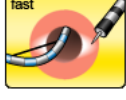
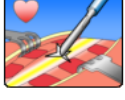



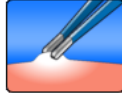
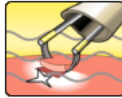
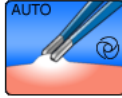

Cutting mode icon	Designation	Coagulation mode icon	Designation
	Standard		Moderate
	Micro		Forced non cutting
	Dry		Forced mixed
	MetraLOOP		Forced cutting
	Resection		Spray
	Laparoscopy		Laparoscopy
	Argon*		Argon*
 slow	GastroLOOP 1		Argon flexible*
 medium	GastroLOOP 2	 Pulsed 4.4kV	Argon flex. pulse*
 fast	GastroLOOP 3		Gastro Coag

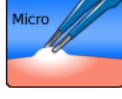

* These modes can only be used in connection with the argon coagulation unit ARC PLUS (900-001).

Cutting mode icon	Designation	Coagulation mode icon	Designation
	GastroKNIFE 1		Resection
	GastroKNIFE 2		Cardiac Mammary
	GastroKNIFE 3		Cardiac Thorax
			SimCoag

5.5.2. Bipolar modes

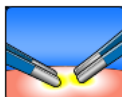
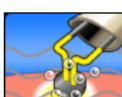
Cutting mode icon	Designation	Coagulation mode icon	Designation
	Standard		Standard forceps
	Bipolar resection ^R		Standard forceps AUTO
	Bipolar scissors		Micro forceps
	Vaporisation ^R		Forceps forced
			LIGATION ^L
			TissueSeal PLUS ^L
			Bipolar scissors
			Laparoscopy
			Micro laparoscopy
			Bipolar resection ^R
			SimCoag ^S
			Vaporisation ^R



^R These modes are available with the option Bipolar Resection (900-395).

^L These modes are available with the option LIGATION (900-396).

^S This mode is available with the option Bipolar SimCoag (900-399).



The information and data regarding settings, application points, application duration and instrument use are based on clinical practice. However, these are only basic guidelines which must be tested for suitability by the operator. Depending on individual conditions, it may be necessary to deviate from the provided data.

Medical practice is continuously evolving as a result of R&D and clinical experience. This may also make deviations from the provided data necessary.

5.6. Monopolar cutting modes

5.6.1. Standard

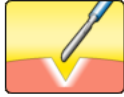

In this mode a high-performance HF current with a low crest factor is used for cutting biological tissue. ARC CONTROL quickly adjusts the power output to the minimum required level in response to variations in tissue type and changes in the cutting area or speed.

Application areas

Cutting tissue with low electrical resistance, such as muscle tissue or vascular tissue.

Cutting or preparing fine structures

Suitable instruments

- Needle electrodes
- Knife electrodes
- Spatula electrodes
- Sling electrodes

5.6.2. Micro

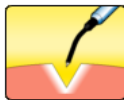

This mode is used for electrosurgical cutting using micro-electrodes. It enables extremely fine control of the power level and precise work.

Application areas

Pediatric surgery, neurosurgery, plastic surgery

Suitable instruments

- Micro needle electrodes

5.6.3. Dry

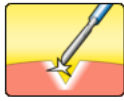

This mode is used for monopolar dry cutting. A large, controlled arc is generated, which allows significantly deeper coagulation to be obtained.

Application areas

Cardiac surgery and blood coagulation in retracting blood vessels in the sternum region.

Suitable instruments

- Knife electrodes

5.6.4. Argon

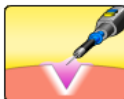

This mode is used to perform open surgical interventions in combination with the ARC PLUS companion device for argon-assisted cutting. With suitable instruments connected, argon-assisted cutting can be performed using rigid electrodes.

Application areas

Visceral surgery

Suitable instruments

- Rigid argon electrodes
- Argon handle

5.6.5. Resection

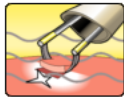

This mode is used in gynecology and urology. ARC control generates the cutting effect with simultaneously minimized output power. ARC control facilitates direct cutting and prevents electrode adhesion.



Use non-conductive irrigation fluids.

Application areas

Hysteroscopy, transurethral prostate resection (TUR-P), surgical treatment of bladder tumors (TUR-B), vaporization of prostate tissue (TUR-VAP).

Suitable instruments

- Resectoscope (monopolar)
- Resection sling
- Rollerblade electrode

5.6.6. MetraLOOP

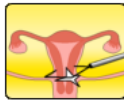

This mode is used in gynecology for laparoscopic hysterectomy. Removal of the uterus can be achieved by applying monopolar cutting current and pulling on the sling at the same time.

Application areas

Gynecology; laparoscopic hysterectomy

Suitable instruments

- Gynecological slings

5.6.7. Laparoscopy

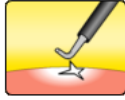

This mode is used in laparoscopy and arthroscopy for monopolar cutting.

Application areas

Laparoscopy, arthroscopy

Suitable instruments

- Arthroscopy electrodes
- Laparoscopy electrodes

5.6.8. GastroLOOP 1

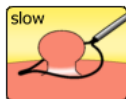

This mode is used in gastroenterology. Polypectomy snares are used for cutting and coagulation. ARC control generates the cutting effect with simultaneously minimized output power. This mode consists of a series of cutting current pulses followed by a coagulation phase. With a relatively slow pulse rate of 1 cutting pulse per second, this mode is suitable for especially cautious work.

Application areas

Polyp removal using polypectomy snares and flexible endoscopy

Suitable instruments

- Polypectomy snares

5.6.9. GastroLOOP 2

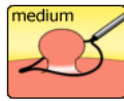

This mode is used in gastroenterology. Polypectomy snares are used for cutting and coagulation. ARC control generates the cutting effect with simultaneously minimized output power. This mode consists of a series of cutting current pulses followed by a coagulation phase. With an accelerated pulse rate of 1.5 cutting pulses per second, this mode is suitable for experienced users.

Application areas

Polyp removal using polypectomy snares and flexible endoscopy, with accelerated pulse rate for experienced users.

Suitable instruments

- Polypectomy snares

5.6.10. GastroLOOP 3

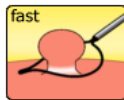

This mode is used in gastroenterology. Polypectomy snares are used for cutting and coagulation. ARC control generates the cutting effect with simultaneously minimized output power. This mode consists of a series of cutting current pulses followed by a coagulation phase. With an accelerated fast pulse rate of 2.2 cutting pulses per second, this mode is suitable for advanced users.

Application areas

Polyp removal using polypectomy snares and flexible endoscopy, with accelerated fast pulse rate for advanced users.

Suitable instruments

- Polypectomy snares

5.6.11. GastroKNIFE 1

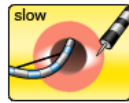

This mode is used in gastroenterology. Instruments for papillotomy and endoscopic resections are used for cutting and coagulation. ARC control generates the cutting effect with simultaneously minimized output power. This mode consists of a pulse sequence of cutting current and coagulation phase. With a relatively slow pulse rate of 1.3 cutting pulse per second, this mode is suitable for especially cautious work.

Application areas

Papilla incision using a papillotome and flexible endoscopy, resection with needle knives; slow pulse rate for cautious work.

Suitable instruments

- Papillotome
- Needle knives

5.6.12. GastroKNIFE 2

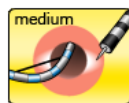

This mode is used in gastroenterology. Instruments for papillotomy and endoscopic resections are used for cutting and coagulation. ARC control generates the cutting effect with simultaneously minimized output power. This mode consists of a pulse sequence of cutting current and coagulation phase. With an accelerated pulse rate of 1.8 cutting pulses per second, this mode is suitable for experienced users.

Application areas

Papilla incision using a papillotome and flexible endoscopy, resection with needle knives; accelerated pulse rate for experienced users.

Suitable instruments

- Papillotome
- Needle knives

5.6.13. GastroKNIFE 3

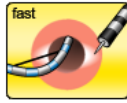

This mode is used in gastroenterology. Instruments for papillotomy and endoscopic resections are used for cutting and coagulation. ARC control generates the cutting effect with simultaneously minimized output power. This mode consists of a pulse sequence of cutting current and coagulation phase. With an accelerated fast pulse rate of 2.2 cutting pulses per second, this mode is suitable for advanced users.

Application areas

Papilla incision using a papillotome and flexible endoscopy, resection with needle knives; accelerated fast pulse rate for advanced users.

Suitable instruments

- Papillotome
- Needle knives

5.7. Monopolar coagulation modes

5.7.1. Moderate

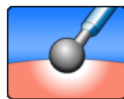

This mode is used with contact coagulation to stop hemorrhagic oozing, for hemostasis of relatively large tissue areas, and for small-area coagulation. Tissue carbonization is prevented and electrode adhesion to the tissue is strongly reduced. Greater coagulation depth is achieved in this mode than in other coagulation modes. The degree of surface scabbing can be controlled by adjusting the "Effect" setting in the range of 1 to 3.

Application areas

Coagulation with relatively high penetration depth; low electrode adhesion to tissue

Suitable instruments

- Electrodes with large contact areas, such as ball electrodes

5.7.2. Forced non cutting

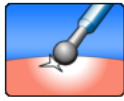

This mode is used for contact coagulation with low tissue penetration, preferably using fine electrodes and electrodes with small contact areas. It achieves a high degree of coagulation with low cutting tendency.

Application areas

Fast coagulation with small penetration depth

Suitable instruments

- Ball electrodes
- Knife electrodes
- Spatula electrodes

5.7.3. Forced mixed



This mode is used for contact coagulation with low tissue penetration, preferably using fine electrodes and electrodes with small contact areas. It achieves a high degree of coagulation with moderate cutting tendency.

Application areas

Fast coagulation with small penetration depth and moderate cutting tendency

Suitable instruments

- Knife electrodes
- Spatula electrodes
- Insulated monopolar forceps

5.7.4. Forced cutting

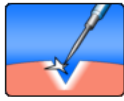

This mode is used for contact coagulation with low tissue penetration, preferably using fine electrodes and electrodes with small contact areas. It achieves good hemostasis with very good cutting tendency.

Application areas

Fast coagulation with small penetration depth and very good cutting tendency

Suitable instruments

- Knife electrodes
- Spatula electrodes
- Needle electrodes

5.7.5. Spray

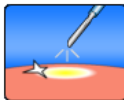

This mode is used with non-contact surface coagulation using an arc, for hemostasis in parenchymal tissue, in poorly accessible crevices, and in conjunction with argon coagulation.

Application areas

Promoting coagulation of diffuse bleeding

Suitable instruments

- Ball electrodes
- Knife electrodes
- Spatula electrodes
- Needle electrodes

5.7.6. Argon

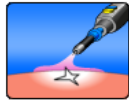

This mode is used for open surgical interventions in conjunction with the ARC PLUS accessory device for argon-assisted electrocoagulation.

This is the current type Spray.

With suitable instruments connected, argon-assisted coagulation can be performed using rigid electrodes.

Application areas

Visceral surgery

Suitable instruments

- Rigid argon electrodes
- Argon handle

5.7.7. Argon flexible

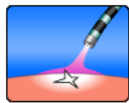

This mode is used for argon-assisted electrosurgery in conjunction with the ARC PLUS accessory device.

This is the current type Spray.

For argon-assisted coagulation, flexible probes are used in combination with endoscopes.

Application areas

Gastroenterology, homogeneous surface coagulation

Suitable instruments

- Flexible argon probes

5.7.8. Argon flex. pulse

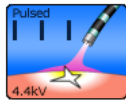

This mode is used for argon-assisted electrosurgery in conjunction with the ARC PLUS accessory device.

This is the current type Spray.

For argon-assisted coagulation, flexible probes are used in combination with endoscopes.

The puls frequency changes with the effect setting. The higher the effect level, the faster the pulse sequence.

Application areas

Gastroenterology, homogeneous surface coagulation

Suitable instruments

- Flexible argon probes

5.7.9. Resection



This mode is used for monopolar hemostasis in gynecology and urology.



Use non-conductive irrigation fluids.

Application areas

Hysteroscopy, transurethral prostate resection (TUR-P), surgical treatment of bladder tumors (TUR-B), vaporization of prostate tissue (TUR-VAP).

Suitable instruments

- Resectoscope (monopolar)
- Resection sling
- Rollerblade electrode

5.7.10. Cardiac Mammary



This mode is used in mammary surgery and cardiac surgery. It produces forced coagulation.

Application areas

Mammary surgery and cardiac surgery

Suitable instruments

- Knife electrodes

5.7.11. Cardiac Thorax



This mode is used in thoracic surgery. It produces forced coagulation.

Application areas

Thoracic surgery

Suitable instruments

- Knife electrodes

5.7.12. SimCoag



This mode is used for simultaneous preparation. Two monopolar socket connectors can be activated at the same time to enable the simultaneous use of two manually switched instruments. Both handpieces can be switched on and off independently.

The current type changes with the effect setting:

Effect 1: Forced cutting

Effect 2: Forced mixed

Effect 3: Spray



The output power setting applies to both output sockets, and the power is distributed according to the tissue structure.

Application areas

Simultaneous coagulation and preparation, e.g. for cardiac or mammary surgery

Suitable instruments

- Ball electrodes
- Knife electrodes
- Spatula electrodes

5.7.13. Gastro Coag

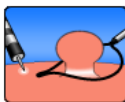

This mode is used in gastroenterology with contact coagulation for the coagulation of small areas.

Application areas

After bleeding associated with polypectomies or papillotomies.

Suitable instruments

- Polypectomy snares
- Papillotome

5.7.14. Laparoscopy

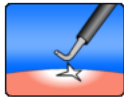

This mode is used in laparoscopy and arthroscopy for monopolar coagulation.

Application areas

Laparoscopy, arthroscopy

Suitable instruments

- Arthroscopy electrodes
- Laparoscopy electrodes

5.8. Bipolar cutting modes

5.8.1. Standard

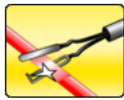

This mode is used for cutting with bipolar laparoscopic instruments.

Application areas

Laparoscopic cutting

Suitable instruments

- Laparoscopic instruments

5.8.2. Bipolar resection (optional)

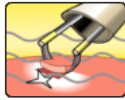

This bipolar mode is used in gynaecology and urology for resection with loop electrodes under conductive rinsing liquid (saline solution). ARC control technology generates the cutting effect with simultaneously minimized output power. ARC Control facilitates immediate cutting and prevents electrode adhesion.



Make sure that NaCl is used as an irrigation medium.
 Secure a continuous irrigation during the application.
 Always use conductive lubricants to avoid damages of the urethra.
 Avoid continuous activations.

Application areas

Hysteroscopy, transurethral prostate resection (TUR-P), surgical treatment of bladder tumors (TUR-B), vaporization of prostate tissue (TUR-VAP).

Suitable instruments

- Resectoscope (bipolar)
- Resection sling



This function is available if the device has the option Bipolar Resection (900-395).



Optimum results are provided exclusively when using BOWA COMFORT resection cables.

5.8.3. Bipolar scissors



This mode is used with bipolar scissors. It can be used for coagulation before or during cutting, point coagulation, coagulation of cuts and surface coagulation.

Application areas

Preparation, coagulation and cutting of tissue

Suitable instruments

- Bipolar scissors



Bipolar scissors should only be operated with the current type bipolar scissors cutting or bipolar scissors coagulation.

5.8.4. Vaporisation



This bipolar mode is used in gynaecology and urology for vaporisation. An arc is struck immediately on tissue contact, enabling fast tissue vaporisation with low heat propagation into surrounding tissue.



Make sure that NaCl is used as an irrigation medium.
Secure a continuous irrigation during the application.
Always use conductive lubricants to avoid damages of the urethra.
Avoid continuous activations.

Application areas

Hysteroscopy, transurethral prostate resection (TUR-P), surgical treatment of bladder tumors (TUR-B), vaporization of prostate tissue (TUR-VAP).

Suitable instruments

- Resectoscope (bipolar)
- Vaporisation electrode

5.9. Bipolar coagulation modes

5.9.1. Standard forceps

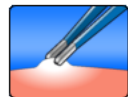

This mode is used for arcless contact coagulation with forceps.

Application areas

Bipolar coagulation

Suitable instruments

- Bipolar forceps

5.9.2. Standard forceps AUTO

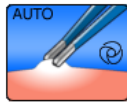

This mode is used for arcless contact coagulation with forceps. Activation starts automatically on contact with tissue. The adjustable delay time can be set under MENU – SYSTEM SETTINGS – AUTOSTART DELAY (see 5.10.2).



Setting the AUTOSTART mode can result in unintentional coagulations, e.g. when bipolar forceps are used for gripping while the AUTOSTART Mode is on.

Application areas

Bipolar coagulation with AUTOSTART

Suitable instruments

- Bipolar forceps

5.9.3. Micro forceps

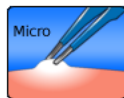

This mode is used for arcless contact coagulation with micro forceps. It enables extremely fine control of power output down to 0.1 W and precise work for tightly restricted bipolar contact coagulation.

Application areas

Bipolar coagulation in pediatric surgery, neurosurgery, plastic surgery, etc.

Suitable instruments

- Bipolar forceps
- Micro forceps

5.9.4. Forceps forced

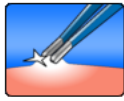

This mode is used for forced coagulation with forceps.

Application areas

Fast bipolar coagulation

Suitable instruments

- Bipolar forceps

5.9.5. LIGATION (optional)

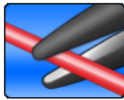

This mode is used for the permanent sealing of veins, arteries and tissue bundles. Conventional instruments cannot be used in this mode. The output power is preconfigured and automatically regulated.

Application areas

Vessel sealing open and laparoscopic

Suitable instruments

- TissueSeal®
- TissueSeal® PLUS
- NightKNIFE®
- LIGATOR®
- ERGO 310D
- ERGO 315R



This function is available if the device has the option LIGATION (900-396).

5.9.6. TissueSeal PLUS (optional)

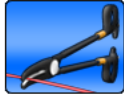

This mode is used for the permanent sealing of veins, arteries and tissue bundles with TissueSeal PLUS[®] for open surgical applications. Conventional instruments cannot be used in this mode. The output power is preconfigured and automatically regulated.

Application areas

Vessel sealing in open surgery

Suitable instrument

- TissueSeal PLUS[®]



This function is available if the device has the option LIGATION (900-396).

5.9.7. Bipolar scissors



This mode is used with bipolar scissors. It can be used for coagulation before or during cutting, point coagulation, coagulation of cuts and surface coagulation.

Application areas

Preparation, coagulation and cutting of tissue

Suitable instruments

- Bipolar scissors



Bipolar scissors should only be operated with the current type bipolar scissors cutting or bipolar scissors coagulation.

5.9.8. Laparoscopy



This mode is used for coagulation in combination with bipolar laparoscopic instruments.

Application areas

Laparoscopic coagulation

Suitable instruments

- Bipolar laparoscopic instruments

5.9.9. Laparoscopy Micro



This mode is used for coagulation in combination with fine bipolar laparoscopic instruments.

Application areas

Laparoscopic coagulation

Suitable instruments

- Fine bipolar laparoscopic instruments

5.9.10. Bipolar resection (optional)



This mode is used for bipolar blood coagulation in gynaecology and in urology for resection under conductive rinsing liquid (saline solution).



Be sure to use NaCl as the rinsing liquid.
Perform continuous rinsing during the application.
Use only conductive gel to avoid damage to the urinary tubes.
Avoid continuous activation.

Application areas

Hysteroscopy, transurethral prostate resection (TUR-P), surgical treatment of bladder tumors (TUR-B), vaporization of prostate tissue (TUR-VAP)

Suitable instruments

- Resectoscope
- Resection sling
- Rollerblade electrode



This function is available if the device has the option Bipolar Resection (900-395).



Make sure that the instrument has contact with the tissue while activating bipolar coagulation to avoid an unintended heating of the irrigation fluid.

5.9.11. Vaporisation (optional)



This mode is used for bipolar blood coagulation in gynaecology and in urology for vaporisation.



Be sure to use NaCl as the rinsing liquid.
Perform continuous rinsing during the application.
Use only conductive gel to avoid damage to the urinary tubes.
Avoid continuous activation.

Application areas

Hysteroscopy, transurethral prostate resection (TUR-P), surgical treatment of bladder tumors (TUR-B), vaporization of prostate tissue (TUR-VAP)

Suitable instruments

- Resectoscope
- Rollerblade electrode
- Vaporisation electrode



Make sure that the instrument has contact with the tissue while activating bipolar coagulation to avoid an unintended heating of the irrigation fluid.



This function is available if the device has the option Bipolar Resection (900-395).

5.9.12. Bipolar SimCoag (optional)

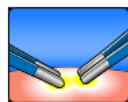

This mode is used for coagulation when using two bipolar instruments, e.g. forceps. The power is individually selectable for each instrument without any loss in power output during simultaneous activation.

The power can be set in steps of 5 watt.

Application areas

Simultaneous coagulation and preparation with two bipolar instruments in general surgery, vascular surgery, plastic surgery, traumatology, Neuro surgery and Orthopedics.

Suitable instruments

- Bipolar forceps
- Bipolar scissors



This function is available if the device has the option Bipolar SimCoag (900-399).

5.10. Menu dialogs



The menu dialogs specify the settings of basic parameters, such as the user interface language and audio, display and memory options.

5.10.1. Overview

The following menu dialogs are available:

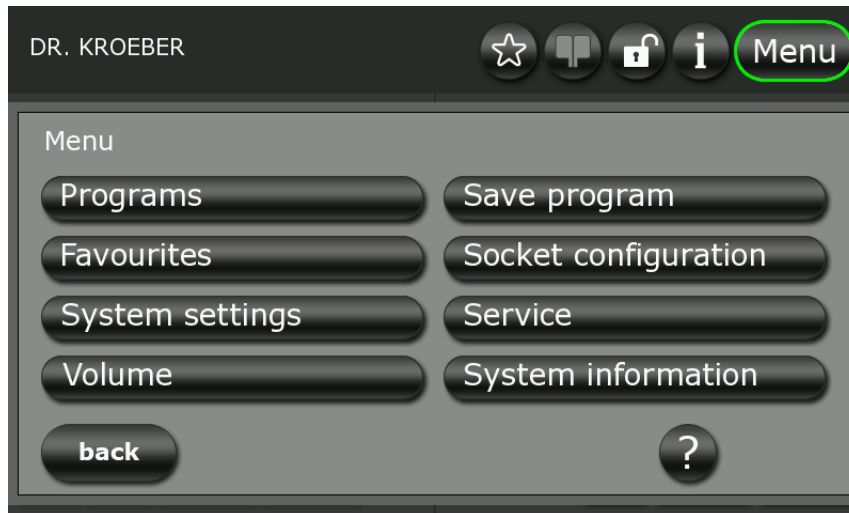

Figure 5-19: Menu dialogs

Selecting a dialog

Press the button of the desired dialog to launch the program.

Exiting a dialog

Press the "back" button to return to the main screen.

5.10.2. "System Settings" dialog

The following parameters can be configured in the "System Settings" dialog:

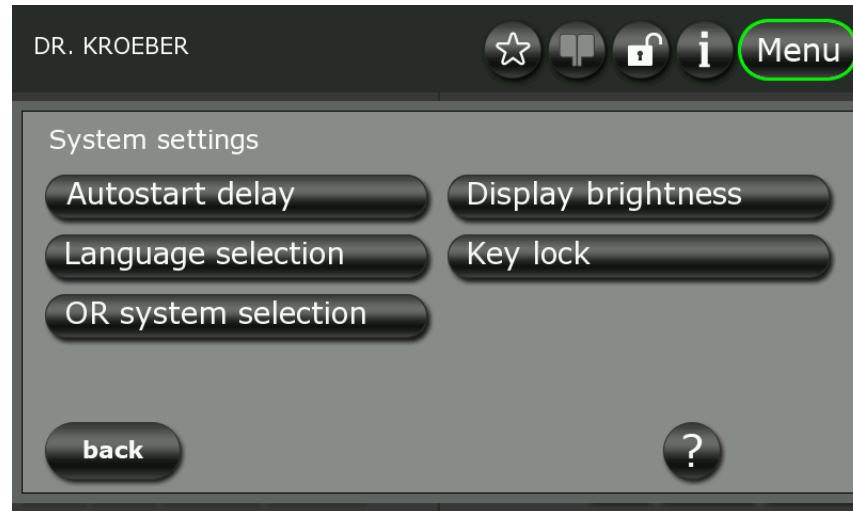

Figure 5-20: "System settings" dialog

The following languages are selectable in „language selection“:

German, English, French, Italian, Spanish, Russian, Polish, Turkish, Japanese, Korean, Thai, Indonesian, Chinese, Portuguese, Czech, Arabic, Hungarian, Danish, Finnish, Vietnamese, Swedish, Dutch, Bulgarian, Serbian, Romanian, Slovakian and Kazakh.

Under "Key lock" you can disable automatic screen lock or set its duration. The duration can be set from 30 seconds to 5 minutes.

A link to an optional OP system can be made under "OR system selection".

5.10.3. "Volume" dialog

Use the "Volume" dialog to set the volume of the individual acoustic signals.

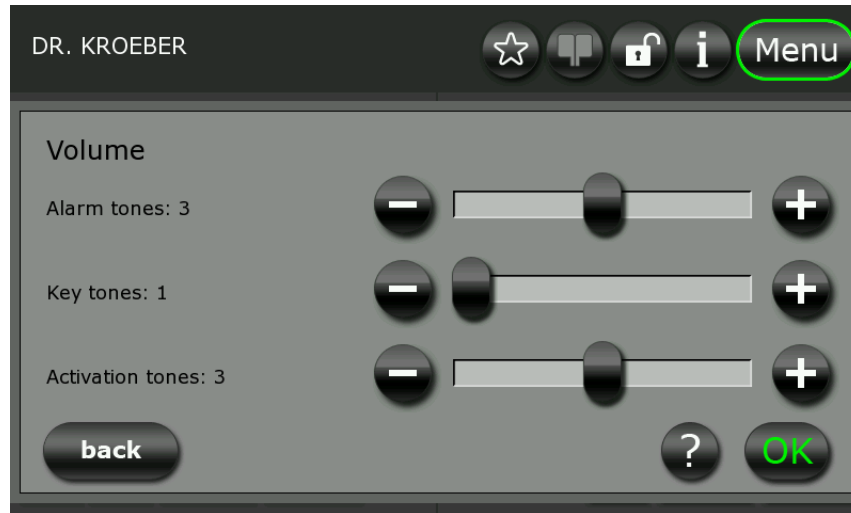

Figure 5-21: "Sound Level" dialog

Incremental setting

- ▶ Press the "+" and "-" buttons.

Fast setting

- ▶ Move the slider in the desired direction.



The volume of the activation signal should be increased as necessary for use in relatively noisy surroundings. The alarm tones have a minimum volume and limited changeability.

Mode	Category	Frequency (Hz)	Signal type
Monopolar Cut	Activation tones	635	Continuous sound
Monopolar Coag	Activation tones	475	Continuous sound
Bipolar Cut	Activation tones	565	Continuous sound
Bipolar Coag	Activation tones	505	Continuous sound
Sim Coag	Activation tones	755	Continuous sound
LIGATION end	Activation tones	-	Alternating sound
Foot switch changeover	Alarm tones	-	Signal tone
ZAP Mode	Alarm tones	-	Signal tone
Error	Alarm tones	-	Signal tone
Warning	Alarm tones	-	Signal tone
Note	Alarm tones	-	Signal tone

5.10.4. "Service" dialog

After entering a password, you can use the "Service" dialog to access additional options, such as resetting the device to the factory default configuration or viewing the instructions of use.

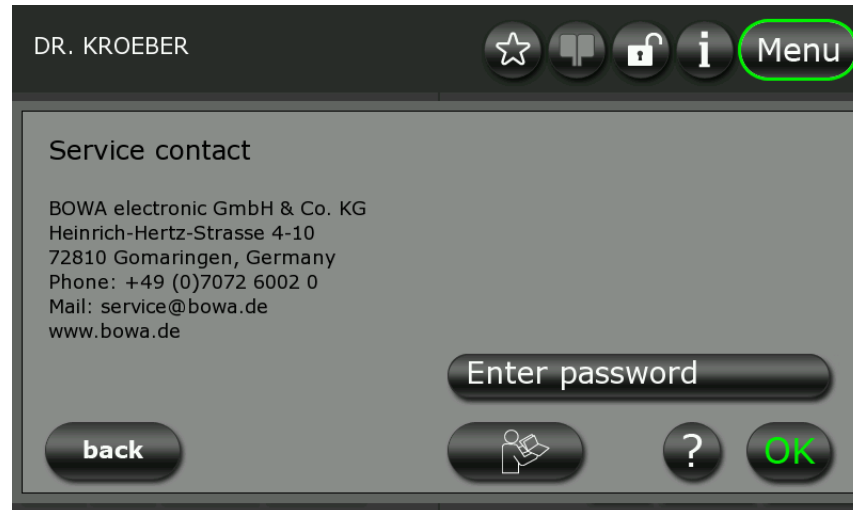

Figure 5-22: "Service" dialog

Opening the operating instructions:

1. Press the "Operating instructions" button.
- ↳ The operating instructions are displayed chapter for chapter.
2. Use the arrow buttons to select the desired chapter.
3. Press "OK" to open the selected chapter.
Use the arrow buttons to open the individual pages of the chapter.
4. Press "back" to return to the chapter overview.

With the password **001224** you enter the service level 1.

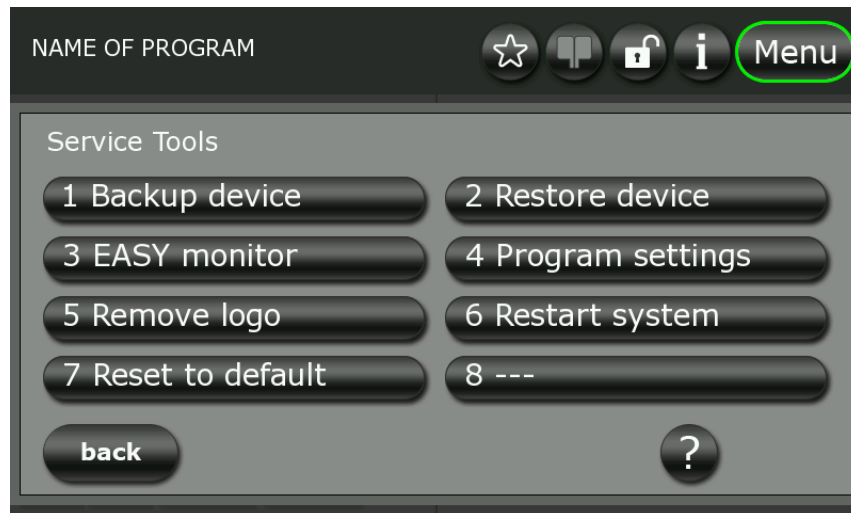

Figure 5-23: "Service Tools" dialog

Saving device settings

With the function "Backup device" device settings can be saved on the BOWA USB Stick (REF 900-402). This includes all stored programs and system settings.

Transferring device settings

Use "Restore device" to transfer saved device settings from a BOWA USB Stick (REF 900-402) to the ARC 400 unit.

Program settings

The "Program settings" function can be used to configure permissions for saving, deleting and editing programs.

Deleting the startup screen

In the service menu, the stored startup screen can be deleted using "Remove logo".

Add logo

See 5.4.9.

Resetting to factory settings

The "Reset to default" function allows you to reset all settings and programs to factory settings.

Save logfiles

This function can be used to save data on a BOWA-approved USB stick. This data can be used for a system analysis and can be sent by email to service@bowa.de, for example.

5.10.5. "System information" dialog

The "System information" dialog displays various System parameters such as version, serial number, TSI date for ARC 400 and if applicable ARC PLUS, as well as options.

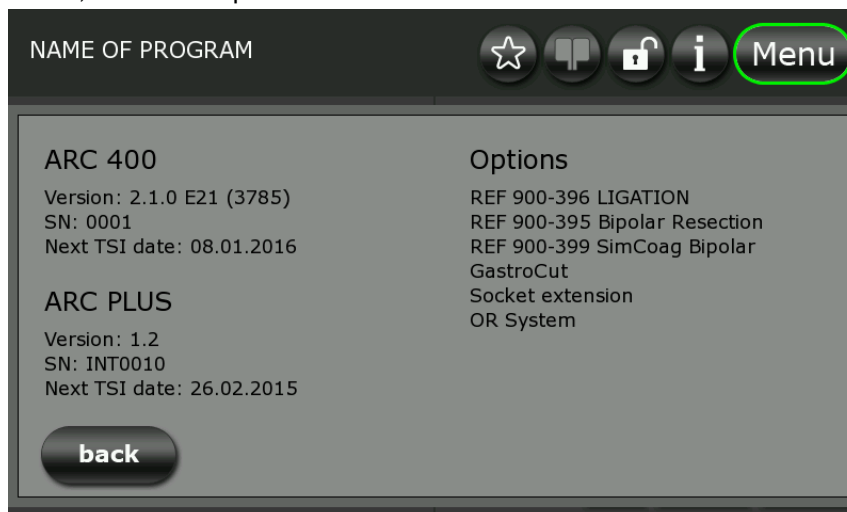

Figure 5-24: "System information" dialog

Moreover, the software version and the next TSI date is displayed, see chapter Safety inspection, page 107.

5.10.6. "Select program" dialog

1. Use the "Select program" dialog to select programs from a list and to add them to the favourites.
- or -
Fast settings of this menu are possible by tapping on the present program name in the main screen.
2. For the selection of a program, tap on the desired program name.
3. The horizontal navigation is possible using the arrows. The programs are always arranged alphabetically in the right column.
4. Use the star symbols at the bottom of the screen to assign programs to the Favourites list. The green arrow is for adding programs to the favourites, and the red arrow is for removing them.
5. The assignment to the favourites is possible using the star button in the lower area of the screen.
6. Press "OK" to load the selected program.
- or -
To return to the main screen click on "back".

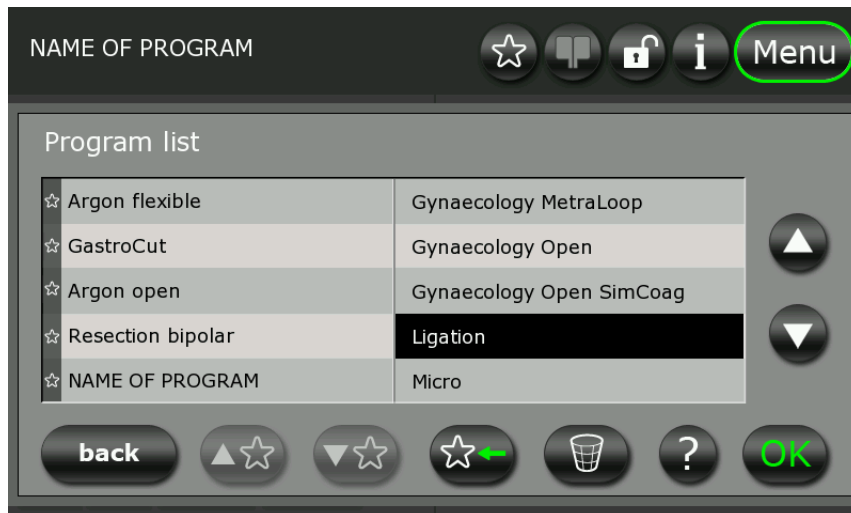

Figure 5-25: "Select program" dialog



Up to 300 programs can be put on the favourites list.

Saved programs can be deleted under "Program".

1. In the program list, select the program to be deleted by touching the program name.
You can also navigate horizontally with the arrows.
2. Touch the "Wastebin" symbol to permanently delete the selected program.
 - ↪ The selected program is deleted after you confirm this in a confirmation prompt.
 - ↪ The default program cannot be deleted.

5.10.7. "Favourites" dialog

Use the "Favourites" dialog to select previously defined favourite programs. A fast selection of the favourites is possible using the star button in the main screen.

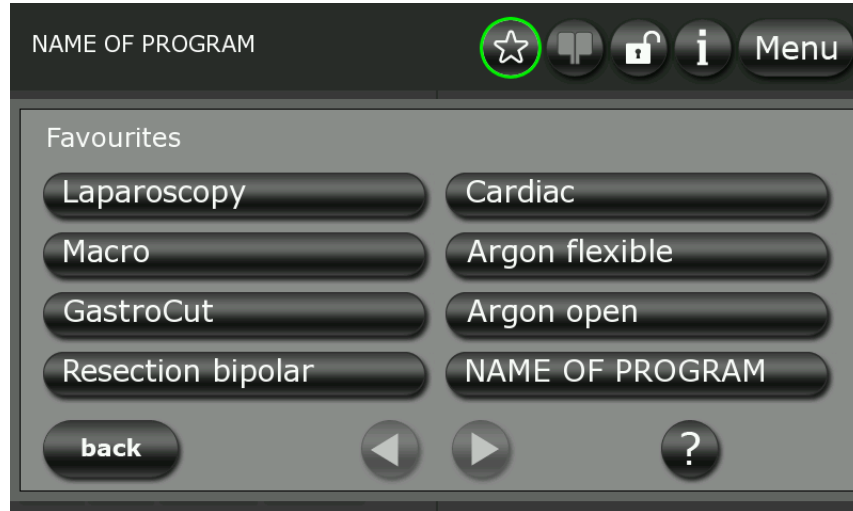

Figure 5-26: "Favourites" dialog

Use the arrow buttons at the bottom of the screen to navigate to the next page of the Favourites list. Confirm with "OK" to accept the selection. To return to the main screen click on "back".

5.10.8. "Save Program" dialog

Use the "Save Program" dialog to save the current program settings under the same name or a different name.



Figure 5-27: "Save program" dialog

With a keypad program names can be created. Several symbols, capital or small letters or numbers are selection options.

You can use the "Enter" button to assign two-line program names.

Confirm with "OK" to accept the selection.

To return to the main screen click on "back".

5.10.9. Socket extension

The bottom bipolar socket can be extended. This allows a total of three bipolar instruments to be connected.



With socket extension active, it is only possible to work with two bipolar ERBE plugs on the bottom bipolar socket. Autostart mode is not available on the extended top socket.

☞ Select "Socket configuration" to access the socket extension screen.



Bild 5-28: Menu "Socket configuration"

☞ Select socket extension for the bottom bipolar socket by touching the right-hand selection area next to the two individual plugs.

Press "OK" to confirm your selection.
Press "Back" to return to the main screen.

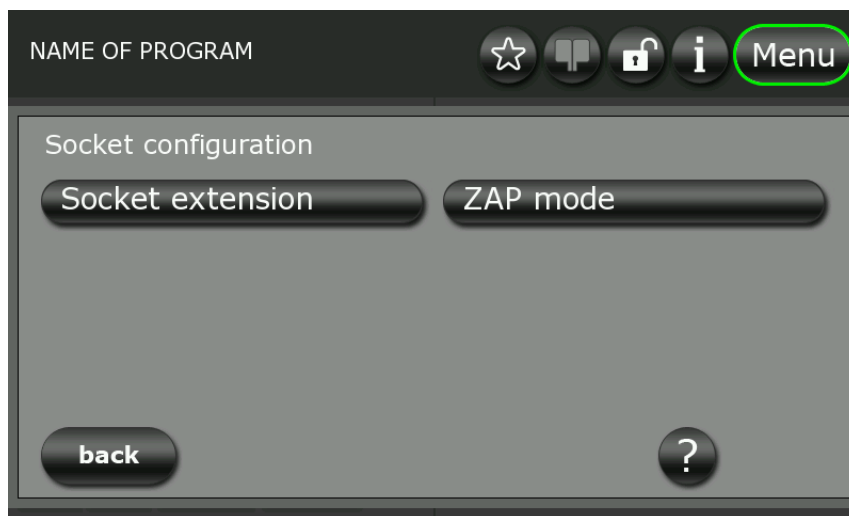

Bild 5-29: Menu "Socket extension"

- You now have three bipolar ports available.
- A socket extension indicator is displayed next to the “Effect” key.



Bild 5-30: Dual operator interface for bottom socket.

5.10.10. ZAP Mode

You can use Zap Mode to switch between two predefined settings for the same instrument.

1. Select Zap Mode on the “Socket configuration” screen.
2. Enable or disable switching for an individual socket by touching the check mark next to the socket.

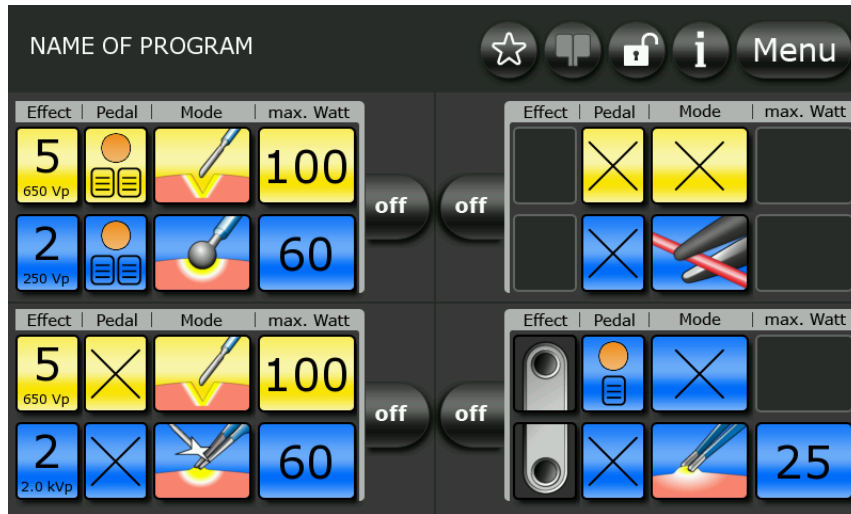

Bild 5-31: Menu “ZAP Mode”

The check mark is filled in when Zap Mode is enabled.

Press “OK” to confirm your selection.

Press “Back” to return to the main screen.

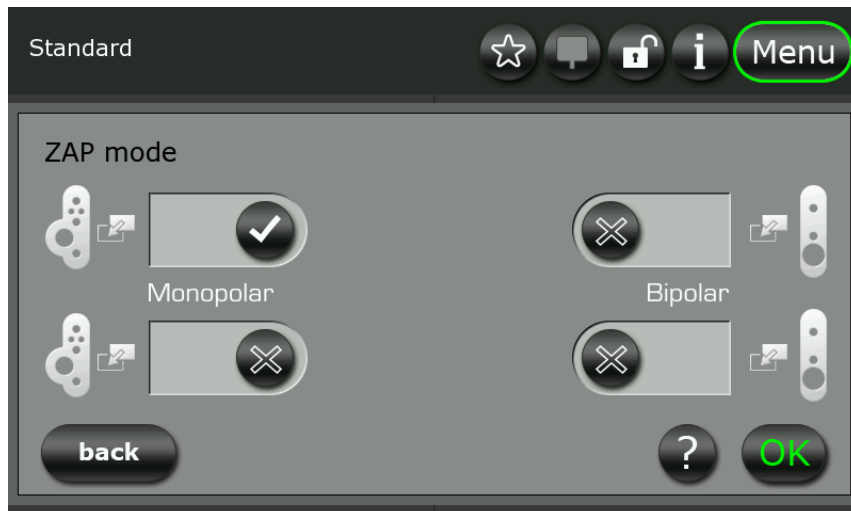
On the main screen, active Zap Mode is indicated by an additional button.



Bild 5-32: Top monopolar socket in Zap Mode

To configure the second socket setting, touch the Zap Mode symbol above the “Off” button.

The colour of the symbol changes from orange to white and the current settings are copied.

Now you can edit the parameters for the second socket setting as desired.

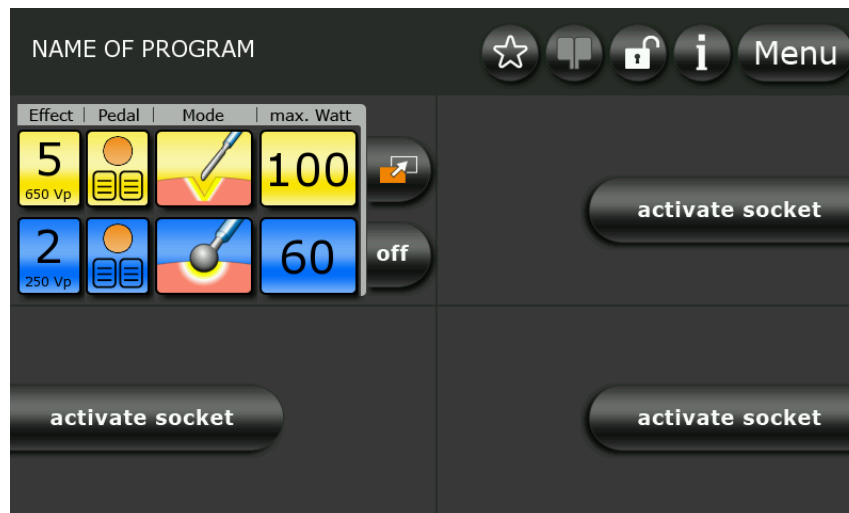

Bild 5-33: Top monopolar socket in Zap Mode Change

Touching the Zap Mode symbol again takes you back to the previous socket setting.

In addition to the described option for switching the setting on the main screen, the setting can be switched with the handle or the foot switch.

Switching with the handle

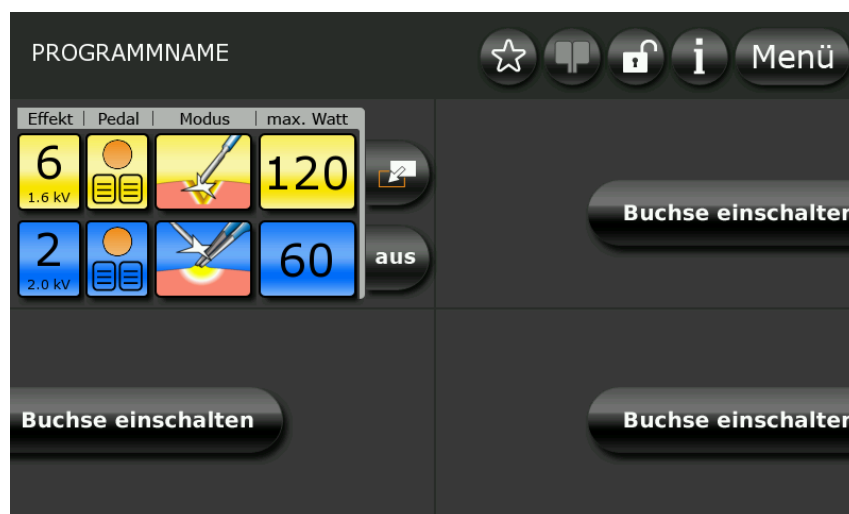
To switch the setting with the monopolar handle, press the two buttons for cutting and coagulation at the same time and hold them pressed for more than one second.

Switching with the foot switch

You can also switch the levels with the orange button on the foot switch. For this purpose, select the Zap Mode symbol below the “Pedal” icon.



Bild 5-34: Zap Mode foot switch selection for cutting

Now the Zap Mode symbol appears on the main screen below the “Pedal” icon.

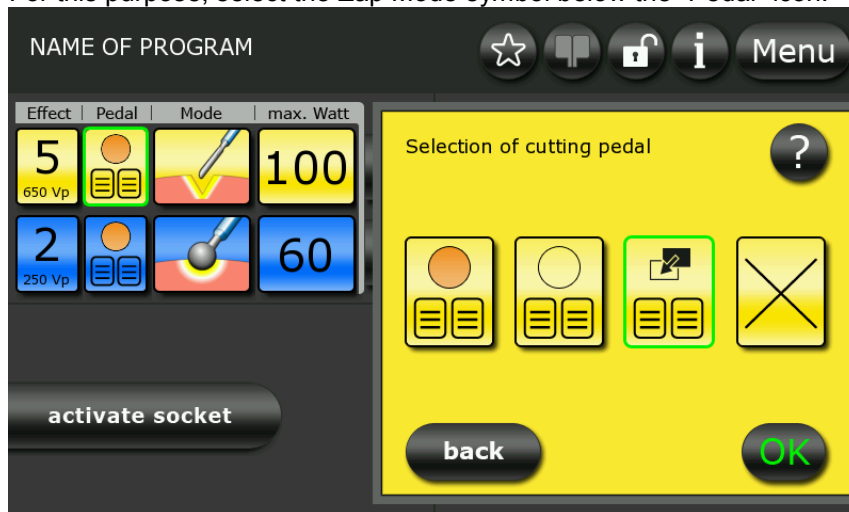

Bild 5-35: ZAP Mode foot switch

You can switch between the two socket settings by pressing the orange button on the foot switch.

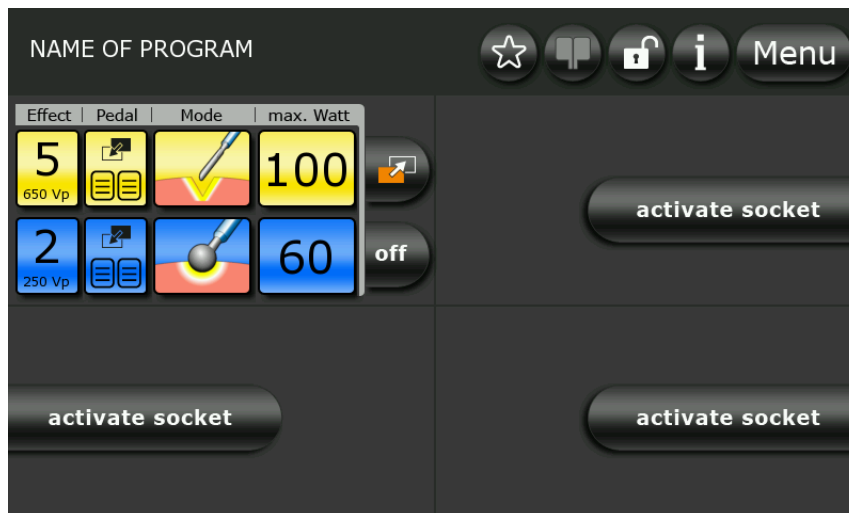

The orange button on the foot switch is now dedicated to Zap Mode switching.

5.10.11. "System messages" dialog

In the "System messages" dialog, it is possible to open the saved system messages which have occurred since switching on the HF device.

These messages are not saved when switching off the HF device.

Opening saved system messages:

1. Select a system message.
2. The selected system message is displayed again with "?".
3. Press "OK" to return to the overview.

Opening the instructions of use:

1. Press the "instructions of use" button.
- ↳ The instructions of use are displayed chapter for chapter
2. Use the arrow buttons to select the desired chapter.
3. Press "OK" to open the selected chapter.

Use the arrow buttons to open the individual pages of the chapter.

4. Press "back" to return to the chapter overview.

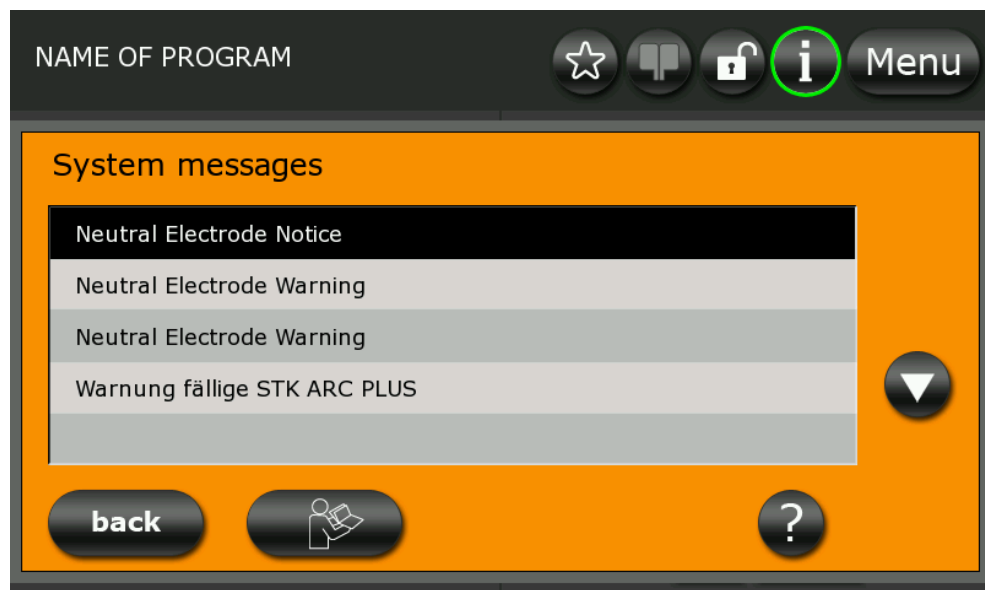

Figure 5-36: "System messages" dialog

5.10.12. "Argon" dialog

In case of the selection of an argon mode and a successful connection to ARC PLUS, this dialog is selectable in the status bar.

The "Argon" dialog enables the selection of argon flow rates for cutting and coagulation, as well as the selection of argon bottles and the display of filling levels.

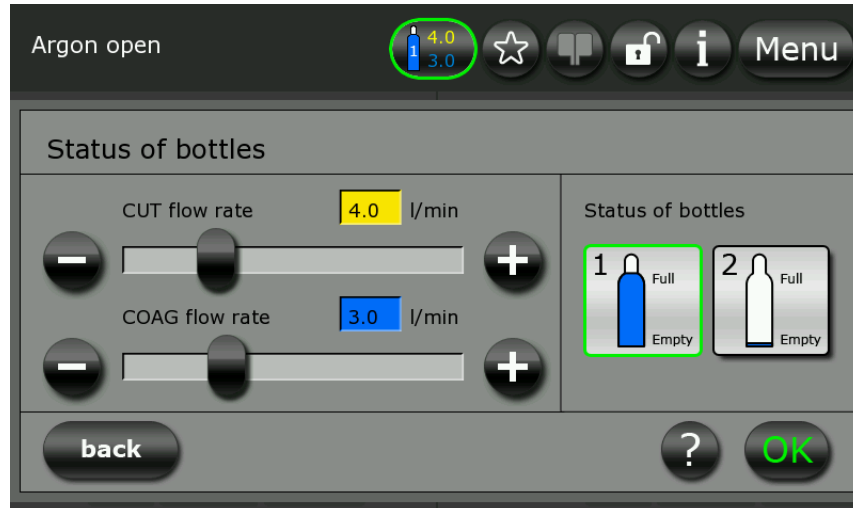

Figure 5-37: "Argon" dialog

1. Use the "+" and "-" buttons to adjust the argon flow rate for cutting (Cut) or coagulation (Coag).
- or -
Use the slider to set the flow rate.
2. In case of two connected argon bottles use the buttons for output "1" or "2" to select the desired gas source.

Pressure reducers with electronic pressure sensor enable the display of exact filling levels of argon bottles.

3. Press the "?" button for more information on this selection.
4. Confirm your selection by pressing the "OK" button.
- or -
Press the "Back" button to return to the main screen without changing the selection.



Default settings for argon flow rates according to the different modes are selected automatically:

Argon open:
CUT flow rate: 4.0 l/min
COAG flow rate: 3.0 l/min

Argon flexible:
COAG flow rate: 0.4 l/min

5.11. Basic programs

The following basic programs are provided with the full version of ARC 400 (incl. the resection bipolar option and the LIGATION option):

- 3 Bipolar
- Argon flexible
- Argon
- Cardiac
- GastroCut
- Laparoscopy
- Ligation
- Macro
- Micro
- Open Surgery
- Resection bipolar
- Resection monopolar
- SimCoag
- SimCoag bipolar
- Standard
- Open surgery ZAP Mode

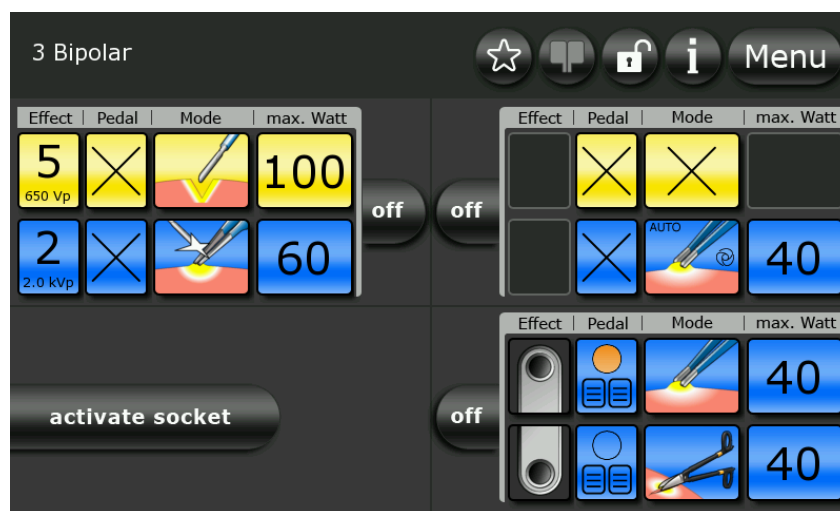

Figure 5-38: Basic program "3 Bipolar"

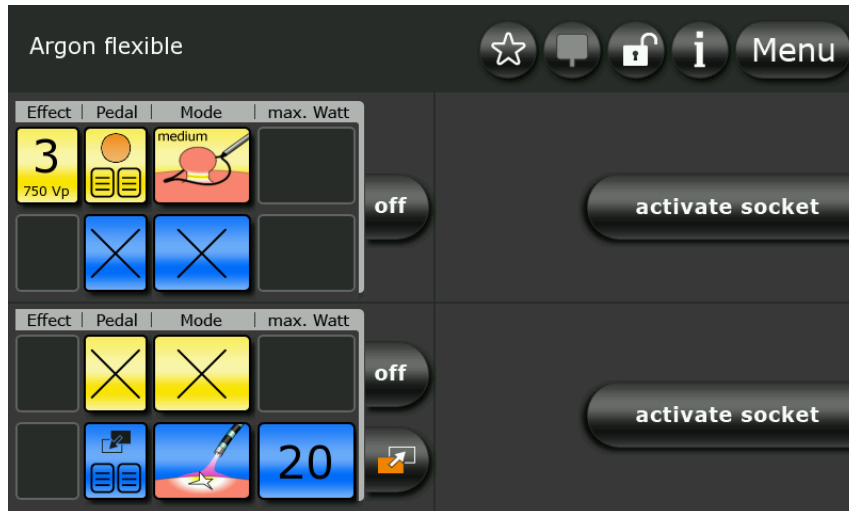

Figure 5-39: Basic program "Argon flexible"



Figure 5-40: Basic program "Argon open"



Figure 5-41: Basic program "Cardiac"

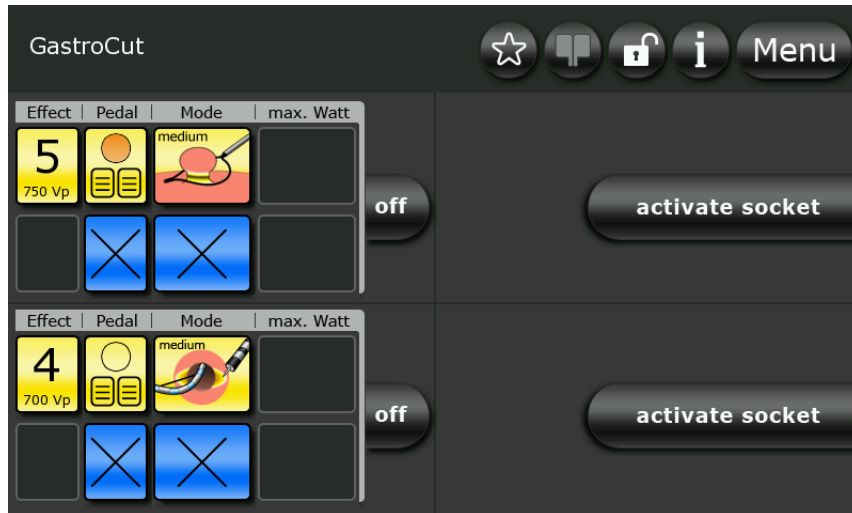

Figure 5-42: Basic program "GastroCut"

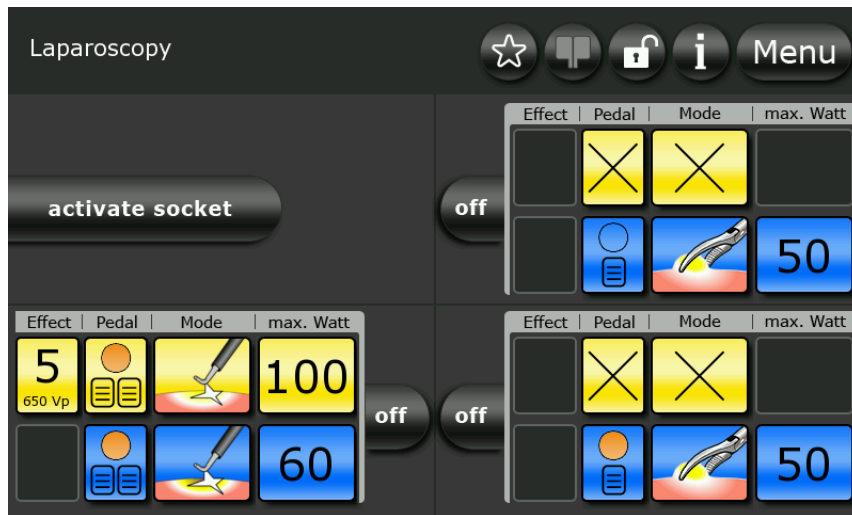

Figure 5-43: Basic program "Laparoscopy"

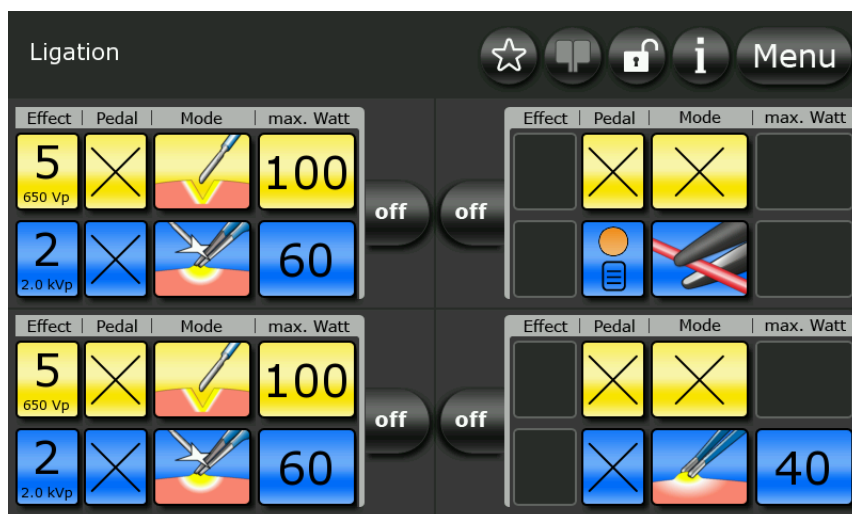

Figure 5-44: Basic program "Ligation"

The LIGATION program is only available when the LIGATION option is present.

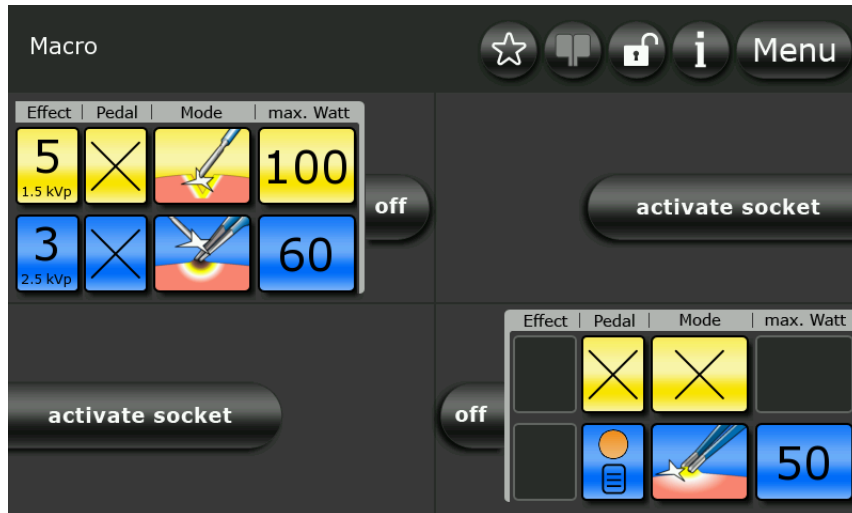

Figure 5-45: Basic program "Macro"

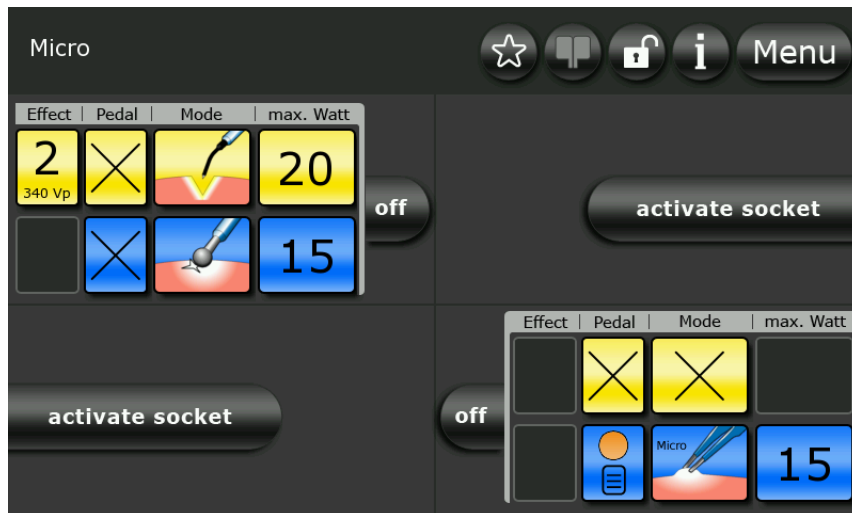

Figure 5-46: Basic program "Micro"

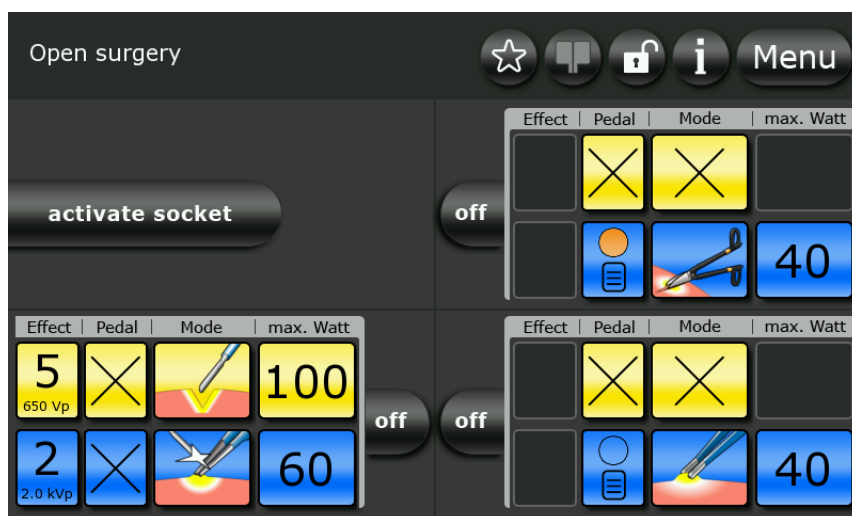

Figure 5-47: Basic program "Open Surgery"

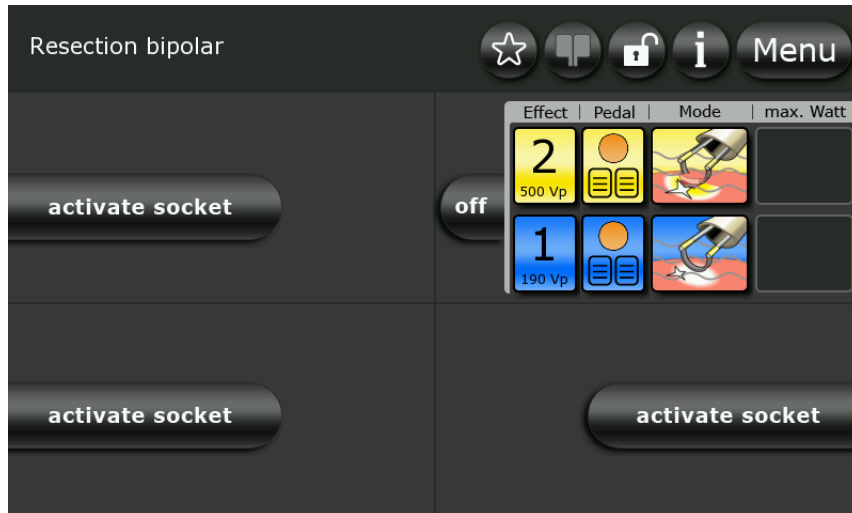

Figure 5-48: Basic program "Resection bipolar"

This program is only available with the resection bipolar option.

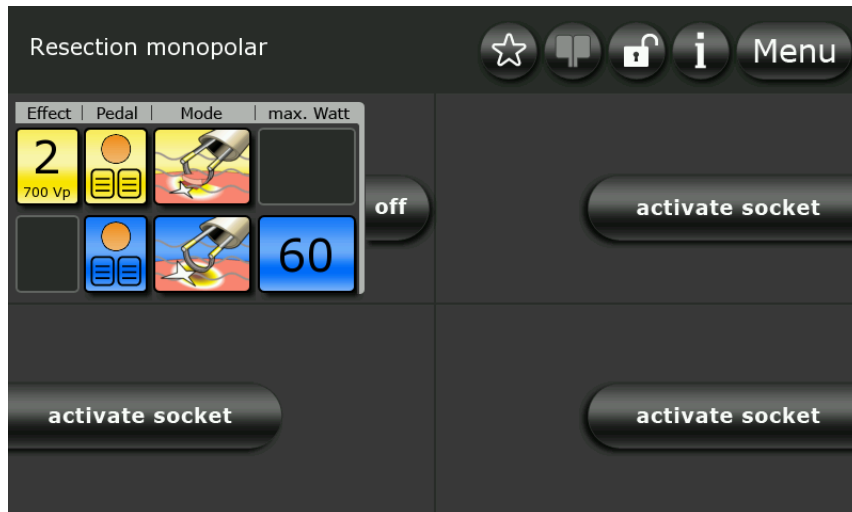

Figure 5-49: Basic program "Resection monopolar"

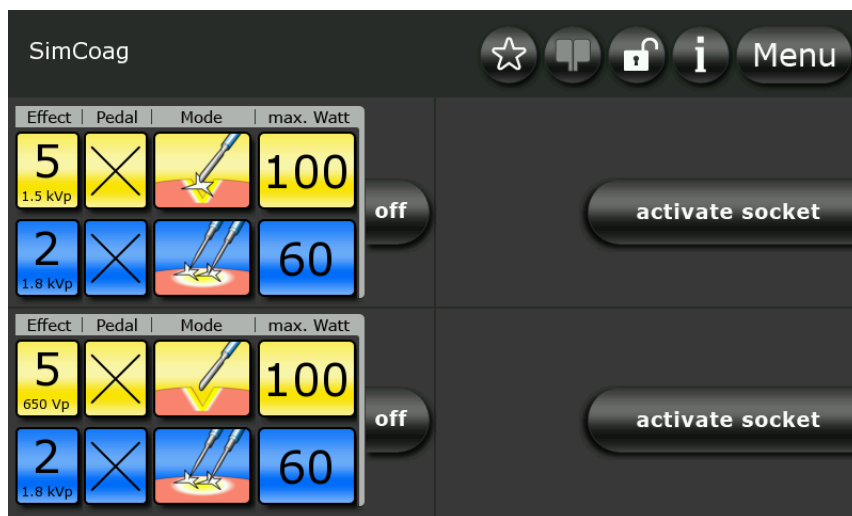

Figure 5-50: Basic program "SimCoag"

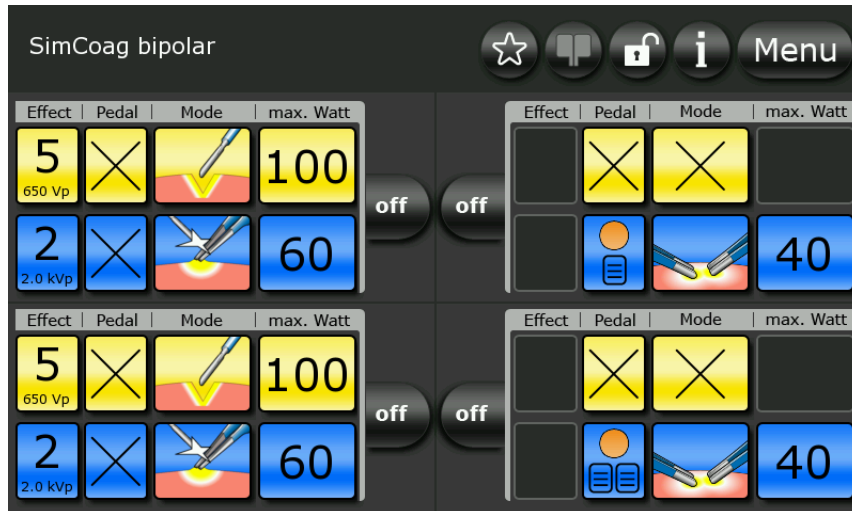

Figure 5-51: Basic program "SimCoag bipolar"

This program is only available with the SimCoag bipolar option.

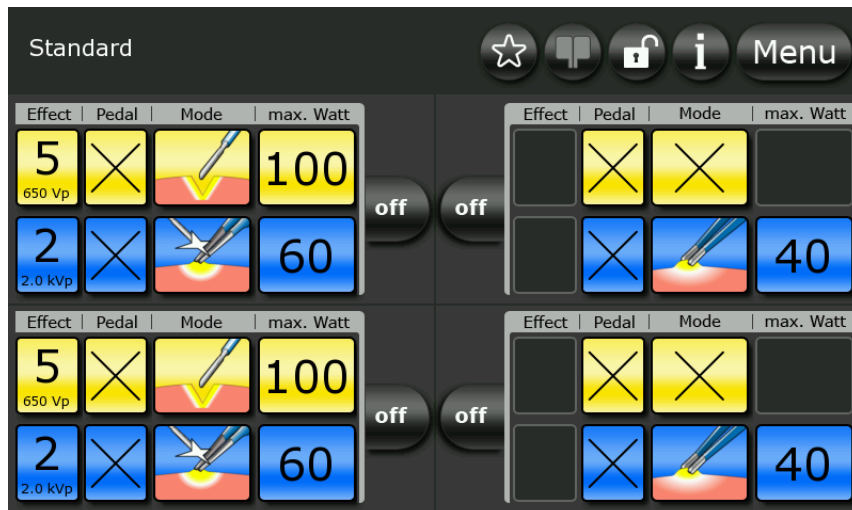

Figure 5-52: Basic program "Standard"

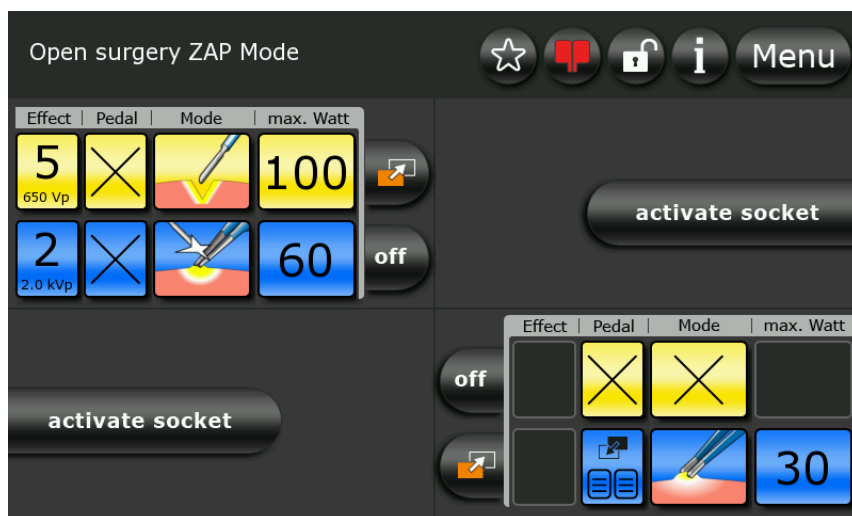

Figure 5-53: Basic program "Open surgery ZAP Mode"

6. Detecting and correcting faults

Two types of faults can occur:

- system faults
- EASY monitoring faults

6.1. System information

A warning message appears on the display when a system fault occurs.

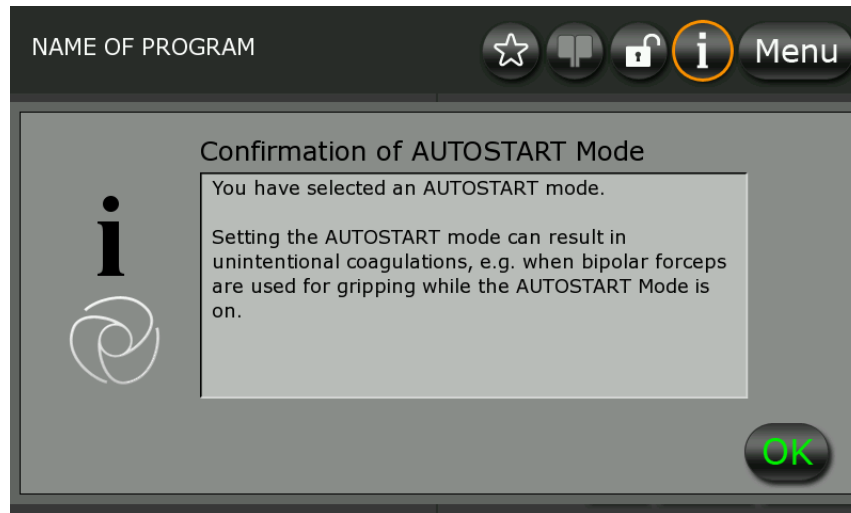

Figure 6-1: Confirmation of AUTOSTART Mode

System information has three different categories:

- Notice (grey screen)
- Warning (orange screen)
- Error (red screen)

Notices are shown for five seconds on the display. Warnings and errors are shown for ten seconds.

While an error is present, activations are prohibited.

The message is available using the orange marked „i“ in the system bar.

The following table describes the cause of the fault and the appropriate corrective action.

Heading	Fault message
Confirmation of AUTOSTART Mode	You have selected an AUTOSTART mode. Setting the AUTOSTART mode can result in unintentional coagulations, e.g. when bipolar forceps are used for gripping while the AUTOSTART Mode is on.
AUTOSTART Fault	The instrument is in contact with tissue. AUTOSTART cannot be selected when the instrument is in contact with tissue. Open up the instrument.
TSI Warning	The annual Technical Safety Inspection (TSI) is due.
Neutral Electrode Fault	No neutral electrode connected. No neutral electrode connected. Connect a neutral electrode.
Neutral Electrode Fault	Wrong neutral electrode connected. The selection does not match the neutral electrode connected. Connect the neutral electrode which matches the selected mode, or change the mode to match the neutral electrode.
Neutral Electrode Fault	Poor contact with the patient. The resistance between the neutral electrode and the patient is too high. Establish better contact of the neutral electrode.
Neutral Electrode Warning	Poor contact with the patient. The contact resistance between the neutral electrode and the patient is increasing. Establish better contact of the neutral electrode.
Neutral Electrode Fault	No cable for neutral electrode connected. No cable for neutral electrode connected. Connect a cable for neutral electrodes.
Neutral Electrode Notice	No cable for neutral electrode connected. The cable for neutral electrode has been removed. Monopolar activation is not possible.
Mode Fault	No mode selected. No mode was selected for this type of activation. Select the desired mode or change the foot switch assignment.
Mode Fault	This mode is not allowed for baby neutral electrodes. Use split neutral electrodes with a large conductive surface for this mode.
Mode Fault	This mode is not allowed for this socket. The current mode remains active. Choose another socket for this mode.
Foot Switch Fault	No compatible foot switch connected. The connected foot switch is not compatible with this device. Connect a compatible foot switch with an orange button.
Foot Switch Fault	Foot switch not assigned to a socket. The foot switch has not been assigned to a socket yet. Assign a socket to the foot switch using the "Pedal" button.

Heading	Fault message
Foot Switch Fault	Fault on foot switch connection. Check the foot switch. If this message appears again, please contact the Technical Support. Contact: MENU - SERVICE.
Finger Switch Fault	Fault on finger switch connection. Check the handle and the connection cable. Please replace them if damaged. If this message appears again please contact the Technical Support. Contact: MENU - SERVICE.
Temperature Warning	The temperature of the device is higher than normal. The temperature of the device is elevated. This leads to a reduction of the maximum power.
Limitation of Continuous Activation	The maximum activation time has been exceeded. Please only activate the generator in short intervals, in order to avoid harming the patient and damaging the connected instruments or the generator.
Activation Fault	While switching on the device, there is an activation by foot switch, finger switch or AUTOSTART. Check the handles or foot switches for malfunctions. Disconnect the handles / foot switches from the device. If the error persists, please contact the Technical Support. Contact: MENU - SERVICE.
Activation Fault	There is an activation while connecting the foot switch or finger switch. Check the handles or foot switches for malfunctions. Disconnect the handles / foot switch from the device. If the error persists, please contact the Technical Support. Contact: MENU - SERVICE.
Activation Fault	There is no instrument connected on the activated socket. Connect an instrument on the designated socket.
Activation Warning	The mode for safety inspections is active. Activation is not possible. Quit this mode before activating again.
Bipolar Resection Warning	Use a BOWA COMFORT resection cable. Be sure to use NaCl as the rinsing liquid. Perform continuous rinsing during the application. Use only conductive gel to avoid damage to the urinary tubes. Avoid continuous activation.
GastroCut Warning	Polypectomy snare not in contact with tissue, or check connection cable at snare or generator. Please apply the snare and reactivate. First of all establish contact between tissue and polypectomy snare, or check the connection cable at the snare or the generator. Then activate with the yellow foot pedal.
LIGATION Notice	Grasp tissue again.

Heading	Fault message
LIGATION Warning	<p>There is a short-circuit in the area of the sealing instrument. Possible remedies: Clean the inner surface of the jaw. The jaw and sealing area must be free of foreign objects such as clamps and tissue residues. Check the instrument and cable for damage. Check the connection to the generator. Follow the instructions for use for the instrument.</p>
LIGATION Warning	<p>The sealing instrument is not in contact with tissue. Possible remedies: Clean the inner surface of the jaw. The jaw and sealing area must be free of foreign objects such as clamps and tissue residues. Check the instrument and cable for damage. Check the connection to the generator. Follow the instructions for use for the instrument.</p>
ARC PLUS Fault	<p>Connect the argon device to the generator and switch it on. The argon device is connected to the generator by fibre optic cables. The active argon device is automatically connected via the generator when an argon mode is activated.</p>
ARC PLUS 5100 Internal Fault	<p>ARC PLUS not operational. Connect an operational argon device to the generator. If the warning message persists, please contact the Technical Support. Contact: MENU - SERVICE.</p>
ARC PLUS Fault	<p>Please check if the argon bottles are connected and open. Empty bottles should be replaced. Subsequently restart ARC PLUS by activating the flashing "Purge" button. You can connect two argon bottles. A change to the replacement bottle occurs automatically.</p>
ARC PLUS Fault	<p>The argon inlet pressure is too high. Max. inlet pressure: <4.5bar Connect a source of argon gas in the appropriate pressure range. Subsequently restart ARC PLUS by activating the flashing "Purge" button.</p>
ARC PLUS Fault	<p>The argon inlet pressure has exceeded the permissible limits. Inlet pressure range: 2 - 4.5bar Connect a source of argon gas in the appropriate pressure range. Subsequently restart ARC PLUS by activating the flashing "Purge" button.</p>
ARC PLUS Warning	<p>Mixed operation of argon bottles with and without an electric bottle pressure gauge is not recommended Connect two identical pressure reducers.</p>
ARC PLUS Warning	<p>Check if the instrument is free of adhesions, and purge it with argon. If repeated purging does not solve the problem, the instrument and cable must be replaced.</p>

Heading	Fault message
ARC PLUS Fault	Check if the argon bottles are connected and open. Empty bottles should be replaced. You can connect two argon bottles. A change to the replacement bottle occurs automatically.
ARC PLUS Warning	The filling level of the argon bottle is low. Please make sure that a replacement is available. You can connect two argon bottles. The unit shifts automatically to the second bottle.
ARC PLUS Fault	The argon bottle is empty. Connect a replacement bottle to enable activation. You can connect two argon bottles. The unit shifts automatically to the second bottle
ARC PLUS Notice	The argon bottle is empty. The unit has shifted automatically to the replacement bottle. Please make sure that a replacement is available.
ARC PLUS Notice	The argon bottle is empty. The unit shifts automatically to the replacement bottle. Please make sure that a replacement is available.
ARC PLUS Fault	Please check if the argon bottles are connected and open. Empty bottles should be replaced. Subsequently restart ARC PLUS by activating the flashing "Purge" button.
TSI ARC PLUS Warning	The annual Technical Safety Inspection (TSI) for ARC PLUS is due.
Plug'n Cut COMFORT Notice	The lifetime of the instrument is ending soon. Please order a replacement in good time. Any use of the instrument beyond its lifetime is not covered by warranty. Please contact your BOWA dealer in good time to purchase a new instrument.
Plug'n Cut COMFORT Warning	The maximum lifetime of the instrument has been reached. Any further use is not covered by warranty. The maximum service lifetime of the instruments must not be exceeded, in order to guarantee safe usage. Any further use is at the user's risk.
Plug'n Cut COMFORT Warning	A software update is necessary to use Plug'n Cut COMFORT with this instrument. Only carry out manual settings at this instrument. Please contact the Technical Support. Contact: MENU - SERVICE.
Plug'n Cut COMFORT Warning	Unable to load the preference parameters of the COMFORT instrument. Configure the instrument settings manually. Please contact the Technical Support. Contact: MENU - SERVICE.

Heading	Fault message
Dr. Dongle Warning	A fault occurred while loading the program. No changes have been made. If the warning message persists, please contact the Technical Support. Contact: MENU - SERVICE.
Dr. Dongle Warning	The selected program does not have any parameters. Put a valid program in this memory or select a different memory location.
Internal Error XXXX (z.B. mit XXXX = 4183)	If this message appears again, please contact the Technical Support. Contact: MENU - SERVICE.

Internal Errors have a number next to the description.
Please advise the Technical Service of this number.

6.2. Fault indications for EASY monitoring

Fault indications are displayed in three stages (green, yellow and red) when problems occur.

When working with a split neutral electrode, the following faults may occur:

EASY monitoring	Cause	Indication	Corrective measures
Flashes yellow	Significant increase in resistance Depending on the indication, there may be heating under the neutral electrode	–	Stopping the application is not necessary. ▶ Check the proper application of the neutral electrode.
Switches from green to continuous red	A significant problem occurred when the monopolar current was activated	An acoustic signal sounds. A warning message appears on the display <ul style="list-style-type: none"> • Notice (grey screen) • Warning (orange screen) • Error (red screen) 	▶ Check the neutral electrode and neutral electrode cable (see Section EASY neutral electrode monitoring (EASY monitoring), page 35). ▶ Check the neutral electrode cable for proper connection and external damage.
	Loosened electrode	An acoustic signal sounds. A warning message appears on the display <ul style="list-style-type: none"> • Notice (grey screen) • Warning (orange screen) • Error (red screen) 	▶ Reattach the neutral electrode. If the fault persists, replace the neutral electrode.

7. Preparation

7.1. Preparation of the accessories

- ▶ Prepare the accessories (e.g. surgical handles, instruments, active electrodes, neutral electrodes and cables) as described in the corresponding operating manuals.
- ▶ Check the accessories before and after use for damage and to ensure that they are working properly.

7.2. Disinfection and cleaning



NOTE

Incorrect handling of the HF device can cause damage to the unit!
Never sterilize the ARC 400 device. Instead, clean or disinfect it.



WARNING

Risk of electric shock and fire!

- ▶ Unplug the power connection before cleaning the device.
- ▶ For cleaning surfaces, use the approved cleaning agents/disinfectants only as specified by the manufacturer.
- ▶ Ensure that no liquid penetrates the device.
- ▶ Ensure that the AUTOSTART function is deactivated.

1. Apply the cleaning agent and disinfectant.
BOWA recommends the use of cleaning and disinfection agents which are suitable for surface cleaning of medical devices made of plastic, metal and glass.
The manufacturer accepts no responsibility if other types of cleaning and disinfecting agents are used.
Follow the instructions provided by the manufacturer of the cleaning agent.
2. Wipe the agent off with a sponge moistened with clean water or with a cloth.
3. Dry the device using a clean, lint-free cloth.

8. Maintenance and repair

8.1. Maintenance



DANGER

Infection hazard!

- ▶ Carry out a surface disinfection and wrap the device in addition to the shipping packaging material before allowing the device to leave the hospital or office to avoid spreading germs and infections.

- ▶ Check the device, the device trolley and the accessories (e.g. foot switch, cable) after each use for damage or defects. In particular, make sure that the insulation is intact on all cables.
- ▶ Do not use any damaged device, damaged device trolley or damaged accessories.
- ▶ Replace defective accessories immediately.
- ▶ Have the safety inspection for the device performed once a year. Please consult and comply with the respective service instructions for additional technical information.

8.1.1. Safety inspection

Safety inspections must be performed once a year.

- ▶ The next safety inspection date of ARC 400 can be displayed in the dialog, see section 5.10.5 "System information" dialog, page 84.
- ↳ A warning message appears during system start-up if a safety inspection is due.
Press OK to confirm this message.



Any shorter safety inspection cycles specified in national regulations must be observed.

- ▶ The device and accessories may be inspected only by persons who have the required training, knowledge or experience and who can perform the inspection independently.
- ▶ With regard to the safety inspection, you must comply with the country-specific rules and regulations.

The tester documents the inspection results and measured values according to the printed test record in the service manual. If you do not have a copy of the service manual, please contact your dealer or one of the service addresses listed below.

In the case of severe deviations from the values of the service test record, or if the specified maximum values were exceeded:

- ▶ Send the HF device to the service center, see section Technical service, page 109.

8.2. Repairs



NOTE

You can damage the HF device by doing your own repairs and modifications of medical equipment!

- ▶ If a repair is necessary, have it done only by the service center specified below.
- ▶ Never carry out any repairs yourself.

BOWA is liable for safety, reliability and performance of the HF device under the following conditions:

- Full compliance with all instructions regarding the installation and proper use for the intended purpose contained in this operating manual was maintained.
- Changes, repairs, new settings and similar procedures were carried out only by persons authorized to do this work by BOWA.
- The electrical installations in the relevant room meet the local requirements and statutory provisions.



Fast and satisfactory repairs can only be guaranteed when all required data have been supplied in full.

The following information is required for returning the device:

- complete address
- model number
- serial number
- software version
- ▶ Describe the problem, the appropriate application and the accessories used.

– or –

- ▶ Describe the repairs to be made.

9. Storage

- ▶ If you store the HF device for longer than one year, pay specific attention to the indicators during automatic functional testing, see section Functional test, page 33.
- ▶ Clean the HF device thoroughly before you put it into storage.
- ▶ Store the HF device in a clean, dry place in accordance with the storage conditions.

Storage conditions:

- Temperature: -20 °C to +50 °C
- Relative humidity 0 to 90 %, non-condensing
- Atmospheric pressure: 500 to 1060 hPa

9.1. Technical service

Contact the following service center for maintenance and repair work:

BOWA-electronic GmbH & Co. KG

Heinrich-Hertz-Strasse 4–10

72810 Gomaringen, Germany

Phone +49 (0) 7072-6002-0

Fax +49 (0) 7072-6002-33

Email service@bowa.de

or visit our website:

www.bowa.de

10. Technical specifications

10.1. ARC 400 technical data (REF 900-400)

Insulation type / Classification	
EMC	IEC 60601-1-2
Level of protection provided by the housing	IP 21
Protection class according to EN 60601-1	I
Application component type according to EN 60601-1	CF
Standards compliance	IEC 60601-1: 2005, IEC 60601-1-2:2007, IEC 60601-2-2: 2009, ISO 14971: 2007 ISO 13485: 2003 + Cor.1 2009
Classification according to EC Directive 93/42/EEC	IIb

Power connection	220 V - 240 V	100 V - 127 V
Min. Power consumption	3 W / 40 VA	3 W / 40 VA
Min. Current consumption	200 mA	400 mA
Max. power consumption (at 400 W)	700 W / 1150 VA	700 W / 1150 VA
Max. current consumption (at 400 W)	5 A	10 A @ 100 V 8 A @ 127 V
Line fuses	2 x T 5 AH 250 V	2 x T 10 AH 250 V
Mains frequency	50 / 60 Hz	50 / 60 Hz
Terminal for potential equalization	√	√

Dimensions and weight	
Dimensions	430 x 180 x 475 mm
Net weight	12,5 kg
Packaging information /dimensions	Carton 685 x 497 x 280 mm
Gross weight	18 kg

Programs	
Number of programs in the device	300
Default programs, factory set	Yes
Individually programmable	Yes
Information shown on the display	Yes

Neutral electrode monitoring	
EASY (Electrode Application System)	Yes
Display indication of one-piece or split or Baby electrode	Main and neutral electrode menu
Contact resistance between individual sections of split neutral electrodes shown on display	Using color and contact indicator
Lead resistance shown on the display when a non-split neutral electrode is used	Yes
Maximum allowable resistance between the sections of a split electrode	300 Ω
Warning signal for hazardous conditions concerning neutral electrode	Visual, acoustic
Tones	Warning, activation, key, starting sound
Warning message on the display	Text message with further information

Safety features	
ISSys (Integrated Safety System)	Yes
Spark regulation	ARC CONTROL
Continuous monitoring of HF leakage current and fault indication	Text message with further information
Dosage monitoring with fault indication on the display	Yes
Continuous self-test	Yes
Continuous status indication on the display	Yes
Operating errors shown on the display	Text message with further information
System faults shown on the display	Text message with further information
Technical Safety Inspection (TSI)	Automatic memory function (optional)
Operating manual	Direct access in the display, additionally provided as hardcopy and USB-Stick incl. PDF

Documentation	
Data acquisition and storage in the device	System information
Documentation of fault states	Yes
Documentation of operating errors	Yes
Retrieval of system information via the display	Text message with further information





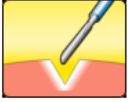
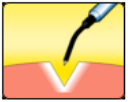
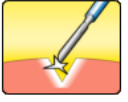
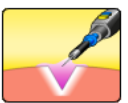
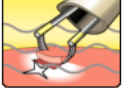
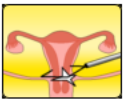
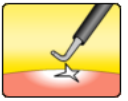

Communication	
Display	Capacitive touchscreen 9"
External interface for communication of HF generator and ARC PLUS	Light wire cables
USB interface for software updates	Yes
External PC interface for service support using BOWA software	CAN / UART

Service support	
Network port for service support	Yes
Service support by service programs integrated in the device	Yes
Service support via ISSys	Yes
Cooling	
Convection	Yes
Temperature-controlled fan	Yes
Duty factor	
Duty factor	Intermittent 10 s / 30 s (on / off)
Characteristics	
Max. MONOPOLAR power	400 W (at 200 Ω)
Max. BIPOLAR power	400 W (at 75 Ω)
Output frequency	350 kHz / 1 MHz
Monopolar sockets	2x (footswitch and finger switch)
Bipolar sockets	3x (3x footswitch and 2x finger switch)
Connection for footswitch	2x
AUTOSTART	Yes
Options	Bipolar Resection M098-900395, LIGATION M098-900396, Bipolar SimCoag M098-900399
Scope of delivery	Incl. Dr. Dongle, USB Stick, operating manual, mains cable, PE-line
RFID	
Transmitter frequency	13,56 MHz
Duty cycle	0-100%
Modulation scheme	AM
Antennas	Two internal antennas (antenna diversity – no simultaneous transmission on both antennas)
Number of channels	1
Max. RF output power	33dBm (<< 42 dB μ A/m at 10m)
Applied RF standards	ETSI EN 300330-1 V1.7.1 (2010-02) ETSI EN 300330-2 V1.5.1 (2010-02)
Compatibility	
Permitted combinations	ARC PLUS (900-001), footswitch (901-031, 901-032, 901-011)

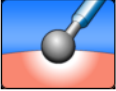

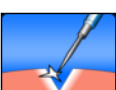
Conditions of operation, transport and storage	Operation	Transport and storage
Temperature	+10°C to +40°C	-20°C to +50°C
Relative humidity	30 to 75%, non-condensing	0 to 90%, non-condensing
Atmospheric pressure	700 to 1060 hPa	500 to 1060 hPa
Operating altitude (max.)	3000 m above sea level	

Mode icon	Description	CCS	ARC CONTROL	Form of HF voltage	Max. power output		Peak voltage	Default values		Rated load resistance	Modulation	
					Effect	Power range		Effect	Max. Watt		Frequency	Duty cycle
Modes Monopolar Cutting												
	Standard	Yes	Yes	sinusoidal constant	1 2 3 4 5 6 7 8 9	1 W – 400 W	400 Vp 450 Vp 560 Vp 650 Vp 650 Vp 700 Vp 700 Vp 700 Vp 750 Vp	5	100	200 Ω	---	---
	Micro	Yes	yes	sinusoidal constant	1 2 3 4 5 6 7 8 9	1 W – 50 W	280 Vp 340 Vp 380 Vp 400 Vp 400 Vp 400 Vp 450 Vp 450 Vp 450 Vp	5	20	500 Ω	---	---
	Dry	Yes	yes	sinusoidal modulated	1 2 3 4 5 6 7 8 9	1 W – 200 W	1.4 kVp 1.4 kVp 1.4 kVp 1.4 kVp 1.5 kVp 1.6 kVp 1.6 kVp 1.6 kVp 1.6 kVp	5	100	500 Ω	20 kHz	30 % 30 % 30 % 30 % 25 % 20 % 20 % 20 % 20 %
	Argon	Yes	yes	sinusoidal constant	1 2 3 4 5 6 7 8 9	1 W – 300 W	400 Vp 450 Vp 560 Vp 650 Vp 650 Vp 700 Vp 700 Vp 700 Vp 750 Vp	5	100	500 Ω	---	---
	Resection	Yes	yes	sinusoidal constant	1 2 3 4 5	250 W	650 Vp 700 Vp 700 Vp 700 Vp 750 Vp	2	---	500 Ω	---	---
	MetraLOOP	Yes	Yes	sinusoidal constant	1 2 3	300 W 350 W 400 W	650 Vp	1	---	100 Ω	---	---
	Laparoscopy	Yes	Yes	sinusoidal constant	1 2 3 4 5 6 7 8 9	1 W - 200W	400 Vp 450 Vp 560 Vp 650 Vp 650 Vp 700 Vp 700 Vp 700 Vp 750 Vp	5	100	500 Ω	---	---

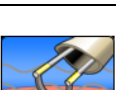
Mode icon	Description	CCS	ARC CONTROL	Form of HF voltage	Max. power output		Peak voltage	Default values		Rated load resistance	Modulation	
					Effect	Power range		Effect	Max. Watt		Frequency	Duty cycle
	GastroLOOP 1	Yes	Yes	sinusoidal alternating Cut, Coag and break phases	1 2 3 4 5	400 W	750 Vp	3	---	500 Ω	---	---
	GastroLOOP 2	Yes	Yes	sinusoidal alternating Cut, Coag and break phases	1 2 3 4 5	400 W	750 Vp	3	---	500 Ω	---	---
	GastroLOOP 3	Yes	Yes	sinusoidal alternating Cut, Coag and break phases	1 2 3 4 5	400 W	750 Vp	3	---	500 Ω	---	---
	GastroKNIFE 1	Yes	Yes	sinusoidal alternating Cut and Coag phases	1 2 3 4 5	300 W	650 Vp 650 Vp 650 Vp 700 Vp 750 Vp	3	---	500 Ω	---	---
	GastroKNIFE 2	Yes	Yes	sinusoidal alternating Cut and Coag phases	1 2 3 4 5	300 W	650 Vp 650 Vp 650 Vp 700 Vp 750 Vp	3	---	500 Ω	---	---
	GastroKNIFE 3	Yes	Yes	sinusoidal alternating Cut and Coag phases	1 2 3 4 5	300 W	650 Vp 650 Vp 650 Vp 700 Vp 750 Vp	3	---	500 Ω	---	---

Mode icon	Description	CCS	ARC CONTROL	Form of HF voltage	Max. power output		Peak voltage	Default values		Rated load resistance	Modulation	
					Effect	Power range		Effect	Max. Watt		Frequency	Duty cycle
Modes Monopolar Coagulation												
	Moderate			sinusoidal constant	1 2 3	1 W – 120 W	250 Vp	2	60	75 Ω	---	---
	Forced non cutting			pulsed modulated	-	1 W - 80 W	3.5 kVp	---	50	1000 Ω	20 kHz	1 pulse
	Forced mixed			sinusoidal modulated	1 2 3	1 W – 120 W	1.5 kVp 2.0 kVp 2.5 kVp	2	60	500 Ω	30 kHz	sinusoidal 1 pulse
	Forced cutting			sinusoidal modulated	1 2 3 4	1 W – 250 W	1.5 kVp 1.5 kVp 1.3 kVp 1.3 kVp	2	80	500 Ω	20 kHz	30 % 35 % 40 % 50 %
	Spray			pulsed modulated	1 2 3 4	1 W – 120 W	3.0 kVp 3.8 kVp 4.6 kVp 5.0 kVp	2	80	500 Ω	20 kHz	sinusoidal 1 pulse 1 Impuls 1 Impuls 1 Impuls
	Argon			pulsed modulated	-	1 W – 120 W	4.6 kVp	---	80	500 Ω	20 kHz	1 pulse
	Argon flexible			pulsed modulated	-	1 W – 120 W	4.4 kVp	---	20	500 Ω	Power dependent 1 kHz - 20 kHz	1 pulse
	Argon flex. pulse			pulsed modulated	1 2 3	1 W – 80 W	4.4 kVp	2	20	500 Ω	Power dependent 1 kHz - 20 kHz	1 pulse 1 pulse 1 pulse
	Resection			sinusoidal modulated	-	1 W -120 W	2.2 kVp	---	60	500 Ω	30 kHz	sinusoidal 1 pulse

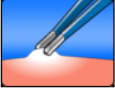
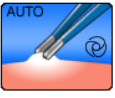
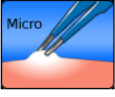
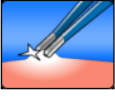
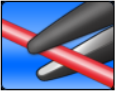
Mode icon	Description	CCS	ARC CONTROL	Form of HF voltage	Max. power output		Peak voltage	Default values		Rated load resistance	Modulation	
					Effect	Power range		Effect	Max. Watt		Frequency	Duty cycle
Modes Monopolar Coagulation												
	Cardiac Mammary			sinusoidal modulated	-	1 W - 60 W	1.8 kVp	---	15	500 Ω	30 kHz	sinusoidal 1 pulse
	Cardiac Thorax			sinusoidal modulated	-	1 W - 100 W	1.8 kVp	---	40	500 Ω	30 kHz	sinusoidal 1 pulse
	SimCoag			sinusoidal modulated pulsed modulated pulsed modulated	1 2 3	1 W - 120 W	2.0 kVp 2.5 kVp 4.6 kVp	2	60	500 Ω	30 kHz 30 kHz 20 kHz	sinusoidal 1 pulse sinusoidal 1 pulse 1 pulse
	Gastro Coag			sinusoidal modulated	1 2 3	1 W - 50 W	1.8 kVp 2.2 kVp 2.8 kVp	2	15	500 Ω	30 kHz	sinusoidal 1 pulse
	Laparoscopy			sinusoidal modulated	-	1 W - 120 W	1.8 kVp	---	60	500 Ω	20 kHz	5%
Modes Bipolar Cutting												
	Standard	Yes	Yes	sinusoidal constant	-	1 W - 200 W	400 Vp	---	100	75 Ω	---	---
	Bipolar resection	Yes	Yes	sinusoidal constant	1 2 3	250 W	500 Vp	2	---	75 Ω	---	---
			Initial incision phase	860 W								
	Bipolar scissors			sinusoidal constant	-	1 W - 120 W	200 Vp	---	40	75 Ω	---	---
	Vaporisation	Yes	Yes	sinusoidal constant	1 2 3	300 W 300 W 400 W	350 Vp 400 Vp 450 Vp	2	---	75 Ω	---	---

Mode icon	Description	CCS	ARC CONTROL	Form of HF voltage	Max. power output		Peak voltage	Default values		Rated load resistance	Modulation	
					Effect	Power range		Effect	Max. Watt		Frequency	Duty cycle
Modes Bipolar Coagulation												
	Standard forceps			sinusoidal constant	-	1 W – 120 W	150 Vp	---	40	50 Ω	---	---
	Standard forceps AUTO			sinusoidal constant	-	5 W – 120 W	150 Vp	---	40	50 Ω	---	---
	Micro forceps			sinusoidal constant	-	0.1 W – 40 W	90 Vp	---	10	50 Ω	---	---
	Forceps forced			sinusoidal modulated	-	1 W – 100 W	550 Vp	---	50	50 Ω	20 kHz	10%
	LIGATION			sinusoidal modulated	-	200 W	190 Vp	---	---	25 Ω	1 - 2 Hz	sinusoidal
	TissueSeal PLUS			sinusoidal modulated	-	200 W	190 Vp	---	---	25 Ω	1 - 2 Hz	sinusoidal
	Bipolar scissors			sinusoidal constant	-	1 W – 120 W	200 Vp	---	40	75 Ω	---	---

Mode icon	Description	CCS	ARC CONTROL	Form of HF voltage	Max. power output		Peak voltage	Default values		Rated load resistance	Modulation	
					Effect	Power range		Effect	Max. Watt		Frequency	Duty cycle
Modes Bipolar Coagulation												
	Laparoscopy			sinusoidal constant	-	1 W – 120 W	150 Vp	---	50	50 Ω	---	---
	Laparoscopy Micro			sinusoidal constant	-	1 W – 100 W	110 Vp	---	40	25 Ω	---	---
	Bipolar resection			sinusoidal constant	1 2 3 4	125 W 200 W 275 W 350 W	190 Vp	2	---	25 Ω	---	---
	SimCoag			sinusoidal modulated	-	5 W - 60 W	550 Vp	---	40	50 Ω	20 kHz	50%
	Vaporisation			sinusoidal constant sinusoidal modulated sinusoidal modulated	1 2 3	250 W	190 Vp 400 Vp 500 Vp	2	---	25 Ω	- 20 kHz 20 kHz	---- 50% 50%



The max. values are not necessarily created at rated load resistance. The HF power is subject to a tolerance limit of ± 20%.

10.2. Output, voltage and current diagrams

Monopolar Cutting – Standard

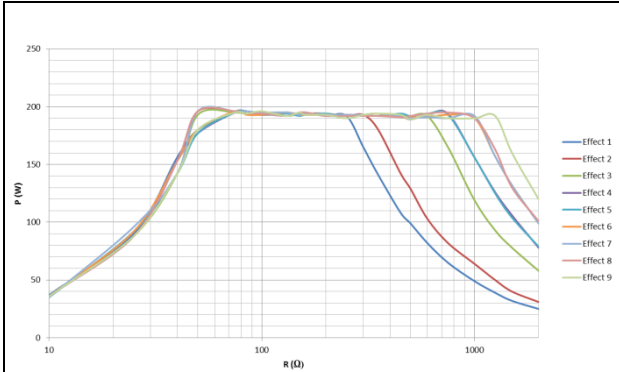
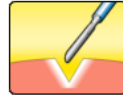

Measurement at ohmic resistances

- Diagram of power output P [W] as a function of the load resistance R [Ω] for the setting "Monopolar Cutting Standard" = 200 W

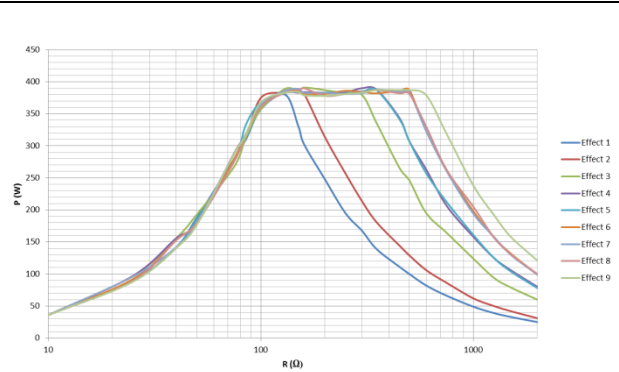

Measurement at ohmic resistances

- Diagram of power output P [W] as a function of the load resistance R [Ω] for the setting "Monopolar Cutting Standard" = 400 W

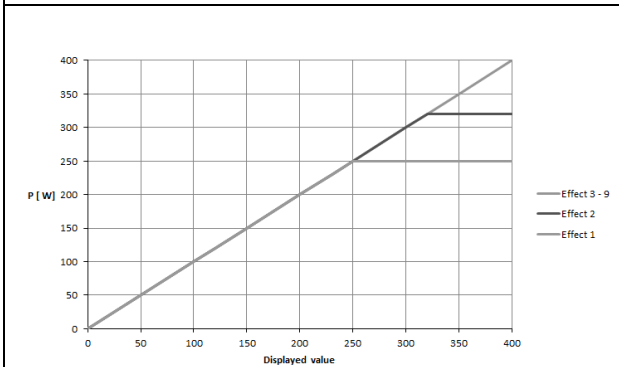

- Diagram of power output P [W] as a function of the setting "Monopolar Cutting Standard" Rated load resistance = 200 Ω

Effect	U (Vp)
1	400
2	450
3	560
4	650
5	650
6	700
7	700
8	700
9	750

- Table of HF output voltage U [Vp] as a function of the setting "Monopolar Cutting Standard" (idle mode)

Monopolar Cutting – Micro

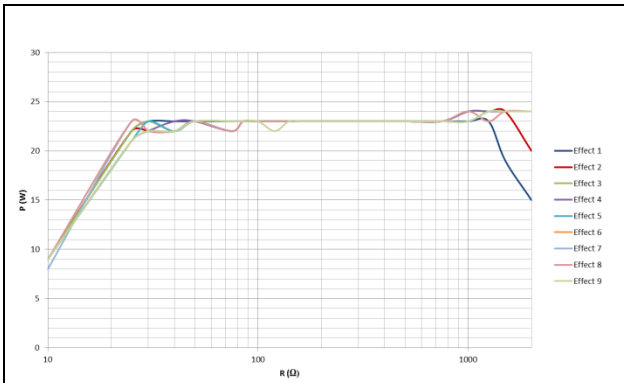
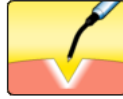

Measurement at ohmic resistances

- Diagram of power output P [W] as a function of the load resistance R [Ω] for the setting "Monopolar Cutting Micro" = 25 W

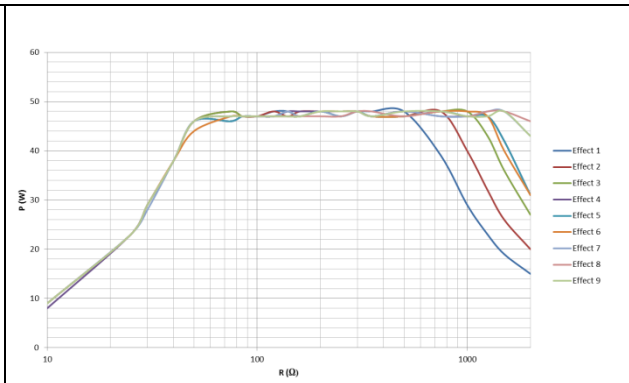

Measurement at ohmic resistances

- Diagram of power output P [W] as a function of the load resistance R [Ω] for the setting "Monopolar Cutting Micro" = 50 W

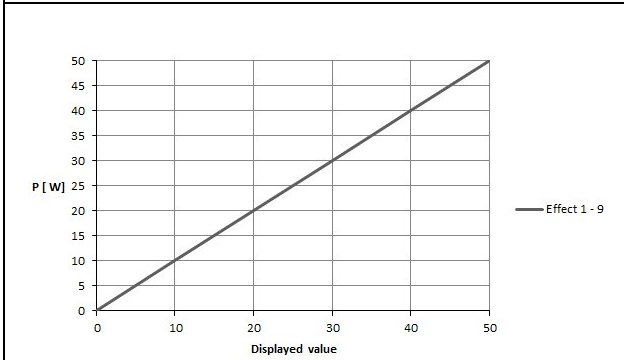

- Diagram of power output P [W] as a function of the setting "Monopolar Cutting Micro" Rated load resistance = 500 Ω

Effect	U (Vp)
1	280
2	340
3	380
4	400
5	400
6	400
7	450
8	450
9	450

- Table of HF output voltage U [Vp] as a function of the setting "Monopolar Cutting Micro" (idle mode)

Monopolar Cutting – Dry

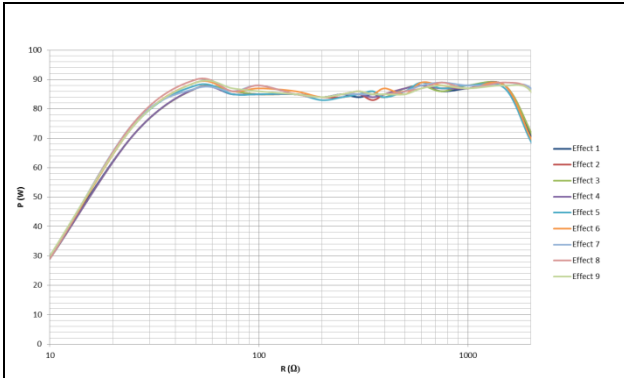
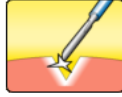

Measurement at ohmic resistances

- Diagram of power output P [W] as a function of the load resistance R [Ω] for the setting "Monopolar Cutting Dry" = 100 W

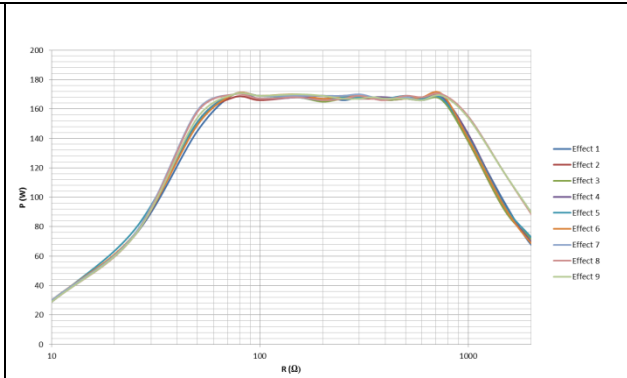

Measurement at ohmic resistances

- Diagram of power output P [W] as a function of the load resistance R [Ω] for the setting "Monopolar Cutting Dry" = 200 W

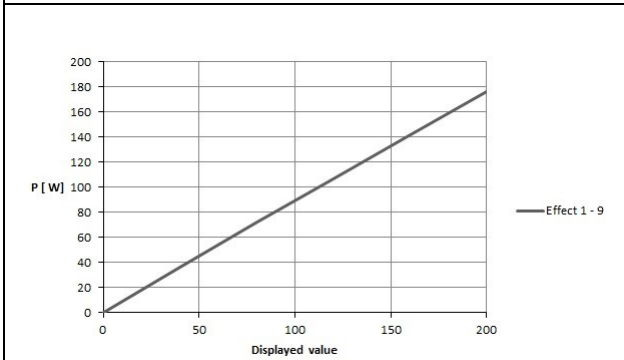

- Diagram of power output P [W] as a function of the setting "Monopolar Cutting Dry" Rated load resistance = 500 Ω

Effect	U (Vp)
1	1400
2	1400
3	1400
4	1400
5	1500
6	1600
7	1600
8	1600
9	1600

- Table of HF output voltage U [Vp] as a function of the setting "Monopolar Cutting Dry" (idle mode)

Monopolar Cutting – Argon

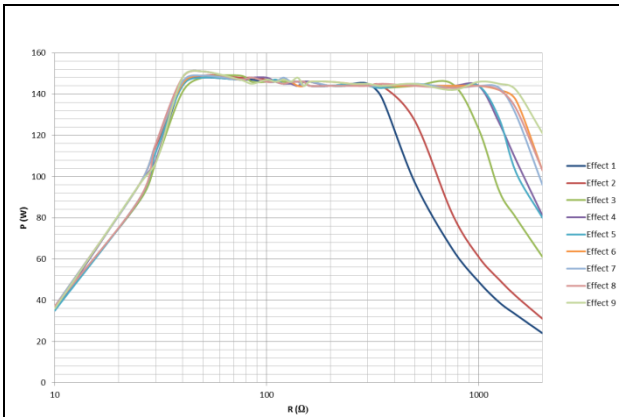
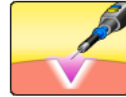

Measurement at ohmic resistances

- Diagram of power output P [W] as a function of the load resistance R [Ω] for the setting "Monopolar Cutting Argon" = 150 W

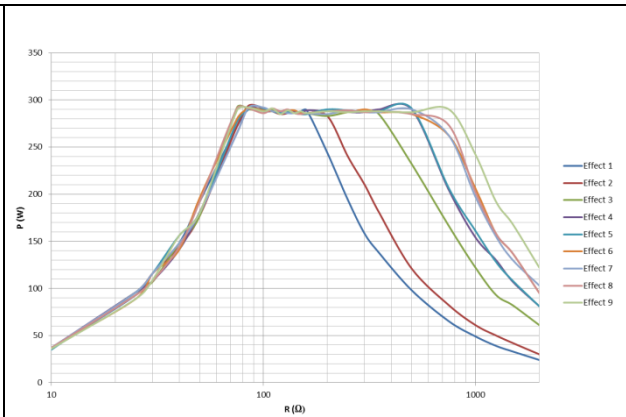

Measurement at ohmic resistances

- Diagram of power output P [W] as a function of the load resistance R [Ω] for the setting "Monopolar Cutting Argon" = 300 W

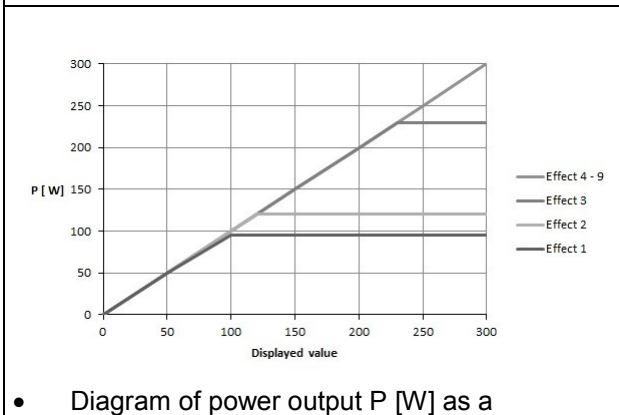

- Diagram of power output P [W] as a function of the setting "Monopolar Cutting Argon" Rated load resistance= 500 Ω

Effect	U (Vp)
1	400
2	450
3	560
4	650
5	650
6	700
7	700
8	700
9	750

- Table of HF output voltage U [Vp] as a function of the setting "Monopolar Cutting Argon" (idle mode)

Monopolar Cutting – Resection

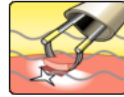

<p>Measurement at ohmic resistances</p> <ul style="list-style-type: none"> Diagram of power output P [W] as a function of the load resistance R [Ω] for the setting "Monopolar Cutting Resection" 																									
<table border="1" style="margin-left: auto; margin-right: auto; border-collapse: collapse; text-align: center;"> <thead> <tr style="background-color: #cccccc;"> <th>Effect</th> <th>P (W)</th> </tr> </thead> <tbody> <tr><td>1</td><td>250</td></tr> <tr><td>2</td><td>250</td></tr> <tr><td>3</td><td>250</td></tr> <tr><td>4</td><td>250</td></tr> <tr><td>5</td><td>250</td></tr> </tbody> </table> <ul style="list-style-type: none"> Table of power output P [W] as a function of the setting "Monopolar Cutting Resection" Rated load resistance= 500 Ω 	Effect	P (W)	1	250	2	250	3	250	4	250	5	250	<table border="1" style="margin-left: auto; margin-right: auto; border-collapse: collapse; text-align: center;"> <thead> <tr style="background-color: #cccccc;"> <th>Effect</th> <th>U (Vp)</th> </tr> </thead> <tbody> <tr><td>1</td><td>650</td></tr> <tr><td>2</td><td>700</td></tr> <tr><td>3</td><td>700</td></tr> <tr><td>4</td><td>700</td></tr> <tr><td>5</td><td>750</td></tr> </tbody> </table> <ul style="list-style-type: none"> Table of HF output voltage U [Vp] as a function of the setting "Monopolar Cutting Resection" (idle mode) 	Effect	U (Vp)	1	650	2	700	3	700	4	700	5	750
Effect	P (W)																								
1	250																								
2	250																								
3	250																								
4	250																								
5	250																								
Effect	U (Vp)																								
1	650																								
2	700																								
3	700																								
4	700																								
5	750																								

Monopolar Cutting – MetraLOOP

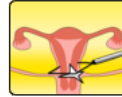

<p>Measurement at ohmic resistances</p> <ul style="list-style-type: none"> • Diagram of power output P [W] as a function of the load resistance R [Ω] for the setting "Monopolar Cutting MetraLOOP" 	<ul style="list-style-type: none"> • 																
<table border="1" data-bbox="363 1003 611 1149"> <thead> <tr> <th>Effect</th> <th>P (W)</th> </tr> </thead> <tbody> <tr> <td>1</td> <td>300</td> </tr> <tr> <td>2</td> <td>350</td> </tr> <tr> <td>3</td> <td>400</td> </tr> </tbody> </table> <ul style="list-style-type: none"> • Table of power output P [W] as a function of the setting "Monopolar Cutting MetraLOOP". Rated load resistance= 100 Ω 	Effect	P (W)	1	300	2	350	3	400	<table border="1" data-bbox="991 1003 1238 1149"> <thead> <tr> <th>Effect</th> <th>U (Vp)</th> </tr> </thead> <tbody> <tr> <td>1</td> <td>650</td> </tr> <tr> <td>2</td> <td>650</td> </tr> <tr> <td>3</td> <td>650</td> </tr> </tbody> </table> <ul style="list-style-type: none"> • Table of HF output voltage U [Vp] as a function of the setting "Monopolar Cutting MetraLOOP" (idle mode) 	Effect	U (Vp)	1	650	2	650	3	650
Effect	P (W)																
1	300																
2	350																
3	400																
Effect	U (Vp)																
1	650																
2	650																
3	650																

Monopolar Cutting – Laparoscopy

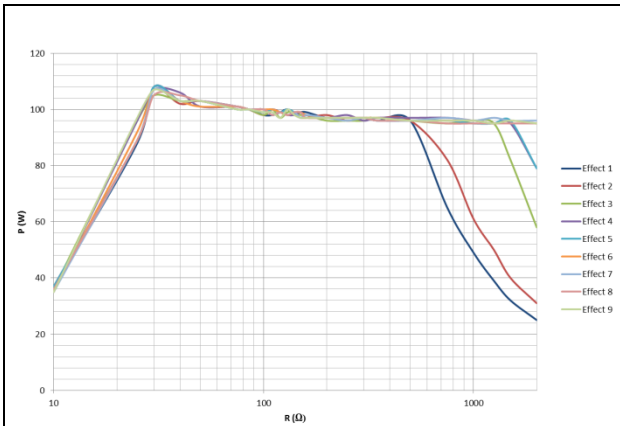

Measurement at ohmic resistances

- Diagram of power output P [W] as a function of the load resistance R [Ω] for the setting "Monopolar Cutting Laparoscopy" = 100 W

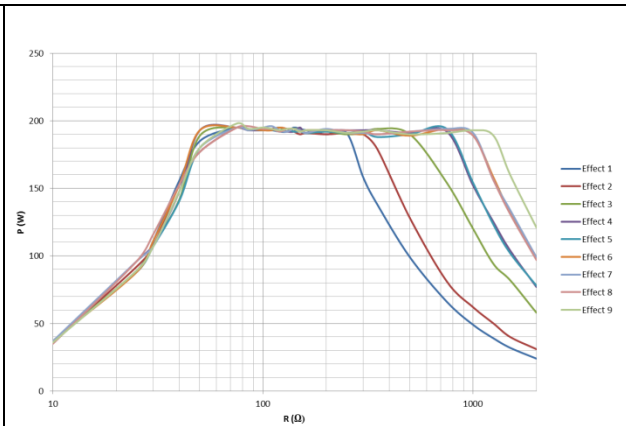

Measurement at ohmic resistances

- Diagram of power output P [W] as a function of the load resistance R [Ω] for the setting "Monopolar Cutting Laparoscopy" = 200 W

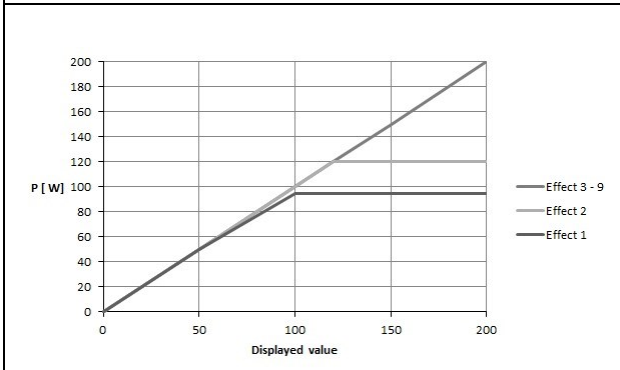

- Diagram of power output P [W] as a function of the setting "Monopolar Cutting Laparoscopy" Rated load resistance= 500 Ω

Effect	U (Vp)
1	400
2	450
3	560
4	650
5	650
6	700
7	700
8	700
9	750

- Table of HF output voltage U [Vp] as a function of the setting "Monopolar Cutting Laparoscopy" (idle mode)

Monopolar Cutting – GastroLOOP 1, 2, 3

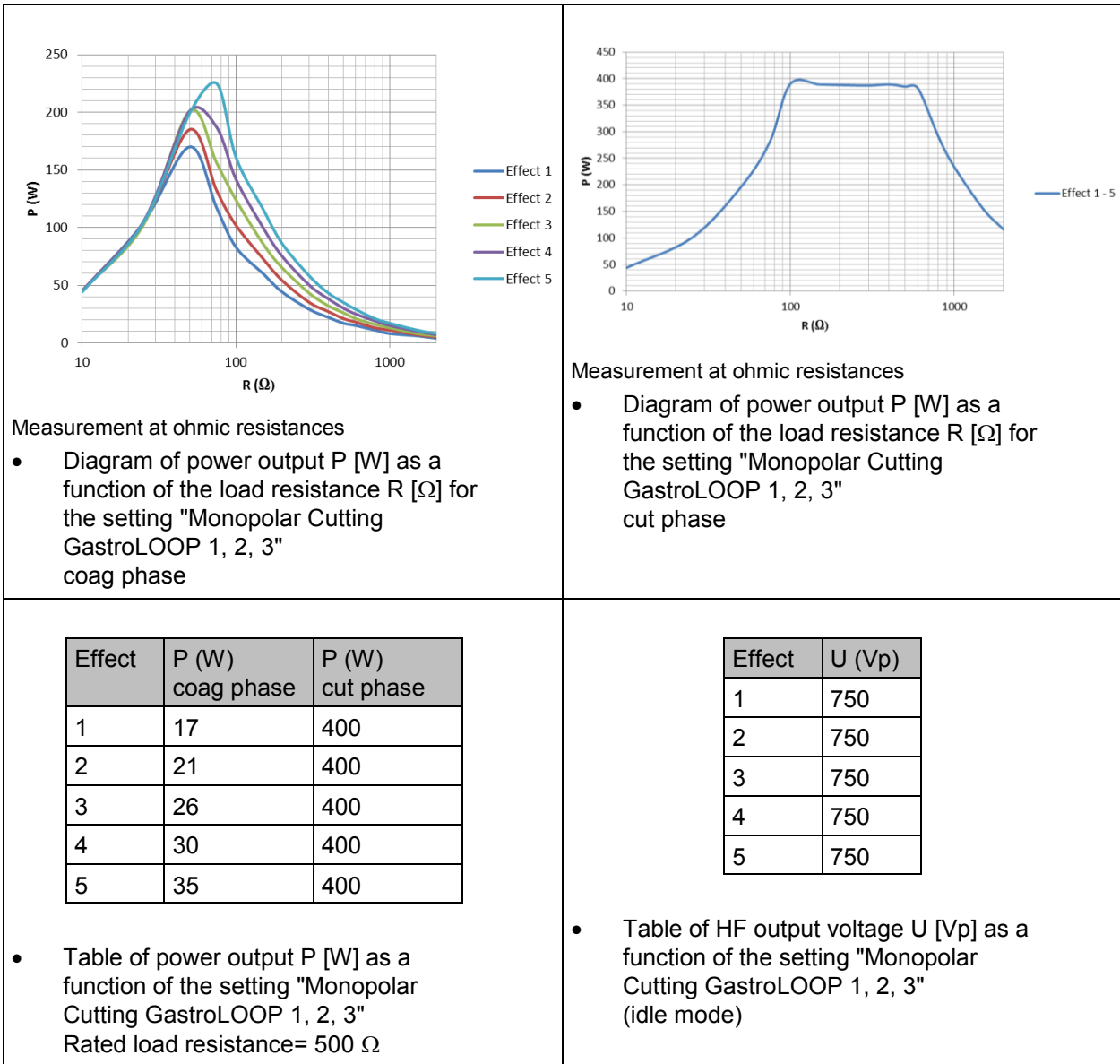
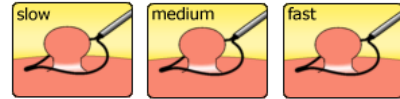

Monopolar Cutting – GastroKNIFE 1, 2, 3

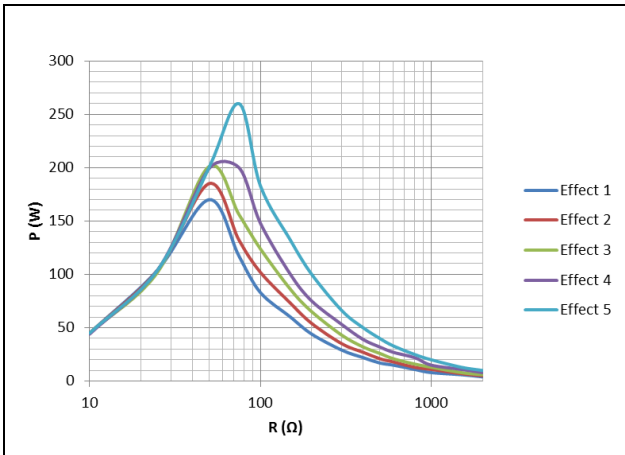
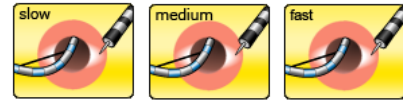

Measurement at ohmic resistances

- Diagram of power output P [W] as a function of the load resistance R [Ω] for the setting "Monopolar Cutting GastroKNIFE 1, 2, 3" coag phase

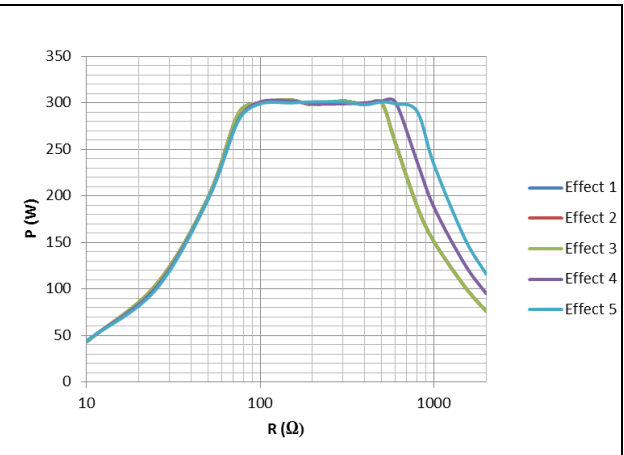

Measurement at ohmic resistances

- Diagram of power output P [W] as a function of the load resistance R [Ω] for the setting "Monopolar Cutting GastroKNIFE 1, 2, 3" cut phase

Effect	P (W) coag phase	P (W) cut phase
1	17	300
2	21	300
3	26	300
4	32	300
5	40	300

- Table of power output P [W] as a function of the setting "Monopolar Cutting GastroKNIFE 1, 2, 3" Rated load resistance= 500 Ω

Effect	U (Vp)
1	650
2	650
3	650
4	700
5	750

- Table of HF output voltage U [Vp] as a function of the setting "Monopolar Cutting GastroKNIFE 1, 2, 3" (idle mode)

Monopolar Coagulation – Moderate

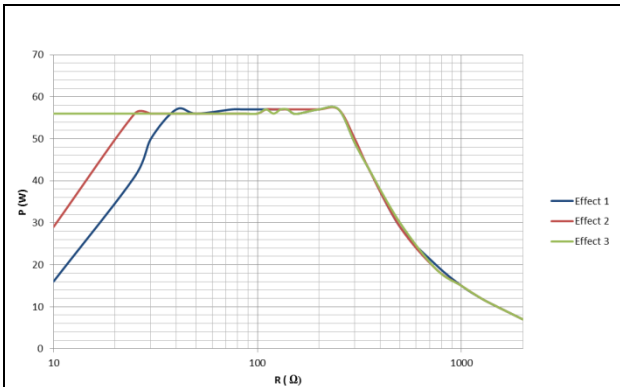
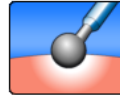

Measurement at ohmic resistances

- Diagram of power output P [W] as a function of the load resistance R [Ω] for the setting "Monopolar Coagulation Moderate" = 60 W

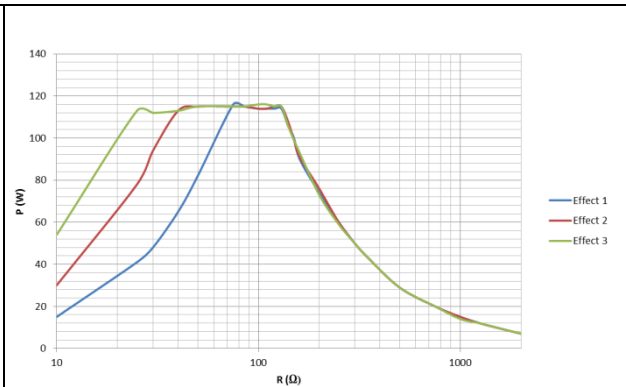

Measurement at ohmic resistances

- Diagram of power output P [W] as a function of the load resistance R [Ω] for the setting "Monopolar Coagulation Moderate" = 120 W

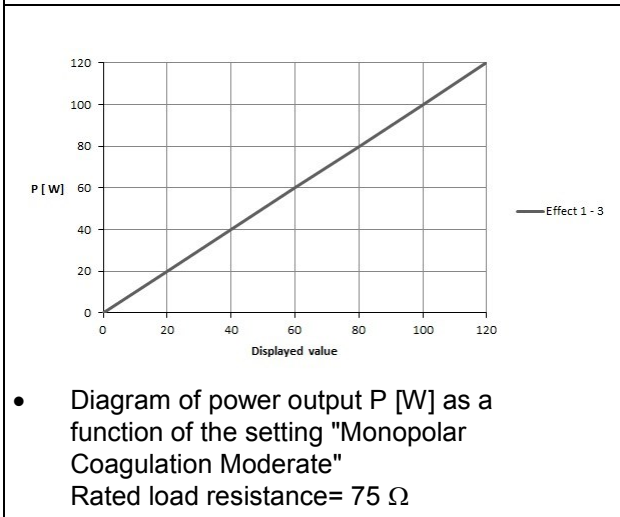

- Diagram of power output P [W] as a function of the setting "Monopolar Coagulation Moderate" Rated load resistance= 75 Ω

Effect	U (Vp)
1	250
2	250
3	250

- Table of HF output voltage U [Vp] as a function of the setting "Monopolar Coagulation Moderate" (idle mode)

Monopolar Coagulation – Forced non cutting

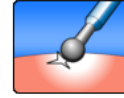

<p>Measurement at ohmic resistances</p> <ul style="list-style-type: none"> Diagram of power output P [W] as a function of the load resistance R [Ω] for the setting "Monopolar Coagulation Forced non cutting" = 40 W 	<p>Measurement at ohmic resistances</p> <ul style="list-style-type: none"> Diagram of power output P [W] as a function of the load resistance R [Ω] for the setting "Monopolar Coagulation Forced non cutting" = 80 W
<ul style="list-style-type: none"> Diagram of power output P [W] as a function of the setting "Monopolar Coagulation Forced non cutting" Rated load resistance = 1000 Ω 	<ul style="list-style-type: none"> HF output voltage U [Vp] for the setting "Monopolar Coagulation Moderate" (idle mode) = 3500 Vp

Monopolar Coagulation – Forced mixed

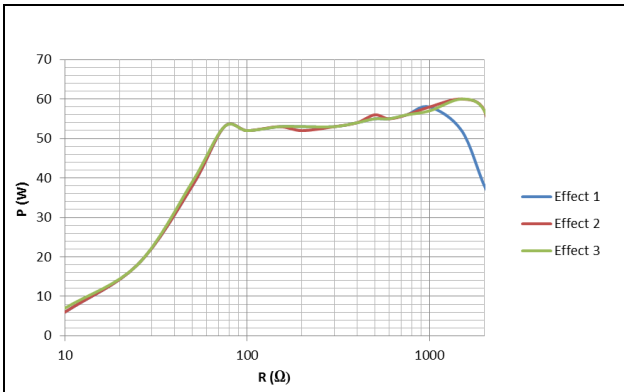

Measurement at ohmic resistances

- Diagram of power output P [W] as a function of the load resistance R [Ω] for the setting "Monopolar Coagulation Forced mixed" = 60 W

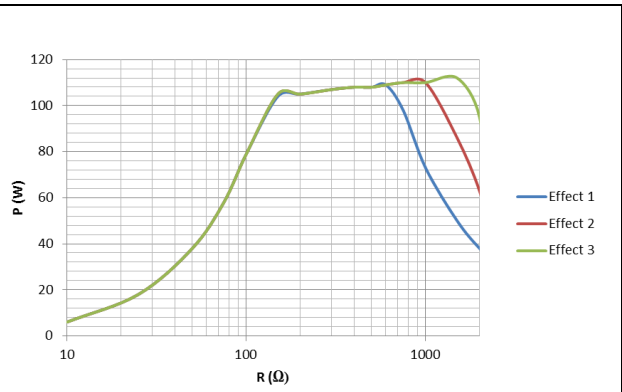

Measurement at ohmic resistances

- Diagram of power output P [W] as a function of the load resistance R [Ω] for the setting "Monopolar Coagulation Forced mixed" = 120 W

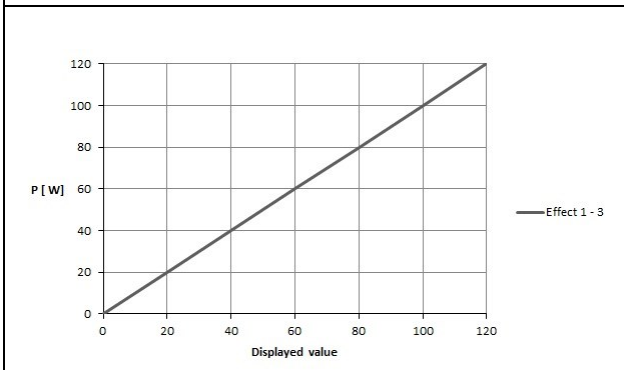

- Diagram of power output P [W] as a function of the setting "Monopolar Coagulation Forced mixed" Rated load resistance = 500 Ω

Effect	U (Vp)
1	1500
2	2000
3	2500

- Table of HF output voltage U [Vp] as a function of the setting "Monopolar Coagulation Forced mixed" (idle mode)

Monopolar Coagulation – Forced cutting

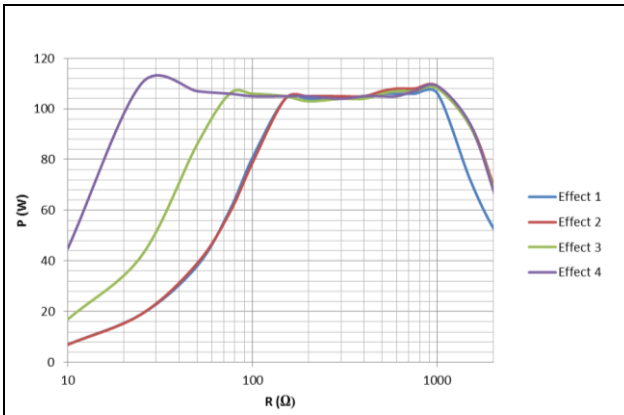
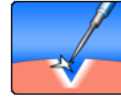

Measurement at ohmic resistances

- Diagram of power output P [W] as a function of the load resistance R [Ω] for the setting "Monopolar Coagulation Forced cutting" = 125 W

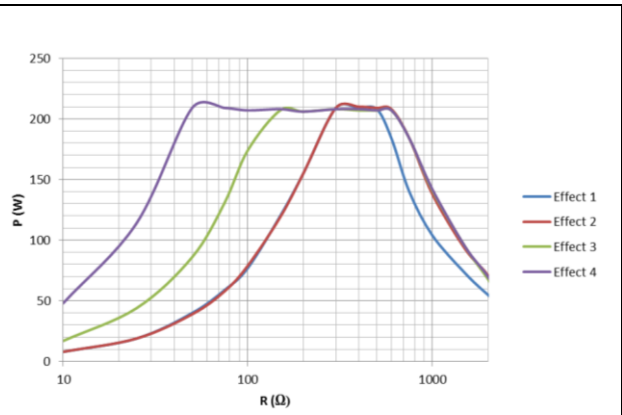

Measurement at ohmic resistances

- Diagram of power output P [W] as a function of the load resistance R [Ω] for the setting "Monopolar Coagulation Forced cutting" = 250 W

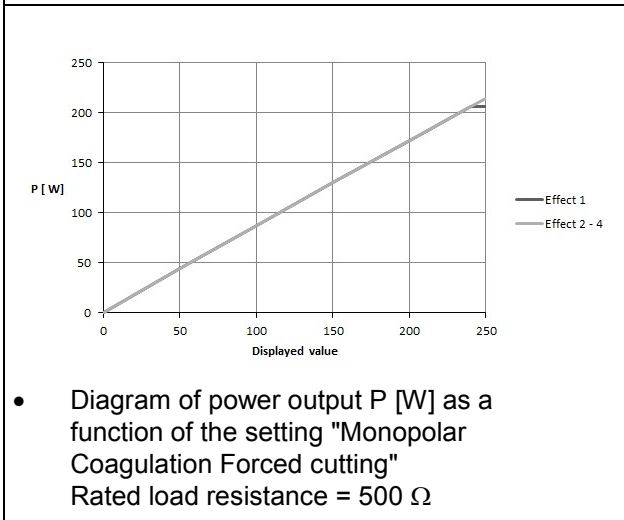

- Diagram of power output P [W] as a function of the setting "Monopolar Coagulation Forced cutting" Rated load resistance = 500 Ω

Effect	U (Vp)
1	1500
2	1500
3	1300
4	1300

- Table of HF output voltage U [Vp] as a function of the setting "Monopolar Coagulation Forced cutting" (idle mode)

Monopolar Coagulation – Spray

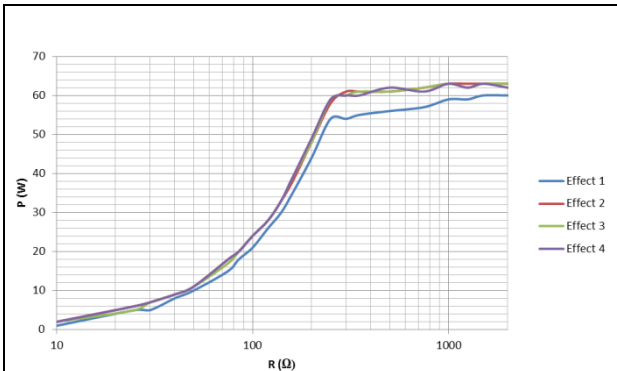
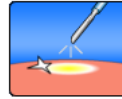

Measurement at ohmic resistances

- Diagram of power output P [W] as a function of the load resistance R [Ω] for the setting "Monopolar Coagulation Spray" = 60 W

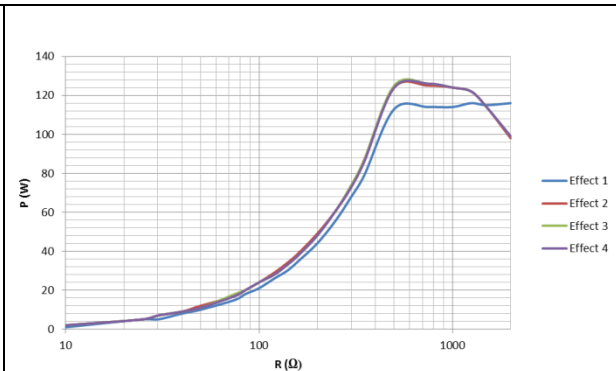

Measurement at ohmic resistances

- Diagram of power output P [W] as a function of the load resistance R [Ω] for the setting "Monopolar Coagulation Spray" = 120 W

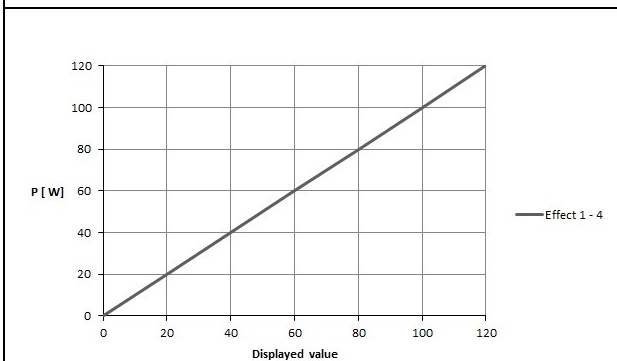

- Diagram of power output P [W] as a function of the setting "Monopolar Coagulation Spray" Rated load resistance = 500 Ω

Effect	U (Vp)
1	3000
2	3800
3	4600
4	5000

- Table of HF output voltage U [Vp] as a function of the setting "Monopolar Coagulation Spray" (idle mode)

Monopolar Coagulation – Argon



<p>Measurement at ohmic resistances</p> <ul style="list-style-type: none"> • Diagram of power output P [W] as a function of the load resistance R [Ω] for the setting "Monopolar Coagulation Argon open" = 60 W 	<p>Measurement at ohmic resistances</p> <ul style="list-style-type: none"> • Diagram of power output P [W] as a function of the load resistance R [Ω] for the setting "Monopolar Coagulation Argon open" = 120 W
<ul style="list-style-type: none"> • Diagram of power output P [W] as a function of the setting "Monopolar Coagulation Argon open" Rated load resistance = 500 Ω 	<ul style="list-style-type: none"> • HF output voltage U [Vp] for the setting "Monopolar Coagulation Argon open" (idle mode) = 4600 Vp

Monopolar Coagulation – Argon flexible

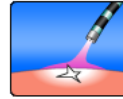

<p>Measurement at ohmic resistances</p> <ul style="list-style-type: none"> • Diagram of power output P [W] as a function of the load resistance R [Ω] for the setting "Monopolar Coagulation Argon flexible" = 60 W 	<p>Measurement at ohmic resistances</p> <ul style="list-style-type: none"> • Diagram of power output P [W] as a function of the load resistance R [Ω] for the setting "Monopolar Coagulation Argon flexible" = 120 W
<ul style="list-style-type: none"> • Diagram of power output P [W] as a function of the setting "Monopolar Coagulation Argon flexible" Rated load resistance = 500 Ω 	<ul style="list-style-type: none"> • HF output voltage U [Vp] for the setting "Monopolar Coagulation Argon flexible" (idle mode) = 4400 Vp

Monopolar Coagulation – Argon flex. pulse

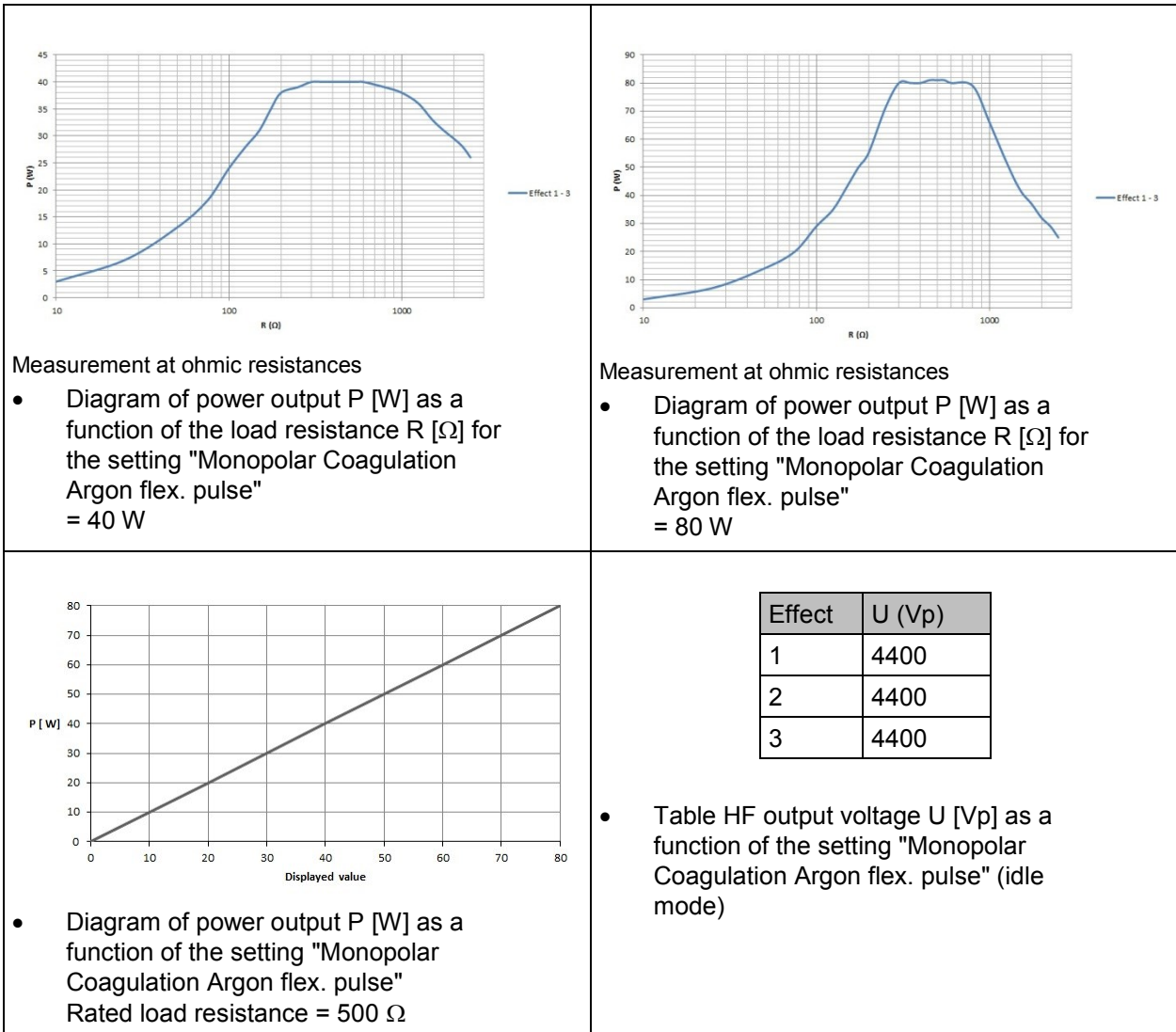
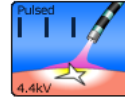

The puls frequency changes with the effect setting. The higher the effect level, the faster the pulse sequence.
Effect 1: 1 Hz, effect 2: 5 Hz, effect 3: 10 Hz
The mode "Argon flexible" is paused due to the pulse sequence.

Monopolar Coagulation – Resection



<p>Measurement at ohmic resistances</p> <ul style="list-style-type: none"> • Diagram of power output P [W] as a function of the load resistance R [Ω] for the setting "Monopolar Coagulation Resection" = 60 W 	<p>Measurement at ohmic resistances</p> <ul style="list-style-type: none"> • Diagram of power output P [W] as a function of the load resistance R [Ω] for the setting "Monopolar Coagulation Resection" = 120 W
<ul style="list-style-type: none"> • Diagram of power output P [W] as a function of the setting "Monopolar Coagulation Resection" Rated load resistance = 500 Ω 	<ul style="list-style-type: none"> • HF output voltage U [Vp] for the setting "Monopolar Coagulation Resection" (idle mode) = 2200 Vp

Monopolar Coagulation – Cardiac Mammary



<p>Measurement at ohmic resistances</p> <ul style="list-style-type: none"> • Diagram of power output P [W] as a function of the load resistance R [Ω] for the setting "Monopolar Coagulation Cardiac Mammary" = 30 W 	<p>Measurement at ohmic resistances</p> <ul style="list-style-type: none"> • Diagram of power output P [W] as a function of the load resistance R [Ω] for the setting "Monopolar Coagulation Cardiac Mammary" = 60 W
<ul style="list-style-type: none"> • Diagram of power output P [W] as a function of the setting "Monopolar Coagulation Cardiac Mammary" Rated load resistance = 500 Ω 	<ul style="list-style-type: none"> • HF output voltage U [Vp] for the setting "Monopolar Coagulation Cardiac Mammary" (idle mode) = 1800 Vp

Monopolar Coagulation – Cardiac Thorax



<p>Measurement at ohmic resistances</p> <ul style="list-style-type: none"> • Diagram of power output P [W] as a function of the load resistance R [Ω] for the setting "Monopolar Coagulation Cardiac Thorax" = 50 W 	<p>Measurement at ohmic resistances</p> <ul style="list-style-type: none"> • Diagram of power output P [W] as a function of the load resistance R [Ω] for the setting "Monopolar Coagulation Cardiac Thorax" = 100 W
<ul style="list-style-type: none"> • Diagram of power output P [W] as a function of the setting "Monopolar Coagulation Cardiac Thorax" Rated load resistance = 500 Ω 	<ul style="list-style-type: none"> • HF output voltage U [Vp] for the setting "Monopolar Coagulation Cardiac Thorax" (idle mode) = 1800 Vp

Monopolar Coagulation – SimCoag

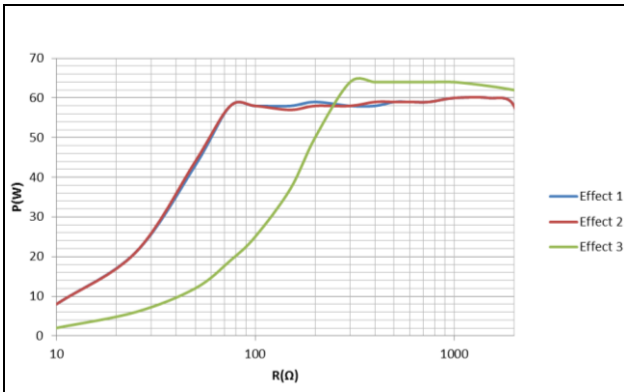

Measurement at ohmic resistances

- Diagram of power output P [W] as a function of the load resistance R [Ω] for the setting "Monopolar Coagulation SimCoag" = 60 W

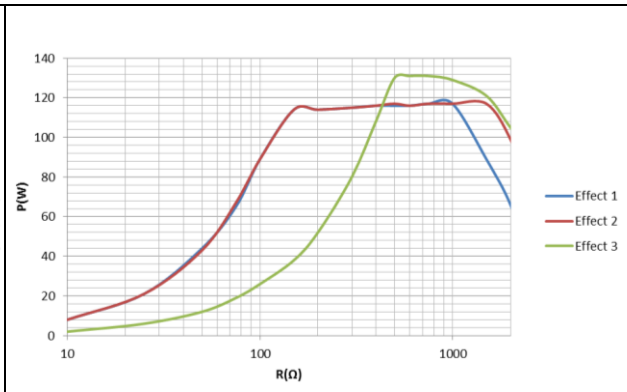

Measurement at ohmic resistances

- Diagram of power output P [W] as a function of the load resistance R [Ω] for the setting "Mon opolar Coagulation SimCoag" = 120 W

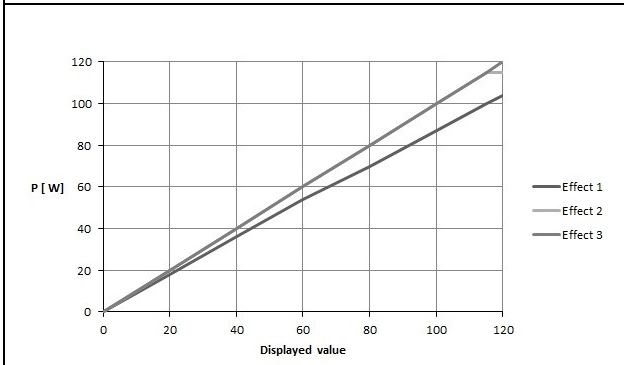

- Diagram of power output P [W] as a function of the setting "Monopolar Coagulation SimCoag" Rated load resistance = 500 Ω

Effect	U (Vp)
1	2000
2	2500
3	4600

- Table of HF output voltage U [Vp] as a function of the setting "Monopolar Coagulation SimCoag" (idle mode)

Monopolar Coagulation – Gastro Coag

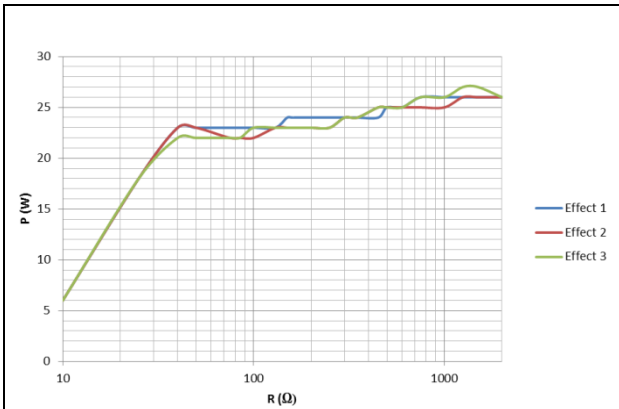

Measurement at ohmic resistances

- Diagram of power output P [W] as a function of the load resistance R [Ω] for the setting "Monopolar Coagulation GastroCut Coag" = 25 W

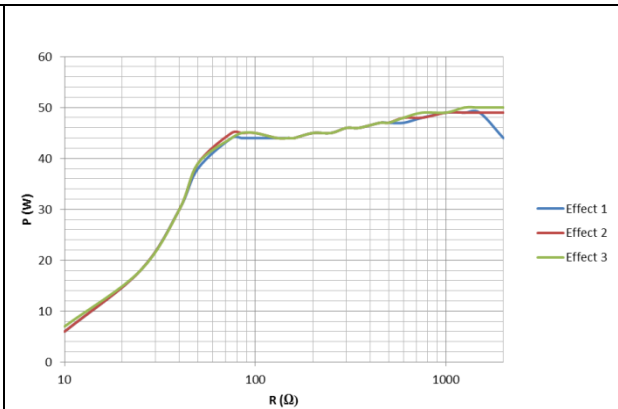

Measurement at ohmic resistances

- Diagram of power output P [W] as a function of the load resistance R [Ω] for the setting "Monopolar Coagulation GastroCut Coag" = 50 W

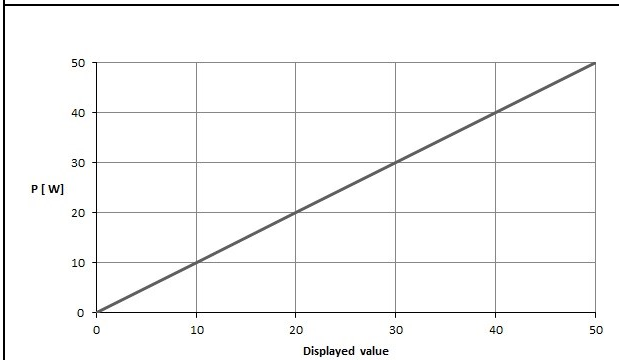

- Diagram of power output P [W] as a function of the setting "Monopolar Coagulation GastroCut Coag" Rated load resistance = 500 Ω

Effect	U (Vp)
1	1800
2	2200
3	2800

- Table of HF output voltage U [Vp] as a function of the setting "Monopolar Coagulation GastroCut Coag" (idle mode)

Monopolar Coagulation – Laparoscopy

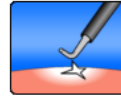

<p>Measurement at ohmic resistances</p> <ul style="list-style-type: none"> • Diagram of power output P [W] as a function of the load resistance R [Ω] for the setting "Monopolar Coagulation Laparoscopy" = 60 W 	<p>Measurement at ohmic resistances</p> <ul style="list-style-type: none"> • Diagram of power output P [W] as a function of the load resistance R [Ω] for the setting "Monopolar Coagulation Laparoscopy" = 120 W
<ul style="list-style-type: none"> • Diagram of power output P [W] as a function of the setting "Monopolar Coagulation Laparoscopy" Rated load resistance = 500 Ω 	<ul style="list-style-type: none"> • HF output voltage U [Vp] for the setting "Monopolar Coagulation Laparoscopy" (idle mode) = 1800 Vp

Bipolar Cutting – Standard



<p>Measurement at ohmic resistances</p> <ul style="list-style-type: none"> • Diagram of power output P [W] as a function of the load resistance R [Ω] for the setting "Bipolar Cutting Standard" = 100 W 	<p>Measurement at ohmic resistances</p> <ul style="list-style-type: none"> • Diagram of power output P [W] as a function of the load resistance R [Ω] for the setting "Bipolar Cutting Standard" = 200 W
<ul style="list-style-type: none"> • Diagram of power output P [W] as a function of the setting "Bipolar Cutting Standard" Rated load resistance = 75 Ω 	<ul style="list-style-type: none"> • HF output voltage U [Vp] for the setting "Bipolar Cutting Standard" (idle mode) = 400 Vp

Bipolar Cutting – Resection

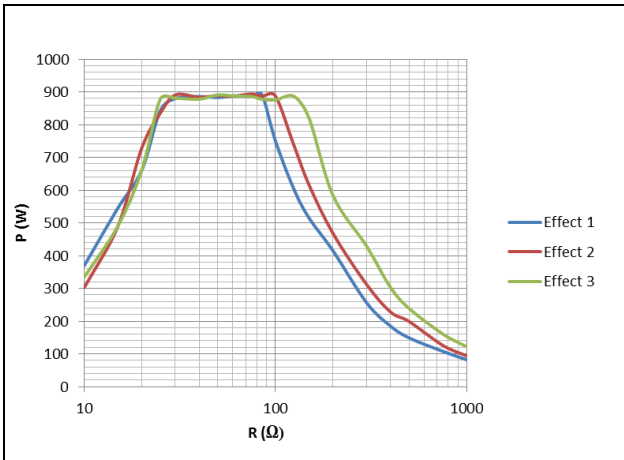
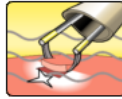

Measurement at ohmic resistances

- Diagram of power output P [W] as a function of the load resistance R [Ω] for the setting "Bipolar Cutting Resection" Initial cut phase

Effect	P (W)
1	250
2	250
3	250

- Table of power output P [W] as a function of the setting " Bipolar Cutting Resection " Rated load resistance = 75 Ω

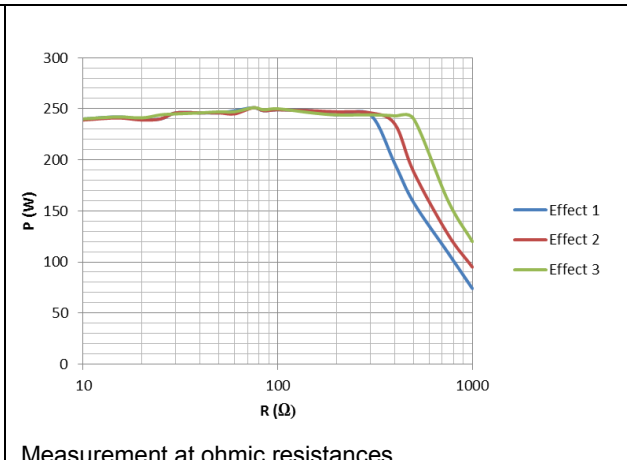

Measurement at ohmic resistances

- Diagram of power output P [W] as a function of the load resistance R [Ω] for the setting "Bipolar Cutting Resection" Phase after the initial cut.

Effect	U (Vp)
1	500
2	500
3	500

- Table of HF output voltage U [Vp] as a function of the setting " Bipolar Cutting Resection " (idle mode)

Bipolar Cutting – Bipolar scissors

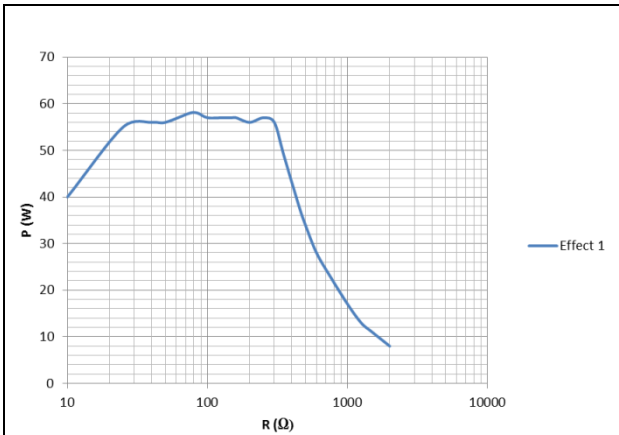

Measurement at ohmic resistances

- Diagram of power output P [W] as a function of the load resistance R [Ω] for the setting "Bipolar Cutting n bipolar scissors" = 60 W

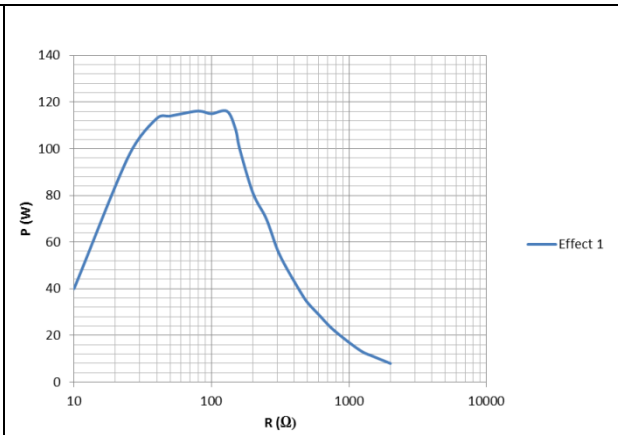

Measurement at ohmic resistances

- Diagram of power output P [W] as a function of the load resistance R [Ω] for the setting "Bipolar Cutting bipolar scissors" = 120 W

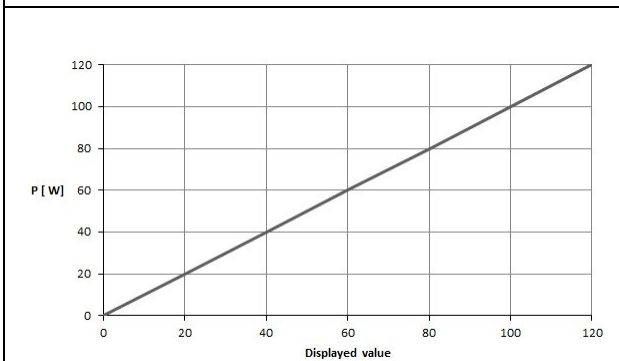

- Diagram of power output P [W] as a function of the setting " Bipolar Cutting bipolar scissors " Rated load resistance = 75 Ω

- HF output voltage U [Vp] for the setting " Bipolar Cutting Bipolar scissors " (idle mode) = 200 Vp

Bipolar Cutting – Vaporisation



<p>Measurement at ohmic resistances</p> <ul style="list-style-type: none"> Diagram of power output P [W] as a function of the load resistance R [Ω] for the setting "Bipolar Cutting Vaporisation" 																	
<table border="1" data-bbox="320 860 568 1032"> <thead> <tr> <th>Effect</th> <th>P (W)</th> </tr> </thead> <tbody> <tr> <td>1</td> <td>300</td> </tr> <tr> <td>2</td> <td>300</td> </tr> <tr> <td>3</td> <td>400</td> </tr> </tbody> </table> <ul style="list-style-type: none"> Table of power output P [W] as a function of the setting " Bipolar Cutting Vaporisation " Rated load resistance = 75 Ω 	Effect	P (W)	1	300	2	300	3	400	<table border="1" data-bbox="959 860 1206 1032"> <thead> <tr> <th>Effect</th> <th>U (Vp)</th> </tr> </thead> <tbody> <tr> <td>1</td> <td>350</td> </tr> <tr> <td>2</td> <td>400</td> </tr> <tr> <td>3</td> <td>450</td> </tr> </tbody> </table> <ul style="list-style-type: none"> Table of HF output voltage U [Vp] as a function of the setting " Bipolar Cutting Vaporisation " (idle mode) 	Effect	U (Vp)	1	350	2	400	3	450
Effect	P (W)																
1	300																
2	300																
3	400																
Effect	U (Vp)																
1	350																
2	400																
3	450																

Bipolar Coagulation – Standard forceps

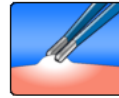

<p>Measurement at ohmic resistances</p> <ul style="list-style-type: none"> • Diagram of power output P [W] as a function of the load resistance R [Ω] for the setting "Bipolar Coagulation Standard forceps" = 60 W 	<p>Measurement at ohmic resistances</p> <ul style="list-style-type: none"> • Diagram of power output P [W] as a function of the load resistance R [Ω] for the setting "Bipolar Coagulation Standard forceps" = 120 W
<ul style="list-style-type: none"> • Diagram of power output P [W] as a function of the setting " Bipolar Coagulation Standard forceps " Rated load resistance = 50 Ω 	<ul style="list-style-type: none"> • HF output voltage U [Vp] for the setting " Bipolar Coagulation Standard forceps " (idle mode) = 150 Vp

Bipolar Coagulation – Standard forceps AUTOSTART

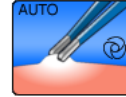

<p>Measurement at ohmic resistances</p> <ul style="list-style-type: none"> Diagram of power output P [W] as a function of the load resistance R [Ω] for the setting "Bipolar Coagulation Standard forceps AUTOSTART" = 60 W 	<p>Measurement at ohmic resistances</p> <ul style="list-style-type: none"> Diagram of power output P [W] as a function of the load resistance R [Ω] for the setting "Bipolar Coagulation Standard forceps AUTOSTART" = 120 W
<ul style="list-style-type: none"> Diagram of power output P [W] as a function of the setting " Bipolar Coagulation Standard forceps AUTOSTART" Rated load resistance = 50 Ω 	<ul style="list-style-type: none"> HF output voltage U [Vp] for the setting " Bipolar Coagulation Standard forceps AUTOSTART" (idle mode) = 150 Vp

Bipolar Coagulation – Micro forceps

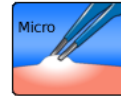

<p>Measurement at ohmic resistances</p> <ul style="list-style-type: none"> • Diagram of power output P [W] as a function of the load resistance R [Ω] for the setting "Bipolar Coagulation Micro forceps" = 20 W 	<p>Measurement at ohmic resistances</p> <ul style="list-style-type: none"> • Diagram of power output P [W] as a function of the load resistance R [Ω] for the setting "Bipolar Coagulation Micro forceps" = 40 W
<ul style="list-style-type: none"> • Diagram of power output P [W] as a function of the setting " Bipolar Coagulation Micro forceps " Rated load resistance = 50 Ω 	<ul style="list-style-type: none"> • HF output voltage U [Vp] for the setting " Bipolar Coagulation Micro forceps " (idle mode) = 90 Vp

Bipolar Coagulation – Forceps forced



<p>Measurement at ohmic resistances</p> <ul style="list-style-type: none"> • Diagram of power output P [W] as a function of the load resistance R [Ω] for the setting "Bipolar Coagulation forceps forced" = 50 W 	<p>Measurement at ohmic resistances</p> <ul style="list-style-type: none"> • Diagram of power output P [W] as a function of the load resistance R [Ω] for the setting "Bipolar Coagulation forceps forced" = 100 W
<ul style="list-style-type: none"> • Diagram of power output P [W] as a function of the setting " Bipolar Coagulation forceps forced " Rated load resistance = 50 Ω 	<ul style="list-style-type: none"> • HF output voltage U [Vp] for the setting " Bipolar Coagulation forceps forced " (idle mode) = 550 Vp

LIGATION / TissueSeal PLUS

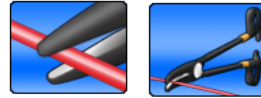

<p>Measurement at ohmic resistances</p> <ul style="list-style-type: none"> • Diagram of power output P [W] as a function of the load resistance R [Ω] for the setting "LIGATION" 	
<ul style="list-style-type: none"> • Power output P [W] as a function of the setting " LIGATION " Rated load resistance (25 Ω) = 200 W 	<ul style="list-style-type: none"> • HF output voltage U [Vp] for the setting " LIGATION " (idle mode) = 190 Vp

Bipolar Coagulation – Bipolar scissors



<p>Measurement at ohmic resistances</p> <ul style="list-style-type: none"> • Diagram of power output P [W] as a function of the load resistance R [Ω] for the setting "Bipolar Coagulation bipolar scissors" = 60 W 	<p>Measurement at ohmic resistances</p> <ul style="list-style-type: none"> • Diagram of power output P [W] as a function of the load resistance R [Ω] for the setting "Bipolar Coagulation bipolar scissors" = 120 W
<ul style="list-style-type: none"> • Diagram of power output P [W] as a function of the setting " Bipolar Coagulation bipolar scissors" Rated load resistance = 75 Ω 	<ul style="list-style-type: none"> • HF output voltage U [Vp] for the setting " Bipolar Coagulation Bipolar scissors " (idle mode) = 200 Vp

Bipolar Coagulation– Laparoscopy



<p>Measurement at ohmic resistances</p> <ul style="list-style-type: none"> • Diagram of power output P [W] as a function of the load resistance R [Ω] for the setting "Bipolar Coagulation Laparoscopy" = 60 W 	<p>Measurement at ohmic resistances</p> <ul style="list-style-type: none"> • Diagram of power output P [W] as a function of the load resistance R [Ω] for the setting "Bipolar Coagulation Laparoscopy" = 120 W
<ul style="list-style-type: none"> • Diagram of power output P [W] as a function of the setting " Bipolar Coagulation Laparoscopy " Rated load resistance = 50 Ω 	<ul style="list-style-type: none"> • HF output voltage U [Vp] for the setting " Bipolar Coagulation Laparoscopy " (idle mode) = 150 Vp

Bipolar Coagulation – Laparoscopy Micro



<p>Measurement at ohmic resistances</p> <ul style="list-style-type: none"> • Diagram of power output P [W] as a function of the load resistance R [Ω] for the setting "Bipolar Coagulation - Laparoscopy Micro" = 60 W 	<p>Measurement at ohmic resistances</p> <ul style="list-style-type: none"> • Diagram of power output P [W] as a function of the load resistance R [Ω] for the setting "Bipolar Coagulation - Laparoscopy Micro" = 120 W
<ul style="list-style-type: none"> • Diagram of power output P [W] as a function of the setting "Bipolar Coagulation - Laparoscopy Micro" Rated load resistance = 25 Ω 	<ul style="list-style-type: none"> • HF output voltage U [Vp] for the setting "Bipolar Coagulation - Laparoscopy Micro" (idle mode) = 110 Vp

Bipolar Coagulation – Bipolar Resection

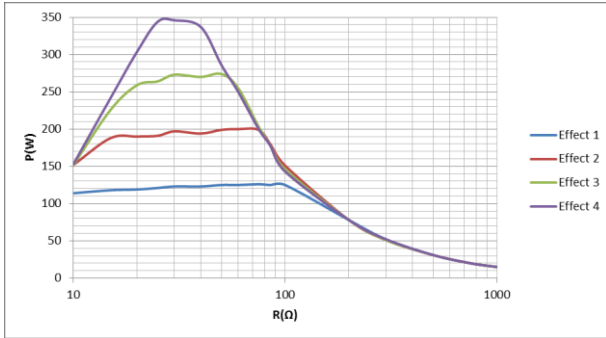

Measurement at ohmic resistances

- Diagram of power output P [W] as a function of the load resistance R [Ω] for the setting "Bipolar Coagulation Bipolar Resection"

Effect	P (W)
1	125
2	200
3	275
4	350

- Table of power output P [W] as a function of the setting " Bipolar Coagulation Bipolar Resection " Rated load resistance = 25 Ω

Effect	U (Vp)
1	190
2	190
3	190
4	190

- Table of HF output voltage U [Vp] as a function of the setting "Bipolar Coagulation Bipolar Resection" (idle mode)

Bipolar Coagulation – SimCoag bipolar

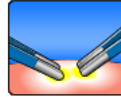

<p>Measurement at ohmic resistances</p> <ul style="list-style-type: none"> • Diagram of power output P [W] as a function of the load resistance R [Ω] for the setting "Bipolar Coagulation Sim Coag" = 30 W 	<p>Measurement at ohmic resistances</p> <ul style="list-style-type: none"> • Diagram of power output P [W] as a function of the load resistance R [Ω] for the setting "Bipolar Coagulation SimCoag" = 60 W
<ul style="list-style-type: none"> • Diagram of power output P [W] as a function of the setting " Bipolar Coagulation SimCoag " Rated load resistance = 50 Ω 	<ul style="list-style-type: none"> • HF output voltage U [Vp] for the setting "Bipolar Coagulation SimCoag" (idle mode) = 550 Vp

Bipolar Coagulation – Vaporisation

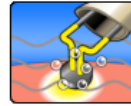

<p>Measurement at ohmic resistances</p> <ul style="list-style-type: none"> Diagram of power output P [W] as a function of the load resistance R [Ω] for the setting "Bipolar Coagulation Vaporisation" 																	
<table border="1" data-bbox="316 927 564 1106"> <thead> <tr> <th>Effect</th> <th>P (W)</th> </tr> </thead> <tbody> <tr> <td>1</td> <td>250</td> </tr> <tr> <td>2</td> <td>250</td> </tr> <tr> <td>3</td> <td>250</td> </tr> </tbody> </table> <ul style="list-style-type: none"> Table of power output P [W] as a function of the setting " Bipolar Coagulation Vaporisation " Rated load resistance = 25 Ω 	Effect	P (W)	1	250	2	250	3	250	<table border="1" data-bbox="954 927 1203 1106"> <thead> <tr> <th>Effect</th> <th>U (Vp)</th> </tr> </thead> <tbody> <tr> <td>1</td> <td>190</td> </tr> <tr> <td>2</td> <td>400</td> </tr> <tr> <td>3</td> <td>500</td> </tr> </tbody> </table> <ul style="list-style-type: none"> Table of HF output voltage U [Vp] as a function of the setting "Bipolar Coagulation Vaporisation" (idle mode) 	Effect	U (Vp)	1	190	2	400	3	500
Effect	P (W)																
1	250																
2	250																
3	250																
Effect	U (Vp)																
1	190																
2	400																
3	500																

11. Accessories and replacement parts

Original BOWA accessories are suitable for use with the ARC Series¹ and ARC PLUS¹ devices. When using accessories made by other manufacturers, the user must ensure that they are designed for and compatible with the maximum HF peak voltage of the HF device.

For the use and correct preparation of the autoclavable devices, compliance with the relevant instruction manuals accompanying these devices is required.

Detailed information on accessories and replacement parts is available in the current accessories catalogue.

¹ This includes compliance to IEC 60601-1-2:2007; Ch. 5.2.2.1a)

12. EMC

- ▶ Medical electrical equipment needs special precautions regarding EMC and needs to be installed and put into service according to the EMC information provided in this document.
IEC 60601-1-2; Ch. 5.2.2.1a)
- ▶ Portable and mobile RF communication equipment can affect medical electrical equipment (see also table 4 and 6 on pages 161 and 162)
IEC 60601-1-2; Ch. 5.2.1.1b)
- ▶ The generator should not be used adjacent to or stacked with other electrical equipment. If adjacent or stacked use is necessary both the generator and other equipment should be observed to verify normal operation in the configuration in which it will be used.
IEC 60601-1-2; Ch. 5.2.2.1d)
- ▶ The use of accessories and cables other than those specified may result in increased emissions or decreased immunity.
IEC 60601-1-2; Ch. 5.2.2.1b)
- ▶ This HF device is solely intended to be used by trained medical personnel. This HF device may cause functional impairment or interference to the operation of other devices in the vicinity. It may be necessary to take suitable remedial measures, such as changing the orientation, arrangement or screening of the HF device.
IEC 60601-1-2:2007; Section 5.2.1.4

12.1. Guidelines and manufacturer's declaration in accordance with IEC 60601-1-2:2007

Emission of electromagnetic interference (IEC 60601-1-2, Table 1)		
The ARC 400 is intended for operation in an electromagnetic environment as described below. The customer or user of the ARC 400 should ensure that it is operated in such an environment.		
Interference emission measurement	Conformity	Electromagnetic environment guideline
HF emissions according to CISPR 11	Group 2	The ARC 400 must emit electromagnetic energy in order to perform its intended function. Nearby electronic devices may be affected.
HF emissions according to CISPR 11	Class A	The ARC 400 is suitable for use in facilities other than those suitable for a residential environment or those connected directly to the public power grid, which also supplies power to buildings used for residential purposes.
Emission of harmonics according to IEC 61000-3-2	Classes A	
Emission of voltage fluctuations and flicker according to IEC 61000-3-3	Conforms	

Immunity to electromagnetic interference (IEC 60601-1-2, Table 2)			
The ARC 400 is intended for operation in an electromagnetic environment as described below. The customer or user of the ARC 400 should ensure that it is operated in such an environment.			
Interference immunity test	IEC 60601 test level	Conformity level	Electromagnetic environment guidelines
Electrostatic discharge (ESD) according to IEC 61000-4-2	±6 kV contact discharge	±6 kV contact discharge	Floors should be wooden or concrete or finished with ceramic tiles. If the floor is finished with a synthetic material, the relative humidity must be at least 30%.
	±8 kV air discharge	±8 kV air discharge	
Fast transient electrical noise or bursts according to IEC 61000-4-4	±2 kV on AC supply lines	±2 kV on AC supply lines	The quality of the AC power should correspond to that of a typical business or hospital environment.
	±1 kV on input and output lines	±1 kV on input and output lines	
Surges according to IEC 61000-4-5	±1 kV between external conductors	±1 kV between external conductors	The quality of the AC power should correspond to that of a typical business or hospital environment.
	±2 kV between external conductor and ground	±2 kV between external conductor and ground	
Voltage dropouts, brief interruptions and supply voltage fluctuations according to IEC 61000-4-11	< 5% U_T for one half-cycle (> 95% dropout) 40% U_T for 5 cycles (60% dropout) 70% U_T for 25 cycles (30% dropout) < 5% U_T for 5 s (> 95% dropout)	< 5% U_T for one half-cycle (> 95% dropout) 40% U_T for 5 cycles (60% dropout) 70% U_T for 25 cycles (30% dropout) < 5% U_T for 5 s (> 95% dropout)	The quality of the AC power should correspond to that of a typical business or hospital environment. If the ARC 400 user requires it to continue operating in the event of a power dropout, it is recommended to power the ARC 400 from an uninterruptible power supply or a battery.
Note: U_T is the AC supply voltage before the test level is applied.			

Immunity to electromagnetic interference (IEC 60601-1-2, Table 4)			
The ARC 400 is intended for operation in an electromagnetic environment as described below. The customer or user of the ARC 400 should ensure that it is operated in such an environment.			
Interference immunity test	IEC 60601 test level	Conformity level	Electromagnetic environment guidelines
Conducted HF interference according to IEC 61000-4-6	3 Vrms 150 kHz to 80 MHz	10 V	Portable and mobile wireless devices should not be used inside the recommended protective distance from the ARC 400 and its cables, as calculated using the equation for the relevant transmission frequency. Recommended protective distance: $d = 0.35 \times \sqrt{P}$ $d = 0.35 \times \sqrt{P}$ for 80 MHz to 800 GHz $d = 0.75 \times \sqrt{P}$ for 80 MHz to 2.5 GHz where P is the rated transmitter output power in watts (W) as specified by the transmitter manufacturer and d is the recommended protective distance in meters (m). The field strength of stationary transmitters as determined by on-site measurements ^a should be lower than the compliance level ^b at all frequencies. Interference is possible in the vicinity of devices that bear the following symbol: <div style="text-align: right;">  </div>
Radiated HF interference according to IEC 61000-4-3	3 V/m 80 MHz to 2.5 GHz	3 / 10 V/m	
Note 1	The higher frequency range applies in case of 80 MHz and 800 MHz.		
Note 2	These guidelines may not be applicable in all cases. The propagation of electromagnetic waves is influenced by absorption and reflection by buildings, objects and people.		
^a	Field strengths from stationary transmitters, such as base stations for radio telephones, land mobile radios, amateur radio, AM and FM radio broadcasting and TV broadcasting, cannot be predicted accurately based on theoretical considerations. A survey of the electromagnetic conditions at the site should be performed to determine the electromagnetic environment resulting from stationary transmitters. If the measured field strength at the location where the ARC 400 is used exceeds the stated compliance level, the ARC 400 should be monitored to verify that it operates correctly. Additional measures, such as altering the orientation or location of the ARC 400, may be necessary if abnormal operation is observed.		
^b	The field strength should be lower than 10 V/m over the frequency range of 150 kHz to 80 MHz.		

Recommended protective distances between portable and mobile HF telecommunication devices and the ARC 400 (IEC 60601-1-2, Table 6)

The ARC 400 is designed for operation in an electromagnetic environment in which HF interference is monitored. The customer or user of the ARC 400 can help to prevent electromagnetic interference by complying with the minimum distance between portable and mobile HF telecommunication devices (transmitters) and the ARC 400. This distance depends on the output power of the communication device, as specified below.

Rated transmitter power (W)	Protective distance (m) at various transmission frequencies		
	150 kHz to 80 MHz $d = 0.35 \times \sqrt{P}$	80 MHz to 800 GHz $d = 0.35 \times \sqrt{P}$	800 MHz to 2.5 GHz $d = 0.7 \times \sqrt{P}$
0.01	0.035	0.035	0.07
0.1	0.11	0.11	0.22
1	0.35	0.35	0.70
10	1.1	1.1	2.2
100	3.5	3.5	7.0

For transmitters whose maximum rated power is not specified in the table above, the recommended protective distance d in meters (m) can be determined using the equation in the corresponding column, where P is the maximum rated output power of the transmitter in watts (W) as specified by the transmitter manufacturer.

Note 1	The higher frequency range applies in case of 80 MHz and 800 MHz.
Note 2	These guidelines may not be applicable in all cases. The propagation of electromagnetic waves is influenced by absorption and reflection by buildings, objects and people.

13. Disposal



Always comply with the national regulations of the relevant country when disposing of or recycling the device or its components.

Symbol	Designation
	A device marked with this symbol must be put into the separate waste collection for electrical and electronic devices. Disposal is carried out free of charge by the manufacturer within the European Union.

If you have any questions regarding product disposal, contact the service center, see section Technical service, page 109.

BOWA
EINFACH SICHER

BOWA-electronic GmbH & Co. KG
Heinrich-Hertz Strasse 4–10
D-72810 Gomaringen | Germany

Phone: +49 (0) 7072-6002-0
Fax: +49 (0) 7072-6002-33
info@bowa-medical.com | www.bowa-medical.com



CE marked according to
Medical Device
93/42/EWG

BOWA-IFU-11779-ARC400-V2.1.0-S0-EN
Printed in Germany

Copyright by BOWA-electronic, Gomaringen | Germany

Subject to technical and design changes