

**Anexa 36 Dispozitiv de fizioterapie cu ultrasunet, Model: PhysioGo.Lite Sono, Astar,
Nr. de inregistrare AMDM: DM000663213**

Specificarea tehnică deplină solicitată, Standarde de referință	Specificarea tehnică deplină oferita, Standarde de referință
<p>Parametru Specificație Ecran dimensiune Minim 4 inch, color, tactil Frecvența de lucru, diapazon Minim 1–3 MHz Notă Se vor evalua doar valorile nominale, fără a lua în considerare eventuale abateri procentuale (precum acuratețea, eroarea etc.). Moduri de operare Continuu sau pulsatoriu Timpul de tratament $\geq 1-30$ minute Programe presetate Obligatoriu Programe personalizate Obligatoriu Tensiune 220 V, 50 Hz Accesorii: Sonda cu suprafață de $\sim 1 \text{ cm}^2$: ≥ 1 bucată Sonda cu suprafață de $\sim 4-5 \text{ cm}^2$: ≥ 1 bucată Gel de contact: ≥ 1 litru</p>	<p>Dispozitiv de fizioterapie cu ultrasunet Parametru Specificație Ecran dimensiune 5 inch, color, tactil, broșura, pag. 1 Frecvența de lucru, diapazon: 1–3 MHz, broșura, pag.2 Moduri de operare Continuu si pulsatoriu – broșura, pag. 1 Timpul de tratament 30s –30 minute - broșura, pag.2 Programe presetate -da, 156 programe, broșura, pag.1 Programe personalizate -da, 50 programe pentru fiecare applicator, broșura, pag.1 Tensiune 100-240 V, 50/60 Hz, broșura, pag.2 Accesorii: Sonda cu suprafață de $\sim 1 \text{ cm}^2$: 1 bucată (GU-1 type) - broșura, pag. 1 Sonda cu suprafață de $\sim 5 \text{ cm}^2$: 1 bucată (GU-5 type) – broșura pag. 1 Gel de contact: 1 litru da, (2 butelii/500g)- manual pag. 59</p>



PhysioGo.Lite SONO

Ultrasound therapy



Features

5" color touchscreen display	✓
one treatment channel	✓
possibility of two SnG heads operating simultaneously, their total area of head front in dual-section equals 34,6 cm ²	✓
manual mode	✓
treatment programs selected by name or medical field	✓
preset treatment programs database	✓
user-defined programs database	✓
favorite programs	✓
names of user programs and sequences can be edited	✓
built-in encyclopedia with treatment methodology	✓
availability of LIPUS therapy	✓
statistics of performed treatments	✓
buzzer volume adjustment	✓
battery (optional accessory)	✓

Ultrasound therapy

water resistant heads	✓
continuous / pulse emission	✓
lack of contact detection	✓
US head temperature control	✓
US head sensitivity adjustment	✓

Ultrasound heads

GU-1 type - 1 cm ² ; 1/3 MHz	✓
GU-5 type - 5 cm ² ; 1/3 MHz	✓
SnG type - 17,3 cm ² ; 1/3 MHz	✓

Preset treatment programs

preset treatment programs	156
user-defined programs	50 (for each applicator)
favorite programs	✓

Ultrasound therapy technical parameters

General technical parameters

frequency of operation	1 MHz; 3 MHz	dimensions	25 x 27 x 16,5 cm
total area of the head front GU-1; GU-5; SnG	1cm ² ; 5cm ² ; 17,3cm ²	weight	max. 3 kg
max. ultrasound intensity	2/3 W/cm ²	battery type (option)	Li-Ion
frequency in pulse mode	10 - 150 Hz with a variable step for GU-1, GU-5, SnG; 1 kHz LIPUS	battery capacity (option)	2100 mAh
regulated duty factor in pulse mode	✓	mains supply	100 - 240 VAC, 50/60 Hz, 24 VDC, 2,5 A
treatment timer	30 s - 30 minutes		



PhysioGo.Lite Sono –
User manual

CE
0197

Contents

1.	INTRODUCTION	5
1.1	MANUFACTURER	5
1.2	RISK MANAGEMENT PROCESS	5
2.	INTENDED USE	6
2.1	INTENDED USERS	7
2.2	USER TRAINING	7
3.	WARRANTY AND MANUFACTURER'S RESPONSIBILITY.....	8
4.	OPERATIONAL SAFETY	9
4.1	MAINS SUPPLY AND OPERATION MODE	9
4.2	STORAGE, OPERATION AND TRANSPORT CONDITIONS	10
4.3	WARNINGS AND SAFETY NOTES	10
4.4	EXPLOSION PROOF ENVIRONMENT	12
4.5	ELECTROMAGNETIC ENVIRONMENT	13
4.6	OPERATION OF TOUCH-SENSITIVE DISPLAYS	13
4.7	APPLIED PARTS	13
4.8	ESSENTIAL PERFORMANCE	14
4.8.1	<i>Tests of essential performance and basic safety</i>	14
4.9	DISPOSAL	15
5.	UNIT DESCRIPTION	16
5.1	GENERAL CHARACTERISTICS	16
5.2	FRONT PANEL	17
5.2.1	<i>Operation status and battery level indicators</i>	18
5.3	BATTERY INSTALLATION	19
5.4	NAME PLATE AND LABEL WITH PARAMETERS	20
5.5	ULTRASOUND HEADS	20
5.5.1	<i>Main features of SnG head</i>	21
5.5.2	<i>Signaling the lack of contact of the ultrasound heads</i>	22
5.5.3	<i>Temperature control of ultrasound heads</i>	22
6.	DEVICE INSTALLATION AND START-UP	23
6.1	UNIT INSTALLATION	23
6.1.1	<i>Assembling of the holders</i>	23
6.1.2	<i>Connection of ultrasound heads</i>	25
6.1.3	<i>Connection in combined therapy</i>	26
6.2	FIRST OPERATION	26
6.3	SETUP MODE.....	27
6.3.1	<i>Basic information</i>	27
6.3.2	<i>Language</i>	27
6.3.3	<i>Global settings</i>	27
6.3.4	<i>Functional settings</i>	28
6.3.5	<i>Control functions</i>	30
6.3.6	<i>Information</i>	30
6.4	TRANSPORT POSITION – TROLLEY FOR THE UNIT AND ACCESSORIES	31
7.	UNIT OPERATION	32
7.1	PATIENT PREPARATION AND TREATMENT PERFORMANCE	32
7.1.1	<i>General information</i>	32
7.1.2	<i>Ultrasound therapy</i>	32
7.1.3	<i>Combined therapy</i>	33
7.1.4	<i>Method of treatment performance</i>	34
7.2	SCREEN CONFIGURATION	36
7.3	GENERAL CONFIGURATION	37
7.4	DISPLAY DESCRIPTION	38
7.5	OPERATION WITH PRESET TREATMENT PROGRAMS	38
7.6	FAVORITE PROGRAMS	40
7.7	MANUAL MODE OPERATION	41
7.8	USER PROGRAMS	41
7.9	COMBINED THERAPY TREATMENT	42

7.10	SAFE SHUTDOWN PROCEDURE.....	43
8.	DEFINITIONS AND PARAMETERS.....	44
8.1	STANDARD ULTRASOUND HEADS (GU-5, GU-1).....	45
8.2	SnG – SINGLE-TRANSDUCER MODE	46
8.3	SnG – DUAL-TRANSDUCER MODE	47
8.4	SnG – FOURFOLD-TRANSDUCER MODE	48
8.5	CHARACTERISTICS OF PULSE PARAMETERS	49
9.	INDICATIONS AND CONTRAINDICATIONS.....	50
9.1	INDICATIONS	50
9.1.1	<i>Standard and SnG heads therapy.....</i>	<i>50</i>
9.1.2	<i>LIPUS therapy.....</i>	<i>50</i>
9.2	CONTRAINDICATIONS	50
10.	MAINTENANCE, CLEANING, DISINFECTION.....	52
10.1	CLEANING OF THE UNIT, SWITCH MODE POWER SUPPLY AND MAINS FILTER CASING	52
10.2	CLEANING OF TOUCHSCREEN	52
10.3	CLEANING AND DISINFECTION OF THE ULTRASOUND HEADS	53
10.4	SPECIAL MESSAGES.....	53
10.5	SELF-TEST PROCEDURE	53
10.6	TROUBLESHOOTING	54
10.7	FUSE REPLACEMENT	55
11.	SPECIFICATION AND ACCESSORIES.....	56
11.1	TECHNICAL DATA	56
11.2	EMC PARAMETERS	58
11.3	STANDARD ACCESSORIES.....	59
11.4	OPTIONAL ACCESSORIES	59
12.	APPENDIX A. SYMBOL DESCRIPTION	60
12.1	CONTROLLER, HEADS, MAINS FILTER, PACKAGING	60
12.2	SWITCHED-MODE POWER SUPPLIES – CASING	63

Figure list

Figure 4.1.	The method of correct connection of the SMPS, mains filter and controller	9
Figure 5.1	General view.....	16
Figure 5.2	Unit rear panel view	16
Figure 5.3	Arrangement of front panel components	17
Figure 5.4	The battery installation method	19
Figure 5.5.	Label with parameters.....	20
Figure 5.6	SnG ultrasound head, a cross-section through applicator (marked two transducers)	21
Figure 5.7	Way of inserting the hook-and-loop belt through the head handles	21
Figure 6.1	Method of mounting the standard ultrasound head holder	24
Figure 6.2	Method of mounting the SnG head holder	25
Figure 6.3	Ultrasound heads sockets.....	26
Figure 6.4	Combined therapy socket.....	26
Figure 7.1	Field description	36
Figure 7.2	Screenshot sample view for SnG head	38
Figure 7.3	Information screen sample view	39
Figure 8.1.	Manual time setting	47
Figure 10.1.	The unit error signaling and information visible after closing of the error message.....	53

1. Introduction

Read this manual carefully before starting the unit operation! Follow the recommendations presented in this manual!

The ultrasound therapy unit PhysioGo.Lite Sono should be installed by the seller. The recipient has the right to insist on the product operation training.
The unit may only be operated by qualified personnel or under supervision of such personnel!
WARNING: The device is intended for adult patients only. It is not intended for use in a home healthcare environment.

Description of symbols used in this manual:



Read appropriate passage of this user manual, warnings or important information. Failure to observe warnings can lead to injuries.



Important notices and information.



Following texts marked with this symbol facilitates device operation.

NOTE:

The outlook of screens shown in this manual may slightly differ from their actual outlook during device operation. These differences may concern size and type of fonts and size of symbols. There are no differences in the content of shown information.

NOTE:

This manual contains information for use and technical description.

WARNING: No modification of this equipment is allowed!

1.1 Manufacturer

ASTAR Sp. z o.o.
ul. Świt 33
43-382 Bielsko-Biała, Poland
www.astar.eu

1.2 Risk management process

The manufacturer conducts continuous risk management process referring to the device construction, its intended use, method of operation and maintenance. Residual risks are presented in this User Manual in form of information about precautions, contraindications and warnings.

2. Intended use

Ultrasound therapy unit PhysioGo.Lite Sono is an active, non-invasive medical device intended for carrying out treatments procedures using standard ultrasound therapy, low-intensity pulsed ultrasound (LIPUS) therapy and phonophoresis.

As regards to ultrasounds, the unit may be operated with:

- GU-5 standard ultrasound head, which generates an ultrasound wave with a frequency of 1 MHz or 3 MHz, with a total area of the head front of 5 cm², for classic ultrasound therapy and LIPUS therapy, as well as combined therapy,
- GU-1 standard ultrasound head, which generates an ultrasound wave with a frequency of 1 MHz or 3 MHz, with a total area of the head front of 1 cm², for classic ultrasound therapy and LIPUS therapy, as well as combined therapy,
- SnG hands-free ultrasound head, which generates an ultrasound wave with a frequency of 1 MHz or 3 MHz, with a total area of the head front of 17.3 cm², for stationary ultrasound therapy and LIPUS therapy, as well as combined therapy.

Standard heads are operated by the operator during treatment.

The hands-free head simulates the movements of the therapist due to the switching sequence of the ultrasonic transducers and the modulation of the ultrasonic wave. Details – see chapter 5.5.1.

The unit enables the simultaneous connection of two ultrasound heads. The device has one therapeutic channel for ultrasound therapy. Further information on supported types of ultrasound heads are given in sections 5.5 and 8. The unit possesses the base of preset treatment procedures along with therapeutic encyclopedia, which significantly increases comfort of operation. There is a possibility to create own user-defined programs – for all applicators.

Detailed information about indications and contraindications are presented in chapter 9.

Due to the optional availability of a battery, the unit is perfectly suited for use:

- in sports medicine in case of training camps,
- wherever there are problems with power supply quality.

Impact of ultrasounds application on tissues includes:

- increase in cell membranes permeability
- improvement of tissue respiration and stimulation of cellular metabolism
- changes in tissue colloid structure and their hydration
- changes in tissue ion systems
- change of tissue reading in alkaline direction

The therapeutic application includes:

- analgesic effect:
 - cervical arthritic spondylosis pains
 - rachialgias, chest and loins section
 - sciatic neuralgia pains
 - painful shoulder syndrome
 - tennis elbow
 - phantom limb pains
- reduction of muscle tone
- degenerative joint diseases
- neuralgias
- lockjaw
- scars
- shin ulceration
- medicine application (phonophoresis)

2.1 Intended users



The patient should not be the operator.

Users (operators) of PhysioGo.Lite Sono can be:

- specialists in the field of the ultrasound therapy,
- physiotherapists specializing in the therapy of the musculoskeletal system,
- sports medicine specialists,
- aesthetic medicine specialists,
- trained personnel performing treatments under the supervision of the above-mentioned specialists.

The user should have:

- knowledge about the indications and contraindications for the use of ultrasound therapy,
- knowledge of the terminology and technical terms used in the manual (e.g. knowledge of units of physical quantities),
- practical skills in performing therapeutic treatments using devices for ultrasound therapy, resulting from education, experience and training.

Physical and cognitive requirements of the operator:

- eyesight enabling to recognize elements of screen and keyboard,
- hearing enabling to hear the patient's voice,
- reading comprehension that allows to read the instructions of use and information on the screen of the device,
- two functional upper limbs that allow to perform treatments and other activities related to the operation of the device (e.g. cleaning of applicators),
- age in the range of admissible value of professional activity (depending on the regulations of the country where the device is used).

2.2 User training

The PhysioGo.Lite Sono user has to be properly trained in the device safe and effective use, before starting the operation. Training in the rules of operation can be carried out by representatives of the manufacturer or seller, based on this user manual.

Recommended training positions:

- information about the intended use of the device,
- occupational safety information,
- information on the construction and method of the output signal generation,
- information on available settings and operation modes,
- instructions for use,
- indications and contraindications for the therapy,
- information on recommended maintenance, cleaning and disinfection,
- handling in the event of a technical malfunction.

Due to requirements of local law and regulations in different countries, additional training activities may be required. The user should inform the seller about such requirements in order to receive complete information.

3. Warranty and manufacturer's responsibility



The manufacturer warrants the controller and ultrasound heads to be free of faults for the period of time and conditions stated in Warranty Certificates. The manufacturer also provides post-warranty service for a period of 10 years from launching the unit onto the market. The warranty includes all material and workmanship faults.

The manufacturer undertakes to observe the warranty agreement, if the following conditions are met:

- all repairs, changes, extensions and calibrations of equipment are performed by manufacturer or authorized service personnel,
- the mains supply system in the treatment room meets requirements of standards in force,
- the unit is operated by qualified personnel, in compliance with instructions presented in this manual,
- the unit is operated in compliance with its intended use.

The warranty does not include consumables, such as connection cables, mains cables, holders and fuses, as well as faults or damage caused by:

- improper placement, installation or configuration of the device,
- misuse or failure to observe the instructions presented in this user manual,
- inaccurate or inadequate maintenance carried out by the operator,
- improper environmental conditions specified for the product,
- unauthorized opening of the outer casing,
- adjustment and/or unauthorized tuning,
- use of non-original accessories.

The warranty does not cover any damage due to a failure to adhere to the recommendations stated in chapters 4.3 and 10 hereof.

The manufacturer is not liable in case of transmission of infection by equipment components.



The expected "life time" of the device is 10 years.

After elapse of 10 years from date of introduction of device and accessories in the market the manufacturer is not liable for device and accessories' faults or its consequences. After elapse of the expected life time of the device the user bears the complete responsibility for the occurrence of medical incidents.

The manufacturer bears no responsibility for results of faulty installation, wrong diagnosis, wrong use of the device and equipment, failure to observe user's manual and performance of repairs by unauthorized persons.



**Inside the device there are no user serviceable components, except for fuses and battery.
No parts can be serviced or maintained when the device is in use with a patient.**

On demand, the producer makes available technical diagrams, parts lists, descriptions, instructions for calibration or other helpful information to appropriately qualified user's technical staff to repair these parts of unit, which are described by the producer as a reparable.

4. Operational safety

4.1 Mains supply and operation mode



The unit is designed for supply from AC mains with rating 100-240 V and frequency 50/60 Hz. It is a medical device under safety class II, type BF. The unit may be used only in rooms, where the electric system is executed in compliance with standards in force. The unit is intended for continuous operation. It is not necessary to switch it off from the mains between particular treatment procedures.

An external switched-mode power supply (SMPS) treated as part of the device is the source of supply for the device. Two models are allowed to be used with the device:

- type HPU63B-108 by Sinpro, constant output voltage 24V, rated current 2.62A,
- type GSM60B24-P1J by Mean Well, constant output voltage 24V, rated current 2.5A.

The types of switched-mode power supply approved for use with the device is placed on the identification label.



The SMPS may be connected to the mains only by a special, detachable mains power supply cord integrated with the PLMF2A anti-interference filter. This filter is used to reduce electromagnetic disturbance that is generated during ultrasound therapy treatments.

The power supply cord is equipped with a mains plug that isolates the device from the supply mains on all poles simultaneously.

The socket in the device where the plug of the switched-mode power supply is connected is marked with  and safety sign ISO 7010 - M002.

Connecting to the mains and the proper operation of the switched-mode power supply is signaled:

- by the green LED indicator located on the housing of the switched-mode power supply type HPU63B-108 by Sinpro,
- by the blue LED indicator located on the housing of the switched-mode power supply type GSM60B24-P1J by Mean Well.

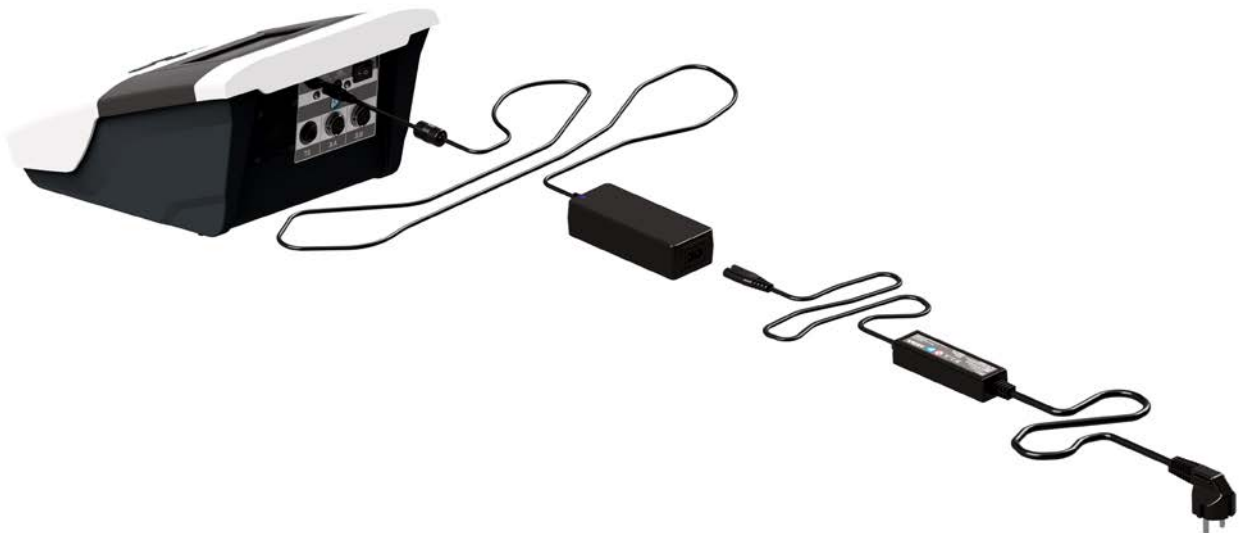

Figure 4.1. The method of correct connection of the SMPS, mains filter and controller

Recommendations related to isolation the device from the supply mains:



- Do not position the PhysioGo.Lite Sono so that it is difficult to operate the disconnection of the device from the supply mains.
- To isolate the device from the supply mains, hold the mains socket-outlet with one hand, grasp the mains plug with second hand and disconnect it from the mains socket-outlet.

Disconnection from the mains takes place after:

- switching the power switch to the "0" position,
- removing the SMPS output cord plug from the socket on the unit,
- removing the mains cable plug from the mains socket.

Selected models are equipped with rechargeable battery which allows for operation without, or in conditions of reduced quality of mains supply.

4.2 Storage, operation and transport conditions

The PhysioGo.Lite Sono unit must be stored in closed rooms, where the atmosphere is free from vapors and caustic substances and:

- the temperature is maintained between + 5°C and +45°C,
- relative humidity does not exceed 75%,
- atmospheric pressure value is between 700 and 1060 hPa (70-106 kPa).

The unit is intended for operation under the following conditions:

- ambient temperature between +15°C and +30°C,
- relative humidity between 30% to 75%,
- atmospheric pressure between 700 to 1060 hPa (70-106 kPa).

If further transport of the device is required, use the delivery packaging. Transport shall be performed with covered transport means.

Recommended transport conditions:

- ambient temperature between -10°C to +45°C,
- humidity between 20 and 95%,
- atmospheric pressure between 700 and 1060 hPa (70-106 kPa).

The above conditions refer also to the battery mode.



4.3 WARNINGS and safety notes

The PhysioGo.Lite Sono unit has been designed and manufactured in such a way that its use does not cause a hazard to the health and safety of patients, operators and third parties, as well as the unit provides therapeutic benefits to patients if it is operated in appropriate conditions and in accordance with its intended purpose.

General:

- PhysioGo.Lite Sono unit may be operated by qualified personnel in compliance with instructions (see 2.1).
- To avoid the risk of electric shock, the equipment must only be connected to mains supply with protective earth (mains socket with grounding pin).
- In order to ensure conformity with the requirements relating to electromagnetic disturbance, the device should be connected to grounded mains supply (mains socket with grounding pin). This solution is a functional earthing.
- The SMPS may be connected to the mains only by a special, detachable mains power supply cord integrated with the PLMF2A anti-interference filter.
- No modification of this equipment is allowed!
- The treatment station (bed, couch, chair) shall be located away from other electric devices and water supply / sewerage installation / central heating system, so that it is impossible for the patient to touch any of them during treatment procedure.
- Do not position PhysioGo.Lite Sono so that it is difficult to operate the disconnection of the device from the supply mains.
- Do not remove warning signs and labels put by the manufacturer on the unit casing and casings of accessories.
- The unit and ultrasound heads shall be protected against high temperatures and atmospheric conditions (e.g. direct sunlight).
- Damaged cables and/or heads shall be replaced immediately. Pay special attention to the casing cracks, threadbare insulation and partially torn interconnecting cables.

- Prevent any fluid from penetrating inside the unit, SMPS or mains filter. In case of any fluid getting inside the unit, SMPS or mains filter, switch the unit immediately off, isolate from the mains and contact service to inspect the unit.
- By any means do not cover the vents. Do not insert any objects into the ventilation socks.
- The unit may be only used with accessories, spare parts, disposable items which have been determined to be safe and appropriate inspection bodies have not issued contraindications against their use.
- Ultrasound heads are sensitive to mechanical damages that is why they should be used with caution. Throwing, banging against hard surfaces and similar actions that may lead to damage of the head shall be avoided. Careless use of the head may make its properties worse.
- Ultrasound heads are particularly sensitive to very low and very high temperatures. Special attention should be paid, so not connect the device to the mains supply when it is too much cooled (e.g. winter period, right after delivering by the forwarder).
- Ultrasound heads may only be connected to the sockets when the mains supply is switched off. Each head contains memory with calibration data that are checked by microprocessor during self-test phase. Plugging head to switched on unit will make the head be undetected, so its use will not be possible. Sometimes it may also damage the ultrasound head.
- The ultrasound head has dedicated transport packaging. The front of the head is protected by rubber cover, which secures it against mechanical damage during delivery. The cover must be removed before use. It is not recommended to use it between treatments due to the possibility of damaging head parts.
- After switching the unit off, wait for 10 seconds before you switch it on again.
- Each serious incident concerned with the device should be reported to the manufacturer and competent authority of the country, where the user or patient resides. Serious incident means any incident that directly or indirectly led, might have led or might lead to any of the following:
 - the death of a patient, user or other person,
 - the temporary or permanent serious deterioration of a patient's, user's or other person's state of health,
 - a serious public health threat.

Therapeutic:

- The device is intended for adult patients (patient has to be conscious). Minor patients – only on the doctor's explicit recommendation, after considering contraindications.
- It is impermissible for the patient to carry out the treatment on their own.
- Patients with implanted electronic devices (e.g. cardiac pacemakers) or other metal implants should consult a physician prior to treatment.
- If two heads are connected, the head which is not used should be placed in the holder. If any of the head is not used for a longer period of time, it is recommended to disconnect this head.
- Before performing the treatment, make sure there are no contraindications to its implementation.
- Treatment parameters should be consistent with the indications of a physician and/or a physiotherapist.
- Do not perform ultrasound treatments on the cervical spine above the 3rd vertebra as the ultrasound energy could affect the medulla oblongata.
- Before treatment it is necessary to interview the patient, including the occurrence of relative and absolute contraindications to conduct therapy.
- Do not perform treatments on patients under the influence of alcohol.
- Do not perform treatments on patients under the influence of intoxicants.
- It is necessary to ensure the adequate interval between treatments for the patient, in order to avoid an increase of the risk of complications.
- Take special care with patients with disturbed surface sensation.
- Sitting or reclining position should be applied to the patients with respiratory disorders or breathing difficulties.
- Avoid applying ultrasound energy to internal organs of the abdominal cavity, thorax (i.e. heart area) and gonads.
- Avoid application of ultrasounds in continuous mode directly over joints with cement or plastic endoprostheses. Ultrasounds in LIPUS mode can be used with caution.
- Avoid application of ultrasounds in continuous mode (causing a thermal effect) in case of dermatological diseases that are sensitive to heat, such as eczema, psoriasis. Ultrasound in the pulse mode can be used to treat open wounds with precautions (head disinfection, sterile gel, correct treatment method). The skin condition should be monitored and in case of its deterioration, the treatment should be stopped.

- Avoid application of ultrasounds in continuous mode (causing a thermal effect) over damaged nerves, because they can cause unpleasant sensations (e.g. needles and pins) and do not accelerate their regeneration.
- The patient should be in a position causing loosening of the part of the body subjected to therapy.
- The patient should immediately report an increase of pain or other unpleasant sensations.
- The choice of the ultrasound head should take into account the recommended technique of performing a specific treatment. For details – see chapter 7.1.4.
- When performing treatments with standard heads, a dynamic or semi-stationary technique should be applied. The stationary technique is only allowed for LIPUS therapy.
- Only a stationary (static) technique should be applied when performing treatments with hands-free SnG heads.
- GU heads are not identical to GS heads used in previous ultrasound therapy devices such as Etius, PhysioGo, Sonaris. They cannot be used interchangeably. SnG head is not supported by other devices.
- Avoid placing the hands-free head on superficial osteophymas, in order not to cause periosteal pain by a thermal dose. It is also necessary to carefully attach the head with the original hook-and-loop belts provided by the manufacturer, to limit its movement.
- Immediately stop the treatment in the case of appearing special messages on the display.
- Use a coupling gel for ultrasound devices. The gel should be a medical equipment, marked with the conformity mark (the CE mark in EU). Avoid using a gel with undocumented origin.
- Where it is necessary to use other coupling medium (e.g. liquid paraffin), test the quality of contact detection first (see 5.5.2).
- It is recommended to use distilled water when performing treatments in water, preferably after its degasification. To degas water, boil it for 30 minutes, then close a container tightly and put it in the refrigerator to cool. Heat water to the comfort temperature for the patient before use. The presence of air bubbles during therapy may cause deterioration of operation parameters, especially at the stationary positioning of the head.
- The surface of the front head of the ultrasound transducer can degrade and its parameters can deteriorate if you use tap water with the addition of minerals, disinfectants or other chemical agents. In the extreme case, the transducer may damage.
- The therapist should keep his or her hand outside of water during treatment.
- If you use a plastic container, the dose should be corrected, because the plastic absorbs reflected ultrasound energy. If you use a metal container, the reflected energy returns to the treated body part and there is no need to correct the dose.
- It is necessary to keep records of the treatment, including the parameters of the therapy, the area of treatment, treatment technique, dose and symptoms after therapy.
- It is necessary to continuously update knowledge and follow literary activities in the scope of therapy.

Therapeutic – combined therapy:

- See warnings and information for electrotherapy and ultrasound therapy.

Battery use (optional):

- Rechargeable battery UR18650A 5S1P is designed for use only with Astar PhysioGo.Lite range of devices.
- In case of mechanical damage to the battery module, there is a risk of fire, explosion or burns, due to used lithium-ion cells.
- Do not throw the battery or hit it. Do not heat it or incinerate.
- Do not short-circuit the contacts or disassemble the casing.
- Do not immerse in liquids.
- Operation, storage and transport conditions are presented in chapter 4.2.



4.4 Explosion proof environment

PhysioGo.Lite Sono is not adopted to operation in rooms, where combustible gases or their vapors occur. It is recommended to avoid anesthetics or oxygen derivate gases, such as nitrous oxide (N₂O) and oxygen. Some materials (e.g. cotton, wool) may after saturation with oxygen become combustible at high temperatures generated with normal operation of equipment. It is recommended that solutions of adhesive and combustible solvents be vaporized before equipment is operated. It is also recommended to pay attention to the danger of

ignition of endogenous gases. The unit must be separated from the mains before approaching the disinfection room, where it is installed.



4.5 Electromagnetic environment

The SMPS may be connected to the mains only by a special, detachable mains power supply cord integrated with the PLMF2A anti-interference filter. This filter is used to reduce electromagnetic disturbance that is produced during ultrasound therapy treatments.

- Due to the intended use the device can be used in hospitals, clinics, health centers, GP practices, rehabilitation offices and other health care facilities, under the supervision of qualified personnel.
- Simultaneous operation of PhysioGo.Lite Sono unit with devices generating strong electromagnetic field, such as short wave and microwave diathermies, high frequency surgical equipment, MRI systems, may disturb unit operation. For this reason, it is recommended to maintain appropriate distance between these devices or to switch off the generator of strong fields during therapy with the PhysioGo.Lite Sono unit. Manufacturer doesn't claim compatibility of the PhysioGo.Lite Sono unit with high frequency surgical equipment.
- If the device is subjected to electromagnetic interference with an intensity that exceeds the compliance levels declared in Section 11.2, the display may be affected, generation may be interrupted or the device may restart.
- **WARNING:** Use of the PhysioGo.Lite Sono adjacent to or stacked with other equipment should be avoided because it could result in improper operation. If such use is necessary, the PhysioGo.Lite Sono and the other equipment should be observed to verify that they are operating normally.
- It is recommended to use original accessories, spare parts and equipment of Astar.
- **WARNING:** Use of accessories, transducers and cables other than those specified or provided by the manufacturer of this equipment could result in increased electromagnetic emissions or decreased electromagnetic immunity of this equipment and result in improper operation.
- **WARNING:** Portable RF communications equipment (including peripherals such as antenna cables and external antennas) should be used no closer than 30 cm (12 inches) to any part of the PhysioGo.Lite Sono, including cables specified by the manufacturer. Otherwise, degradation of the performance of this equipment could result.

The PhysioGo.Lite Sono meets requirements of electromagnetic interference emission and immunity standards and shall not pose a threat to correct operation of the other devices. Compliance levels for emissions and immunity are given in the chapter 11.2.

4.6 Operation of touch-sensitive displays

Table 4-1. Recommendations for the operation of touch screens

Type of display	Method of operation of the display
5" with a resistive touch panel	Recommended: <ul style="list-style-type: none"> • Pen designed for resistive screens – preferably with a narrow plastic tip Admissible: <ul style="list-style-type: none"> • Operator's finger – much lower comfort of operation compared to the pen

4.7 Applied parts

The PhysioGo.Lite Sono unit has an applied part of BF type. It includes:

- three types of ultrasound heads,
- ultrasound heads sockets,
- ultrasound heads plugs with cables.

The elements of the applied part are connected together. Physical contact of the ultrasound head with patient's body during normal use is essential for the device to perform its function.

The specification of the leads, along with the location of the output sockets and the characteristics of ultrasound heads are described in detail in the chapters 5.1 and 5.5. The appropriate symbol of the BF type applied part is placed on the sockets label.

4.8 Essential performance

With regard to the PhysioGo.Lite Sono, essential performance is the generation of an ultrasonic wave with a frequency in the range of 500kHz – 5MHz in:

- continuous mode or
- pulse mode – with adjustable duty factor and frequency of packets, with the use of ultrasonic transducers.

The device meets the requirements of IEC 60601-2-5 standard, where:

- the maximum effective intensity,
 - the accuracy of output power, effective radiating area and effective intensity (power density),
 - the acceptable level of unwanted ultrasound radiation,
 - the temperature limits of ultrasonic transducers
- are defined.

4.8.1 Tests of essential performance and basic safety



The user of unit must perform technical inspection of the unit at year's intervals. The inspection must be performed by a service authorized by the manufacturer. The inspection is performed at the user's expense. Recommendations for test:

Table 4-2. Recommendations for test of essential performance and basic safety

Test item	Method of checking	Acceptance criteria	Required measuring equipment
Safety test: <ul style="list-style-type: none"> • patient leakage current measurement, • touch current measurement, • insulation resistance if necessary 	The manufacturer allows the methods compliant with the requirements of the standards: <ul style="list-style-type: none"> • IEC 60601-1 • IEC 62353 	The measurement results are within the limits specified by the applied standard	Safety tester meeting the: <ul style="list-style-type: none"> • IEC 60601-1 • IEC 62353 requirements
Control of correctness of the performed self-test	Visual inspection	No errors	No requirements
Evaluation of keyboard function and operation	Manual and visual inspection	The keys respond properly to pressure	No requirements
Evaluation of touchscreen function and operation	Manual and visual inspection	The touch panel responds correctly to pressing	No requirements
Inspection of the controller condition for casing defects and damage of sockets	Visual inspection	No deformation or cracks of the casing Undamaged sockets No loosened sockets	No requirements
Inspection of the heads condition for casing defects and damage of interconnecting cables and connectors	Visual inspection	No deformation or cracks of the casing No tear and bending of cables insulation Undamaged connectors	No requirements
Inspection of the SMPS condition for casing defects and damage of interconnecting cables and connectors	Visual inspection	No deformation or cracks of the casing No tear and bending of cable insulation Undamaged connector	No requirements

4. Operational safety

Test item	Method of checking	Acceptance criteria	Required measuring equipment
Inspection of the mains filter condition for casing defects and damage of interconnecting cables and connectors	Visual inspection	No deformation or cracks of the casing	No requirements
		No tear and bending of cable insulation	
		Undamaged connector	
Test of the power emitted by ultrasound heads	The manufacturer allows the methods compliant with the requirements of the IEC 60601-2-5 standard	The accuracy of the power indication is within a tolerance of $\pm 20\%$	Radiation force balance or ultrasonic power meter
Detection of lack of contact of the ultrasound head	Visual inspection	Signaling by LED indicator / indicators on the head	No requirements
		Bars presenting the ultrasound head contact quality are not highlighted.	
		Message on the screen	

The inspection must also include verification of the quality of applied accessories and treatment materials.

Positive result of the technical inspection confirms that basic safety and essential performance is maintained.

4.9 Disposal

In case, when the disposal of the unit will become necessary (e.g. after elapse of its service life), please contact the manufacturer or manufacturer representative, which must react in an appropriate way i.e. collecting the unit from the user. The user may also contact companies specialized in removal and/or disposal of electrical devices or computer equipment. Under no circumstances should you place the unit along with other wastes. The name plate includes an appropriate symbol (see Appendix at the end of the User Guide).

The unit is marked with an appropriate symbol complying with the directive on waste electrical and electronic equipment (WEEE) – see table with description of the symbols used to label the product presented in **Appendix A**.

5. Unit description

5.1 General characteristics

Ultrasound therapy unit PhysioGo.Lite Sono is a highly specialized medical device based on modern microprocessor platform.

The unit has a plastic console casing. It is equipped with a color touch LCD display with a diagonal of 12.7 cm (5"). On the rear side of the casing are located:

- power switch,
- fuse socket,
- mains socket,
- sockets for connection of ultrasound heads,
- combined therapy socket.

General view of the unit is presented in Figure 5.1, view of the rear panel in Figure 5.2.



Figure 5.1 General view



Figure 5.2 Unit rear panel view





5.2 Front panel

Arrangement of front panel components is shown in figure 5.3.



Figure 5.3 Arrangement of front panel components

Table 5-1. Description of front panel components

Symbol	Description	Function
1.	Liquid crystal display	The unit is equipped with a touch-sensitive display. The screen clearly displays all information related to the device operation.
2.	Operation status and battery level indicators	See 5.2.1.
3.	Turn ON/OFF key (STANDBY)	This key is marked with the symbol  . In order to activate the unit in the case of battery operation, please hold on for at least 5 seconds. Extension of the holding time prevents unintentional activation during transport.
4.	Edit keys	These keys are marked with symbols   . Pressing any of them results in change of value of edited parameter or setting in setup mode. Keep holding the key down to change a parameter quicker.
5.	START/STOP key	This key is marked with the symbol  . It is used with the sequence of starting emission. Its pressing, after setting of treatment procedure parameters starts emission. Pressing of this key once again stops the treatment procedure. The emission of signal is stopped.

5.2.1 Operation status and battery level indicators

Symbols and description of unit operation status signaled by LED indicators are summarized in the table below.

Table 5-2. Non-battery unit



Symbol	Color	Indicator status	Mains switch	Explanation
 Operation status indicator	Green	No light	OFF („0“)	The unit is turned off. Turning ON: <ul style="list-style-type: none"> • Turn the mains switch on • Press the STANDBY key
		Blinks	ON („1“)	Unit is in standby mode. Turning ON: <ul style="list-style-type: none"> • Press the STANDBY key
		Steady light	ON („1“)	The unit is ready for operation.
 Battery level indicator	Yellow	No light	---	No battery.

Table 5-3. Unit equipped with battery



Symbol	Color	Indicator status		Mains switch	Explanation
		Readiness	Battery		
 	Green	No light	No light	OFF („0“)	The unit is turned off. Turning ON: <ul style="list-style-type: none"> • Turn the mains switch on • Press the STANDBY key
		Blinks slowly	No light	ON („1“) Mains cable connected	Unit is in standby mode. Battery is fully charged. Turning ON: <ul style="list-style-type: none"> • Press the STANDBY key
		Blinks slowly	Blinks slowly	ON („1“) Mains cable connected	Unit is in standby mode. Battery is being charged. Turning ON: <ul style="list-style-type: none"> • Press the STANDBY key
	Yellow	Steady light	Blinks slowly	ON („1“) Mains cable connected	The unit is turned on. Battery is being charged.
		Steady light	No light	ON („1“) Mains cable connected	The unit is turned on. Battery is fully charged.
		No light	Steady light	ON („1“) Mains cable disconnected	Unit is running on battery supply.

Table 5-4. Additional information about battery indicator

Symbol	Color	Battery indicator status	Explanation
	Yellow	Blinks fast for 4 seconds	Battery module has been disconnected.
		3 pulses	Battery low.
		5 pulses	Battery error. Turn the unit off using STANDBY key and switch the power switch off. Restart it after 10 seconds. If the problem repeats, contact your authorized service.

5.3 Battery installation

PhysioGo.Lite Sono can be optionally fitted with a battery. Users can install the battery by themselves.



WARNING: Before performing the below actions, turn the device power off and disconnect the SMPS from the mains.

The battery assembly method is illustrated in the following figures.

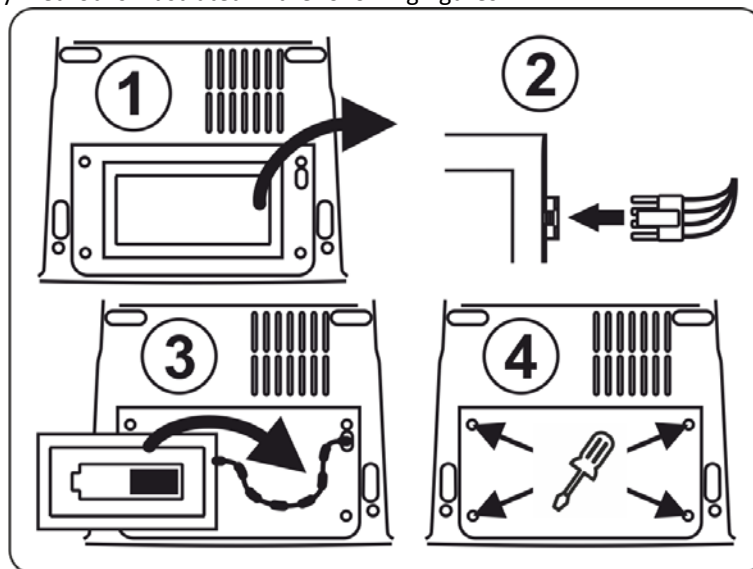

Figure 5.4 The battery installation method

Table 5-5. The battery installation method

Action no.:	Description
1.	Turn the device over.
	Unscrew four battery cover screws.
	Remove the stabilizing cartridge. Keep it for further use.
2.	Connect battery cable to the battery socket.
3.	Place the battery in the enclosure.
4.	Reinstall battery cover by means of 4 screws.
	Turn the device over to its normal position. Connect power supply to the mains. Switch on the unit and check if it starts correctly.

The above information is summarized on labels placed on the battery cover.

5.4 Name plate and label with parameters

The name plate is located on the bottom of unit casing. Among others there are following data on the name plate (see **Appendix A**):

- device version,
- serial number,
- nominal voltage and frequency of operation,
- type of applied fuses,
- manufacturer's data.

The label with ultrasonic wave parameters is located on the bottom of unit casing (see **Appendix A**):

- acoustic working frequencies (f_{awf}),
- waveforms,
- values of pulses durations (pd), pulses repetition periods (prp), duty factors (DF).

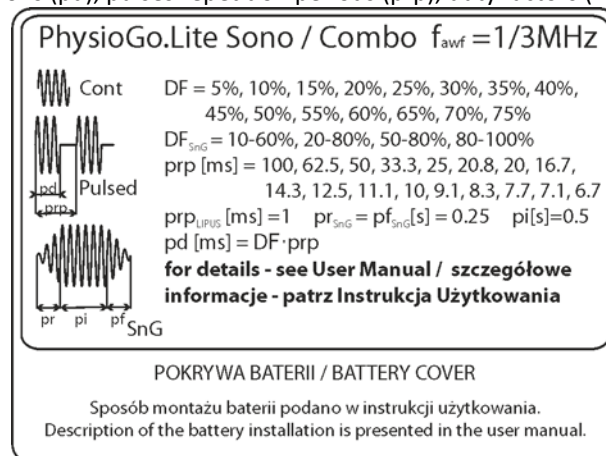

Figure 5.5. Label with parameters

5.5 Ultrasound heads

The unit can operate with following types of ultrasound heads:

Head type	Characteristics and intended use
GU-5	<ul style="list-style-type: none"> • standard head • basic type of head for carrying out the ultrasound therapy, phonophoresis, LIPUS and combined therapy (with connection to an electrotherapy device) • total area of the head front – 5 cm² • effective radiating area – 3.4 cm² • integrated temperature sensor
GU-1	<ul style="list-style-type: none"> • standard head • head intended to small body parts • total area of the head front – 1 cm² • effective radiating area – 0.7 cm² • integrated temperature sensor
SnG	<ul style="list-style-type: none"> • hands-free head • head for carrying out the ultrasound therapy, phonophoresis, LIPUS and combined therapy (with connection to an electrotherapy device) • 2 ultrasonic transducers in one head - it can operate in single-transducer and dual-transducer mode • possibility to operate in single-section (A/B) or dual-section (A+B) mode • total area of the head front in single-section mode – 17.3 cm², in dual-section mode – 34.6 cm² • effective radiating area – 3 cm² • integrated temperature sensor

The following data are located on the ultrasound head name plate (see **Appendix A**):

- acoustic working frequency,
- beam type,
- beam non-uniformity ratio,
- nominal power,
- effective radiating area,
- manufacturer's data
- serial number, reference number, production date, version,
- degree of protection provided by the enclosure,
- symbols, e.g. applied part type,
- conformity mark.

5.5.1 Main features of SnG head

The hands-free SnG head has two ultrasonic transducers placed in one housing. The general view is shown in Figure 5.6. The head is intended basically for stationary therapy, and thanks to eyelet, it can be attached to the patient's body with hook-and-loop belts. The attachment method is shown in Figure 5.7.

SnG heads have LED indicators to show which front is currently active.



Figure 5.6 SnG ultrasound head

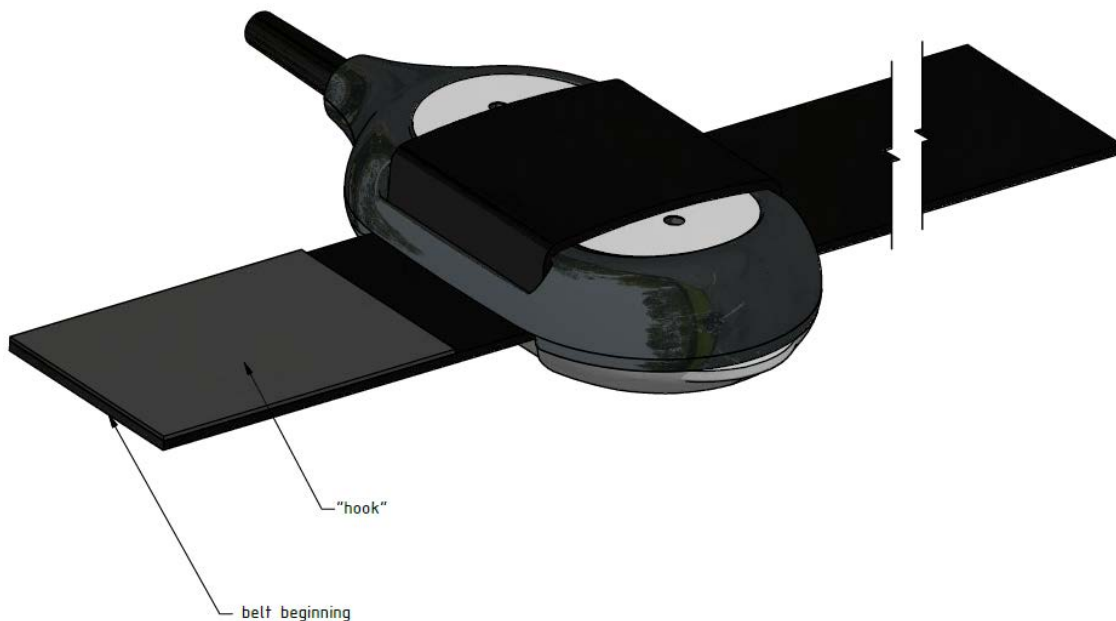

Figure 5.7 Way of inserting the hook-and-loop belt through the head eyelets

It is possible to combine two SnG heads into dual-section work, which allows for the treatment of larger areas simultaneously.

5.5.2 Signaling the lack of contact of the ultrasound heads

The unit has a system controlling the quality of contact between a head and the patient's body during the treatment process, which aids the operator in a proper treatment performance. In case the quality of contact worsens (e.g. not enough gel, bones too close), the output power of the head is reduced to the minimum level ensuring the continuity of the generator operation.

The way the device reacts (the time after which the message is displayed and the way the treatment timer works) depends on the type of applied head and the settings saved by the user – see chapter 6.3.4.5.

The quality of contact during the treatment is presented on the display in the form of bars of different heights – see chapter 7.3.

The standard heads have an LED indicator that signals the contact quality. This indicator status should be interpreted as follows:

- if it does not light up during the treatment – it means that the head is in good contact with the patient's body,
- if it blinks or glows continuously during the treatment – it means poor contact of the head with the patient's body.

When working with hands-free heads, the lack of contact is signaled:

- by lighting of the LED indicator in the single-transducer mode – as for standard heads,
- only by the bars of different heights (see 7.3) in multi-transducer mode.

5.5.3 Temperature control of ultrasound heads

The ultrasound heads are equipped with temperature sensors. By using them the controller periodically controls the temperature of the heads' fronts. This mechanism prevents the temperature from rising above the limit specified in IEC 60601-2-5. The moment when the temperature is measured is signaled by the LED indicator of the head turning off.

6. Device installation and start-up

6.1 Unit installation



The first installation should be performed by a qualified manufacturer's or distributor's representative!

After removing the unit from the carton, check if the complete unit has been delivered. In case of any inconsistencies contact the distributor or manufacturer.



After removing the unit from transportation packaging wait approximately two hours before proceeding to next installation steps. This is aimed at adaptation of the unit to conditions in operation room.

The unit shall be placed on a table or in a cabinet near mains socket with power input 100-240V and frequency 50/60 Hz. It is recommended to place the unit at such a height that it would enable convenient operation from the front panel.

The light shall enable easy readout of display indicators, however the unit shall not be exposed to direct sunlight.



Ultrasound heads may only be connected to the sockets when the mains supply is switched off. Plugging head to switched on unit will make the head be undetected, so its use will not be possible. Sometimes it may also damage the ultrasound head.

6.1.1 Assembling of the holders

According to possessed accessories to the unit casing you can mount holders for ultrasound heads.

In order to mount the holder:

Step	Description
1.	Loosen the clasps and remove the holder masking cover – black parts of the casing located on the left and right side of the screen.
2.	Unscrew two screws under the cover at the outer edge.
3.	Adjust the holders and screw bolts in.
4.	Reattach the masking cover. Pay attention to the orientation of the SnG head in the holder.

Method of mounting the holders is presented in the following figures.

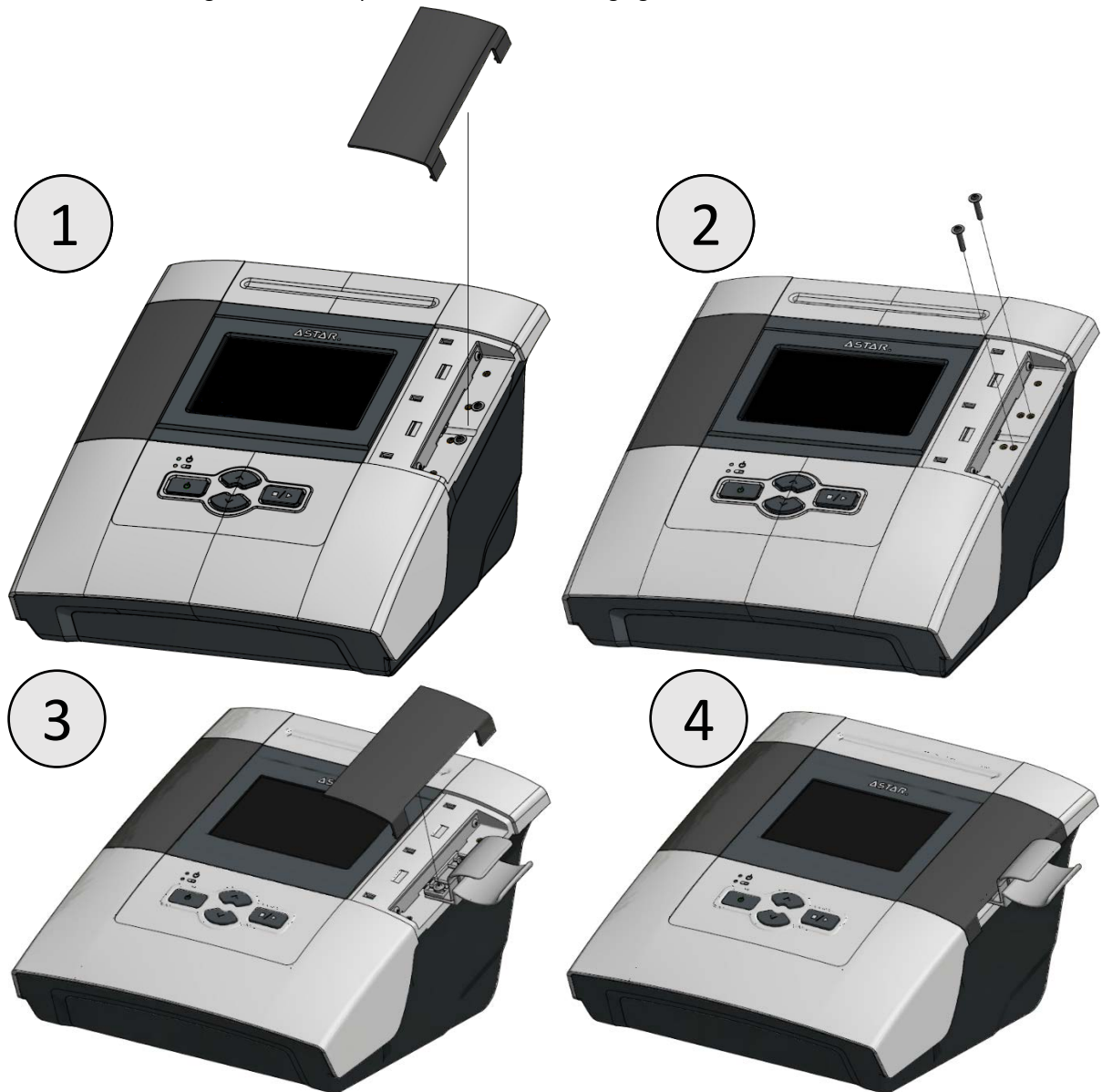

Figure 6.1 Method of mounting the standard ultrasound head holder

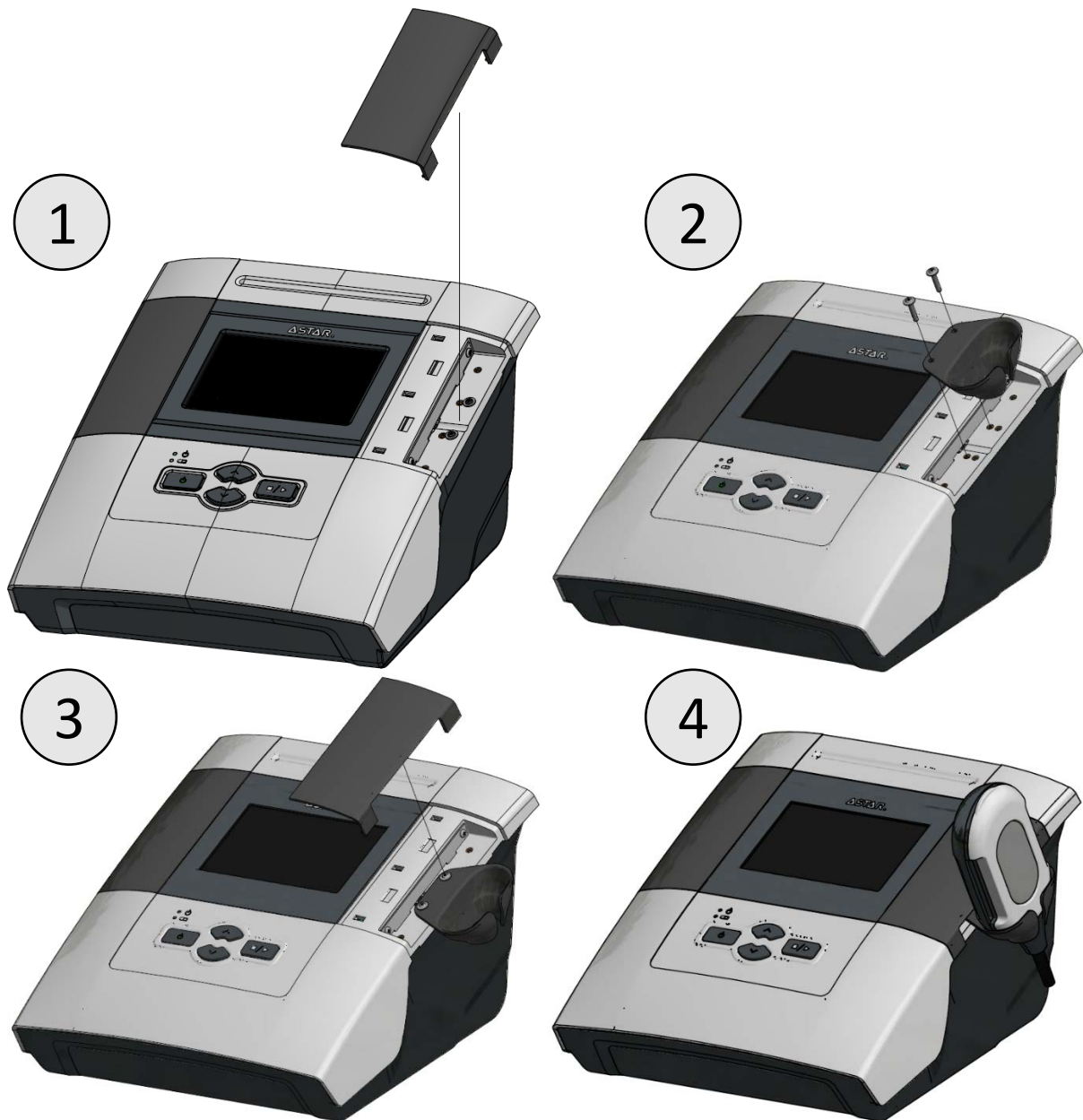

Figure 6.2 Method of mounting the SnG head holder

6.1.2 Connection of ultrasound heads

Ultrasound heads should be connected to sockets according to Figure 6.3. All connectors are protected against pulling out. When plugging a connector in, twist the thread to secure it.

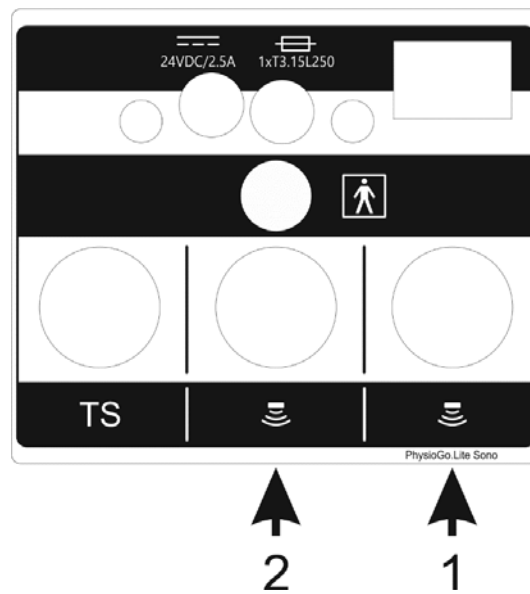

Figure 6.3 Ultrasonic heads sockets



GU heads are not identical to GS heads used in previous ultrasound therapy devices such as Etius, PhysioGo, Sonaris. They cannot be used interchangeably. SnG head is not supported by other devices.

6.1.3 Connection in combined therapy

Connect a black plug of patient's cable to the TS socket. The color of the socket implies the proper connection. More details are presented in the chapter 7.9.

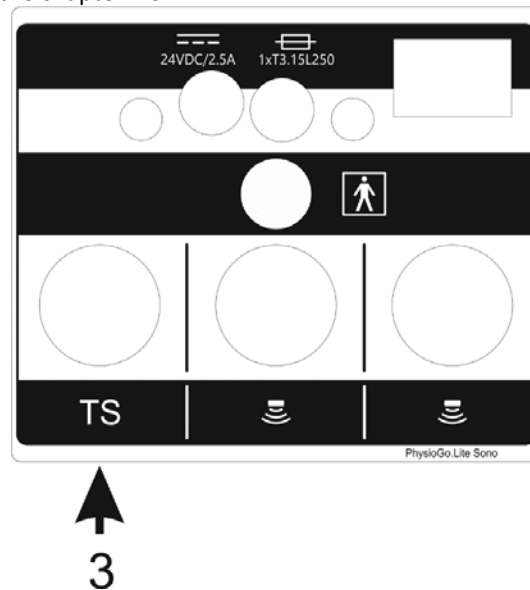





Figure 6.4 Combined therapy socket

6.2 First operation

Connect the SMPS to the mains using the cable with integrated mains filter. Then connect output cord of the SMPS to the device socket marked with symbol , located on the back of the unit. Switch the power switch on. Then press the STANDBY key  to start the operation. After switching the mains supply on proper work of all blocks are tested.

In the case of battery operation, please hold on for at least 5 seconds the STANDBY key . Extension of the holding time prevents unintentional activation during transport.



If after switching on mains supply the display is illegible and no light indicator is illuminated, check whether mains fuse or mains cable operate correctly. Care shall be given to apply fuses with rating given on the name plate. If fuse and cables are working properly, contact the authorized service.
If the self-test results in appearing on the display the information about unit or connected equipment defect along with the error code, turn the unit off and contact the authorized service.

Do not touch the screen during the system start-up.





6.3 Setup mode

6.3.1 Basic information

Keyboard components designed for the unit operation are called "**keys**".

The area on the screen, where after its pressing a specific unit reaction is followed, is called "**button**".

The area on the screen that has the possibility to select or deselect any item, is called "**selection field**".

To enter Setup mode, press	
To leave Setup mode, press	
To leave Setup mode without changes, press	
To go back one level, press	



Setup mode is available only if the treatment is not performed. Some setting options depend on the connected accessories. In the absence of some accessories, the options will not be available.

6.3.2 Language

Information on the display may be presented in different language versions (depending on the software version). The user is free to select language options.

To set the language version, press the **Language** button in the list of setup options, then press the desired version. The language version is changed after the operation is confirmed.

6.3.3 Global settings

6.3.3.1 Date and time

In this section there is a possibility to adjust date and time. To change these settings, press the button **Edit**. Using arrows, set the required value. Confirm settings using **Set** button or leave the edition mode by pressing **Cancel**.

6.3.3.2 Sounds

The user may configure settings of acoustic signals, which occur during unit operation. Description of available configuration options:

- Keys sound
- Sound during treatment
- End of treatment sound
- Warning sounds
- Initial sound

- End of treatment sound – see table below

Setting	Device reaction
0	No signal
1 – 10	Number of signals
∞ (infinity symbol)	Signal active until disabled by the operator

- Sound tone – type of emitted signal.

In order to set the appropriate option, select or clear the selection field by pressing it. For the "End of treatment sound" and "Sound tone" parameters, click on the value to change it.

6.3.3.3 Volume

The user may adjust sound volume level. To perform this action:

- press the volume bar at desired place, or
- use buttons  on the screen.

6.3.3.4 Display

The user may adjust display brightness level. To perform this action:

- press the value bar at desired place, or
- use buttons  on the screen

6.3.4 Functional settings

6.3.4.1 Channel operation mode selection

This function allows the user to set preferred style of unit operation.

Option	Explanation
Manual mode – automatically	After therapy selection, the unit is set in manual mode of the operation.
Program mode – automatically	After therapy selection, the unit is set in program mode of the operation.
Mode selection pop-up	After therapy selection, the unit displays a window with a list of operation mode selection options.

In order to set the appropriate option, select or clear the selection field by its pressing.

6.3.4.2 Program groups / medical fields

This function allows the user to set filters of available program mode options according to the preferred program groups or medical fields. In order to set the appropriate option, select or clear the selection field by its pressing.

For program groups, the following options are available:

- Preset programs
- User programs

For medical fields, instead of the preset treatment programs the following options classified by medical nomenclature are available (according to chosen applicator):

- Orthopedics
- Sports medicine
- Aesthetic medicine
- Rheumatology
- Neurology
- Dermatology
- Angiology

The classification of preset treatment programs into the above-mentioned categories do not limit their applications in other fields, according to the knowledge and experience of doctors and physiotherapists.

6.3.4.3 The battery save mode

When the mode is activated, the device switches automatically into the standby mode after two hours of inactivity, which prolongs the battery life.

6.3.4.4 US head sensitivity

For advanced users only!

It is possible to modify sensitivity of ultrasound heads in terms of no contact detection. According to treatment specifics, the sensitivity can be improved or reduced beyond default settings.

To change it you need to:

Step	Description
1.	Enter the setup mode. Select the Functional settings tab, then select the US head sensitivity .
2.	Select the ultrasound head type.
3.	Set a new sensitivity value.

Main features of sensitivity settings are listed below.

Sensitivity settings	Advantages	Disadvantages
Default	Default manufacturer settings	
High	<ul style="list-style-type: none"> forced use of precise treatment technique, i.e. for training purposes protection of the ultrasound head against too fast usage 	<ul style="list-style-type: none"> improved sensitivity on load's changes treatment timer stops more frequently
Low	<ul style="list-style-type: none"> reduced sensitivity on load's changes facilitated treatment performing on small parts of the body facilitated treatment performing on areas including bones, e.g. hands facilitated phonophoresis treatment performing treatment timer does not stop frequently 	<ul style="list-style-type: none"> rapid usage of ultrasound head – possible overheat reduced comfort of patient's sensations – possible increase of heat feeling in the tissue

6.3.4.5 US head contact signaling

This function allows you to set the time after which in case of US head weak contact the treatment will be interrupted.

Option	Explanation
Default	The treatment will be interrupted after ten seconds when the US head will lose the acceptable level of contact quality with the patient's body.
Delayed	The treatment will be interrupted after 20 minutes when the US head will lose the acceptable level of contact quality with the patient's body.
Correction of treatment time	Option selected – treatment timer is not stopped after detecting lack of contact.
	Option unchecked – treatment timer is stopped after detecting lack of contact.

In order to set the appropriate option, select or clear the selection field by its pressing.

6.3.5 Control functions

6.3.5.1 Miscellaneous

In this section there is a possibility to manage some basic service functions:

- **Delete user programs** – button allows you to remove user-defined programs.
- **Calibrate the touch panel** – button starts the display calibration procedure. Follow the messages on the screen. First, touch three points, then validate the operation by touching five points on the screen.



You can also calibrate the display by pressing the   key combination simultaneously when starting the device. The progress bar will change to green and the calibration screen will be displayed when started.

- **Test the touch panel** – button allows you to check the touch screen operation – on the touched spots an indicator occurs:
 - red at the pressed spot,
 - yellow at the pressure detection spots,
 - white at the spot where the pen or finger is removed (it should coincide with the red one).



Press the START/STOP key to exit the test mode.





6.3.5.2 Date of inspection

There is possibility to enter into the device the date of the next inspection – it will automatically remind you about the need to perform an annual technical inspection.

6.3.5.3 US head calibration

In order to exercise the option, follow the instructions shown on the display. This function allows you to adjust the head settings associated with the contact quality detection with the patient's body during treatment. It is recommended to carry it out in case of problems during normal operation.

In order to properly perform the procedure clean and dry out the ultrasound head.

Step	Description
1.	Prepare a plastic container with a capacity of 1 liter of water.
2.	Switch on the unit.
3.	Press the field 
4.	Select the tab Control functions
5.	Select the tab US head calibration
6.	Select the head and press the field.
7.	Measure the head without load – "in the air". Press the  /  button.
8.	Put the ultrasound head into the container filled with water. Press the  /  button.
9.	If necessary, adjust the US head sensitivity settings by selecting a different field from the default.
10.	Press Save the calibration to save the settings or Return to cancel and return to the procedure beginning.

6.3.6 Information

6.3.6.1 Info

Provides information about the serial number, version of the unit, software, interface and software build date.

6.3.6.2 Manufacturer

Provides information about the manufacturer together with the contact details.

6.3.6.3 Distributor

Provides information about the distributor in a given country together with the contact details. The „Change contact data” button can be use only by authorized unit, after entering the access code. The full data consists of:

- the company name
- the company address
- the company website
- the company phone number
- the company e-mail

If data is not entered, the „-----” characters will be shown.

6.3.6.4 Technical support

Provides information about technical staff (the manufacturer’s or distributor’s) in a given country together with the contact details. The „Change contact data” button can be use only by authorized unit, after entering the access code. The full data consists of:

- the company name
- the company address
- the company website
- the company phone number
- the company e-mail

If data is not entered, the „-----” characters will be shown.

The „Show logs” button supports service diagnostics, by displaying information about all saved device errors.



6.3.6.5 Unit statistics

Provides information about the number of treatment procedures performed. Statistics can be deleted. If you want to delete statistics, press **Delete programs counters** button.

6.3.6.6 Accessories statistics

There appears the information on connected accessories.

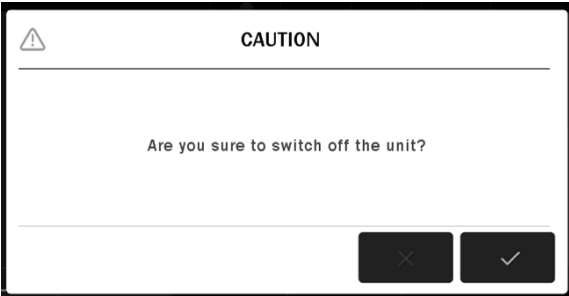
6.4 Transport position – trolley for the unit and accessories

Step	Description
1.	Click the UNIT ON / OFF (STANDBY) button on the front panel  .
	A message will appear on the display:
2.	
3.	Press  to shut down the system correctly.
4.	Disconnect from the controller the power cord and all heads.
5.	Remove the device and applicators from the trolley.
6.	Then unlock all wheel brakes of the trolley.
7.	Transport the trolley. Move the device and heads separately.
8.	After arranging the trolley in the destination place, lock the brakes.
9.	Place the device on the upper shelf. Reconnect the switched-mode power supply and heads.



7. Unit operation

The unit may operate in one of two modes:

- program mode,
- manual mode.



Notes – unit operation:

- In the program mode you can use preset procedures of treatment programs, as well as user-defined programs and sequences.
- In the program mode you cannot edit the preset programs parameters. However, they can be easily “copied” to the manual mode. In order to do it, press the button  .
- There is a possibility to repeat the completed treatment. In order to do it, press .

7.1 Patient preparation and treatment performance

7.1.1 General information

To perform safe and effective treatment procedure you are obliged to:

- make sure if there are no contraindications to perform the treatment,
- the patient should be placed in a comfortable position while providing relaxation of tissues in the treatment area, the patient should be in lying position in case of treatment performed near the head,
- sitting or reclining position should be applied to patients with respiratory disorders or breathing difficulties,
- inform the patient about the possible feelings occurring during treatment procedure.



The treatment effectiveness depends on the choice of parameters to the current patient’s condition. The patient’s condition changes over time. Its observation and assessment should take place before, during and after therapy. Such an action is necessary for changing the parameters in order to adapt them to the actual condition of the patient.

It is recommended to keep the records of treatment, including the parameters of the therapy, the area of treatment, treatment technique, dose and symptoms after therapy. If the treatment does not generate the intended effects, change of treatment parameters should be taken into consideration. It is necessary to continuously update knowledge and follow literary activities in the scope of therapy.

When performing therapy, it is recommended to follow the guidelines given in the following sections.

7.1.2 Ultrasound therapy

- Before the treatment it is necessary to check the efficiency of functioning of the equipment and to control the cables and ultrasound head.
- It is necessary to explain to the patient the method of treatment and sensations during the treatment (always painless). This can be done with the help of the encyclopedia containing figures, description of the treatment methodology and parameters.
- It is necessary to clean the skin (or soap or alcohol 70%) in the place of application. If skin is very hairy in the place of treatment, it is necessary to shave it gently, cover the remaining parts of the body in order to avoid undercooling.
- The position of the therapist should facilitate free access to the equipment in such a way that the ultrasound head should remain for the whole time of treatment in contact with the skin of the patient. Proper pressure is necessary in order to ensure firm contact between the skin and the head which enables optimal transmission of ultrasound energy.
- It is necessary to use the coupling medium conducting the ultrasounds, preferably gel.

- Coupling medium should be applied on the surface of skin, make continuous movements in the form of overlapping or longitudinal circles, the head shall not be removed from skin, in case of pain or burning it is necessary to stop therapy and change parameters.
- It is necessary to locate the tissue affected by the disease (incl. determination of its type, depth), the surrounding tissues and its repair phase, to:
 - choose frequency of ultrasounds (up to 6 cm – frequency 1 MHz, up to 1 cm – frequency 3 MHz),
 - distinguish if it is an acute condition (only mechanical effect of ultrasounds recommended), or chronic condition (mainly thermal effect),
 - choose a method of application (direct, indirect),
 - determine proper starting position: without pain, relaxing position, with treated tissues positioned as close to the surface of skin as possible.
- Ultrasounds in water bath are used if part of the body subjected to therapy is of irregular shape or there is a spot sensitivity enabling direct contact with ultrasound head. Most often it is used in therapy of palms, forearms, feet and ankles. Part of the body subjected to therapy should be immersed in degassed water with temperature pleasant for the patient. Waterproof head must be placed at the distance of 1-2 cm and move parallel to the treated surface. Intensity must be increased by 30 - 50%, to obtain a dose like in direct therapy.
- Output power must be switched on if the head is in direct contact with the skin and at the same time it is in motion. Such a procedure allows to avoid damages to the converter and prevent skin injuries, which may occur if a sufficient amount of energy is taken back to the head. Control system which monitors the contact of the head reduces the output power, if the head's contact is inadequate.

7.1.3 Combined therapy



- Combined therapy consists in simultaneous effect of ultrasounds and pulsed current of low or medium frequency on the tissues, by employing specialized devices generating ultrasounds and currents.
- Influence of ultrasounds increases permeability of the skin for the current, owing to which it is allowed to use smaller doses of amperage. Combination of activity of ultrasounds and currents produces bigger therapeutic effects than in case of their separate application.
- In combination therapy it is possible to precisely localize the place of application with a very small dose of current as the ultrasounds increase the sensitivity of nerve fibers.
- Ultrasounds prevent or clearly decrease the effect of habituation which is negative from the therapeutic point of view, therefore the electric stimulus is more efficient and may be applied in long term without adverse effects.
- Combined therapy is of huge importance both in diagnostics (searching for trigger points, hyperacusis zones and Head's zones) and in treatment.
- In combined therapy ultrasounds are combined with bidirectional pulsed currents (TENS, HVS, average frequency) in order to limit the occurrence of electrochemical reactions and ensure proper depth of penetration.
- Choice of frequency of ultrasounds depends on the localization of trigger point. Frequency 1 MHz is used for treatment of myofascial trigger points and localized in connective tissue, whereas frequency 3 MHz in treatment of surface points in skin.
- The power density of ultrasounds used in combination therapy amounts to 0.5 to 1.5 W/cm².
 - The power density of 0.5W/cm² is employed in the area of face and neck, it is recommended in case of active trigger points and significant painful conditions.
 - The power density of 0.5 to 1.0 W/cm² is employed in the paraspinal area, it is recommended in case of active trigger points and painful conditions of medium intensity and in slim patients.
 - The power density of 1.0 to 1.5 W/cm² is recommended in painful conditions of low intensity, on limbs, in the area of hips and buttocks in stout patients.
- Most often impulse emission of ultrasounds is applied, with duty factor of 20-75%.
- Current parameters in diagnostics of trigger points:
 - traditional, symmetric TENS – frequency 100Hz, pulse time 0.1ms, intensity above sensory threshold,
 - dipole interference, AMF – frequency 100Hz, intensity above sensory threshold.Semi-stable technique, treatment time from several seconds to 2 minutes per one point.
- In combined therapy an active electrode is the ultrasound head, placed above the pain location. Possibilities of placing a passive electrode:
 - outside the area where the treatment is carried out,

- above the nerve supplying the pain area,
- above the spot of referenced pain,
- within a given dermatome, where pain area is located.
- In local therapy the parameters of ultrasounds and current are adapted to the actual condition of tissues.
- Additionally, pay attention to the technique of electrotherapy treatment performance.

7.1.4 Method of treatment performance

Method	Features
Dynamic	<p>The head is moved in a continuous way, by exercising pressure, parallel to the skin, by applying steady, rhythmical motion patterns at average speed of 4cm/sec. Too fast motions cause too low accumulation of ultrasound energy, too slow motions cause overheating of tissues in case of using higher intensities of ultrasounds.</p> <hr/> <p>Choice of the method of moving the head depends on the shape of treated surface. In case of treating surfaces with irregular shape, motion pattern may appear as overlapping circles. This method requires from the therapist to make circular motions of small diameter, the size of ultrasound head should be such that the subsequent circular sliding motion overlaps the half of the previous motion.</p> <hr/> <p>In case of treating larger, flat surfaces it is necessary to carry out longitudinal movements. This method requires from the therapist carrying out sliding movement with the adequate rhythm and carrying out side movements of length equal to half of the ultrasound head's diameter. As far as possible it is recommended to slightly press the head to the skin surface as this increases the penetration of ultrasounds deep into the tissues.</p>
Sem-stationary	<p>Even during treatment of relatively small areas, such as trigger points, elements of scars or tendons it is necessary to make even very small but continuous movements with the head.</p>
Stationary (static)	<p>The head remains motionless during the treatment.</p> <hr/> <p>SnG heads are attached permanently to the patient's body with hook-and-loop belts.</p> <hr/> <p>In multi-transducer application, protection against tissue overheating is achieved by a sequence of switching of ultrasonic transducers and ultrasonic wave modulation.</p> <hr/> <p>In single-transducer application, protection against tissue overheating is achieved by the ultrasonic wave modulation.</p>
LIPUS	<p>The head remains motionless during the treatment.</p>

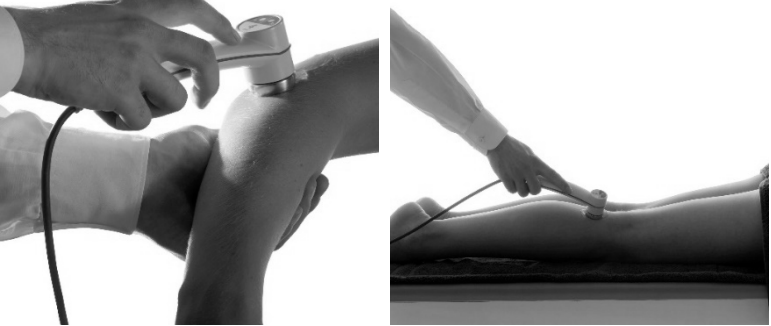
Examples of applications are presented below.

Method	Head	Example
Dynamic, semi-stationary LIPUS	GU-5	
Dynamic, semi-stationary LIPUS	GU-1	

7.2 Screen configuration

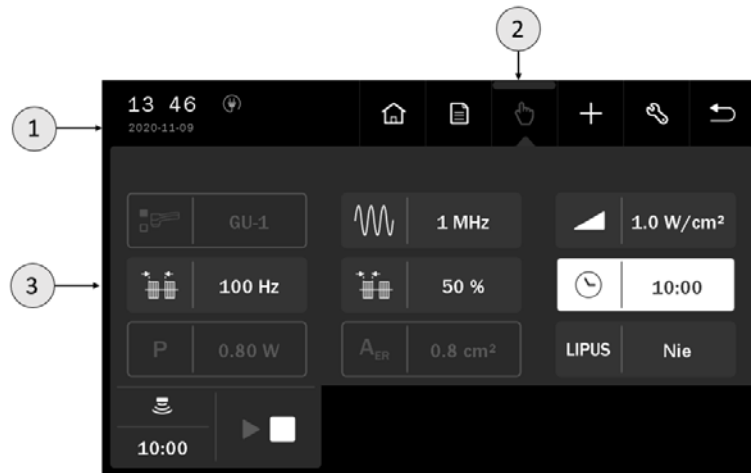









Figure 7.1 Field description

Symbol	Field	Description
		Date and time
1	Status tab	 Battery – quality level battery charging symbols
		 Mains cable connected
		 Therapy and applicator selection menu
		 Program mode
2	Main menu	 Manual mode
		 User-defined treatment programs edition mode
		 Information mode
		 Setup mode
3	Edition field	This field shows: <ul style="list-style-type: none"> • available accessories • treatment parameters in manual mode • preset treatment program lists • user-defined program lists • settings





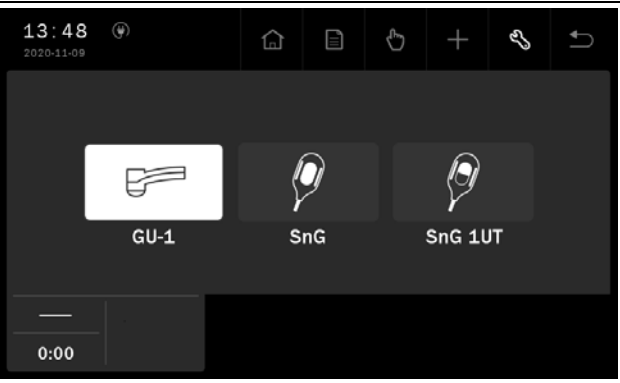
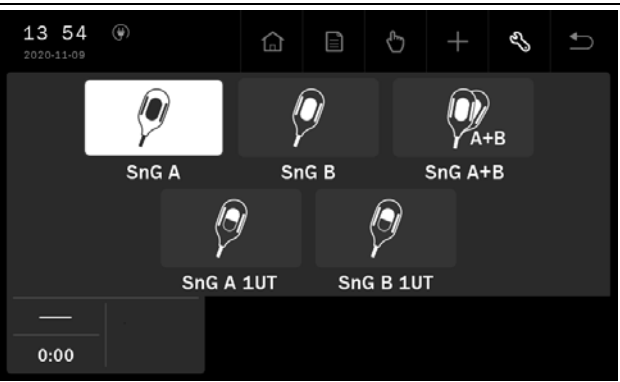
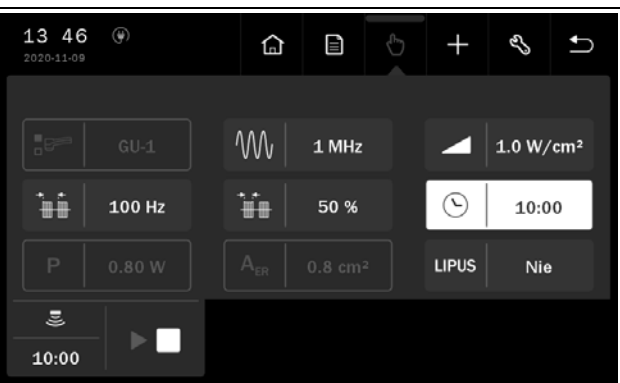

Note: If the edition / main menu field is greyed out, it means that it is inactive.

7.3 General configuration

Examples of accessory configurations are shown below:

Channel	Equipment
	<p>Connected accessories:</p> <ul style="list-style-type: none"> • standard ultrasound head (GU-1) • standard ultrasound head (GU-5) 
1	<p>Connected accessories:</p> <ul style="list-style-type: none"> • standard ultrasound head (GU-1) • SnG head 
	<p>Connected accessories:</p> <ul style="list-style-type: none"> • SnG head • SnG head 
	

The table below explains the meaning of the symbols presented in tab:

Symbol	Description
	Ultrasound therapy symbol
	Ongoing treatment (white symbol)
	Treatment interrupted (white symbol)
	Error (yellow symbol)

7.4 Display description

An example of the appearance of a treatment screen is presented below.

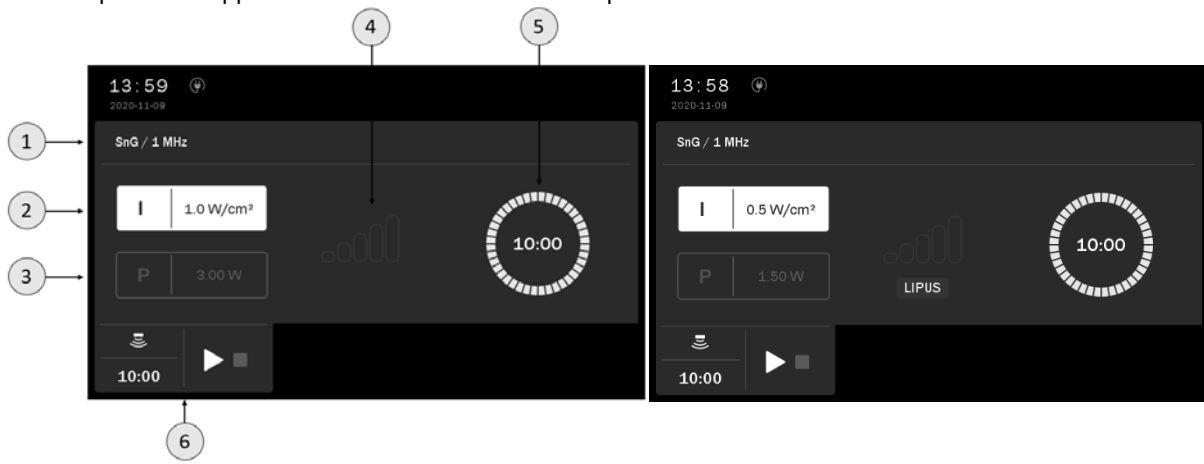

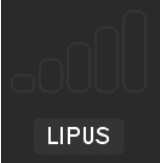

Figure 7.2 Screenshot sample view for SnG head

Symbol	Description
1	Head identifier and frequency / program name
2	I Effective intensity, also called output power density, [W/cm ²]
3	P Output power [W]
4	 Quality of the ultrasound head contact. The more bars are highlighted, the better the contact is.
4	 Quality of the ultrasound head contact in LIPUS mode. The more bars are highlighted, the better the contact is.
5	Treatment timer
6	Tab field – channel 1

7.5 Operation with preset treatment programs

The simplest method of unit's operation is to use its preset programs. The unit includes a database containing several dozens of most frequently met disorders together with suggested treatment types and parameters. In this mode, the operation is reduced to selection of disease entity from the list.



The values of the preset treatment programs parameters are based on the available literature data and they are determined as average values. Parameters should be treated exclusively as indications. Sole responsibility for application of preset treatment programs bears the user.



Pressing the button  after program selection results in appearing information which contains:

- description of treatment performance,
- illustrations with highlighted points or areas of the body covered by the treatment,
- suggested number of procedures, the frequency of repetition,
- impact on the patient,
- notes,
- treatment parameters.

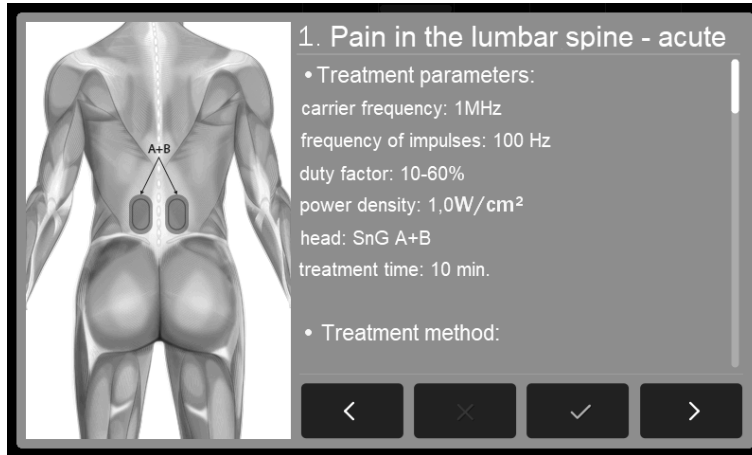









Figure 7.3 Information screen sample view





Information mode navigation:

Symbol	Explanation
	Approval of the program and return to the list (the current position)
	Back to the list of preset programs on a position from which there was an encyclopedia entry
	Go to the next program
	Go to the previous program
	Model of the human body – go to the previous / next illustration for the program







Use   keys or a bar located on the right side of the display to scroll the information.

If it is necessary to interrupt the treatment procedure (pause), press  /  key. To resume the treatment procedure, it is recommended to follow the instructions shown on the display.

Symbol definition and parameters range are given in chapter 8.

Schematic procedures for ultrasound therapy are presented below. In continuous operation, it is recommended to start the treatment procedure from step 2 of the scheme.

Schematic procedure for ultrasound therapy treatments:







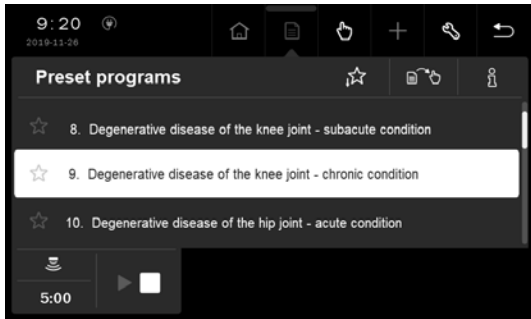

Step	Description
1.	Connect the appropriate ultrasound heads.
2.	Switch on the unit.
3.	If two heads are connected, select the head which is going to be used. If the SnG head is connected, select the operating mode.
4.	Press the field  Program modes
5.	Select the option Preset programs from Program modes menu. Confirm your choice by pressing the selected field again.
6.	Select the program from the list.
7.	Prepare the patient for the treatment according to indications in point 7.1.
8.	Press the key  .
9.	Using the keys   optionally adjust power density of the ultrasound head.

7.6 Favorite programs

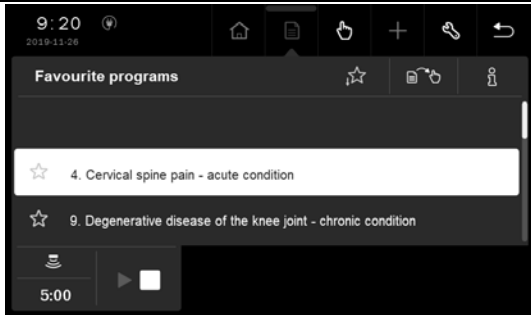

The function offers quick access to frequently used **preset programs** without browsing the entire list. Function is available for all therapies.

To add or remove the program from the favorite list, follow the instructions:







Step	Description				
1.	Prepare the unit to work with preset treatment programs (see section 7.5). Select the program.				
2.	<div style="display: flex; justify-content: space-around;"> <div style="width: 45%;">  </div> <div style="width: 45%; text-align: center;"> <table border="1" style="width: 100%; background-color: #f0f0f0;"> <thead> <tr> <th style="width: 50%; text-align: center;">add</th> <th style="width: 50%; text-align: center;">remove</th> </tr> </thead> <tbody> <tr> <td style="text-align: center;"> Press the symbol  next to the name of the selected preset treatment program. Symbol color changes to yellow and the program is inserted on the favorite list. </td> <td style="text-align: center;"> Press the symbol  next to the name of the selected preset treatment program. Symbol color changes to blue and the program is deleted from the favorite list. </td> </tr> </tbody> </table> </div> </div>	add	remove	Press the symbol  next to the name of the selected preset treatment program. Symbol color changes to yellow and the program is inserted on the favorite list.	Press the symbol  next to the name of the selected preset treatment program. Symbol color changes to blue and the program is deleted from the favorite list.
add	remove				
Press the symbol  next to the name of the selected preset treatment program. Symbol color changes to yellow and the program is inserted on the favorite list.	Press the symbol  next to the name of the selected preset treatment program. Symbol color changes to blue and the program is deleted from the favorite list.				
3.					
4.	--- You can also remove the item from the favorite list, if you press the symbol  .				

To enter the favorite list, press the symbol .



If no item from the preset treatment program list is selected as a "favorite", the after entering the option, the list will be empty.

NOTE: Favorite option is not available when you set the view of preset treatment programs by medical fields. See point 6.3.4.2.

7.7 Manual mode operation

Step	Description
1.	Connect the appropriate ultrasound heads.
2.	Switch on the unit.
3.	If two heads are connected, select the head which is going to be used. If the SnG head is connected, select the operating mode.
4.	Press the field  Manual mode
5.	Select the parameter for edition, using the keys   set its value.
6.	Prepare the patient for the treatment according to indications in point 7.1.
7.	Press the key  /  .
8.	Using the keys   optionally adjust power density of the ultrasound head.





If it is necessary to interrupt the treatment procedure (pause), press  /  key. To resume the treatment procedure, it is recommended to follow the instructions shown on the display.

7.8 User programs





The User has the possibility to save in to the device memory own sets of treatment parameters in the form of programs.

Saving of user program:



Step	Description
1.	Prepare the unit to work in manual mode (steps 1 – 5 see section 7.7).
2.	Set the program parameters.
3.	Press the button  from main menu.
4.	Select the item number under which the program will be saved. Confirm your choice by clicking the field once again.
5.	Enter the program name. Press the button  .

The user-defined programs are selected in the same way as preset treatment programs. In **Program modes** menu select the option **User programs**.



Edition of user program:

Step	Description
1.	Prepare the unit to work in the program mode (see section 7.5)
2.	Select the option User programs from Program modes menu. Confirm your choice by clicking the field once again.
3.	Select the program for edition.
4.	Press the button  from main menu.
5.	Select the action – Edit .
6.	Correct the parameters.
7.	Press the button  from main menu.
8.	Select the item number under which the program will be saved. Confirm your choice with the key 
9.	Enter or edit the program name. Press button  .

Removal of user program:

Step	Description
1.	Prepare the unit to work in the program mode (see section 7.5)
2.	Select the option User programs from Program modes menu. Confirm your choice by clicking the field once again.
3.	Select the program which will be deleted.
4.	Press the button  from main menu.
5.	Select the action – Remove .
6.	Confirm by pressing  or resign using  .

User program parameter view:

Step	Description
1.	Prepare the unit to work in the program mode (see section 7.5)
2.	Select the option User programs from Program modes menu. Confirm your choice by clicking the field once again.
3.	Select the program which parameters will be checked.
4.	Press button 
5.	Press the button  to return to the user-defined treatment program list.





7.9 Combined therapy treatment

PhysioGo.Lite Sono device can cooperate with devices manufactured by Astar with electrotherapy function. This allows to perform a combined therapy, where the generator of current is the unit with this function, while PhysioGo.Lite Sono controls the operation of the ultrasound head.



If you use the device with electrotherapy function manufactured by another producer, it is obligatory to follow the recommendation that its application part should be of BF type. This is indicated by the appropriate marking (see Appendix A).

An executing element in ultrasound therapy is an ultrasound head, which is also an active electrode in electrotherapy, while an electrode adequate for the selected type of electrotherapy and properly attached to the patient's body is the passive electrode.

Step	Description
1.	Connect the ultrasound head / heads to the PhysioGo.Lite Sono. Connect accessories to the other device.
2.	Switch on both units.
3.	Set the appropriate electrotherapy parameters (according to the User Manual of the electrotherapy device) and ultrasound therapy (see section 7.7). Set the treatment time on PhysioGo.Lite Sono device longer than the time on electrotherapy device.
4.	Connect the PhysioGo.Lite Sono and the electrotherapy device: <ul style="list-style-type: none"> connect the black color plug of the patient's electrotherapy cable into the socket marked TS on the back of the PhysioGo.Lite Sono, connect the red color plug of the patient's electrotherapy cable to the passive electrode.
5.	Prepare the patient for the treatment according to indications in point 7.1. Attach the passive electrode to the patient's body.
6.	Press the key  /  . Next ensure good contact of the head with the patient's body and then start the treatment on the electrotherapy device (according to the User Manual of the electrotherapy device). If you do it in reverse order, the electrotherapy device will detect no flow of current between the electrodes and will indicate this condition with the proper message and a sound signal (see User Manual of the electrotherapy device).





While performing combination therapy treatment we do not recommend using unipolar currents: diadynamic, DC, pulse currents and Träbert currents, due to the current constant component which results in ultrasound head corrosion.

We do not recommend to perform combination therapy with two SnG heads connected. The moment the sections are switched, the current circuit may open and cause temporary discomfort for the patient.



7.10 Safe shutdown procedure

The work flow for the safe termination of the operation:

Step	Description
1.	Click the UNIT ON / OFF (STANDBY) key on the front panel  .
2.	After clicking the button, a message will appear on the display as it is shown on the screen below. <div data-bbox="539 1397 1142 1711" data-label="Image"> </div>
3.	If you want to confirm the operation, select the  button, pressing of which will switch the unit off properly. If you quit turning the unit off, select  .
4.	After closing the system, you can disconnect the unit from the power supply network by means of power switch. If you want to charge the battery, leave the device connected to the mains.

8. Definitions and parameters

The term ultrasounds applies to mechanical vibrations with frequency that exceeds the upper limit of human hearing (above 20 kHz). Electromechanically active substances, that are distorted as a result of an external electric field, are used for generation of ultrasounds used in physical therapy. In physical medicine, sound waves are generated by electroacoustic transducers using the reverse piezoelectric effect. Mechanical vibrations of the piezoelectric element are conducted to the surface of the ultrasound head. Particles adjacent to the vibrating surface of the ultrasonic transducer begin to oscillate around their equilibrium position. The vibrations are transferred to the next particles causing the formation of a mechanical wave that propagates in space and time. When the ultrasound head comes into contact with the patient's body, the ultrasound waves propagate in the form of longitudinal waves, which cause parallel movement of particles in the same direction as the energy flow. The frequencies used in physiotherapy are typically between 0.8 and 3.5 MHz.

Absorption of the energy by tissues to which it is applied produces the therapeutic effects. The greatest amount of ultrasound energy is absorbed in human tissues with a high content of proteins, such as tendons and articular cartilage.

In tissues, the ultrasound produces:

- thermal effects,
- mechanical effects,
- physicochemical changes.

The thermal effect is based on the increase in the temperature of the tissues, that results from the conversion of kinetic and potential energy (molecules oscillation around the equilibrium position) into thermal energy. The physiological responses to the rise of the temperature include:

- increase in collagen flexibility,
- acceleration of blood flow,
- changes in the peripheral nerves conduction velocity,
- increase of pain threshold,
- acceleration of enzymes activity,
- changes in skeletal muscles contractile activity.

The non-thermal ultrasound mechanisms include:

- mechanical changes (micromassage),
- cavitation (formation of cavities penetrated by vapors of liquids, that are result of overcoming cohesive forces and breaking the water bonds in the emerging areas of negative pressure),
- chemical changes.

Under the influence of the mechanical energy of the ultrasounds, the following physiological effects occur:

- increase of the intracellular calcium level,
- degranulation of mastocytes,
- stimulation of fibroblasts activity,
- increase of the permeability of vascular walls,
- increase of angiogenesis,
- increase of the tensile strength of collagen fibers.

Because of the mechanical and thermal effects, the ultrasounds cause physicochemical changes in tissues, including:

- acceleration of conventional reactions as well as oxidation and reduction in aqueous solutions,
- degradation of polymers,
- lysis and reactions in organic solvents.

The biological effect of ultrasounds is the resultant of thermal, mechanical and physicochemical effects and includes:

- agitation of fibroblast activity,
- stimulation of collagen synthesis,
- stimulation of synthesis of non-collagen proteins in fibroblasts (albumin and globulin),
- acceleration of DNA synthesis,
- vasodilation and hyperemia of organs,
- intracellular increase of calcium synthesis,
- degranulation of mastocytes,
- acceleration of angiogenesis,
- agitation of cellular oxidation processes,
- change of cell membrane functions,
- change of nerve fibers conduction rates.

Ultrasounds, due to their biological effects in tissues, are used to:

- treat inflammation,
- reduce pain and swelling,
- increase the flexibility of connective tissue,
- reduce muscle tension,
- accelerate tissue healing, including bone fusion,
- reconstruct and improve circulation.





A low intensity ultrasounds therapy (LIPUS) is a special type of ultrasonic wave incorporated in the device. Generally, they are emitted in pulsed mode with average power density up to 0.1 W/cm^2 (100 mW/cm^2), low frequency (most often 1.5 MHz), short duty cycles (20%), pulse repetition frequency around 1kHz. The low intensity ultrasounds do not cause thermal and destructive effects, they accelerate the healing of open wounds, as well as tendons, nerves and bones.

The ultrasounds in LIPUS mode are used to:

- stimulate bone fusion, tendons and nerve repair,
- support the healing processes in acute and subacute inflammation.

8.1 Standard ultrasound heads (GU-5, GU-1)







Parameters description:

Symbol	Description	Available parameters
	Head type	GU-5 GU-1
	Acoustic working frequency	Available settings: <ul style="list-style-type: none"> • 1 MHz • 3 MHz • 1/3 MHz – switching frequency every 8 seconds • LIPUS – operation only with a frequency of 1 MHz
	Amplitude	Setting – power density [W/cm^2]: <ul style="list-style-type: none"> • $0.1 - 3 \text{ W/cm}^2$ – pulse mode • $0.1 - 2.5 \text{ W/cm}^2$ – continuous mode • $0.1 - 0.5 \text{ W/cm}^2$ – LIPUS Regulation step: <ul style="list-style-type: none"> • 0.1 W/cm^2
	Pulse operation frequency	Available settings: <ul style="list-style-type: none"> • 10 Hz – 150 Hz, variable step • LIPUS – 1 kHz • cont – continuous mode
	Pulse operation duty factor	Available settings: <ul style="list-style-type: none"> • 5 – 75%, 5% step – pulse mode • LIPUS – 20% • cont – 100%

Symbol	Description	Available parameters
	Treatment time	30 seconds – 30 minutes, 30 seconds step (manual adjustment is possible by "holding" the time field by means of a pen / finger – in increments of 1 s, Figure 8.1)
P	Power	Non-adjustable parameter, the result of power density and effective radiating area.
		8,5 W GU-5
		1,75 W GU-1
		10,2 W GU-5
A_{ER}	Effective radiating area	2,1 W GU-1
		3,4 cm ² for GU-5
LIPUS	LIPUS mode	0,7 cm ² for GU-1
		<ul style="list-style-type: none"> • YES – active • NO – disabled

8.2 SnG head – single-transducer mode

Parameters description:

Symbol	Description	Available parameters
	Operating mode	 Non-adjustable parameter, one transducer active
	Acoustic working frequency	<p>Available settings:</p> <ul style="list-style-type: none"> • 1 MHz • 3 MHz • 1/3 MHz – switching frequency every 8 seconds • LIPUS – operation only with a frequency of 1 MHz
	Amplitude	<p>Setting – temporal power density [W/cm²]:</p> <ul style="list-style-type: none"> • 0.1 – 2 W/cm² • 0.1 – 0.5 W/cm² – LIPUS <p>Regulation step:</p> <ul style="list-style-type: none"> • 0.1 W/cm² <p>Amplitude change in the range of 75 – 100% of the setting in the 5s-5s cycle (rise-fall).</p>
	Pulse operation frequency	<p>Available settings:</p> <ul style="list-style-type: none"> • 10 Hz – 150 Hz, variable step • LIPUS – 1 kHz
	Pulse operation duty factor	<p>Available settings:</p> <ul style="list-style-type: none"> • 10-60%, 5s-5s cycle (rise-fall). • LIPUS – 20%
	Treatment time	30 seconds – 30 minutes, 30 seconds step (manual adjustment is possible by "holding" the time field by means of a pen / finger – in increments of 1 s, Figure 8.1)
P	Power	Non-adjustable parameter, the result of power density and effective radiating area.
		6 W Temporal maximum output power in pulse mode
A_{ER}	Effective radiating area	3 cm ²
LIPUS	LIPUS mode	<ul style="list-style-type: none"> • YES – active • NO – disabled

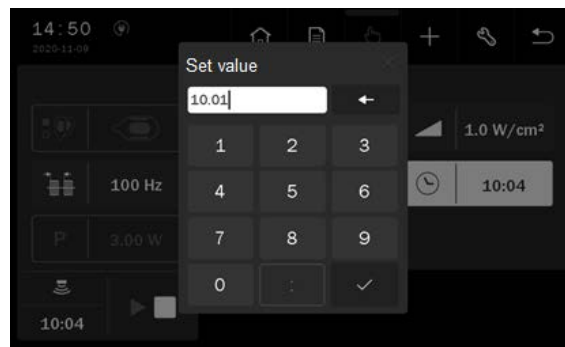









Figure 8.1. Manual time setting







8.3 SnG head – dual-transducer mode

Parameters description:

Symbol	Description	Available parameters
	Operating mode	 Non-adjustable parameter, two transducers active
	Acoustic working frequency	Available settings: <ul style="list-style-type: none"> • 1 MHz • 3 MHz • 1/3 MHz – switching frequency every 8 seconds
	Amplitude	Setting – temporal power density [W/cm ²]: <ul style="list-style-type: none"> • 0.1 – 3 W/cm² Regulation step: <ul style="list-style-type: none"> • 0.1 W/cm² <p>The transducer is switched every 1 second. Emission control cycle of single ultrasonic wave transducer:</p> <ul style="list-style-type: none"> • increase of power – 0.25s • phase of full emission – 0.5s • decrease of power – 0.25s
	Pulse operation frequency	Available settings: <ul style="list-style-type: none"> • 10 Hz – 150 Hz, variable step
	Pulse operation duty factor	Available settings: <ul style="list-style-type: none"> • 10-60%, 0.5s-0.5s cycle (rise-fall) • 20-80%, 0.5s-0.5s cycle (rise-fall) • 50-80%, 0.5s-0.5s cycle (rise-fall) • 80-100%, 0.5s-0.5s cycle (rise-fall)
	Treatment time	30 seconds – 30 minutes, 30 seconds step (manual adjustment is possible by "holding" the time field by means of a pen / finger – in increments of 1 s, Figure 8.1)
P	Power	Non-adjustable parameter, the result of power density and effective radiating area. 9 W Temporal maximum output power in pulse mode
A_{ER}	Effective radiating area	3 cm ² for every transducer

8.4 SnG head – quadruple-transducer mode

Parameters description:

Symbol	Description	Available parameters
	Operating mode	 Non-adjustable parameter, four transducers active
	Acoustic working frequency	Available settings: <ul style="list-style-type: none"> • 1 MHz • 3 MHz • 1/3 MHz – switching frequency every 8 seconds
	Amplitude	Setting – power density [W/cm ²]: <ul style="list-style-type: none"> • 0.1 – 3 W/cm² – continuous mode Regulation step: <ul style="list-style-type: none"> • 0.1 W/cm² <p>The transducer is switched every 1 second. Emission control cycle of single ultrasonic wave transducer:</p> <ul style="list-style-type: none"> • increase of power – 0.25s • phase of full emission – 0.5s • decrease of power – 0.25s
	Pulse operation frequency	Available settings: <ul style="list-style-type: none"> • 10 Hz – 150 Hz, variable step
	Pulse operation duty factor	Available settings: <ul style="list-style-type: none"> • 10-60%, 0.5s-0.5s cycle (rise-fall) • 20-80%, 0.5s-0.5s cycle (rise-fall) • 50-80%, 0.5s-0.5s cycle (rise-fall) • 80-100%, 0.5s-0.5s cycle (rise-fall)
	Treatment time	30 seconds – 30 minutes, 30 seconds step (manual adjustment is possible by "holding" the time field by means of a pen / finger – in increments of 1 s, Figure 8.1)
P	Power	Non-adjustable parameter, the result of power density and effective radiating area. 9 W Temporal maximum output power in pulse mode
A_{ER}	Effective radiating area	3 cm ² for every transducer

8.5 Characteristics of pulse parameters

The pulse durations depending on the set frequency and duty factor are presented in Table 8-1. For the LIPUS mode, the parameter is non-adjustable – for the frequency of 1 kHz it is 1 ms. In pulse mode, the output power is equal to the product of the duty factor and the set power.

Parameter description:

- DF – duty factor, percentage and division value,
- prp [ms] – pulse repetition period (inverse of frequency),
- pd [ms] – pulse duration.

Table 8-1. Pulse duration depending on the duty factor and pulse repetition period (GU-5, GU-1)

	prp	DF	5%	10%	15%	20%	25%	30%	35%	40%	45%	50%	55%	60%	65%	70%	75%
			1:20	1:10	1:6.67	1:5	1:4	1:3.33	1:2.86	1:2.5	1:2.22	1:2	1:1.82	1:1.66	1:1.54	1:1.43	1:1.33
			pd [ms]														
10 Hz	100 ms		5.00	10.00	15.00	20.00	25.00	30.00	35.00	40.00	45.00	50.00	55.00	60.00	65.00	70.00	75.00
16 Hz	62.5 ms		3.13	6.25	9.38	12.50	15.63	18.75	21.88	25.00	28.13	31.25	34.38	37.50	40.63	43.75	46.88
20 Hz	50 ms		2.50	5.00	7.50	10.00	12.50	15.00	17.50	20.00	22.50	25.00	27.50	30.00	32.50	35.00	37.50
30 Hz	33.3 ms		1.67	3.33	5.00	6.66	8.33	9.99	11.66	13.32	14.99	16.65	18.32	19.98	21.65	23.31	24.98
40 Hz	25 ms		1.25	2.50	3.75	5.00	6.25	7.50	8.75	10.00	11.25	12.50	13.75	15.00	16.25	17.50	18.75
48 Hz	20.8 ms		1.04	2.08	3.12	4.16	5.20	6.24	7.28	8.32	9.36	10.40	11.44	12.48	13.52	14.56	15.60
50 Hz	20 ms		1.00	2.00	3.00	4.00	5.00	6.00	7.00	8.00	9.00	10.00	11.00	12.00	13.00	14.00	15.00
60 Hz	16.7 ms		0.84	1.67	2.51	3.34	4.18	5.01	5.85	6.68	7.52	8.35	9.19	10.02	10.86	11.69	12.53
70 Hz	14.3 ms		0.72	1.43	2.15	2.86	3.58	4.29	5.01	5.72	6.44	7.15	7.87	8.58	9.30	10.01	10.73
80 Hz	12.5 ms		0.63	1.25	1.88	2.50	3.13	3.75	4.38	5.00	5.63	6.25	6.88	7.50	8.13	8.75	9.38
90 Hz	11.1 ms		0.56	1.11	1.67	2.22	2.78	3.33	3.89	4.44	5.00	5.55	6.11	6.66	7.22	7.77	8.33
100 Hz	10 ms		0.50	1.00	1.50	2.00	2.50	3.00	4.00	4.00	4.50	5.00	5.50	6.00	6.50	7.00	7.50
110 Hz	9.1 ms		0.46	0.91	1.37	1.82	2.28	2.73	3.19	3.64	4.10	4.55	5.01	5.46	5.92	6.37	6.83
120 Hz	8.3 ms		0.42	0.83	1.25	1.66	2.08	2.49	2.91	3.32	3.74	4.15	4.57	4.98	5.40	5.81	6.23
130 Hz	7.7 ms		0.39	0.77	1.16	1.54	1.93	2.31	2.70	3.08	3.47	3.85	4.24	4.62	5.01	5.39	5.78
140 Hz	7.1 ms		0.36	0.71	1.07	1.42	1.78	2.13	2.84	2.84	3.20	3.55	3.91	4.26	4.62	4.97	5.33
150 Hz	6.7 ms		0.34	0.67	1.01	1.34	1.68	2.01	2.68	2.68	3.02	3.35	3.69	4.02	4.36	4.69	5.03

9. Indications and contraindications

9.1 Indications

9.1.1 Standard and SnG heads therapy

- analgesic effect e.g. in the course of degenerative diseases of the spine and peripheral joints, sciatic and femoral neuralgias, painful shoulder syndrome, muscle pains (myalgia)
- chronic inflammations incl. degenerative diseases of the spine and peripheral joints, rheumatoid arthritis
- contractures of connective tissue (joint capsule, tendons, muscles, skin surface)
- normalization/acceleration of tissues healing and regeneration processes – muscles, tendons, ligaments, wounds e.g. ulcerations, bedsores
- improvement of circulation
- muscles strains and calcification
- tendons strains and calcification (e.g. tennis elbow, golfer's elbow)
- neuropathy, e.g. compression of the median nerve (only in a non-thermal dose)
- sympathetic system disorders such as reflex sympathetic dystrophy
- medicine application (phonophoresis)
- combined therapy

9.1.2 LIPUS therapy

- fractures (of tibia, fibula, carpal bones)
- delayed bone union
- stress fractures
- degeneration disease and intervertebral disc herniation



9.2 Contraindications

- tumor and state after tumor resection
- areas subjected to radiotherapy in the last few months
- gestation (abdomen and lower part of the spine area)
- active tuberculosis
- haemorrhagic condition
- circulatory failure and arrhythmia
- severe general condition and cachexy
- septic inflammation
- unfinished bone growth in the area of metaphyseal growth cartilage
- neuralgias of unknown etiology
- acute inflammatory process and fever
- diabetes (decrease of glucose in blood)
- thrombophlebitis and varicose veins
- implanted electronic devices (e.g. pacemaker)
- peripheral circulation disorders
- sensory disturbance
- neuropathy (thermal dose)
- intervertebral disc prolapse
- conditions after laminectomy, spina bifida, hernia of the intervertebral disc
- precautions should be taken for implants and endoprotheses (metal, plastic and cement)
- skin conditions and wounds
- peripheral nerves damage

Therapy limitations:

- ultrasound must not be applied above the third cervical vertebrae
- avoid application in the area of heart, brain, eyes, facial sinuses, gonads, thyroid and lymph nodes (especially cervical), chest, over the parenchymal organs
- avoid application over bone structures and nerves just below the skin surface

10. Maintenance, cleaning, disinfection



NOTE: The warranty does not cover any damage due to a failure to adhere to the recommendations stated in this chapter.



NOTE: Before attempting to perform following operations isolate the unit, switch mode power supply and mains filter from the mains supply!

The activities of maintenance, cleaning and disinfection of device components should be realized at:

- ambient temperature between +15°C to +30°C,
- relative humidity between 30% to 75%,
- atmospheric pressure between 700 hPa and 1060 hPa (70 – 106 kPa).

These conditions are identical to those defined in chapter 4.2 as operation conditions.

There are no limitations for the number of cleaning and disinfection cycles, procedures should be carried out during the entire device “life time”.

10.1 Cleaning of the unit, switch mode power supply and mains filter casing



NOTE: Before attempting to perform following operations isolate the unit, switch mode power supply and mains filter from the mains supply!

Cleaning of the unit, switch mode power supply, mains filter and cables shall be performed with lightly humid sponge or soft cloth with delicate soap solution or mild detergent. It is recommended to use a microfiber cloth, preferably designated for cleaning mirrors or electronic equipment.



Do not use solvents for paints and lacquers. Do not use excessively dampened sponges either, which can lead to water penetration inside the unit.

Then all cleaned cables shall be wiped with dry cloth and left for complete drying.

Do not connect wet or moist leads!

Do not disinfect or sterilize unit, switch mode power supply and mains filter casing. Disinfection of accessories, which are not intended for contact with patient’s body (for example cables), shall be carried out with liquid or spray agents dedicated to that purpose at least once a week.

10.2 Cleaning of touchscreen

To clean the touchscreen, we recommend to use a cloth which is included in the unit's standard accessory, or other made of microfiber, preferably designated for cleaning mirrors or electronic equipment.

The manufacturer recommends to clean regularly the touchscreen display. Gently moisten the cloth with clean water. The cloth should be drained so that there is no dripping water. The screen should be wiped until removal of all dirt and dust.

The manufacturer does not recommend to use any product designated for cleaning screens, because there is no guarantee that the chemicals will not lead to faster wear out of touchscreen layers.

10.3 Cleaning and disinfection of the ultrasound heads



Ultrasound heads shall be cleaned with water and gentle soap or mild detergent, and then wiped with dry cloth and left for complete drying. Ultrasound heads shall be thoroughly cleaned after each treatment session.

Ultrasound heads (especially their head fronts) shall be disinfected after each treatment session. To disinfect it is recommended to use 70 % alcohol solution. After disinfection, accessories must be washed (clean, not hot water) to avoid allergic reaction.

For the SnG head, it is possible to remove the plastic cover from the front side to thoroughly clean the applicator.

10.4 Special messages

In case of an error occurrence, messages that facilitate error handling are displayed in the edition field. There can also be shown a window that informs user about the need to contact the technical support. By using the visible setup control, it is possible to display the unit logs, in order to pass them to the technical staff (see 6.3.6.4.).

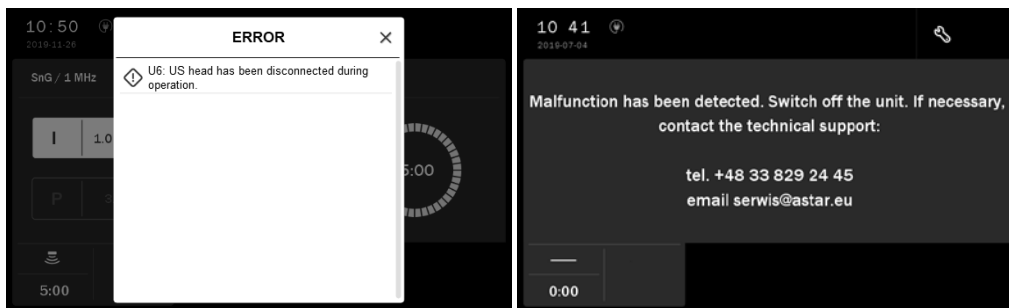

Figure 10.1. The unit error signaling and information visible after closing of the error message

Table 10-1. Signaling special messages

Type of message	Symbol
Errors	
General information	
Warnings	

10.5 Self-test procedure

Each time the PhysioGo.Lite Sono unit is started, a special self-test procedure is performed during which all modules and functional blocks of the device are tested. If any errors or damage are detected, the relevant information will be presented on the display screen. The module where the irregularity has been detected is blocked and the associated function is not available.

If any mistakes of the hardware nature are detected, the unit will not start. An acoustic signal reminiscent of "tapping" will be emitted. The number of signals ("taps") generated is adequate to the number of the error (see Table 10-2 of error codes). For example, if seven signals are emitted (followed by a short break), this means that the keyboard is damaged or one of the keys is locked.



In this situation, you must disconnect the unit from the mains and contact an authorized service for inspection and a possible repair.

Table 10-2. The "hardware" error coding system

Error code	Error description
12	SDRAM self-test error
13	No communication with the SD card
14	No communication with the TSC controller in the LCD
15	Program defect in the processor FLASH memory (CRC)
17	The keyboard is damaged or a button is pressed (a button short-circuit)
18	Main processor oscillator error

10.6 Troubleshooting

Table 10-3.

Symptoms	Undertaking action
The unit does not respond to mains supply	Check fuse. If it is blown, replace it in accordance with indications in point 10.7. Try to connect different mains cable. If the problem persists, contact your authorized service.
The unit does not start. Acoustic sounds can be heard	Turn off and on the device. If the problem persists or occurs frequently, determine the type of error based on chapter 10.5 and contact your authorized service.
Unit Error indication – symbol  in the status field or channel tab	Turn off and on the device. If the problem persists or frequently occurs, note down the error number and contact your authorized service.
Ultrasound head error indication	Switch the unit off. Disconnect the accessory. Connect it once again and switch on the mains supply. If the problem persists or frequently occurs, note down the error number and contact your authorized service. If you have another head, connect it in and check if the problem persists.
The unit does not respond when you press keys	Turn off and on the device. If the problem persists or frequently occurs, contact your authorized service.
The touch panel is too sensitive or does not respond to touch	Calibrate the display. To carry out calibration, press the   keys simultaneously during system start-up. The unit then activates the display calibration mode. Follow the messages on the screen. First, touch three points, then validate the correctness of operation by touching five points on the screen.
The touch panel reacts in a different spot from where it was touched	
Message “A problem in touch panel operation has been detected.”	If the problem occurred once, it means the touch panel was touched while system start-up. Do not touch the screen during the system start-up. If the problem occurs after each system start-up, contact your authorized service.
Incomprehensible messages	Switch on the unit. Enter the setup mode. Select an appropriate language version.
Unclear display	Switch on the unit. Enter the setup mode. Adjust brightness.
Lack of buzzer signals	Switch on the unit. Enter the setup mode. Check the configuration of buzzer volume.
Too silent buzzer volume	Switch on the unit. Enter the setup mode. Set an appropriate buzzer volume.
Message – no ultrasound head contact – appears frequently	Switch on the unit. Enter the setup mode. Modify the US head sensitivity, following point 6.3.4.4. If the problem repeats, contact your service.

Symptoms	Undertaking action
Ultrasound head does not detect the lack of contact.	Switch on the unit. Enter the setup mode. Perform the US head calibration procedure, according to point 6.3.5.3. If the problem repeats, contact your service.
Unit equipped with battery module – the device does not respond to mains supply	Connect the mains supply. The battery may be discharged. To start the operation, please hold on for at least 5 seconds the STANDBY key.
The battery discharges quickly	Contact your authorized service for battery replacement. If the battery module has to be dismantled, a stabilizing cartridge should be installed. If you change the battery yourself, follow the information included in 5.3.
Date and time settings cancel	If I16 error is shown on the display, it means that the backup battery is discharged. Its exchange should be directed to an authorized service. Type of memory backup battery is a CR2032.



10.7 Fuse replacement

NOTE:

Before proceeding to the further described operations isolate the unit and switch mode power supply from the mains supply!

In case of burnt the fuse, it must be replaced. Fuse parameters are given in chapter **“Specification and accessories”** and on the name plate.

To replace the fuse:

Step	Description
1.	Switch the power switch to the "0" position.
2.	Disconnect the mains cable from the mains socket. Disconnect the power supply cable from the device socket marked with symbol  .
3.	With flat screwdriver unscrew the fuse socket until the moment of its slipping from the socket.
4.	Remove the socket with your fingers, replace the fuse, install them in the socket again and screw firmly.
5.	Connect the power supply cord to the device socket. Then connect the mains cable to the mains socket.
6.	Switch the power switch on and start the device. Check the device operation.

11. Specification and accessories

11.1 Technical data

Classifications:

Medical device class:	Ila
Classification rule: (according to MDD 93/42 / EEC and REGULATION (EU) 2017/745 OF THE EUROPEAN PARLIAMENT AND OF THE COUNCIL of 5 April 2017)	9
Electrical safety class:	II
Applied part type:	BF
Degree of protection provided by unit enclosure:	IP20
Degree of protection provided by ultrasound head enclosure:	IPX7

Mode of operation:

The unit is intended for continuous operation.

Treatment parameters:

Described in chapter 8

Accuracy of parameters:

Output power / power density:	± 20%
Pulses frequency:	± 20%
Duty factor:	± 20%
Effective radiating area:	± 20%

Treatment programs:

Pre-defined treatment programs for GU-1 head:	7
Pre-defined treatment programs for GU-5 head:	52
Pre-defined treatment programs for SnG head (single-transducer mode):	4
Pre-defined treatment programs for SnG head (dual-transducer mode):	69
Pre-defined treatment programs for SnG head (quadruple-transducer mode):	24
Total	156

User-defined programs:

50 (for every applicator)

Treatment timer:

Ranges and resolutions:	defined in chapter 8
Time accuracy:	±10%

General:

Mains supply:	100-240 V; 50/60 Hz
PhysioGo.Lite Sono controller supply	24VDC; 2,5A
Mains fuses:	size 5x20mm; T3,15L250V; 3,15 A; 250 V
Type of memory backup battery:	CR2032
Unit weight:	max. 3 kg
Ultrasound head weight:	max. 0,5 kg
Unit dimensions (WxDxH)	25x27x16,5cm

Switched Mode Power Sup Sinpro, model HPU63B-108:

Mains supply – input:	100-240 VAC; 1,62-0,72A; 47-63 Hz
Output:	24VDC; 2,62A max
Weight:	0,38 kg max
Power supply dimensions (WxDxH)	13,2x5,6x3,7 cm

Switched Mode Power Supply Mean Well, model GSM60B24-P1J:

Mains supply – input:	100-240 VAC; 1,4-0,7A; 50/60 Hz
Output:	24VDC; 2,5A max
Weight:	0,35 kg max
Power supply dimensions (WxDxH)	12,5x5x3,15 cm

Battery:

Type:	Li-Ion
Voltage:	18 V
Capacity:	2,1 Ah
Charging time:	max. 6,5 h
Durability:	> 700 cycles
Weight:	0,45 kg max
Dimensions (WxDxH):	15x8x3,3 cm

Storage conditions:

Temperature range:	+5÷+45°C
Relative humidity:	30÷75%
Pressure range:	700÷1060 hPa (70 – 106 kPa)

Operation conditions:

Temperature range:	+15÷+30°C
Relative humidity:	30÷75%
Pressure range:	700÷1060 hPa (70 – 106 kPa)

Transport conditions:

Temperature range:	-10÷+45°C
Relative humidity:	20÷95%
Pressure range:	700÷1060 hPa (70 – 106 kPa)

11.2 EMC parameters

In compliance with IEC 60601-1-2:2014

Guidance and manufacturer's declaration – electromagnetic emissions

Emission test	Compliance
RF emissions CISPR 11	Group 1
RF emissions CISPR 11	Class B
Harmonic emissions IEC 61000-3-2	Class A
Voltage fluctuations / Flicker emissions IEC 61000-3-3	Complies

Guidance and manufacturer's declaration – electromagnetic immunity

Immunity test	IEC60601 test level	Compliance level
Electrostatic discharge (ESD) IEC 61000-4-2	±8 kV contact ±2, ±4, ±8, ±15 kV air	±8 kV contact ±2, ±4, ±8, ±15 kV air

Recommendation: Floor should be made of wood, concrete or ceramic tile. If floors are covered with synthetic material, the relative humidity should be at least 30%.

Immunity test	IEC60601 test level	Compliance level
Radiated RF IEC 61000-4-3	10 V/m 80MHz do 2,7 GHz	10 V/m

Field strengths from fixed transmitters, such as base stations for radio (cellular / cordless) telephones and land mobile radios, amateur radio, AM and FM radio broadcast and TV broadcast cannot be predicted theoretically with accuracy. To assess the electromagnetic environment due to fixed RF transmitters, an electromagnetic site survey should be considered. If the measured field strength in the location in which the PhysioGo.Lite Sono unit is used exceeds the applicable RF compliance level above, the unit should be observed to verify normal operation. If abnormal performance is observed, additional measures may be necessary, such as re-orienting or relocating the PhysioGo.Lite Sono unit.

Applied compliance level is suitable for home healthcare environment. It means the device may be connected to the public low-voltage power supply network.

Immunity test	IEC60601 test level	Compliance level
Electric fast transient / burst IEC 61000-4-4	±2 kV	±2 kV

Immunity test	IEC60601 test level	Compliance level
Surges IEC 61000-4-5	±1 kV line-to-line	±1 kV line-to-line

Immunity test	IEC60601 test level	Compliance level
Conducted RF IEC 61000-4-6	3 Vrms 150 kHz to 80 MHz 6 Vrms in ISM and amateur radio bands between 150 kHz – 80 MHz	3 Vrms 150 kHz to 80 MHz 6 Vrms in ISM and amateur radio bands between 150 kHz – 80 MHz

Field strengths from fixed transmitters, such as base stations for radio (cellular / cordless) telephones and land mobile radios, amateur radio, AM and FM radio broadcast and TV broadcast cannot be predicted theoretically with accuracy. To assess the electromagnetic environment due to fixed RF transmitters, an electromagnetic site survey should be considered. If the measured field strength in the location in which the PhysioGo.Lite Sono unit is used exceeds the applicable RF compliance level above, the unit should be observed to verify normal operation. If abnormal performance is observed, additional measures may be necessary, such as re-orienting or relocating the PhysioGo.Lite Sono unit.

Applied compliance level is suitable for home healthcare environment. It means the device may be connected to the public low-voltage power supply network.

Immunity test	IEC60601 test level	Compliance level
Magnetic field power frequency (50 and 60 Hz) IEC 61000-4-8	30 A/m	30 A/m

Immunity test	IEC60601 test level	Compliance level
Voltage dips IEC 61000-4-11	0% U_T 0,5 cycle, phase angles of synchronization with AC power supply voltage 0°, 45°, 90°, 135°, 180°, 225°, 270°, 315°	Complies
	0% U_T 1 cycle, phase angle of synchronization with AC power supply voltage 0°	Complies
	70% U_T 25 cycles for 50 Hz 30 cycles for 60 Hz phase angle of synchronization with AC power supply voltage 0°	Complies
Voltage interruptions IEC 61000-4-11	0% U_T 250 cycles for 50 Hz 300 cycles for 60 Hz	Complies

Immunity test	Compliance level
Proximity fields from RF wireless communications equipment according to 8.10 IEC 60601-1-2:2014	Complies

11.3 Standard accessories

No.	Name	REF	Quantity
1.	PhysioGo.Lite Sono controller	A-UL-AST-PLS	1
2.	Switch mode power supply – type HPU63B-108 by Sinpro or GSM60B24-P1J by Mean Well	-	1
3.	Mains cable with filter	-	1
4.	USG gel	H-AS-CEM-ZEL500G	1
5.	Spare fuse – time lag T3,15L250V	-	1
6.	Pen for a resistive touch screen	-	1
7.	LCD touch screen cloth	-	1
8.	Masking covers with cutout	-	2
9.	M3x16DK screw	-	8
10.	User Guide	-	1
11.	Electrical safety test report	-	1

11.4 Optional accessories

Name	REF
GU-1 head	A-AS-AST-GU1
GU-5 head	A-AS-AST-GU5
SnG head	A-AS-AST-SNG
Standard ultrasound head holder	A-AS-AST-SMSPUCH
SnG head holder	-
Battery	A-AW-AST-LITEAQ
Versa trolley	A-AM-AST-VSA
Versa X trolley	A-AM-AST-VSX
Name	
Phillips screwdriver	Bag for the unit and accessories









12. Appendix A. Symbol description





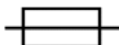









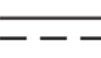
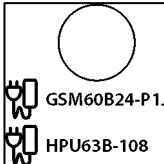

Recommendation for the operator's position to ensure the legibility of markings and information on the controller and accessory labels:

- visual distance – shall be 30 cm due to the applied technologies,
- lighting – 500 lx, which corresponds to normal room lighting conditions.

12.1 Controller, heads, mains filter, packaging

Symbol	Definition
	Caution, see the ACCOMPANYING DOCUMENTATION, symbol ISO 7000-0434A
	Class II equipment, symbol IEC 60417-5172
	BF type equipment, symbol IEC 60417-5333
	Date of production: year, symbol ISO 7000-2497
	Manufacturer, symbol ISO 7000-3082
IP20	Degree of protection provided by enclosures (IP code), based on IEC 60529
	Fuse, symbol IEC 60417-5016
VER	Unit version
	Serial number, symbol ISO 7000-2498
	Batch code, symbol ISO 7000-2492
	Catalogue number, symbol ISO 7000-2493
	Medical device, symbol 5.7.7. of ISO 15223-1:2020 standard

Symbol	Definition
	Unique Device Identifier, symbol 5.7.10. of ISO 15223-1:2020 standard
	Disposal of used devices together with other waste is prohibited, complied with the requirements of WEEE
	General symbol for recovery/recyclable, symbol ISO 7000-1135
	Operator's manual; operating instructions, symbol ISO7000-1641
	Switch mode power supply socket, direct current, symbol IEC 60417-5031
	Switched-mode power supplies identification
	Follow operating instructions, symbol ISO 7010-M002 Background color: blue
	Sitting prohibited, symbol ISO 7010-P018 Background color: white Circular band and slash: red Symbol or text: black
	Stepping prohibited, symbol ISO 7010-P019 Background color: white Circular band and slash: red Symbol or text: black
	Pushing prohibited, symbol ISO 7010-P017 Background color: white Circular band and slash: red Symbol or text: black
	Do not disassemble Background color: white Circular band and slash: red Symbol or text: black
	Keep for further use
	Non-ionizing electromagnetic radiation, symbol IEC 60417-5140 Indication of equipment in the medical electrical area that intentionally apply RF electromagnetic energy for diagnosis or treatment.
	Weight
	Packaging size





Symbol	Definition
	Temperature limit, symbol ISO 7000-0632
	Keep away from rain, symbol ISO 7000-0626
	Fragile; handle with care, symbol ISO 7000-0621
	This way up, symbol ISO 7000-0623
	The marking of conformity with legal regulations for medical devices applicable in the European Union along with the number of the Notified Body taking part in the conformity assessment.

















Table of ultrasonic parameters of unit:



Symbol	Explanation
F_{awf}	Acoustic working frequency
Cont	Continuous mode (continuous emission)
Pulsed	Pulse mode (pulse emission) of standard heads
SnG	Pulse mode (pulse emission) of SnG head
DF	Duty factor of standard heads
DF_{SnG}	Duty factor of SnG head
prp	Pulse repetition period
prp_{LIPUS}	Pulse repetition period in LIPUS mode
pr_{SnG}	Duration of frequency rise in SnG head pulse mode
pf_{SnG}	Duration of frequency fall in SnG head pulse mode
pi	Duration of frequency stabilization in SnG head pulse mode
pd	Pulse duration

Ultrasound head nameplate symbols:

Symbol	Explanation
f_{awf}	Acoustic working frequency
Beam type	Type of the head (coll. – collimated)
RBN / BNR (max)	Beam non-uniformity ratio
Rated output power	-
AER	Effective radiating area
Head size / Total appl. area	Total contact area (head front)
IPX7	Degree of protection provided by enclosure

12.2 Switched-mode power supplies – casing

Symbol	Description	SMPS type
	TUV Rheinland conformity mark (the table lists the standards for which compliance has been demonstrated, the ID means the notified body's report number).	all
	Marking of compliance with the requirements of legal regulations in force in the European Union.	all
	UL+CU conformity mark (USA, Canada). The alphanumeric string represents the approved UL report number.	all
	Federal Communications Commission EMC compliance mark (USA)	HPU150B-108 (Sinpro)
	The Eurasian Conformity mark – conformity to all technical regulations of the Eurasian Customs Union.	GSM60B24-P1J (Mean Well)
	Caution, symbol ISO 7000-0434A	GSM60B24-P1J (Mean Well)
	Dangerous voltage, symbol IEC 60417-5036	GSM60B24-P1J (Mean Well)
	For indoor use only, symbol IEC 60417-5957	all
	Class II equipment, symbol IEC 60417-5172	all
	Compliance with the RoHS directive SJ/T 11364-2014 (China). The number indicates the service life of an environmentally friendly electric and electronic product.	GSM60B24-P1J (Mean Well)
	Disposal of used devices together with other waste is prohibited, complied with the requirements of WEEE	all
	Upper limit of temperature, symbol ISO 7000-0533	GSM160B24-R7B1 (Mean Well)
	Energy efficiency level	GSM60B24-P1J (Mean Well)
	Energy efficiency level	HPU63B-108 (Sinpro)
	Do not disassembly	GSM160B24-R7B1 (Mean Well)
	Voltage polarity in the output plug	all

Symbol	Description	SMPS type
	Direct current (DC), symbol IEC 60417-5031	all
	Alternating current (AC), symbol IEC 60417-5032	HPU63B-108 (Sinpro)
IP22	Degree of protection provided by enclosures (IP code), based on IEC 60529	GSM60B24-P1J (Mean Well)