



Member of REINSBERG® GROUP

**You save lives,
we take care of the rest.**

PR-01.5

Accessories
for operating tables



FAMED

Żywiec

Member of **REINSBERG® GROUP**

Famed Żywiec is a leading European manufacturer of high-end medical equipment. For more than 75 years we have been supplying medical institutions with thousands of units of the highest quality operating tables, hospital and delivery beds or examination chairs. Our products are used by doctors in Poland and in over 120 countries around the world.

We are distinguished by our qualified staff, wide product portfolio, modern machinery and unique technological solutions used in production. We were one of the first companies in the world to introduce carbon in the production of operating tables. We also offer the world's safest medical imaging table.

Our mission is to make the work of medical staff easier and to increase patient comfort during their hospital stay. Innovative designs and a commitment to the reliability of our products directly contribute to improving the quality of medical care in Poland and around the world.

BASIC
ACCESSORIES

ORTHOPAEDICS
AND TRAUMATOLOGY

GYNAECOLOGY, UROLOGY
PROCTOLOGY, LITHOTOMY

NEUROLOGY
MINIMALLY INVASIVE SURGERY

POSITIONING OF THE
HEAD

POSITIONING OF THE
UPPER LIMB

POSITIONING OF THE
LOWER LIMB

GEL AND FOAM
POSITIONERS

1

2

3

4

5

6

7

8

Famed Żywiec OPERATING TABLE

The operating table is the most important equipment in any operating theatre. Its functionality, reliability, stability, durability, and versatility in various fields of surgery help medical staff save the lives and health of patients. At Famed Żywiec, we have been manufacturing operating tables since 1964, implementing innovative solutions that facilitate the work of the surgical team. Our product range includes tables for medical imaging, general and precision surgery, as well as simple surgical and treatment tables. Famed Żywiec operating tables, combined with the appropriate accessories, create solutions that are ideal for most medical procedures.

UNIQUE FEATURES of Famed operating tables

Fully translucent tabletop for better co-operation with C-arm.

Solutions tailored for precision surgery* allow precise management of the table top and column settings with an accuracy of 0.5 mm / 0.1°.

Possibility of changing the headrest with footrests and changing the characteristics of the table.

Many options to control the table: manual, from wired remote control, wireless remote control, control panel located on the column or alternative drive.

Base and column covers made of premium stainless steel or carbon fibre to shorten up the disinfection process and protect it from damage.

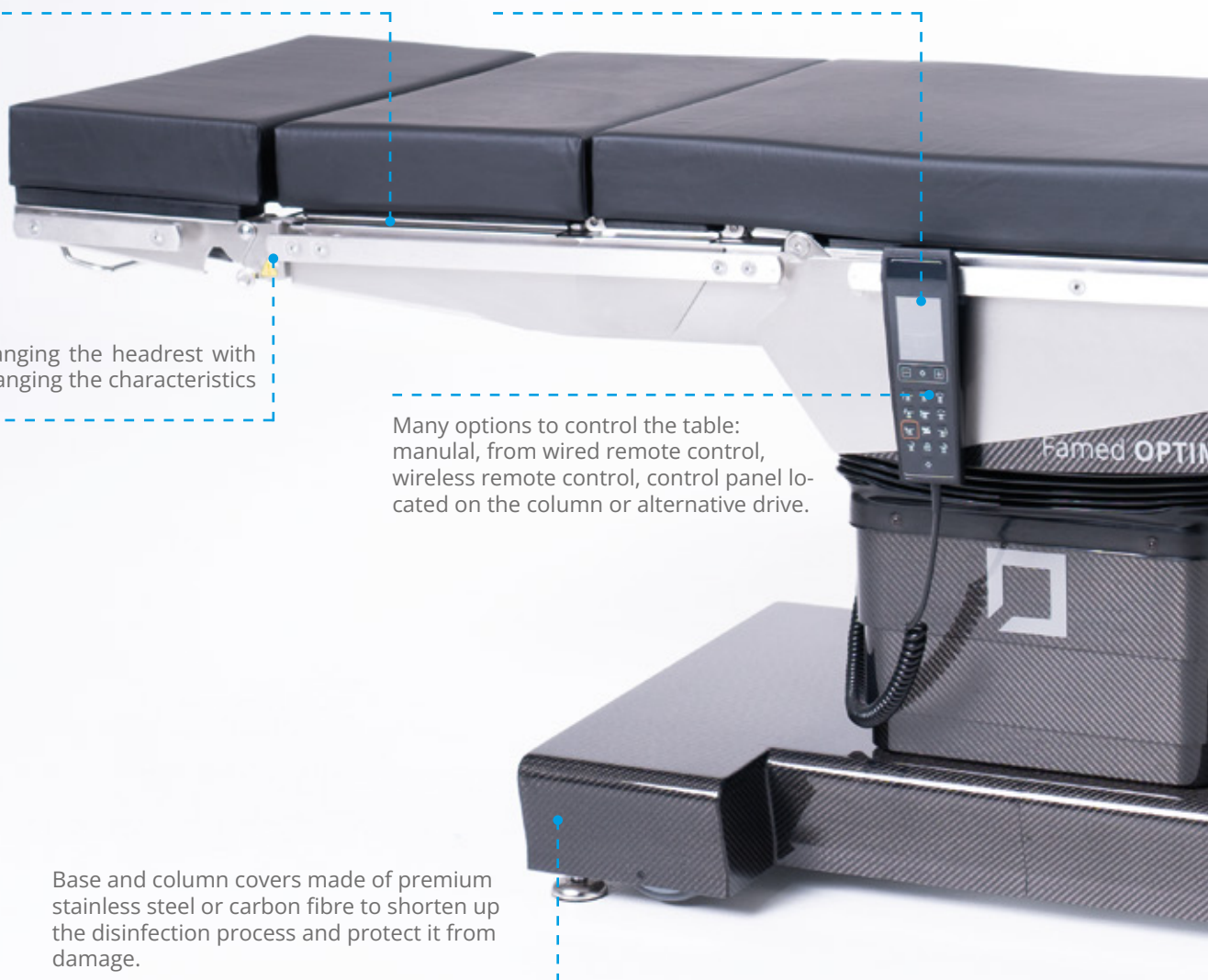

MODERN TECHNOLOGIES

used in operating tables from Famed Żywiec



InteliProtectPlus™



CarbonProtect™



fCharge™



Unique rigid wedges segments connection with 100% accessory anti-fail prevention.

Fully waterproof, anti-static pressure ulcer relief mattresses.

Side rails with protection against dropping the accessories.

Wide range of accessories to suit individual table models.

High quality stainless steel AISI 304 with **InteliProtectPlus™** technology.

Durable **fCharge™** batteries with with the battery charge indicator on the remote control*

Mobile base with central locking system available in two versions: "T" shape (slim) or "H" shape (Supermobile, with large wheels for easy maneuvering). Base available with a manual or remote lock.

The shape of the base facilitates the work of the doctor, thanks to the possibility of close approach to the table. Low profile base enable collision-free operation of a C arm.

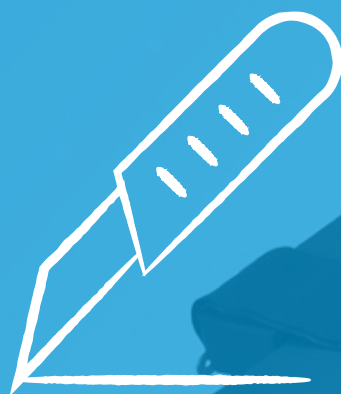

BASIC **ACCESSORIES**

Basic accessories





WS-13.5 Operating table equipment trolley

- Designed for storing and transporting operating table accessories.
- Made of electropolished stainless steel.
- It is equipped with three accessory mounting rails and a basket.
- 4 castors with brakes ensure stability and easy manoeuvrability.

base dimensions	710 x 610 mm
castor diameter	75 mm
basket dimensions	647 x 325 x 230 mm
rail length	850 mm

 FAMED ŻYWIEC ACCESSORIES



WS-13.9 Operating table equipment trolley

- Designed for storing and transporting operating table accessories.
- Made of electropolished stainless steel and HPL plastic.
- 6 dedicated equipment shelves and a steel basket in the base.
- Upper shelves contain openings for storing accessories (square and round).
- Second and third levels of shelves have cut-outs in the top for storing straps.
- 4 castors with brakes ensure stability.

base dimensions	712 x 962 mm
castor diameter	75 mm
basket dimensions	887 x 330 x 77 mm

 FAMED ŻYWIEC ACCESSORIES

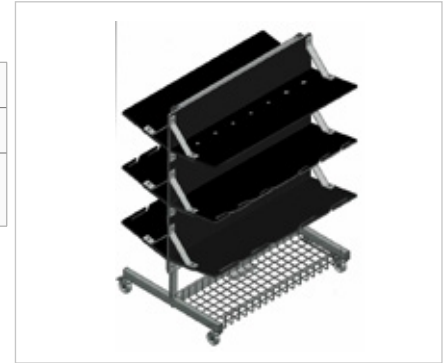

AS-08 Table top extension set

- Designed for extending the top of the operating table.
- Consists of 6 elements enabling the top to be extended by 110 mm on each side (3 per side).
- Made of electropolished stainless steel.
- HPL table top.
- Mattresses made of polyurethane foam.
- Each component has an additional accessory rail for mounting equipment.
- Compatible with all tables with accessory rails and 80 mm thick mattresses.

mattresses	250 x 110 x 80 mm
	300 x 110 x 80 mm
	350 x 110 x 80 mm
adjustment	longitudinal
assembly	accessory rail, integrated mounting adaptor

 HYPERION | OPTIMA 5.15, 5.20



AS-20 Table top extension set

- Designed for extending the top of the operating table.
- Consists of 6 elements enabling the top to be extended by 110 mm on each side (3 per side).
- Made of electropolished stainless steel.
- HPL table top.
- Mattresses made of polyurethane foam.
- Each component has an additional accessory rail for mounting equipment.

mattresses	370 x 100 x 40 mm
	330 x 100 x 40 mm
	190 x 100 x 40 mm
adjustment	longitudinal
assembly	accessory rail, integrated mounting adaptor

 OPTIMA 5.9, 5.12 | PRIME | SU-02



AS-84 Table top extension set

- Designed for extending the top of the operating table.
- Consists of 2 elements enabling the top to be extended by 100 mm on each side.
- Made of electropolished stainless steel and HPL plastic.
- Mounting to table top possible using integrated mounting adaptors.
- Mattresses made of polyurethane foam.
- Each component has an additional accessory rail for mounting equipment.

mattresses	600 x 100 x 40 mm
adjustment	longitudinal
assembly	carbon top, integrated mounting adaptor

 FLARE



AS-71 Table top for paediatric procedures

- Dedicated to paediatric patients
- Cut-outs in the tabletop provide better access for the surgeon.
- Made of electropolished stainless steel.
- X-ray transparent HPL table top.
- Additional accessory rails on the sides and an adaptor for mounting a specialised headrest with a 25 mm x 25 mm square pivot or two 25 mm circular pivots.
- Polyurethane foam mattress with a thickness of 40 or 80 mm - depending on the operating table model.
- Mounting in place of standard footrests allows changing the position using the remote control (in Famed HYPERION, Famed OPTIMA 5.15, 5.20).

dimensions	803 mm x 400/545 mm
assembly	wedges, integrated mounting adaptor
Polyurethane foam	mattress with a thickness of 40 or 80 mm

HYPERION | OPTIMA 5.9, 5.12, 5.15, 5.20 | PRIME | SU-02



AS-82 Adjustable special headrest adaptor

- Versatile design compatible with any Famed Żywiec operating table.
- Tool-free spacing adjustment.
- Suitable for use with headrests with a 25 x 25 mm square mounting pivots and two 25 mm round mounting pivots with 170 mm spacing between them.
- Made of electropolished stainless steel.

spacing adjustment	560 - 650 mm
assembly	to mounting rail, slide-on
assembly	accessory rails, integrated adaptors

HYPERION | FLARE | OPTIMA 5.9, 5.12, 5.15, 5.20 | PRIME | SU-02 | SU-14 | VIDAR



WS-16.5 Mounting adaptor

- Designed to mount equipment to the accessory rail of the operating table.
- Features a clamp that prevents the accessory adaptor from slipping off the accessory rail.
- Adjustment of the accessory is possible after locking the adaptor onto the rail.
- Mounting from the front of the accessory rail (**hook-on**).
- Suitable for use with accessories with a 16 mm diameter pivot.
- Made of electropolished stainless steel.

hole for mounting pivot	circular Ø 16 mm
assembly	to accessory rail, hook-on
lock	on the rail independently of the accessory
angle adjustment	none

OPTIMA 5.9, 5.12, 5.15, 5.20 | PRIME | SU-02



WS-16.8 Mounting adaptor

- Designed to mount equipment to the accessory rail of the operating table.
- Features a clamp that prevents the accessory adaptor from slipping off the accessory rail.
- Adjustment of the accessory is possible after locking the adaptor onto the rail.
- Mounting from the front of the accessory rail (**hook-on**).
- Suitable for use with accessories with a 18 mm diameter pivot.
- Made of electropolished stainless steel.

hole for mounting pivot	round Ø 18 mm
assembly	to accessory rail, hook-on
lock	on the rail independently of the accessory
angle adjustment	none

HYPERION





WS-17.6 Multiposition adaptor

- Designed to mount equipment to the accessory rail of the operating table.
- Mounting from the side of the accessory rail (slide-on).
- Suitable for use with accessories with a 16 and 18 mm diameter circular pivot and 16 x 16 mm square pivot.
- Made of electropolished stainless steel.

hole for mounting pivot	16 x 16 mm or Ø 16/18mm
assembly	accessory rail, slide-on
lock	adaptor and accessory with one knob
angle adjustment	yes

 FLARE | OPTIMA 5.9, 5.12, 5.15, 5.20 | PRIME | SU-02 | SU-14 | VIDAR



WS-17.8 Multiposition adaptor

- Designed to mount equipment to the accessory rail of the operating table.
- Dedicated to bariatric equipment with increased maximum safe working load (SWL)
- Features a clamp that prevents the accessory adaptor from slipping off the accessory rail.
- Adjustment of the accessory is possible after locking the adaptor onto the rail.
- Mounting from the side of the accessory rail (slide-on).
- Suitable for use with accessories with a 18 mm diameter pivot.
- Made of electropolished stainless steel.

hole for mounting pivot	circular Ø 18 mm
assembly	accessory rail, slide-on
lock	adaptor and accessory with one knob
angle adjustment	yes

 HYPERION



AS-89 Multiposition adaptor - multipurpose

- Designed to mount equipment to the accessory rail of the operating table.
- Mounting from the side of the accessory rail (hook-on).
- Easy assembly and disassembly using the handle lock release button on the rail.
- Suitable for use with accessories with a 16 and 18 mm diameter circular pivot and 16 x 16 mm square pivot.
- Made of electropolished stainless steel.

hole for mounting pivot	16 x 16 mm or Ø 16/18mm
assembly	accessory rail, slide-on
lock	adaptor and accessory with one knob
angle adjustment	yes

 HYPERION | FLARE | OPTIMA 5.9, 5.12, 5.15, 5.20 | PRIME | SU-02 | SU-14 | VIDAR

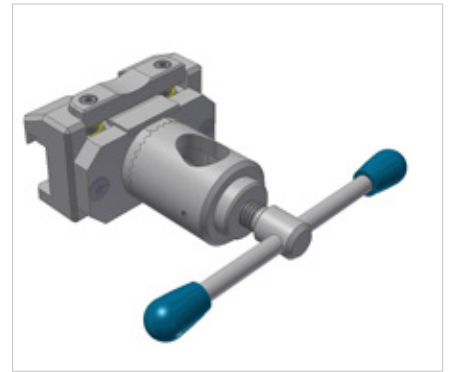

AS-83 Footrest adapter with accessory rail

- Designed for mounting accessories in place of the footrest on the OR table (after removing the footrest).
- Allows remote adjustment of accessories mounted on the adapter.
- Made of electropolished stainless steel.
- Equipped with an accessory rail for mounting additional equipment.
- Protected against accidental detachment from the mounting wedge.

Rail length	84 mm
Mounting	Wedges, integrated mounting adapter
Adjustment	Angular, remote controlled

 OPTIMA 5.15, 5.20



AS-51 X-ray tray

- Used as a stand for the x-ray cassette when taking x-rays.
- Suitable for use with the backrest section of the Famed SU-14 operating and examination table.
- Made of lacquered aluminium.
- The special-shaped electro-polished stainless steel handle ensures easy handling.

internal dimensions	500 x 464 mm
adjustment	longitudinal
assembly	under the operating table top, requires the use of mounting rails

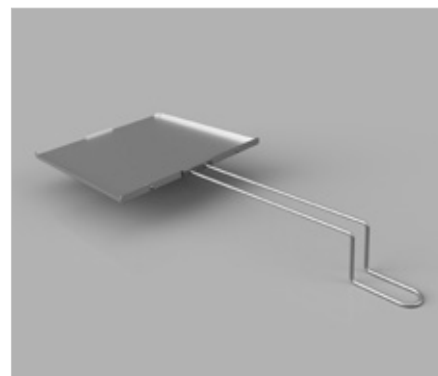

WS-11.7 X-ray tray

- Used as a stand for the x-ray cassette when taking x-rays in the seat and back section.
- Tray made of lacquered aluminium.
- The special-shaped electro-polished stainless steel handle ensures easy handling.

internal dimensions	450 x 383 mm
adjustment	longitudinal
assembly	under the operating table top, requires the use of mounting rails



WS-11.8 X-ray tray

- Used as a stand for the x-ray cassette when taking x-rays in the seat and back section.
- Tray made of lacquered aluminium.
- The special-shaped electro-polished stainless steel handle ensures easy handling.

internal dimensions	500 x 423 mm
adjustment	longitudinal
assembly	under the operating table top, requires the use of mounting rails



WS-19.7 X-ray tray

- Used as a stand for the x-ray cassette when taking x-rays in the head and back section.
- Made of lacquered aluminium.
- The special-shaped electro-polished stainless steel handle ensures easy handling.

internal dimensions	500 x 383 mm
adjustment	longitudinal
assembly	under the operating table top, requires the use of mounting rails



WS-19.8 X-ray tray

- Used as a stand for the x-ray cassette when taking x-rays in the head and back section.
- Made of lacquered aluminium.
- The special-shaped electro-polished stainless steel handle ensures easy handling.

internal dimensions	500 x 433 mm
adjustment	longitudinal
assembly	under the operating table top, requires the use of mounting rails

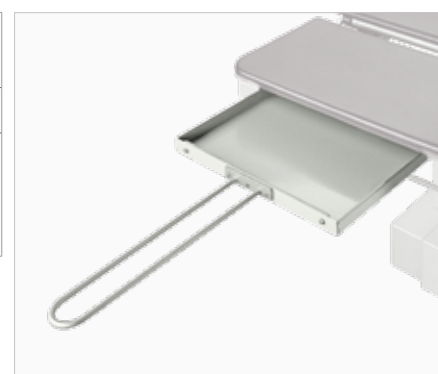



WS-33 Side holder for X-ray pictures

- Cassette holder designed for horizontal mounting.
- Made of electropolished stainless steel.
- A convenient knob keeps the tray in position and ensures stability.

pivot	circular Ø 16 mm
dimensions	365 x 165 mm
adjustment	height
assembly	accessory rail, mounting adaptor required



 HYPERION | OPTIMA 5.9, 5.12, 5.15, 5.20 | PRIME | SU-02 | SU-14 | VIDAR

KTEK 2501 Anaesthesia screen frame

- Designed for hanging the anaesthesia screen during surgery.
- Made of plastic allowing free shaping.
- Mounted on accessory rails on both sides of the operating table.
- The plastic allows for bending while maintaining adequate rigidity.

length	1,520 mm
adjustment	longitudinal, height, width
assembly	Accessory rail, 2x KTEK4810 mounting adaptor required



 FLARE | OPTIMA 5.9, 5.12, 5.15, 5.20 | PRIME | SU-02 | SU-14

KTEK4810 mounting adaptor for KTEK2501 screen frame

- Designed for mounting the KTEK4810 anaesthesia screen frame to the accessory rails of the operating tables.
- Slide-On mounting.
- Easy mounting of the frame to the adaptor with one hand.
- Includes a knob that ensures stability.

assembly	accessory rails
size	EU (25x10 mm) (other available as option)



 FLARE | OPTIMA 5.9, 5.12, 5.15, 5.20 | PRIME | SU-02 | SU-14

WS-01.5 Anaesthesia frame

- Designed for hanging the anaesthesia screen during surgery.
- Made of electropolished stainless steel.
- It consists of a support structure with a crossbar.
- Height adjustment and rotation around its axis allows to adjust the position of the frame in relation to the operating table.

height	800 mm
length of crossbar	580 mm
pivot	circular Ø 16 mm
adjustment	height, rotation around its axis
assembly	accessory rail, mounting adaptor required



 FLARE | OPTIMA 5.9, 5.12, 5.15, 5.20 | PRIME | SU-02 | SU-14 | VIDAR

WS-01.6 Adjustable anaesthesia frame

- Designed for hanging the anaesthesia screen during surgery.
- Made of electropolished stainless steel.
- Adjustable frame crossbar width from 640 - 1125 mm.
- Height adjustment and rotation around its axis allows to adjust the position of the frame in relation to the operating table.

height	695 mm
length of crossbar	640 - 1,125 mm
pivot	circular Ø 16 mm
adjustment	height, spacing and rotation around its axis
assembly	accessory rail, mounting adaptor required

FLARE | OPTIMA 5.9, 5.12, 5.15, 5.20 | PRIME | SU-02 | SU-14 | VIDAR



WS-01.7 Anaesthesia frame

- Designed for hanging the anaesthesia screen during surgery.
- Accessory with increased durability. It can be used in bariatric surgery.
- Made of electropolished stainless steel.
- It consists of a support structure with a crossbar.
- Height adjustment and rotation around its axis allows to adjust the position of the frame in relation to the operating table.

height	800 mm
length of crossbar	653 mm
pivot	circular Ø 18 mm
adjustment	height, rotation around its axis
assembly	accessory rail, mounting adaptor required

Famed HYPERION



WS-01.8 Adjustable anaesthesia frame

- Designed for hanging the anaesthesia screen during surgery.
- Accessory with increased durability. It can be used in bariatric surgery.
- Made of electropolished stainless steel.
- Adjustable frame crossbar width from 640 - 1125 mm.
- Height adjustment and rotation around its axis allows to adjust the position of the frame in relation to the operating table.

height	695 mm
length of crossbar	640 mm - 1125 mm
pivot	circular Ø 18 mm
adjustment	height, rotation around its axis
assembly	accessory rail, mounting adaptor required

Famed HYPERION



WS-14.5 Anaesthesia tube holder

- Used to support anaesthetic tubes during surgery.
- It consists of an electropolished stainless steel arm and a Plexiglas plate with cut-outs for tubes.
- Adjustment of the height and distance of the support from the edge of the table top allows the holder to be adapted to the requirements of the operation.

support size	200 x 100 mm
pivot	circular Ø 16 mm
adjustment	height and distance from the edge of the table top
assembly	accessory rail, mounting adaptor required

HYPERION | FLARE | OPTIMA 5.9, 5.12, 5.15, 5.20 | PRIME | SU-02 | SU-14 | VIDAR





WS-32.5 Side handrail

- Protects the patient from slipping off the operating table.
- Made of electropolished stainless steel.
- Set includes two **handrails** - a shorter and a longer one.
- Intuitive and quick folding.
- **Stable construction.**
- Adjustable distance between handrails

longer handrail	267 x 594 mm
shorter handrail	267 x 389 mm
adjustment	horizontal on accessory rail
assembly	accessory rail, integrated mounting adaptors

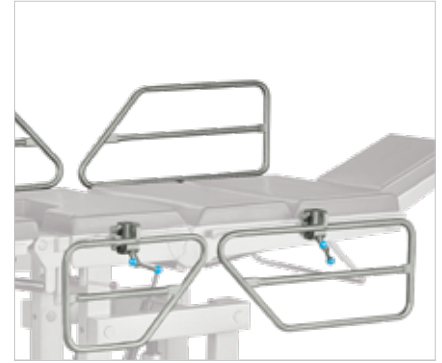

◀ OPTIMA 5.9, 5.12, 5.15, 5.20 | PRIME | SU-02 | SU-14 | VIDAR

WS-43 Hand holder

- Designed to stabilise the patient's arm over the chest.
- Made of polycaprolactam.
- Easy to clean and disinfect.
- Consists of a wide strap that wraps around the patient's arm and a mounting strap with adjustable **hook&loop**.
- Mounted to another accessory that allows the hand to be suspended over the patient's chest, e.g. WS-01.5 anaesthesia frame.

strap width	200 mm
strap length	740 mm
adjustment	strap length, height
assembly	accessory rail, other mounting accessory required



◀ HYPERION | FLARE | OPTIMA 5.9, 5.12, 5.15, 5.20 | PRIME | SU-02 | SU-14 | VIDAR

WS-92.5 Bag holder

- Designed to support the body fluid collection bags.
- It consists of a shaped arm with a crossbar ending in two hooks.
- Made of electropolished stainless steel.
- It has a safety feature that prevents it from falling out of the mounting adaptor.

length	153 mm
pivot	circular \varnothing 16 mm
adjustment	longitudinal on rail
assembly	accessory rail, mounting adaptor required



◀ HYPERION | FLARE | OPTIMA 5.9, 5.12, 5.15, 5.20 | PRIME | SU-02 | SU-14 | VIDAR

WS-53 Side rail extension

- Designed to extend the side rail in the back of the operating table from the headrest side.
- Made of electropolished stainless steel.
- Consists of rail and clamp to ensure stable installation.
- Slides onto the accessory rail from the side.
- Allows additional accessories to be fitted.

rail length	250 mm
assembly	accessory rail, integrated mounting adaptor



◀ FLARE | OPTIMA 5.9, 5.12, 5.15, 5.20 | PRIME | SU-02 | SU-14

AS-75.0 Endoscope holder on articulated arm

- Used to support endoscope cables during surgery.
- Fully adjustable thanks to three rotating elements locked by a single knob.
- Option to position the holder above the patient.
- Ends with endoscope support holder with convenient clamp.

endoscope	Ø 10 and 5 mm
arm	max. 876 mm
load	max. 10 kg
adjustment	3 rotating elements, 3D in each axis
assembly	accessory rail, integrated mounting adaptor

 HYPERION | FLARE | OPTIMA 5.9, 5.12, 5.15, 5.20 | PRIME | SU-02 | SU-14 | VIDAR | AS-67

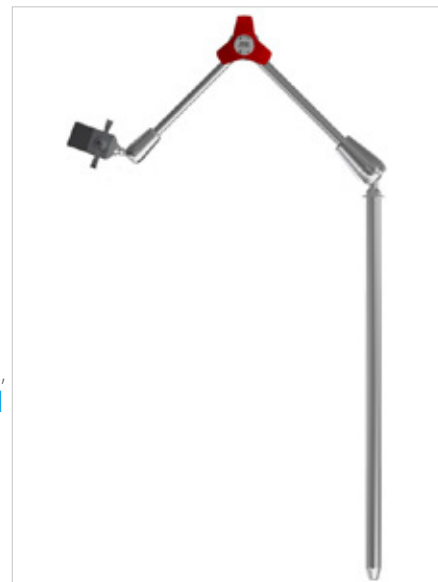

WK-01.5 Infusion stand

- Designed to support infusion fluid containers during operating procedures above the operating table.
- Made of electropolished stainless steel.
- Ends with two hooks that prevent IVs from falling out.
- Height-adjustable position of hooks over the operating table.

length	1,150 mm
distance between hooks	220 mm
pivot	circular Ø 16 mm
assembly	accessory rail, mounting adaptor required
number of hooks	2

 HYPERION | FLARE | OPTIMA 5.9, 5.12, 5.15, 5.20 | PRIME | SU-02 | SU-14 | VIDAR



WK-01.6 Infusion stand

- Designed to support infusion fluid containers during operating procedures above the operating table.
- Made of electropolished stainless steel.
- Ends with two four that prevent IVs from falling out.
- Height-adjustable position of hooks over the operating table.

length	950 mm
distance between hooks	220 mm
pivot	circular Ø 16 mm
assembly	accessory rail, mounting adaptor required
number of hooks	4

 HYPERION | FLARE | OPTIMA 5.9, 5.12, 5.15, 5.20 | PRIME | SU-02 | SU-14 | VIDAR





WS-23 Abdominal restraint strap

- Used to immobilise the patients body on the operating table at a height of the abdomen.
- No additional adaptor required for mounting - drawn through accessory rails
- Made of polycaprolactam
- Durable and easily washable material

dimensions	267 x 594 mm
adjustment	length hook & loop
assembly	to accessory rail, no additional mounting adaptor required

▶ HYPERION | FLARE | OPTIMA 5.9, 5.12 5.15, 5.20 | PRIME | SU-02 | SU-14 | VIDAR



WS-34.5 Wrist strap

- Designed to immobilise the patient's upper limbs.
- It can be used on patients placed in prone and supine positions.
- Consists of a polycaprolactam strap and bracket with electropolished stainless steel adaptor.
- It features a support plate on the outside of the belt with polyurethane foam
- Easy and quick disinfection

dimen-sions	length: 600 mm, width: 100 mm,
adjust-ment	longitudinal, strap size adjustment
assem-bly	accessory rail, integrated mounting adaptor

▶ HYPERION | FLARE | OPTIMA 5.9, 5.12 5.15, 5.20 | PRIME | SU-02 | SU-14 | VIDAR

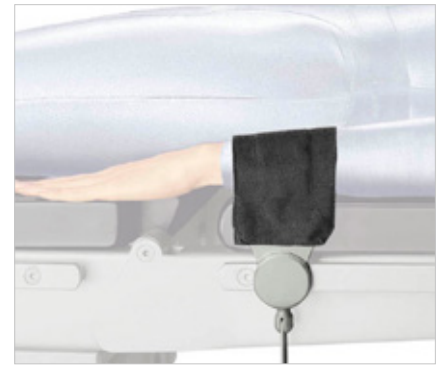

WS-41 Abdominal restraint strap

- Designed to secure the patient on the operating table.
- It can be used on patients placed in prone, supine and lateral positions.
- It consists of two polycaprolactam straps and two electropolished stainless steel adaptors.
- Size adjustment by means of a hook&loop system
- Easy and quick disinfection

dimen-sions	strap length: 750 mm, width: 100 mm
adjust-ment	longitudinal, strap size adjustment
assem-bly	accessory rail, integrated mounting adaptor

▶ FLARE | OPTIMA 5.9, 5.12, 5.15, 5.20 | PRIME | SU-02 | SU-14 | VIDAR



WS-41.5 Abdominal restraint strap

- Designed to secure the patient on the operating table.
- It can be used on patients placed in prone, supine and lateral positions.
- It consists of two polycaprolactam straps and two electropolished stainless steel adaptors.
- Size adjustment by means of a hook&loop system
- Easy and quick disinfection

dimen-sions	strap length: 950 mm, width: 100 mm
adjust-ment	longitudinal, strap adjustment
assembly	accessory rail, integrated mounting adaptor

▶ HYPERION | FLARE | OPTIMA 5.9, 5.12 5.15, 5.20 | PRIME | SU-02 | SU-14 | VIDAR



WS-41.6 Abdominal restraint strap

- Designed to secure the patient on the operating table.
- Can be fitted from the top of the rail without the need to slide on the side.
- It can be used on patients placed in prone, supine and lateral positions.
- It consists of two polycaprolactam straps and two electropolished stainless steel adaptors.
- Size adjustment by means of a hook&loop system.
- Easy and quick disinfection.

dimen-sions	950 mm x 100 mm
adjust-ment	longitudinal, strap size adjustment
assembly	to accessory rail, integrated mounting adaptor

▶ HYPERION | FLARE | OPTIMA 5.9, 5.12 5.15, 5.20 | PRIME | SU-02 | SU-14 | VIDAR



WS-42 Lower leg strap

- Designed for immobilisation of the patient's lower leg on the operating table leg rest.
- It consists of an electropolished stainless steel adaptor with bracket and two stitched together straps of different lengths made of polycaprolactam.
- An adaptor and a longer strap (wrapping around the leg rest) ensure a secure installation.
- The shorter strap goes around the patient's lower leg.
- Size adjustment by means of a hook&loop system.

dimensions	735 x 100 mm 580 x 100 mm
adjustment	longitudinal, size adjustment of both straps, hook & loop
assembly	to accessory rail, integrated mounting adaptor

◀ HYPERION | FLARE | OPTIMA 5.9, 5.12 5.15, 5.20 | PRIME | SU-02 | SU-14 | VIDAR



WS-42.1 Lower leg strap

- Designed for immobilisation of the patient's lower leg on the operating table leg rest.
- It consists of two stitched together straps of different lengths made of polycaprolactam.
- The longer strap goes around the lower leg ensuring a secure installation.
- The shorter strap goes around the patient's lower leg.
- Size adjustment by means of a hook&loop system.

dimensions	850 x 100 mm and 580 x 100 mm
adjustment	longitudinal, size adjustment of both straps, hook & loop
assembly	mounted directly on a leg rest, no mounting adaptor required

◀ OPTIMA 5.9, 5.12, 5.15, 5.20 | PRIME | SU-02 | SU-14 | VIDAR



WS-42.5 Lower leg strap

- Designed for immobilisation of the patient's lower leg on the operating table leg rest.
- It consists of an electropolished stainless steel adaptor with bracket and two stitched together straps of different lengths made of polycaprolactam.
- An adaptor and a longer strap (wrapping around the leg rest) ensure a secure installation.
- The shorter strap goes around the patient's lower leg.
- Size adjustment by means of a hook&loop system.
- Easy and quick disinfection

dimensions	930 x 100 mm and 780 x 100 mm
adjustment	longitudinal, size adjustment of both straps
assembly	accessory rail, integrated mounting adaptor

◀ OPTIMA 5.9, 5.12 5.15, 5.20 | PRIME | SU-02 | SU-14 | VIDAR



WS-44 Thigh strap

- Designed for immobilisation of the patient's thigh on the operating table leg rest.
- Consists of an electropolished stainless steel adaptor with bracket and a polycaprolactam strap.
- Adjustment on the adaptor with bracket using the hook&loop system.
- It simultaneously wraps around the thigh and the leg rest.
- Easy and quick disinfection.
- Polyurethane foam insert over a length of 450 mm.

dimensions	1,250 x 100 mm
adjustment	longitudinal, strap adjustment
assembly	accessory rail, integrated mounting adaptor

◀ OPTIMA 5.9, 5.12 5.15, 5.20 | PRIME | SU-02 | SU-14 | VIDAR



WS-44.1 Thigh strap

- Designed for immobilisation of the patient's thigh on the operating table leg rest.
- It consists of two straps - a longer and a shorter one.
- The longer strap goes around the leg rest and is used for mounting.
- The shorter strap wraps around the patient's thigh, holding it in the required position.
- Easy and quick disinfection

strap size	900 x 100 mm 850 x 100 mm
adjustment	longitudinal, strap adjustment
assembly	mounted directly on a leg rest, no additional mounting adaptor required

◀ OPTIMA 5.9, 5.12 5.15, 5.20 | PRIME | SU-02 | SU-14 | VIDAR





WS-44.5 Thigh strap

- Designed for immobilisation of the patient's thigh on the operating table leg rest.
- Consists of an electropolished stainless steel adaptor and a polycaprolactam strap.
- It simultaneously wraps around the thigh and the leg rest.
- Adjustment on the adaptor with bracket using the hook&loop system.
- Easy and quick disinfection.
- Polyurethane foam insert over a length of 650 mm.

strap size	1,450 x 100 mm
adjustment	longitudinal, strap adjustment
assembly	mounted on the side rail of the leg rest, integrated mounting adaptor required.

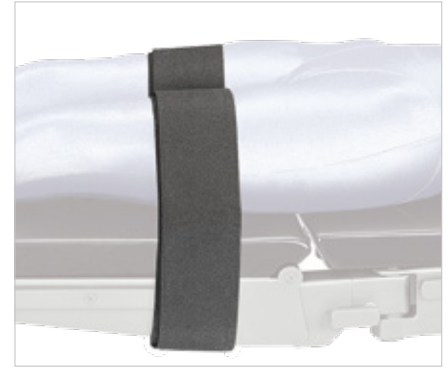

WS-66 66 Half-roll

- It can be used as a knee support for a patient lying in supine position or under the ankle joint for a patient lying in prone position.
- The roll adapts to the patient's body and prevent decubitus.
- Made of polyurethane foam upholstered with leather.
- Easy to disinfect.

dimensions	500 x 180 x 110 mm
transparency	X-ray transparent



WS-68 Neck half-roll

- Serves as a neck support for patients lying in supine position.
- The roll adapts to the patient's body and prevent decubitus.
- Made of polyurethane foam upholstered with leather.
- Easy to disinfect.

dimensions	420 x 160 x 80 mm
transparency	X-ray transparent

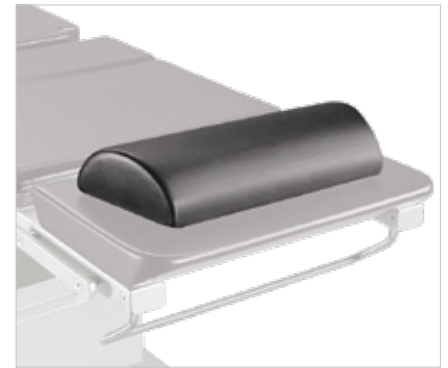

WS-69 Headrest

- Serves as a head support for patients lying in supine position.
- The shaped design adapts to the patient's head and prevents decubitus.
- Made of polyurethane foam upholstered with leather.
- Easy to disinfect.

roll dimensions	240 x 220 mm
mattress height	40 mm
transparency	X-ray transparent



WS-59.6 Shoulder support

- Designed to support the patient's shoulders while the patient is placed in the Trendelenburg position.
- Can be used as a side support for the patient's body.
- The set consists of a right and a left support.
- Consists of an arm made of electropolished stainless steel and a rectangular mattress with a large surface area.
- The mattress easily adapts to the patient's body.
- The mounting system ensures stability even during extreme tilt when placing the patient in the Trendelenburg position.

dimensions	205 x 105 x 40 mm
pivot	square 16x16 mm
adjustment	height, distance from patient, angle adjustment
mattress	made of polyurethane foam
assembly	rail, 2x multiposition mounting adaptor required



WS-06.5 Shoulder support

- They prevent the patient from sliding off the operating table top when the patient is placed in the Trendelenburg position.
- Mounted at the patient's shoulder height.
- Consist of an electropolished stainless steel support structure and kidney-shaped mattresses.
- Set includes right and left shoulder supports.

dimensions	70 x 152 mm
pivot	circular Ø 16 mm
adjustment	height and extension
mattress	24 mm polyurethane
assembly	accessory rail, 2x mounting adaptor required



WS-50.5 Side support

- Designed to support the patient's body in the lateral position.
- It consists of an electropolished stainless steel arm and a rectangular kidney-shaped mattress.
- The mattress easily adapts to the patient's body.
- The mounting system ensures stability even during extreme tilt when placing the patient in the lateral position.

dimensions	152 x 70 x 24 mm
pivot	circular Ø 16 mm
adjustment	height, distance from patient
mattress	polyurethane
assembly	accessory rail, mounting adaptor required



AS-70.51 FlexArm™ side support

- Designed to stabilise the patient placed in a lateral position.
- Consists of an adjustable arm made of electropolished stainless steel and a rectangular-shaped mattress.
- The arm has three rotating elements locked with a single knob for free positioning.
- Mattress made of polyurethane foam with waterproof and anti-static cover.

mattress	200 x 100 mm
adjustment	3D in each axis
mattress	made of 50 mm polyurethane foam
assembly	to accessory rail, integrated mounting adaptor





AS-79 Universal side support arm





- Universal arm with interchangeable ends for stabilising the patient in lateral position.
- Integrated assembly socket for quick exchange of the mattress top in various sizes, which is part of the support.
- Ends mounted on quick connect fittings.
- Electropolished stainless steel arm
- **Adjustment of height**, extension, rotation of arm around its axis, mattress rotation around its axis adjustable by a set of knobs.



adjustment	height, extension, rotation around its axis
assembly	to accessory rail, integrated mounting adaptor
compatibility	interchangeable ends on quick connect fittings: AS-79.11, AS-79.12, AS-79.13, AS-79.14, AS-79.31, AS-79.32, AS-79.33, AS-79.41, AS-79.42

The interchangeable ends for the AS-79 universal side support arm are used to support the patient's body in a lateral position. The polyurethane foam mattress easily adapts to the patient's body. They are fitted with a quick connect fitting compatible with the AS-79.

HYPERION | FLARE | OPTIMA 5.9, 5.12, 5.15, 5.20 | PRIME | SU-02 | SU-14

	interchangeable ends	shape	dimensions	thickness	
1	AS-79.11 Small side support mattress	square	95 x 95 mm	40 mm	
2	AS-79.12 Small side support mattress	rectangle	100 x 200 mm	40 mm	
3	AS-79.13 Large side support mattress	square	170 x 240 mm	50 mm	
4	AS-79.14 Large side support mattress	square	200 x 200 mm	40 mm	
5	AS-79.31 Special shape mattress	special shape R=160	70 x 150 mm	25 mm	

6	AS-79.32 Special shape mattress with cut-out	with half-round cut-out R=100 mm	100 x 200 mm	40 mm	
7	AS-79.33 Special shape mattress	special shape R=250 mm	105 x 245 mm	40 mm	
8	AS-79.41 Triangular mattress	triangle	170 x 190 mm	40 mm	
9	AS-79.42 Round mattress	circular	∅ =120	40 mm	

WS-06.55 Shoulder support

- They prevent the patient from sliding off the operating table top when the patient is placed in the Trendelenburg position.
- Mounted at the patient's shoulder height.
- Support structure made of electropolished stainless steel.
- Mattresses made of polyurethane foam.
- Set includes right and left shoulder supports.

dimensions	245 x 155 mm
pivot	rectangular 25 x 10 mm
adjustment	height and extension
mattress	40 mm polyurethane foam
assembly	accessory rail, integrated mounting adaptor

 HYPERION | FLARE | OPTIMA 5.9, 5.12, 5.15, 5.20 | PRIME | SU-02 | SU-14 | VIDAR



WS-06.7 Side support

- Designed to support the patient's body in the lateral position.
- It consists of an electropolished stainless steel arm and a rectangular kidney-shaped mattress.
- The mounting system ensures stability even during extreme tilt when placing the patient in the lateral position.

dimensions	152 x 70 mm
pivot	rectangular 25 x 10 mm
adjustment	height
mattress	24 mm polyurethane
assembly	accessory rail, integrated mounting adaptor

 HYPERION | FLARE | OPTIMA 5.9, 5.12, 5.15, 5.20 | PRIME | SU-02 | SU-14 | VIDAR



WS-15.5 Surgical instruments tray

- Designed for the storage of surgical instruments directly at the operating table.
- Provides quick access to the required surgical instruments.
- Consists of an electropolished stainless steel tray and an arm for height adjustment and rotation around its axis.
- It has shaped edges to prevent instrument from slipping off the table top.

tray dimension	325 x 530 mm
pivot	circular ∅ 16 mm
adjustment	height, rotation around its axis
assembly	accessory rail, mounting adaptor required

 HYPERION | FLARE | OPTIMA 5.9, 5.12, 5.15, 5.20 | PRIME | SU-02 | SU-14 | VIDAR





ORTHOPAEDICS AND TRAUMATOLOGY

Orthopaedics and traumatology

Patient positioning using the SO-12 orthopaedic attachment with stretching mechanism

The operated limb is positioned using the WS-85.6 attachment for knee operation and foot stabilisation shoes with stretching mechanism. The non-operated limb is supported by the WS-71.5 leg support. The range of available adjustments of the SO-12 orthopaedic attachment allows the patient's position to be adapted to the requirements of a specific procedure, and the attachment's range of lateral extension of the arms provides adequate space for the surgeon.

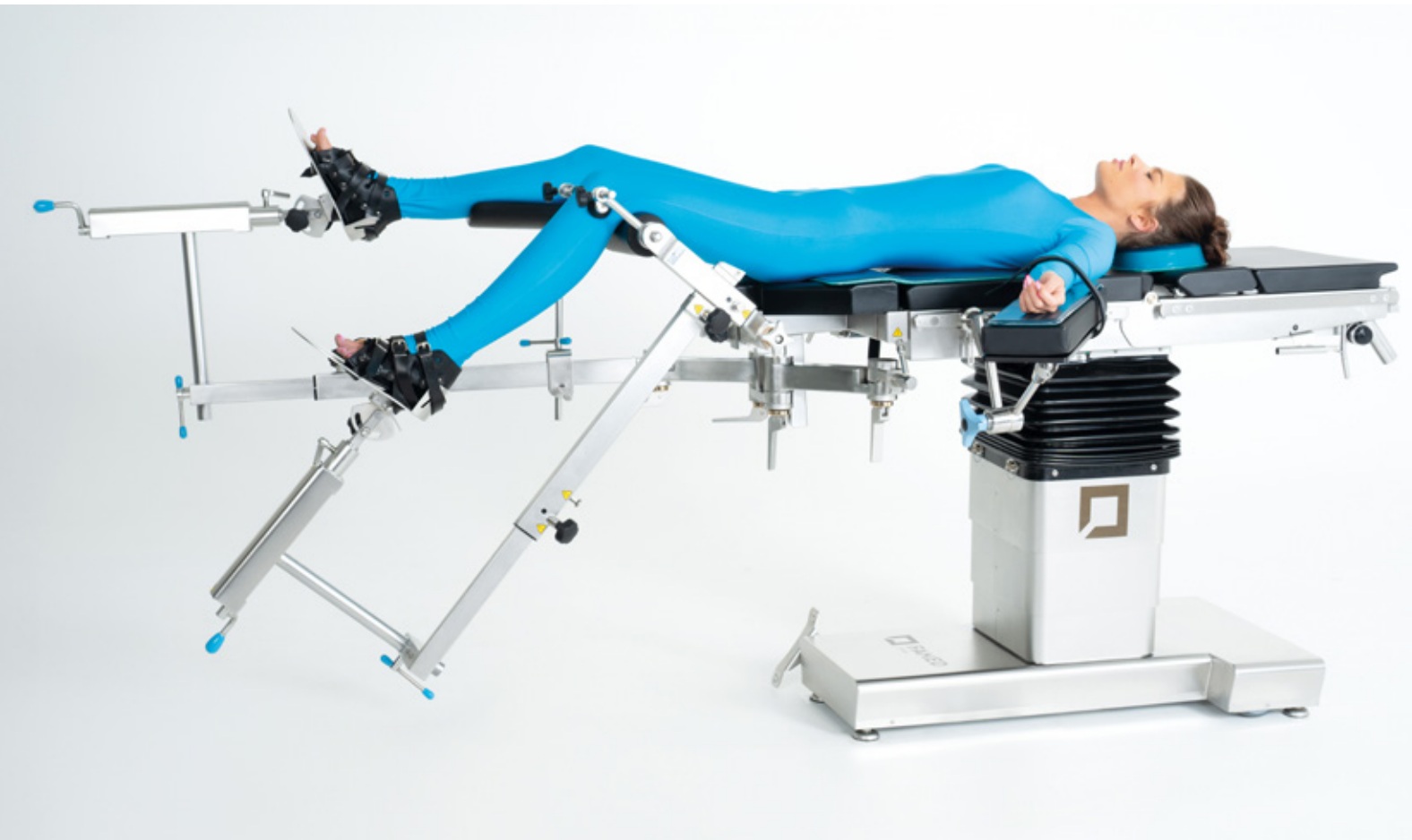

RECOMMENDED SET OF ACCESSORIES	PREMIUM	BASIC
Head	EL011 gel head positioner	EL011 gel head positioner
Torso	OAL030 Universal pad	OAL030 Universal pad
Sacrum	AZ301 Sacrum and buttock support	AZ301 Sacrum and buttock support
Hands	2 x AS-70.31 FlexArm™ arm support 2 x OA072 Arm pad	2 x PR-01.5 Arm support
Legs	SO-14 Orthopaedic attachment	SO-12 Orthopaedic attachment
Feet	Shoe for SO-14	Shoe for SO-12
Knee	WS-85.6 Attachment for knee operation	WS-85.6 Attachment for knee operation



SO-12 Orthopaedic attachment with lift

It is used for the treatment of lower limb fractures, joint arthroscopy and hip surgery. It is mounted in place of the foot rests, equipped with a top with a single point of support and two mounting points for the wedge, which moves the hip towards the surgeon, making the area extending behind the spina iliaca anterior superior available for imaging.

It includes additional support with end-mounted feet. Two rotating elements under the table top allow the leg to be easily retracted and the operating area for the C-arm to be significantly exposed, or the unused part to be stored under the table.

height adjustment of the stretching mechanism	320 mm
distance between the resistance roll and the stretching mechanism	475 - 1,250 mm
screw extension of the stretching mechanism	250 mm
swing range of pivot arms	180°
assembly	wedges
mattress	80 mm polyurethane foam / 40 mm polyurethane

- ❑ SO-12.1 - SU-02 | PRIME | OPTIMA 5.9, 5.12
- ❑ SO-12.2 - HYPERION
- ❑ SO-12.3 - SU-14
- ❑ SO-12.4 - OPTIMA 5.15
- ❑ SO-12.45 - OPTIMA 5.20

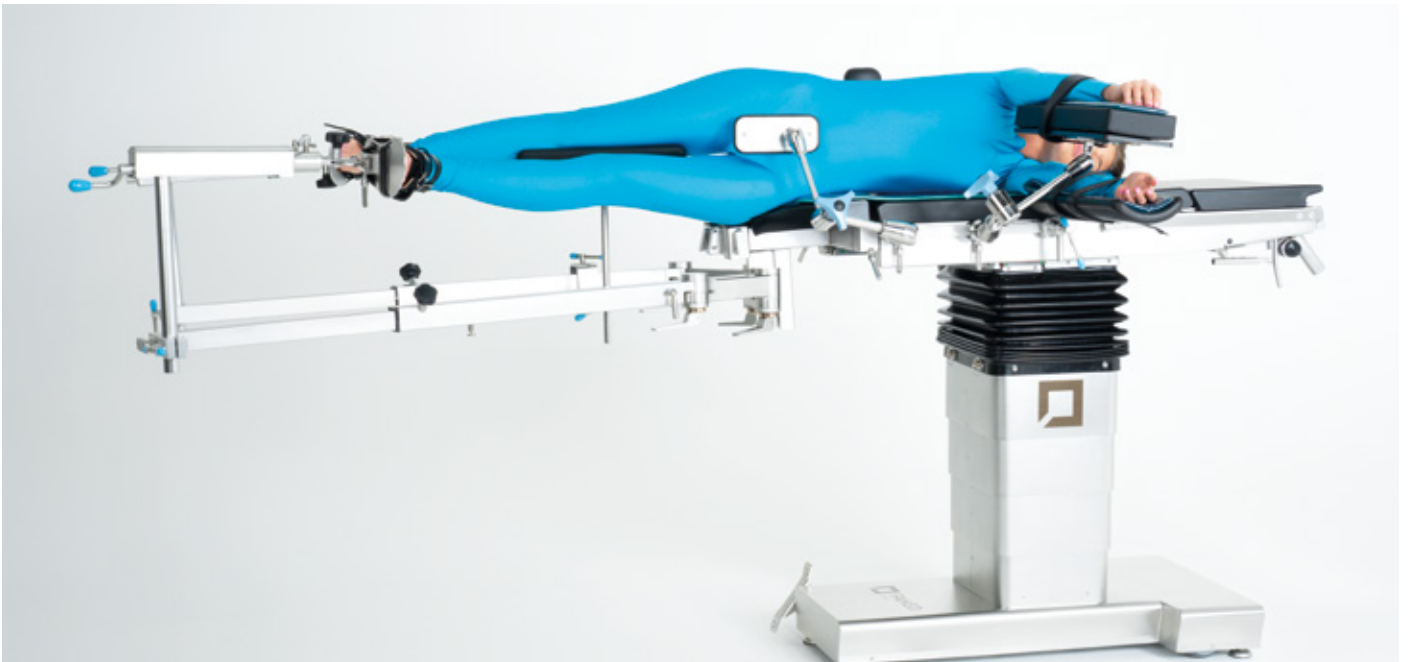

SO-14 Orthopaedic attachment with lift with carbon fibre arms

Similar to the SO-12 but with a single rotating element and carbon fibre arms. The X-ray-transparent arms facilitate manoeuvring of the C-arm. Their shape differs from that of the Famed SO-12 arms, so a dedicated adaptor WS-82.6 is required to mount accessories.

height adjustment of the stretching mechanism	320 mm
distance between the resistance roll and the stretching mechanism	475 - 1,250 mm
screw extension of the stretching mechanism	250 mm
swing range of pivot arms	180°
assembly	wedges
mattress	80 mm polyurethane foam / 40 mm polyurethane



- SO-14 - SU-02 | PRIME | OPTIMA 5.9, 5.12
- SO-14.2 - HYPERION
- SO-14.4 - OPTIMA 5.15
- SO-14.45 - OPTIMA 5.20



Adult leather shoes for Famed SO-12 and SO-14

- Designed for adult patients
- They are used to support the patient's foot during procedures using the Famed SO-12 or SO-14 orthopaedic attachment.
- They secure the patient's foot and keep it in place during stretching of the operated limb.
- Natural leather design consisting of a laced shoe and mounting straps with brackets.
- Soft, durable and easy to disinfect lining.
- Mounted to Famed SO-12 or SO-14 orthopaedic attachment foot support.



adjustment	lacing and brackets
assembly	to the Famed SO-12 or SO-14 foot support, integrated mounting straps



SO-12 | SO-14



Paediatric leather shoes for Famed SO-12 and SO-14

- Designed for paediatric patients.
- They are used to support the patient's foot during procedures using the Famed SO-12 or SO-14 orthopaedic attachment.
- They secure the patient's foot and hold it in place during stretching of the operated limb.
- Natural leather design consisting of a laced shoe and mounting straps with brackets.
- Soft, durable and easy to disinfect padding.
- Mounted to Famed SO-12 or SO-14 orthopaedic attachment foot support.

adjustment	lacing and brackets
assembly	to the Famed SO-12 or SO-14 foot support, integrated mounting straps



WS-60.6 Hip support

- Designed to support limbs during hip surgery in lateral position.
- Consists of vertical roll (fixed), horizontal roll (movable) and hip support.
- Made of electropolished stainless steel with polyurethane mattresses.
- Height adjustment in the range of 0-100 mm and rotation of the horizontal shaft on its own axis allow the accessory to be adapted to each patient.

support	230 x 345 x 40 mm
horizontal roll	∅ 66 mm
vertical roll	∅ 80 mm
mattresses	polyurethane
adjustment	height - 0-100 mm; rotation around its axis
assembly	requires another attachment



WS-70.6 Support for plastering

- Designed to support the patient's hip during plastering.
- Consists of an adjustable arm made of electropolished stainless steel.
- Easy to disinfect.
- Stable construction.

adjustment	arm extension
assembly	Famed SO-12 or SO-14 wedge

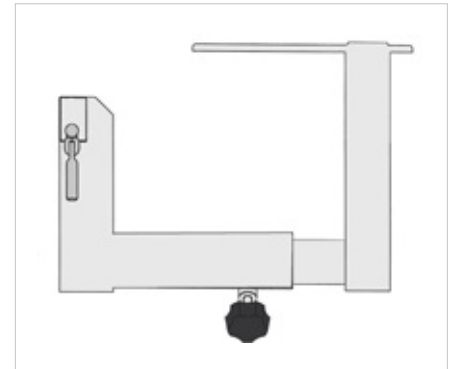

WS-71.5 Leg support

- Designed to support the lower leg or thigh during procedures performed using the Famed SO-12 and SO-14 orthopaedic attachment.
- It consists of a shaped support finished with a polyurethane mattress and a load-bearing section made of electropolished stainless steel.
- Easy to assemble and disinfect.

mattress	360 x 160 x 24 mm
adjustment	height, distance from table top, rotation around its axis
pivot	∅ 16 mm
assembly	Famed SO-12 or SO-14 arm, mounting adaptor required,



WS-72.5 Crossbar/strap support

- Used to support the limb during plastering after fixation of the femoral area.
- The electropolished stainless steel construction consists of a load-bearing section, a crossbar and leather strap.
- Can be used to support the lower limb of a patient placed in a prone or supine position.
- Suitable for use with Famed SO-12 or SO-14 orthopaedic attachment.

strap / crossbar length	460/280 mm
adjustment	height, distance from table top, rotation around axis
pivot	∅ 16 mm
assembly	Famed SO-12 or SO-14 arm, mounting adaptor required



SO-12 | SO-14

WS-73.5 Foot holder clip

- Designed for restraining the patient's foot to tighten the lower limb with a stretching mechanism.
- Right and left clip included.
- Clip made of electropolished stainless steel with natural leather harness.
- Mounted in place of the rotating foot holder on the stretching mechanism of the Famed SO-12 or SO-14 orthopaedic attachment.
- The harness adjustment at the buckle allows the size to be adjusted to suit each patient's foot.

adjustment	size, stretch
assembly	Famed SO-12 holder, integrated mounting adaptor



SO-12 | SO-14

WS-74.5 Heel holder

- Designed for positioning the lower limb in the Famed SO-12 or SO-14 stretching mechanism.
- Used for positioning the limb for surgery.
- Made of electropolished stainless steel
- Consists of shaped fork with clamp with integrated mounting adaptor.
- Right and left holder included.

fork width	90 mm
fork spacing	50 mm
adjustment	stretch
assembly	Famed SO-12 or SO-14 holder, integrated assembly adaptor



SO-12 | SO-14

WS-75.5 Knee joint support

- Designed to support the knee of a patient placed in a lateral position.
- Designed to provide knee support below the shoulder line of the Famed SO-12 or SO-14 orthopaedic attachment.
- Consists of a support arm and a polyurethane mattress.
- Adjustable distance from the patient, height, angle of the support arm and rotation on its own axis of the support arm.

mattress	295 x 180 mm
pivot	circular ∅ 16 mm
mattresses	24 mm polyurethane
adjustment	distance, height, angle and rotation around axis
assembly	for SO-12 orthopaedic attachment, mounting adaptor required



SO-12 | SO-14

WS-82.5 Accessory adaptor

- Allows mounting of accessories to Famed orthopaedic attachment SO-12
- Suitable for use with accessories with a 16 mm diameter pivot.
- Made of electropolished stainless steel.
- Consists of a bracket and a counter crossbar with a multiposition adaptor.

adjustment	angular, longitudinal
mounting hole:	Ø 16 mm
assembly	Famed SO-12 arm, mounting adaptor required

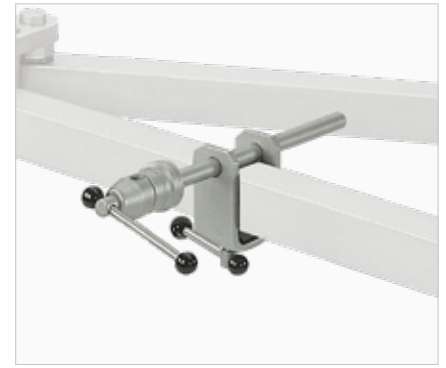

WS-82.7 Accessory adaptor

- Allows mounting of accessories to Famed orthopaedic attachment SO-12
- Suitable for use with accessories with a 16 x 16 mm pivot.
- Made of electropolished stainless steel.
- Consists of a bracket and a counter crossbar with a multiposition adaptor.

adjustment	angular, longitudinal
mounting hole	16 x 16 mm
assembly	Famed SO-12 arm, mounting adaptor required

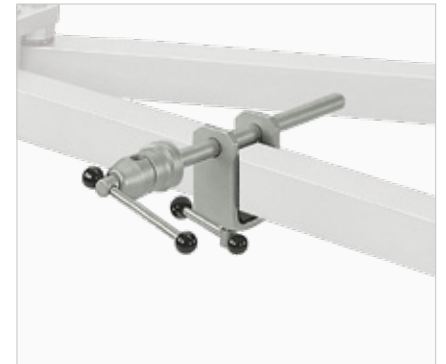

WS-82.6 Accessory adaptor

- Allows mounting of accessories to Famed orthopaedic attachment SO-14
- Suitable for use with accessories with a 16 mm diameter pivot.
- Made of electropolished stainless steel.
- Consists of a bracket and a counter crossbar with a multiposition adaptor.

adjustment	angular, longitudinal
mounting hole	Ø 16 mm
assembly	Famed SO-14 arm, mounting adaptor required



WS-82.8 Accessory adaptor

- Allows mounting of accessories to Famed orthopaedic attachment SO-12
- Suitable for use with accessories with a 16 x 16 mm pivot.
- Made of electropolished stainless steel.
- Consists of a bracket and a counter crossbar with a multiposition adaptor.

adjustment	angular, longitudinal
mounting hole	for 16 x 16 mm square pivot
assembly	Famed SO-14 arm, mounting adaptor required,



WS-85.6 Attachment for knee operation with lower leg lift

- Designed to support the knee joint and apply traction to the lower leg bones.
- Enables lower limb traction with the support of Famed SO-12 and SO-14 stretching mechanism.
- It consists of a support structure with a polyurethane roll and two stabilising holders with adjustable spacing.
- Made of electropolished stainless steel.
- Mounting in place of support assembly.

roll dimensions	225 x 80 mm
adjustment	height, inclination and spacing of holders
mattress	polyurethane
assembly	SO-12 or SO-14 orthopaedic attachments wedge integrated mounting adaptor

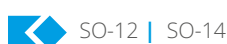

AS-85 leg rest for orthopaedic attachment

- Used to support the patient's lower limbs during procedures carried out with an orthopaedic attachment.
- Made of electropolished stainless steel with HPL plastic top.
- Mattress made of polyurethane.
- Mounted on orthopaedic attachment wedges.
- Easy assembly and disassembly of mattresses and quick disinfection.
- Set includes two leg rests - left and right.

adjustment	615 x 236 mm
mounting hole	50 mm polyurethane
assembly	attachment wedges, integrated mounting adaptor

SO-12.1 | SO-14



AS-85.1 leg rest for orthopaedic attachment

- Used to support the patient's lower limbs during procedures carried out with an orthopaedic attachment.
- Made of electropolished stainless steel with HPL plastic top.
- Mattress made of polyurethane foam.
- Mounted on orthopaedic attachment wedges.
- Easy assembly and disassembly of mattresses using the hook&loop system.
- Set includes two leg rests - left and right.

adjustment	585 x 236 mm
mounting hole	80 mm polyurethane foam
assembly	attachment wedges, integrated mounting adaptor,

SO-12.2 | SO-12.3 | SO-12.4 | SO-12.45 | SO-14.2 | SO-14.4 | SO-14.45



SO-12 or SO-14 orthopaedic attachment trolley

- Designed to hold or transport and store the SO-12 or SO-14 orthopaedic attachment.
- Facilitates mounting and dismounting of the attachment to the operating table.
- Made of electropolished stainless steel.
- Four wheels with a diameter of 125 mm (2 with brakes) for easy rolling.
- Basket for additional equipment.



Trolley variants and compatibility:

trolley	variant SO-12	compatibility	length	width	height	function
WS-80.7		SO-12	1,180 mm	660 mm	850 mm	storage
WS-80.8	SO-12.1	OPTIMA 5.9, 5.12 PRIME	1,179 mm	580 mm	860 mm	transport storage
WS-80.9	SO-12.2	HYPERION	1,179 mm	580 mm	760 mm	transport storage
WS-80.11	SO-12.4	OPTIMA 5.15	1,179 mm	580 mm	860 mm	transport storage
WS-80.115	SO-12.4	OPTIMA 5.20	1,179 mm	580 mm	730 mm	transport storage
WS-80.12	SO-14.2	HYPERION	1,179 mm	580 mm	760 mm	transport storage
WS-80.14	SO-14.4	OPTIMA 5.15	1,179 mm	580 mm	860 mm	transport storage
WS-80.145	SO-14.4	OPTIMA 5.20	1,179 mm	580 mm	730 mm	transport storage



RECOMMENDED SET OF ACCESSORIES	PREMIUM	BASIC
Head positioning	AS-70.7 Special headrest	AS-78.1 Special headrest
Face stabilisation	AS-77.11 Special headrest mask	AS-77.6 headrest strap set
Side support	AS-77.4 Abdominal restraint strap	AS-77.4 Abdominal restraint strap
Operated hand	AS-70.31 FlexArm™ arm support	WS-07.5 arm support
Non-operated hand	AS-70.31 FlexArm™ arm support	PR-01.6 arm support
Anti-decubitus mattress for buttocks	EL 031 Gel mattress for buttocks	EL 031 Gel mattress for buttocks
Anti-decubitus pads for ankle joint	OA Gel pads	OA Gel pads
Anti-decubitus pads for knee joint	OA 213 Gel half-roll	OA 213 Gel half-roll

AS-77 Famed ArtHero™ Shoulder Surgery System

Table top designed for arthroscopy of the shoulder complex with removable (or lowerable) plates to facilitate access to the shoulder joint. The table top is mounted in place of the foot rests, allowing the angle of the accessory to be adjusted by remote control. The lightweight aluminium structure and quick-assembly/disassembly system allows for one-person operation. Removable side segments provide full access to the shoulder during surgery. The 80-mm-thick foam mattresses with waterproof covers ensure patient comfort and safety, even during procedures that last for hours. By choosing the appropriate accessories, the system can be adapted to the surgeon's needs and the time required for patient positioning can be significantly reduced.

dimensions without headrest	670 x 570 x 230 mm
table top dimension	565 x 570 mm
dimensions of right/left table top	395 x 200 mm
assembly	wedges, integrated mounting bracket
angle adjustment	-30° to 80°
mattress	80 mm polyurethane foam



HYPERION | OPTIMA 5.15, 5.20

AS-80 Famed ArtHero™ Shoulder Surgery System

Table top designed for arthroscopy of the shoulder complex with removable (or lowerable) plates to facilitate access to the shoulder joint. Adjustable width spacing allows mounting to the accessory rails of most operating tables on the market. Gas springs allow easy angle adjustment of the table top. The lightweight structure and quick-assembly/disassembly system allows for one-person operation. Removable side segments provide full access to the shoulder during surgery. The system includes anti-static, waterproof polyurethane foam mattresses with a thickness of 80 mm or 40 mm (depending on the thickness of the operating table mattress). By choosing the appropriate accessories, the system can be adapted to the surgeon's needs and the time required for patient positioning can be significantly reduced.

dimensions without headrest	800 x 610 x 230 mm
table top dimension	565 x 570 mm
dimension of one table top	395 x 200 mm
assembly	accessory rail, mounting adaptor required
angle adjustment	0° to + 80°
width adjustment	480-680 mm
mattress	80 mm / 40 mm polyurethane foam



HYPERION | OPTIMA 5.9, 5.12, 5.15, 5.20 | PRIME | SU-02 | SU-14

AS-70.7 FlexArm™ special helmet

- Designed to support and position the patient's head during shoulder arthroscopy and other procedures.
- Fully adjustable thanks to three rotating elements locked by a single knob.
- Allows lateral positioning of the head and lifting of the cervical spine.
- The folding side rails of the helmet allow a single headrest to be used during anaesthesia and surgery.
- Easily removable padding inside the helmet protects the patient's head.
- The helmet's design allows the fitting of face stabilising straps or a special mask with holes for tubes.

adjustment	3D in each axis
rotating elements	3
pivot	square 20 x 20 mm
mattresses	polyurethane foam
assembly	square socket 20 x 20 mm

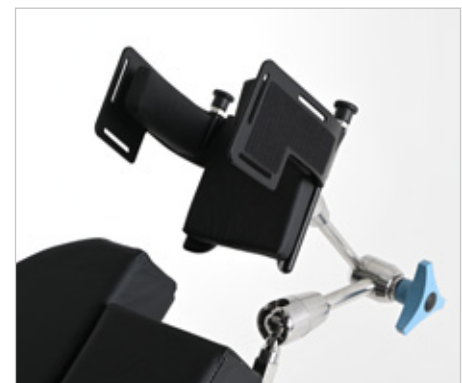

ArtHero™ AS-80 | ArtHero™ AS-77 | headrest adaptor for pivot square 20 x 20 mm



AS-77.6 Helmet strap set

- Designed to stabilise the patient's head in the AS-70.7 special helmet.
- The set includes 3 reusable straps securing the patient's chin, forehead and top of the head.
- Made of easy to disinfect polycaprolactam.
- Mattresses in contact with the patient's skin
- Mounted to dedicated holes in the helmet and adjusting the length of the straps with a hook&loop system.

mattress	100 x 50 mm
chin strap	650 x 48 mm
forehead strap	500 x 48 mm
top of head strap	500 x 48 mm
mattress	20 mm polyurethane foam
adjustment	length
assembly	AS-70.7 special headrest required



ArtHero™ AS-80 | ArtHero™ AS-77

AS-77.11 Special helmet mask

- Designed to stabilise the patient's head in the AS-70.7 special helmet.
- Disposable mask.
- Made of soft foam to provide comfort while keeping the patient's head in the headrest.
- Mounted to the headrest with a hook&loop system.
- Cut-out at mouth and nose area for anaesthetic tubes.

mounting points	5
overall dimensions	597 x 660 mm
hole dimensions	70 x 90 mm
assembly	hook & loop, AS-70.7 special headrest required



ArtHero™ AS-80 | ArtHero™ AS-77

AS-77.12 Special helmet chin strap

- Secures the patient's chin and head in the AS-70.7 special helmet.
- Disposable belt.
- Mounted to the headrest with a hook&loop system.
- Made of soft foam to provide comfort while keeping the patient's head in the headrest.
- Special stitching to prevent the strap slipping off the patient's chin.
- The stitching in the middle of the strap secures the patient's chin, and the two ends connect to each other at the level of the cranial coronal suture.

mounting points	3
overall dimensions	80 x 600 mm
adjustment	length
assembly	hook & loop, AS-70.7 special headrest required



ArtHero™ AS-80 | ArtHero™ AS-77

AS-77.13 Special helmet forehead strap

- Secures the patient's forehead and head in the AS-70.7 special helmet.
- Disposable belt.
- Mounted to the headrest with a hook&loop system.
- Made of soft foam to provide comfort while keeping the patient's head in the headrest.
- The strap wraps around the patient's forehead and the ends connect to each other at the back of the helmet.

mounting points	3
overall dimensions	80 x 500 mm
adjustment	length
assembly	hook & loop, AS-70.7 special headrest required



ArtHero™ AS-80 | ArtHero™ AS-77

AS-77.4 Abdominal restraint strap

- Designed to stabilise the patient's body during surgery using the **Famed AS-77 or AS-80 ArtHero™ shoulder arthroscopy system**.
- Supports stabilisation of the patient's body on a given side of the shoulder arthroscopy system table top.
- Made of easy to disinfect polycaprolactam with hook & loop system.
- The length and width of the strap ensures a customised fit to the patient's body.
- The strap completely wraps around the patient's body in the abdominal area, passing through the mounting brackets located on the back of the Famed ArtHero™ table top.

dimensions	2,000 x 100 mm
adjustment	strap length
assembly	dedicated holders

ArtHero™ AS-80 | ArtHero™ AS-77



WS-47.5 Humerus positioning device with Weinberger hand cuff

- Designed to support the forearm during the fixation of forearm bone fractures.
- Consists of a hand cuff and a wedge roll.
- Can be used in transverse or longitudinal position relative to the operating table top.
- Finger clamps allow quick release or immobilisation of the hand.
- Traction operated by a rotary lever.
- Made of electropolished stainless steel

roll	polyurethane, Ø 16 x 300 mm
pivot	circular Ø 16 mm
adjustment	finger holder angle, height, traction
assembly	to accessory rail, 2 mounting adaptors required



HYPERION | FLARE | OPTIMA 5.9, 5.12, 5.15, 5.20 | PRIME | SU-02 | SU-14 | VIDAR

WS-87.5 Support for upper limb surgery

- It provides additional support during procedures involving the shoulder joint, arm, elbow joint and other procedures requiring the patient to be extended beyond the joint.
- Allows the patient to be moved to the side of the table top, increasing access to the operated area.
- Allows positioning of the patient in both supine and prone positions.
- Made of electropolished stainless steel with HPL top and polyurethane or polyurethane foam mattress (optional).

mattress dimensions	290 x 200 mm
adjustment	longitudinal
mattress	40 mm polyurethane or 80 mm foam (optional)*
assembly	to accessory rail, integrated mounting adaptor



HYPERION | OPTIMA 5.9, 5.12, 5.15, 5.20 | PRIME | SU-02 | SU-14 | VIDAR

*The thickness of the support mattress should be adapted to the thickness of the operating table mattress.



GYNAECOLOGY, UROLOGY

PROCTOLOGY, LITHOTOMY

Gynaecology, urology, proctology, lithotomy

Patient positioning using stirrups leg holders

In this case, the patient's lower limbs are positioned with stirrup-type leg holders, which allow them to be inverted laterally in a lithotomy position. The use of stirrups provides the operator with adequate access to the area to be operated on and the range of movement from -55° to $+85^{\circ}$ helps to reduce the surgeon's effort and improve ergonomics. The SG-44.8 Gynaecological-urological section with a special cut-out extends the operating table top and allows further extension of the patient towards its shorter edge.



RECOMMENDED SET OF ACCESSORIES	PREMIUM	BASIC
Head	EL011 gel head positioner	EL011 gel head positioner
Hands	2 x AS-70.31 FlexArm™ arm support 2 x OA072 Arm pad	2 x PR-01.5 Arm support
Shoulders	2x WS-06.5 Shoulder support 2 x AS-89 Mounting adaptor	2x WS-06.5 Shoulder support 2 x WS-16.5 Mounting adaptor
Torso	OAL030 Universal pad	OAL030 Universal pad
Sacrum	SG-44.8 Gynaecological-urological section AZ301 Sacrum and buttock support	Operating table top AZ301 Sacrum and buttock support
Legs	KTEK3100 Clean Leg holder	WS-96.5 Attachment for leg movement
Other	WS-28.9 Gynaecological and urological bowl WS-89.5 Strainer	WS-28.9 Gynaecological and urological bowl



AS-11 Positioner for proctology procedures

- A set containing a kneeler and abdomen roll used for patient positioning during proctology procedures and during lumbar spine surgery.
- Allows the patient's buttocks to be exposed and the lumbar region to be elevated
- Made of electropolished stainless steel.
- Angle adjustment of the kneeler possible via remote control. Option of manual height adjustment along the entire length of the mounting rails.
- Adjustable height and angle of the abdomen roll.
- The maximum load capacity is 200 kg.

kneeler	60 mm polyurethane foam
roll	polyurethane: 540 mm, Ø 210 mm
pivot	Ø 16 mm
adjustment	angle, height
assembly	kneeler: wedges - in place of foot rests, roll: accessory rail, integrated mounting brackets,

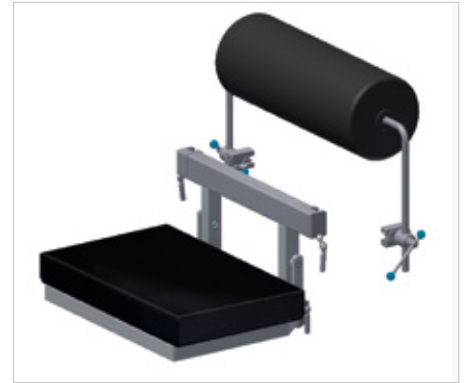

AS-23 Positioner for proctology procedures

- A set containing a kneeler and abdomen roll used for patient positioning during proctology procedures.
- Allows the patient's buttocks to be exposed and the lumbar region to be elevated
- Made of electropolished stainless steel.
- Kneeler mounted to accessory rails in foot rests - angle adjustment assisted by gas springs.
- Adjustable height and angle of the abdomen roll.
- The maximum load capacity of the positioner is 150 kg.

kneeler	polyurethane 45mm, 500 x 293mm
roll	polyurethane 446 mm, Ø 105 mm
pivot	Ø 16 mm
adjustment	angle, height
assembly	accessory rails, 2x mounting adaptors required (abdomen roll)



WS-30.5 Positioner for proctology procedures

- A set containing a kneeler and abdomen roll used for patient positioning during proctology procedures.
- Allows the patient's buttocks to be exposed and the lumbar region to be elevated
- Made of electropolished stainless steel.
- Possibility to adjust the height of the kneeler along the entire length of the side rails.
- Adjustable height and angle of the abdomen roll.
- The maximum load capacity of the positioner is 150 kg.

kneeler	polyurethane: 45mm, 500 x 293mm
roll	polyurethane: 446 mm, Ø 105 mm
pivot	Ø 16 mm
adjustment	angle, height
assembly	accessory rails, 2x mounting adaptors required (abdomen roll)



WS-30.8 Positioner for proctology procedures

- A set containing a kneeler and abdomen roll used for patient positioning during proctology procedures and during lumbar spine surgery.
- Allows the patient's buttocks to be exposed and the lumbar region to be elevated
- Made of electropolished stainless steel.
- Angle adjustment of the kneeler possible via remote control. Option of manual height adjustment along the entire length of the mounting rails.
- Adjustable height and angle of the abdomen roll.
- The maximum load capacity of the positioner is 200 kg.

kneeler	polyurethane foam: 40 mm, 552 x 352 mm
roll	polyurethane foam: 540 mm, 210 mm
pivot	Ø 16 mm
adjustment	angle, height
assembly	kneeler: wedges in place of leg rests roll: accessory rail, integrated mounting brackets



WS-30 Positioner for proctology procedures

- A set containing a kneeler and abdomen roll used for patient positioning during proctology procedures.
- Allows the patient's buttocks to be exposed and the lumbar region to be elevated
- Made of electropolished stainless steel.
- Possibility to adjust the height of the kneeler along the entire length of the side rails.
- Adjustable height and angle of the abdomen roll.
- The maximum load capacity of the positioner is 135 kg.



kneeler	polyurethane 40 mm, 565 x 260 mm
roll	polyurethane: 446 mm, Ø 105 mm
pivot	Ø 16 mm
adjustment	angle, height
assembly	accessory rails, 2x mounting adaptors required (abdomen roll)



AS-16.5 Roll

- Designed to support the lower abdomen of the patient placed in a prone position.
- Allows for the elevation of the lumbar spine.
- Consists of a polyurethane roll on a frame made of electropolished stainless steel.
- Adjustability allows the height and angle of the roll roller to be adapted to the operating table.



roll length	450 mm
diameter	210 mm
pivot	Ø 16 mm
spacing of mounting points	620 mm
adjustment	height and angle
assembly	accessory rails, 2x mounting adaptor required



AS-16.6 Roll

- Designed to support the lower abdomen of the patient placed in a prone position.
- Allows for the elevation of the lumbar spine.
- Consists of a polyurethane roll on a frame made of electropolished stainless steel.
- Adjustability allows the height and angle of the roll roller to be adapted to the operating table.



roll length	450 mm
diameter	210 mm
pivot	Ø 16 mm
spacing of mounting points	705 mm
adjustment	height and angle
assembly	accessory rails, 2x mounting adaptor required



AS-16.7 Roll

- Designed to support the lower abdomen of the patient placed in a prone position.
- Allows for the elevation of the lumbar spine.
- It consists of a roll made of polyurethane foam on a frame made of electropolished stainless steel.
- Adjustability allows the height and angle of the roll roller to be adapted to the operating table.



roll length	540 mm
diameter	210 mm
pivot	Ø 16 mm
spacing of mounting points	684 mm
adjustment	height and angle
assembly	accessory rails, 2x mounting adaptor required

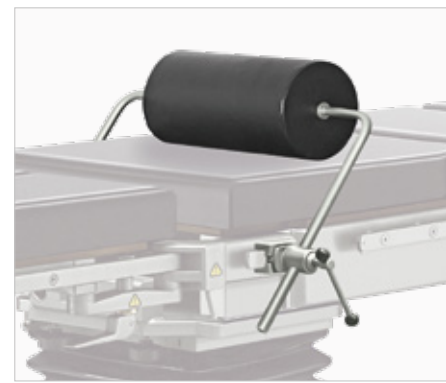



WS-64.5 Lithotomy stirrups

- Designed to support the patient's lower limbs i.a.: in the lithotomy position.
- Consist of a loop made of polycaprolactam tape and electropolished stainless steel supports.
- Easy removal of the loop for disinfection.
- Double height adjustment - on the support clamps and on the mounting adaptor
- Stirrups sold in pairs - optionally sold by piece.

stirrup dimensions	1,000 mm x 40 mm
extension	300 mm
pivot	Ø 16 mm
adjustment	height, rotation around axis
assembly	accessory rails, 2x mounting adaptor required

 HYPERION | OPTIMA 5.9, 5.12, 5.15, 5.20 | PRIME | SU-02 | SU-14 | VIDAR



SG-44.6 Gynaecological-urological section

- Additional table top extension segment used in gynaecology, urology or proctology.
- A cut-out in the table top provides the surgeon with better access to the operated area.
- Made of electropolished stainless steel with X-ray-transparent HPL top and polyurethane mattress.
- Additional accessory rails on the sides of the gynaecological section and a wedge holder for mounting additional accessories.
- Mattress mounted using pins.
- Section assembly in place of leg section.

dimensions	492 x 330 mm
mattress	polyurethane, 50 mm
assembly	wedges, integrated mounting adaptor

 OPTIMA 5.9, 5.12, | PRIME | SU-02



SG-44.7 Gynaecological-urological section

- Additional table top extension segment used in gynaecology, urology or proctology.
- A cut-out in the table top provides the surgeon with better access to the operated area.
- Made of electropolished stainless steel with x-ray-transparent HPL top and polyurethane foam mattress.
- Additional accessory rails on the sides of the gynaecological section and a wedge holder for mounting additional accessories.
- Easy assembly and disassembly of the mattress using the hook&loop system.
- Adjustment of the section angle using the remote control.

dimensions	550 x 357 mm
mattress	polyurethane, 60 mm
adjustment	angle
assembly	wedges, integrated mounting adaptor

 HYPERION

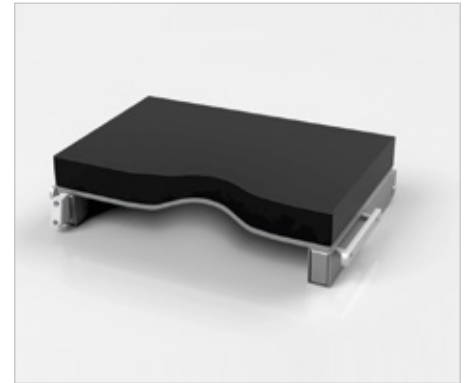

SG-44.8 Gynaecological-urological section

- Additional table top extension segment used in gynaecology, urology or proctology.
- A cut-out in the table top provides the surgeon with better access to the operated area.
- Made of electropolished stainless steel with x-ray-transparent HPL top and polyurethane foam mattress.
- Additional accessory rails on the sides of the gynaecological section and a wedge holder for mounting additional accessories.
- Easy assembly and disassembly of the mattress - mFix™ system.
- Adjustment of the section angle using the remote control.

dimensions	550 x 330 mm
mattress	80 mm polyurethane foam
adjustment	angle
assembly	wedges, integrated mounting adaptor

 OPTIMA 5.15, 5.20

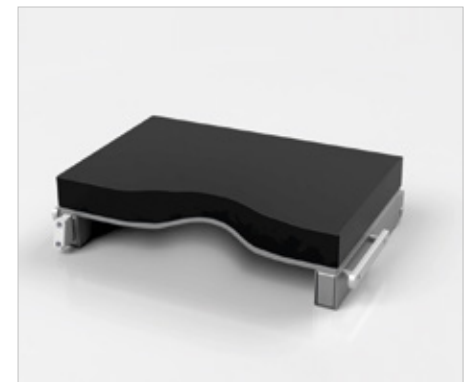

WS-28.9 Gynaecological and urological bowl

- A bowl designed to hold the body fluids during gynaecological or urological procedures.
- Available without a drain (WS-28.9W2) and with a drain (WS-28.9W1) that allows fluids to be drained without removing the bowl.
- It consists of a bowl and handle made of electropolished stainless steel.
- The handle allows height adjustment and rotation around its axis.
- The bowl allows for angle adjustment and rotation around its own axis.
- The version with a drain has a rubber extension for draining fluids.

capacity	4 litres
dimensions	65 x 265 x 325 mm
adjustment	height, inclination angle, rotation around own axis
assembly	accessory rails, integrated mounting adaptor

 HYPERION | OPTIMA 5.9, 5.12, 5.15, 5.20 | PRIME | SU-02 | SU-14 | VIDAR



WS-89.5 Strainer

- Designed for separation of tissue from body fluids
- Compatible with WS-28.9 urological bowl
- Made of electropolished stainless steel
- The distance between the bottom of the bowl and the bottom of the strainer facilitates the drainage of fluids
- Comfortable handles for easy handling

dimensions	201 x 251 x 46 mm
assembly	inserted into the centre of the WS-28.9W1 urological bowl

 WS-28.9 Urological bowl



KTEK2602 Nissen straps

- Used to stabilise the patient placed in anti-Trendelenburg positioning.
- The set includes two straps made from a combination of nylon and viscoelastic foam.
- It can be used on patients placed in supine positions.
- Support structure made of stainless steel and aluminium.
- Size adjustment by means of a bracket.

length	2,430 mm
width	127 mm
thickness	12 mm
adjustment	longitudinal, strap adjustment
assembly	accessory rail, 2x KTEK4710 holder required

 HYPERION | FLARE | OPTIMA 5.9, 5.12, 5.15, 5.20 | PRIME | SU-02 | SU-14 | VIDAR



KTEK1000 Transport trolley for stirrup leg holder

- Designed for the transport and storage of stirrup leg holders.
- It has dedicated handles for vertical storage.
- It helps keep things organised and reduces the space required for storage.
- Easy to disinfect and durable.
- Rack made of steel with plastic handles.
- Storage compartments for storing and transporting accessories and adaptors.

weight	16.1 kg (unloaded)
height	1,035 mm
base dimensions	550 mm x 550 mm
castors	4 pieces



KTEK3000 Stirrup leg holder 159 kg

- Designed to support the leg of a patient placed in the lithotomy position.
- It is perfect for areas of gynaecology, urology, proctology, laparoscopy or robotic surgery.
- The shoe with a shape memory insole adapts to the patient's leg size.
- The patented design provides 22° more ROM compared to solutions from competitors.
- Unique access to pelvic region for robot-assisted procedures.
- Quick assembly and disassembly with Clip-On or other adaptors.
- Adjustable range of lithotomy position and movement locked by a single lever.
- Adjustable distance of the shoe from the operating table.
- No zones where fingers/hands could be crushed.

maximum load	159 kg
lithotomy position range	-55° / +85°
movement range	+25° / -9°
limb strap	Velcro
boot lining	25 mm memory foam
assembly	accessory rails KTEK4200 or KTEK4610 or KTEK4720 mounting adaptor required



 HYPERION | OPTIMA 5.9, 5.12, 5.15, 5.20 | PRIME | SU-02 | SU-14 | VIDAR | FG-07 | FG-04

KTEK400 Stirrup leg holder 181 kg

- Designed to support the leg of a patient placed in the lithotomy position.
- It is perfect for areas of gynaecology, urology, proctology, laparoscopy or robotic surgery.
- The shoe with a shape memory insole adapts to the patient's leg size.
- The patented design provides 22° more ROM compared to solutions from competitors.
- Unique access to pelvic region for robot-assisted procedures.
- Quick assembly and disassembly with Clip-On or other adaptors.
- Adjustable range of lithotomy position and movement locked by a single lever.
- Adjustable distance of the shoe from the operating table.
- No zones where fingers/hands could be crushed.

maximum load	181 kg
lithotomy position range	-55° / +85°
movement range	+25° / -9°
limb strap	silicone strap
boot lining	25 mm memory foam
assembly	accessory rails KTEK4200 or KTEK4610 or KTEK4720 mounting adaptor required



 HYPERION | OPTIMA 5.9, 5.12, 5.15, 5.20 | PRIME | SU-02 | SU-14 | VIDAR | FG-07 | FG-04

KTEK5000 Stirrup leg holder 227 kg

- Designed to support the leg of a patient placed in the lithotomy position.
- It is perfect for areas of gynaecology, urology, proctology, laparoscopy or robotic surgery.
- The shoe with a shape memory insole adapts to the patient's leg size.
- The patented design provides 22° more ROM compared to solutions from competitors.
- Unique access to pelvic region for robot-assisted procedures.
- Quick assembly and disassembly with Clip-On or other adaptors.
- Adjustable range of lithotomy position and movement locked by a single lever.
- Adjustable distance of the shoe from the operating table.
- No zones where fingers/hands could be crushed.

maximum load	227 kg
lithotomy position range	-55° / +85°
movement range	+25° / -9°
limb strap	Velcro
boot lining	25 mm memory foam
assembly	accessory rails KTEK4200 or KTEK4610 or KTEK4720 mounting adaptor required





 HYPERION | OPTIMA 5.9, 5.12, 5.15, 5.20 | PRIME | SU-02 | SU-14 | VIDAR | FG-07 | FG-04

KTEK250 Stirrup leg holder - paediatric 113 kg clean

- Designed to support the leg of a patient placed in the lithotomy position.
- It is perfect for areas of gynaecology, urology, proctology, laparoscopy or robotic surgery.
- The shoe with a shape memory insole adapts to the patient's leg size.
- The patented design provides 22° more ROM compared to solutions from competitors.
- Unique access to pelvic region for robot-assisted procedures.
- Quick assembly and disassembly with Clip-On or other adaptors.
- Adjustable range of lithotomy position and movement locked by a single lever.
- Adjustable distance of the shoe from the operating table.
- No zones where fingers/hands could be crushed.



maximum load	113 kg
lithotomy position range	-55° / +85°
movement range	+25° / -9°
limb strap	silicone strap
boot lining	19 mm memory foam
assembly	accessory rails KTEK4200 or KTEK4610 or KTEK4720 mounting adaptor required

 HYPERION | OPTIMA 5.9, 5.12, 5.15, 5.20 | PRIME | SU-02 | SU-14 | VIDAR | FG-07 | FG-04

KTEK3100 Stirrup leg holder 159 kg clean

- Designed to support the leg of a patient placed in the lithotomy position.
- It is perfect for areas of gynaecology, urology, proctology, laparoscopy or robotic surgery.
- The shoe with a shape memory insole adapts to the patient's leg size.
- The patented design provides 22° more ROM compared to solutions from competitors.
- Unique access to pelvic region for robot-assisted procedures.
- Quick assembly and disassembly with Clip-On or other adaptors.
- Adjustable range of lithotomy position and movement locked by a single lever.
- Adjustable distance of the shoe from the operating table.
- No zones where fingers/hands could be crushed.



maximum load	159 kg
lithotomy position range	-55° / +85°
movement range	+25° / -9°
limb strap	silicone strap
boot lining	25 mm memory foam
assembly	accessory rails KTEK4200 or KTEK4610 or KTEK4720 mounting adaptor required

 HYPERION | OPTIMA 5.9, 5.12, 5.15, 5.20 | PRIME | SU-02 | SU-14 | VIDAR | FG-07 | FG-04

KTEK5100 Stirrup leg holder 227 kg clean

- Designed to support the leg of a patient placed in the lithotomy position.
- It is perfect for areas of gynaecology, urology, proctology, laparoscopy or robotic surgery.
- The shoe with a shape memory insole adapts to the patient's leg size.
- The patented design provides 22° more ROM compared to solutions from competitors.
- Unique access to pelvic region for robot-assisted procedures.
- Quick assembly and disassembly with Clip-On or other adaptors.
- Adjustable range of lithotomy position and movement locked by a single lever.
- Adjustable distance of the shoe from the operating table.
- No zones where fingers/hands could be crushed.



maximum load	227 kg
lithotomy position range	-55° / +85°
movement range	+25° / -9°
limb strap	silicone strap
boot lining	25 mm memory foam
assembly	accessory rails KTEK4200 or KTEK4610 or KTEK4720 mounting adaptor required

 HYPERION | OPTIMA 5.9, 5.12, 5.15, 5.20 | PRIME | SU-02 | SU-14 | VIDAR | FG-07 | FG-04



KTEK800 Stirrup leg holder – bariatric 363 kg clean

- Designed to support the leg of a patient placed in the lithotomy position.
- It is perfect for areas of gynaecology, urology, proctology, laparoscopy or robotic surgery.
- The shoe with a shape memory insole adapts to the patient's leg size.
- The patented design provides 22° more ROM compared to solutions from competitors.
- Unique access to pelvic region for robot-assisted procedures.
- Quick assembly and disassembly with Clip-On or other adaptors.
- Adjustable range of lithotomy position and movement locked by a single lever.
- Adjustable distance of the shoe from the operating table.
- No zones where fingers/hands could be crushed.



HYPERION | OPTIMA 5.9, 5.12, 5.15, 5.20 |
PRIME | SU-02 | SU-14 | VIDAR | FG-07
FG-04

maximum load	363 kg
lithotomy position range	-55° / +85°
movement range	+25° / -9°
limb strap	silicone strap
boot lining	25 mm memory foam
assembly	accessory rails KTEK4200 or KTEK4610 or KTEK4720 mo- unting adaptor required

KTEK4200 Mounting adaptor for stirrup leg holder

- Designed for mounting KTEK stirrup leg holders to the accessory rails of the operating tables.
- Mounted to Clip-On rail
- Easy mounting of the leg holder to the adaptor using one hand.
- Includes a knob that ensures stability.
- Protection against accidental removal.

assembly	accessory rails
size	EU (25x10 mm) (other availa- ble as option)



KTEK4610 Mounting adaptor for stirrup leg holder

- Designed for mounting KTEK stirrup leg holders to the accessory rails of the operating tables.
- Slide-On mounting.
- Easy mounting of the leg holder to the adaptor using one hand.
- Includes a knob that ensures stability.
- Can be sterilised in the autoclave.

assembly	accessory rails
size	EU (25x10 mm) (other availa- ble as option)

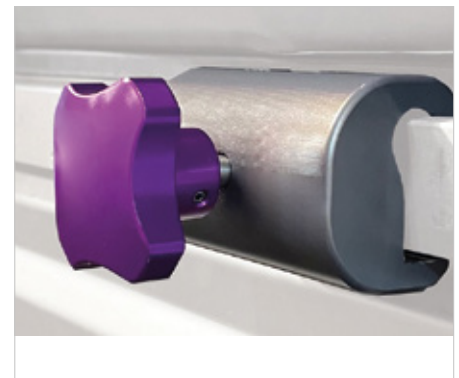

KTEK4710 Mounting adaptor for stirrup leg holder

- Designed for mounting KTEK stirrup leg holders to the accessory rails of the operating tables.
- Slide-On mounting.
- Easy mounting of the leg holder to the adaptor using one hand.
- Includes a knob that ensures stability.

assembly	accessory rails
size	EU (25x10 mm) (other availa- ble as option)







NEUROLOGICAL SURGERY

MINIMALLY INVASIVE SURGERY

Neurosurgery and minimally invasive surgery

Patient positioning using the KYRA CURVE FRAME for spinal surgery

The KYRA CURVE FRAME for spinal surgery was used to elevate the spine during posterior access surgery, providing maximum lordosis of the operated segment during, among others, laminectomy, decompression, intervertebral disc surgery or microdiscectomy procedures. An additional AS-76 carbon table top mounted in place of the standard operating table foot rests allows free interaction with the C-arm and 360° imaging over a length of 890 mm. Both the patient's arms and head are positioned using accessories with the FlexArm™ system with 3D adjustment in each axis.



RECOMMENDED SET OF ACCESSORIES	PREMIUM	BASIC
Head	AS-70.2 FlexArm™ special headrest AS-82 Adjustable headrest adaptor	AS-78.1 Single special headrest AS-82 Adjustable headrest adaptor
Hands	2 x AS-70.31 FlexArm™ arm support 2 x OA072 Arm pad 2 x AS-68 Carbon table top holder	2 x WS-07.5 Angle-adjustable arm support
Spinal elevation	KYRA CURVE FRAME	WS-65 Elevating mattress
Table top	AS-67 Carbon table top	Standard operating table top
Knee	EL130 gel positioner	EL130 gel positioner
Ankle joint	EL216 Gel half-roll	WS-66 Half-roll



AS-65 Accessory for spinal surgery with posterior access

- Designed for performing spinal surgery with posterior access.
- The thigh and buttock support system (side and back) prevents the patient from slipping during surgery and stabilises the operating field.
- Consists of kneeler, abdomen roll, buttock support and side supports.
- Made of electropolished stainless steel and HPL plastic (kneeler top).
- Kneeler and roll with polyurethane mattress, buttock support and side supports made of foam.
- Height and angle adjustment is possible on each component of the set.
- The rolls include a free rotation mechanism.

kneeler dimensions	500 x 338 x 45 mm
dimensions of abdomen roll	446 mm, Ø 105 mm
buttock support dimensions	482 mm, Ø 120 mm
side supports dimensions	205 x 105 x 40 mm
adjustment	angle, height and distance from patient
mattress	polyurethane, polyurethane foam
pivot	circular Ø 16 mm
assembly	- assembly rail, - integrated mounting adaptor (kneeler), - 4x mounting adaptor required

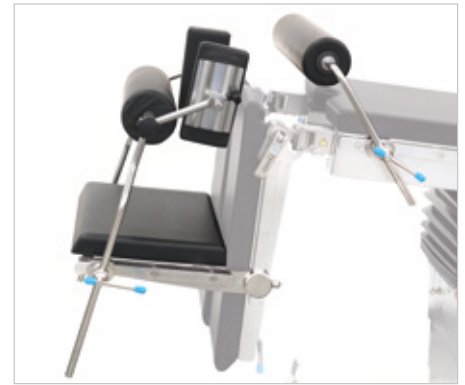

 OPTIMA 5.9, 5.12 | PRIME

AS-66 Carbon fibre extension

- Designed to extend the imaging window of the Famed FLARE table.
- Made entirely of x-ray-transparent carbon fibre.
- Tool-free assembly - slides onto the table top and is secured with integrated X-ray transparent clamps.
- 240 mm larger imaging window and 360° 3D imaging capability over a length of 1,702 mm (including Famed FLARE top).
- Polyurethane foam mattress included.

table top	552 x 350 x 35 mm
mattress	40 mm polyurethane foam, 540 x 240 mm
assembly	to table top, integrated mounting adaptor



 FLARE

AS-67 Carbon fibre table top

- Designed to extend the imaging window of operating tables.
- Enables minimally invasive surgery to be performed on a general surgical table.
- Made of carbon fibre with high X-ray transparency.
- 1,100 mm larger imaging window and 360° 3D imaging capability over a length of 890 mm.
- Two 160 mm long accessory rails and possibility to use additional InfiniMove™ accessory rails (AS-68).
- Comes with a mattress with quick assembly system - mattress thickness depends on the thickness of the operating table mattress.

table top dimension	1100 x 540 x 35 mm
mattress	40 mm or 80 mm polyurethane foam, 1,100 x 540 mm
assembly	wedges, integrated mounting adaptor



 HYPERION | OPTIMA 5.9, 5.12, 5.15, 5.20 | PRIME

WS-13.8 Storage and transport trolley for AS-67

- Designed for storing and transporting the AS-67 carbon table top together with the mattress.
- Made of electropolished stainless steel.
- Features a basket for storing accessories.
- 4 mounting slots in the base to store accessories with 16 mm mounting pivot.
- 4 castors with brakes ensure stability and easy manoeuvrability.

trolley dimensions	700 x 670 mm
basket dimensions	635 x 330 x 77 mm
castors	Ø 75 mm



WS-65 Elevating mattress

- Designed to elevate the patient's spine during surgery.
- Used for patients placed in prone position.
- Trapezoidal cut-out with space for patient's abdomen.
- Shaped space for the patient's head.
- The mattresses are made of antidecubitus polyurethane foam covered with waterproof fabric.
- Optional patient abdominal area filling available.

mattress dimensions	840 x 460 x 100 mm
cut-out dimensions	460 x 300 x 100 mm
mattress	polyurethane foam
transparency	X-ray transparent



AS-74 Filling mattress for WS-65 elevating mattress

- Serves as a filling for the WS-65 uplift mattress during spinal surgery with posterior access.
- Mattress with trapezoidal base.
- Provides stable support for the patient's body.
- The mattress is made of polyurethane foam with an antistatic and waterproof cover made of artificial leather.

dimensions	450 x 290 x 100 mm
mattress	polyurethane foam
assembly	in recess - WS-65
transparency	X-ray transparent

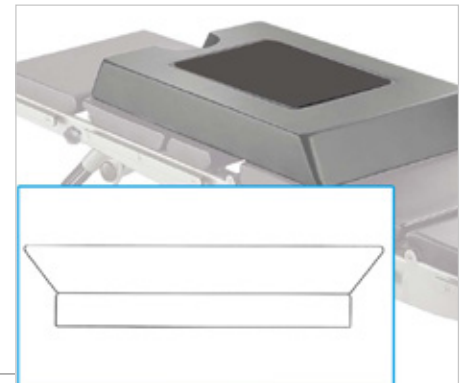

KTEK9000 Spinal surgery frame

- Used to elevate the spine during surgery with posterior access.
- Provides maximum lordosis of the operated segment during, among others, laminectomy, decompression, intervertebral disc surgery or microdiscectomy procedures.
- Polycarbonate base ensures X-ray transparency
- Carbon fibre plates covered with gel pads provide an elevation in the range of 225-295 mm.
- Infinitely adjustable elevation with an easy-to-use and removable crank.
- Adjustable spacing of pads ensures adequate space for the patient's abdomen - maximum spacing width is 180 mm.
- Mounted to accessory rails or directly to the table top with easy to disinfect silicone straps.

dimensions	762 x 444 x 254 mm
adjustment	polyurethane foam
max. load	272 kg
mattress	gel pads
assembly	accessory rail, table top,





AS-58.2 Accessory rail for carbon table top

- Designed for mounting additional accessories to the Famed FLARE table top or the AS-67 carbon fibre table top.
- The rail, which is lowered to the table top, makes it possible, among other things, to accommodate navigation devices.
- Made of aluminium alloy and electropolished stainless steel.
- Equipped with a 500 mm long accessory rail.
- Stable and secure mounting to the table top thanks to two handles with protection against accidental loosening.
- Safety features to prevent accessories from accidentally falling off.

rail length	500 mm
adjustment	longitudinal
assembly	directly on table top, integrated adaptor



AS-58.3 Holder

- Designed for mounting additional accessories to the end of the Famed FLARE table top.
- Made of aluminium alloy and electropolished stainless steel.
- Equipped with a standard 200 mm long accessory rail.
- Stable and secure mounting to the table top thanks to the clamping lever.
- Rail protection prevents accessories from falling out during use

rail length	140 x 88 mm
rail length	200 mm
assembly	directly on table top, integrated adaptor

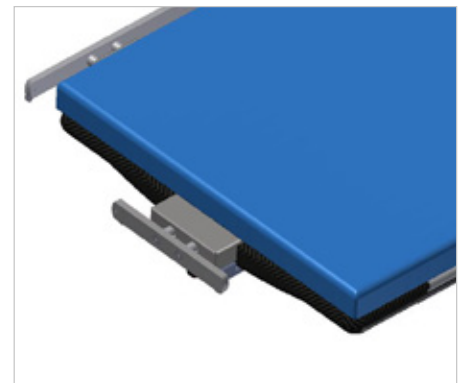

AS-68 Carbon table top holder

- Designed for mounting additional accessories to the Famed FLARE table top or the AS-67 carbon fibre table top.
- Made of aluminium alloy and electropolished stainless steel.
- Equipped with a standard 200 mm long accessory rail.
- Stable and secure mounting to the table top thanks to the clamping lever with protection against accidental loosening.
- Rail protection prevents accessories from falling out during use

dimensions	140 x 84 mm
rail length	200 mm
adjustment	longitudinal
assembly	directly on the table top integrated adaptor







POSITIONING OF THE
HEAD

Head positioning

Patient positioning using ophthalmologic table top

The patient's head is positioned using a table top designed for ophthalmology and ENT procedures. This comprehensive solution consists of a main table top, angle-adjustable headrest, hand support for the surgeon and a strap to secure the patient's head. Mounting the set in place of the standard operating table foot rests in configuration B allows the table top to be moved as far as possible towards the patient's head, providing the surgeon with adequate space. The Famed OPTIMA 5.20 operating table with the option to lower the table top to 550 mm from the floor allows the operator to work in a seated position.



RECOMMENDED SET OF ACCESSORIES	PREMIUM	BASIC
Head	AS-72 Ophthalmologic table top EL011 Head positioner for adults	AS-78.1 Single special headrest AS-82 Adjustable headrest adaptor
Hands	2 x AS-70.31 FlexArm™ arm support 2 x OA072 Arm pad	2 x PR-01.5 Arm support
Pelvis	WS-41.5 Abdominal restraint strap OA072 Gel pad	WS-41.5 Abdominal restraint strap
Torso	OAL030 Universal pad	OAL030 Universal pad
Knee	EL216 Half-roll	WS-66 Half-roll
Heels	EL130 Heel gel pad	EL130 Heel gel pad



AS-82 Adjustable special headrest adaptor

- Versatile design compatible with any Famed Żywiec operating table.
- Tool-free spacing adjustment.
- Suitable for use with headrests with a 25 x 25 mm square mounting pivots and two 25 mm round mounting pivots with 170 mm spacing between them.
- Made of electropolished stainless steel.

spacing adjustment	560 - 650 mm
assembly	to mounting rail, slide-on
assembly	accessory rails, integrated adaptors

▶ HYPERION | FLARE | OPTIMA | PRIME | SU-02 | SU-14 | VIDAR



AS-70.2 FlexArm™ special headrest

- Designed to support and position the head of a patient placed in supine position.
- Fully adjustable thanks to three rotating elements locked by a single knob.
- Allows lateral positioning of the head and lifting of the cervical spine.
- Consists of support arm and headrest with polyurethane mattress.
- Accessory strip for mounting additional equipment and attaching elements that support the head and tubes.
- Arm made of electropolished stainless steel.

dimensions	235 x 190 x 70 mm
adjustment	3 rotating elements, 3D in each axis
pivot	square 20 x 20 mm
mattress	polyurethane
assembly	AS-82 headrest adaptor required

▶ HYPERION | FLARE | OPTIMA 5.9, 5.12, 5.15, 5.20 PRIME | SU-02 | SU-14* | VIDAR



AS-70.7 FlexArm™ special headrest

- Designed to support and position the head of a patient placed in supine position.
- Fully adjustable thanks to three rotating elements locked by a single knob.
- Allows lateral positioning of the head and lifting of the cervical spine.
- The folding side rails of the helmet allow a single headrest to be used during anaesthesia and surgery.
- Easily removable padding inside the helmet protects the patient's head.
- The helmet's design allows the fitting of face stabilising straps or a special mask with holes for tubes.

dimensions	267 x 594 mm
adjustment	3 rotating elements, 3D in each axis
pivot	square 20 x 20 mm
mattress	polyurethane foam
assembly	AS-82 headrest adaptor required or mounted directly to AS-77 or AS-80

▶ HYPERION | FLARE | OPTIMA 5.9, 5.12, 5.15, 5.20 PRIME | SU-02 | SU-14* | VIDAR | AS-77 | AS-80

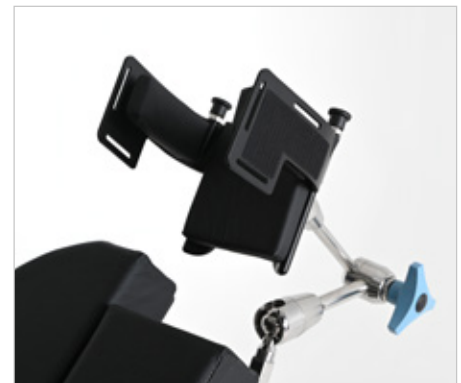

WS-22.5 Arm support

- Designed to support the hands of a surgeon working in a sitting or standing position behind the patient's head.
- The support structure made of stainless steel provides adequate stability.
- Consists of two arms with joints for adjustment and a polyurethane support in the shape of a semicircle.
- Adjustable height and angle of support.

support dimensions	325 x 400 mm
adjustment	height, angle
pivot	circular, Ø 16 mm
mattress	60 mm polyurethane
assembly	accessory rail, 2x mounting adaptor required

▶ HYPERION | FLARE | OPTIMA 5.9, 5.12, 5.15, 5.20 PRIME | SU-02 | SU-14 | VIDAR



AS-78 Special headrest frame with 3 rotating elements

- Universal arm with interchangeable headrests for supporting and positioning the patient's head.
- Mounting of the headrests to the arm using a mounting rail with clamping device.
- Arm made of electropolished stainless steel.
- Three rotating elements, locked with knobs, allow adjustment of the length, height relative to the table top, and angle of the headrest.
- Consists of a 162 mm long mounting rail and three 136 mm, 136 mm and 61 mm long movable arms.
- The 180 mm long decentralised mounting rail allows for the installation of interchangeable headrests and additional equipment.
- Arm compatible with headrests: AS-78.1, AS-78.2, AS-78.3, AS-78.5, AS-78.6.

total length	495 mm
adjustment	length, height, angle
pivot	square, 20 mm x 20 mm
assembly	AS-82 headrest adaptor or mounting hole 20x20 mm required



 HYPERION | FLARE | OPTIMA 5.9, 5.12, 5.15, 5.20 | PRIME
 | SU-02 | SU-14* | VIDAR | AS-77 | AS-80

AS-78.1 Single special headrest

- Exchangeable headrest for the AS-78 universal headrest arm.
- Designed to support and position the head of a patient placed in supine and prone position.
- It includes a horseshoe-shaped polyurethane mattress with straps for stabilisation.
- Quick mounting ensured by a dedicated clamp-on adaptor.

dimensions	235 x 190 x 70 mm
mattress	polyurethane
assembly	to AS-78 universal arm

 AS-78



AS-78.2 Special split headrest - shaped

- Exchangeable headrest for the AS-78 universal headrest arm.
- Designed to support and position the head of a patient placed in supine, prone or lateral position.
- It consists of two horseshoe-shaped polyurethane mattresses with adjustable spacing.
- Provides a large amount of space for the anaesthesia mask, endotracheal tubes or other anaesthesia equipment.
- Quick mounting ensured by a dedicated clamp-on adaptor.

dimensions	180 x 190 x 90 mm
mattress	polyurethane
assembly	to AS-78 universal arm

 AS-78



AS-78.3 Special split headrest - flat

- Exchangeable headrest for the AS-78 universal headrest arm.
- Designed to support and position the head of a patient placed in supine, prone or lateral position.
- Consists of two split flat horseshoe-shaped mattresses.
- Quick assembly and disassembly of mattresses using the hook&loop system.
- Provides a large amount of space for the anaesthesia mask, endotracheal tubes or other anaesthesia equipment.
- Quick mounting ensured by a dedicated clamp-on adaptor.

mattress dimensions	80 x 249 mm (each)
mattress	60 mm polyurethane foam
assembly	to AS-78 universal arm

 AS-78



* does not require a headrest adaptor



AS-78.5 Panel headrest

- Exchangeable headrest for the AS-78 universal headrest arm.
- Designed to support and position the head of a patient placed in supine, prone or lateral position.
- Includes a rectangular-shaped polyurethane mattress with head stabilising straps.
- Easy assembly and disassembly of the mattress with pins.
- Quick mounting ensured by a dedicated clamp-on adaptor.

headrest dimensions	240 x 170 mm
mattress	50 mm polyurethane
assembly	to AS-78 universal arm



AS-78.6 Special headrest – helmet

- Exchangeable headrest for the AS-78 universal headrest arm.
- Designed to support and position the head of a patient placed in supine position.
- The folding side rails of the helmet allow a single headrest to be used during anaesthesia and surgery.
- Easily removable padding inside the helmet protects the patient's head.
- The helmet's design allows the fitting of AS-77.12, AS-77.13, AS-77.6 face stabilising straps or a special mask with holes for AS-77.1 tubes.

helmet size	universal
mattress	polyurethane foam
assembly	to AS-78 universal arm



SG-10.11 headrest with double elevation

- Designed to support the head of a patient placed in supine, prone or lateral position.
- The double elevation with an additional rotating elements allows the spine to be raised or the patient's head pads to be replaced.
- Made of electropolished stainless steel with HPL plastic top.
- Quick assembly and disassembly of the mattress with pins.
- Double lever supported by gas springs allows the headrest to be adjusted to a convenient position.
- Additional accessory rails.

dimensions	270 mm x 500 mm
adjustment	angle of both table tops
mattress	40 mm polyurethane or 80 mm foam
assembly	wedge, integrated mounting adaptor



SG-15.15 headrest with double elevation

- Designed to support the head of a patient placed in supine, prone or lateral position.
- The double elevation with an additional rotating elements allows the spine to be raised or the patient's head pads to be replaced.
- Made of electropolished stainless steel with a carbon fibre table top.
- Quick assembly and disassembly of the mattress using the hook&loop system.
- Double lever supported by gas springs allows the headrest to be adjusted to a convenient position.
- Additional accessory rails.

dimensions	254 x 545 mm
mattress	80 mm polyurethane foam
adjustment	angle of both table tops
assembly	wedge, integrated mounting adaptor



AS-72 Ophthalmologic table top

- Designed to support the patient's head during ENT and ophthalmology procedures.
- Consists of a shaped table top, a dedicated headrest, stabilising straps and a support for the surgeon's hands.
- Polyurethane foam mattress with a thickness of 40 or 80 mm - depending on the operating table model.
- Gas spring-assisted headrest angle adjustment of +47° / -23°, headrest extension 70 mm.
- Support for the surgeon's hands with adjustable height (40-230 mm) and distance from the headrest (0-150 mm).
- Mounting on wedges on the foot rests allows the angle to be adjusted using the remote control*.
- The cut-out of the main table top allows easy access to the patient, both from the head and leg side.
- Adjustable spacing allows mounting on most Famed Żywiec tables.
- Can be fitted with alternative headrests giving the option to place the patient in the prone position.
- Maximum working load 40 kg.



main table top dimension	494 x 300 mm
headrest dimensions	200 x 255 mm
total length	700 mm
adjustment	extension, angle, height
mattress	40 mm / 80 mm polyurethane foam
assembly	wedges, integrated mounting adaptor

 HYPERION* | OPTIMA 5.9, 5.12, 5.15*, 5.20* | PRIME | SU-02

AS-86 Angle-adjustable headrest

- Designed to support the head of a patient placed in supine or prone position.
- Made of electropolished stainless steel with an X-ray-transparent HPL table top.
- Adjustment of the headrest angle in the range + 90° / - 90°.
- The absence of steel components across a width of 550 mm and a length of 310 mm allows X-ray imaging.
- Two types of horseshoe-shaped mattresses to choose from: full and open.
- Mounted to a Famed FLARE table top or AS-67 carbon table top using AS-68 accessory rails.

dimensions	425 x 730 mm
adjustment	table top angle
mattress	polyurethane foam 230 x 270 x 40 mm
assembly	2x AS-68 accessory rails required

 FLARE | AS-67



WS-88.5 Roller lift

- Designed for traction of the patient's cervical vertebrae.
- Allows to suspend the load regulating the tension force
- Made of electropolished stainless steel.
- Consists of a locking arm with mounting adaptor and roll.

length	320 mm
adjustment	arm angle
assembly	accessory rails, integrated mounting adaptor

 HYPERION | OPTIMA 5.9, 5.12, 5.15, 5.20 | PRIME | SU-02 | VIDAR



* does not require the use of AS-82 headrest adaptor



HORSESHOE HEADREST

Horseshoe-shaped headrest for non-invasive positioning of the patient's head

A high-quality headrest designed for non-invasive positioning of the patient's head. Horizontal and vertical adjustment allows for the correct positioning on the operating table. The range includes horseshoe-shaped headrests designed for both adult and paediatric patients, as well as those for procedures requiring intraoperative imaging.

Multiple configurations

The universal design allows the system to be combined with the head clamp and adaptor of the invasive cranial stabilisation systems QR3 Headrest System Aluminium and LUCENT® Headrest System. Available in various configurations, the systems provide optimal conditions for neurosurgical procedures. The interchangeable gel pads for paediatric and adult patients can be mounted alternately to the same headrest base - either transparent or aluminium. Optionally, the system can be fitted with an extension frame for traction application.

Comfort

The lightweight and simple aluminium or transparent polymer structure ensures easy and problem-free installation of the Famed Żywiec operating table headrest. Removing the gel pads saves the time of medical staff needed for disinfection. The rotating adaptor provides the doctor with the option of adjusting the position of the headrest to their needs, ensuring maximum comfort during the procedure.

Safety

The gel pads, which adapt to the shape of the patient's head, provide comfort during many hours of surgery and protect the tissues at the compression point. The system, made of high-quality materials, works perfectly with Famed Żywiec operating tables, which have stable support points, guaranteeing stability and safety during precise neurosurgical procedures.



QR3 HEADREST SYSTEM

Aluminium cranial stabilisation system suitable for disinfection using autoclave

The QR3 Headrest System is a comprehensive system designed for cranial surgery requiring high quality instruments for precision and safety. Disposable or reusable pins for paediatric or adult patients hold the skull in the required position. The high quality, aluminium structure makes the QR3 the most preferred cranial stabilisation system on the market.

Safety

The stable structure made of high-quality aluminium guarantees maximum safety during operations performed on Famed Żywiec operating tables. Stainless steel pins ensure precise, secure and rigid fixation of the skull. The QR3 Headrest System allows the patient to be positioned in the abdominal, supine and lateral positions, as well as in the sitting position.

Mix & Match

Mix & Match technology allows the non-transparent elements of the attachment to be combined with Radiolucent products. Fitting a transparent cranial clamp and a transparent adaptor provides full control over the results of head and cervical spine surgery enabling intraoperative imaging.

Convenience

Two rotating adaptors facilitate the positioning of the cranium in a convenient position for the physician. The Famed AS-82 headrest adaptor provides a smooth installation of the attachment to the operating table (it is also possible to use an adaptor from DORO®). The simple and lightweight design improves disinfection and the Quick Rail® technology allows for easy attachment of accessories. Famed Żywiec operating tables offer the possibility to lower the table top to a level that ensures the physician's comfort during many hours of operations even in a sitting position.



THE SET INCLUDES

1001.001	DORO® QR3 Skull Clamp
3002-00	DORO® Swivel Adaptor
3001-00	DORO® Adjustable Base Unit

LUCENT® Headrest System

Transparent cranial stabilisation system for intraoperative imaging

The LUCENT® Headrest System is a fully transparent system used for, among other things, cranial stabilisation during cervical spine surgery. The steel-free cranial clamp supports angiography, fluoroscopy, CT, cranial surgery and C-spine surgery.

New treatment options

LUCENT®'s unique transparent design is perfect for procedures requiring intraoperative imaging with X-ray, angiography or CT. The transparent interfaces connecting the cranial clamp to the base allow imaging of both the cervical spine and the patient's skull. Titanium polymer pins reduce artefacts to a minimum, improving the quality of images taken during surgery regardless of the treatment site. The long extension arm allows the patient to be moved away from the edge of the operating table, providing more space for the camera.

Comfort

The rotating adaptor allows the position of the cranial clamp to be adjusted to the desired location within a 360° range. The transparent Quick-Rail® base allows the system to be quickly and securely mounted to the operating table. Famed Żywiec tables also allow LUCENT® to be mounted on a table top made entirely of carbon fibre (or a suitable carbon adaptor), which increases the operating field by up to 1,900 mm (this range should also be increased by the reach of the attachment itself, which depends on the chosen configuration).

Safety

The system made of high-quality materials guarantees stable and safe performance of surgical procedures. Stable Famed Żywiec table bases guarantee full compatibility with DORO® accessories even when the table top is in extreme positions. Disposable titanium-polymer pins significantly reduce the number of artefacts during imaging, allowing for shorter procedure times and lower X-ray doses.



THE SET INCLUDES	
3034-00	DORO® Skull Clamp Radiolucent
3033-00	DORO® Swivel Adaptor Radiolucent
1101.026	DORO LUCENT® Transitional Member
1101.026	DORO LUCENT® Locking Transitional Member
1101.021	DORO® Lucent Base Unit Standard

TEFLON® Headrest System

Teflon cranial stabilisation system suitable for cleaning using autoclave

The QR3 Teflon® Headrest System is a Teflon-coated system for neurosurgery operations designed with the comfort of doctors and the safety of patients in mind. The Teflon layer allows the set to be placed in a washer/autoclave. It is a complete head support system that is compatible with the Infection Control Guidelines created by the WHO. Quick-Rail® technology allows for easy mounting of accessories.

Ease of navigation

The ease of use of the QR3 Headrest System Teflon® allows the system to be used to its maximum potential during neurosurgery operations lasting many hours. The rotating adaptor allows the position of the cranial clamp to be adjusted to the desired location within a 360° range. Height adjustment during surgery is provided by a single lever mounted in the base.

Mix & Match

Mix & Match technology allows the non-transparent elements of the attachment to be combined with Radiolucent products. Fitting a transparent cranial clamp and a transparent adaptor provides full control over the results of head and cervical spine surgery enabling intraoperative imaging.

Safety and hygiene

The Teflon layer allows autoclave sterilisation and ensures maximum safety during surgery for patients at high risk of infection. Choosing DORO® TEFLON® in a set with the Famed Żywiec operating table guarantees a high level of protection against infection in the operating theatre and room. The combination of this equipment with IntelliProtect™ technology, which we use in our tables, guarantees the best level of safety and infection spread prevention on the market.

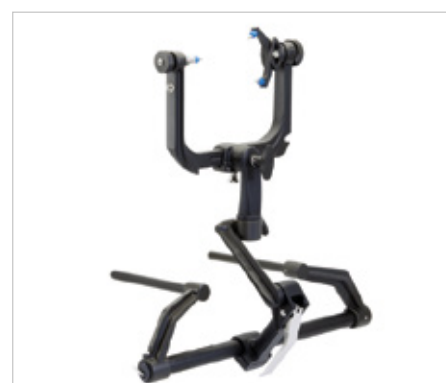

THE SET INCLUDES	
3003-009	DORO® QR3 Skull Clamp Teflon®
3002-009	DORO® Swivel Adaptor Teflon®
3001-009	DORO® Adjustable Base Unit Teflon®



CONFIGURATION A IMAGING OF THE CERVICAL SPINE

An ideal combination of cervical spine imaging capability and favourable price.

Part of the set	Index
QR3 Skull Clamp	1001.001
LUCENT® Base Unit	1101.021
LUCENT® Locking Transitional Member	1101.031
LUCENT® Transitional Member	1101.026
Swivel Adaptor Radiolucent	3033-00
Interface Skull Clamp Aluminium	3033-51



CONFIGURATION B IMAGING OF THE SKULL AND CERVICAL SPINE

Set to ensure compatibility of cranial and cervical spine procedures using CT, Angiography, Fluoroscopy techniques.

Part of the set	Index
Base Unit Aluminium	3001-00
Transitional Member Radiolucent	3032-00
Swivel Adaptor Radiolucent	3033-00
Skull Clamp Radiolucent	3034-00
Adaptor for table-top mounting (Famed Żywiec)	AS-82
Adaptor for table-top mounting (DORO®)	3011-00



CONFIGURATION C CRANIAL IMAGING

Set to ensure compatibility of cranial procedures using C-arm imaging, Angiography or Fluoroscopy techniques.

Part of the set	Index
Base Unit Aluminium	3001-00
Swivel Adaptor Aluminium	3002-00
Interface Skull Clamp Radiolucent	3033-50
Skull Clamp Radiolucent	3034-00
Adaptor for table-top mounting (Famed Żywiec)	AS-82
Adaptor for table-top mounting (DORO®)	3011-00

Base Unit Park Bench

- Set designed to place the patient in the lateral position during procedures using the QR3 Headrest System (1001.100).
- Increased stability during surgery due to the ability to position the hand below the level of the operating table top.
- Safe and comfortable positioning.
- Design to ensure maximum stability.
- Change of setting with a single lever.
- Adjustable across the width of the base.
- Mounted to the side rail with the required adaptor.



Crossbar adaptor (3007-00)

- Designed for positioning the patient's head in the sitting position using the DORO® system.
- Allows the DORO® base to be mounted to the operating table for better access to the head and cervical spine.
- Perfectly compatible with operating tables with a back section adjusted with a remote control.
- Mounted to the accessory rails of the operating table
- 2x mounting adaptor required.



Cervical Spine Support (3012-00)

- Designed for cervical spine surgery procedures.
- Allows the cervical vertebrae to be elevated.
- Mounted on the Doro® accessory rail adaptor 3011-00 with integrated clamping adaptors.



DORO® Side Rail OR Table Adaptor (3011-00)

- Enables mounting of the DORO® system and accessories to the operating table.
- Mounts to the accessory rails of the operating table.
- Adjustable adaptor spacing allows the width to be adapted to the width of the operating table.



Skull fixing pins



Reusable pins:

- stainless steel (adult 3005-00, paediatric 3004-00),
- titanium for imaging (adult 3005-50, paediatric 3004-50).



Disposable pins (set contains 36 pieces)

- stainless steel (adult 3006-00 or 3006-50, paediatric 3006-10),
- titanium for imaging (adult 3006-20, paediatric 3006-30).



POSITIONING OF THE
UPPER LIMB

Upper limb positioning

Patient positioning using the hand surgery table top

The hand surgery table top provides support for the patient's upper limb during procedures involving the arm, forearm or hand. The table top is made of X-ray-transparent carbon fibre or HPL and the space between the table top and the floor ensures perfect interaction with the C-arm. Cut-outs in the table top provide adequate space for the surgeon and shorten the distance from the operated limb. The support under the table top ensures stability and provides hand support for the operator during procedures performed in a sitting position.



RECOMMENDED SET OF ACCESSORIES	PREMIUM	BASIC
Head	EL011 Head positioner for adults	EL011 Head positioner for adults
Hands	Hand surgery table top AS-69.1 FlexArm™ arm support AS-70.31 2 x OA072 Arm pad	Hand surgery table top AS-69 Arm support PR-01.5
Pelvis	WS-41.5 Abdominal restraint strap OA072 Gel pad	WS-41.5 Abdominal restraint strap
Torso	OAL030 Universal pad	OAL030 Universal pad
Knee	EL216 Half-roll	WS-66 Half-roll
Heels	EL130 Heel gel pad	EL130 Heel gel pad



AS-69 Carbon fibre hand surgery table top

- Designed to support the patient's hand during surgery.
- Table top made of X-ray-transparent carbon fibre.
- Folding support with height-adjustable foot for improved stability.
- Polyurethane foam mattress with quick and easy hook&loop mounting system.
- Adjustable height allows the height of the table top with mattress to be matched to the level of the table mattress.
- Cut-outs in the table top ensure adequate space for the surgeon.

dimensions	305 x 810 mm
adjustment	height
mattress	30 mm polyurethane foam
assembly	accessory rail, mounting adaptor required

▶ HYPERION | FLARE | OPTIMA 5.9, 5.12, 5.15, 5.20 | PRIME | SU-02 | SU-14 | VIDAR



AS-69.1 Hand surgery table top

- Designed to support the patient's hand during surgery.
- Table top made of X-ray-transparent HPL.
- Folding support with height-adjustable foot for improved stability.
- Polyurethane foam mattress with quick and easy hook&loop mounting system.
- Adjustable height allows the height of the table top with mattress to be matched to the level of the operating table mattress.
- Cut-outs in the table top ensure adequate space for the surgeon and improve access to the operated limb.

dimensions	500 x 780 mm
adjustment	height
pivot	square, 16 x 16 mm
mattress	30 mm polyurethane foam
assembly	accessory rail, mounting adaptor required

▶ HYPERION | FLARE | OPTIMA 5.9, 5.12, 5.15, 5.20 | PRIME | SU-02 | SU-14 | VIDAR



AS-70.31 FlexArm™ arm support

- Designed to support the hand of the patient lying in a prone, supine and lateral position.
- Fully adjustable thanks to three rotating elements locked by a single knob.
- Option to position the support above the patient.
- Consists of a movable arm, HPL table top with polyurethane foam mattress and straps.
- Arm made of electropolished stainless steel.
- Quick and easy assembly and disassembly of the mattress using the hook&loop system.

dimensions	150 x 500 mm
arm	max. length: 465 mm
load	max. 10 kg
mattress	50 mm foam
adjustment	3 rotating elements, 3D in each axis
assembly	accessory rail, integrated mounting adaptor

▶ HYPERION | FLARE | OPTIMA 5.9, 5.12, 5.15, 5.20 | PRIME | SU-02 | SU-14 | VIDAR



AS-70.42 FlexArm™ arm support

- Designed to support the hand of the patient lying in a prone, supine and lateral position.
- Fully adjustable thanks to three rotating elements locked by a single knob.
- Option to position the support above the patient.
- Consists of a movable arm, a C-shaped support finished with a polyurethane mattress and straps for stabilisation.
- Arm made of electropolished stainless steel.

dimensions	160 x 380 mm
arm	max. length: 465 mm
load	max. 10 kg
mattress	polyurethane, 24 mm
adjustment	3 rotating elements, 3D in each axis
assembly	accessory rail, integrated mounting adaptor

▶ HYPERION | FLARE | OPTIMA 5.9, 5.12, 5.15, 5.20 | PRIME | SU-02 | SU-14 | VIDAR



PR-01.6 Arm support

- Designed to support the hand of a patient lying in a supine, prone or lateral position.
- Support structure made of electropolished stainless steel.
- Polyurethane foam mattress.
- Gas spring supports the angular inclination adjustment of the support.
- Integrated mounting adaptor allows the support to rotate about its own axis by 180°
- Mounting straps for hand stabilisation.

dimensions	160 x 500 mm
adjustment	inclination angle, rotation around own axis
mattress	polyurethane foam, 50 or 80 mm
assembly	accessory rail, integrated mounting adaptor

HYPERION | OPTIMA 5.15, 5.20 | SU-14 | VIDAR



PR-01.5 Arm support

- Designed to support the hand of a patient lying in a supine, prone or lateral position.
- Support structure made of electropolished stainless steel.
- C-shaped polyurethane mattress.
- The adaptor required for mounting allows the stand to rotate about its own axis by 180°
- Mounting straps for hand stabilisation.

dimensions	160 x 500 mm
adjustment	rotation around its axis
mattress	polyurethane, 24 mm
assembly	accessory rail, integrated mounting adaptor

HYPERION | FLARE | OPTIMA 5.9, 5.12, 5.15, 5.20 | PRIME | SU-02 | SU-14 | VIDAR



WS-07.5 Angle-adjustable arm support

- Designed to support the hand of a patient lying in a supine, prone or lateral position.
- Support structure made of electropolished stainless steel.
- Consists of an arm with a lowered accessory rail and a support on a steel pivot with polyurethane mattress and straps for stabilisation.
- The arm allows the support to rotate about its vertical axis by 360°.
- Adjustment of the height of the support and the angle of the mattress.

dimensions	160 x 380 mm
pivot	circular, Ø 16 mm
mattress	polyurethane, 24 mm
adjustment	height, inclination angle, rotation around own axis
assembly	accessory rail, integrated mounting adaptor

HYPERION | FLARE | OPTIMA 5.9, 5.12, 5.15, 5.20 | PRIME | SU-02 | SU-14 | VIDAR



AS-10.0 Arm support with angle adjustment

- Designed to support the hand of the patient lying in a prone, supine or lateral position.
- Consists of a swivel arm with a lowered accessory rail, a pivot with the support table top, mattress, and straps for stabilisation.
- Made of electropolished stainless steel.
- Support table top made of HPL
- Quick assembly and disassembly of the mattress thanks to the hook&loop system.
- The pivot with the special-shaped polyurethane foam mattress is angle-adjustable, height-adjustable and allows rotation around its own axis.
- The arm allows the support to be moved sideways by 360°.

mattress	80 mm polyurethane foam, 250 x 380 mm
adjustment	height, inclination angle, abduction, rotation around axis
pivot	circular, Ø 18 mm
assembly	accessory rail, integrated mounting adaptor



HYPERION | OPTIMA 5.15, 5.20 | SU-14 | VIDAR



AS-15 Arm support

- Designed to support the hand of a patient lying in a supine, prone or lateral position.
- Consists of a short pivot made of electropolished stainless steel, support table top made of HPL, mattress with cut-outs made of polyurethane foam, and straps for stabilisation.
- Support structure with mounting adaptor allows the support to rotate around its own axis.
- Easy and quick assembly and disassembly of the mattress using the hook&loop system.

dimensions	200 x 600 mm
adjustment	rotation around its axis
pivot	circular, Ø 18 mm
mattress	50 mm polyurethane foam
assembly	accessory rail, mounting adaptor required

 HYPERION | FLARE | OPTIMA 5.9, 5.12, 5.15, 5.20 | PRIME | SU-02 | SU-14 | VIDAR



AS-28.1 Carbon fibre arm support

- Designed to support the hand of a patient lying on the Famed FLARE medical imaging table.
- Consists of two mounting adaptors, a carbon fibre table top and a polyurethane foam mattress.
- Imaging window along the full length of the table top.
- Carbon fibre table top with high X-ray transparency.
- Cut-outs on both sides of the support provide adequate space for the surgeon.

dimensions	305 x 743 mm
adjustment	longitudinal
mattress	60 mm polyurethane foam
assembly	to the table top, integrated mounting adaptors

 FLARE



AS-87 Elbow arthroscopy support

- Used to support the arm of a patient lying in a prone position during elbow arthroscopy.
- Allows the elbow joint to maintain 90° flexion when the forearm is hanging down
- Consists of a support structure ending in a horseshoe-shaped support made of electropolished stainless.
- Mattress made of polyurethane foam.
- Adjustable height, inclination angle of the support structure and rotation of the support around its own axis.

dimensions	156 x 100 mm
pivot	circular, Ø 18 mm
adjustment	height and inclination angle, rotation of support around its axis, distance from table top
mattress	20 mm polyurethane foam
assembly	accessory rails, mounting adaptor required

 HYPERION | FLARE | OPTIMA 5.9, 5.12, 5.15, 5.20 | PRIME SU-02 | SU-14 | VIDAR







POSITIONING OF THE
LOWER LIMB

Lower limb positioning

Patient positioning using the attachment for knee arthroscopy

The patient's lower limb is positioned using the AS-88 attachment for knee arthroscopy, which allows procedures to be performed on this joint in the "figure-of-four" position.



RECOMMENDED SET OF ACCESSORIES	PREMIUM	BASIC
Head	EL011 Head positioner for adults	EL011 Head positioner for adults
Hands	Hand surgery table top AS-69.1 FlexArm™ arm support AS-70.31 2 x OA072 Arm pad	Hand surgery table top AS-69 Arm support PR-01.5
Pelvis	WS-41.5 Abdominal restraint strap OA072 Gel pad	WS-41.5 Abdominal restraint strap
Torso	OAL030 Universal pad	OAL030 Universal pad
Knee	EL216 Half-roll	WS-66 Half-roll
Heels	EL130 Heel gel pad	EL130 Heel gel pad



AS-21 Foot supports

- Provide solid support for the patient's feet during procedures requiring the anti-Trendelenburg position.
- Made of electropolished stainless steel with polyurethane foam mattresses.
- A set of clamps makes it possible to adjust the support spacing, and mounting to the accessory rail allows longitudinal adjustment.
- The set includes a right and left support.

dimensions	245 x 205 mm
adjustment	spacing, longitudinal
mattress	40 mm polyurethane foam
assembly	accessory rail, integrated mounting adaptor

 HYPERION | OPTIMA 5.9, 5.12, 5.15, 5.20 | PRIME | SU-02 | SU-14 | VIDAR



AS-35 Panel foot rest

- A one-piece foot rest designed to support the lower limbs of a patient placed in a prone, supine or lateral position.
- Support structure made of lacquered steel with HPL filling and polyurethane foam mattress.
- Easy and quick assembly and disassembly of the mattress using the hook&loop system.
- X-ray-transparent foot rest filling
- Gas spring-assisted foot rest angle adjustment of + 30°/- 90°.
- Accessory rails for mounting equipment.

dimensions	600 x 595 mm
adjustment	inclination angle
mattress	50 mm polyurethane foam
assembly	wedges, integrated mounting adaptor

 VIDAR



AS-63.6 Leg rest

- Designed to support lower limbs during patient transport or prior to placing lower limbs in supports or stirrups.
- Lightweight frame construction made of electropolished stainless steel.
- It consists of a frame with a cover stretched over it and a polyurethane foam mattress.
- The cover has a zip for easy removal and disinfection.

dimensions	710 x 560 mm
mattress	50 mm polyurethane foam
assembly	to accessory rail, integrated mounting bracket

 OPTIMA 5.9, 5.12 | PRIME | SU-02



AS-63.7 Leg rest

- Designed to support lower limbs during patient transport or prior to placing lower limbs in supports or stirrups.
- Lightweight frame construction made of electropolished stainless steel.
- It consists of a frame with a cover stretched over it and a polyurethane foam mattress.
- Easy to disinfect cover stretched over the foot rest frame.

dimensions	710 x 645 mm
mattress	80 mm polyurethane foam
assembly	to an accessory rail, integrated mounting bracket

 HYPERION



AS-63.8 Leg rest

- Designed to support lower limbs during patient transport or prior to placing lower limbs in supports or stirrups.
- Lightweight frame construction made of electropolished stainless steel.
- It consists of a frame with a cover stretched over it and a polyurethane foam mattress.
- The cover has a zip for easy removal and disinfection.

dimensions	710 x 625 mm
mattress	80 mm polyurethane foam
assembly	to an accessory rail, integrated mounting bracket

 OPTIMA 5.15, 5.20



SG-42.6 Panel foot rest

- A one-piece foot rest designed to support the lower limbs of a patient placed in a prone, supine or lateral position.
- Support structure made of electropolished stainless steel with HPL filling and mattress.
- Easy and quick assembly and disassembly of the mattress facilitates disinfection.
- X-ray-transparent foot rest filling
- Gas spring-assisted foot rest angle adjustment.
- Accessory rails for mounting equipment.

dimensions	615 x 498 mm
adjustment	inclination angle
mattress	40 mm polyurethane
assembly	wedges, integrated mounting adaptor

 OPTIMA 5.9, 5.12 | PRIME | SU-02



SG-42.7 Panel foot rest

- A one-piece foot rest designed to support the lower limbs of a patient placed in a prone, supine or lateral position.
- Support structure made of electropolished stainless steel with carbon fibre filling and mattress.
- Easy and quick assembly and disassembly using the hook&loop system.
- X-ray-transparent foot rest filling
- Adjustment of the foot rest angle using the remote control from + 35° / - 90°.
- Accessory rails for mounting equipment.

dimensions	566 x 500 mm
adjustment	inclination angle
mattress	80 mm polyurethane foam
assembly	wedges, integrated mounting adaptor

 HYPERION



SG-42.8 Panel foot rest

- A one-piece foot rest designed to support the lower limbs of a patient placed in a prone, supine or lateral position.
- Constructed of electropolished stainless steel with HPL filling and polyurethane foam mattress.
- Easy and quick assembly and disassembly with the mFix™ system.
- X-ray-transparent foot rest filling
- Adjustment of the foot rest angle using the remote control from + 30° / - 90° and additional angle adjustment by means of a gas spring.
- Accessory rails for mounting equipment.

dimensions	580 x 550 mm
mattress	80 mm polyurethane foam
adjustment	inclination angle
assembly	wedges, integrated mounting adaptor

 OPTIMA 5.15, 5.20





SG-15.9 Foot rests with cut-outs

- Designed to support the lower limbs of a patient lying in a prone or supine position.
- Cut-outs in the patient's groin area make more space available to the surgeon during abduction.
- Cut-outs in the patient's groin area make more space available to the surgeon in case of abduction.
- Angle adjustment of foot rests using a remote control + 35° / - 90°, manual lateral abduction 0°-180°.
- Easy assembly and disassembly of mattresses using the hook&loop system.
- Rails for mounting equipment.

dimensions	608 x 272 mm
cut-out	at an angle of 35°
mattress	80 mm polyurethane foam
adjustment	inclination angle, abduction
assembly	wedges, integrated mounting adaptor

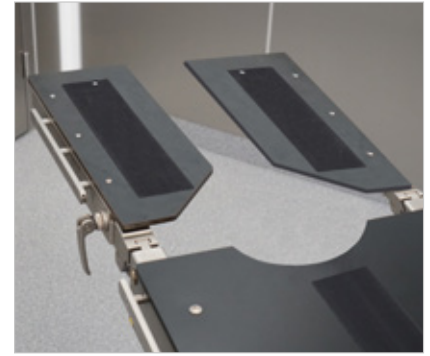

 HYPERION

SG-43.1 Double abduction foot rests

- Designed to support the lower limbs of a patient placed in a prone or supine position.
- Two pivot points locked by a single lever allow double lateral abduction.
- Ideal for procedures in gynaecology, urology and proctology.
- Generous space in the groin area and easy access to the operated area due to the double abduction and cut-outs.
- Construction in electropolished stainless steel with HPL infill and polyurethane mattress.
- Footrest top transparent for X-rays.
- Angle adjustment possible on tables with leg section adjustment from the remote control.

mattress dimensions	236 x 615 mm
mattress	50 mm polyurethane
adjustment	abduction
assembly	wedges, integrated mounting adaptor



 OPTIMA 5.9, 5.12 | PRIME | SU-02

SG-43.2 Double abduction foot rests

- Designed to support the lower limbs of a patient placed in a prone or supine position.
- Two pivot points locked by a single lever allow double lateral abduction.
- Foot rest inclination angle adjustment using the remote control.
- Ideal for procedures in gynaecology, urology and proctology.
- Generous space in the groin area and easy access to the operated area due to the double abduction and cut-outs.
- Made of electropolished stainless steel with carbon fibre padding and polyurethane foam mattress.
- Footrest top transparent for X-rays.

mattress	polyurethane foam 80 mm, 270 x 635 mm
adjustment	inversion inclination angle
assembly	wedges, integrated mounting adaptor

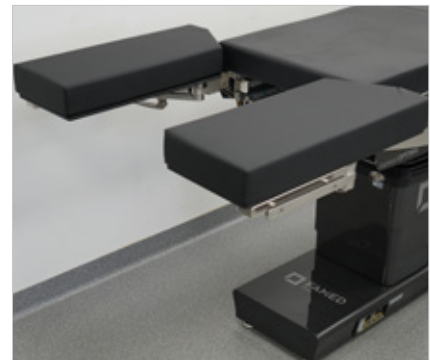

 OPTIMA 5.15, 5.20

SG-43.3 Double abduction foot rests

- Designed to support the lower limbs of a patient placed in a prone or supine position.
- Two pivot points locked by a single lever allow double lateral abduction.
- Foot rest inclination angle adjustment using the remote control.
- Ideal for procedures in laparoscopy, gynaecology, urology.
- Generous space in the groin area and easy access to the operated area due to the double abduction and cut-outs.
- Made of electropolished stainless steel with carbon fibre padding and polyurethane foam mattress.

mattress	polyurethane foam 80 mm, 270 x 635 mm
adjustment	inversion inclination angle
assembly	wedges, integrated mounting adaptor

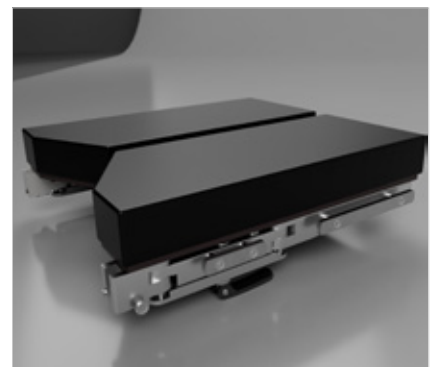

 HYPERION

AS-88 Attachment for knee arthroscopy

- Designed to support the knee joint during arthroscopy.
- The side support allows the knee joint to be positioned in the "figure-of-four" position and handled by a single operator.
- It consists of a polyurethane roll, shaped clamps and a support part.
- Parts in contact with the patient's body made of polyurethane.
- Support structure made of electropolished stainless steel.
- Clamp spacing can be adjusted by turning the knob.

roll	polyurethane, 80 x 140 mm
clamps	polyurethane, 70 x 152 x 24 mm
adjustment	angle, height, spacing
pivot	square, 16 x 16 mm
assembly	accessory rail, mounting adaptor required

 HYPERION | OPTIMA 5.9, 5.12, 5.15, 5.20 | PRIME | SU-02 | SU-14 | VIDAR



WS-40.5 Attachment for knee arthroscopy and meniscus surgery

- Designed to support the patient's knee joint in supine position.
- Consists of a polyurethane roll and a support part.
- Parts in contact with the patient's body made of polyurethane.
- Support structure made of electropolished stainless steel.

roll	polyurethane, 80 x 300 mm
adjustment	angle, height
pivot	square, 16 x 16 mm
assembly	accessory rail, mounting adaptor required

 HYPERION | OPTIMA 5.9, 5.12, 5.15, 5.20 | PRIME | SU-02 | SU-14 | VIDAR



WS-40.7 Attachment for knee arthroscopy and meniscus surgery

- Designed to support the patient's knee joint in supine position.
- Made of plexiglass.
- The roll has no steel reinforcements and is completely X-ray transparent
- Support structure made of electropolished stainless steel.

roll	Plexiglas, 80 x 300 mm
adjustment	angle, height
pivot	square, 16 x 16 mm
assembly	accessory rail, mounting adaptor required

 HYPERION | OPTIMA 5.9, 5.12, 5.15, 5.20 | PRIME | SU-02 | SU-14 | VIDAR

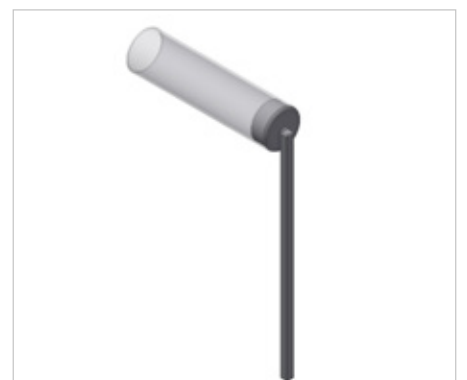



AS-09 Knee rests

- Designed to support the patient's lower limbs in a lying or sitting position.
- Accessory with increased durability. It can be used in bariatric surgery.
- Support structure made of electropolished stainless steel with knee rests finished in polyurethane.
- Height adjustment, rotation around its axis and angle positioning of the support and mattress.
- Goepel holder equipped with straps for limb stabilisation.
- Product sold as a pair – optionally available as a piece.

dimensions	220 x 337 mm
pivot	circular, Ø 18 mm
mattress	polyurethane, 27 mm
adjustment	height, inclination angle, rotation around axis
assembly	accessory rail, mounting adaptor required

 HYPERION | OPTIMA 5.9, 5.12, 5.15, 5.20 | PRIME | SU-02 | SU-14 | VIDAR



WS-05.5 Knee rest

- Designed to support the patient's limb in lying or sitting position.
- It consists of an electropolished stainless steel arm and a shaped support finished with polyurethane and stabilising straps.
- The use of a suitable mounting adaptor makes it possible to rotate the support arm around its axis, adjust its height and angle.
- The support mattress can be adjusted on the ball joint.

dimensions	190 x 295 mm
mattress	polyurethane, 25 mm
pivot	Ø 16 mm
adjustment	height, angle, rotation around its axis
assembly	accessory rails, mounting adaptor required

 OPTIMA 5.9, 5.12, 5.15, 5.20 | PRIME SU-02 | SU-14 | VIDAR



WS-96.5 Attachment for leg movement

- Designed for support and abduction of the patient's lower limb.
- Consists of an arm with an accessory rail, a mounting adaptor and a leg support with special-shaped polyurethane mattress.
- Support structure made of electropolished stainless steel.
- A range of adjustments ensures easy positioning.

dimensions	190 x 295 x 24 mm
adjustment	height, distance from the table, angle of the mattress, abduction
mattress	polyurethane
assembly	accessory rail, integrated mounting adaptor

 HYPERION | OPTIMA 5.9, 5.12, 5.15, 5.20 | PRIME SU-02 | SU-14 | VIDAR







GEL AND FOAM

POSITIONERS

Gel and foam positioners

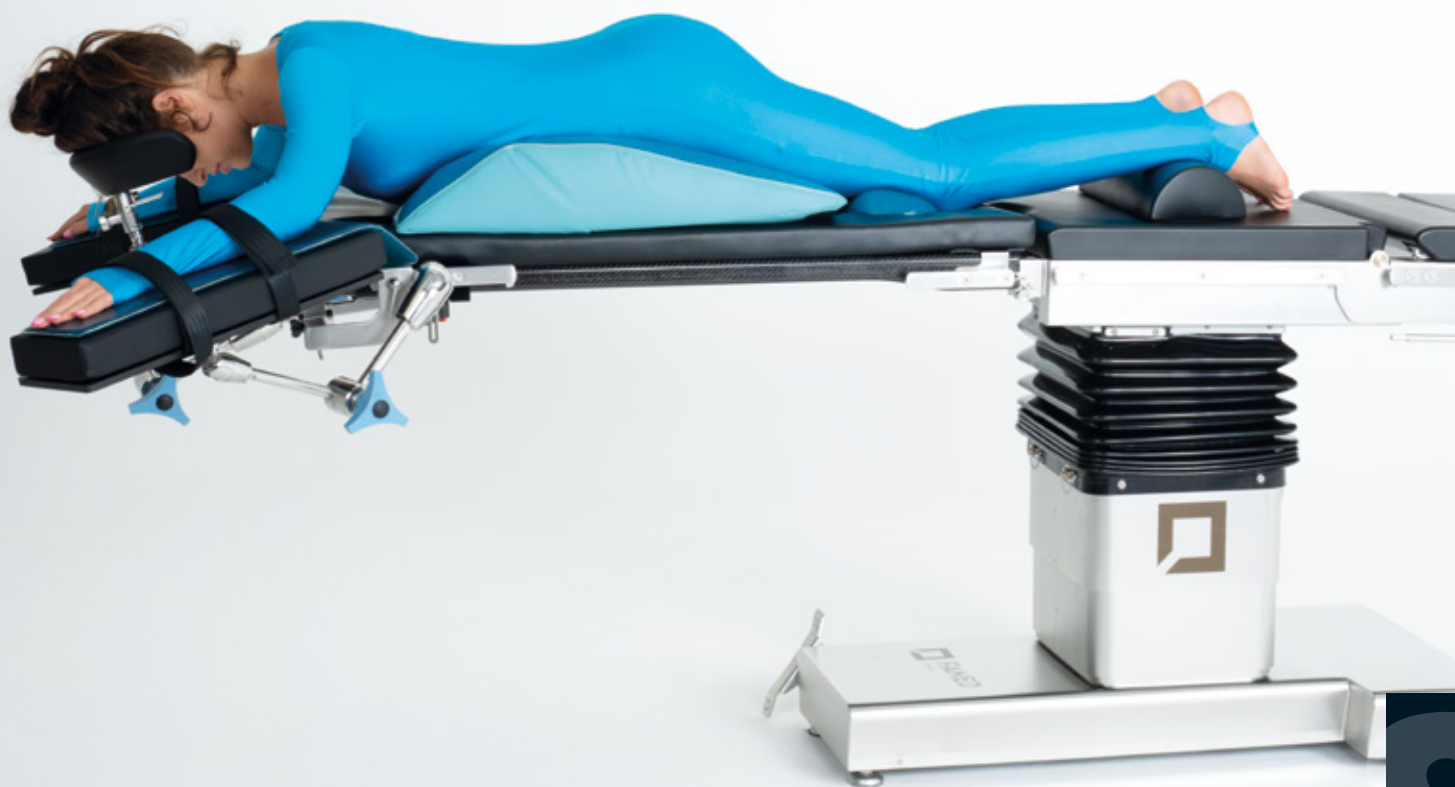



AP002
Head positioner closed

- supine, lithotomy position
- dimensions: 140 x 60 x 35 mm



AP003
Head positioner closed

- supine, lithotomy position
- dimensions: 200 x 75 x 45 mm



AP013
Open head positioner

- prone, lateral position
- dimensions: 200 x 75 x 45 mm



AP014
Open head positioner

- prone, lateral position
- dimensions: 200 x 75 x 75 mm



AP014C
Open head positioner with cutout

- prone, lateral position
- dimensions: 200 x 75 x 75 mm



AP023
Head positioner

- prone position
- dimensions: 230 x 190 x 130 mm



AP024
Head positioner

- prone position
- dimensions: 240 x 220 x 90 mm



AP031
Heel pad

- supine, prone, lithotomy position
- dimensions: 200 x 110 x 70 mm



AP042
Half-roll

- supine, prone, lateral, lithotomy position
- dimensions: 400 x 150 x 100 mm



AP043
Half-roll

- supine, prone, lateral, lithotomy position
- dimensions: 500 x 150 x 100 mm



AP047
Half-roll

- supine, prone, lateral, lithotomy position
- dimensions: 500 x 180 x 150 mm



AP049-2
Half-roll profiled

- supine, prone, lateral, lithotomy position
- dimensions: 400 x 160 x 130/90 mm

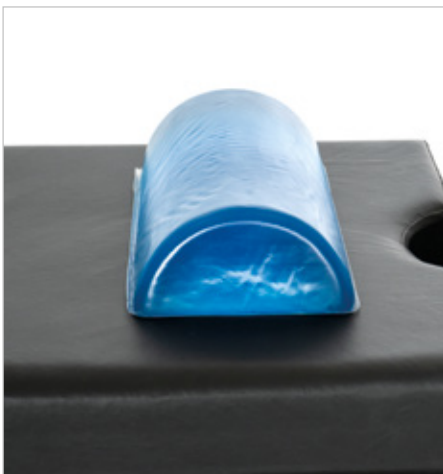

AP051
Half-roll

- supine, prone, lithotomy position
- dimensions: 350 x 150 x 75 mm



AP051 UFG
Half-roll

- supine, prone, lithotomy position
- dimensions: 350 x 150 x 75 mm

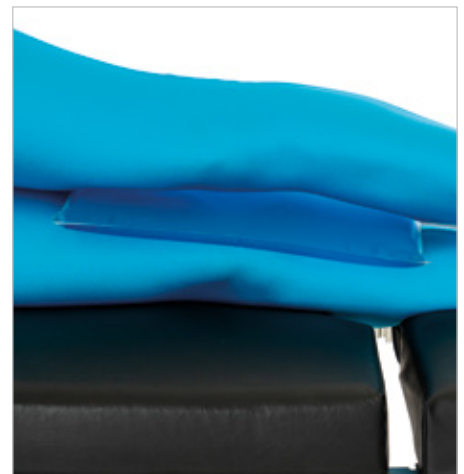

AP052
Knee pad

- lateral position
- dimensions: 230 x 360 x 38 mm



AP055
Sacral stabilizer

- supine, lithotomy position
- dimensions: 180 x 180 x 13 mm



AP071
Hand pad

- supine, prone, lateral, lithotomy position
- dimensions: 400 x 125 x 20 mm

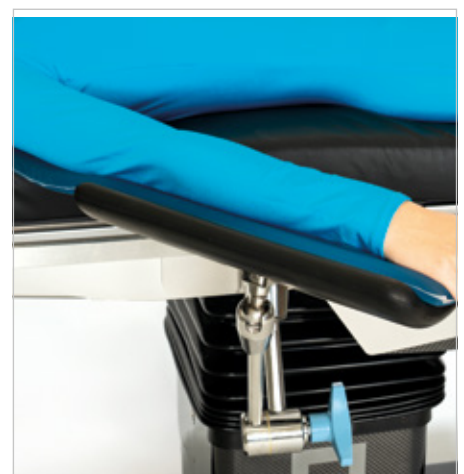

AP072
Hand pad

- supine, prone, lateral, lithotomy position
- dimensions: 600 x 125 x 20 mm



AP077
Profile hand pad

- supine, prone, lateral, lithotomy position
- dimensions: 520 x 150 x 55 mm



AP093
Universal positioner

- supine, prone, lateral, lithotomy position
- dimensions: 330 x 120 x 60 mm



AP095
Universal positioner

- supine, prone, lateral, lithotomy position
- dimensions: 250 x 125 x 50 mm



AP101
Side positioner

- lateral position
- dimensions: 710 x 500 x 100 mm



AP103
Side positioner

- lateral position
- dimensions: 400 x 650 x 210 mm



AP103-1
Crossbone support

- supine, lithotomy position
- dimensions: 400 x 380 x 25 mm,



AP110
Head positioner with ear protection

- supine, lithotomy position
- dimensions: 270 x 230 x 70 mm



AP110-UFG
Head positioner with ear protection

- supine, lithotomy position
- dimensions: 270 x 230 x 70 mm



AP112
Head positioner

- supine, lithotomy position
- dimensions: 270 x 240 x 90 mm



AP113
Heart-shaped head positioner

- supine, lithotomy position
- dimensions: 300 x 315 x 70 mm



AP402
Operating table pad

- supine, lithotomy, lateral position
- dimensions: 1830 x 500 x 10 mm



AP409WC-1.5
Operating table pad

- supine, prone, lateral, lithotomy position
- dimensions: 1170 x 500 x 15 mm



AP801
Leg support pad

- lithotomy position
- dimensions: 310 x 230 x 10 mm



AP802
Leg support pad

- lithotomy position
- dimensions: 400 x 250 x 10 mm



APFB01
Stabilization belts

- supine, lithotomy position
- dimensions: 330 x 70 x 15 mm

Table of accessories

1 Basic accessories		
WS-13.5	Operating table equipment trolley	8
WS-13.9	Operating table equipment trolley	8
AS-08	Table top extension set	8
AS-20	Table top extension set	8
AS-84	Table top extension set	8
AS-71	Table top for paediatric procedures	9
AS-82	Adjustable special headrest adaptor	9
WS-16.5	Mounting adaptor	9
WS-16.8	Mounting adaptor	9
WS-17.6	Multiposition adaptor	10
WS-17.8	Multiposition adaptor	10
AS-89	Multiposition adaptor - multipurpose	10
AS-83	Footrest adapter with accessory rail	10
AS-51	X-ray tray	11
WS-11.7	X-ray tray	11
WS-11.8	X-ray tray	11
WS-19.7	X-ray tray	11
WS-19.8	X-ray tray	11
WS-33	Side holder for X-ray pictures	12
KTEK 2501	Anaesthesia screen frame	12
KTEK4810	mounting adaptor for KTEK2501 screen frame	12
WS-01.5	Anaesthesia frame	12
WS-01.6	Adjustable anaesthesia frame	13
WS-01.7	Anaesthesia frame	13
WS-01.8	Adjustable anaesthesia frame	13
WS-14.5	Anaesthesia tube holder	13
WS-32.5	Side handrail	14
WS-43	Hand holder	14
WS-92.5	Bag holder	14
WS-53	Side rail extension	14
AS-75.0	Endoscope holder on articulated arm	15
WK-01.5	Infusion stand	15
WK-01.6	Infusion stand	15
WS-23	Abdominal restraint strap	16
WS-34.5	Wrist strap	16
WS-41	Abdominal restraint strap	16
WS-41.5	Abdominal restraint strap	16
WS-41.6	Abdominal restraint strap	16
WS-42	Lower leg strap	17
WS-42.1	Lower leg strap	17
WS-42.5	Lower leg strap	17
WS-44	Thigh strap	17
WS-44.1	Thigh strap	17

WS-44.5	Thigh strap	18
WS-66	Half-roll	18
WS-68	Neck half-roll	18
WS-69	Headrest	18
WS-59.6	Shoulder support	19
WS-06.5	Shoulder support	19
WS-50.5	Side support	19
AS-70.51	FlexArm™ side support	19
AS-79	Universal side support arm	20
AS-79.11	Small side support mattress	20
AS-79.12	Small side support mattress	20
AS-79.13	Large side support mattress	20
AS-79.14	Large side support mattress	20
AS-79.31	Special shape mattress	20
AS-79.32	Special shape mattress with cut-out	21
AS-79.33	Special shape mattress	21
AS-79.41	Triangular mattress	21
AS-79.42	Round mattress	21
WS-06.55	Shoulder support	21
WS-06.7	Side support	21
WS-15.5	Surgical instruments tray	21

2 Orthopaedics and traumatology		
SO-12	Orthopaedic attachment with lift	24
SO-14	Orthopaedic attachment with lift	25
	Adult leather shoes	25
	Paediatric leather shoes	26
WS-60.6	Hip support	26
WS-70.6	Support for plastering	26
WS-71.5	Leg support	26
WS-72.5	Crossbar/strap support	27
WS-73.5	Foot holder clip	27
WS-74.5	Heel holder	27
WS-75.5	Knee joint support	27
WS-82.5	Accessory adaptor	28
WS-82.7	Accessory adaptor	28
WS-82.6	Accessory adaptor	28
WS-82.8	Accessory adaptor	28
WS-85.6	Attachment for knee operation with lower leg lift	28
AS-85	leg rest for orthopaedic attachment	29
AS-85.1	leg rest for orthopaedic attachment	29
WS-80.7	orthopaedic attachment trolley	29
WS-80.8	orthopaedic attachment trolley	29
WS-80.9	orthopaedic attachment trolley	29
WS-80.11	orthopaedic attachment trolley	29
WS-80.115	orthopaedic attachment trolley	29
WS-80.12	orthopaedic attachment trolley	29
WS-80.14	orthopaedic attachment trolley	29
WS-80.145	orthopaedic attachment trolley	29
AS-77	Famed ArtHero™ Shoulder Surgery System	31
AS-80	Famed ArtHero™ Shoulder Surgery System	31
AS-70.7	FlexArm™ special helmet	31
AS-70.6	Helmet strap set	31
AS-77.11	Special helmet mask	32
AS-77.12	Special helmet chin strap	32
AS-77.13	Special helmet forehead strap	32
AS-77.4	Abdominal restraint strap	33
WS-47.5	Humerus positioning device with Weinberger hand cuff	33
WS-87.5	Support for upper limb surgery	33

3 Gynaecology, urology, proctology, lithotomy		
AS-11	Positioner for proctology procedures	36
AS-23	Positioner for proctology procedures	36
WS-30.5	Positioner for proctology procedures	36
WS-30.8	Positioner for proctology procedures	36
WS-30	Positioner for proctology procedures	37
AS-16.5	Roll	37
AS-16.6	Roll	37
AS-16.7	Roll	37
WS-64.5	Lithotomy stirrups	38
SG-44.6	Gynaecological-urological section	38
SG-44.7	Gynaecological-urological section	38
SG-44.8	Gynaecological-urological section	38
WS-28.9	Gynaecological and urological bowl	39
WS-89.5	Strainer	39
KTEK2602	Nissen straps	39
KTEK1000	Transport trolley for stirrup leg holder	39
KTEK3000	Stirrup leg holder 159 kg	40
KTEK400	Stirrup leg holder 181 kg	40
KTEK5000	Stirrup leg holder 227 kg	40
KTEK250	Stirrup leg holder - paediatric 113 kg	40
KTEK3100	Stirrup leg holder 159 kg	41
KTEK5100	Stirrup leg holder 227 kg	41
KTEK800	Stirrup leg holder – bariatric 363 kg clean	42
KTEK4200	Mounting adaptor for stirrup leg holder	42
KTEK4610	Mounting adaptor for stirrup leg holder	42
KTEK4710	Mounting adaptor for stirrup leg holder	42



4 Neurosurgery and minimally invasive surgery

AS-65	Accessory for spinal surgery	46
AS-66	Carbon fibre extension	46
AS-67	Carbon fibre table top	46
WS-13.8	Storage and transport trolley for AS-67	47
WS-65	Elevating mattress	47
AS-74	Filling mattress for WS-65 elevating mattress	47
KTEK9000	Spinal surgery frame	47
AS-58.2	Accessory rail for carbon table top	48
AS-58.3	Holder	48
AS-68	Carbon table top holder	48

6 Upper limb positioning

AS-69	Carbon fibre hand surgery table top	62
AS-69.1	Hand surgery table top	62
AS-70.31	FlexArm™ arm support	62
AS-70.42	FlexArm™ arm support	62
PR-01.6	Arm support	63
PR-01.5	Arm support	63
WS-07.5	Angle-adjustable arm support	63
AS-10.0	Arm support with angle adjustment	63
AS-15	Arm support	64
AS-28.1	Carbon fibre arm support	64
AS-87	Elbow arthroscopy support	64

5 Head positioning

AS-82	Adjustable special headrest adaptor	52
AS-70.2	FlexArm™ special headrest	52
AS-70.7	FlexArm™ special headrest	52
WS-22.5	Arm support	52
AS-78	Special headrest frame with 3 rotating elements	53
AS-78.1	Single special headrest	53
AS-78.2	Special split headrest - shaped	53
AS-78.3	Special split headrest - flat	53
AS-78.5	Panel headrest	54
AS-78.6	Special headrest - helmet	54
SG-10.11	headrest with double elevation	54
SG-15.15	headrest with double elevation	54
AS-72	Ophthalmologic table top	55
AS-86	Angle-adjustable headrest	55
WS-88.5	Roller lift	55
	HORSESHOE HEADREST	56
	QR3 HEADREST SYSTEM	56
	LUCENT® Headrest System	57
	TEFLON® Headrest System	57
	Base Unit Park Bench	59
	Crossbar adaptor (3007-00)	59
	Cervical Spine Support (3012-00)	59
	DORO® Side Rail OR Table Adaptor (3011-00)	59
	Skull fixing pins	59

7 Lower limb positioning

AS-21	Foot supports	68
AS-35	Panel foot rest	68
AS-63.6	Leg rest	68
AS-63.7	Leg rest	68
AS-63.8	Leg rest	69
SG-42.6	Panel foot rest	69
SG-42.7	Panel foot rest	69
SG-42.8	Panel foot rest	69
SG-15.9	Foot rests with cut-outs	70
SG-43.1	Double abduction foot rests	70
SG-43.2	Double abduction foot rests	70
SG-43.3	Double abduction foot rests	70
AS-88	Attachment for knee arthroscopy	71
WS-40.5	Attachment for knee arthroscopy and meniscus surgery	71
WS-40.7	Attachment for knee arthroscopy and meniscus surgery	71
AS-09	Knee rests	72
WS-05.5	Knee rest	72
WS-96.5	Attachment for leg movement	72

8

Gel and foam positioners

AP002	Head positioner closed	76
AP014	Open head positioner	76
AP024	Head positioner	76
AP003	Head positioner closed	76
AP014C	Open head positioner with cutout	76
AP031	Heel pad	76
AP013	Open head positioner	76
AP023	Head positioner	76
AP042	Half-roll	76
AP043	Half-roll	77
AP051	Half-roll	77
AP055	Sacral stabilizer	77
AP047	Half-roll	77
AP051 UFG	Half-roll	77
AP071	Hand pad	77
AP049-2	Half-roll profiled	77
AP052	Knee pad	77
AP072	Hand pad	77
AP077	Profile hand pad	78
AP101	Side positioner	78
AP110	Head positioner with ear protection	78
AP093	Universal positioner	78
AP103	Side positioner	78
AP110-UFG	Head positioner with ear protection	78
AP095	Universal positioner	78
AP103-1	Crossbone support	78
AP112	Head positioner	78
AP113	Heart-shaped head positioner	79
AP801	Leg support pad	79
AP402	Operating table pad	79
AP802	Leg support pad	79
AP409WC-1.5	Operating table pad	79
APFB01	Stabilization belts	79

1

2

3

4

5

6

7

8



Member of REINSBERG GROUP

Famed Żywiec Sp. z o.o.
ul. Fabryczna 1
34-300 Żywiec, Poland

Business Office:
tel.: +48 33 866 62 00
fax: +48 33 475 58 90
sekretariat@famed.com.pl

Sales:
tel: +48 33 866 63 08
sprzedaz@famed.com.pl

www.famed.com.pl



Edition 354/2024/10/1. Famed Żywiec reserves the right to introduce modifications to the product and specifications as a result of technical developments. All illustrations and pictures used in this publication are used for demonstration purposes only and may not reflect the finished product. The people visible in the pictures are not medical professionals. They are models. The equipment shown in the catalogue is intended for use in healthcare facilities by authorised persons after familiarisation with the manual.



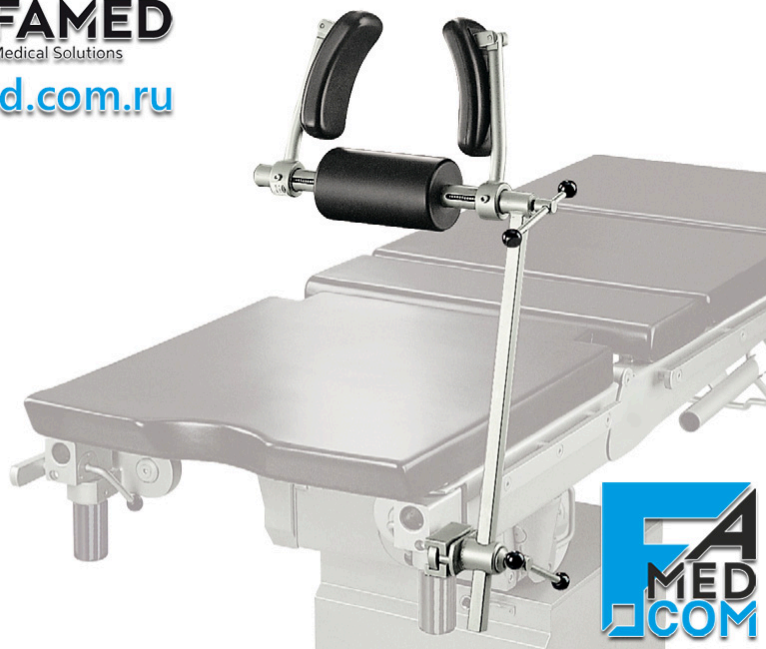

Металлические элементы конструкции изготовлены из лучшей на рынке нержавеющей стали AISI 316L с технологией **InteliProtectPlus™**.

Опорная часть состоит из полиуретанового валика цилиндрической формы (длина 140мм, Ø 80 мм), а зажимной механизм - из двух умягченных формованным полиуретаном элементов с регулировкой расстояния между ними.



Приставка для артроскопии коленного сустава AS-14 имеет бóльший диапазон регулировки ширины рабочей части, чем WS-39.5 подходит для всех моделей операционных столов FAMED.

