





-  SMMS 40 GSM G-PLUS
-  DOUBLE SIDED TAPE

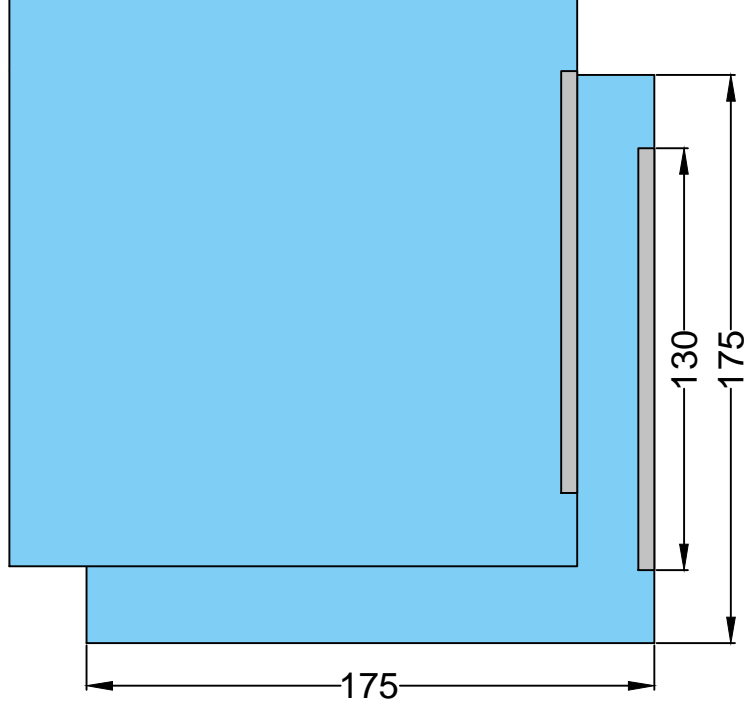

ADHESIVE DRAPE 175X175CM 2PCS

NUREL MEDİKAL SAN. VE TİC. A.Ş			TITLE: ADHESIVE DRAPE 175X175CM 2PCS			
		UNIT: CM	GEN. TOLERANCE: ±5		SIZE: A4	REV:0
APPROVAL	DEPARTMENTION	NAME - SURNAME	SIGN	DATE	DWG NO: NMN 2023-3953	
	PRODUCTION AND DESIGN MANAGER	FİLİZ BATUR ŞAHİN				
	DRAWING BY	EMRAH ÇELİK				
	TECHNICAL DRAWING DATE			07.11.2023	SCALE:1/1	PAGE:1

BIFLEX 56 GSM SPUNBOND

DOUBLE SIDED TAPE

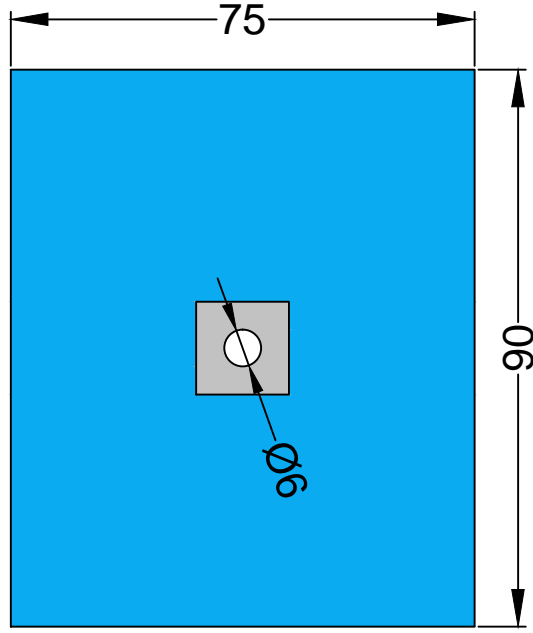

## FENESTRATED ADHESIVE DRAPE 75X90CM

NUREL MEDİKAL SAN. VE TİC. A.Ş

TITLE: FENESTRATED ADHESIVE DRAPE 75X90CM



UNIT: CM

GEN. TOLERANCE:  $\pm 5$

SIZE: A4

REV:0

APPROVAL

DEPARTMENTION

NAME - SURNAME

SIGN

DATE

DWG NO: NMN 2023-3954

PRODUCTION AND DESIGN  
MANAGER

FİLİZ BATUR ŞAHİN

DRAWING BY

EMRAH ÇELİK

TECHNICAL DRAWING DATE 07.11.2023

SCALE:1/1 PAGE:1

**NUREL**  
medikal



BIFLEX 56 GSM SPUNBOND

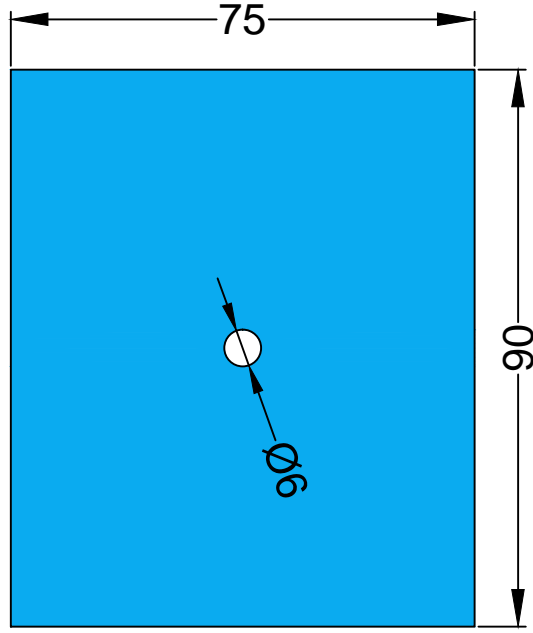

## FENESTRATED DRAPE 75X90CM

NUREL MEDİKAL SAN. VE TİC. A.Ş

TITLE: FENESTRATED DRAPE 75X90CM



UNIT: CM

GEN. TOLERANCE:  $\pm 5$

SIZE: A4

REV:0

APPROVAL

DEPARTMENTION

NAME - SURNAME

SIGN

DATE

DWG NO: NMN 2023-3955

PRODUCTION AND DESIGN  
MANAGER

FİLİZ BATUR ŞAHİN

DRAWING BY

EMRAH ÇELİK

TECHNICAL DRAWING DATE 07.11.2023

SCALE:1/1 PAGE:1

**NUREL**  
medikal

- SMMS 40 GSM G-PLUS
- DOUBLE SIDED TAPE

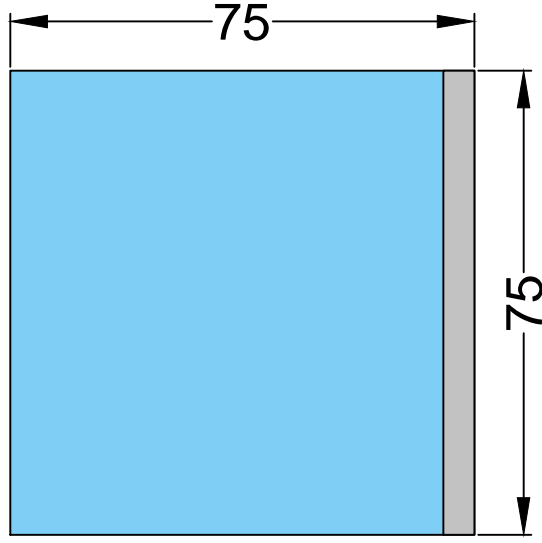

## ADHESIVE DRAPE 75X75CM

NUREL MEDİKAL SAN. VE TİC. A.Ş			TITLE: ADHESIVE DRAPE 75X75CM			
		UNIT: CM	GEN. TOLERANCE: ±5		SIZE: A4	REV:0
APPROVAL	DEPARTMENTION	NAME - SURNAME	SIGN	DATE	DWG NO: NMN 2023-3956 <b>NUREL</b> medikal	
	PRODUCTION AND DESIGN MANAGER	FİLİZ BATUR ŞAHİN				
	DRAWING BY	EMRAH ÇELİK				
	TECHNICAL DRAWING DATE		07.11.2023	SCALE:1/1		

- SMMS 40 GSM G-PLUS
- TRIPLEX 106 GSM
- DOUBLE SIDED TAPE

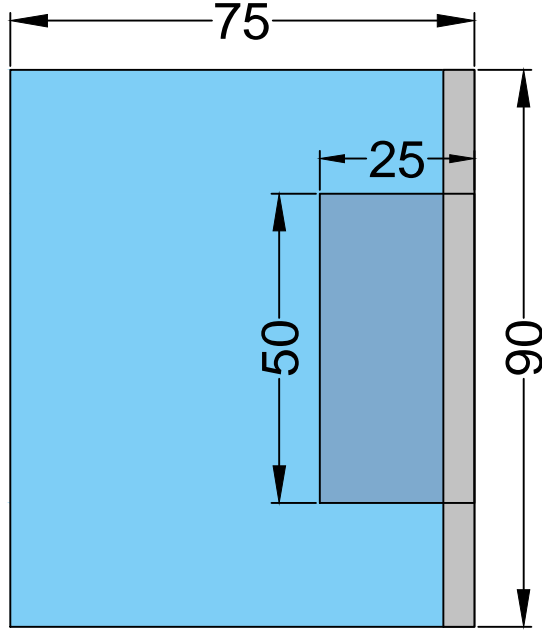

## REINFORCED ADHESIVE DRAPE 75X90CM

NUREL MEDİKAL SAN. VE TİC. A.Ş

TITLE: REINFORCED ADHESIVE DRAPE 75X90CM



UNIT: CM

GEN. TOLERANCE:  $\pm 5$

SIZE: A4

REV:0

APPROVAL

DEPARTMENTION

NAME - SURNAME

SIGN

DATE

DWG NO: NMN 2023-3957

PRODUCTION AND DESIGN  
MANAGER

FİLİZ BATUR ŞAHİN

DRAWING BY

EMRAH ÇELİK

TECHNICAL DRAWING DATE

07.11.2023

SCALE:1/1

PAGE:1

**NUREL**  
medikal

- SMMS 40 GSM G-PLUS
- TRIPLEX 106 GSM
- DOUBLE SIDED TAPE

- BIFLEX 150CM BLUE 50 GR PEVA
- ORT 75 CM 30 GR SPUNBOND
- BLUE PE 50 MIC / SPUNBOND 30GR

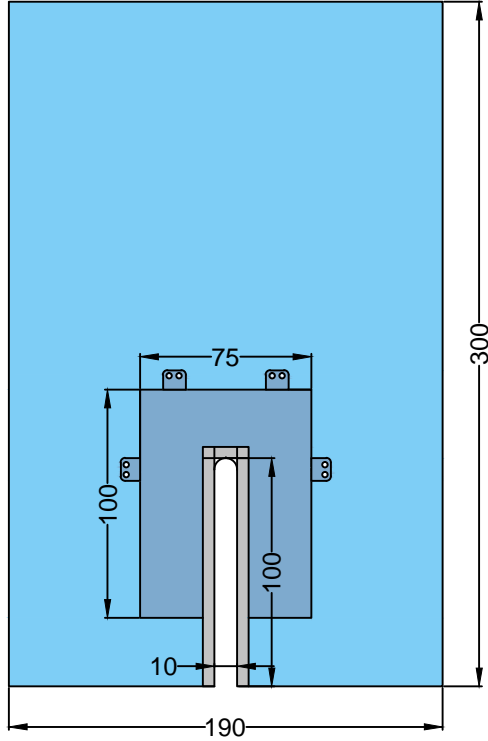

REINFORCED U SPLIT DRAPE 190X300CM

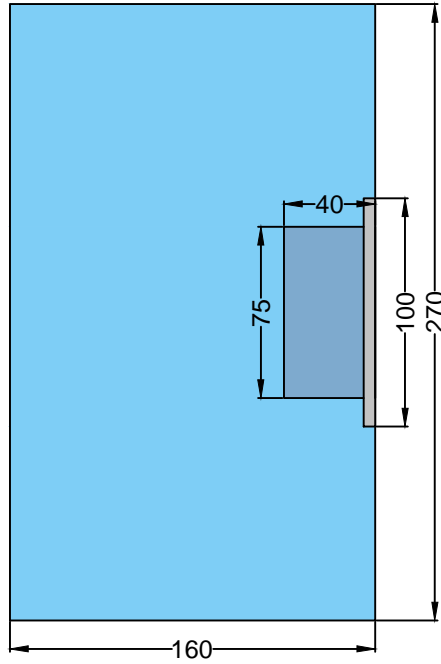

REINFORCED ANESTHESIA DRAPE 160X270CM

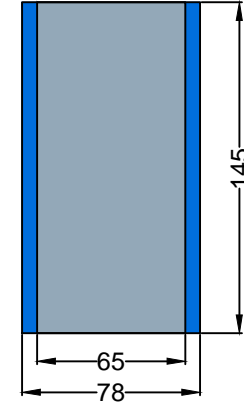

MAYO COVER 78X145CM

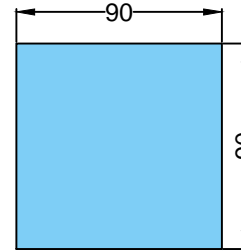

WRAP 90X90CM

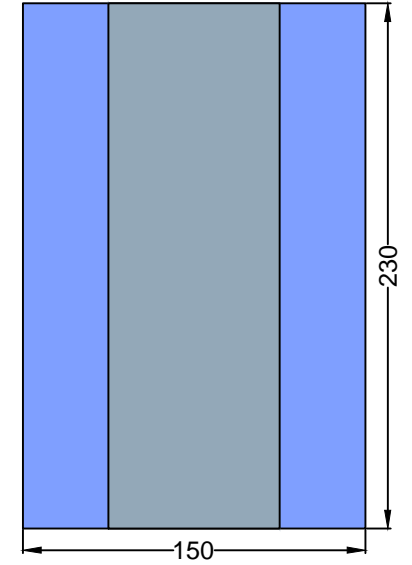

TABLE COVER 150X230CM



SUTURE BAG  
18X30CM



OR-TOWEL 42X63CM

NUREL MEDİKAL SAN. VE TİC. A.Ş			TITLE: SURGICAL SET	
		UNIT: CM	GEN. TOLERANCE: ±5	
		SIZE: A4	REV:0	
APPROVAL	DEPARTMENTION	NAME - SURNAME	SIGN	DATE
	PRODUCTION AND DESIGN MANAGER	FILİZ BATUR ŞAHİN		
	DRAWING BY	EMRAH ÇELİK		
	TECHNICAL DRAWING DATE		07.11.2023	SCALE:1/1
				<b>NUREL</b> Medikal



- SMMS 40 GSM G-PLUS
- TRIPLEX 106 GSM
- INCISION
- SPUNLACE 50GSM
- BIFLEX 150CM BLUE 50 GR PEVA  
ORT 75 CM 30 GR SPUNBOND
- BLUE PE 50 MIC / SPUNBOND 30GR
- TRANSPARENT 80MIC PE

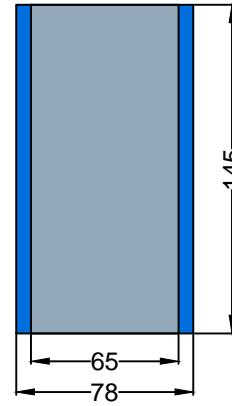
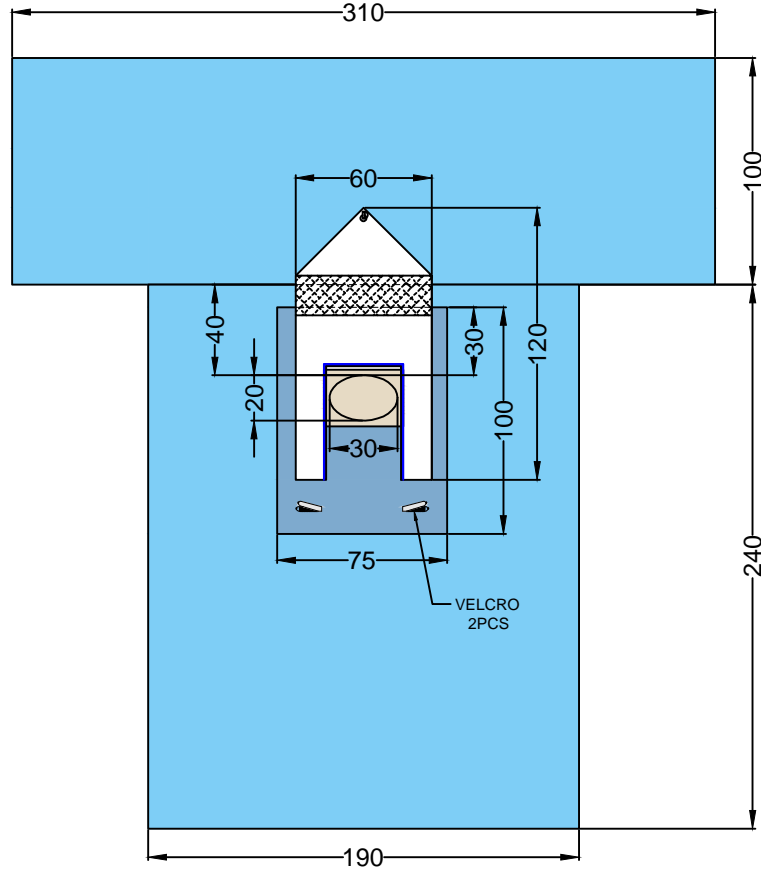

MAYO COVER 78X145CM

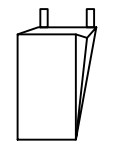

SUTURE BAG  
18X30CM

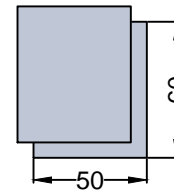

TOWEL 50X60CM 2PCS

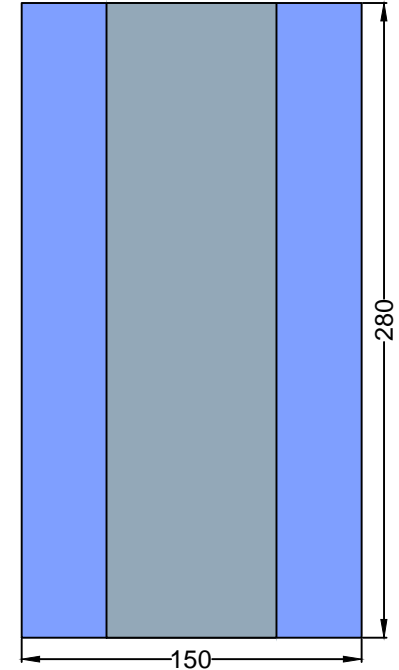

TABLE COVER 150X280CM

NUREL MEDİKAL SAN. VE TİC. A.Ş			TITLE: CRANIOTOMY SET		
☞	UNIT: CM	GEN. TOLERANCE: ±5		SIZE: A4	REV:0
APPROVAL	DEPARTMENTION	NAME - SURNAME	SIGN	DATE	DWG NO: NMN 2023-3959
	PRODUCTION AND DESIGN MANAGER	FILIZ BATUR ŞAHİN			
	DRAWING BY	EMRAH ÇELİK			
TECHNICAL DRAWING DATE			07.11.2023	SCALE:1/1	PAGE:1

