













ACA and ACZ series

- high weighing accuracy
- very good indication readability (LCD 18mm)
- indication backlight
- automatic internal calibration (ACA)
- RS232C and USB interface for printer, computer, label printer and barcode reader



Laboratory balances ACA and ACZ series are designed for use in laboratories, pharmacies, jewelry and research institutes where high accuracy of measurement is required.

 external calibration	 products database	 unit selection	 animals weighing
 internal calibration	 date/time	 weighing speed selection	 density measurement
 GLP compatibility	 printout config.	 threshold/selection	 force measurement
	 pieces counting	 max weight	 recipe
	 percentage	 min weight	 statistics
	 summation	 Alibi memory	

Options on demand



Under hook weighing



Protective cover



Glass draft shield



ACA hydro set

hook for hanging weighed object

protective cover to secure pan

glass draft shield

ACA hydro set to measure density of liquids and solids

USB_A (for USB flash drive or AXIS printer), LAN or Wi-Fi to work with computer

barcode reader interface (RS232C+supply)

computer software : Statistics ^{freeware}, Communication ^{freeware} - saving to file, ProCell - export to Excel

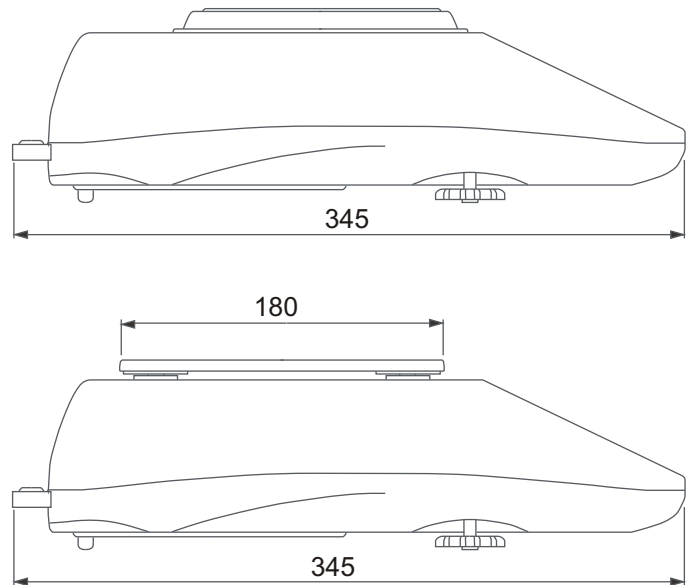
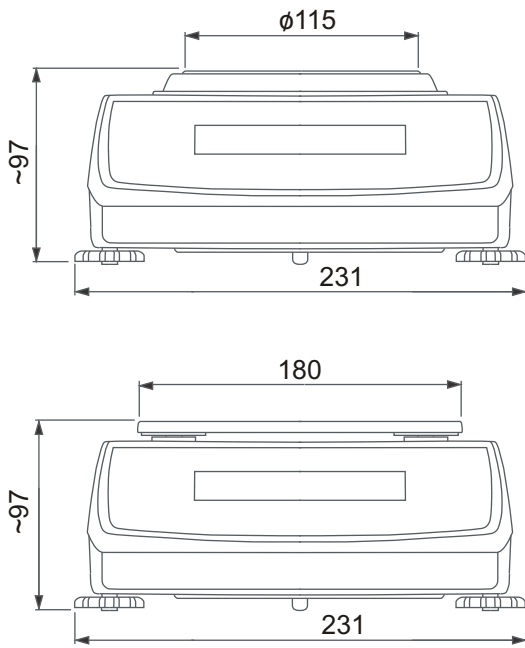

Balances with verification option

M

Technical data

Balances with int. calib.	ACA220	ACA320	ACA520	ACA620	ACA820	ACA1000	ACA2200	ACA3200	ACA4200	ACA6200	
Balances without int. calib.	ACZ220	ACZ320	ACZ520	ACZ620	ACZ820	ACZ1000	ACZ2200	ACZ3200	ACZ4200	ACZ6200	ACZ10
Capacity (Max)	220g	320g	520g	620g	820g	1000g	2200g	3200g	4200g	6200g	10kg
Minimum (Min)	0,02g	0,02g	0,02g	0,02g	0,02g	0,02g	0,5g	0,5g	0,5g	0,5g	5g
Reading unit (d)	0,001g	0,001g	0,001g	0,001g	0,001g	0,001g	0,01g	0,01g	0,01g	0,01g	0,1g
Verification unit (e)	0,01g	0,01g	0,01g	0,01g	0,01g	0,01g	0,1g	0,1g	0,1g	0,1g	-
Tare range	-220g	-320g	-520g	-620g	-820g	-1000g	-2200g	-3200g	-4200g	-6200g	-10kg
Accuracy class	II										
Repeatability	0,001g							0,01g		0,02g	0,2g
Linearity	± 0,002g							± 0,02g		± 0,02g	± 0,2g
Working temperature	+10 ÷ +40°C										
Weighing time	<3s										
Pan size	φ115mm					180x180mm					
Display	LCD digits height 18mm										
Dimensions (with legs)	231x345x97mm										
Interfaces	RS232, USB-B					option: USB-A, LAN or Wi-Fi					
Units	mg, g, kg, ct, lb, oz, ozt, gr, dwt										
Power supply	~230V 50Hz 9VA / =12V 1A										
Balance weight	4kg					5kg					
Recommended std. of mass	F2 200g	F1 500g			E2 1000g	F2 2000g			F1 5000g		