

Delta UPS Accessory

External Battery Pack for
RT Pro 1/ 2/ 3 kVA

Installation & Operation Quick Guide

ENGLISH

1 Product Introduction

The Delta External Battery Pack is applicable to the Delta Amplon RT 1/ 2/ 3kVA UPS. When the UPS is operating during a power outage, the battery pack provides DC power, which maintains inverter operation to supply power to the critical loads connected to the UPS.

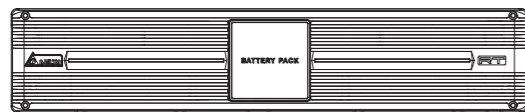

(Figure 1: Delta External Battery Pack Front View)

2 Important Safety Instructions

- Servicing of batteries and battery packs must be performed or supervised by qualified service personnel knowledgeable in batteries, battery packs and the required precautions. Keep unauthorized personnel away from batteries and battery packs.
- A battery can present a risk of electric shock and high short-circuit current.
- To reduce the risk of fire or electric shock, install the battery pack in a tempera-ture and humidity controlled indoor area free of conductive contaminants.
- Forbid opening or removing the cover of the battery pack to avoid high voltage electric shock.
- The risk of dangerous high voltage is possible when the batteries are still connected to the UPS even though the UPS is disconnected from the mains. Do not forget to disconnect the battery cable to completely cut off the battery source.
- Turn off the UPS and cut off the AC source before performing battery/ battery pack replacement.
- Only use the same type of batteries from the same supplier. Never use old, new and different Ah batteries at the same time.
- The number of batteries must meet UPS requirements.
- Do not reverse or short circuit the polarity + and - when connecting the batte-ries because this will destroy the device and constitute a risk of electric shock or fire.
- Use a voltage meter to measure whether the total voltage, after battery pack connection, is around $12.5Vdc \times$ the total number of batteries.
- The external slits and openings in the battery pack are provided for ventilation. To ensure reliable operation of the battery pack and to protect the battery pack from overheating, these slits and openings must not be blocked or covered. Do not insert any object into the slits and openings that may hinder ventilation.
- Do not allow liquid or any foreign object to enter the battery pack.
- Do not place beverages or any other liquid-containing vessels on or near the battery pack.

- Do not dispose of the battery or batteries in a fire. The batteries may explode.
- Do not open or mutilate the battery or batteries. The released electrolyte is harmful to the skin and eyes and may be toxic.
- Observe the following before replacing batteries:
 1. Remove watches, rings, or other metal objects.
 2. Use tools with insulated handles.
 3. Wear rubber gloves and boots.
 4. Do not lay tools or metal parts on the top of batteries.
 5. Disconnect charging source prior to connecting or disconnecting batteries' terminals.

3 Package List

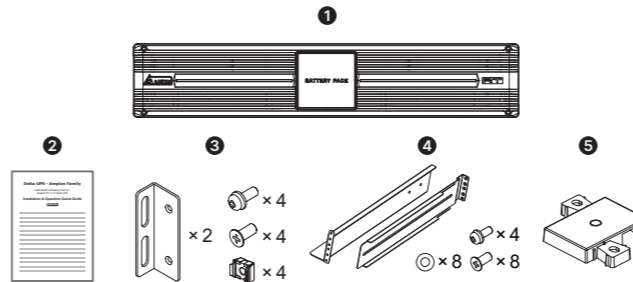

No.	Item	Q'ty
1	Delta External Battery Pack	1 PC
2	Installation & Operation Quick Guide	1 PC
3	Bracket Ear	1 SET
4	Rail Kit	1 SET
5	Tower Stand Extender	4 PCS

4 Installation Procedures

• Rack Mounting:

- 1 Attach the included bracket ears to the lateral mounting holes of the Delta external battery pack. See *Figure 2*.

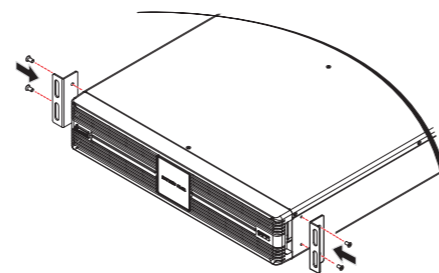

(Figure 2: Mount the Bracket Ears)

- 2 Follow steps 1 to 4 to install the Delta external battery pack into the provided rail kit and your rack. See *Figure 3*.

Step 1: Adjust the length of the rails according to your rack.

- 2 Tighten the rails' nuts.
- 3 Fix the rails on your rack.
- 4 Insert the Delta external battery pack into your rack and tighten the provided screws.

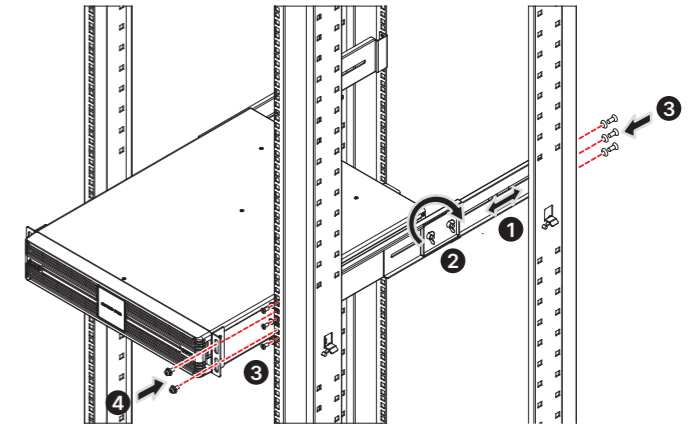

(Figure 3: Insert the Delta External Battery Pack into Your Rack)

NOTE: If you want to use a non-Delta rail kit, please only follow step 4.

• Tower Mounting:

- 1 Connect the provided stand extenders with the tower standards provided in the UPS's carton (please take the UPS and the Delta external battery pack's size into consideration). See *Figure 4*.

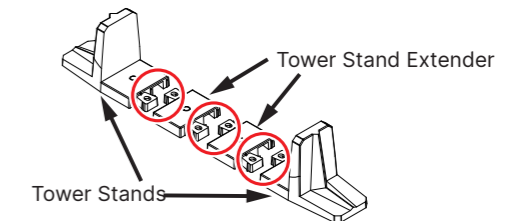

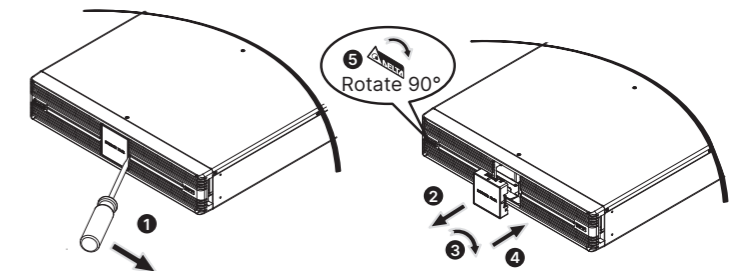

(Figure 4: Assemble the Tower Stands)

- 2 Pull out the Delta external battery pack's control panel (1 & 2), rotate it 90° clockwise (3) and re-insert the control panel (4). After that, rotate the Delta logo nameplate 90° clockwise (5). See *Figure 5*.



(Figure 5: Rotate the Delta External Battery Pack's Control Panel & Delta Logo Nameplate)



- Carefully lift the Delta external battery pack upright with the Delta logo  and the battery icon  facing up. A minimum of two people are required. See **Figure 6**.

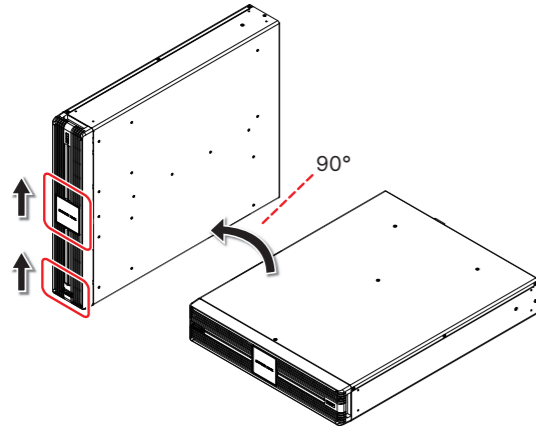

(Figure 6: Place the Delta External Battery Pack Upright)

- Place the Delta external battery pack and the UPS inside the tower stands. See **Figure 7**.

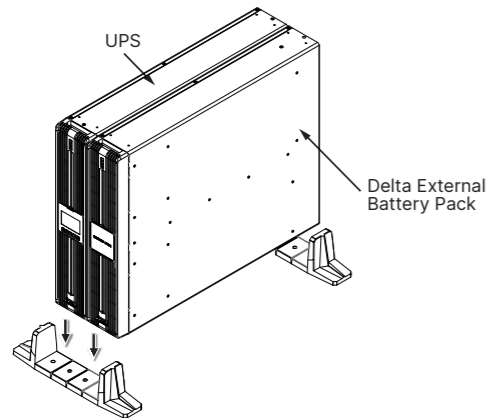

(Figure 7: Place the Delta External Battery Pack and the UPS inside the Tower Stands)

- Connect the Delta External Battery Pack with the UPS

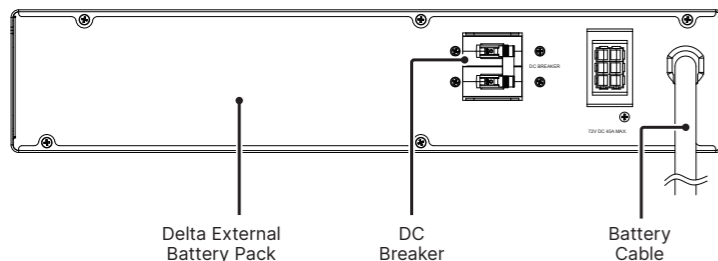

(Figure 8: Delta External Battery Pack Rear View)

- Set the battery pack's DC breaker to the **OFF** position.
- Remove the cover of the battery pack connector located on the rear side of the UPS.
- Connect the battery cable attached to the Delta external battery pack to the UPS's battery pack connector. Make sure the battery cable's iron strip shown in **Figure 9** is tightly screwed.

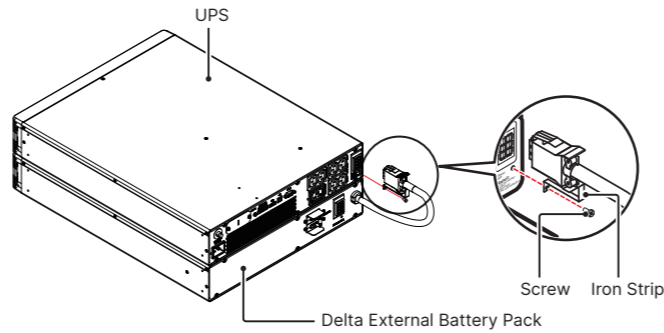



(Figure 9: Connect the UPS and the Delta External Battery Pack)

- Set the external battery pack's circuit breaker to the **ON** position.
- Use either the UPSentry 2012 software or the UPS's LCD to set up the battery pack number. Connects up to two external battery cabinets at maximum to extend the backup time.



NOTE:

- If the UPS is going to run for the 1st time, before operation, please fully charge the batteries (internal and external) until the Battery Level Bar Graph  shown on the UPS's LCD is fully on.
- Normally, the life of a battery is 3~5 years. However, an extreme operating condition and environment may shorten its life-span.
- When the UPS has not been used for a period of time, the batteries will discharge slightly. It is recommended to charge the batteries (internal and external) once every 3 months, and each time, fully charge them until the Battery Level Bar Graph  shown on the UPS's LCD is fully on.
- Safety Requirement:
For convenient removal of the battery power cord in an emergent situation, please arrange and organize each cable/wire connecting to the UPS and the Delta external battery pack well.

5 Operation Procedures

- Follow *Delta UPS Amplon Family RT Pro Series, Single-Phase, 220/230/240 Vac 1/2/3kVA UPS User Manual* to execute input/output connection.
- Follow **4 Installation Procedures** to connect the UPS and the Delta external battery pack.
- Follow *Delta UPS Amplon Family RT Pro Series, Single-Phase, 220/230/240 Vac 1/2/3kVA UPS User Manual* to turn on the UPS.

6 Optional Accessories

No.	Item	Function
1	Tower Stands	Mount the UPS or the external battery pack in an upright position.



NOTE: If you need to purchase the tower stands, please contact your local dealer or customer service.

7 Technical Specifications

Delta External Battery Pack		RT PRO-1KB	RT PRO-2KB	RT PRO-3KB
Applicable to Amplon RT Series UPS		1kVA	2kVA	3kVA
Battery	Type	VRLA		
	Q'ty	2 x 2 x 12V/ 9 Ah	2 x 4 x 12V/ 9 Ah	2 x 6 x 12V/ 9 Ah
Dimensions (W x D x H)		440 x 335 x 88 mm (17.3 x 13.2 x 3.5 inch)	440 x 430 x 88 mm (17.3 x 16.9 x 3.5 inch)	440 x 565 x 88 mm (17.3 x 22.2 x 3.5 inch)
Weight		15.2 kg 33.5 lb	28.5 kg 62.8 lb	41.1 kg 90.6 lb
Environment	Operating Altitude	0 ~ 3000 meters 0 ~ 1000 meters (without derating)		
	Operating Temperature	0 ~ 40°C		
	Relative Humidity	5 ~ 95% (non-condensing)		



NOTE:

- Please refer to the rating label for the safety certification.
- All specifications are subject to change without prior notice.

Copyright © 2024 by Delta Electronics Inc. All rights reserved. Changes may be made periodically to the information in this Quick Guide without obligation to notify any person of such revision or changes.

Global Headquarter

Taiwan

Delta Electronics Inc.
30 Section 2, Huandong Road, Shanhua District,
Tainan City 74144, Taiwan
T +886 6 505 6565
E ups.taiwan@deltaww.com

Regional Office

EMEA

Netherland

Delta Electronics (Netherlands) B.V.
Zandsteen 15, 2132 MZ Hoofddorp, The Netherlands
T +31 (0)20 800 3900
E info@delta-emea.com

AMERICA

U.S.A

Delta Electronics (Americas) Ltd.
46101 Fremont Blvd. Fremont, CA 94538
T +1 510 668 5100
E ups.na@deltaww.com

ASIA

India

Delta Electronics India Pvt. Ltd.
Plot No. 43, Sector-35, HSIIDC, Gurgaon-122001,
Haryana, India
T +91 124 4874 900
E ups.india@deltaww.com

Japan

Delta Electronics (Japan), Inc.
2-1-14 Shibadaimon, Minato-Ku, Tokyo, 105-0012,
Japan
T +81-3-5733-1111
E jpstps@deltaww.com

Singapore

Delta Electronics Int'l (Singapore) Pte Ltd.
17 Kallang Junction, #01-01, TRION,
Singapore 339274
T +65 6747 5155
E ups.singapore@deltaww.com

Vietnam (Ho Chi Minh)

Delta Electronics (Vietnam) Co., Ltd.
10th Floor, The Galleria Office Building,
258 Nam Ky Khoi Nghia Street, Vo Thi Sau Ward,
District 3, Ho Chi Minh City, Vietnam
T +84 903 133 548
E ups.vietnam@deltaww.com

Philippines

Eltek Power Inc./ Delta
302 Orient Square Bldg
F. Ortigas JR Road, Barangay
San Antonio, Pasig City
1605 Philippines
E ups.philippines@deltaww.com

OCEANIA

Australia

Delta Electronics (Australia) Pty Ltd.
St Leonard's Corporate Centre
Unit 18/39 Herbert Street, St Leonards NSW 2065, Australia
T +61 2 9479 4200
E ups.australia@deltaww.com

UK

Delta Electronics (UK) Ltd.
Eltek House, Unit 1 Cleveland Road, Hemel Hempstead,
Hertfordshire, HP2 7EY, UK
T +44 1442 210805
E sales.gb@eltek.com

South America

Delta Electronics Brasil Ltda.
Estrada Velha Rio-São Paulo, 5300 – Eugênio de Melo –
CEP 12247-001 São José dos Campos-SP-Brasil
T +55 12 39322300
E ups.brazil@deltaww.com

China

Delta GreenTech (China) Co., Ltd.
238 Minxia Road, Pudong, Shanghai, 201209 P.R.C
T +86 21 5863 5678
+86 21 5863 9595
E ups.china@deltaww.com

South Korea

Delta Electronics (Korea), Inc.
1511, Byucksan Digital Valley 6-cha, Gasan-dong, Geumcheon-gu,
Seoul, Korea, 153-704
T +82-2-515-5303
E ups.south.korea@deltaww.com

Thailand

Delta Electronics (Thailand) Public Co., Ltd.
909 Soi 9, Moo 4, E.P.Z., Bangpoo Industrial Estate, Tambon Phraksa,
Amphur Muang-samutprakarn, Samutprakarn Province 10280,
Thailand
T +662 709-2800
E ups.thailand@deltaww.com

Vietnam (Hanoi)

Delta Electronics (Vietnam) Co., Ltd.
3rd Floor, Vietnam 3D Creative Center Building, No. 3 Duy Tan Street,
Dich Vong Hau Ward, Cau Giay District, Hanoi City, Vietnam
T +84 966 532 266
E ups.vietnam@deltaww.com

Indonesia

Delta Electronics International (S) Pte Ltd.
Soho Capital, 30th Fl, Unit SC3009
Jl. Letjend S. Parman kav 28. Jakarta 11470 Indonesia
T + 65 9667 4687
E ups.indonesia@deltaww.com