

BMI® Medical

Shunting System



BMI® Medical

Ventricular Catheter 01101

Barium-impregnated silicone catheter provides resistance to kinking and compression. Stainless steel stylet allows catheter to be directed during catheter placement. The catheter is fabricated from silicone elastomer tubing impregnated with barium to provide radiopacity.

- Barium impregnation allows for visualization of the catheter on x-ray.
- non-ferrous design won't interfere with CT scans or MRI.

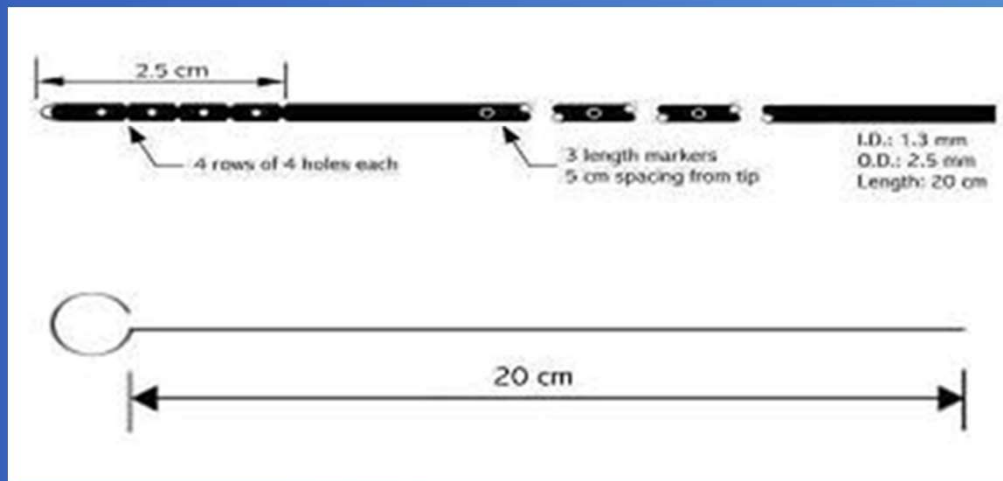
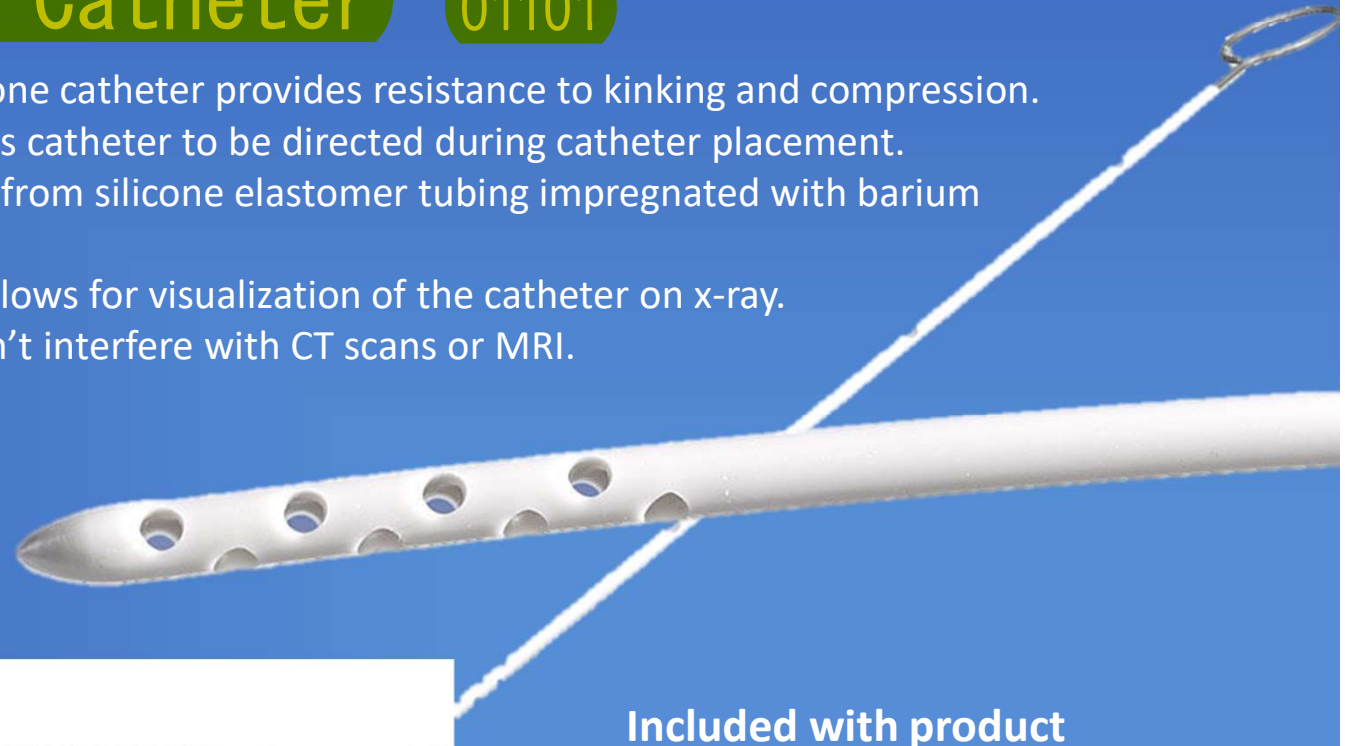

Included with product

**1ea. Ventricular Catheter
Barium Impregnated**

I.D.: 1.3 mm

O.D.: 2.5 mm

Length: 20 cm

1ea. Stainless Steel Stylet (20 cm)

BMI® Medical

Antibacterial Ventricular Catheter 21101

The Antibiotic-Impregnated Catheters reduce the colonization of gram-positive bacteria using a combination of rifampicin and silver salts.

Features

1. Impregnated with two antibiotics: rifampicin and silver salts
2. Show to reduce colonization of gram-positive bacteria on all catheter surfaces.
3. Features same-sized tubing as our standard non-antibiotic-impregnated catheters to resist kinking and compression.
4. Barium impregnation allows for visualization of the catheter on x-ray.
5. non-ferrous design won't interfere with CT scans or MRI.

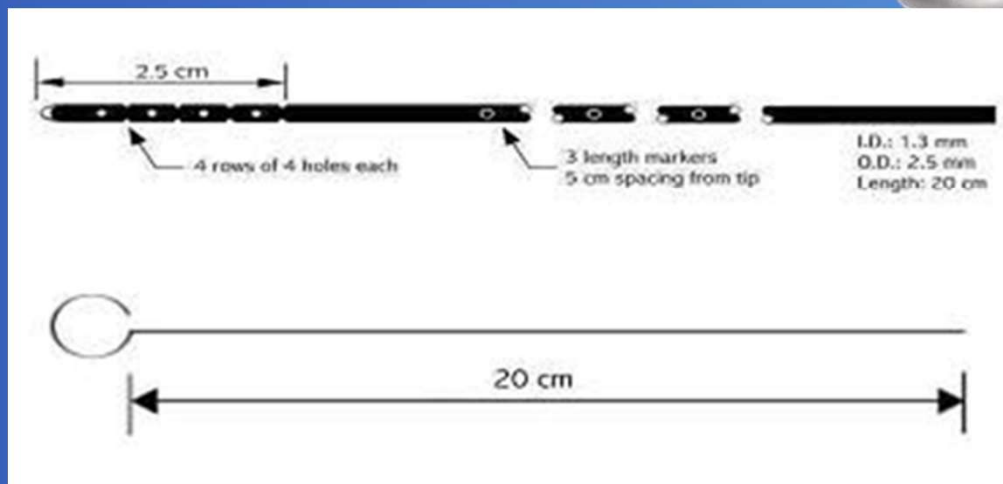

Included with product
1ea. Ventricular Catheter
Barium Impregnated

I.D.: 1.3 mm

O.D.: 2.5 mm

Length: 20 cm

1ea. Stainless Steel Stylet (20 cm)

BMI® Medical

Distal Catheter 03107

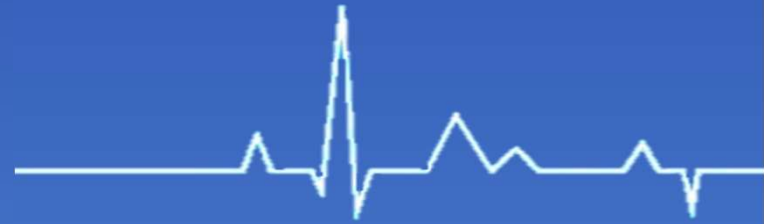

Barium-impregnated silicone catheter provides resistance to kinking and compression. All catheter impregnated with white barium to provide radiopacity and resistance to catheter kinking and compression.

The proximal tip is filled with tantalum-impregnated silicone elastomer.

CSF fluid flow from 4 slit openings prevent penetration and the obstruction of the catheter.

Free-flow slit openings design to eliminate distal end migration.

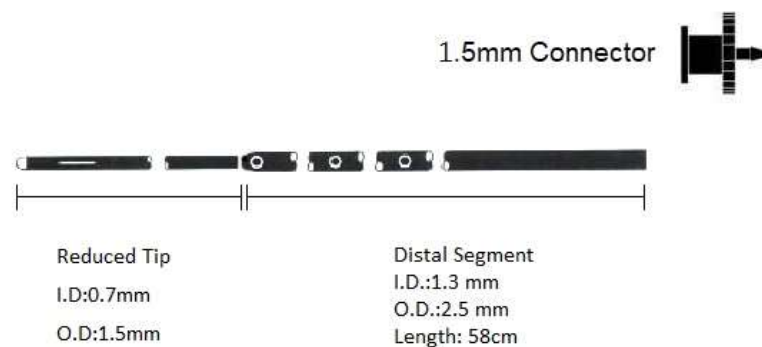

Included with product

1ea. Distal Catheter

Barium Impregnated

I.D.: 1.3 mm

O.D.: 2.5 mm

Length: 58 cm

1ea. Connector (1.5 mm)

BMI® Medical

Ventricular Catheter 06115

Barium impregnated silicone catheter.

Kink and compression resistant.

The catheter is fabricated from silicone elastomer tubing impregnated with barium to provide radiopacity.

- Barium impregnation allows for visualization of the catheter on x-ray.
- non-ferrous design won't interfere with CT scans or MRI.

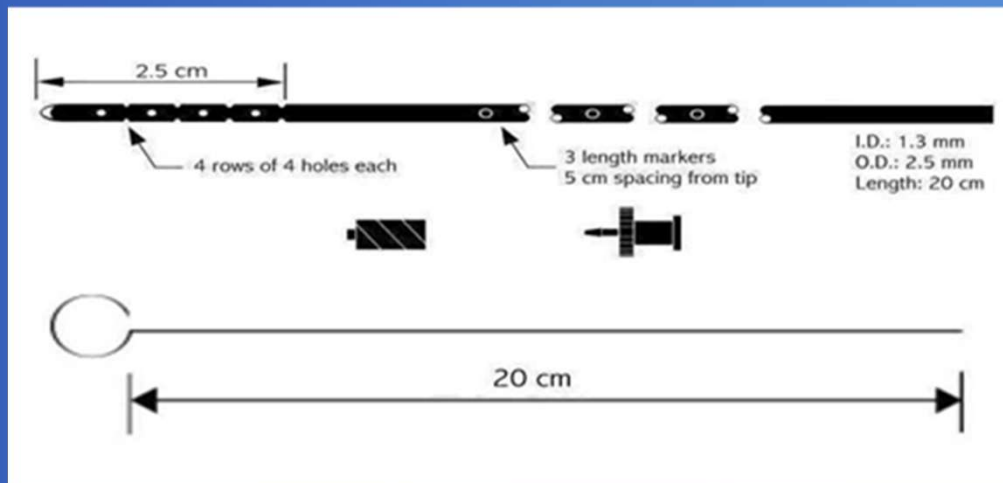
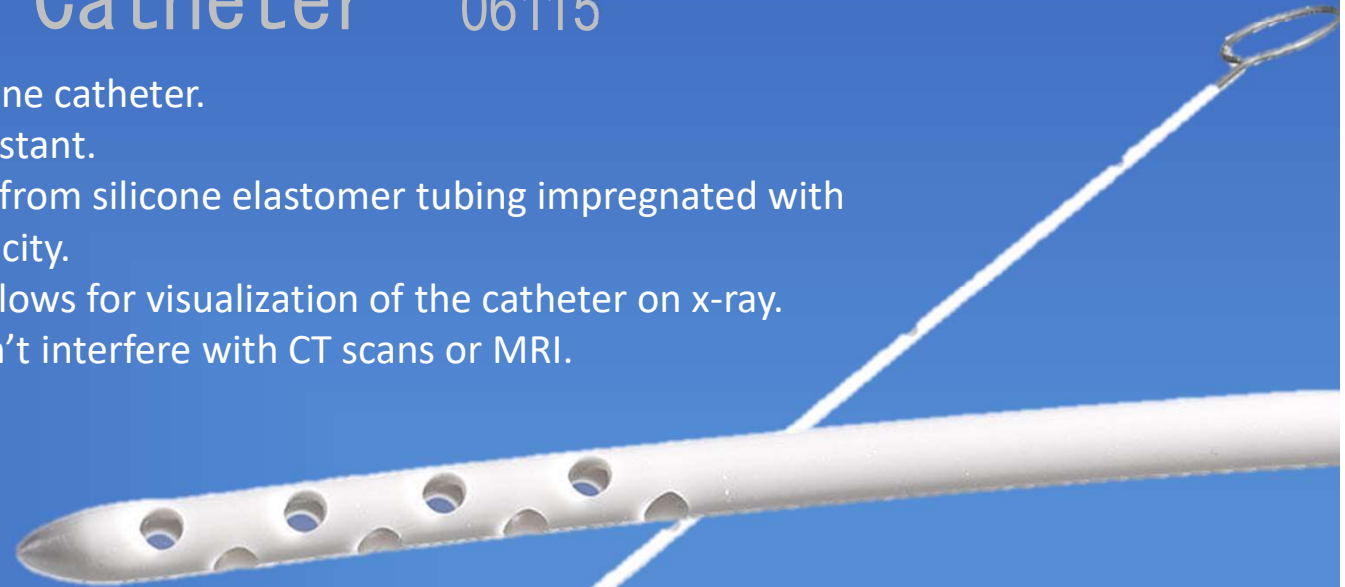

Included with product

1ea. Ventricular Catheter Barium Impregnated

I.D.: 1.3 mm

O.D.: 2.5 mm

Length: 20 cm

1ea. Luer Lock Cap

1ea. Female Luer Adapter

1ea. Stainless Steel Stylet(90cm)

BMI® Medical

Ventricular Catheter 06118、06118S



Barium impregnated silicone catheter.

Kink and compression resistant.

Stainless steel stylet allows catheter to be directed during catheter placement.

The catheter is fabricated from silicone elastomer tubing impregnated with barium to provide radiopacity.

- Barium impregnation allows for visualization of the catheter on x-ray.
- non-ferrous design won't interfere with CT scans or MRI.

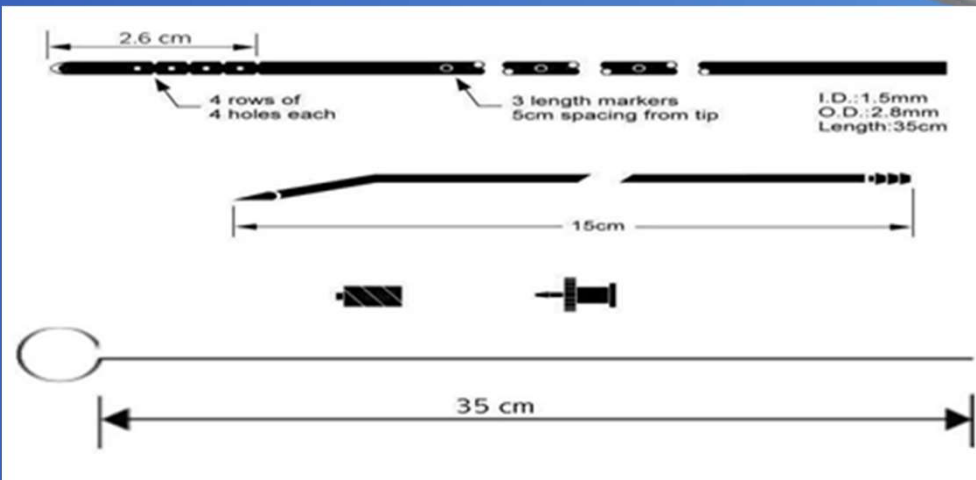
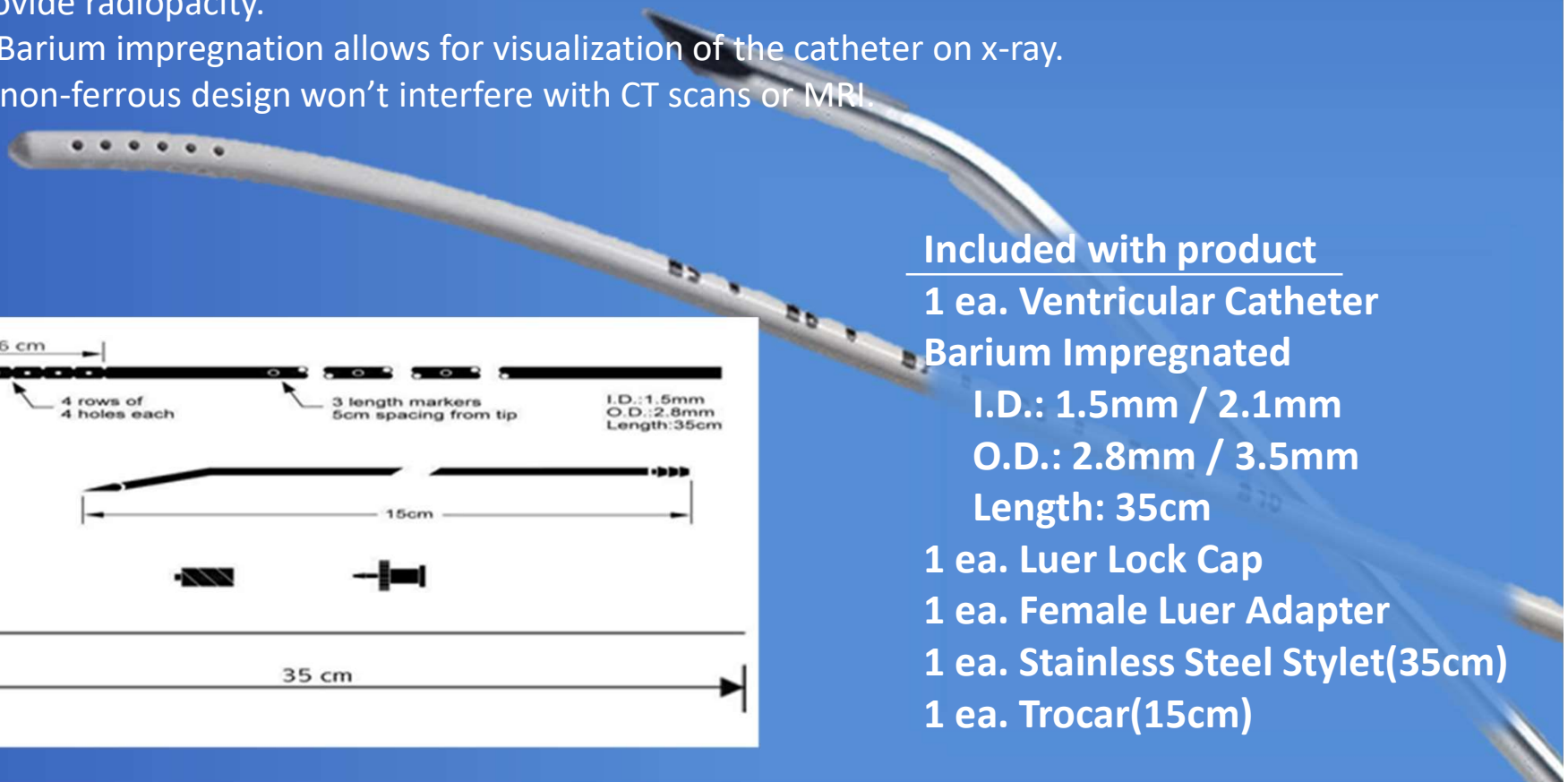

Included with product

1 ea. Ventricular Catheter
Barium Impregnated

I.D.: 1.5mm / 2.1mm

O.D.: 2.8mm / 3.5mm

Length: 35cm

1 ea. Luer Lock Cap

1 ea. Female Luer Adapter

1 ea. Stainless Steel Stylet(35cm)

1 ea. Trocar(15cm)

BMI® Medical

Antibacterial Ventricular Catheter 26118

The Antibiotic-Impregnated Catheters reduce the colonization of gram-positive bacteria using a combination of rifampicin and silver salts.

Features

1. Impregnated with two antibiotics: rifampicin and silver salts
2. Show to reduce colonization of gram-positive bacteria on all catheter surfaces.
3. Features same-sized tubing as our standard non-antibiotic-impregnated catheters to resist kinking and compression.
4. Barium impregnation allows for visualization of the catheter on x-ray.
5. non-ferrous design won't interfere with CT scans or MRI.

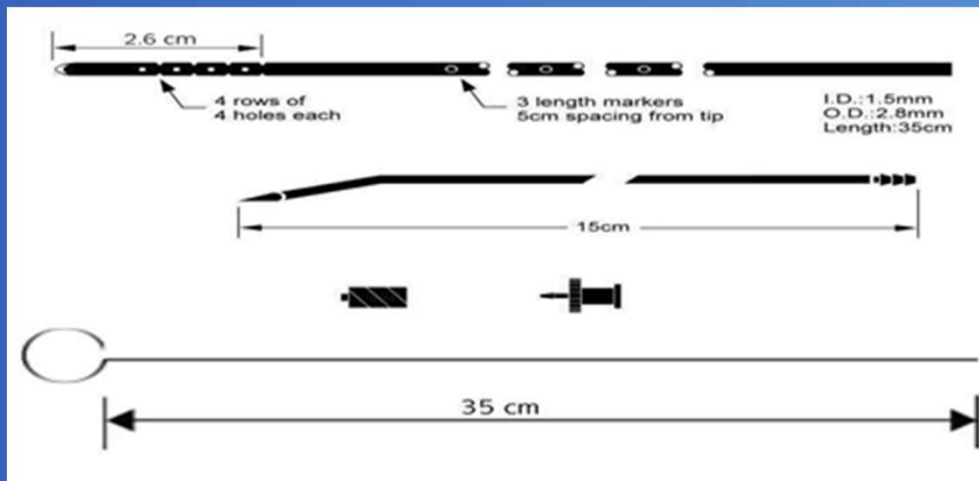

Included with product

1 ea. Ventricular Catheter
Barium Impregnated

I.D.: 1.5mm / 2.1mm

O.D.: 2.8mm / 3.5mm

Length: 35cm

1 ea. Luer Lock Cap

1 ea. Female Luer Adapter

1 ea. Stainless Steel Stylet(35cm)

1 ea. Trocar(15cm)

BMI® Medical

Peritoneal Catheter (L. M. H) 03103、03105

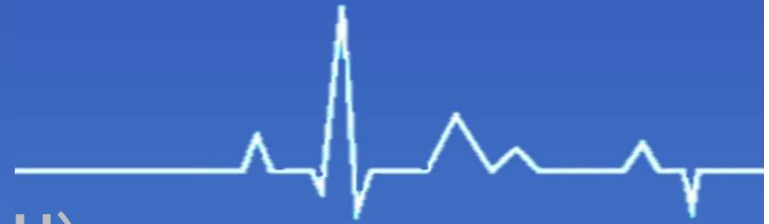

Peritoneal Catheter, Small, Barium Impregnated, 90cm, a pressure valve at the tip, 4 slit openings at the distal end. High, Medium, Low pressure are available according to the size of slit.



03103

I.D.: 1.3 mm /O.D.: 2.5 mm/Length: 75-100 cm



03105

I.D.: 1.3 mm /O.D.: 2.5 mm/Length: 90-100 cm

Features

1. Tubing impregnated with white barium to provide radiopacity.
2. Pressure control valve.
3. Enable the surgeon to gauge and adjust its length.

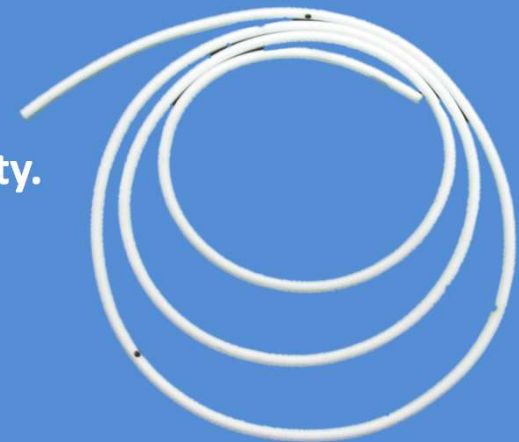

BMI® Medical

External Drainage Monitoring System 06128

Draining cerebrospinal fluid(CSF) from the lateral ventricles of the brain or the lumbar subarachnoid space.

Monitoring (CSF) pressure and flow rate from the lateral ventricles of the brain or the lumbar subarachnoid space.

Reduce intracranial pressure(ICP)

Features

1. **Hydrophobic filter prevents passage of bacteria and eliminates negative pressure artifacts.**
2. **Two convenient injection sites allow sampling and intraventricular medication.**
3. **Sliding chamber allows accurate flow monitoring**
4. **Locking bracket is incorporated in the chamber for quick, accurate pressure head setting.**
5. **Large capacity drainage bag (700ml) may be disconnected for replacement or emptied for re-use.**
6. **Pressure monitoring can be performed at either the mounting panel or patient line port.**
7. **System panel is adjustable by using either the locking cord or mounting bracket.**

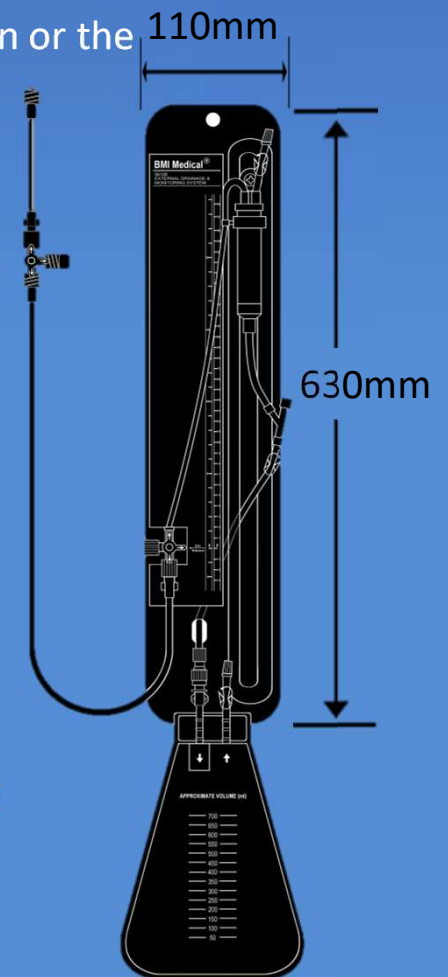

BMI® Medical

Drainage Bag 06124

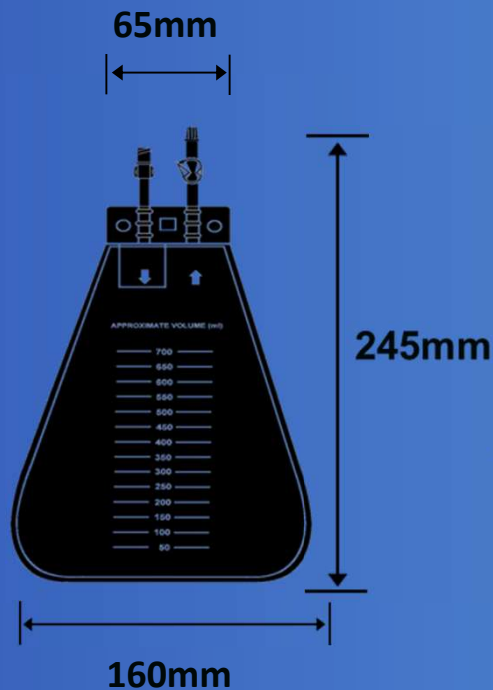
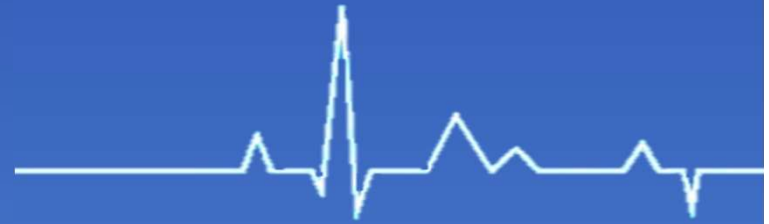

EDMS Drainage Bag

1. Bacteria barrier filter
2. Fixation tabs
3. Preventing backflow
4. 700 ml capacity

Features

1. Bacteria barrier filter at the opening of the bag reduces effect of negative pressure and closes the system to bacteria.
2. Drainage bag connects easily and securely to EDMS Patient Connection Line.
3. Prevent back of fluid toward patient.
4. With measurement scale, enable monitoring flow capabilities.

BMI® Medical

CSF Valve Burr Hole (L. M. H) 02512、02514

Two sizes are available: 12mm/14mm. (Pediatric/Adult)
High, Medium, Low pressure are available .

Features

1. Flexible silicone elastomer eliminating valve sticking and deformation.
2. Connector included.
3. Internal flow path is uncomplicated.
4. Two-way flushing eliminates separate reservoirs or antechambers.
5. Non-metallic design will not interfere with CT scans or MRI.
6. Polypropylene needle guard prevents complete penetration of the valve by needles.
7. Silicone elastomer dome is injectable.

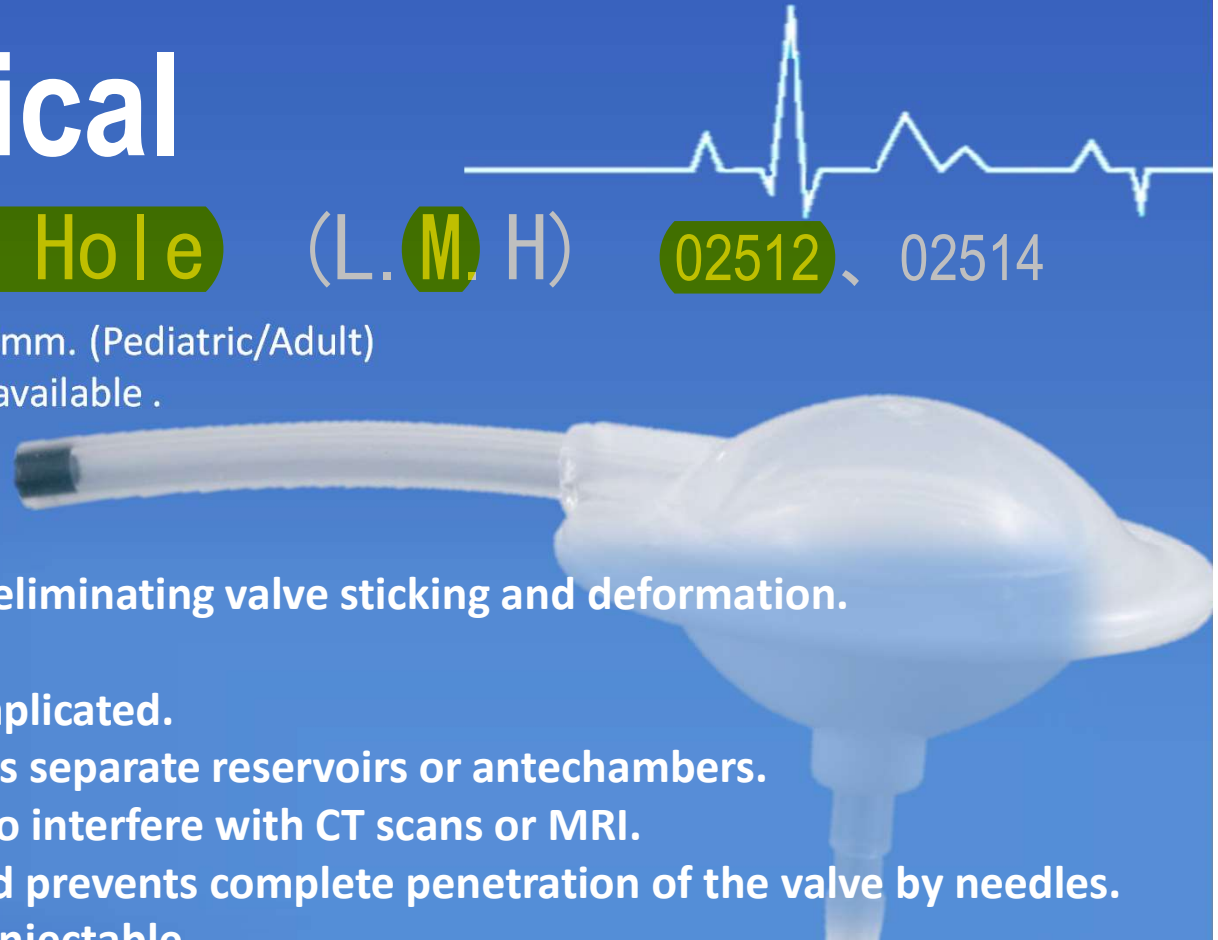
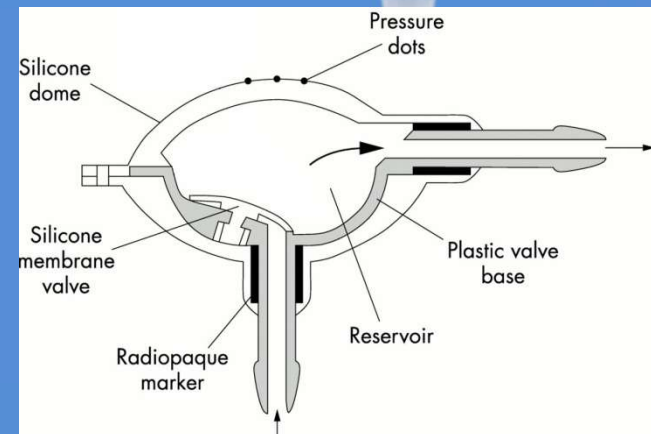
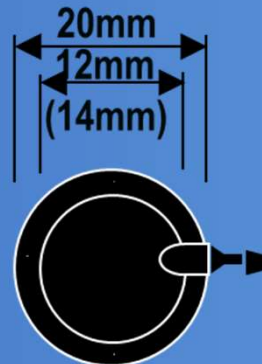
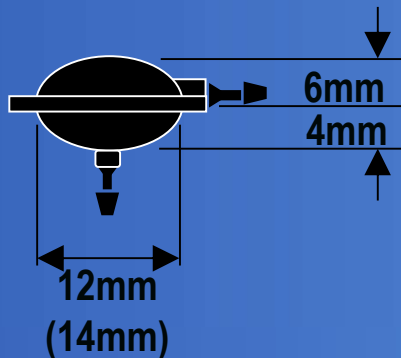

BMI MEDICAL
Peritoneal Catheter 23105 (L, M, H)

Features :

1. **Impregnated with two antibiotics:** rifampicin and Silver Salts
 2. Show to reduce colonization of gram-positive bacteria on all catheter surfaces.
 3. Features same-sized tubing as our standard non-antibiotic-impregnated catheters to resist kinking and compression.
 4. Barium impregnation allows for visualization of the catheter on x-ray.
 5. non-ferrous design won't interfere with CT scans or MRI.
-

Description

The Antibiotic-Impregnated Catheters were designed with the same diameters as our standard catheters for seamless connection to all Wellong shunt valves. High, Medium, Low pressure are available according to the size of slit. The spherical tip of catheter is tantalum-impregnated. CSF flow from 4 wall slits around the circumference of the catheter near the tip. The graphitic markers are imprinted at each 10 cm from the tip. All impregnate with white barium to provide radiopacity fully.

23105 Peritoneal Catheter (L, M, H)

I.D.:1.3 mm
O.D.:2.5 mm
Length: 90~120 cm



1.5mm Connector



Indications

The Peritoneal Catheters is designed as the distal component of a flow control shunt for use in shunting cerebrospinal fluid from the ventricles of the brain into the peritoneal cavity.

Instructions for use

A variety of surgical techniques may be utilized in placing the catheters into peritoneal cavity. Position of placement is at the discretion of the surgeon.

Peritoneal Catheter Patency Check

Place Peritoneal Catheter into sterile physiological saline and check the patency before implant. See figure below, first fill 1 with saline, then connect with 2 and 3. Press 1, if saline flows out from the tip, the catheter passes the patency test.

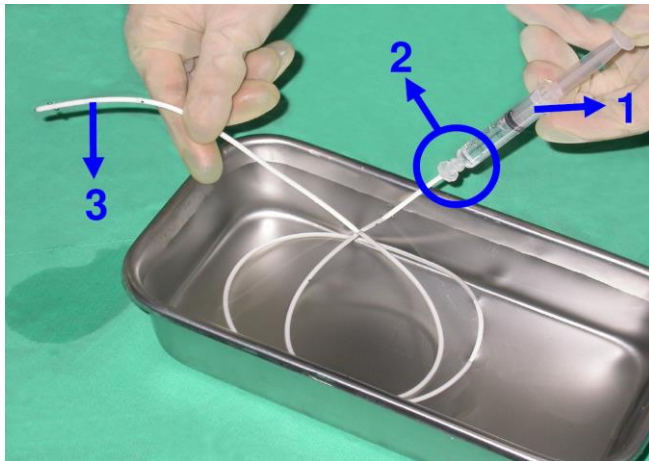

1. Syringe
2. Connector
3. Peritoneal Catheter

BMI[®] Medical

CSF-Flow Control Valve (L. M. H) 02812



1. Patient's position

When patient lying down at horizontal position, pressure (high, medium or low) will be controlled via pressure membrane of the valve.

2. Function of slit valve

When patient's position is changing uplifting to vertical position (sitting or standing position), there's negative pressure caused by changing the posture. The fluid drainage will be controlled efficiently by the slit valve at the distal end of the Peritoneal Catheter.

3. Anti-siphon effect

There are double pressure membranes to control the flow in only one direction and avoid over drainage by preventing siphoning effect.

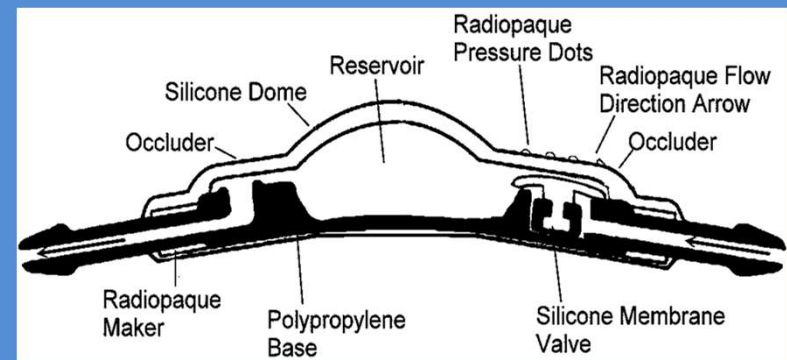
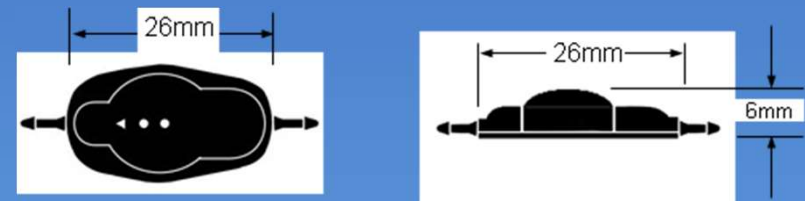

BMI® Medical

CSF-Flow Control Valve Small (L.M.H) 04120



1. Patient's position

When patient lying down at horizontal position, pressure (high, medium or low) will be controlled via pressure membrane of the valve.

2. Function of slit valve

When patient's position is changing uplifting to vertical position (sitting or standing position), there's negative pressure caused by changing the posture. The fluid drainage will be controlled efficiently by the slit valve at the distal end of the Peritoneal Catheter.

3. Anti-siphon effect

There are double pressure membranes to control the flow in only one direction and avoid over drainage by preventing siphoning effect.

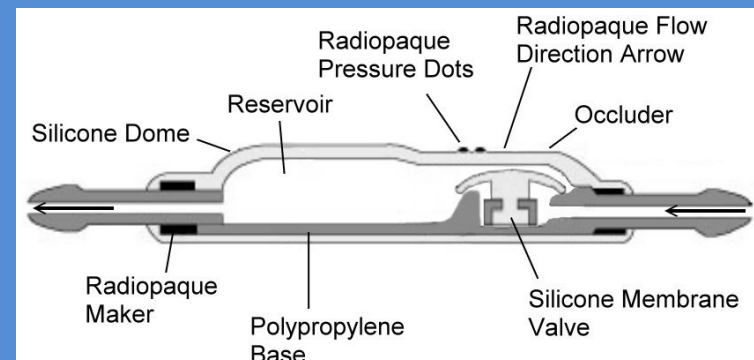
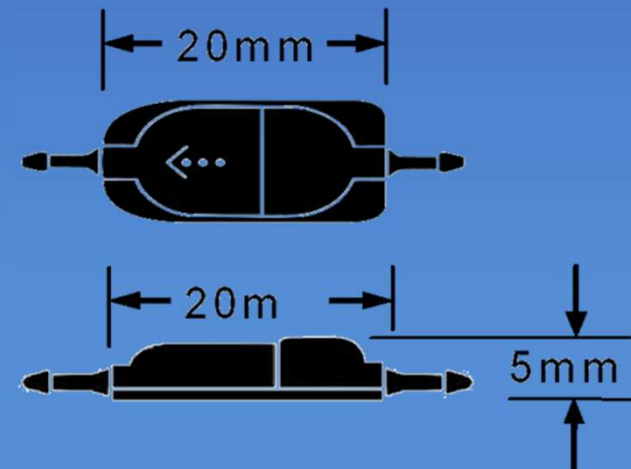

BMI[®] Medical

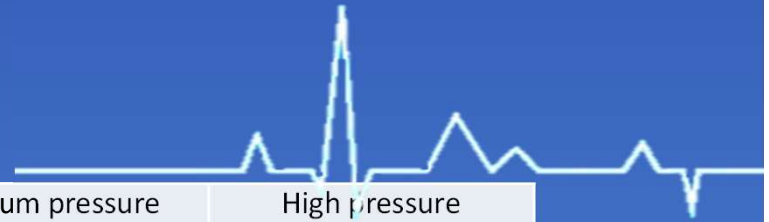

	Low Low Pressure	Low pressure	Medium pressure	High pressure
Flow rate 5 ml / hr	1 cm / H ₂ O	2 cm / H ₂ O	6 cm / H ₂ O	12 cm / H ₂ O
Flow rate 50 ml / hr	3 cm / H ₂ O	8 cm / H ₂ O	14 cm / H ₂ O	20 cm / H ₂ O
remark	

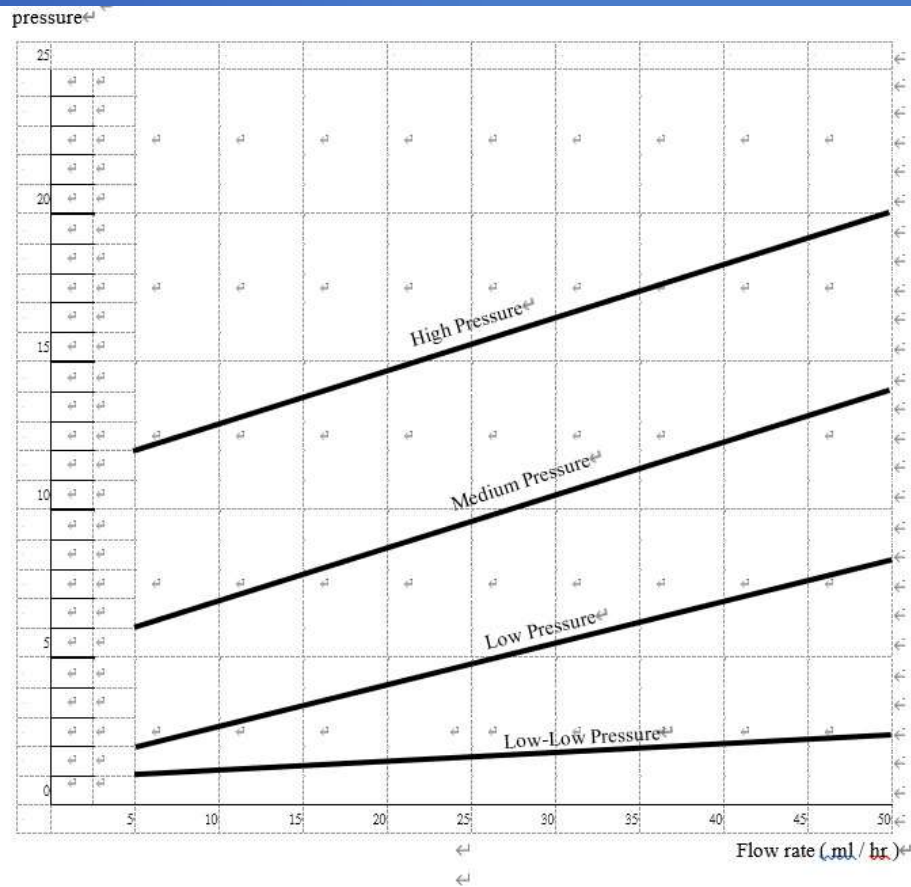

Flow rate between 5~50 ml / hr : tolerance ± 2 cm / H₂O

Pressure / Flow Characteristics

BMI® Medical

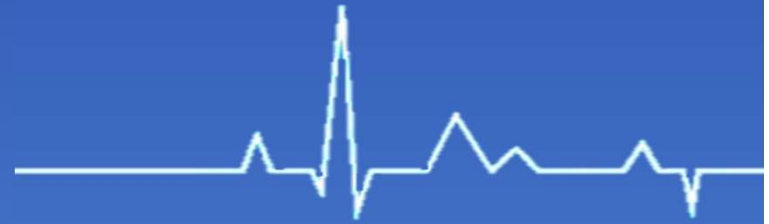

Shunting System-Instructions for Use

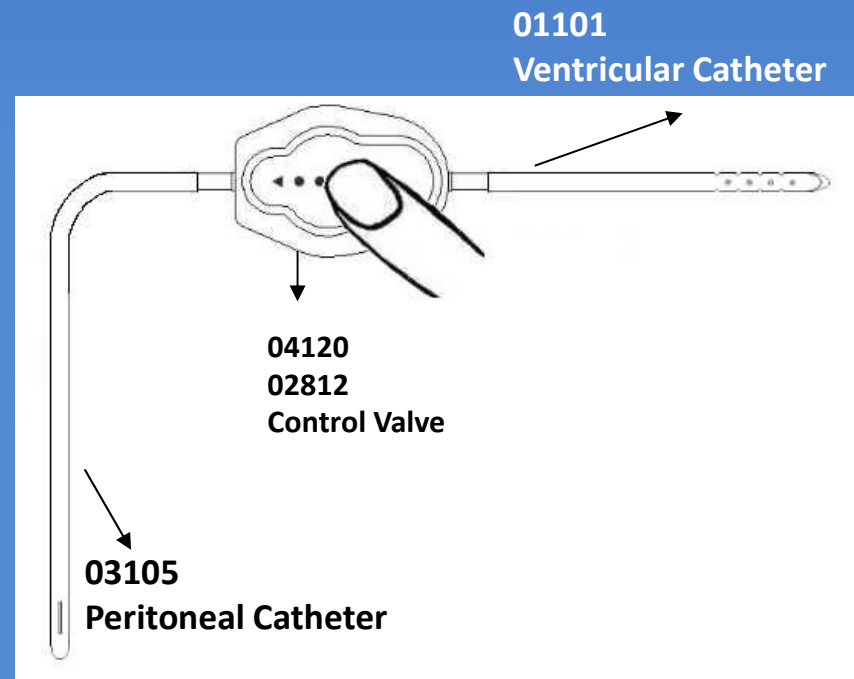
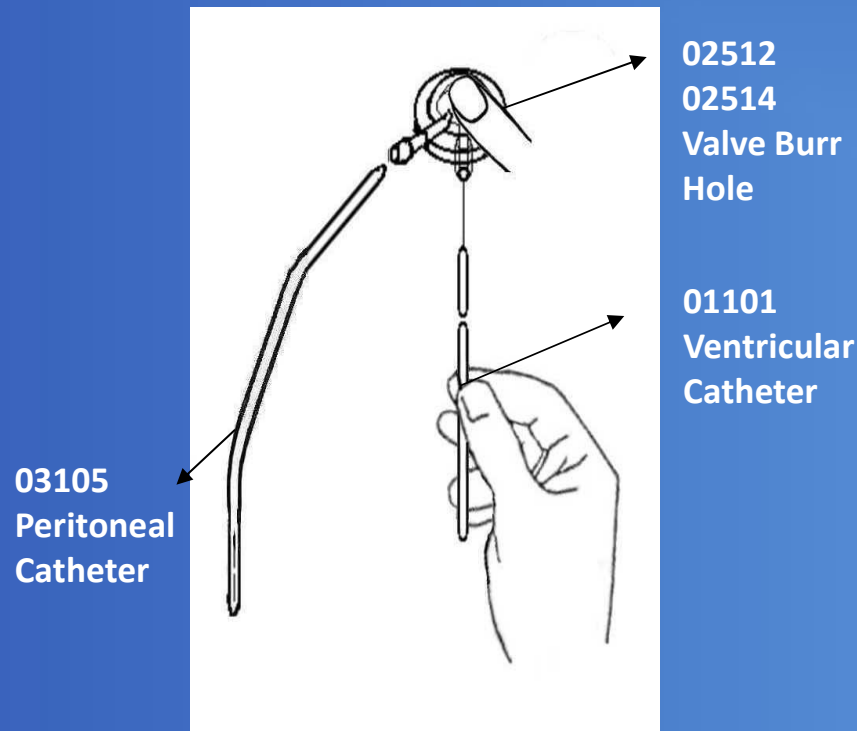

BMI® Medical

Anti-Siphon 04118

Anti-Siphon Device are fabricated of dissimilar materials, thus provides resistance to sticking and deformation. The plastic connector contributes structural integrity, and facilitate connecting the catheter and the connector.

Features

1. Flexible silicone elastomer eliminating valve sticking and deformation.
2. Connector included.
3. Internal flow path is uncomplicated.
4. Two-way flushing eliminates separate reservoirs or antechambers.
5. Non-metallic design will not interfere with CT scans or MRI imaging.

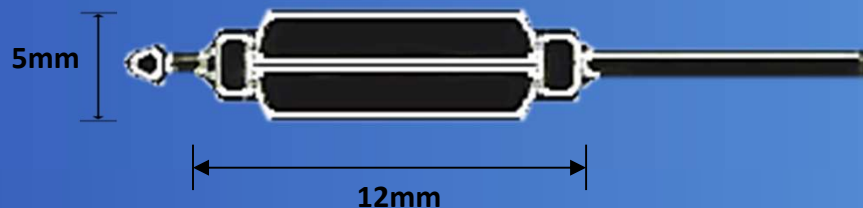
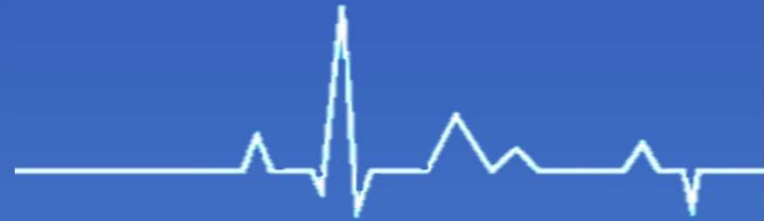

BMI® Medical

Anti-Siphon Burrhole Child 04121 (02512+04118)

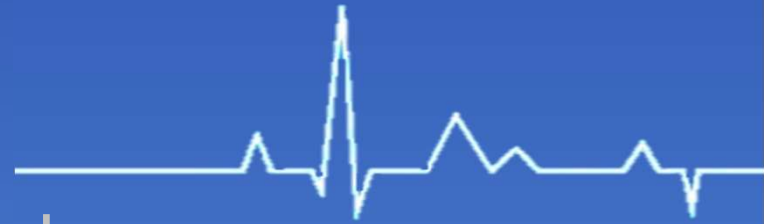

Features

1. Flexible silicone elastomer eliminating valve sticking and deformation.
2. Connector included.
3. Internal flow path is uncomplicated.
4. One-way flushing eliminates separate reservoirs or antechambers.
5. Non-metallic design will not interfere with CT scans or MRI imaging.



BMI® Medical

Anti-Siphon Burrhole Adult 04123 (02514+04118)

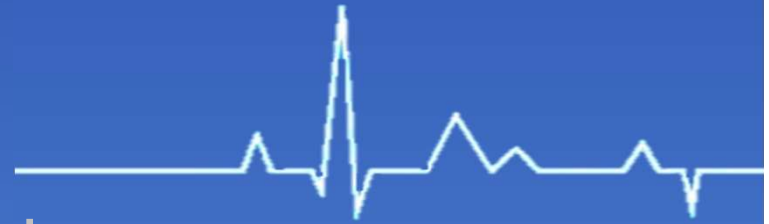

Features

1. Flexible silicone elastomer eliminating valve sticking and deformation.
2. Connector included.
3. Internal flow path is uncomplicated.
4. One-way flushing eliminates separate reservoirs or antechambers.
5. Non-metallic design will not interfere with CT scans or MRI imaging.



BMI® Medical

Anti-Siphon Contoured Child 04125 (04120+04118)

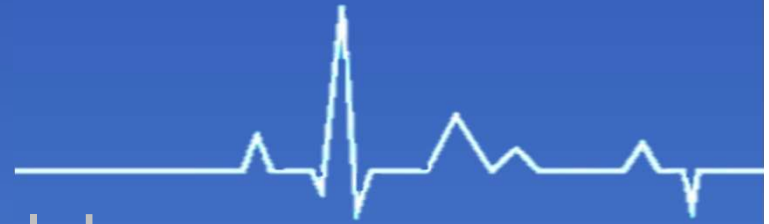

Features

1. Flexible silicone elastomer eliminating valve sticking and deformation.
2. Connector included.
3. Internal flow path is uncomplicated.
4. One-way flushing eliminates separate reservoirs or antechambers.
5. Non-metallic design will not interfere with CT scans or MRI imaging.



BMI[®] Medical

Anti-Siphon Contoured Adult 04127 (02812+04118)

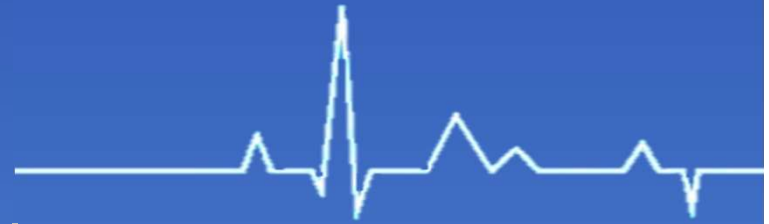

Features

1. Flexible silicone elastomer eliminating valve sticking and deformation.
2. Connector included.
3. Internal flow path is uncomplicated.
4. One-way flushing eliminates separate reservoirs or antechambers.
5. Non-metallic design will not interfere with CT scans or MRI imaging.



BMI® Medical

Patient Connection Line 06126

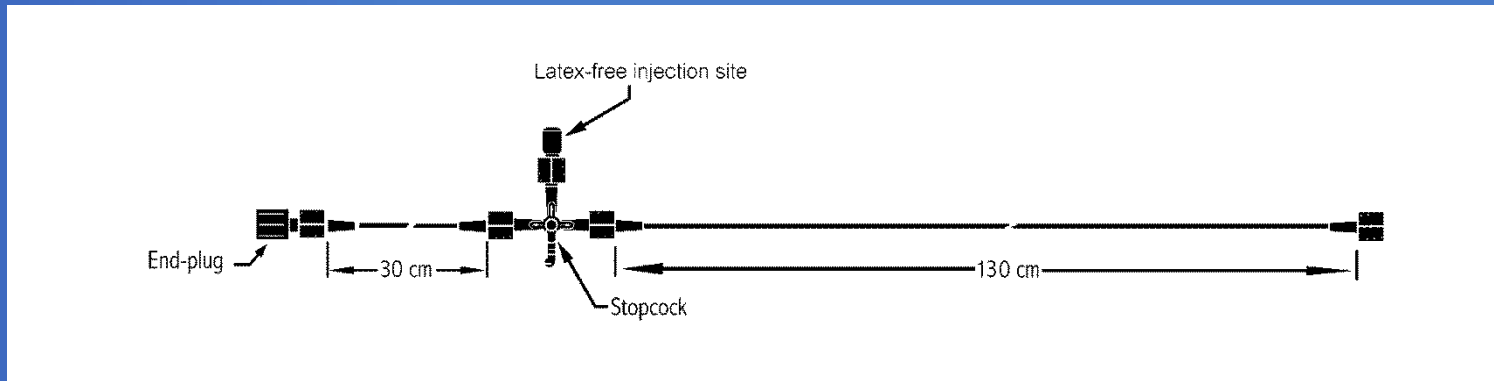
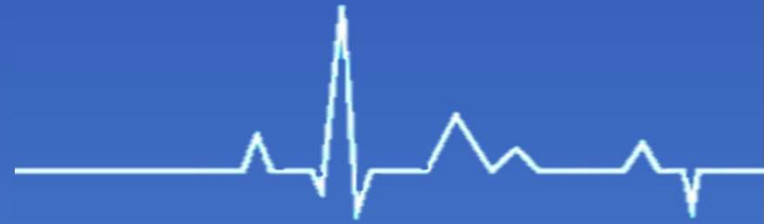

Features

1. EDMS Patient Connection Line stopcock provides easy access for fluid sampling.
2. Barium impregnated silicone catheter tubing provides resistance to kinking and compression.

BMI® Medical

CSF Uni-Shunt (L. M. H) 05106

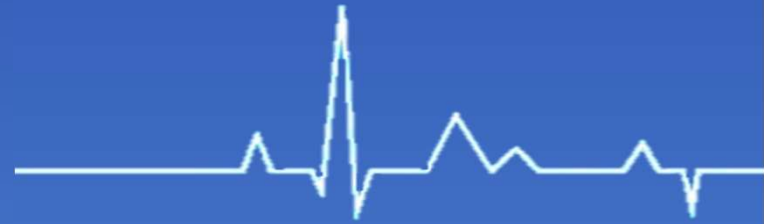

Included with product

Ventricular Catheter, Barium Impregnated, 20cm

Peritoneal Catheter, Small, Barium Impregnated, 100cm, 4 slit openings at the distal end.

High, Medium, Low pressure are available .

I.D.: 1.3 mm

O.D.: 2.5 mm

Length: 120cm

BMI[®] Medical

Ventricular Reservoir, OMMAYA 04111

Barium impregnated catheter provide, 4 rows of 4 holes each length markers of 5 cm spacing from tip. Silicone elastomer dome is injectable.

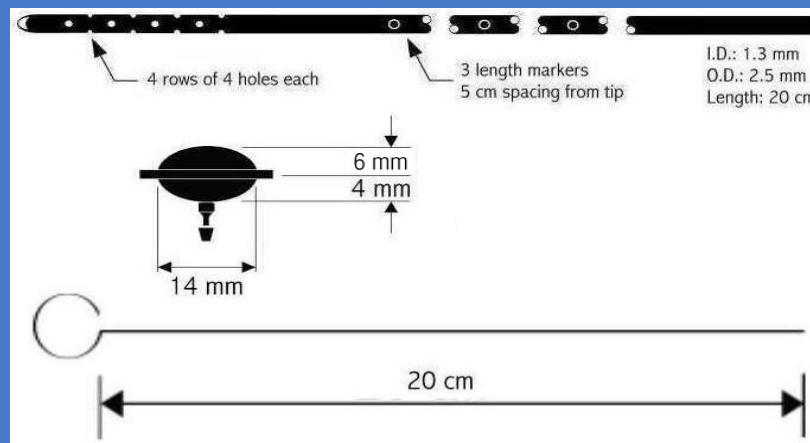

Included with product

Ventricular Reservoir, 14 mm, Burr Hole

Ventricular Catheter, Small, Barium Impregnated

I.D.: 1.3 mm

O.D.: 2.5 mm

Length: 20 cm

1ea. Stainless Steel Stylet

Kink and compression resistant

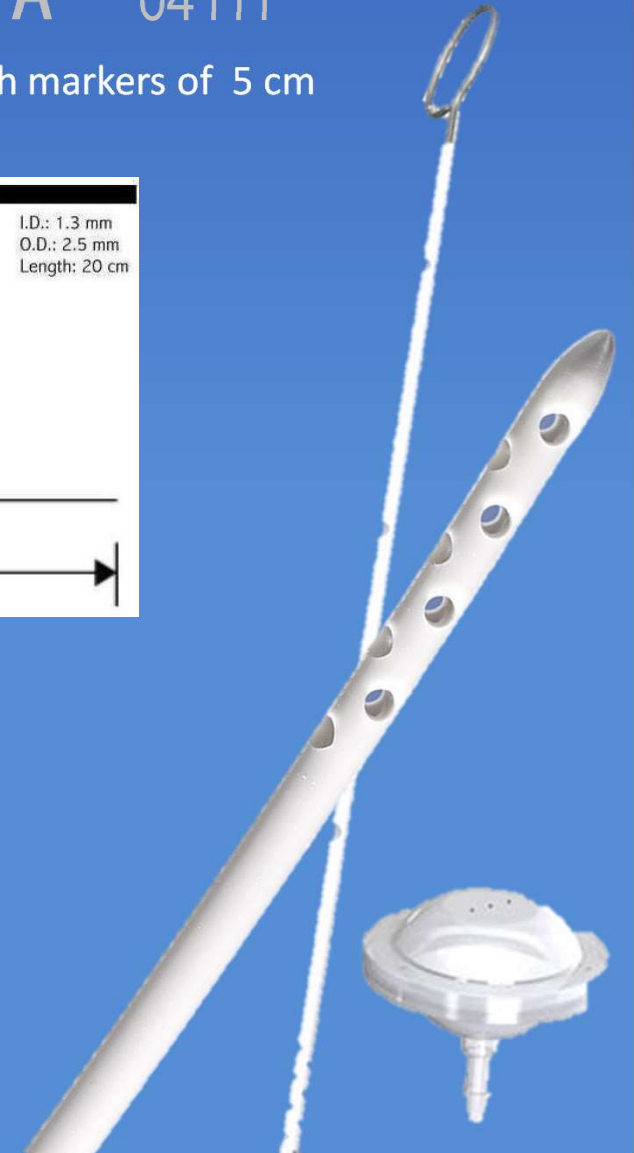

BMI® Medical

Lumbar Catheters 06418

Lumboperitoneal Shunt is designed for the diversion of CSF from the lumbar subarachnoid space into the peritoneal cavity using simplified surgical techniques.
Lumbar Catheter, 80 cm, Barium Impregnated.

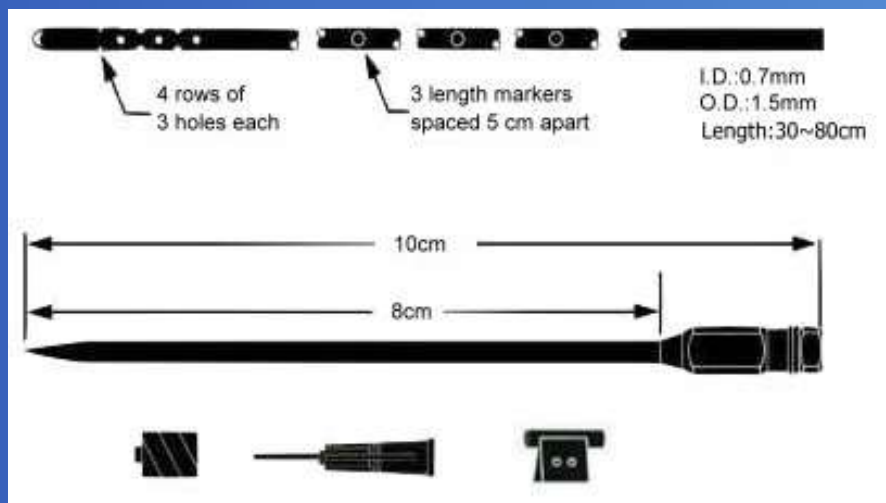
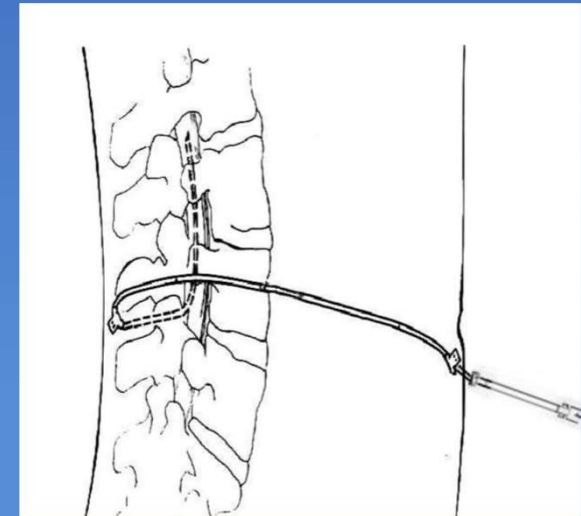
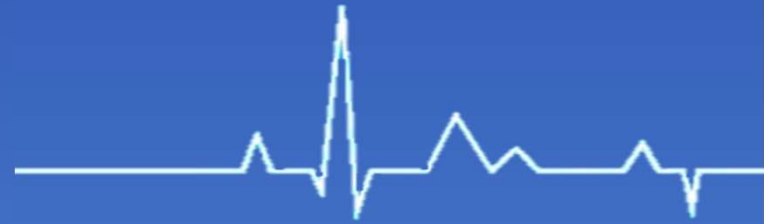

Included with product

Lumbar Catheter, Barium Impregnated

I.D.: 0.7mm

O.D.: 1.5mm

Length: 30~80cm

Tuohy Needle, 14-gauge, 9cm with Huber Tip

1ea. Luer Lock Cap

1ea. Blunt needle

2ea. Fixation tab

BMI® Medical

Lumbar Catheters 06419

Lumboperitoneal Shunt is designed for the diversion of CSF from the lumbar subarachnoid space into the peritoneal cavity using simplified surgical techniques.
Lumbar Catheter, 24 cm, Barium Impregnated (open Tip).
4 rows of 3 holes each of 17 mm at the beginning of the head.

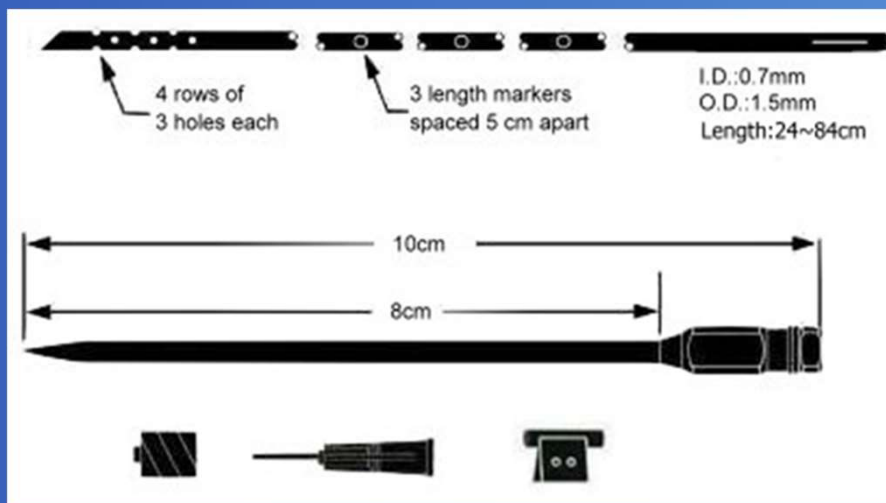
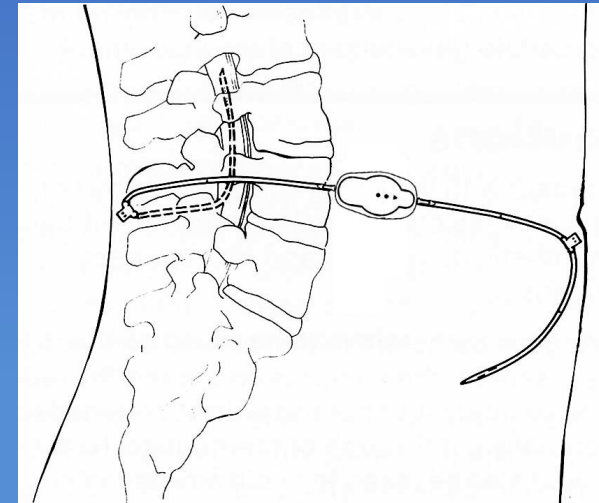
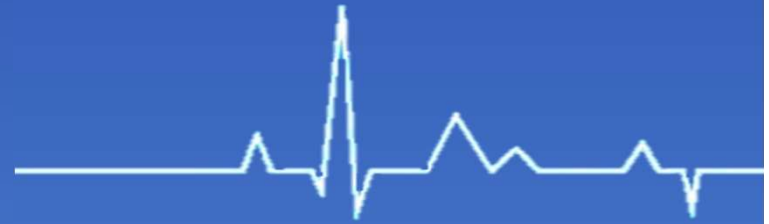

Included with product

Lumbar Catheter, Barium Impregnated

I.D.: 0.7mm

O.D.: 1.5mm

Length: 24~84cm

Tuohy Needle, 14-gauge, 9cm with Huber Tip

1ea. Luer Lock Cap

1ea. Blunt needle

2ea. Fixation tab

BMI® Medical

CSF Lumboperitoneal T-Tube Shunt

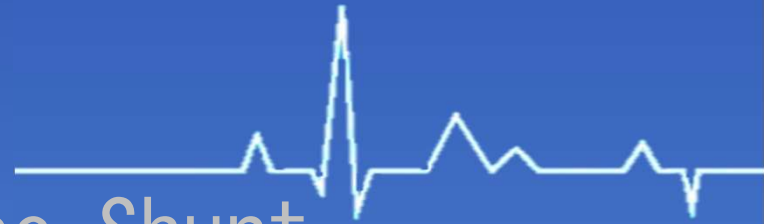

06421T、06422T

T-shaped catheter, Child 06421T

55 cm, Barium Impregnated, with 14mm slit valves

I.D.: 0.7mm

O.D.: 1.5mm

Length: 55cm

5cm T portion has 16 proximal holes

1 CSF-Catheter Connector, Straight

2 fixation tab

T-shaped catheter, Adult 06422T

80 cm, Barium Impregnated, with 14mm slit valves

I.D.: 0.7mm

O.D.: 1.5mm

Length: 80cm

8cm T portion has 32 proximal holes

1 CSF-Catheter Connector, Straight

2 fixation tab

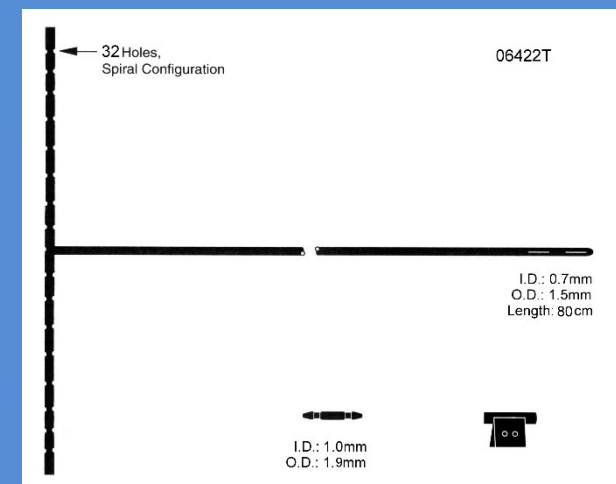
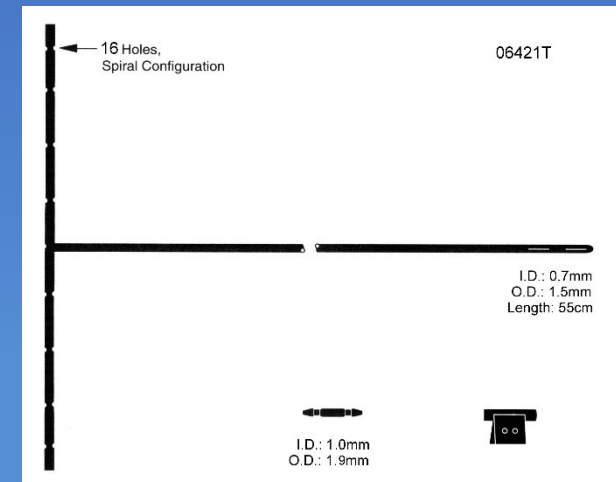

BMI[®] Medical

CSF Catheter Connector 05103、05104、05105

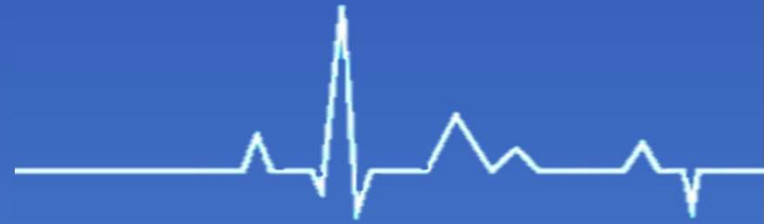

Catheter Connector, Straight 05103:

The CSF-Catheter Connector, Straight, is a polypropylene connector designed for use with CSF-Peritoneal Catheters, Ventricular Catheter.



I.O.: 1.0mm
O.D.:1.9mm

Catheter Connector, Right Angle 05104:

The CSF-Catheter Connector, Right Angle, is a polypropylene connector designed for use with Ventricular Catheter and CSF-Peritoneal Catheters.

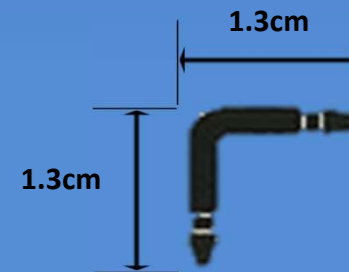

I.O.: 1.0mm
O.D.:1.9mm

Catheter Connector, 3-Way 05105:

The CSF-Catheter Connector, 3-Way is a polypropylene elastomer connector designed to connect CSF-Ventricular Catheters to a CSF-Flow Control Valve inlet connector and CSF-Peritoneal Catheters.

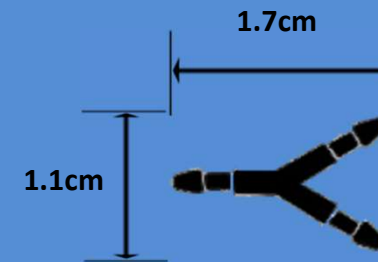

I.O.: 1.0mm
O.D.:1.9mm

BMI® Medical

Bulb Drainage System 06648

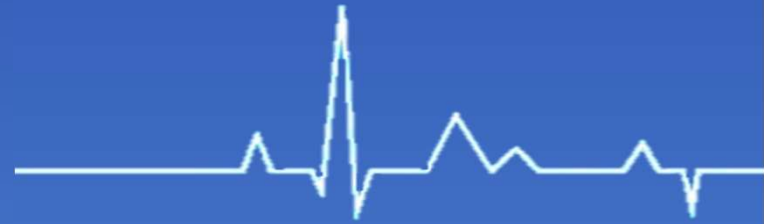

Bulb Drainage Catheter 7 mm (Flat) 066148-1

I.D.: 2.8 mm

O.D.: 4.8 mm

Length: 75 cm



Bulb Drainage Catheter 10 Fr. (Round) 06648-2

I.D.: 1.5 mm

O.D.: 3.3 mm

Length: 60 cm



Bulb Reservoir 100 c.c. 06648-3

Bulb Drainage Catheter 10 mm (Flat) 06648-4

I.D.: 2.8 mm

O.D.: 4.8 mm

Length: 75 cm

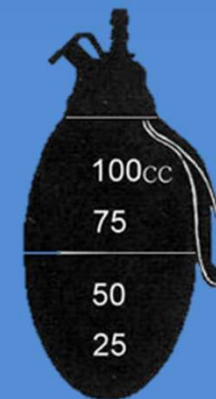

Bulb Drainage Instructions

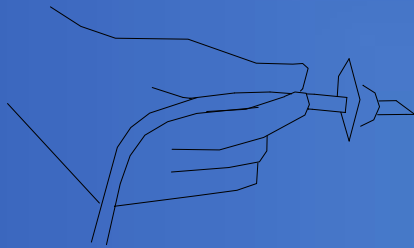

1. Starting with trocar inside wound, push trocar through to a separate exit site 2 to 5 cm from the wound.

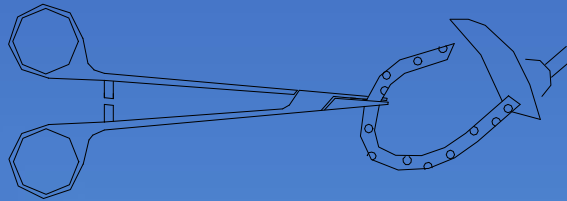

2. Cut catheter section with holes to needed wound length and insert into wound site.
CAUTION: Make sure all drainage holes are contained tissue in order to maintain suction.

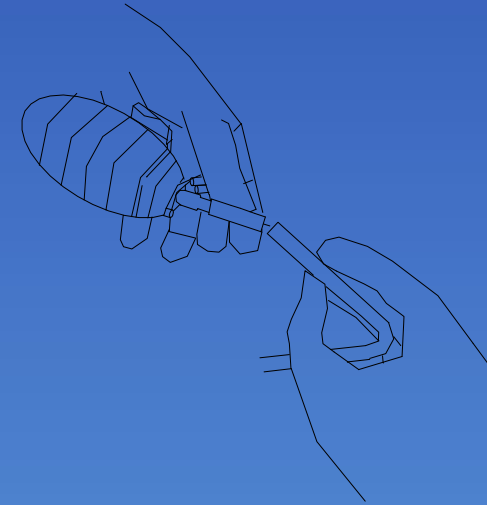

3. Cut off trocar, place slide clamp on catheter, and attach catheter to connector with a pushing and twisting motion
CAUTION: Check tubing seals at all connecting points

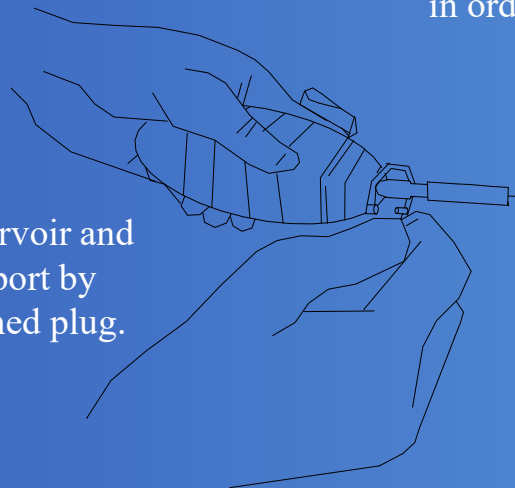

4. Squeeze reservoir and close FLUSH port by inserting attached plug.

5. TO empty or reset, open FLUSH port, FLUSH contents into appropriate container, compress reservoir and reseal port.
NOTE: For optimal drainage place the reservoir below wound site.

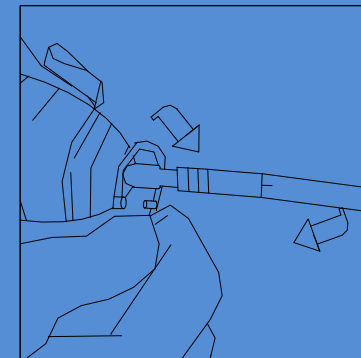

BMI® Medical

Tool : Passer

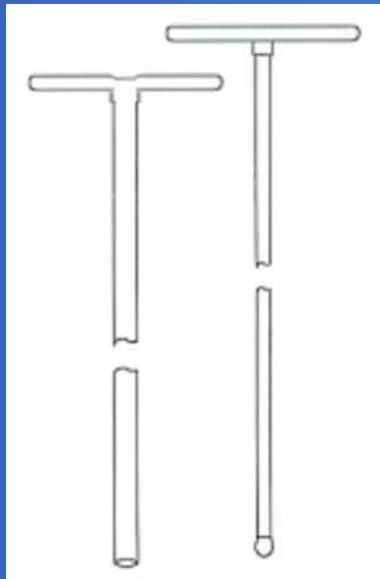
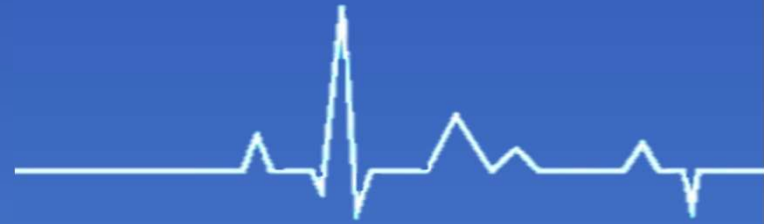

Catheter Passer
R-4201 40cm Length
R-4202 60cm Length

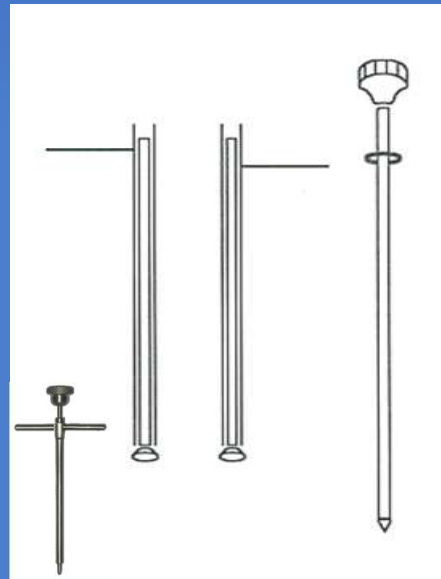

Peritoneal Trocar set of 3
R-4215

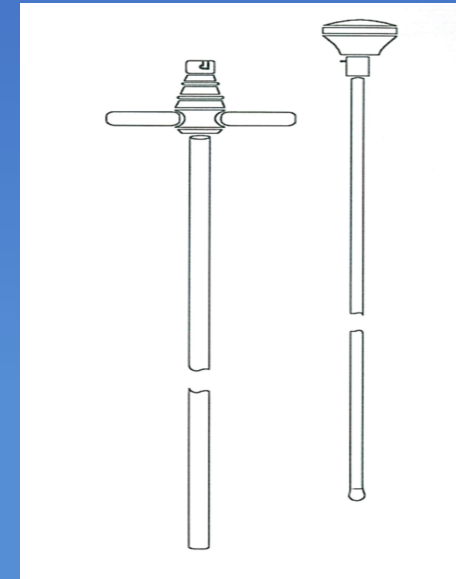

Subcutaneous Catheter Passer
R-48405 60cm Length
R-48403 40cm Length

BMI® Medical



Tool : Disposable Catheter Passer US-62

Indications

The Disposable Catheter Passer is indicated for use as a subcutaneous guide in the placement of a hydrocephalic catheter for ventriculo-peritoneal shunting of CSF.

Length:

US-62 38cm

US-62 60cm



BMI® Medical

Tool

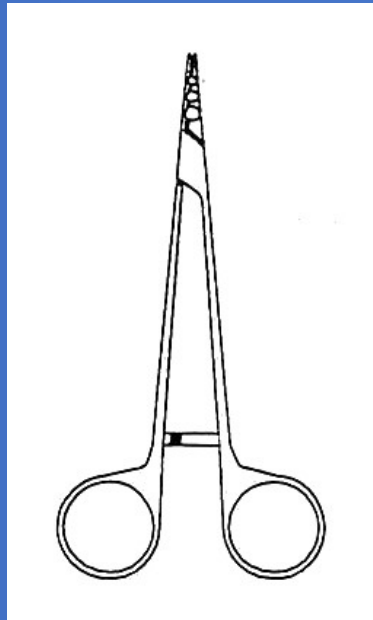
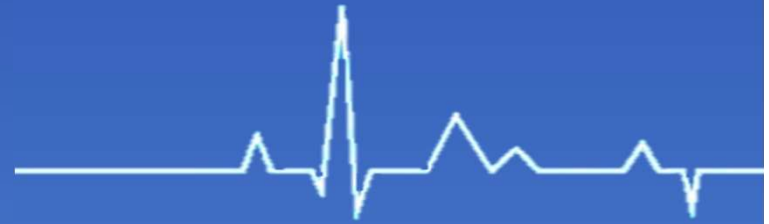

Catheter Forceps
R-1999
Size: 5 1/2

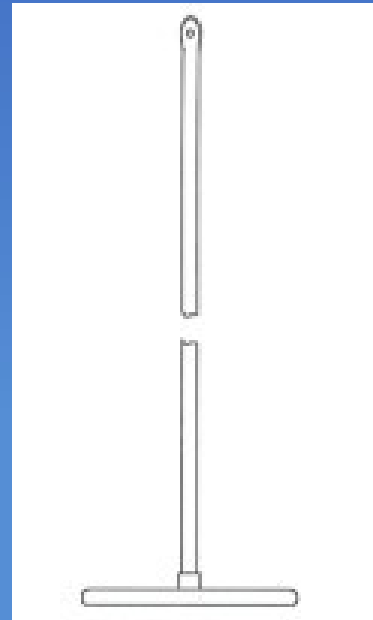

Tendon Passer
R-4100 30cm Length

BMI® Medical

Tool

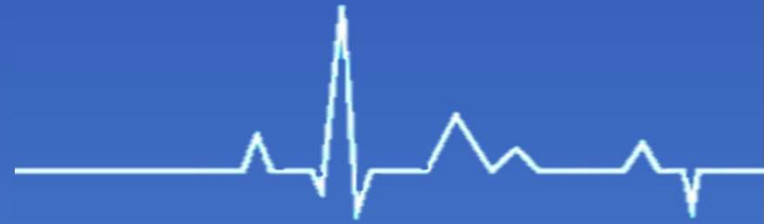

**Ventricular Catheter Cannular & Stylet, soft
R-2100 11.5cm Length**



**Ventricular Catheter Cannular & Stylet, S. S
R-2101 12.5cm Length**

BMI® Medical

Tool

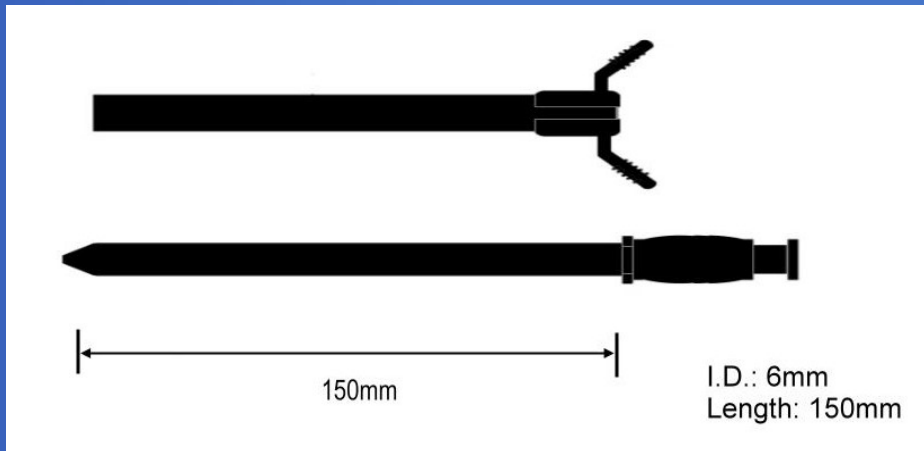
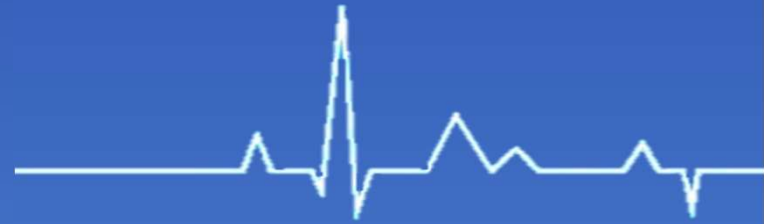

Ventricular Cannula & Stylet, soft

R-2105

I.D.: 6mm

O.D.:7mm

15cm Length

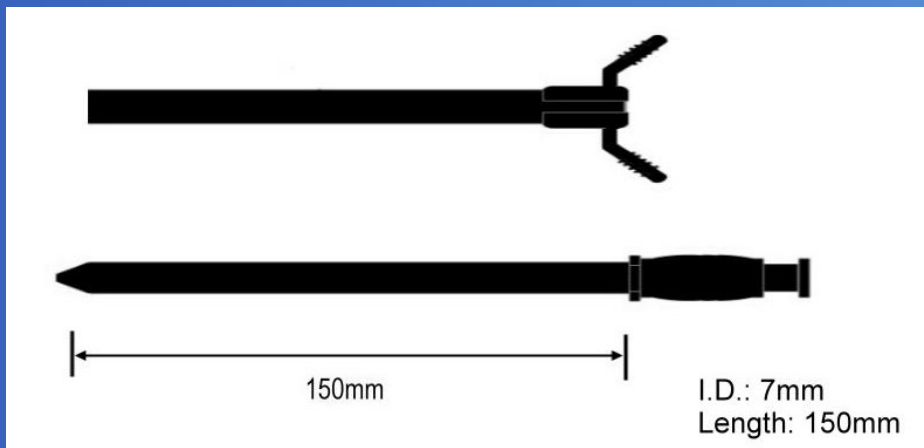

Ventricular Cannula & Stylet, soft
(Translucent)

R-2105T

I.D.: 7mm

O.D.:8mm

15cm Length

BMI[®] Medical

Titanium Cranial Bone Flap

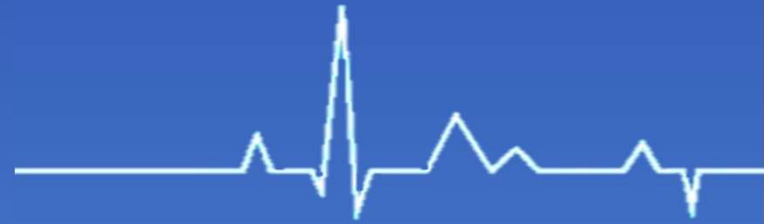

The Titanium Cranial Bone Flap Skull Fix is designed for rapid and stable fixation of cranial bone flaps to the surrounding cranium following a craniotomy.

150-0010-4

Titanium Cranial Bone Flap Fix, 1set.

Dia. ψ 14mm

150-0010-5

Titanium Cranial Bone Flap Fix, 1set.

Dia. ψ 16mm

150-0010-6

Titanium Cranial Bone Flap Fix, 1set.

Dia. ψ 18mm

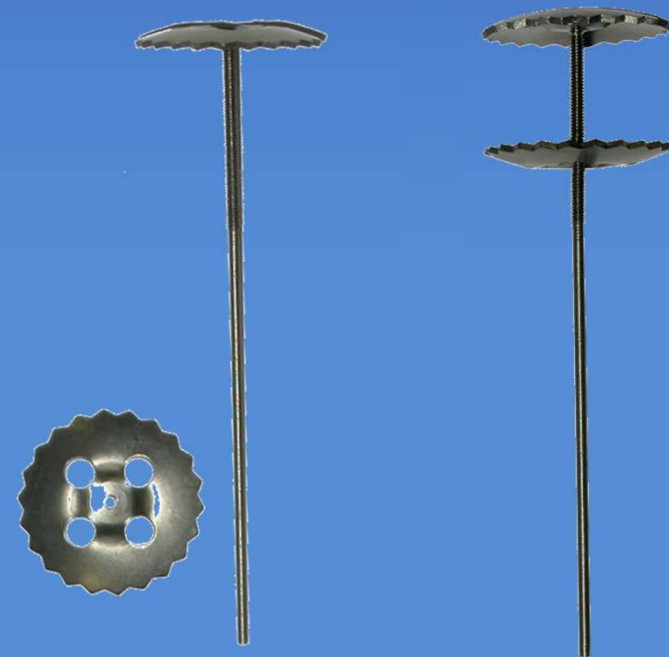

Titanium Cranial Bone Flap Skull Fix Instructions - method one

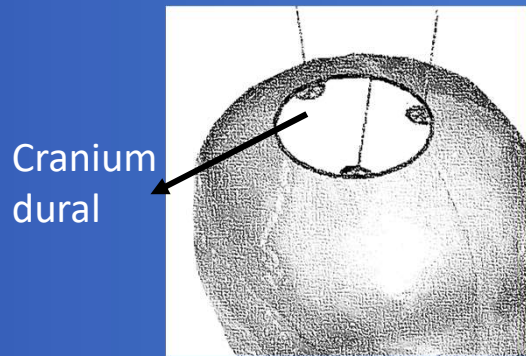

1. Place the three skull fix disks on proper positions of the cranium.

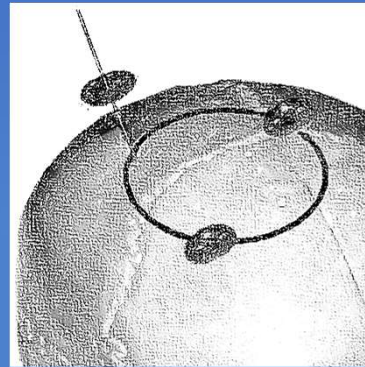

2. Reattach the removed part of cranial bone flap.

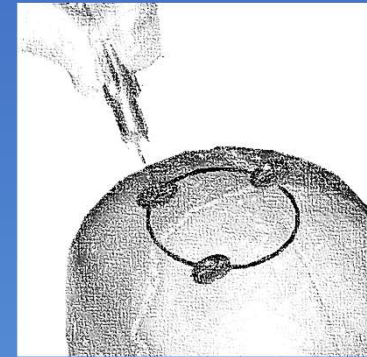

3. Place the upper disk, put the wrench on top.

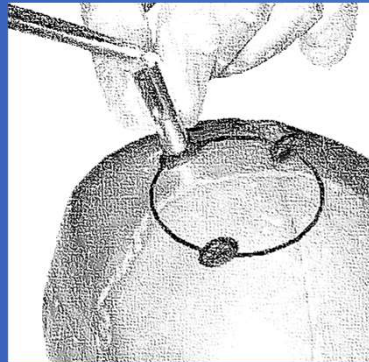

4. Use a clamp to hold the axis of the skull fix, turn the wrench clockwise to secure it.

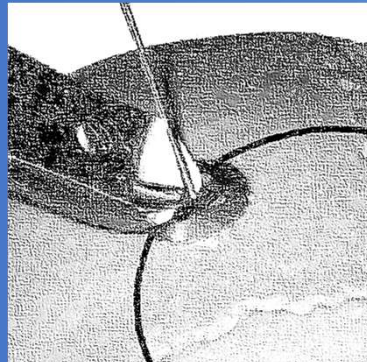

5. Remove the wrench. Use the front of bone forceps to flatten the axis.

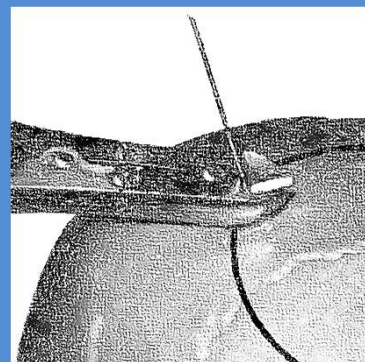

6. Use the back of forceps to cut it.

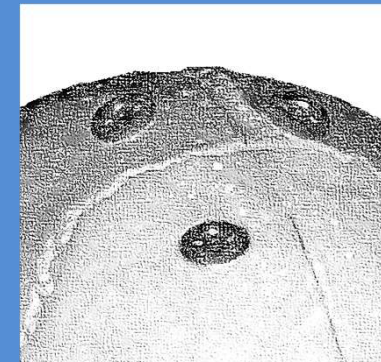

7. Complete

Titanium Cranial Bone Flap Skull Fix Instructions - method two

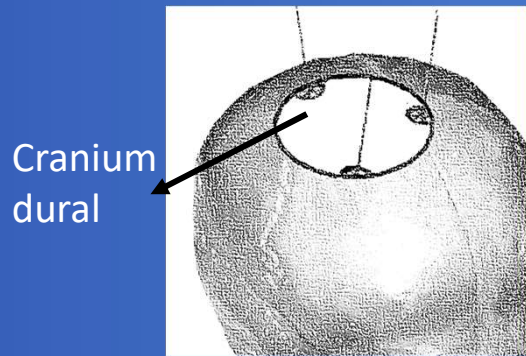

1. Place the three skull fix disks on proper positions of the cranium.

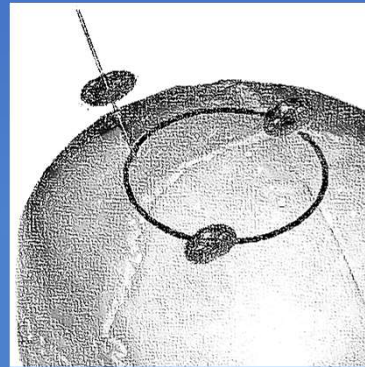

2. Reattach the removed part of cranial bone flap.

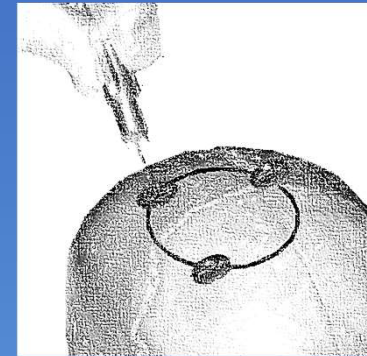

3. Place the upper disk, put the wrench on top.

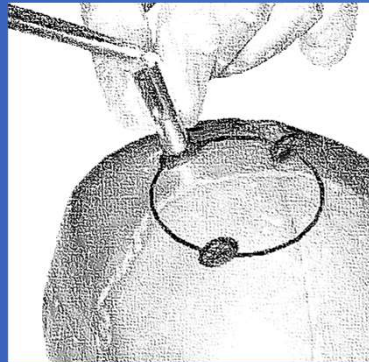

4. Use a clamp to hold the axis of the skull fix, turn the wrench clockwise to secure it.

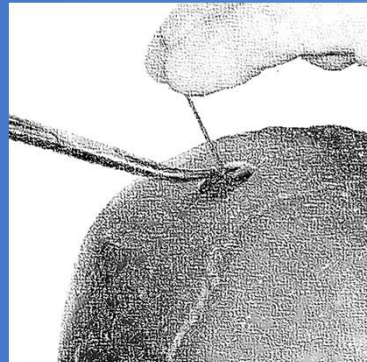

5. Use the mosquito forceps to clamp the root of rod.

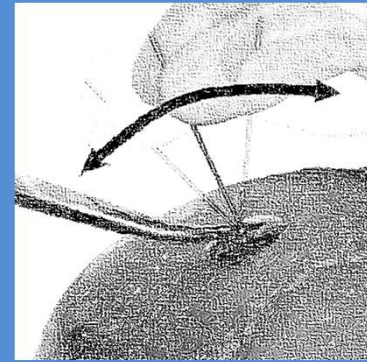

6. Shake the top of rod to break.

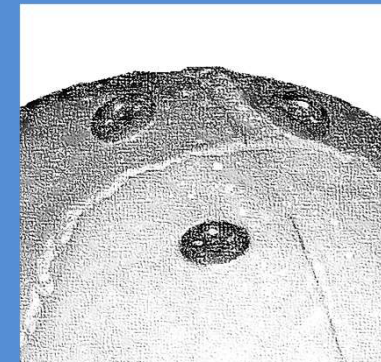

7. Complete

BMI® Medical

Wellong Instruments Co., Ltd.

E-mail : cctco@ms35.hinet.net

Phone Number : +886-2-25719829 · +886-2-25413710

Fax Number : +886-2-25627884

Address : 2F., No.63, Linsen N. Rd., Zhongshan Dist.,
Taipei City 104, Taiwan (R.O.C.)