

CUSTOMER:		DESCRIPTION:	
CIP-CHISINAU		PAEDIATRIC PACK FOR USE WITH FX15RW40	
MOLDOVA			
PRODUCT CODE:	DRAWING TYPE:	Total Priming Volume:	
CX-ML025	PRODUCTION	XXX	

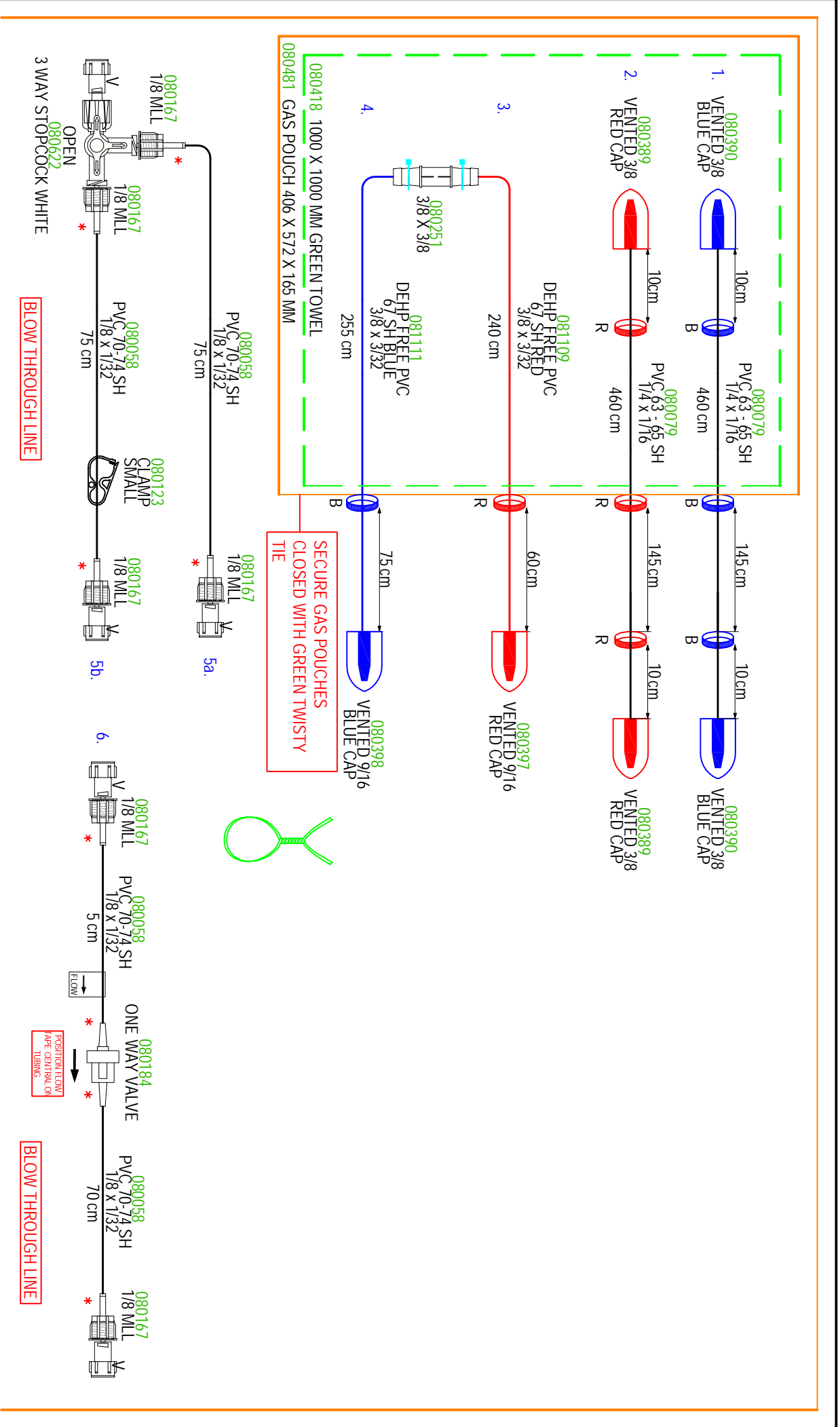

DRAWN BY:	SHIRLEY COURTNEY	ISSUED:	26/02/2016	ISSUE No:	6
INT. AMEND:	28/03/2019-SF	AMENDED:	16/04/2019-SF	SHEET No:	1/5
THIS DOCUMENT IS THE PROPERTY OF TERUMO EUROPE AND MAY NOT BE COPIED BY ANY THIRD PARTY.					

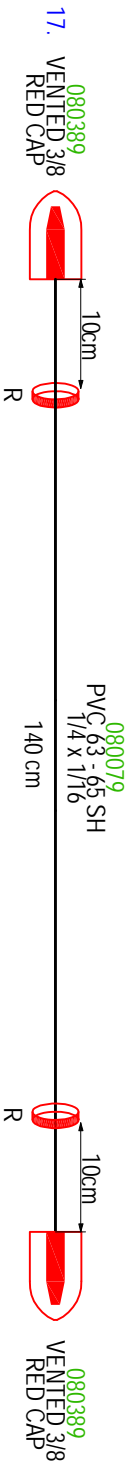
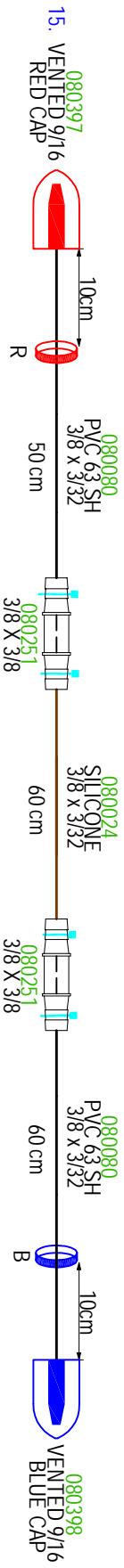
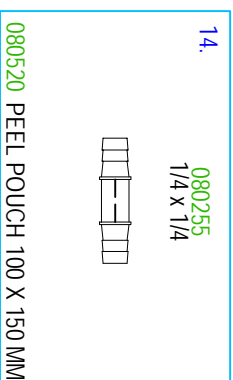
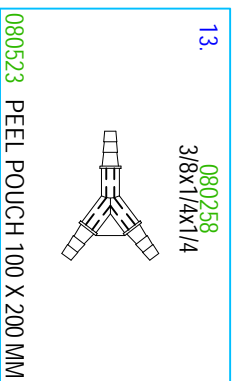
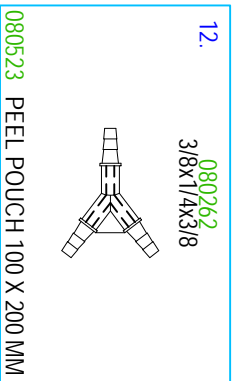
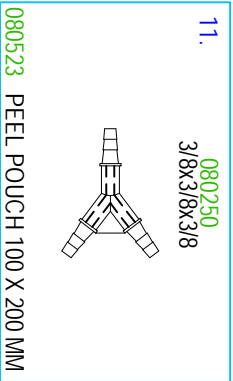
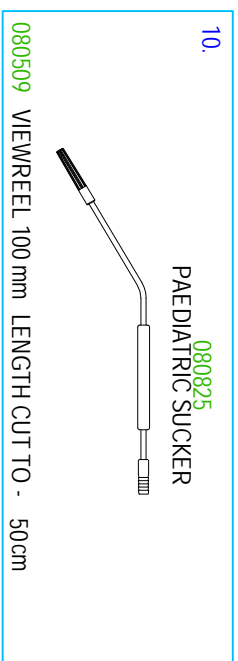
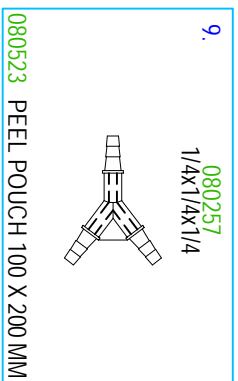
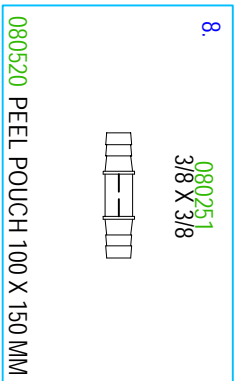
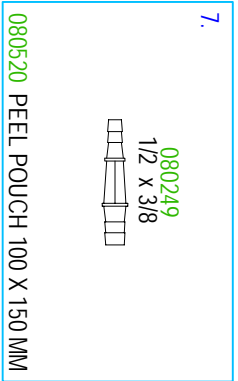

CUSTOMER:

CIP CHISIMAU
MOLDOVA

DESCRIPTION:

PAEDIATRIC PACK FOR USE WITH FX15RW40

PRODUCT CODE:

CK-ML025

DRAWING TYPE:

PRODUCTION

Total Priming Volume:

XXX

DRAWN BY: SHIRLEY COURTNEY

INT. AMEND: 28/03/2019-SF

THIS DOCUMENT IS THE PROPERTY OF TERUMO EUROPE AND MAY NOT BE COPIED BY ANY THIRD PARTY.

ISSUED: 26/02/2016

AMENDED: 16/04/2019-SF

ISSUE No: 6

SHEET No: 2/5



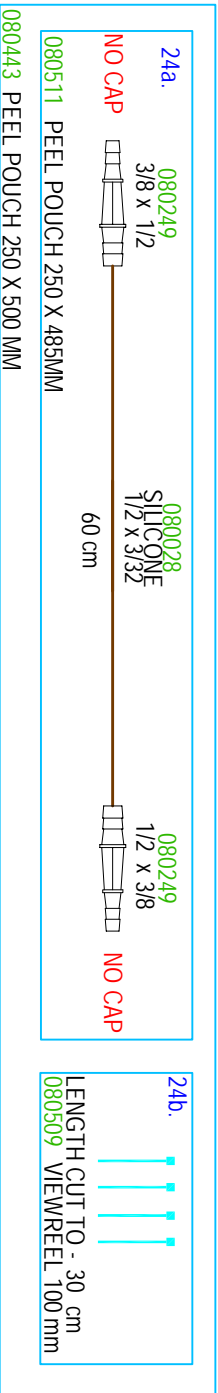
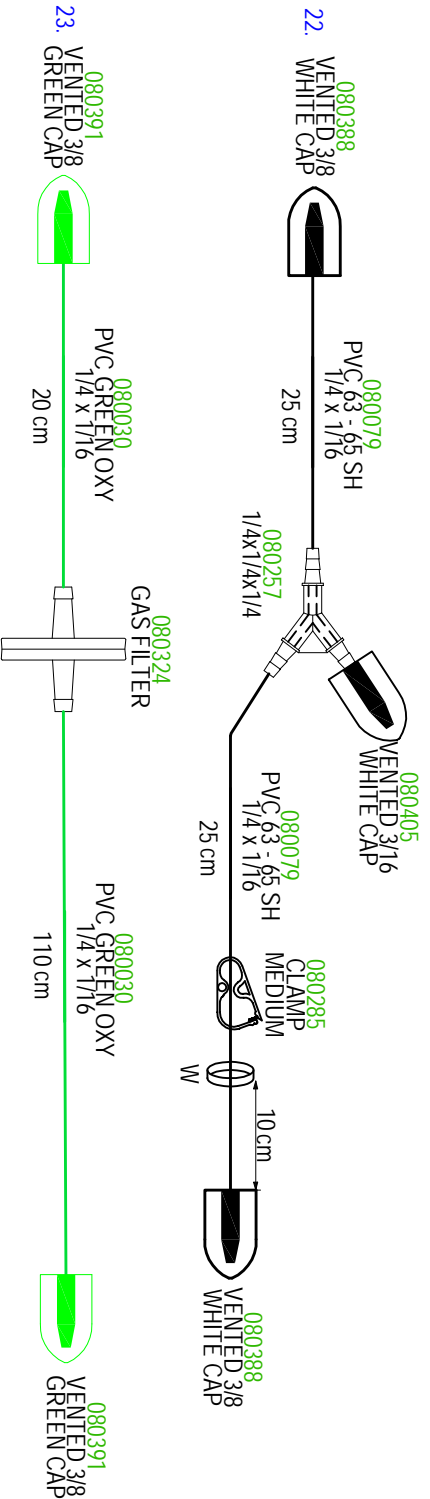
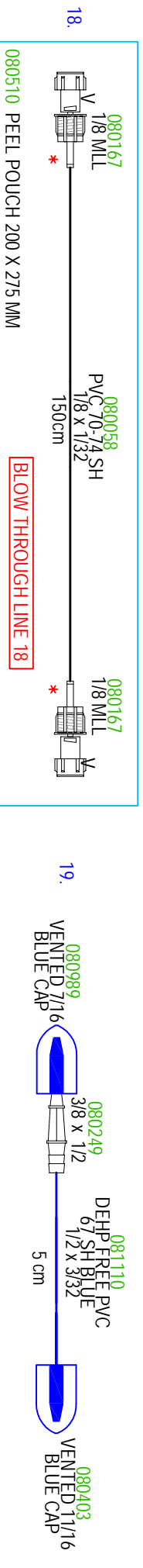

CUSTOMER: CIP CHISINAU MOLDOVA

DESCRIPTION: PAEDIATRIC PACK FOR USE WITH FX15RW40

PRODUCT CODE: CX.ML.025

DRAWING TYPE: PRODUCTION

Total Priming Volume: XXX

DRAWN BY: SHIRLEY COURTNEY

ISSUED: 26/02/2016

INT. AMEND: 28/03/2019-SF

AMENDED: 16/04/2019-SF

SHEET No: 6

THIS DOCUMENT IS THE PROPERTY OF TERUMO EUROPE AND MAY NOT BE COPIED BY ANY THIRD PARTY.



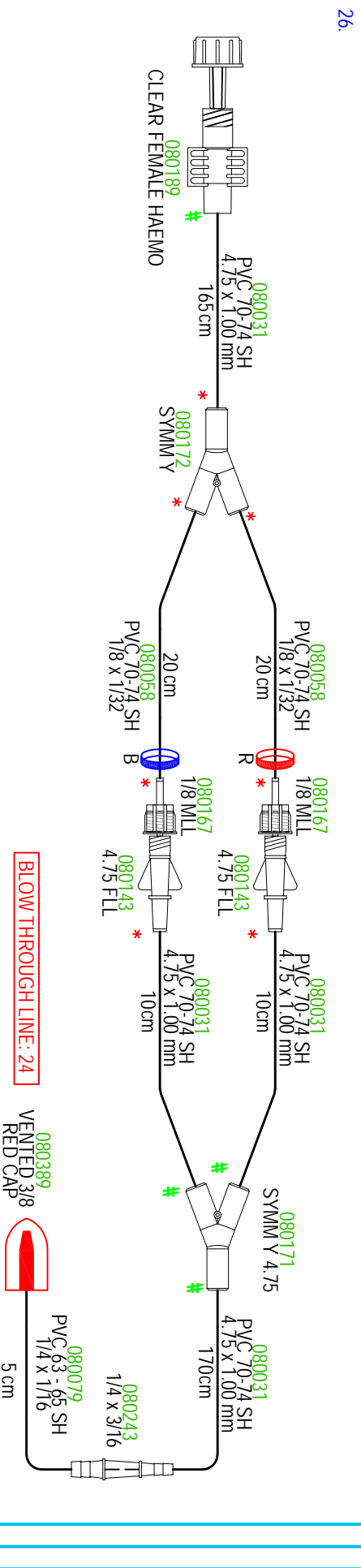
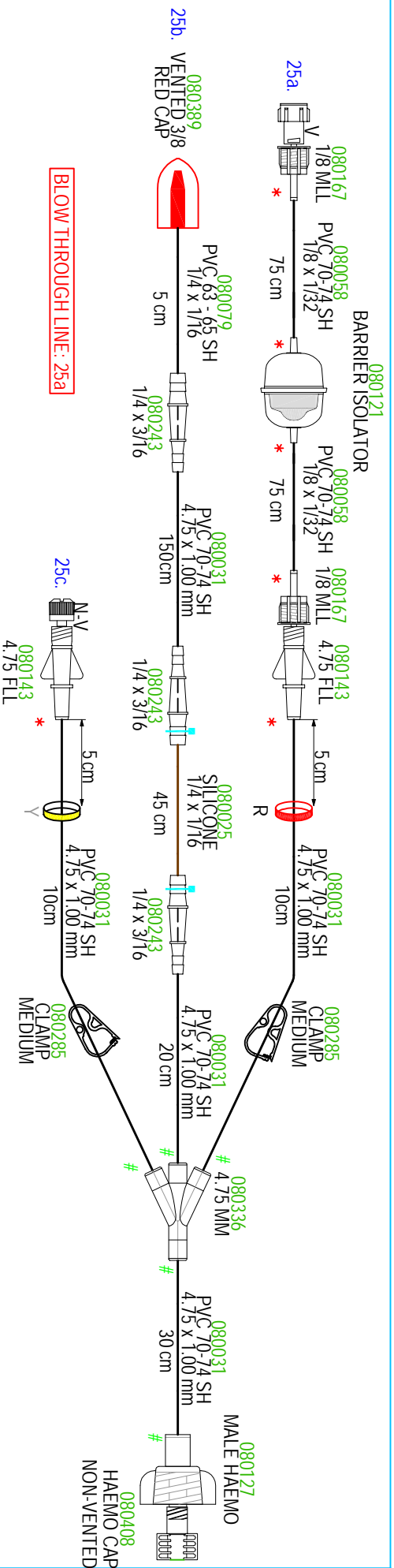

- 080511 PEEL POUCH 250 X 485MM
- 080512 PEEL POUCH 250 X 485MM
- 080511 PEEL POUCH 250 X 485MM
- 080483 GAS POUCH 508 X 648 X 165 MM

CUSTOMER:	DESCRIPTION:
CIP CHISINAU	PAEDIATRIC PACK FOR USE WITH FX15RW40
MOULDOVA	
PRODUCT CODE:	DRAWING TYPE:
CX-ML025	PRODUCTION
	Total Priming Volume:
	XXX

DRAWN BY:	ISSUED:
SHIRLEY COURTNEY	26/02/2016
INT. AMEND:	AMENDED:
28/03/2019-SF	16/04/2019-SF
THIS DOCUMENT IS THE PROPERTY OF TERUMO EUROPE AND MAY NOT BE COPIED BY ANY THIRD PARTY.	
SHEET No:	ISSUE No:
4/5	6



CP LAYER PAD
080856
0,25

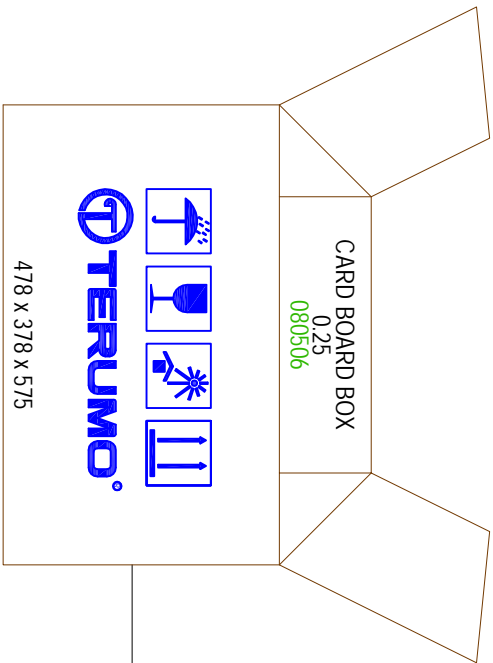
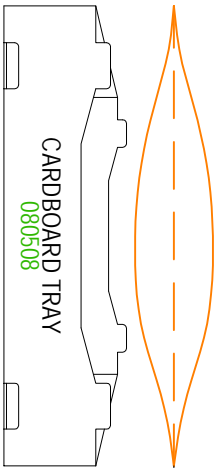
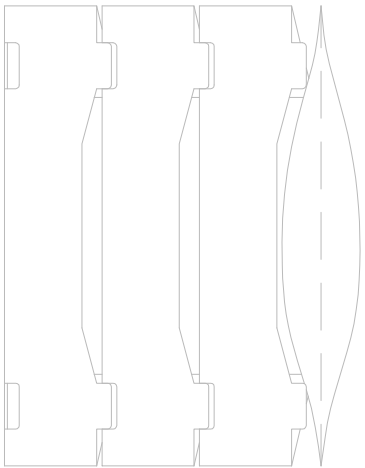

PACKING INFORMATION

EACH GAS POUCH IS TO BE PACKED IN A
CARDBOARD TRAY, ONE ON TOP OF
ANOTHER, 4 PACKS PER BOX

TOP:
24-25-26
7-8-9-11-12-13-14-18
19-21-5-6-23
15-17-16-20-22
1-2-3-4

PACK LABEL EXAMPLE

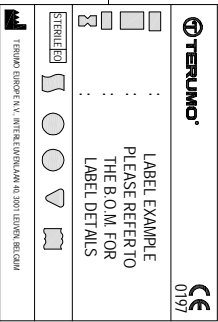

BOX LABEL EXAMPLE

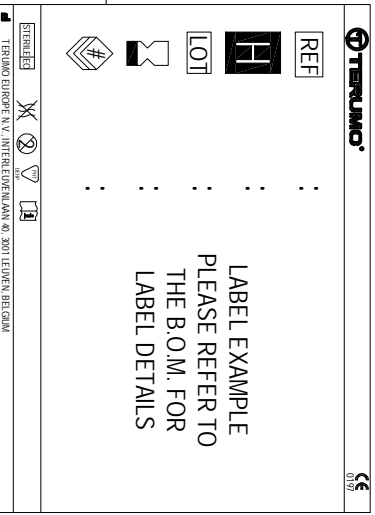

CUSTOMER:

CIP CHISINAU
MOLDOVA

DESCRIPTION:

PAEDIATRIC PACK FOR USE WITH FX15RW40

PRODUCT CODE:

CX-MML025

DRAWING TYPE:

PRODUCTION

Total Priming Volume:

XXX

DRAWN BY:

SHIRLEY COURTNEY

ISSUED:

26/02/2016

ISSUE No.:

6

INT. AMEND:

28/03/2019-SF

AMENDED:

16/04/2019-SF

SHEET No.:

5/5

THIS DOCUMENT IS THE PROPERTY OF TERUMO EUROPE AND MAY NOT BE COPIED BY ANY THIRD PARTY.