

BASIC 160 V2

BASIC 200 V0

BASIC 250 V1

BASIC 315 V1

BASIC 355 V0

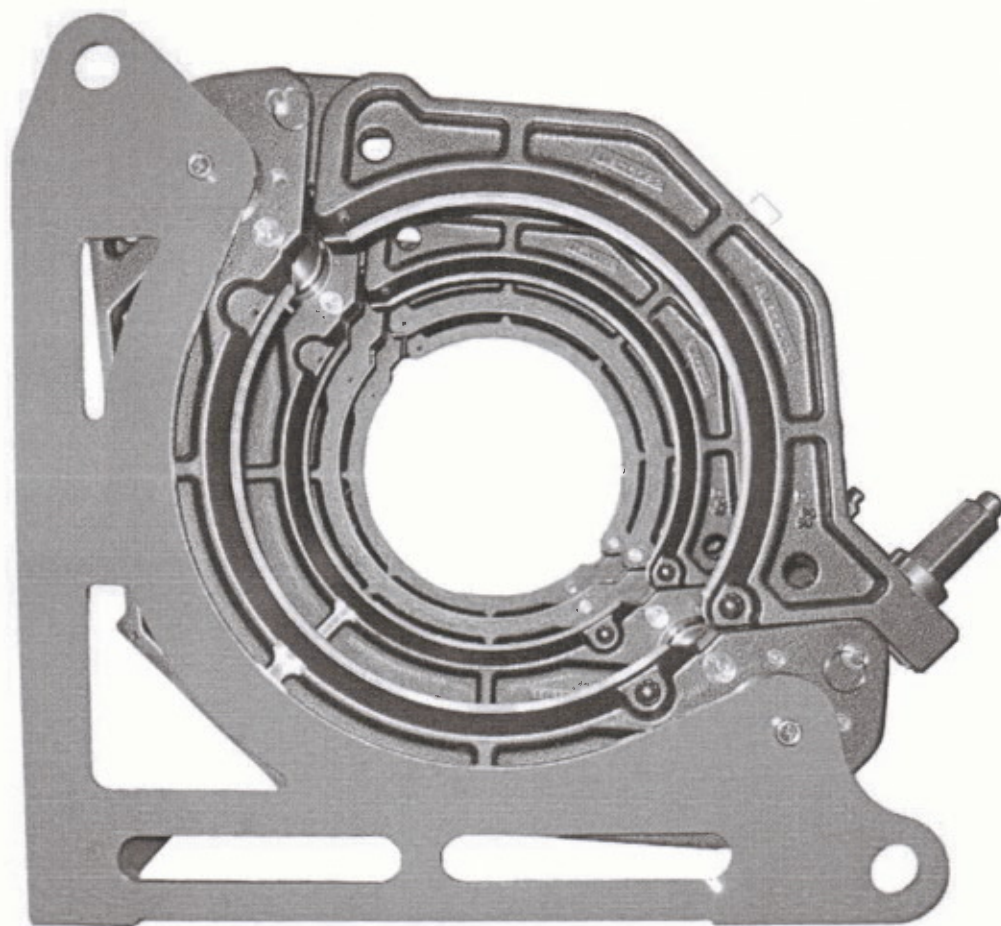

USE AND MAINTENANCE HANDBOOK

I **Ritmo** S.p.A. è libera di apportare modifiche senza preavviso alle caratteristiche della macchina descritta in questo manuale e alle informazioni qui contenute.
È vietata la riproduzione, anche parziale e sotto qualsiasi forma, di questo documento.

EN **Ritmo** S.p.A. is free to modify the contents of this handbook, as well as the features of the machine described herein, at any time, without notice.
All rights reserved. It is strictly prohibited to reproduce this document or part of it in any form whatsoever.

F L'entreprise **Ritmo** S.p.A. se réserve le droit d'apporter, sans préavis, toutes les modifications qu'elle désirera aux caractéristiques de la machine décrite dans ce manuel ainsi qu'aux informations qu'il contient.
La reproduction de ce document, même partielle, sous n'importe quelle forme, est strictement interdite.

E **Ritmo** S.p.A. se reserva el derecho de hacer modificaciones sin previo aviso a las características de la máquina descrita en este manual y a las informaciones en él incluidas.
Está terminantemente prohibida toda reproducción de este documento, incluso parcial o de cualquier otra

P A **Ritmo** S.p.A. pode efectuar sem pré-aviso quaisquer modificações às características da máquina descrita no presente manual, bem como às informações nele inseridas.
A cópia total ou parcial deste documento é severamente proibida, sob qualquer forma.

D Die hier angegebenen Daten sind ohne Gewähr und **Ritmo** S.p.A. behält sich Änderungen ohne Vorankündigung vor.
Die Vervielfertigung, auch auszugsweise, dieses Dokumentes ist verboten.

NL **Ritmo** S.p.A. is vrij om de inhoud van deze handleiding en de kenmerken te wijzigen van NL de machine die hierin beschreven wordt, op elke gegeven tijd, zonder waarschuwing. Alle rechten voorbehouden. Het is streng verboden om dit document of een gedeelte ervan in elk vorm dan ook te reproduceren.

RUS **Ritmo** S.p.A. имеет право вносить изменения в аппарат, описанный в данной инструкции и в информацию о нём без предварительного уведомления.
Все права защищены. Данный документ и любые его части воспроизводить запрещено.

AR **Ritmo** S.p.A. عبارة عن كتيب ذي محتوى قابل للتعديل، كما أن ميزات الآلة الموضحة في هذا الكتيب عرضة للتغيير بدون إشعار مسبق. جميع الحقوق محفوظة. يحظر تمامًا إعادة إنتاج هذا المستند أو أي جزء منه بأي شكل من الأشكال.



S.p.A.

Via A. Volta, 35-37 – (Z.I.)
35037 BRESSÈO DI TEOLO (PD)
ITALY
Tel. +39.049.990.1888
Fax +39.049.990.1993
info@ritmo.it

INTRODUCTION

Dear Customer,

Thank you for having chosen a *Ritmo* machine.

This handbook will show you all your new **BASIC** machine features, and how to get the most of them. In this book you will also find all the information and suggestions needed to use the machine in a proper, safe and professional manner. We therefore recommend its complete reading before starting using the machine. We also recommend to keep it for future consultations and/or new users.

Please remember that this machine is a professional device; its use must be limited to skilled and certified personnel.

Certain of your complete satisfaction,

Best regards,



CONTENTS

Introduction

1. Product Introduction and Specifications	1.1
2. Welding General Criteria	2.1
Transport, loading/unloading, handling and storage	2.1
Scratches and notches	2.1
Before welding	2.1
Set up	2.2
Welding cycles	2.3
Welding bead: naked eye observation	2.4
3. Parts Description	3.1
Chassis	3.1
Facer	3.1
Heating plate	3.2
Facer/heating plate support	3.2
Hydraulic gearcase	3.3
Timer	3.3
Standard equipment	3.4
4. Operating Instructions	4.1
Hydraulic connections	4.1
Electrical connections	4.1
Thermoregulator DIGITAL DRAGON	4.3
Insertion of reductions	4.4
How to weld between clamps number 2 and 3	4.5
How to weld between clamps number 3 and 4	4.5
Facing	4.6
Simple Pressure welding cycle	4.7
Dual Pressure welding cycle	4.10
5. Maintenance	5.1
6. Trouble Shooting	6.1
7. Safety Precautions	7.1
8. Welding Parameters	8.1

1. TECHNICAL FEATURES

INTRODUCTION

BASIC is a line of on-site butt welding machines for pipes and fittings in Polyethylene (PE), Polypropylene (PP), and other thermoplastic materials intended for the transport of combustible gas, water, and other fluids under high pressure.

All **BASIC** machines can weld PE 100 with the Dual Pressure method.

We remind you that the use of such machines is limited to authorized skilled and certified personnel, in accordance with the Legislation and Regulations in force.

SPECIFICATIONS

	BASIC 160 V2		BASIC 200 V0		BASIC 250 V1		BASIC 315 V1		BASIC 355 V0	
--	--------------	--	--------------	--	--------------	--	--------------	--	--------------	--

GENERAL FEATURES

Power supply (VAC/Hz)	110	230	110	230	110	230	110	230	230	
	50-60		50-60		50-60		50-60		50-60	
Diameters range [mm]	Ø 40÷160		Ø 63÷200		Ø 75÷250		Ø 90÷315		Ø 125÷355	
Weldable materials	HDPE: PE 80 (MRS 8) and PE 100 (MRS 10), PP and other thermoplastics materials									
Ambient temperature range [° C]	from -10 to +40									
Maximum absorbed power [W]	2320	2220	3220	3420	3420	3920	4420	5750		
Isolation class	1: protection conductor									
Noise	L _{WA} = 72 dB (A)									
Weight - machine with all features [kg]	75 Kg (165 lb))		90 Kg (198 lb)		121 Kg (267 lb)		163 Kg (359 lb)		205 Kg (452 lb)	

CHASSIS

Overall thrust section [cm ²]	1.947		3.156		5.890		6.680		14.130
Dimensions W D H [mm]	606x365x375 mm (23.9x14.4x14.8 in)		685x460x420 mm (27x18.2x16.5 in)		850x470x400 mm (33.5x18.5x15.7 in)		981x586x520 mm (38.6x23x20.5 in)		1077x510x715 mm (42.4x20x28 in)
Weight [kg]	31 Kg (68 lb)		39 Kg (86 lb)		63 Kg (138.9)		86 Kg (189.6 lb)		100 Kg (220.5 lb)

FACER

Nominal power [W]	1020	1050	1050	1050	1050	900	
Rotation speed [RPM]	109		109	73	67	22	
Dimensions W D H [mm]	375x325x280 mm (14.8x12.9x11 in)		360x415x320 mm (14.2x16.3x12.6 in)		440x450x380 mm (17.3x17.7x15 in)		600x460x390 mm (23.6x18.1x15.3 in)
Weight [kg]	9 Kg (19.9 lb)		11 Kg (24.2 lb)		15 Kg (33.1 lb)		24 Kg (53 lb)
							38 Kg (83.8 lb)

HEATING PLATE

Maximum absorbed power [W]	1000	800	1800	2000	3000	3750	
Temperature adjustment	180-260°C						
Time to reach working the temperature	< 20 min.						
Dimensions W D H [mm]	410x280x50 mm (16.1x11x2 in)		416x40x326 (16.4x1.6x12.8 in)		470x50x490 mm (18.5x2x19.3 in)		470x50x600 mm (18.5x2x23.6 in)
Weight [kg]	3 Kg (6.6 lb)		6 Kg (13.2 lb)		8 Kg (17.6 lb)		13 Kg (28.7 lb)
							18 Kg (39.7 lb)

HYDRAULIC GEARCASE

Nominal power [W]	370					1100
Pressure range [bar]	0 ÷ 150					0 ÷ 120
Hydraulic oil	Viscosity class 46 or 68 ISO 3448 Recommended : TEXACO RANDO HDZ 46, ESSO UNIVIS N 46 SHELL TELLUS T 46					
Dimensions W D H [mm]	470x250x370 mm (18.5x9.8x14.5 in)					550x300x400 mm (21.6x11.8x15.7 in)
Weight [kg]	26 Kg (57 lb)					32 Kg (70.5 lb)

FACER/HEATING PLATE SUPPORT

Dimensions W D H [mm]	340x440x230 mm (1.34x1.73x9.1 in)	365x505x205 mm (14.4x19.9x8.1 in)	477x500x203 mm (18.8x19.7x8 in)	690x560x290 mm (2.72x2.20x1.14 in)	740x465x388 mm (29.1x18.3x15.3 in)
Weight [kg]	6 Kg (13 lb)	7.5 Kg (16.5 lb)	9 Kg (19.9 lb)	14 Kg (30.9 lb)	23 Kg (50.7 lb)

1. TECHNICAL FEATURES

ADAPTERS (ON DEMAND)	BASIC 160 V2	BASIC 200 V0	BASIC 250 V1	BASIC 315 V1	BASIC 355 V0
INSERTS (mm)	Weight (full set)				
Ø 40 mm	4.6 Kg (10 lb)	-	-	-	-
Ø 50 mm	4.4 Kg (9.7 lb)	-	-	-	-
Ø 56 mm	4.4 Kg (9.7 lb)	-	-	-	-
Ø 63 mm	4.2 Kg (9.2 lb)	6.6 Kg (14.5 lb)	12.0 Kg (26.4 lb) ¹	-	-
Ø 75 mm	4.0 Kg (8.8 lb)	6.4 Kg (14.1 lb)	10.6 Kg (23.3 lb)	-	-
Ø 90 mm	3.7 Kg (8.2 lb)	6.0 Kg (13.2 lb)	10.0 Kg (22 lb)	10.0 Kg (22 lb)	-
Ø 110 mm	3.1 Kg (6.8 lb)	5.5 Kg (12.1 lb)	9.8 Kg (21.6 lb)	9.8 Kg (21.6 lb)	-
Ø 125 mm	2.6 Kg (5.7 lb)	5.0 Kg (11 lb)	9.1 Kg (20 lb)	9.1 Kg (20 lb)	9.1 Kg (20 lb)
Ø 140 mm	2.1 Kg (4.6 lb)	4.5 Kg (9.9 lb)	8.3 Kg (18.3 lb)	8.3 Kg (18.3 lb)	8.3 Kg (18.3 lb)
Ø 160 mm	-	3.6 Kg (8 lb)	7.5 Kg (16.5 lb)	7.5 Kg (16.5 lb)	7.5 Kg (16.5 lb)
Ø 180 mm	-	2.6 Kg (5.7 lb)	6.2 Kg (13.6 lb)	6.2 Kg (13.6 lb)	6.2 Kg (13.6 lb)
Ø 200 mm	-	-	4.8 Kg (10.6 lb)	4.8 Kg (10.6 lb)	4.8 Kg (10.6 lb)
Ø 225 mm	-	-	3.1 Kg (7 lb)	3.1 Kg (7 lb)	3.1 Kg (7 lb)
Ø 250 mm	-	-	-	9.8 Kg (21.6 lb) MASTER ADAPTER 316->260	17.6 Kg (39 lb) MASTER ADAPTER 365->260
Ø 280 mm	-	-	-	5.4 Kg (11.9 lb)	10.3 Kg (22.7 lb)
Ø 315 mm	-	-	-	-	6.4 Kg (14.1 lb)

INSERTS (IPS)	Weight (full set)				
Ø 1 IPS	4.7 Kg (10 ½ lb)	-	-	-	-
Ø 1 ¼ IPS	4.6 Kg (10 lb)	-	-	-	-
Ø 1 ½ IPS	4.5 Kg (10 lb)	-	-	-	-
Ø 2 IPS	4.4 Kg (9 ½ lb)	6.6 Kg (14.6 lb)	21.0 Kg (46.3 lb)	-	-
Ø 2 ¼ IPS	-	-	19.8 Kg (43.6 lb)	-	-
Ø 3 IPS	3.7 Kg (8 lb)	6.1 Kg (13.4 lb)	18.9 Kg (41.7 lb)	18.9 Kg (41.7 lb)	-
Ø 4 IPS	-	5.3 Kg (11.7 lb)	17.8 Kg (39.2 lb)	17.8 Kg (39.2 lb)	17.8 Kg (39.2 lb)
Ø 5 IPS	-	4.4 Kg (9.7 lb)	16.3 Kg (35.9 lb)	16.3 Kg (35.9 lb)	16.3 Kg (35.9 lb)
Ø 6 IPS	-	3.2 Kg (7.0 lb)	12.7 Kg (28.0 lb)	12.7 Kg (28.0 lb)	12.7 Kg (28.0 lb)
Ø 8 IPS	-	-	6.1 Kg (13.4 lb)	6.1 Kg (13.4 lb)	6.1 Kg (13.4 lb)
Ø 250 mm	-	-	-	9.8 Kg (21.6 lb) MASTER ADAPTER 316->260	17.6 Kg (39 lb) MASTER ADAPTER 365->260
Ø 10 IPS	-	-	-	9.9 Kg (21.8 lb)	19.5 Kg (43.0 lb)
Ø 12 IPS	-	-	-	-	8.7 Kg (19.2 lb)

INSERTS (DIPS)	Weight (full set)				
Ø 3 DIPS	-	6.1 Kg (13.4 lb)	18.5 Kg (40.8 lb)	18.5 Kg (40.8 lb)	-
Ø 4 DIPS	-	5.3 Kg (11.7 lb)	16.8 Kg (37.1 lb)	16.8 Kg (37.1 lb)	16.8 Kg (37.1 lb)
Ø 6 DIPS	-	3.2 Kg (7.0 lb)	12.0 Kg (26.4 lb)	12.0 Kg (26.4 lb)	12.0 Kg (26.4 lb)
Ø 8 DIPS	-	-	4.5 Kg (9.9 lb)	4.5 Kg (9.9 lb)	4.5 Kg (9.9 lb)
Ø 250 mm	-	-	-	9.8 Kg (21.6 lb) MASTER ADAPTER 316->260	17.6 Kg (39 lb) MASTER ADAPTER 365->260
Ø 10 DIPS	-	-	-	9.9 Kg (21.8 lb)	19.5 Kg (43.0 lb)
Ø 12 IPS	-	-	-	-	8.7 Kg (19.2 lb)

TOOL FOR FLANGE NECKS (ON DEMAND)

Dimensions W D H [mm]	-	300×190×490 mm (11.8x7.5x19.3 in)	300×190×490 mm (11.8x7.5x19.3 in) (200mm adapter required)	340x182x542 mm (13.4x7.1x21.3 in)	340x182x542 mm (13.4x7.1x21.3 in) (315mm adapter required)
Weight [kg]	-	7 Kg (15.4 lb)	7 Kg (15.4 lb)	9 Kg (19.9 lb)	9 Kg (19.9 lb)

¹ Sold as stand-alone set

2. WELDING GENERAL CRITERIA

The transport, loading / unloading, handling and storage of the pipes/fittings require extreme attention, and must be done by means of suitable mechanical devices.

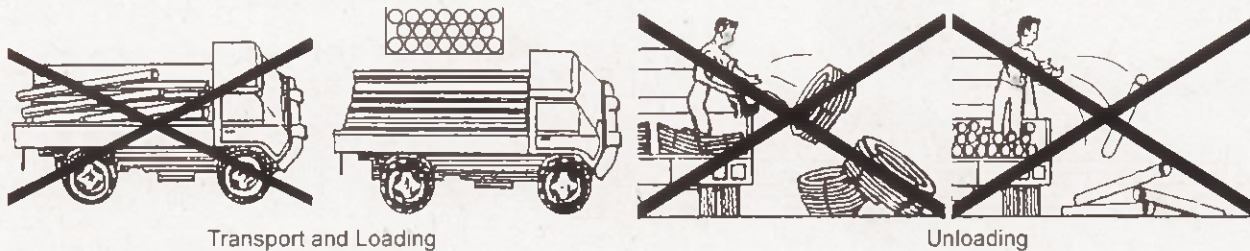

Transport and Loading

Unloading

It is essential to avoid deep scratches and/or notches on the pipes/fittings. Do not drag the pipes/fittings on rough or sharp surfaces (such as truck side-boards, work tools, rocky soil, etc).

BEFORE WELDING

Measuring Instruments:



Timer



Manometer

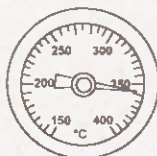

Thermometer

Verify their functionality.

Facer

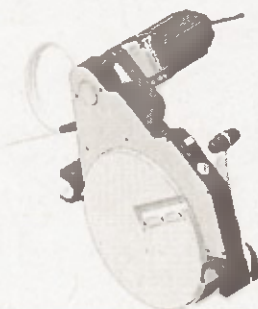

Verify its functionality.

Be sure the blades are sharp enough.

Heating plate



Verify the integrity of the coating.

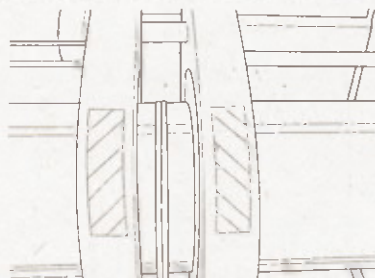

Use a digital thermometer to check if the temperature set has indeed been reached.

Joint





Make a test welding.

2. WELDING GENERAL CRITERIA

Weather conditions		<p>The welding must take place in a dry place.</p> <p>Protect the welding in case of rain, high humidity, strong wind, very low or very high temperatures.</p>
		<p>It is forbidden to raise the temperature of the welding by means of blowlamps or burners put in direct contact with the surfaces to be welded.</p>

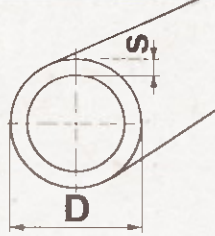
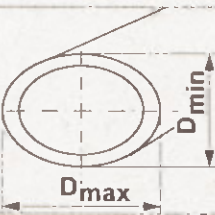
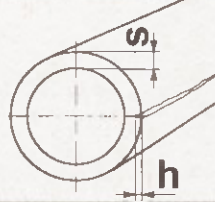
SET UP

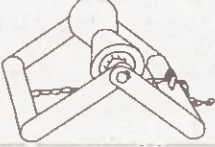
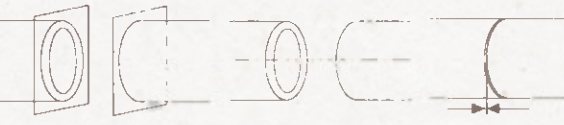
2.2.1. Pipes/fitings to be welded		<p>a) They must have</p> <ul style="list-style-type: none"> same nominal outside diameter (D) same nominal thickness (s) <p>→ D and s must respect the tolerance range established by the National Legislation and regulations in force.</p> <p>b) They must have the same product sigma (σ).</p>
2.2.2. Oval-shaped pipes		<p>The oval-shaped percentage</p> $\frac{D_{max} - D_{min}}{D} \times 100$ <p>must respect the tolerance range established by the National Legislation and regulations in force.</p>
2.2.3. Scratches and notches		<p>The percentage</p> $\frac{h}{s} \times 100$ <p>must respect the tolerance range established by the National Legislation and regulations in force. (h = scratch/notch depth)</p>
2.2.4. Cleaning		<p>Accurately clean the internal and external surfaces of the ends to be welded.</p> <p>Use only the cleaning products recommended by the pipe/fitting producer.</p>
2.2.5. Rollers		<p>Sustain the pipes with rollers in order to reduce friction (and therefore reduce the dragging pressure P_t).</p>
2.2.6. Wind plugs		<p>Apply the wind plugs to the ends not being welded in order to avoid a stack effect.</p>
2.2.7.	<p>While fastening check:</p> 	<p>These three conditions must be met according to the range established by the National Legislation and regulations in force.</p>
	<p>Parallelism Axle alignment Light</p>	
2.2.8. Dragging pressure P_t		<p>Must be measured with pipe/fitting fastened in the clamps.</p> <p>Must always be inferior to P_1 and P_5</p>

2. WELDING GENERAL CRITERIA

WELDING CYCLES

Following are the welding parameters that the operator must set and control afterwards:

- | | |
|----------------------------|-----------------------|
| Heating plate temperature, | Pressures, |
| Bead dimension, | Length of each phase. |

The formulas required to calculate the welding parameters (according to the compound and the welding standards being used) are illustrated in Chapter 9, as well as the parameters for the most common diameters.

SIMPLE PRESSURE WELDING CYCLE

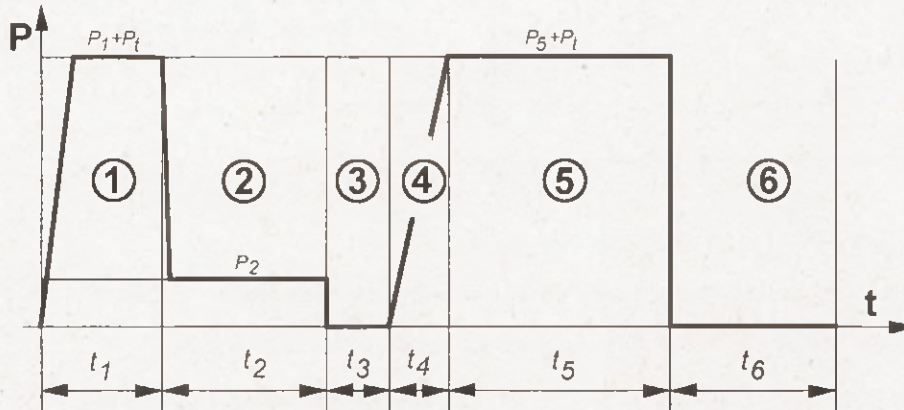

- P_1 : Approach and pre-heating pressure
- P_2 : Maximum heating pressure
- P_5 : Welding pressure
- P_t : Dragging pressure (pressure required to overcome friction - must be read by the operator on the gearcase manometer)

t_1, t_2, \dots, t_6 : Length of Phases 1, 2, ..., 6

Phase 1 Approach and Pre-heating. Approach both ends to be welded to the heating plate at the $(P_1 + P_t)$ pressure, and wait until the bead has reached the expected size from the standard used.

Phase 2 Heating. Reduce pressure to P_2 maximum value, sufficient to keep the ends in touch with the heating plate for the entire t_2 time.

IMPORTANT! The ends to be welded MUST NOT detach from the heating plate while the pressure is being reduced. If that happens, the welding **must absolutely** be repeated.

Phase 3 Removal of heating plate. Remove the heating plate within the maximum t_3 time, without damaging the beads.

Phase 4 Reach of welding pressure. Get both ends together while gradually increasing the pressure up to $(P_5 + P_t)$ value, during t_4 time. Prevent an excessive leakage of melted material while performing this phase.

Phase 5 Welding. Keep both ends together at the $(P_5 + P_t)$ pressure for the entire t_5 time.

Phase 6 Cooling. The joint must not be removed or suffer any sort of mechanical strain for the entire t_6 time.

Do not use water or compressed air to rush cooling. Protect the joint from rain, wind or excessive sunlight.

2. WELDING GENERAL CRITERIA

DUAL PRESSURE WELDING CYCLE

The Dual Pressure cycle is used when welding PE 100 with thickness equal or superior to 20mm.

When welding PE 100 with thickness inferior to 20mm, use the Simple Pressure cycle (previous page).

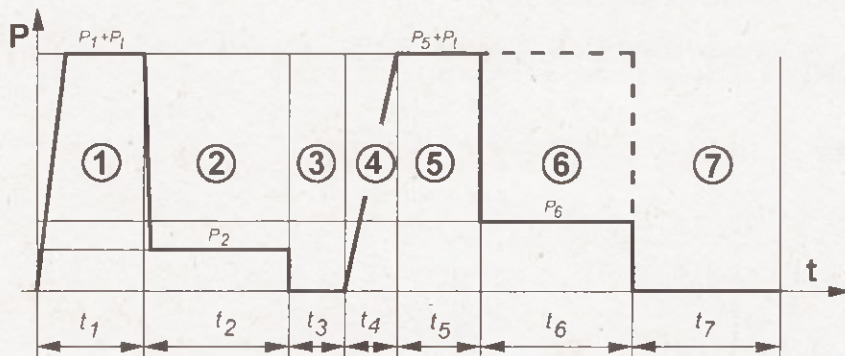

The first four phases are identical (with respect to the simple pressure cycle).

Phases 5/6 Welding. The welding phase happens in two moments:

1. Keep both ends together at the (P_5+P_i) pressure for the entire t_6 time.
2. Reduce pressure to P_6 value and maintain the contact for the entire t_6 time.

Phase 7 Cooling. The joint must not be removed or suffer any sort of mechanical strain for the entire t_7 time.

Control the joint:

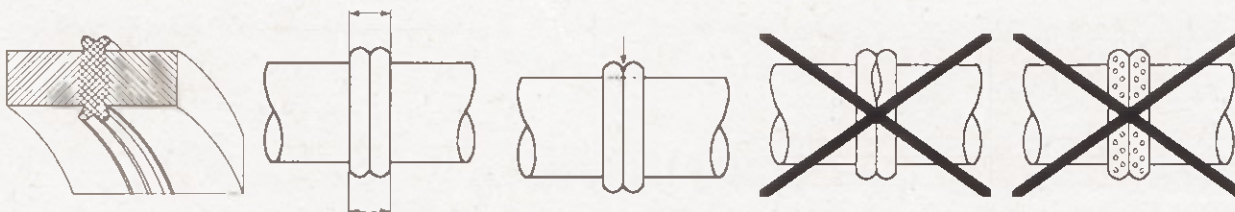

Always follow the working procedures established by the National Legislation and regulations in force, as well as those learnt during the training courses.

3. PARTS' DESCRIPTION

CHASSIS

1. Movable carriage
2. Heating plate release plaques (*)
3. Lower piston rod
4. Clamp fastener
5. Dragging bars
6. Upper piston rod
7. Quick-coupling connections
8. Upper jaw
9. Lower jaw

(*) Not featured in the **BASIC 160** and **BASIC 200** models.

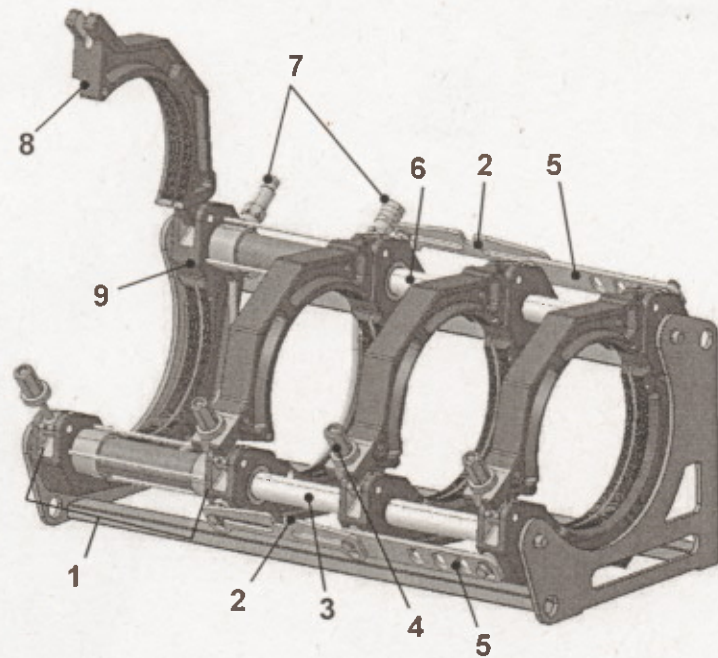

FACER

1. Power supply cable
2. Handgrip
3. Motor
4. Start push button - green (motor)
5. Stop push button - red (motor)
6. Blocking lever
7. Circuit breaker push button
8. Fork for piston rod support
9. Blade
10. Facer disk

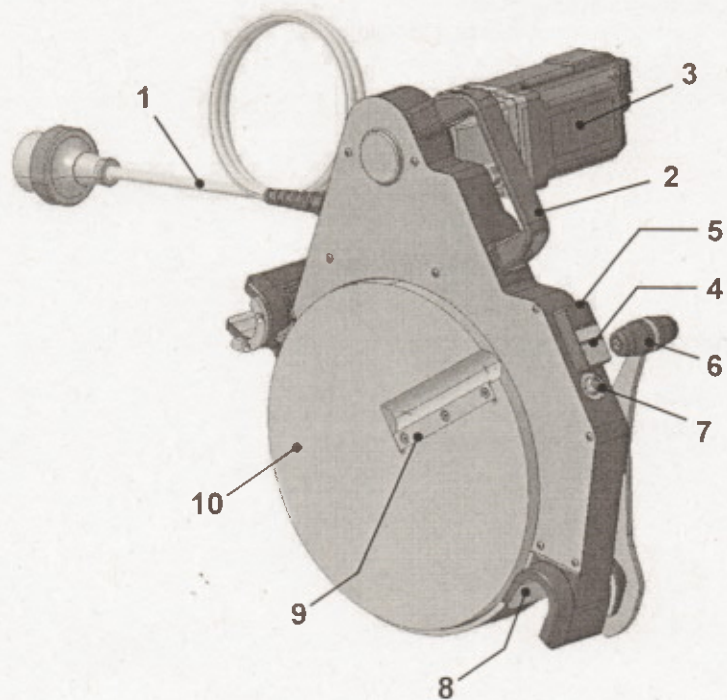

3. PARTS' DESCRIPTION

HEATING PLATE

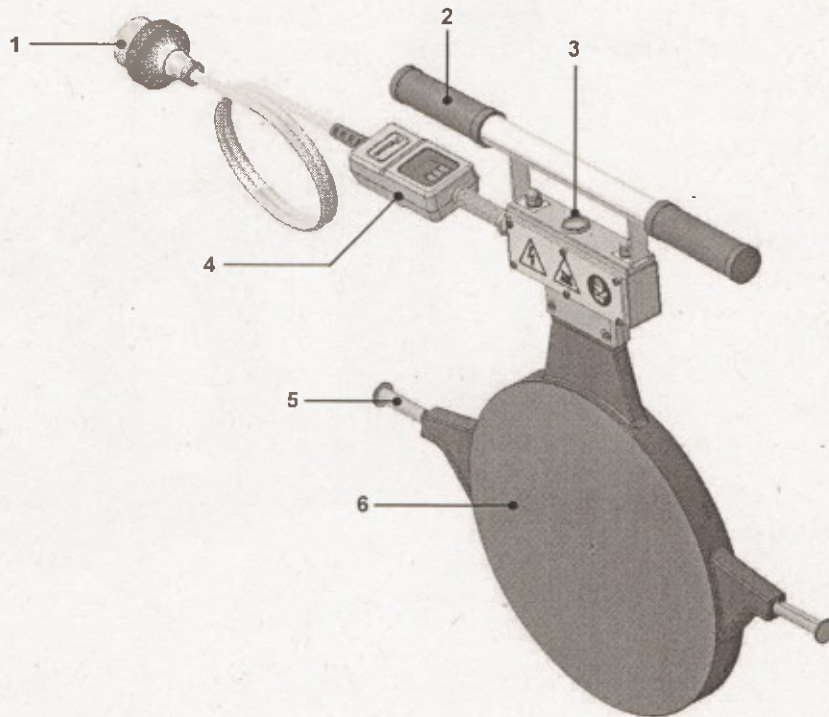

1. Power plug
2. Handgrip
3. Mechanical thermometer
4. Thermoregulator DIGITAL DRAGON
5. Pin for piston rod support
6. Plate

FACER/HEATING PLATE SUPPORT

1. Handgrip
2. Heating plate housing
3. Facer housing

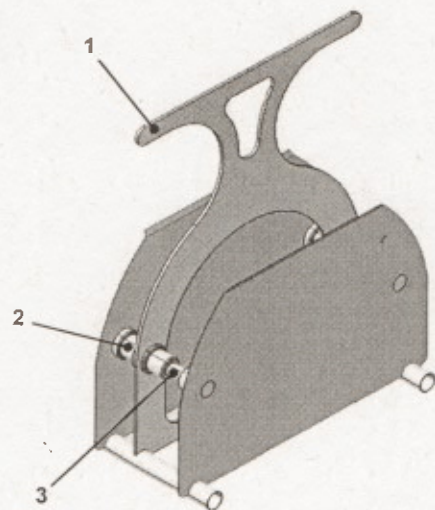

3. PARTS' DESCRIPTION

HYDRAULIC GEARCASE

1. Oil tank plug
2. Pressure discharge valve
3. Maximum pressure valve
4. Distributor lever
5. Oil pressure manometer
6. Hydraulic hoses
7. Quick-coupling connectors

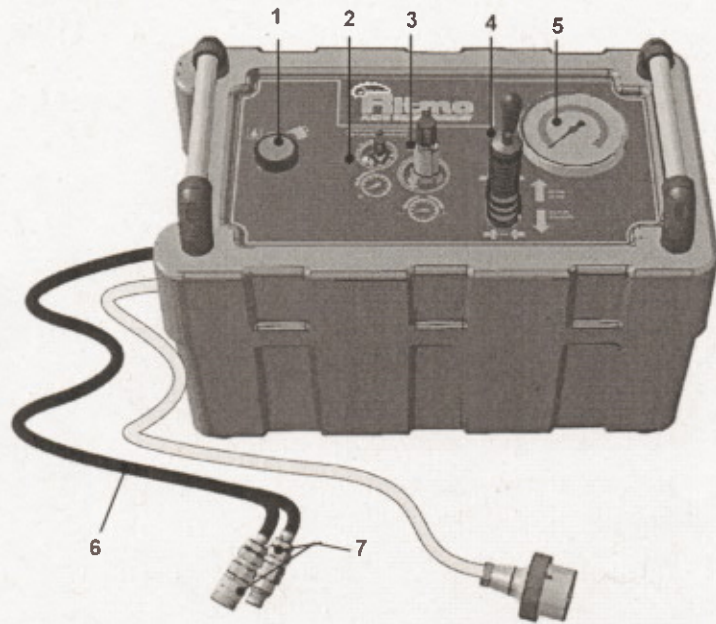

TIMER

- 1: Hours/minutes adjustment key (in **TIMER 3** mode)
- 2: Minutes/seconds adjustment key (in **TIMER 1** and **TIMER 2** modes)
- 3: Reset key
- 4: Countdown start/interrupt key
- 5: Multifunction key – display/adjustment hour-alarm
- 6: **TIMER** keys
T1 mode: Minutes/seconds setup
T2 mode: Minutes/seconds setup
T3 mode: Hours/minutes setup

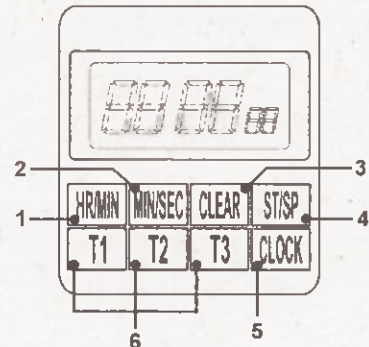

OPERATING INSTRUCTIONS

COUNTDOWN

Choose the mode by pressing keys 6 (T1, T2, T3).

Press key 1 or 2 to set time in terms of hours/minutes (T3) or in terms of minutes/seconds (T1,T2). Press key 4 to start countdown. Countdown may be interrupted and re-started at any time by pressing key 4. When countdown is over, timer will measure time run (second by second). Press key 4 to interrupt progressive counting. Press key 4 again to recall the time previously set.

Press key 5 to display the hour (→hours/minutes buffer blinks). Press key 5 again to display the alarm (→hours/minutes buffer blinks no more).

Hours adjustment:

While the hour is displayed, press key 5 for 3 seconds. Hours/minutes will blink. Press key 1 to set the hour, and key 2 to set the minutes. Press key 5 to confirm.

Alarm adjustment:

While the alarm is displayed, press key 5 for 3 seconds. Hours/minutes will blink. Press key 1 to set the hour, and key 2 to set the minutes. Press key 5 to confirm.

3. PARTS' DESCRIPTION

STANDARD EQUIPMENT

1. Tool bag
2. A Allen key wrench (used to assembly and disassembly the reductions) – only for **BASIC 160** and **BASIC 200** models.
3. Socket wrench used to fasten the clamps, (only for **250 BASIC** , **315 BASIC** and **355 BASIC** models)
4. Use and maintenance handbook
5. Parts list
6. Timer

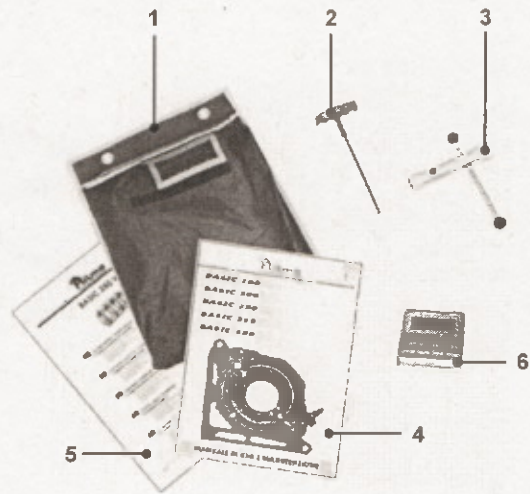

4. OPERATING INSTRUCTIONS

HYDRAULIC CONNECTIONS

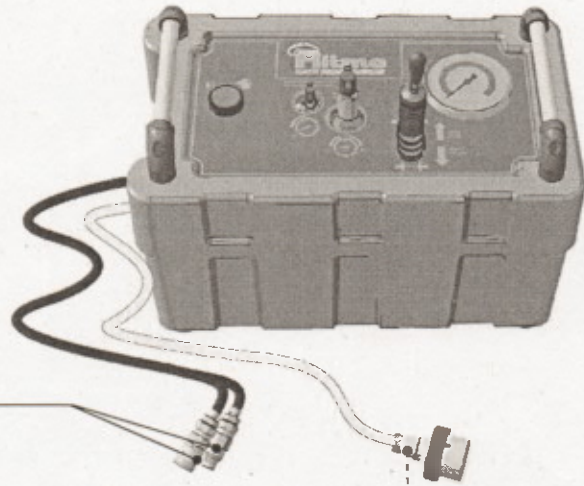
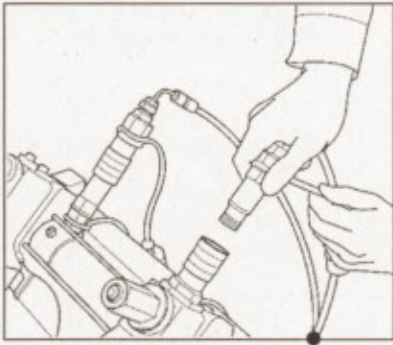

ELECTRICAL CONNECTIONS

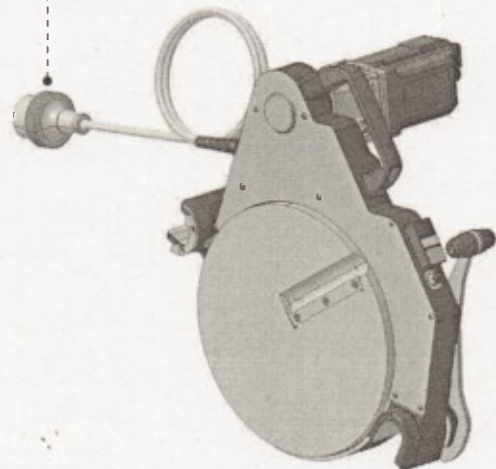
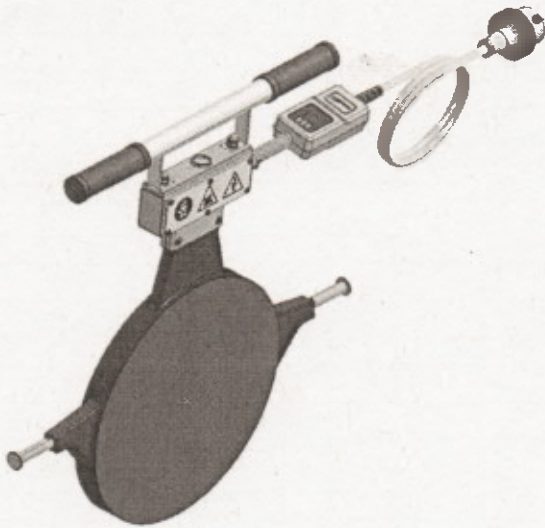

4. OPERATING INSTRUCTIONS

Hydraulic gearcase – Generator set

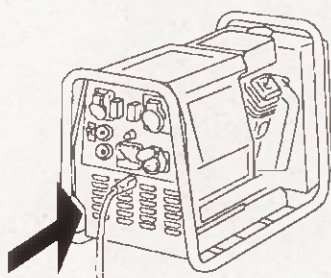

Make sure that the power source has the right voltage (ref. technical data).

Do not use a power source subjected to frequent overvoltages (maximum admissible: +10% of the nominal value).

Use a voltage stabilizer.

BASIC 160 V2

	230 V	
Sezione cavo [mm ²]	1.5	2.5
Max cable length [m]	50 m (164')	75 m (246')

	110 V	
Cable section[mm ²]	2.5	4
Max cable length [m]	30 m (98')	50 m (164')

BASIC 200 V0

	230 V	
Cable section[mm ²]	1.5	2.5
Max cable length [m]	25 m (82')	50 m (164')

	110 V	
Cable section[mm ²]	2.5	4
Max cable length [m]	20 m (65')	40 m (131')

ALLOWED EXTENSIONS for the overall machine power supply

BASIC 250 V1

	230 V	
Cable section[mm ²]	1.5	2.5
Max cable length [m]	25 m (82')	50 m (164')

	110V	
Cable section[mm ²]	2.5	4
Max cable length [m]	20 m (65')	40 m (131')

BASIC 315 V1

	230 V	
Cable section[mm ²]	2.5	4
Max cable length [m]	25 m (82')	50 m (164')

	110 V	
Cable section[mm ²]	4	6
Max cable length [m]	20 m (65')	40 m (131')

BASIC 355 V0

	230 V	
Cable section[mm ²]	4	6
Max cable length [m]	25 m (82')	50 m (164')

4. OPERATING INSTRUCTIONS

START UP

Plug in the power cable (see specifications on the back of the thermoregulator).

Once the power is on, the temperature scale (°C/°F) shows up on the display (A) for 5 seconds. Then the following is displayed:

- **LOW**: the thermoregulator is on, and the heating plate is reaching the set temperature (see **TEMPERATURE SETPOINT MODIFICATION**). The word **LOW** is displayed until the heating plate reaches 160°C (320°F). Then the display shows the current measured temperature.
- **OFF**: the thermoregulator is off. Push B for 4 sec to turn it on.

When the heating plate reaches the set temperature, a red dot on the bottom right of the display (P) starts blinking. Now the temperature is steady and it is possible to make a welding.

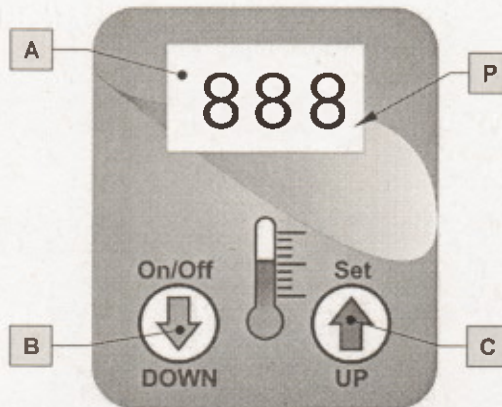

A. Display

B. "DOWN"/ "On/Off" key

Functions:
decrease the temperature set point
turn on /off the heater
change the temperature scale (°C/°F)

C. "UP" / "Set" key

Functions:
increase the temperature set point
enable the temperature setpoint mode

P. Thermoregulation led

Status:
fixed = heating up
blinking = temperature reached

Temperature setpoint modification:

- Keep **C** pressed for approximately 4 seconds until the value displayed starts blinking.
- Press **C** and **B** to set the new value.
- Release both keys and wait for a few seconds. The set value halts to blink and it is stored.

How to change the temperature measure system (temperature scale):

- Keep **B** pressed and plug in the power cable.
- Set value "002" by using **C** and **B** (the measure system in use will start blinking after approximately 4 seconds).
- Press **C** and **B** to switch the temperature scale (Fahrenheit [F] – Celsius [°C]). Wait till the display stops blinking to store your choice.

Error messages:

If one of the following messages appears, try to switch off and on again the thermoregulator. Contact an authorized service centre, if the problem persists.

- | | | |
|-----------|------------------------|---|
| OP | Open Probe: | The reading is out of scale: the temperature probe could be damaged. |
| OC | Out of Control: | Indicates a problem with the temperature adjustment; the thermoregulator cannot adjust the temperature set. |

Shutdown instructions:

To turn off the heating plate, keep **B** pressed until the word **OFF** shows up.
To turn off the thermoregulator, disconnect the power plug.

4. OPERATING INSTRUCTIONS

4.4.1 Set the time (§ 3.1/3)

Timer 1: Set the heating time t_2

Timer 2: Set the welding time t_6 (Simple Pressure cycle) or t_6 (Dual Pressure cycle).

4.4.2 Chassis:

Push the distributor lever to the maximum and fully open the carriage.

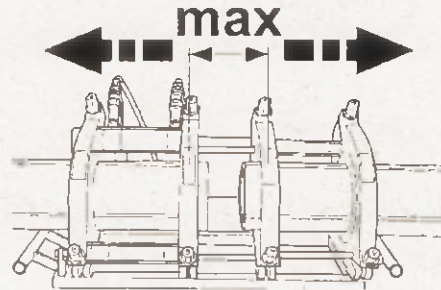

4.4.3. Inserts for **160 BASIC** and **200 BASIC** models

Insert the **V** screw without fastening it. Insert the **R** insert so that its groove coincides with the jaw's bushing. Fasten the **V** screw to lock the insert to the jaw.

Repeat the operation with the other jaws

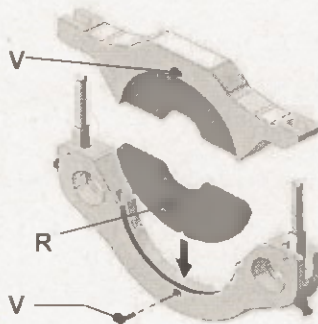

Inserts for **250 BASIC**, **315 BASIC** and **355 BASIC** models

Place the insert end (see arrow) inside the jaw's groove, so that the insert lays on the **S** pin.

Press **P** key to allow complete insertion and fastening of the insert. Make sure that **P** returns to its initial position, afterwards.

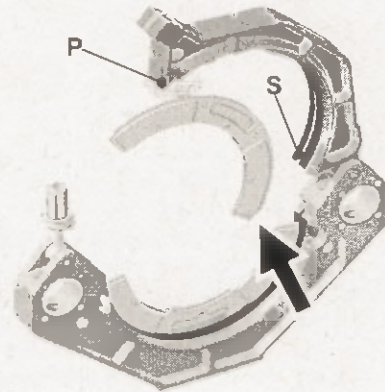

Repeat the operation with the other jaws.

Inserts could be mounted on adapters (master):

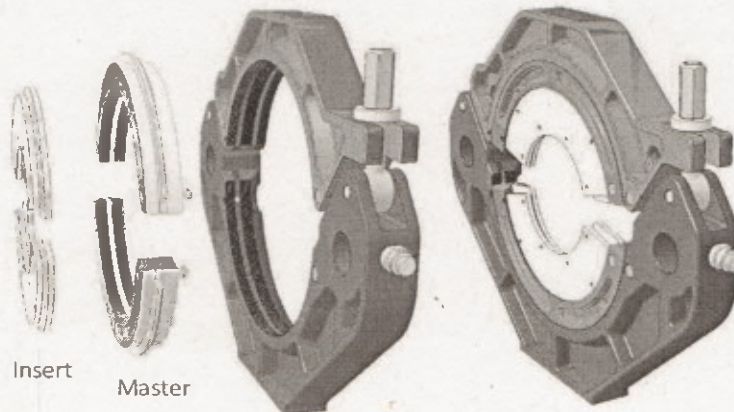

4. OPERATING INSTRUCTIONS

HOW TO WELD BETWEEN 2nd AND 3rd JAW

Assembly the drag bars **A** and the heating plate release plaques **B** as shown in the image below.

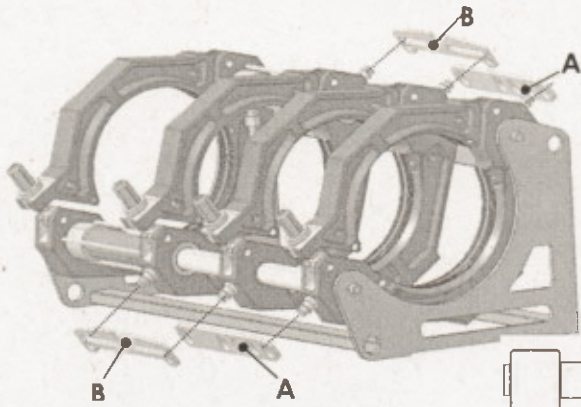

Important!

The heater tearout bracket **B** is not available for **BASIC 160** and **BASIC 200** models

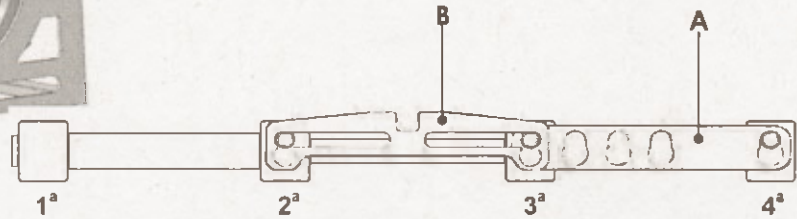

Insert the elements to be welded inside the clamps and fasten them.

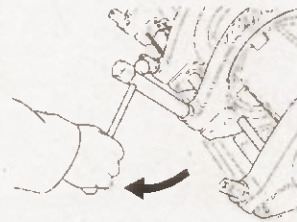
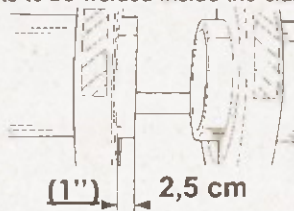

HOW TO WELD BETWEEN 3rd AND 4th JAW

Assembly the dragging bars **A** and the heating plate release plaques **B** as shown in the image below.

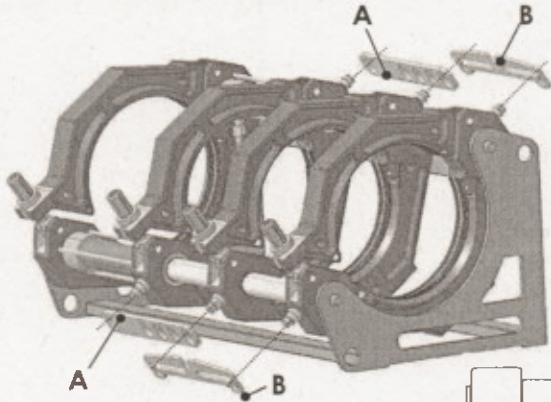

Important!

The heater tearout bracket **B** is not available for **BASIC 160** and **BASIC 200** models

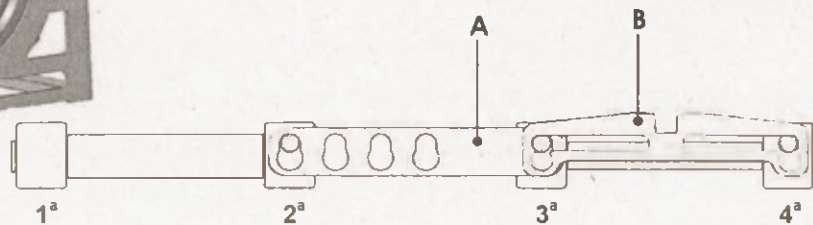

Insert the elements to be welded inside the clamps and fasten them.

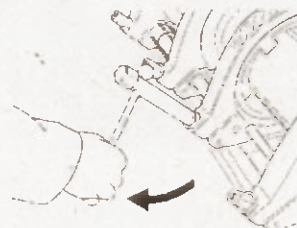
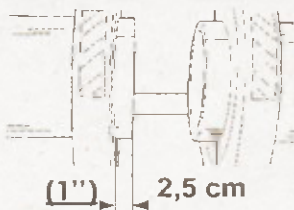

4. OPERATING INSTRUCTIONS

FACING

4.6.1. Position the facer in between the ends to be welded

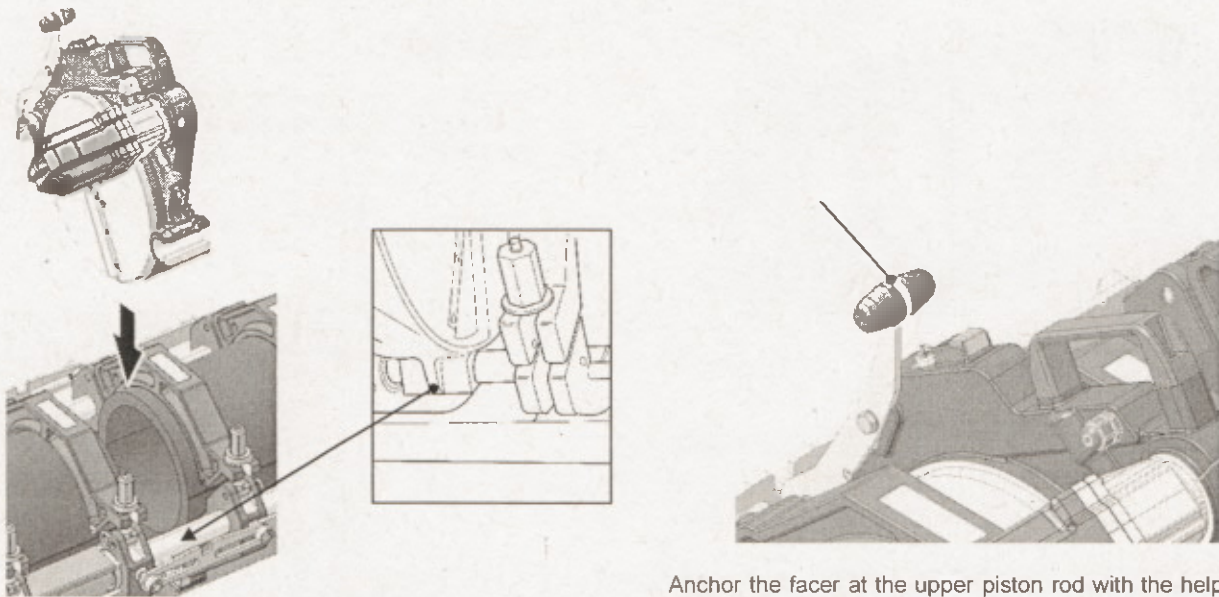

Rest the facer on the lower piston rod.

Anchor the facer at the upper piston rod with the help of the blocking lever M.

4.6.2. Turn on the facer by pressing the start push button (green).

Caution: do not use more than 10 Bar (+ drag pressure P_t)

Approach and face both ends to be welded without overstressing the motor.



4.6.3. As soon as you get a continuous and even shaving on both ends, stop the facing and open the carriage.

Shut down the motor by pressing the stop push button (red).

Remove the facer and place it in its housing. Remove the shavings without touching or fouling the faced ends.

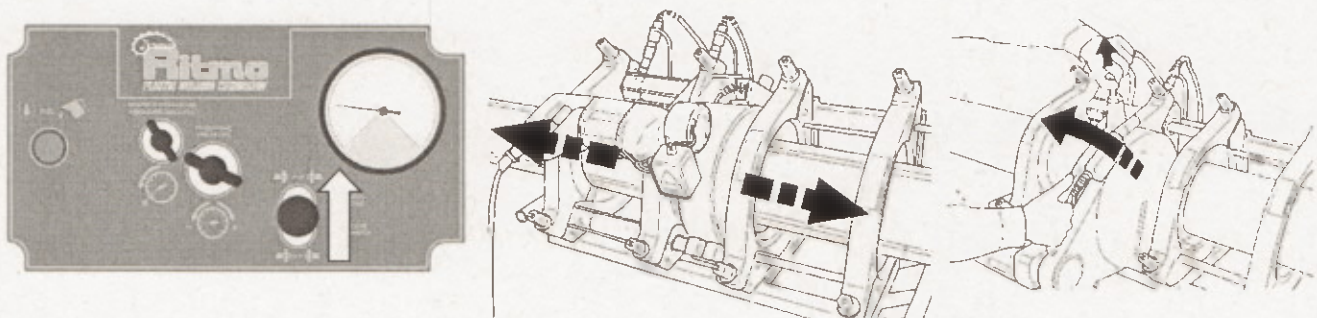

4. OPERATING INSTRUCTIONS

READING THE DRAG PRESSURE P_t

4.7.1. Push the distributor lever to the maximum and fully open the carriage.

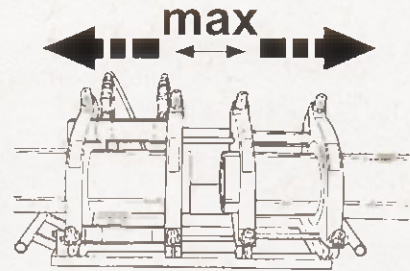

4.7.2. Turn the pressure release valve counter-clockwise to zero the pressure inside the hydraulic circuit.

Turn the release valve clockwise again.



4.7.3. The drag pressure P_t is the minimum pressure required to get the carriage in motion.



In order to find out the drag pressure P_t , fully pull the distributor lever and slowly turn clockwise the maximum pressure valve, until the carriage gets in motion. Read the pressure (P_t) on the pressure gauge and write it down

Warning: The P_t value must be measured before EACH welding

SIMPLE PRESSURE WELDING CYCLE

Remember to fill out a welding report at each phase, in order to keep track of the values.

Approach the carriage and fully pull the distributor level.

Turn the max pressure valve till (P_1+P_t) is displayed on the gauge pressure.



Open the pressure release valve to zero the pressure, then push the distributor lever and open the carriage

4. OPERATING INSTRUCTIONS



PHASE 1: Approach and Pre-heating

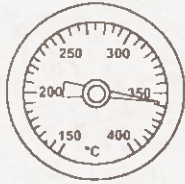

Once you have reached the correct heating plate temperature, insert it in between the two pipe edges

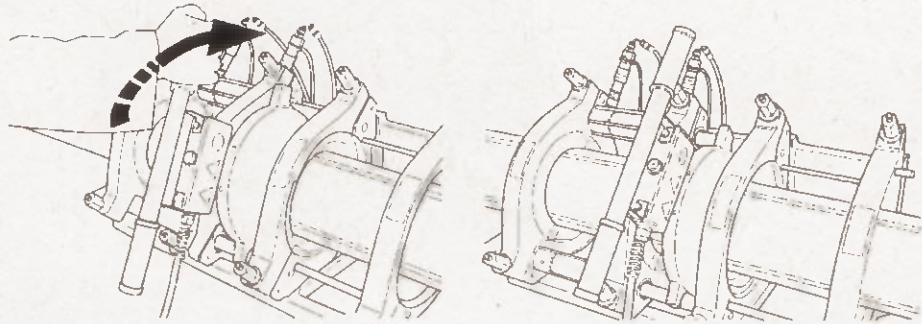

Close the pressure release valve, (turn it clockwise). Close the carriage by pulling the distributor lever and keep the pre-heating pressure ($P_1 + P_t$), until the bead reaches the size expected by the welding standard you're welding with.

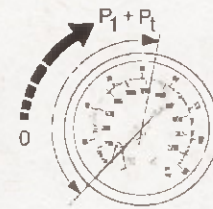
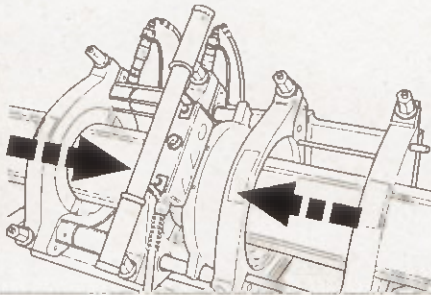
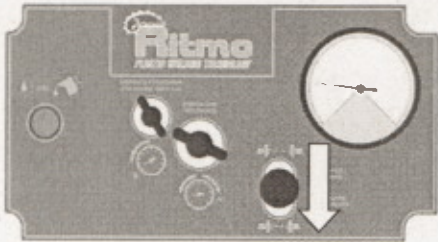

Slowly release the distributor lever.



PHASE 2: Heating

Unscrew the pressure release valve in a gradual manner until the maximum pressure P_2 is reached.

The P_2 is the pressure necessary to keep the pipes edges in contact with the heating plate

Close the pressure release valve by rotating it in a clockwise manner.

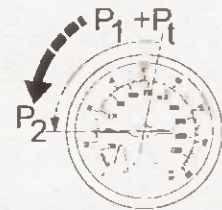

Wait for the t_2 time to end.

During the t_2 time, be sure that the ends NEVER detach from the heating plate. Should this happen, the welding MUST be repeated from the beginning.

Timer 1

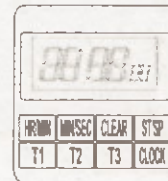

= t_2

4. OPERATING INSTRUCTIONS



PHASE 3: Removal of heating plate



Open the pressure release valve

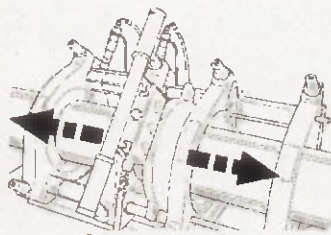

Open the carriage

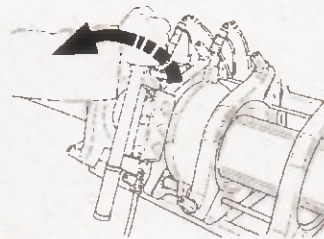

Remove the heating plate

$$t_{\max} = t_3$$

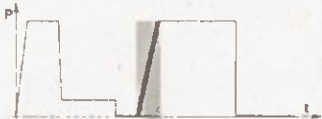

PHASE 4: Reach of welding pressure



Close the pressure release valve

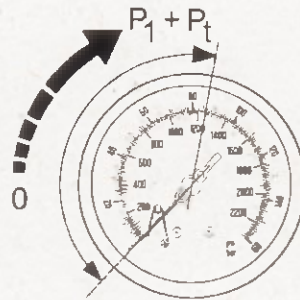

$$= t_4$$

Pull the distributor lever with gradual increasing force until you reach the pressure ($P_1 + P_t$) within the t_4 time.



PHASE 5: Welding

To stabilize the pressure keep pulled the distributor lever for 10 sec

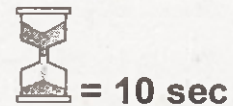

$$= 10 \text{ sec}$$

Slowly release the distributor lever.

Wait for the t_5 time to end.

Timer 2

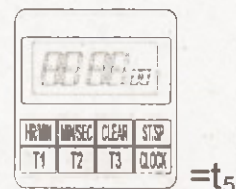

$$= t_5$$

4. OPERATING INSTRUCTIONS



PHASE 6: Cooling

Turn counter-clockwise the pressure release valve to zero the hydraulic pressure of the circuit.

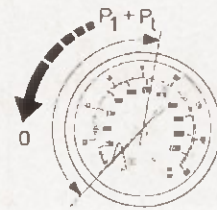

Wait until the joint has cooled down before removing it from the machine.



WHEN WELDING COMPLETED:

- Open the clamps and remove the welded pipe.
- Unplug the machine from the power supply at the end of operations
- Disconnect the components.
- Clean them accurately.
- Put them in their supports.

DUAL PRESSURE WELDING CYCLE

The Dual Pressure cycle is used when welding PE 100 with thickness equal or superior to 20 mm.

When welding PE 100 with thickness inferior to 20 mm, use the Simple Pressure cycle.

The first four phases are identical (with respect to the Simple Pressure cycle, then proceed as indicated below).

Remember to fill out the welding report at each phase.

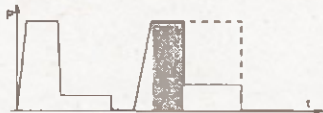

PHASE 5: Welding – FIRST PART

Keep the distributor lever pulled to the maximum..

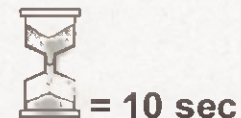

Slowly release the distributor lever.

4. OPERATING INSTRUCTIONS



PHASE 6: Welding – SECOND PART

Discharge pressure down to P_6 by unscrewing the pressure release valve.

Wait for the t_6 time to end.



Timer 2

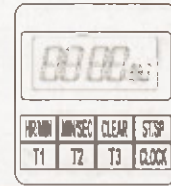

= t_6



PHASE 7: Cooling

Turn counter-clockwise the pressure release valve to zero the hydraulic pressure of the circuit.

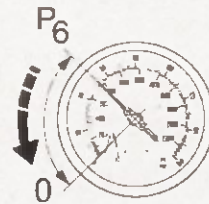

Wait until the joint has cooled down before removing it from the machine.



= t_7

Open the clamps and remove the welded pipe.

Unplug the machine from the power supply at the end of operations.

Disconnect the components.

Clean them accurately.

Put them in their supports.

5. MAINTENANCE



This machine can be damaged by hot environments with high humidity and salt. Clean at the end of each working day all the parts that can be damaged by oxidation (frame, cylinders, electrical and hydraulic connectors) with suitable detergents. Keep this product indoors and use covers to protect it from weather conditions: variations in night / day temperature could lead to the formation of condensation which causes oxidation. Direct sunlight could affect electrical and electronic components.

QUICK-COUPLING CONNECTIONS AND CONNECTORS

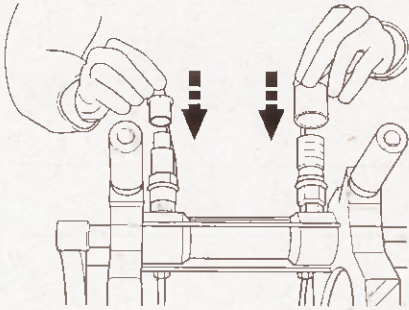

Keep connections and connectors clean at all times.

Prevent earth or sand in the hydraulic circuit by keeping the plugs on the connectors and connections.

CHASSIS

Keep cylinder rods clean at all times. Protect them against collision.

HYDRAULIC GEARCASE

Completely replace oil each 1000 weldings and at least once a year. (Used oil is very pollutant: **take it to the nearest hazardous waste collection site.**)

Use recommended oils only (see page 5 for specifications).

Check the oil level once a month. It must reach the level mark at the dipstick.

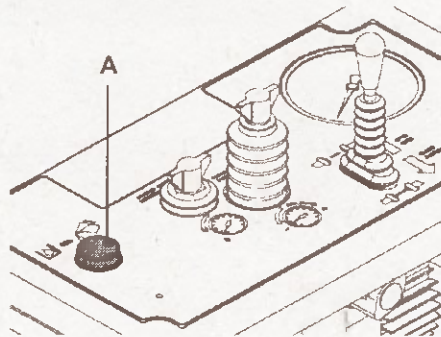

A: Tank cap with oil dipstick.

HEATING PLATE

Clean and place the heating plate in its housing (for coating protection) after operations.

FACER

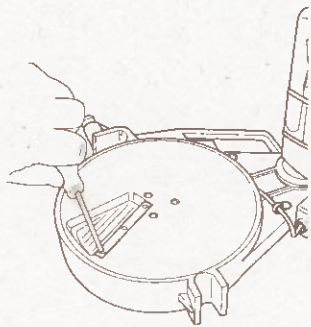

Replace both blades periodically.

Clean and place the facer in its housing after operations.



6. TROUBLE SHOOTING

If your **BASIC** machine is still under warranty, and a malfunctioning (regardless of its type or nature) happens, send the machine to **Ritmo**'s Service Center, or to an authorized one. Any unauthorized intervention, or authorized intervention done by non authorized personnel will immediately abort the warranty. Valid authorizations are done by writing, bear **Ritmo**'s stamp and a **Ritmo**'s employee signature, and are dated.

Unplug the machine from the power source before working on the electrical components.

CHASSIS

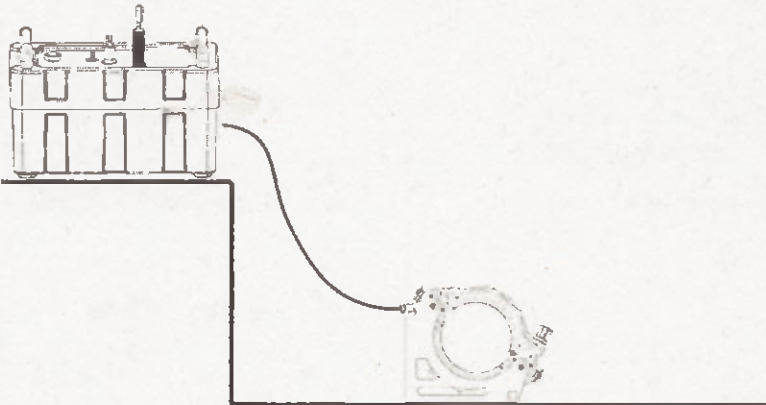
PROBLEM: Oil leakage.	
PROBABLE CAUSE	SOLUTION
Loosening / wear of: - hydraulic fittings - quick-coupling connections / connectors	Tighten the hydraulic fittings or the quick-coupling connections-connectors loosened. Replace worn-out fittings.
Hydraulic cylinders gaskets damaged.	Contact an authorized service center.

PROBLEM: Lack of pressure. Movable carriage with insufficient movement force.	
PROBABLE CAUSE	SOLUTION
Air in one or both hydraulic cylinders.	<p>1. Position the gearcase at a h height (gearcase ought to be higher than the chassis).</p>  <p>2. Move the machine carriage back and forward by activating the distributor lever, until air is eliminated.</p> 



6. TROUBLE SHOOTING

HYDRAULIC GEARCASE

PROBLEM: The gearcase does not work.	
PROBABLE CAUSE	SOLUTION
Plug or connection cable interrupted.	Check the plug contacts; restore them if necessary. Check the power cable; replace it if worn out.
Failure on the electrical system.	Check the electrical system (see electrical diagrams).

PROBLEM: Pressure peaks, wide and abrupt movements of the manometer needle.	
PROBABLE CAUSE	SOLUTION
Membrane of the hydraulic accumulator broken.	Replace the hydraulic accumulator.

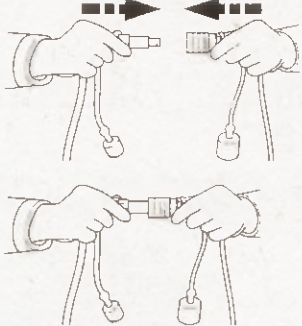
PROBLEM: Oil leakage.	
PROBABLE CAUSE	SOLUTION
Loosening / wear of: - hydraulic fittings - hydraulic hoses	Tighten the hydraulic fittings / hoses loosened. Replace worn-out hydraulic fittings / hoses.

PROBLEM: Lack of pressure.	
PROBABLE CAUSE	SOLUTION
Lack of oil in the tank.	Add oil (it must reach the level mark at the dipstick).
Air in the hydraulic circuit.	<div style="display: flex; align-items: center;"> <div style="flex: 1;">  <p style="text-align: center;">Unite the quick-coupling connectors - connections.</p> </div> <div style="flex: 1;">  <p style="text-align: center;">Activate the gearcase motor for 30 seconds by pulling the distributor lever.</p> </div> </div>
Impurity in the hydraulic circuit.	Contact an authorized service center.

6. TROUBLE SHOOTING

HEATING PLATE

Unplug the machine from the power source before working on the electrical components.

PROBLEM: The heating plate does not heat or it is impossible to adjust the temperature, but LEDs work.	
PROBABLE CAUSE	SOLUTION
Thermoregulator failure	Replace the thermoregulator.
Thermoregulator failure	Replace the thermoregulator.

PROBLEM: The heating plate does not heat or it is impossible to adjust the temperature, and green LED is off.	
PROBABLE CAUSE	SOLUTION
Thermoregulator failure	Replace the thermoregulator.
Thermoregulator failure	Replace the thermoregulator.

FACER

Unplug the machine from the power source before working on the electrical components.

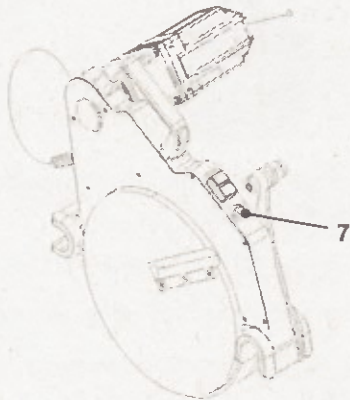
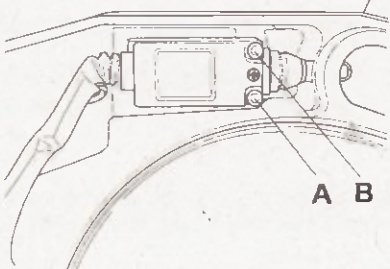
PROBLEM: The facer does not work.	
PROBABLE CAUSE	SOLUTION
Circuit breaker intervention.	<p>Wait until the motor has cooled down, then push the circuit breaker button (7).</p> 
<p>Interrupted connection.</p> <p>Interrupted power cable.</p>	<p>Check the board contacts (electronic circuit and plug) and, if necessary, reconnect them. Check the electrical system.</p> <p>Check the power cable and replace it, if worn-out.</p>
Safety microswitch inefficient or out of place.	<p>Remove the protection plaque and replace the microswitch, or adjust its position using A and B screws so that the contact is closed only by positioning the facer on the upper piston rod.</p> 

7. SAFETY PRECAUTION

INTRODUCTION

The use of the welding machines **BASIC** is intended for skilled and certified (*) personnel only.

(*) Certified according to the Legislation and regulations in force (e.g., UNI 9737).

The machine is to be used only for the functions described in Chapter 1 "Product Introduction and Specifications" and always according to the instructions for use and maintenance herein. Any other use shall be considered improper and is therefore forbidden, as it may cause damage to the operator/third parties/other objects, and/or to the machine itself.

The Safety Precautions herein indicated must be taken into consideration at all times.

It is strictly forbidden to remove each and every safety device (e.g., switches, microswitches, seals, etc.).

Promptly replace any worn-out or damaged component with original **Ritmo** spare parts, only.

Any sort of intervention on the machine must be done by authorized skilled and qualified personnel only.

ELECTRICAL HAZARDS



ELECTROCUTION HAZARD

Parts involved: HYDRAULIC GEARCASE
FACER
HEATING PLATE

Be sure that the electrical specifications of the power supply correspond to the ones of the machine.



Earth the machine.

Control if the earthed system is working properly.

Be sure that the panel board or the generator to which the machine is connected during operations has a highly sensitive differential switch ($I_{\Delta n}=30\text{mA}$).

The panel board plugs must belong to the IEC 309 type with IP44 minimum protection degree.

Do not let the machine be exposed to rain or any other liquids.

Be sure that the isolating protection devices (such as the safety gloves) are perfectly dry when you use the machine.

Do not let the cables be exposed to chemical substances, mechanical strain, or general hazards such as tugs, sharp objects, or the passage of vehicles or passers-by, etc.

Unplug the machine from the power source as soon as operations are over, or even momentarily suspended.

Check the integrity of all components before using the machine. Pay particular attention to the isolating parts, cables, cable fairleads and cable glands.

Test the proper intervention of the differential switch once a month.

Thoroughly clean the machine and its components after use. Do not use substances that could damage the isolating parts, such as solvents, gasoline (combustibles in general), or abrasive liquids.

Extensions must comply with the regulations in force and be suitable for the power requested. Use only type IEC 309, IP67 plugs.

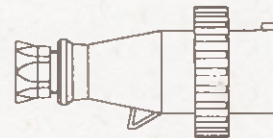

SELV (Safety Extra Low Voltage) equipment is required when working in:

- narrow spaces
- extremely damp places
- sites surrounded by metal structures or water (e.g., shipyards)

7. SAFETY PRECAUTION

MECHANICAL HAZARDS



CRUSH HAZARD

Part involved: CHASSIS

Keep a safe distance from the moveable carriage.

Attention !!!: When crushing happens, immediately activate the distributor lever to OPEN the carriages (the lever must go towards the manometer direction).

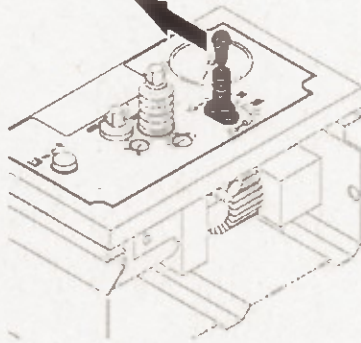

Be sure that the machine is stable at all times.

Be sure that the elements to be welded, as well as the clamps, are correctly and well fastened.

Put work safety into practice at all times.



Always wear your safety shoes.



CUTTING HAZARD

Part involved: FACER

Keep a safe distance from the machine when the facer is working.

Handle the facer with caution.



Always wear your safety gloves.



SPLINTERING HAZARD

Part involved: FACER

Keep a safe distance from the machine when the facer is working.

Clean the ends that are going to be welded before fastening them. Be sure that no deposits remain (earth, gravel, etc.).



Always wear your safety glasses/goggles.

7. SAFETY PRECAUTION



Moving Machinery

ENTANGLEMENT / ENTRAPMENT HAZARD

Parts involved: CHASSIS
FACER

Keep a safe distance from the machine when the movable carriage is in motion or when the facer is working.

Remove all your bracelets and necklaces. Gather up long hair. Do not use loose clothing.



Always wear your safety coverall.

THERMAL HAZARDS



280° C

BURNING HAZARD

Part involved: HEATING PLATE

Keep a safe distance from the heating plate when it's switched on, and handle it with prudence.

Clean the heating plate with maximum caution.

Do not touch the welding bead or the areas around it while they are still hot



Always wear your safety gloves.



FIRE HAZARD

Part involved: HEATING PLATE

Do not use the machine in atmospheres subject to explosion for the presence of inflammable vapors, gazes, etc.

Keep heat-sensitive and inflammable substances (such as oils, solvents, paint, etc.) out of the heating plate reach.

7. SAFETY PRECAUTION

SAFETY WORKING AREA



WARNING!

The operator(s) must remain in the mesh area on the right during the jointing process. The trolley cannot be moved during the alignment.

The operator may leave the command area while positioning and locking the pipes. Once these operations have been accomplished, the operator must return to the command area, and remain there throughout the entire process.

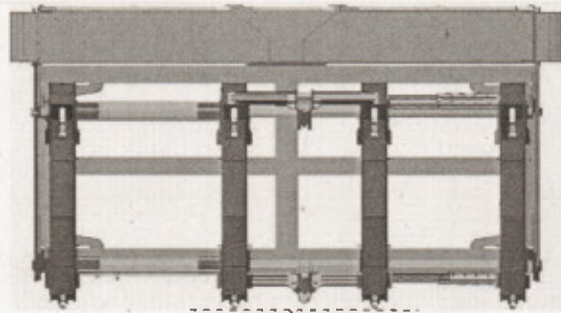

Safety distance
2 mt from the foremost
part of the machine



DISPOSAL

 Do not dispose of in the household trash. Add the device that is no longer able to be used to a separate collection for the purpose of environmentally friendly recycling. Contact Ritmo S.p.A. for further info.

WARNING

The specifications of the device and the data entered in this manual are subject to change without notice from the manufacturer.

Full parts lists and technical documents are available online at www.ritmo.cloud.

Help in the event of problems:



Ritmo S.p.A.

via A. Volta, 35/37 - Z.I. Selve
35037 BRESSEO DI TEOLO (PD)
ITALY

Tel. +39.049.990.1888

Fax +39.049.990.1993

service@ritmo.it

8. WELDING PARAMETERS

PIPE/FITTING FEATURES

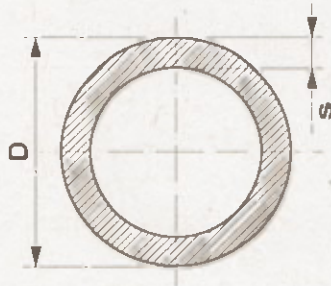

The pipe/fitting classification in **Standard Dimension Ratio (SDR)**, **Series (S)**, **Nominal Pressure (NP)**, as well as the welding parameters, they all depend on the **dimensions** of the pipe/fitting:

D: Outside diameter

s: Wall thickness (use a calibre to measure)

These are the formulas and ratios to be taken into consideration:

$SDR = \frac{D}{s}$ <p>(Standard Dimension Ratio)</p>	$S = \frac{1}{2} \left(\frac{D}{s} - 1 \right)$	$SDR = 2 \times S + 1$	$S = \frac{SDR - 1}{2}$
---	--	------------------------	-------------------------

SDR	41	33	27,6	26	22	21	17,6	17	13,6	11	9	7,4	6
S	20	16	13,3	12,5	10,5	10	8,3	8	6,3	5	4	3,2	2,5
PN (PE 80)	3,2	4	///	5	6	///	///	8	10	12,5	16	20	25
PN (PE 100)	4	5	6	///	///	8	///	10	12,5	16	20	25	32
PN (PP)	2,5	3,2	///	4	///	///	6	///	///	10	12,5	16	20

(Nominal Pressure at 20° C)

The welding parameter list, 'SET & GO' app, in compliance with various regulations for the most common diameters and thickness of pipes / fittings, is available for Android/iPhone

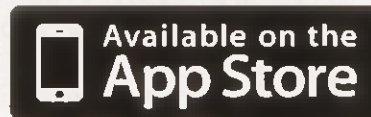
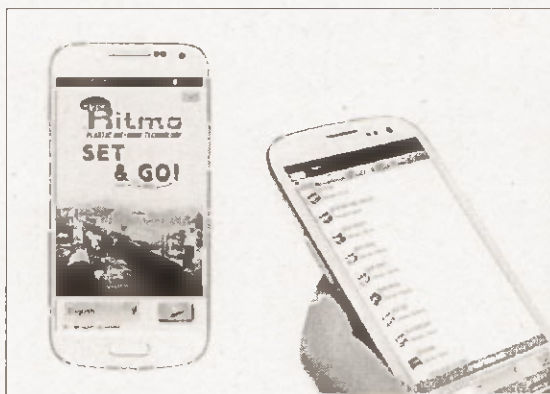

NOTE 1: Add the drag pressure (P_t) measured by the operator when setting the welding pressure.

NOTE 2: Measure the actual pipe diameter and thickness before setting the welding parameters.

NOTE 3: The welding parameters might be subjected to changes according to the ambient temperature.

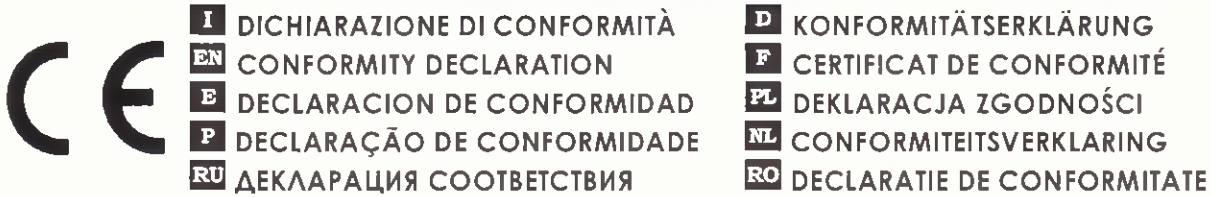

Ritmo S.p.A.

Via A. Volta, 35-37 - Z.I. Selve - 35037 Bressio di Teolo (PD) - ITALIA
Tel. +39-049-9901888 Fax +39-049-9901993

I Dichiaro che il prodotto di mia produzione di seguito identificato:	D Erkläre, daß das Produkt seiner Produktion, wie folgt identifiziert:
EN Declares that the product of its production named as follows:	F Déclare que le produit de sa production identifié comme suit:
E Declaro que los productos identificados mas abajo:	PL Oświadczam, że produkt jego produkcji określone poniżej:
P Declaro que os seguintes soldadoras (de sua produção):	NL Verklaart dat het product wordt geïdentificeerd door onze productie als volgt:
RU Заявляю, что изготовленный ею продукт назван следующим образом:	RO Declara că produsul din lista lui de produse:

BASIC 160 V2 – BASIC 200 V0 – BASIC 250 V1 – BASIC 315 V1 – BASIC 355 V0

I e conforme alle disposizioni delle seguenti Direttive;	D gemäss den folgenden gesetzlichen Richtlinien entspricht;
EN is made in compliance with the following directives:	F est conforme aux directives suivantes
E esta conforme con lo dispuesto;	PL jest wykonany zgodnie z następującymi wytycznymi;
P respèttam quanto indicato nas seguintes Directivas e Normativas;	NL in overeenstemming met de toepasselijke wettelijke eisen;
RU произведена в соответствии со следующими директивами;	RO este în conformitate cu dispozițiile următoarelor Directive:

2006/42/CE
2014/30/UE
2014/35/UE
ISO 12176-1: 2017
UNI 11732: 2018
EN ISO 12100: 2010
CEI EN 60204-1: 2018 (CEI 44-5)
2011/65/EU ROHS II

I La presente dichiarazione perde ogni validità in caso di modifiche apportate al prodotto non approvate esplicitamente e per iscritto dal costruttore.	D Die Gültigkeit der vorliegenden Erklärung ist nichtig im Falle von Änderungen des Gerätes, die nicht ausdrücklich schriftlich vom Hersteller genehmigt wurden.
EN This declaration becomes null and void in the event of any changes being made to the product without the written and explicit manufacturer's approval.	F Cette déclaration n'est plus valable en cas de modifications non approuvées expressément par écrit par le fabricant.
E Esta declaración no es válida en caso de aportar modificaciones a los productos sin la expresa autorización escrita del fabricante.	PL Ta deklaracja staje się nieważna, w przypadku wszelkich zmian wprowadzanych w produkcie bez zgody pisemnej i wyrażonej producenta.
P Qualquer modificação efectuada ao aparelho, que não tenha sido autorizada a priori em modo explícito e por escrito pelo fabricante, anula a presente declaração.	NL De geldigheid van deze verklaring vervalt indien het geval van veranderingen in het apparaat welke niet uitdrukkelijk schriftelijk goedgekeurd zijn door de fabrikant.
RU Это заявление становится недействительным в случае внесения каких-либо изменений в продукт без письменного и явного согласия производителя.	RO Prezenta declarație își pierde valabilitatea în caz de modificări caute produsului, neaprobate explicit și în scris de constructor.

Bressio di Teolo, 15-Mar-19

Rappresentante legale:
Legal representative:
Reprezentant legal:
Законный представитель:
Geseondigde Verreter:
Secretarului legal/Pracostawiciel
pravniho prezidenta legal:
Wettelijke vertegenwoordiger:

Rossella Contiero:



Firma/Signature/Unterschrift/ Firma/ Asculat/Inscris/ Unterschrift/ Podpis/Handtekening

