



# EU - TYPE EXAMINATION CERTIFICATE



No. SK 15 - 058 MI-003 Rev. 6

*This revision replaces all previous versions of this Certificate in full wording*

Issued by **Slovenská legálna metrologia, n. o.** Notified Body number **1432**  
**Hviezdoslavova 31**  
**974 01 Banská Bystrica**  
**Slovak Republic**

In accordance with Annex II, Module B to Government Ordinance of the Slovak Republic No. 145/2016 Coll. relating to the making available on the market of measuring instruments, which implements, in Slovakia, the Directive 2014/32/EU of the European Parliament and of the Council of 26 February 2014 on the harmonisation of the laws of the Member States relating to the making available on the market of measuring instruments as later amended (MID).

Applicable essential requirements Annex I and Annex V to MID

Manufacturer **Applied Meters, a.s.**  
**Budovateľská 50**  
**080 01, Prešov**

Applicant **Manufacturer**

Measuring instrument **Active electrical energy meter**

Type **AMT B2...**  
Trade mark see Descriptive annex  
SW version see Descriptive annex

Environment classes  
- climatic (-40 to +70)°C  
- mechanical M1  
- electromagnetic E2

Description and documentation The principal technical and metrological data, characteristics, instrument description and approval conditions are set out in the Descriptive annex to this EU - type examination certificate (13 pages), which is part of this EU - type examination certificate. The test reports, designs, schematic diagrams and documentation used during certification process are recorded under reference folders Applied\_AMTB2\_rev0 to rev6.

Valid until **17 March 2025**

Date of issue 25 March 2021

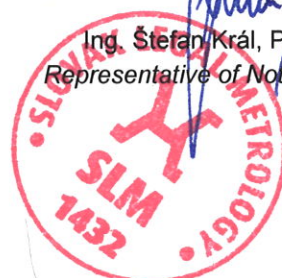

Ing. Štefan Král, PhD.  
Representative of Notified Body

*Where the instrument is subject to other Directives covering other aspects, this EU - type examination certificate is valid, assuming that the instrument conforms to the provisions of those Directives. Without written permission of the notified body this certificate may be reproduced only as a whole.*



## DECISION ON CERTIFICATION

**Number: B/MI-003/2021-58-6**

**Product** Active electrical energy meter  
**Type** AMT B2...  
**Manufacturer** Applied Meters, a.s.  
Budovateľská 50  
080 01, Prešov  
**Applicant** manufacturer  
**Application No** 2020/MI-003/B055  
**Evaluation report** 51/1432/20 MI-003

### Product classification

Active electrical energy meter (MI-003) according to Annex V of Directive 2014/32/EU of the European Parliament and of the Council of 26 February 2014 on the harmonisation of the laws of the Member States relating to the making available on the market of measuring instruments as later amended (MID).

### Regulations, harmonised standards and normative documents used for certification

Government Ordinance of the Slovak Republic No. 145/2016 Coll. relating to the making available on the market of measuring instruments, which implements in Slovakia, the Directive 2014/32/EU of the European Parliament and of the Council of 26 February 2014 on the harmonisation of the laws of the Member States relating to the making available on the market of measuring instruments as later amended.

EN 50470-1: 2006; EN 50470-3: 2006; WELMEC 11.1; -; WELMEC 11.3; WELMEC 7.2

**Certification scheme** Module B

### Summary of evaluation

On the basis of tests, measurements, investigations, assessments and evaluations results, the Evaluation report No. 51/1432/20 MI-003 of 23.3.2021 and the review related to the evaluation of 23.3.2021 were worked out, upon which the conformity of product performances with the essential requirements stated in regulations given above was found.

### Decision on certification

approve

reject

### Date of issue

2021-03-25

### Decision approved by

Ing. Štefan Král, PhD.  
Director of PCB

### Note:

An appeal may be brought against this decision within 15 days of the date of its notification. The appeal shall be lodged with the notified body which issued the contested decision.



## 1. Designation

Three-phase static active electrical energy meter type **AMT B2...** is intended for metering of the active electrical energy in residential (households), commercial and light industrial use. The meter is designed for indoor use.

The meter **AMT B2...** variety is marked by means of additional characters (present or missing) according to the following rule:

**AMT B2X<sub>1</sub>-X<sub>2</sub>X<sub>3</sub>X<sub>4</sub>X<sub>5</sub>X<sub>6</sub>X<sub>7</sub>X<sub>8</sub>**

where

X <sub>1</sub>	current overload - I <sub>max</sub> /I <sub>ref</sub> in %:	3 – 200 (semi-direct connection via CT*), 4 - 400, 5 - 500, 6 - 600, 8 - 800; A - 1000, B -1200, C – 1300, D - 1600, E – 2000, F – 2400
X <sub>2</sub>	basic design	F - active electrical energy meter with LCD and real time clock
X <sub>3</sub>	measuring of	A - active electrical energy R - active + reactive electrical energy S - active + reactive + apparent electrical energy
X <sub>4</sub>	power connection	2 - two-phase 3-wires, 4 – three-phase 4-wires
X <sub>5</sub>	current sensor	T - transformer
X <sub>6</sub>	meter case	C – DIN 35 mounting, I <sub>max</sub> ≤ 65 A, current terminal Ø 6 mm E - for I <sub>max</sub> ≤ 100 A, current terminal Ø 8 mm 9 - for I <sub>max</sub> ≤ 120 A, current terminal Ø 9,5 mm
X <sub>7</sub>	procesor type	I - <i>Texas Instruments</i>
X <sub>8</sub>	special modules	E - external second tariff control 4 - RS485 interface M - Mesh (wireless) interface G - GSM/GPRS interface P – PLC communication interface Y - auxiliary relay

\* - CT (current transformer)

## 2. Description

### 2.1.1 Essential parts of the electricity meter:

- three measuring circuits with measuring sensors (identical for each phase circuit);
- main printed circuit board;
- main CPU (with real time clock)
- register block with LCD;
- power supply;
- optical interface;
- terminal block and terminal cover;
- housing of the meter (ultrasonic welding - alternative).

### 2.1.2 Non-essential parts of the electricity meter:

- not applicable

## 2.2 Metrological functions

### 2.2.1 Essential functions

- Measuring, storing and displaying of active electrical energy in both directions (import and export) and in maximum four tariff rates.





### 2.2.2 Non-essential functions

- measuring, storing and displaying of import/export reactive electrical energy in four quadrants and in four tariffs;
- measuring, storing and displaying of import/export apparent electrical energy in four tariffs;
- measuring and displaying of instantaneous import/export active, reactive and apparent electrical power;
- calculation and displaying of average active, reactive and apparent power (average demand) for a chosen measurement period;
- calculation and displaying of maximum active, reactive and apparent demand for a chosen measurement period;
- recording of historic values of energy, maximum demand, voltage and current (billing period reset);
- recording of measured data in load profiles;
- recording of events in logbooks (one or four according to software version);
- displaying and recording the number of supply interruptions;
- displaying and recording the number and the last date of the terminal cover removal;
- displaying and recording the number and the last date of the meter cover removal;
- displaying and recording the number and the last date of the magnetic field interruptions;
- measuring and displaying of an instantaneous voltage, current, power, frequency and power factor;
- measuring and recording of registers operational time;
- recording of the last programming date;
- recording of the last meter readout date;
- displaying and recording of the meter errors register;
- signalization of measuring circuits malfunction;
- incorrect phase sequence identification;
- internal rate control in four rates (ToU tables);
- external rate control in two rates.

Detailed descriptions and operation of the meter, block and wiring diagrams; values of parameters may be found in manufacturer's documentation stored in folders from Applied\_AMTB2\_rev0\_00 to AMTB2\_rev6\_00.

### 2.3 Software

Software version *	096.00	108.01	108.02	108.03	108.10	136.00
Checksum (CRC16)	0x7013	0xED5D	0xE00B	0xF9FC	0xA285	0xEC45
Software version *	136.01	136.02	136.03	136.04	136.05	136.10
Checksum (CRC16)	0x18A2	0XD5F8	0xA5A2	0x25A2	0xAA86	0x5220

Note \*): Software version is shown on the LCD by OBIS code 0.2.0.

### 2.4 Optional equipment and functions subject to MID requirements

- not applicable



## 2.5 Integrated equipment and functions not subject to MID

- optical interface (essential) – communication protocol: IEC 62056-21;
- DIN 35 rail mounting (optional);
- RS 485 interface (optional) – communication protocol: IEC 62056-21;
- Mesh interface (optional) – communication protocol: IEC 62056-21;
- GSM/GPRS interface (optional) – communication protocol: IEC 62056-21;
- PLC interface (optional) - communication protocol: IEC 62056-21;
- Via the communication no legally relevant data can be altered.
- auxiliary relay 2A connecting acc. tariff (optional);
- SO outputs parametrized for active/reactive energy (optional).
- sensors of removing the terminal cover and the meter cover;
- magnetic field detector;
- see also p. 2.1.2 and p. 4.

All meter integrated parts and meter functions mentioned in section 2.5 and all displayed values which have not been mentioned in section 2.2.1 are not covered by the scope of Directive 2014/32/EU in accordance with Annex V. They have not been subjected to conformity assessment according to the MID at SLM.

## 3. Technical and metrological data

Parameter	Unit	Value	
Connection type	-	Direct	Semi-direct
Reference voltage $U_n$	V	3 × 220/380 ... 3 × 240/415	
Reference frequency $f_n$	Hz	50	
Reference current* $I_{ref}$	A	5, 10	5
Maximum current $I_{max}$	A	40, 50, 60, 65, 80, 100, 120	10
Transitional current $I_{tr}$	A	0,5; 1	0,25
Minimum current $I_{min}$	A	0,25; 0,5	0,05
Meter constant	imp/kWh	standard 1000 (optional from 1 to 30000)	
Accuracy class (index)	-	A or B	
Mechanical class	-	M1	
Electromagnetic class	-	E2	
Specified temperature range of operation	°C	(-40 / +70) °C	
Protection degree	-	IP51 (meter case C) or IP53	
Installation conditions	-	indoor	

\* Note: reference current  $I_{ref} = 10 \times I_{tr} = I_b$  for direct connected meters according to EN 62052-11

## 4. Interfaces and compatibility conditions

- Optical interface – communication protocol: IEC 62056-21;
- RS 485 interface (optional) – communication protocol: IEC 62056-21;
- Mesh interface (optional) – communication protocol: IEC 62056-21;



- GSM/GPRS interface– communication protocol: IEC 62056-21;
- PLC interface (optional) - communication protocol: IEC 62056-21;
- auxiliary relay 2A connecting acc. tariff (optional);
- SO outputs parametrized for active/reactive energy (optional).

Via the interface no legally relevant data shall be altered. Measured data transferred via this interface are not considered as a metrological relevant data in sense of MID.

## 5. Marking and inscriptions

The following data shall be marked on the electricity meter:

- a) manufacturer's mark or name;
- b) manufacturer's postal address (article 8, point 6 of Directive 2014/32/EU);
- c) type of the meter;
- d) serial number and year of production;
- e) reference voltage ( $U_n$ );
- f) reference current ( $I_{ref}$ );
- g) minimum current ( $I_{min}$ );
- h) maximum current ( $I_{max}$ );
- i) reference frequency ( $f_n$ );
- j) class index (A or B);
- k) temperature range of operation;
- l) electromagnetic and mechanical class;
- m) the connection mode for which the meter is specified;
- n) meter constant;
- o) meter directionality type;
- p) EU-type examination certificate number SK 15 - 058 MI-003;
- q) CE marking and supplementary metrology marking according to Article 21 and Article 22 of Directive 2014/32/EU (CE marking and supplementary metrology marking following with number of a notified body).

Any inscriptions on the meter must be in the EU official language; international abbreviations are admitted. Markings on the measuring instrument shall comply with the requirements of Article 9, Annex 1 to Directive 2014/32/EU.

### 5.1 Designation of trademarks on the electricity meters

Manufacturer may use the following trademark on its electricity meters:



## 6. Security measures

The electricity meter shall be protected against unauthorised manipulation by sealing marks according Fig. 5.

- a) meter cover (integrity) ..... 2\* x
- b) terminal cover (electric cable connections), SD card cover\* ..... 2 (3\*\*) x

\* optional – screws are sealed by plastic cover plugs

\*\* optional – sealing of the cover of the SD card of the GPRS communication module



## **7. Requirements on production, putting into use and utilization**

### **7.1 Requirements on production**

- no special requirements identified.

### **7.2 Requirements on putting into use**

- electricity meters must be installed in accordance with requirements listed in installation and user manual issued by the manufacturer;
- initial verification tests of electricity meters can be carried out with the technical requirements in line with.

### **7.3 Requirements for utilization**

- in accordance with requirements of the manufacturer's documentation.

## **8. Documentation used for assessment purposes**

- evaluation report No. 051/1432/20 MI-003, of 23/03/2021, issued by SLM NB 1432;
- manufacturer's technical documentation stored in the folders from Applied\_AMTB2\_rev0\_00 to Applied\_AMTB2\_rev6\_00.

## **9. Standards and regulations used for assessment purposes**

### **9.1 Regulations, harmonized standards and normative documents**

- Government Ordinance of the Slovak Republic No. 145/2016 Coll. relating to the making available on the market of measuring instruments, which implements, in Slovakia, the Directive 2014/32/EU of the European Parliament and of the Council of 26 February 2014 on the harmonisation of the laws of the Member States relating to the making available on the market of measuring instruments as later amended (MID);
- EN 50470-1;
- EN 50470-3;
- EN 62058-31.

### **9.2 Further applied standards and documents**

- WELMEC Guide 11.1, Issue 7;
- WELMEC Guide 7.2, Issue 2015.

## **10. Final provisions on electricity meter**

Construction, technical and metrological parameters of the meter must comply with the documentation presented within the process of type certification. All the characteristics of the measuring instrument (including those not mentioned) shall meet the respective requirements of Government Ordinance of the Slovak Republic No. 145/2016 Coll. relating to the making available on the market of measuring instruments, which implements, in Slovakia, the Directive 2014/32/EU of the European Parliament and of the Council of 26 February 2014 on the harmonisation of the laws of the Member States relating to the making available on the market of measuring instruments as later amended (MID).





11. Figures

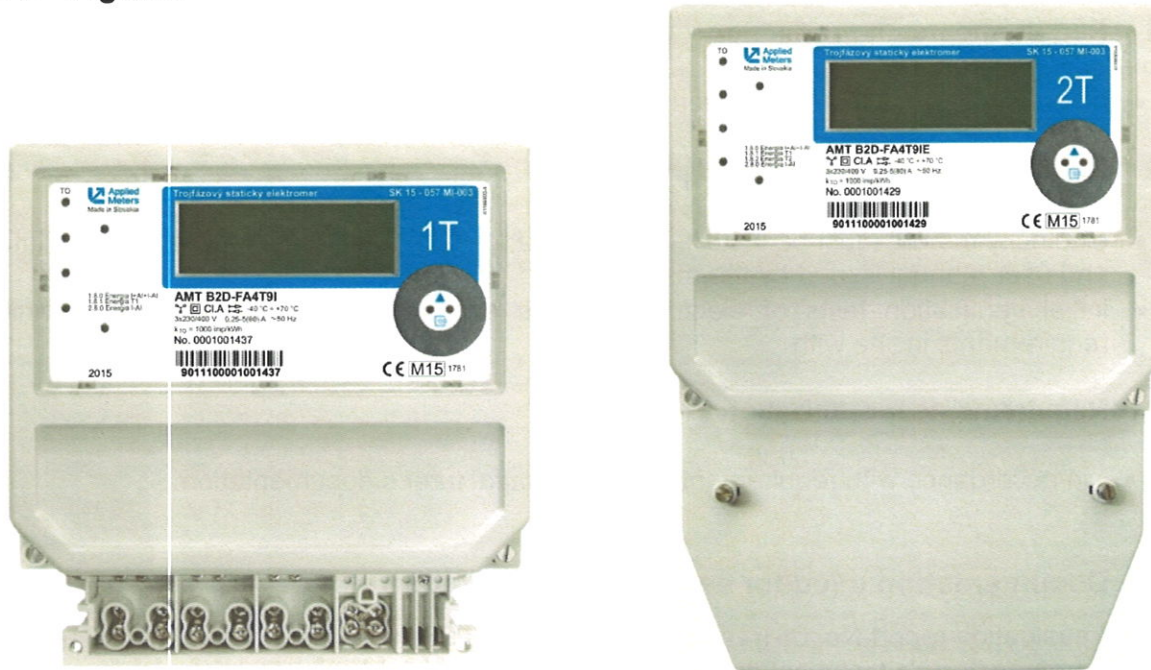

Fig. 1a: Electricity meter *Applied Meters AMT B2x-FA4T9I(E)*

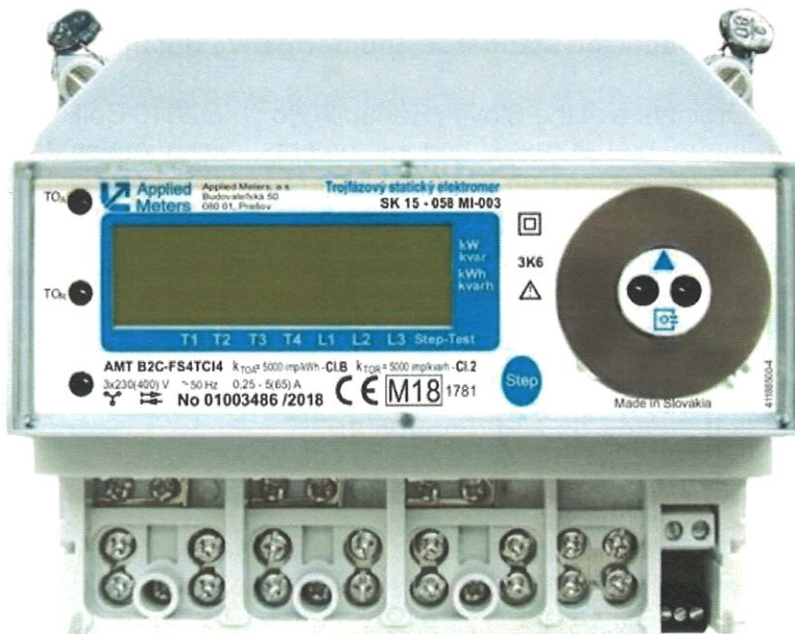

Fig. 1b: Electricity meter *Applied Meters AMT B2C-FS4TCI4* with DIN 35 rail





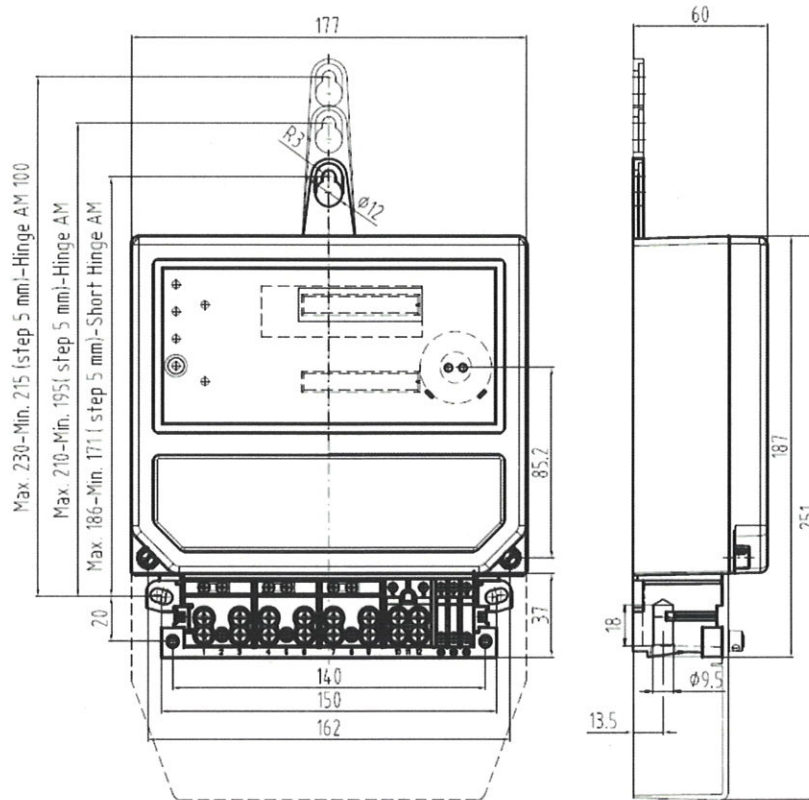

Fig. 2a: View and main dimensions of the electricity meter *Applied Meters AMT B2x-Fx4T9I*

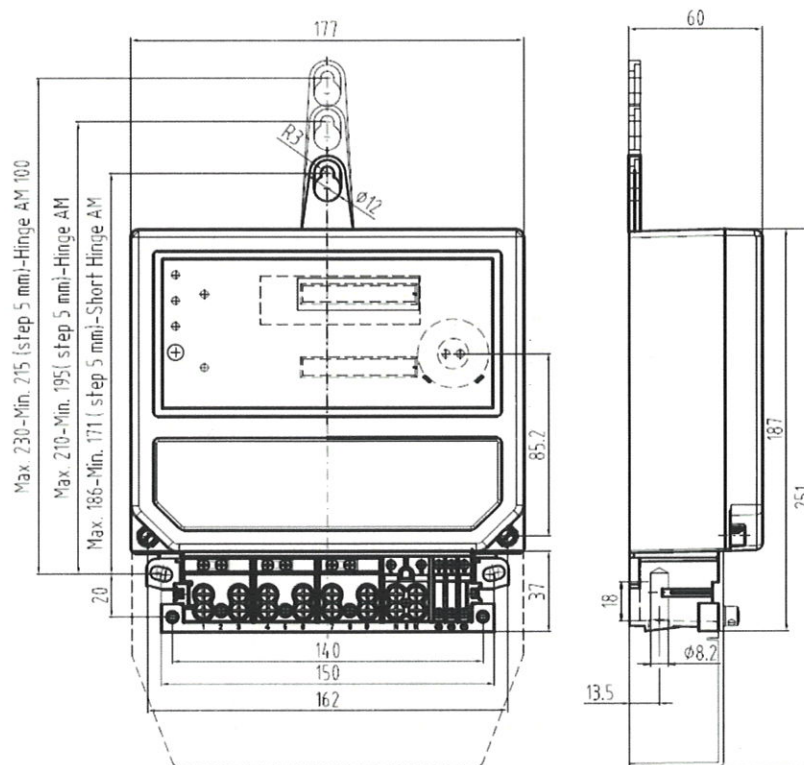

Fig. 2b: View and main dimensions of the electricity meter *Applied Meters AMT B2x-Fx4TEI*

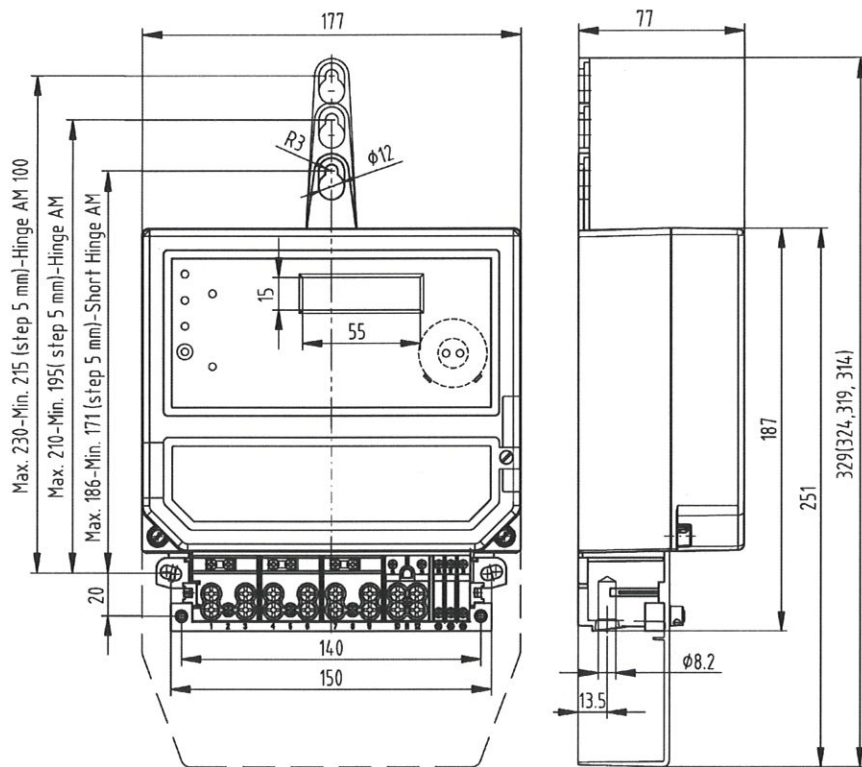

Fig. 2c: View and main dimensions of the electricity meter *Applied Meters AMT B2x... with GPRS interface*

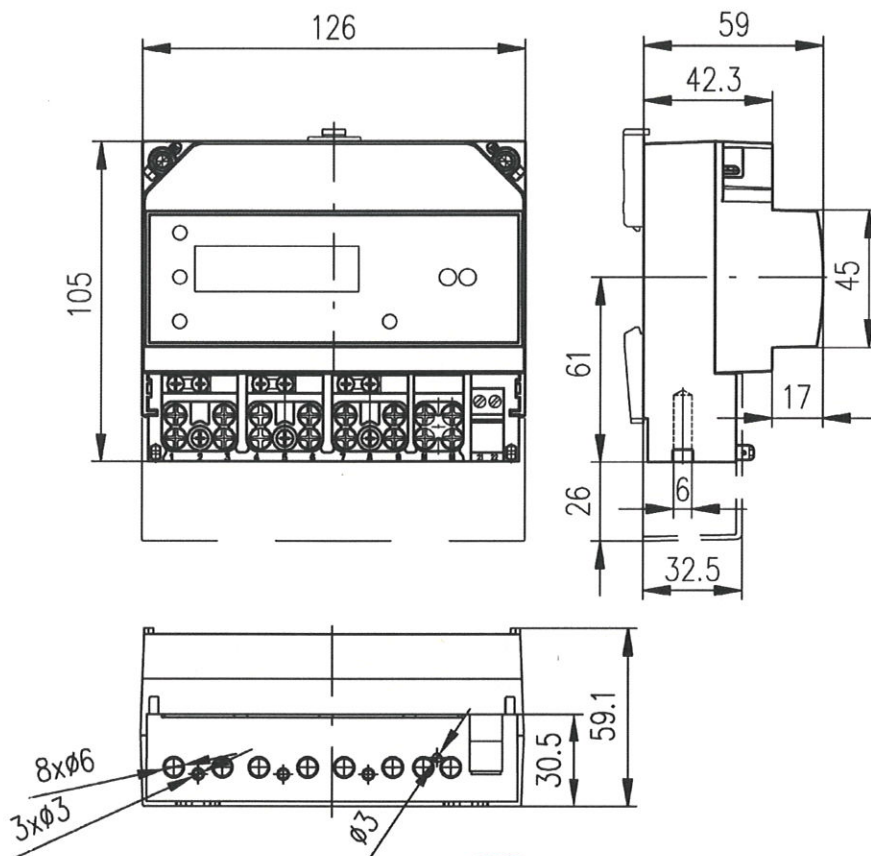

Fig. 2d: View and main dimensions of the electricity meter *Applied Meters B2C-FS4TC14 with DIN 35 rail*





Fig. 3a: Example of marking on the name-plate of the electricity meter *Applied Meters AMT B2x-FA4T9I(E)*

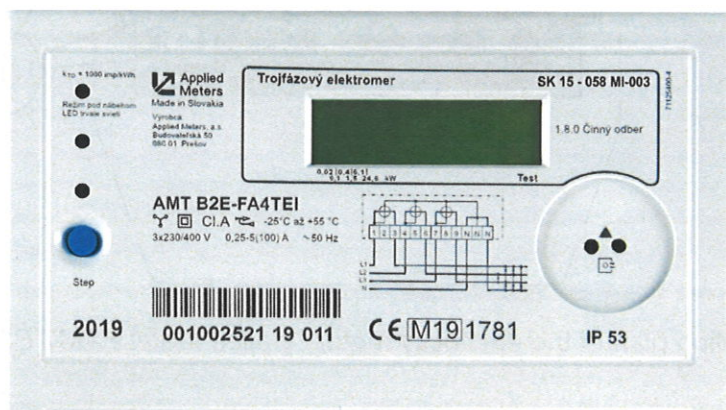

Fig. 3b: Example of marking directly on cover of the electricity meter – *Applied Meters AMT B2x-FA4T9I(E)* (alternative - by laser printing)

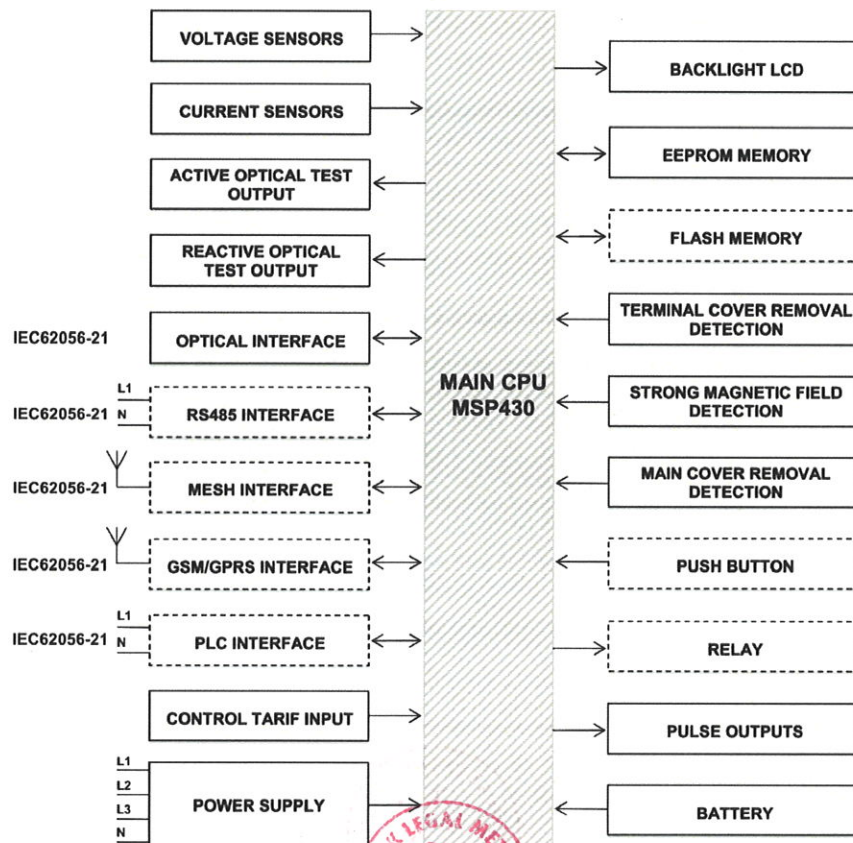

Fig. 4: Block diagram of the electricity meter *Applied Meters AMT B2x-Fx4TxIx*

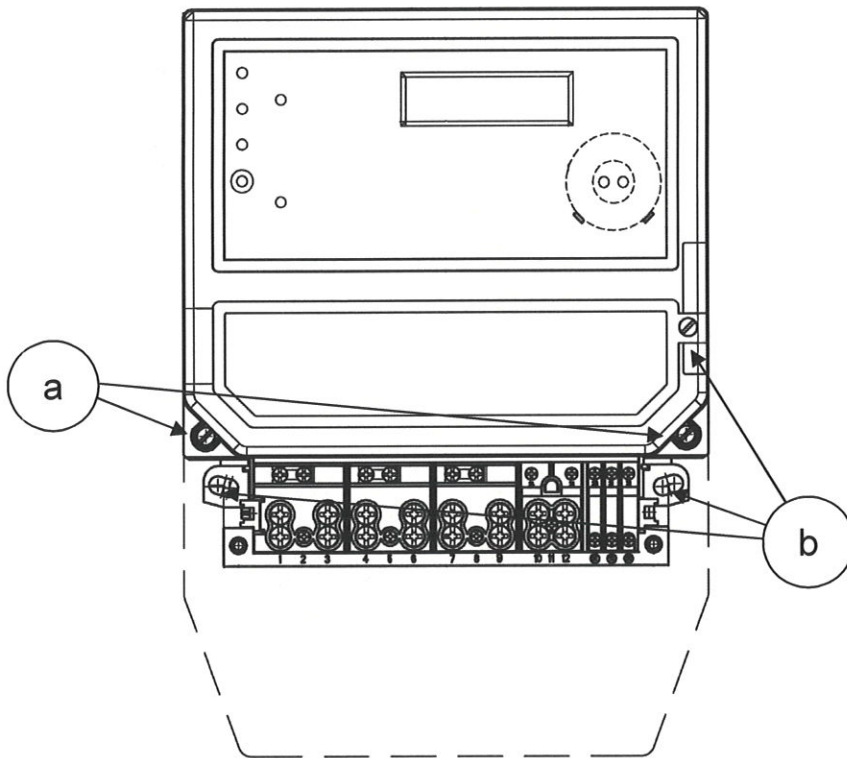

Fig. 5a: Sealing plan of the electricity meter *Applied Meters AMT B2x-FA4T9I(E)*

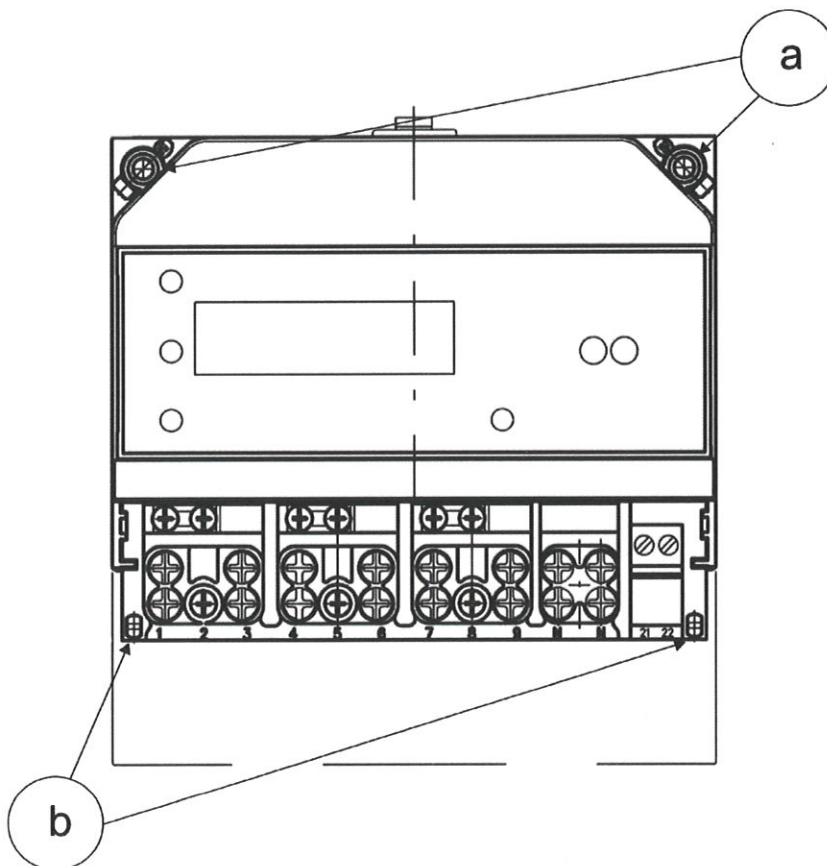

Fig. 5b: Sealing plan of the electricity meter *Applied Meters AMT B2x- B2C-FS4TCI4*  
with DIN 35 rail





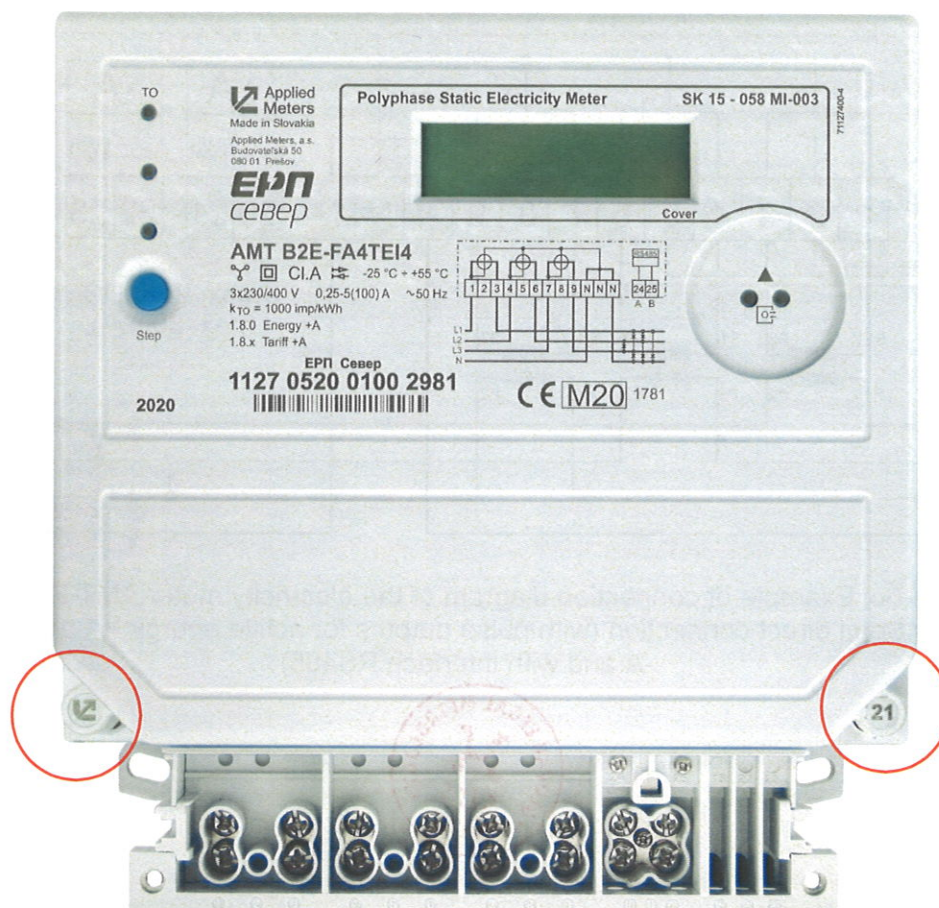

Fig. 5c: Sealing plan of the electricity meter *Applied Meters AMT B2E\_FA4TEI4* (alternative – with Cover Plug Of Hole Sealing Screw)

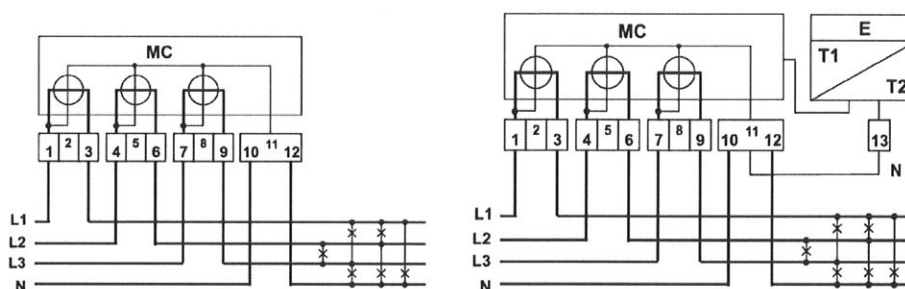

Fig. 6a: Examples of connection diagrams of the electricity meter *AMT B2x-FA4T9I(E)*

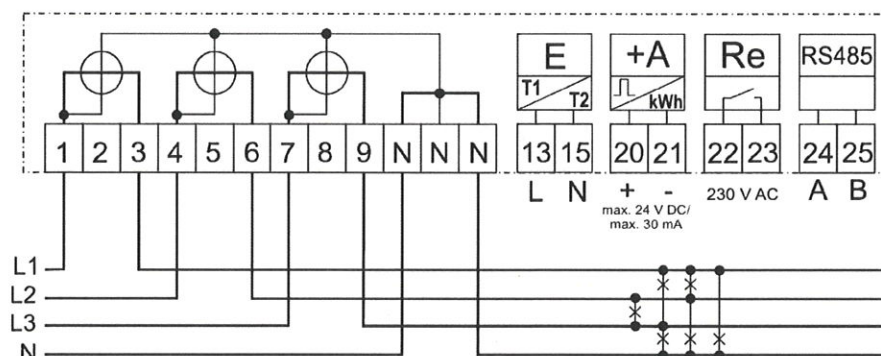

Fig. 6b: Example of connection diagram of the electricity meter *AMT B2x-FA(R,S)4TEIE4Y* (with external rate control relay and interface RS485)

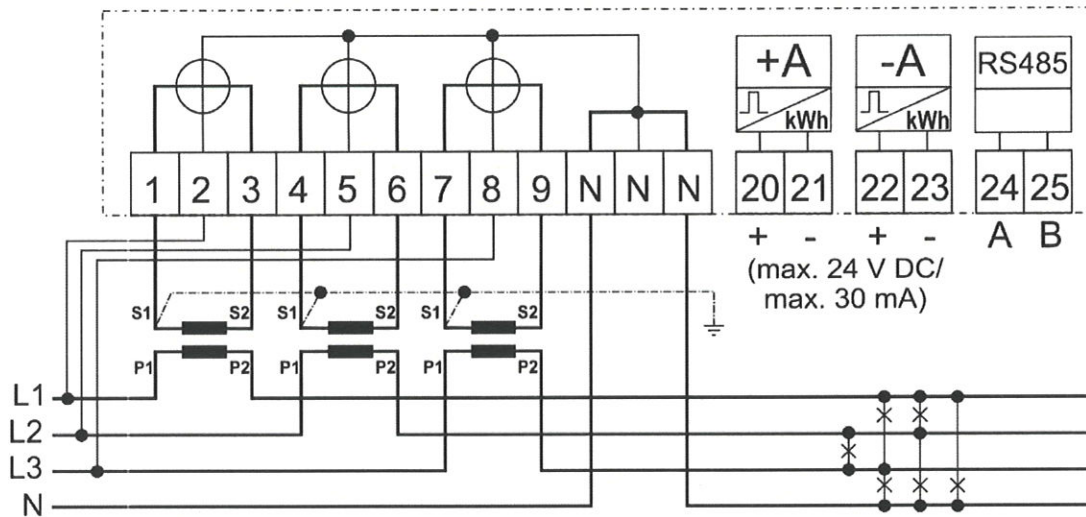

Fig. 6c: Example of connection diagram of the electricity meter AMT B23 for Semi direct connection (with pulse outputs for active energy +A and -A and with interface RS485)





## 12. Influence factors for temperature, frequency and voltage variation

Data of the specimen representative of the type:

Type of the measuring instrument	-	AMT B2D-FA4T9I(E)
Serial numbers of the sample	-	0001001432
Test report no.	-	2014/MI-003/B058/001
Reference current $I_{ref}$	A	5
Minimum current $I_{min}$	A	0,25
Transitional current $I_{tr}$	A	0,5
Maximum current $I_{max}$	A	80
Reference voltage $U_n$	V	3x230/400
Reference frequency $f_n$	Hz	50
Accuracy class	-	B

Influence factors for temperature, frequency and voltage are determined at each load during the type examination.

$$e_c = \sqrt{e^2(I, \cos \varphi) + \delta^2(T, I, \cos \varphi) + \delta^2(U, I, \cos \varphi) + \delta^2(f, I, \cos \varphi)}$$

with

- $e(I, \cos \varphi)$  intrinsic error of the meter at a certain load
- $\delta(T, I, \cos \varphi)$  additional percentage error due to the variation of the temperature at certain load
- $\delta(U, I, \cos \varphi)$  additional percentage error due to the variation of the voltage at certain load
- $\delta(f, I, \cos \varphi)$  additional percentage error due to the variation of the frequency at certain load

Values of additional percentage error  $e_c(T, U, f)$ :

Current	PF $\cos \varphi$	Ambient temperature range						
		55 to 70 °C	40 to 55 °C	30 to 40 °C	5 to 30 °C	-10 to 5 °C	-25 to -10 °C	-40 to -25 °C
$I_{min}$	1	0,55	0,16	0,07	0,44	0,07	0,16	0,55
$I_{tr}$	1	0,33	0,11	0,06	0,09	0,06	0,11	0,33
$10 I_{tr}$	1	0,13	0,10	0,07	0,12	0,07	0,10	0,13
$I_{max}$	1	0,10	0,08	0,06	0,08	0,06	0,08	0,10
$I_{tr}$	0,5 ind	0,58	0,27	0,23	0,22	0,23	0,27	0,58
$10 I_{tr}$	0,5 ind	0,27	0,21	0,19	0,13	0,19	0,21	0,27
$I_{max}$	0,5 ind	0,35	0,44	0,39	0,34	0,39	0,44	0,35
$I_{tr}$	0,8 cap	0,40	0,14	0,08	0,08	0,08	0,14	0,40
$10 I_{tr}$	0,8 cap	0,16	0,11	0,11	0,11	0,11	0,11	0,16
$I_{max}$	0,8 cap	0,09	0,07	0,10	0,08	0,10	0,07	0,09

