

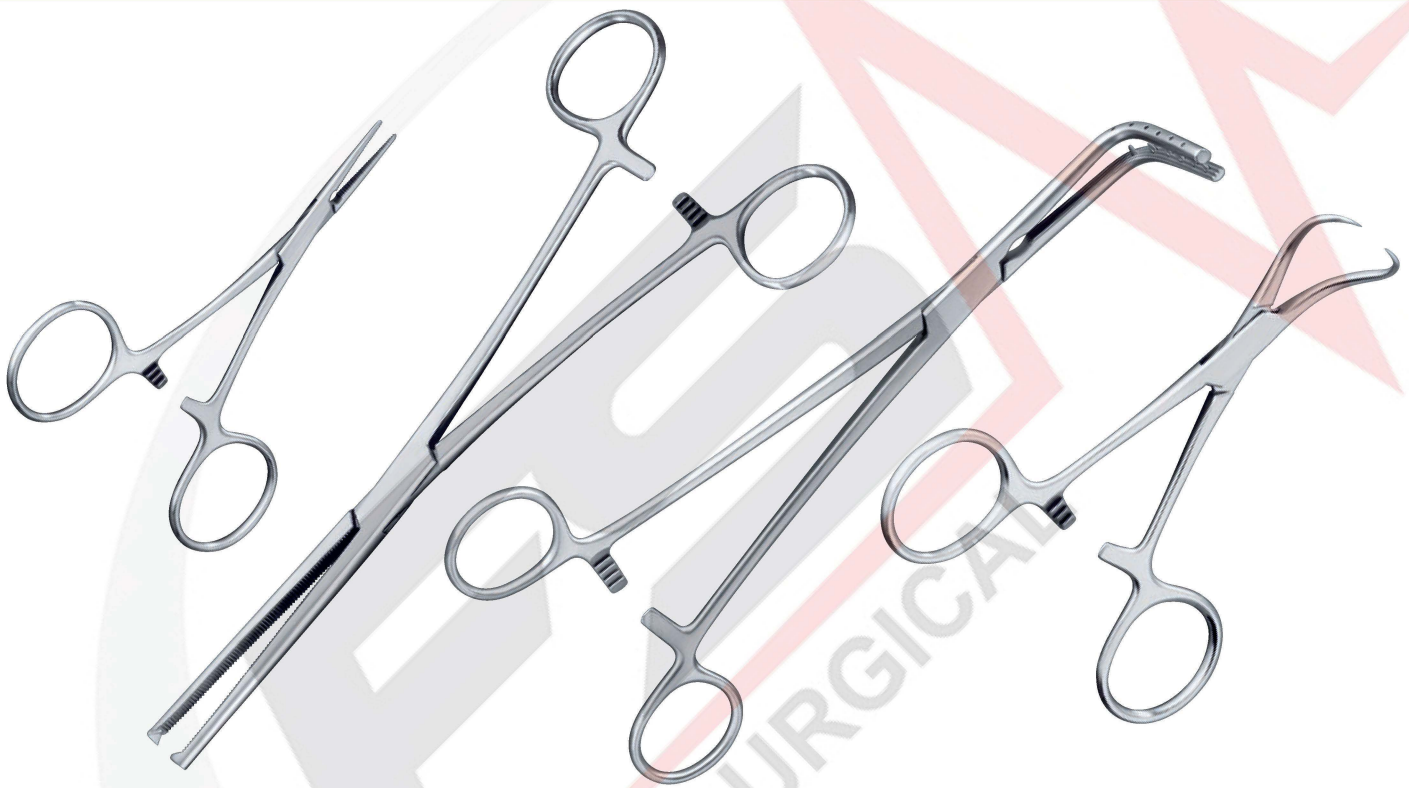

ARTERIENKLEMMEN – HAEMOSTATIC FORCEPS

By
Fizza Surgical International

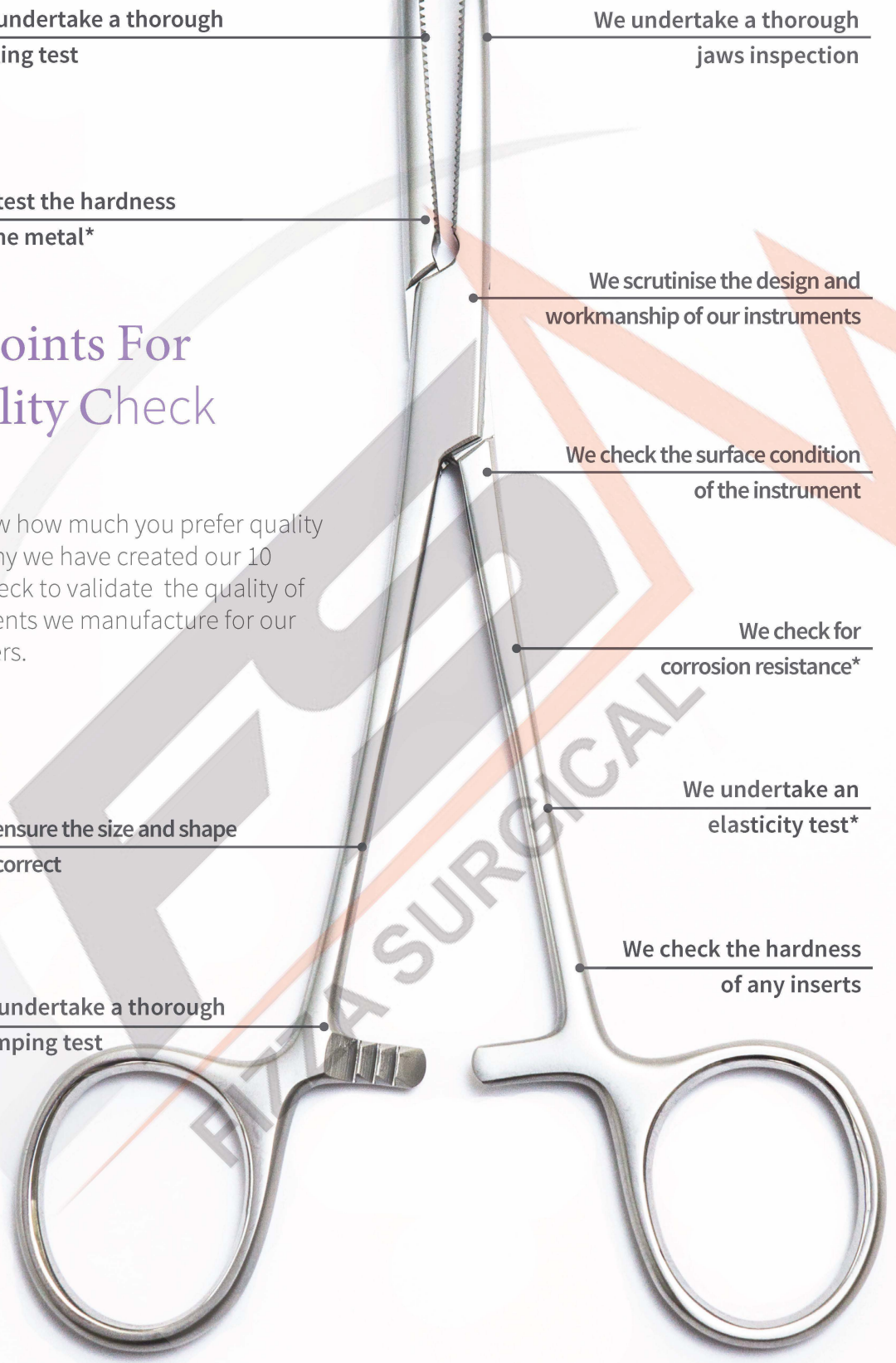



1 We undertake a thorough cutting test

2 We test the hardness of the metal*

3 We ensure the size and shape are correct

4 We undertake a thorough clamping test

5 We undertake a thorough jaws inspection

6 We scrutinise the design and workmanship of our instruments

7 We check the surface condition of the instrument

8 We check for corrosion resistance*

9 We undertake an elasticity test*

10 We check the hardness of any inserts

10 Points For Quality Check

We know how much you prefer quality that's why we have created our 10 point check to validate the quality of instruments we manufacture for our customers.

ARTERIENKLEMMEN – HAEMOSTATIC FORCEPS

Gefäßklemmen
Haemostatic forceps
Serre-fines
Serrafinas
Serrafine



DIEFFENBACH

JOHNS HOPKINS

35 mm – 1 1/2"	HF 04-05-01	HF 04-06-01
50 mm – 2"	HF 04-05-02	HF 04-06-02
60 mm – 2 1/4"	HF 04-05-03	HF 04-06-03

50 mm – 2"	HF 04-10-01
65 mm – 2 1/2"	HF 04-10-02
75 mm – 3"	HF 04-10-03



DIETHRICH



x =	50 mm – 2"	50 mm – 2"	50 mm – 2"	60 mm – 2 1/4"	50 mm – 2"
y =	8 mm	12 mm	16 mm	20 mm	8 mm
	HF 04-15-01	HF 04-15-02	HF 04-15-03	HF 04-15-04	HF 04-15-05

x = Länge
Length

y = geriefte Maullänge
serrated jaw part

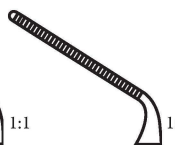

50 mm – 2"	50 mm – 2"	60 mm – 2 1/4"
12 mm	16 mm	20 mm
HF 04-15-06	HF 04-15-07	HF 04-15-08

ARTERIENKLEMMEN – HAEMOSTATIC FORCEPS

Arterienklemmen
 Haemostatic forceps
 Pinces hémostatiques
 Pinzas hemostáticas
 Pinze emostatiche

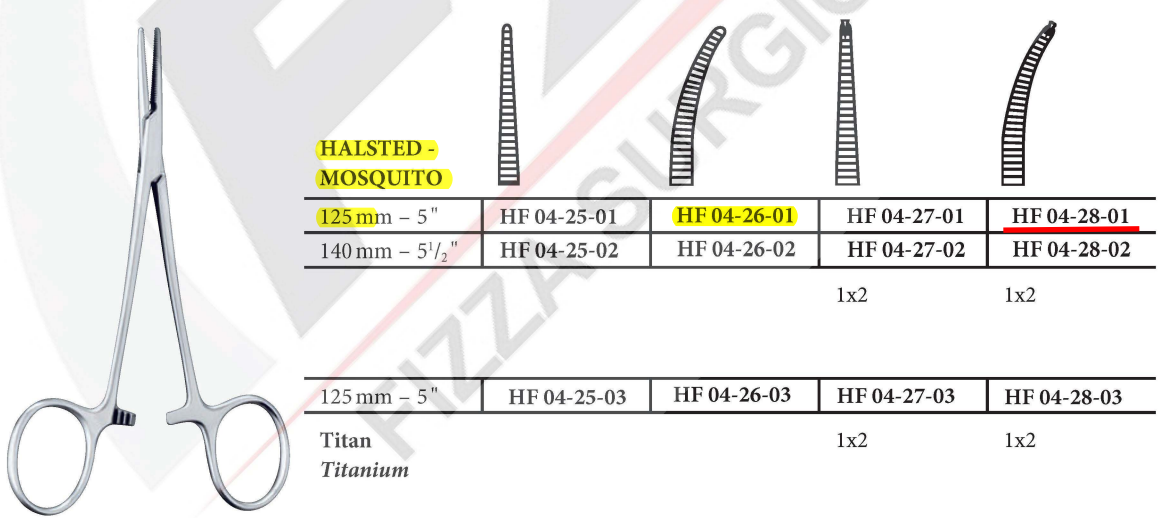
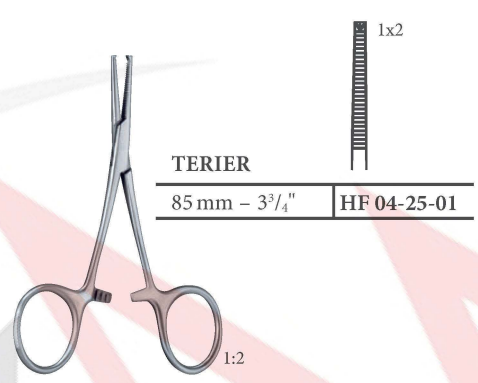
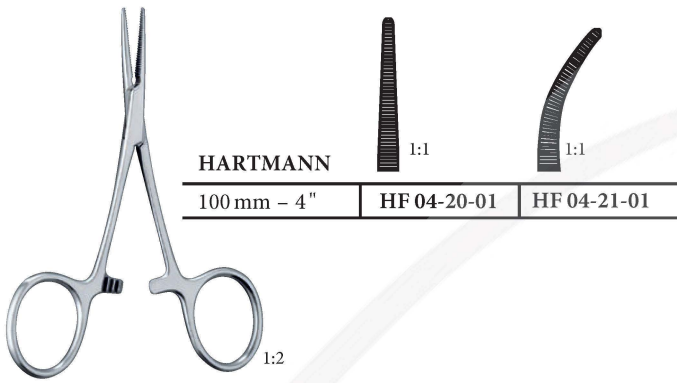

ARTERIENKLEMMEN – HAEMOSTATIC FORCEPS

Arterienklemmen
Haemostatic forceps
Pincés hémostatiques
Pinzas hemostáticas
Pinze emostatiche



Micro - MOSQUITO

100 mm – 4"	HF 04-30-01	HF 04-31-01	HF 04-32-01	HF 04-33-01
120 mm – 4 ³ / ₄ "	HF 04-30-02	HF 04-31-02	HF 04-32-02	HF 04-33-02
130 mm – 5"	HF 04-30-03	HF 04-31-03	HF 04-32-03	HF 04-33-03

1x2

1x2



PROVIDENCE - HOSPITAL

140 mm – 5 ¹ / ₂ "	HF 04-35-01	HF 04-36-01
--	-------------	-------------

1:2



DANDY

140 mm – 5 ¹ / ₂ "	HF 04-40-01	HF 04-41-01
--	-------------	-------------

seitlich gebogen
curved to the side

1x2



MOSQUITO - DANDY

120 mm – 4 ³ / ₄ "	HF 04-45-01
140 mm – 5 ¹ / ₂ "	HF 04-45-02
150 mm – 6"	HF 04-45-03

seitlich gebogen
curved to the side

1:2

ARTERIENKLEMMEN - HAEMOSTATIC FORCEPS

Arterienklemmen
Haemostatic forceps
Pinces hémostatiques
Pinzas hemostáticas
Pinze emostatiche

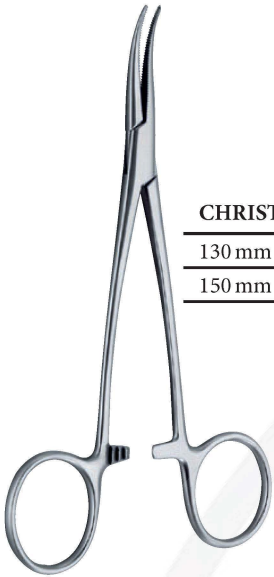

CHRISTOPHE

130 mm - 4"	HF 04-50-01
150 mm - 6"	HF 04-50-02



LOVELACE

155 mm - 6"	HF 04-55-01	HF 04-56-02
-------------	-------------	-------------

1x2



LERICHE

150 mm - 6"	HF 04-60-01	HF 04-61-01
-------------	-------------	-------------



LERICHE

150 mm - 6"	HF 04-65-01	HF 04-66-01
-------------	-------------	-------------





1x2

1x2

ARTERIENKLEMMEN – HAEMOSTATIC FORCEPS

Arterienklemmen
Haemostatic forceps
Pincés hémostatiques
Pinzas hemostáticas
Pinze emostatiche







		
KELLY		
140 mm – 5½"	HF 04-70-01	HF 04-71-01

KELLY - RANKIN		
160 mm – 6¼"	HF 04-75-01	HF 04-76-01

KELLY		
140 mm – 5½"	HF 04-80-01	HF 04-81-01



				
CRILE				
140 mm – 5½"	HF 04-85-01	HF 04-86-01	HF 04-87-01	HF 04-88-01
			1x2	1x2

CRILE - RANKIN				
160 mm – 6¼"	HF 04-90-01	HF 04-91-01	HF 04-92-01	HF 04-93-01
			1x2	1x2

CRILE		
140 mm – 5½"	HF 04-95-01	HF 04-96-01

ARTERIENKLEMMEN – HAEMOSTATIC FORCEPS

Arterienklemmen
Haemostatic forceps
Pincés hémostatiques
Pinzas hemostáticas
Pinze emostatiche

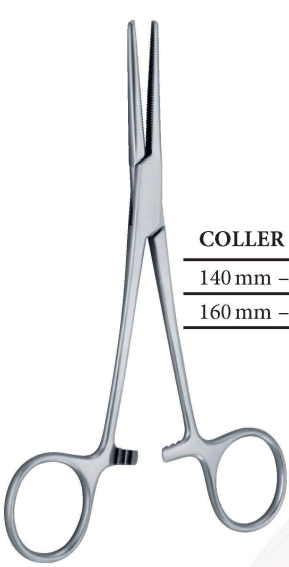

COLLER		
140 mm – 5½"	HF 04-100-01	HF 04-101-01
160 mm – 6¼"	HF 04-100-02	HF 04-101-02

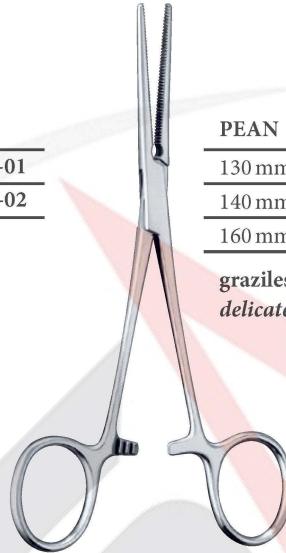
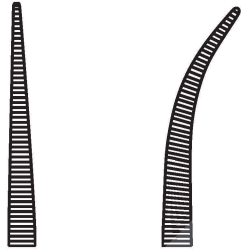

PEAN		
130 mm – 5"	HF 04-105-01	HF 04-106-01
140 mm – 5½"	HF 04-105-02	HF 04-106-02
160 mm – 6¼"	HF 04-105-03	HF 04-106-03

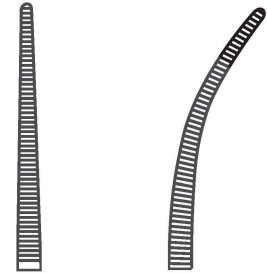

graziles Modell
delicate pattern



DUNHILL	
125 mm – 5"	HF 04-110-01



CAIRNS		
150 mm – 6"	HF 04-115-01	HF 04-116-01

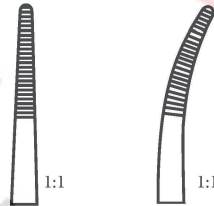

KOCHER		
130 mm – 5"	HF 04-120-01	HF 04-121-01
140 mm – 5½"	HF 04-120-02	HF 04-121-02
160 mm – 6¼"	HF 04-120-03	HF 04-121-03



graziles Modell 1x2 1x2
delicate pattern

ARTERIENKLEMMEN – HAEMOSTATIC FORCEPS

Arterienklemmen
 Haemostatic forceps
 Pincés hémostatiques
 Pinzas hemostáticas
 Pinze emostatiche



PEAN-FINO

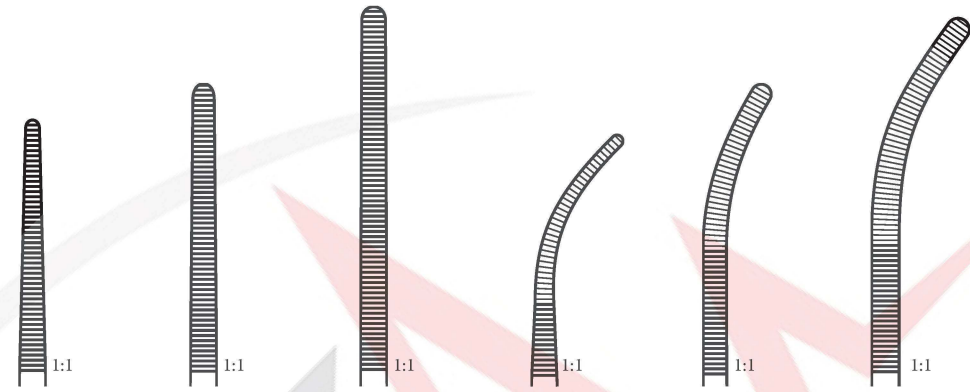

145 mm – 5 3/4"	165 mm – 6 1/2"	185 mm – 7 1/4"	140 mm – 5 1/2"	160 mm – 6 1/4"	180 mm – 7"
HF 04-125-01	HF 04-125-02	HF 04-125-03	HF 04-125-04	HF 04-125-05	HF 04-125-06



KOCHER-FINO

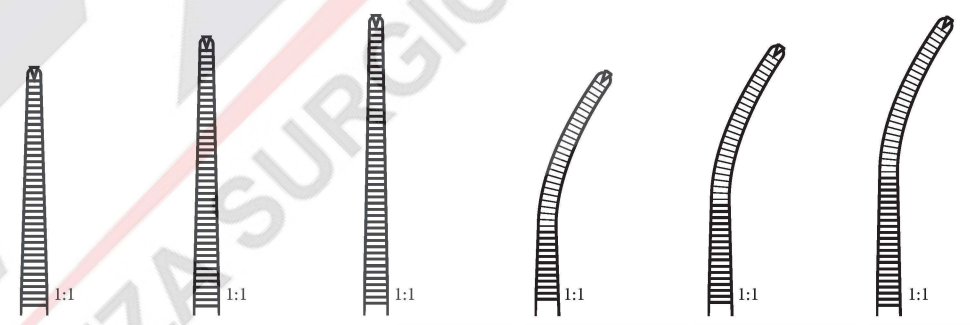





145 mm – 5 3/4"	165 mm – 6 1/2"	185 mm – 7 1/4"	145 mm – 5 3/4"	160 mm – 6 1/4"	180 mm – 7"
HF 04-130-01	HF 04-130-02	HF 04-130-03	HF 04-130-04	HF 04-130-05	HF 04-130-06
1x2	1x2	1x2	1x2	1x2	1x2





ARTERIENKLEMMEN – HAEMOSTATIC FORCEPS

Arterienklemmen
 Haemostatic forceps
 Pinces hémostatiques
 Pinzas hemostáticas
 Pinze emostatiche



ROCHESTER - PEAN

				
140 mm – 5½"	160 mm – 6¼"	185 mm – 7¼"	200 mm – 8"	225 mm – 9"
HF 04-135-01	HF 04-135-02	HF 04-135-03	HF 04-135-04	HF 04-135-05

			
240 mm – 9½"	260 mm – 10¼"	300 mm – 12"	350 mm – 14"
HF 04-135-06	HF 04-135-07	HF 04-135-08	HF 04-135-09

ARTERIENKLEMMEN - HAEMOSTATIC FORCEPS

Arterienklemmen
Haemostatic forceps
Pinces hémostatiques
Pinzas hemostáticas
Pinze emostatiche

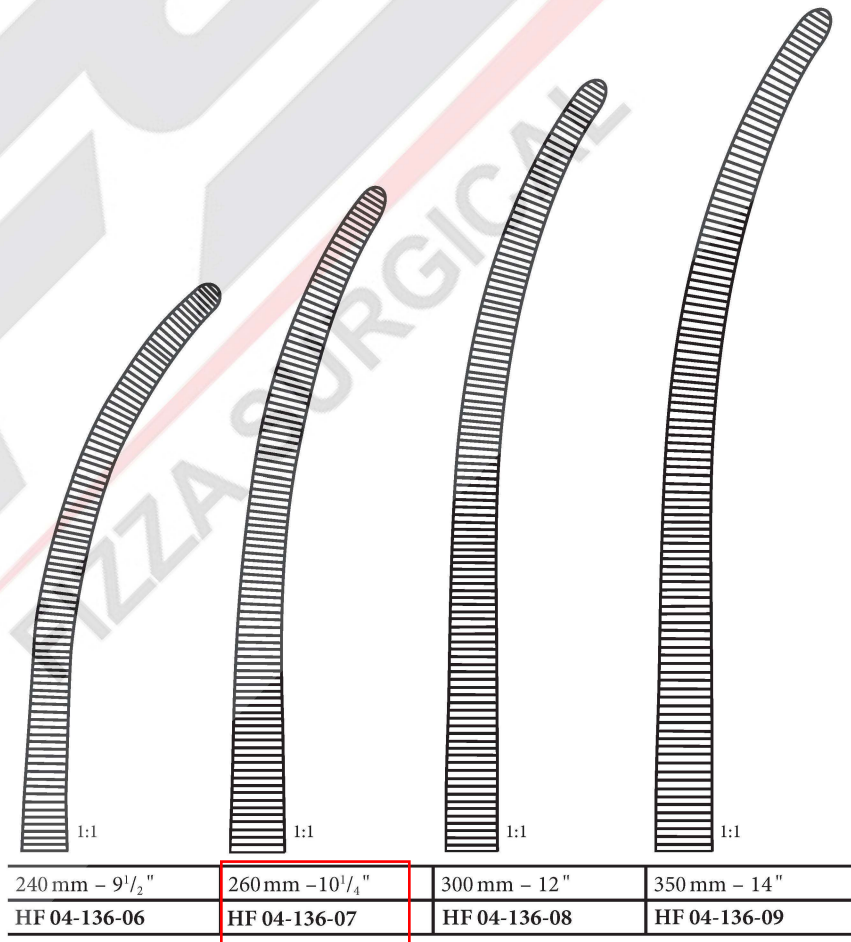
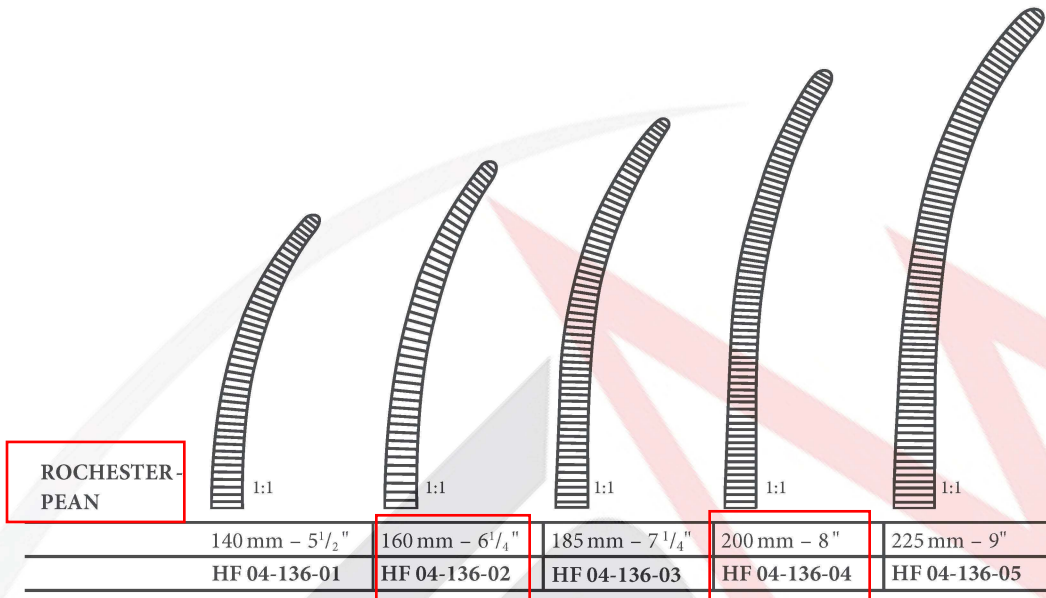

ARTERIENKLEMMEN - HAEMOSTATIC FORCEPS

Arterienklemmen
 Haemostatic forceps
 Pinces hémostatiques
 Pinzas hemostáticas
 Pinze emostatiche



**OCHSNER -
 KOCHER**

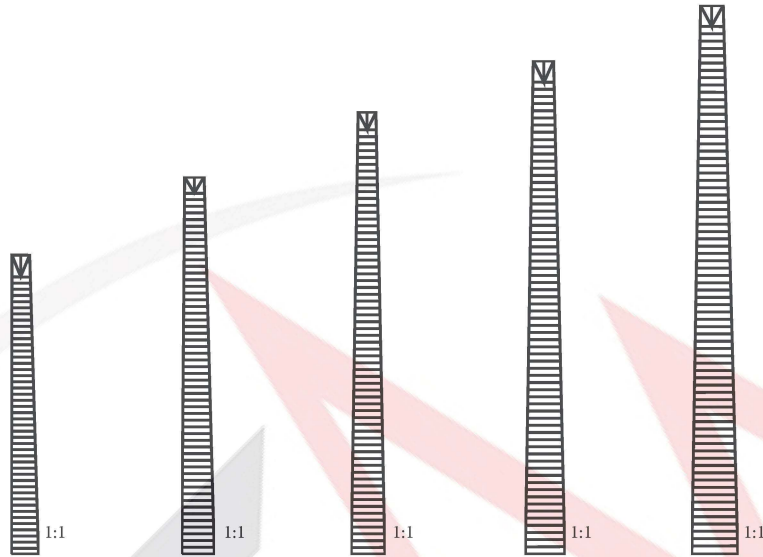



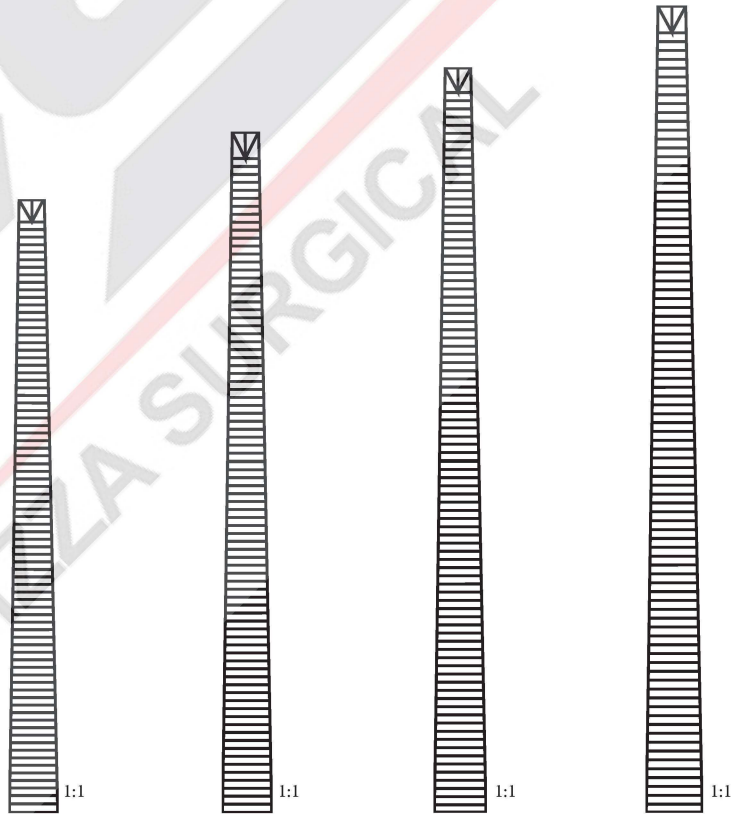





140 mm - 5 1/2"	160 mm - 6 1/4"	185 mm - 7 1/4"	200 mm - 8"	225 mm - 9"
HF 04-140-01	HF 04-140-02	HF 04-140-03	HF 04-140-04	HF 04-140-05
1x2	1x2	1x2	1x2	1x2

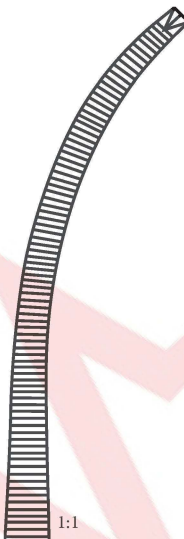

240 mm - 9 1/2"	260 mm - 10 1/4"	300 mm - 12"	350 mm - 14"
HF 04-140-06	HF 04-140-07	HF 04-140-08	HF 04-140-09
1x2	1x2	1x2	1x2

ARTERIENKLEMMEN – HAEMOSTATIC FORCEPS

Arterienklemmen
Haemostatic forceps
Pinces hémostatiques
Pinzas hemostáticas
Pinze emostatiche

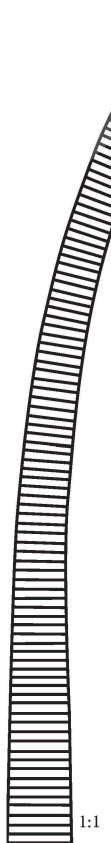
OCHSNER - KOCHER				
 1:1	 1:1	 1:1	 1:1	 1:1
140 mm – 5½"	160 mm – 6¼"	185 mm – 7¼"	200 mm – 8"	225 mm – 9"
HF 04-141-01	HF 04-141-02	HF 04-141-03	HF 04-141-04	HF 04-141-05
1x2	1x2	1x2	1x2	1x2
 1:1	 1:1	 1:1	 1:1	
240 mm – 9½"	260 mm – 10¼"	300 mm – 12"	350 mm – 14"	
HF 04-141-06	HF 04-141-07	HF 04-141-08	HF 04-141-09	
1x2	1x2	1x2	1x2	

ARTERIENKLEMMEN – HAEMOSTATIC FORCEPS

Arterienklemmen
 Haemostatic forceps
 Pinces hémostatiques
 Pinzas hemostáticas
 Pinze emostatiche



HEISS

200 mm - 8"



HF 04-215-01



HF 04-216-01

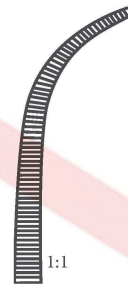







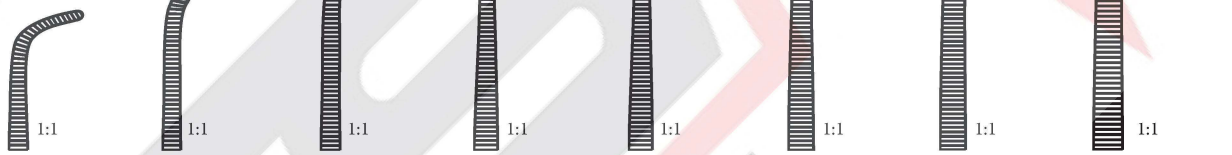

HF 04-217-01



FIZZA SURGICAL

Präparier- und Ligaturklemmen
Dissecting and ligature forceps
Pinces à disséquer et à sutures
Pinzas para preparación y suturas
Pinze per preparazioni e suture

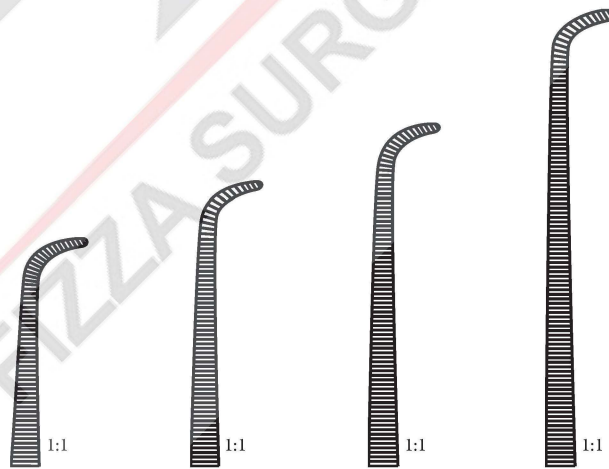

GEMINI	 1:1	 1:1	 1:1	 1:1	 1:1	 1:1	 1:1	 1:1
	130 mm – 5 "	160 mm – 6 ¹ / ₄ "	180 mm – 7 "	200 mm – 8 "	230 mm – 9 "	250 mm – 9 ³ / ₄ "	280 mm – 11 "	350 mm – 14 "
	HF 04-295-01	HF 04-295-01	HF 04-295-01	HF 04-295-01	HF 04-295-01	HF 04-295-01	HF 04-295-01	HF 04-295-01

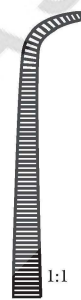

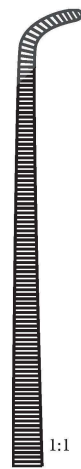
MINI - GEMINI	 1:1	 1:1	 1:1	 1:1
	180 mm – 7 "	220 mm – 8 ³ / ₄ "	250 mm – 9 ³ / ₄ "	280 mm – 11 "
	HF 04-300-01	HF 04-300-02	HF 04-300-03	HF 04-300-04

Präparier- und Ligaturklemmen
Dissecting and ligature forceps
Pincès à disséquer et à sutures
Pinzas para preparación y suturas
Pinze per preparazioni e suture



ZENKER

295 mm – 11½"

HF 04-305-01

HF 04-306-01

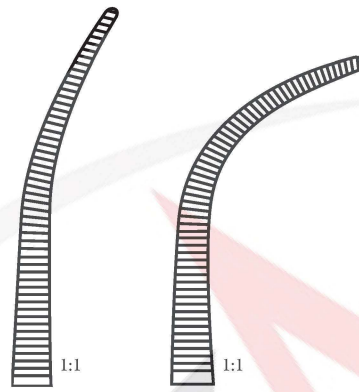

ROBERTS

220 mm – 8¾"

HF 04-310-01

HF 04-311-01

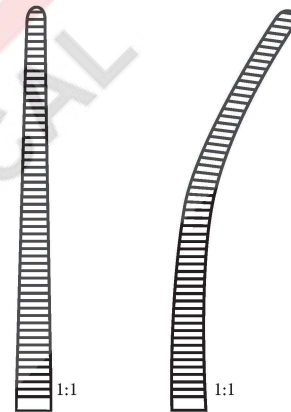

Präparier- und Ligaturklemmen
Dissecting and ligature forceps
Pinces à disséquer et à sutures
Pinzas para preparación y suturas
Pinze per preparazioni e suture



MIXTER

155 mm – 6 ""	HF 04-315-01
190 mm – 7 1/2 ""	HF 04-315-02

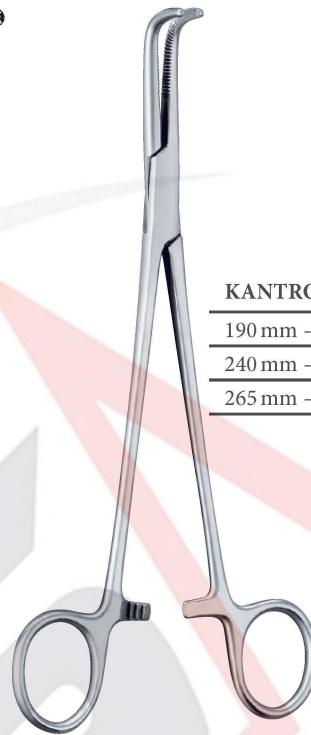

KANTROWITZ

190 mm – 7 1/2 ""	HF 04-320-01
240 mm – 9 1/2 ""	HF 04-320-02
265 mm – 10 1/2 ""	HF 04-320-03

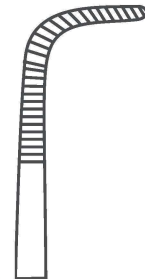

MIXTER

220 mm – 8 3/4 ""	HF 04-325-01
255 mm – 10 ""	HF 04-325-02
350 mm – 14 ""	HF 04-325-03

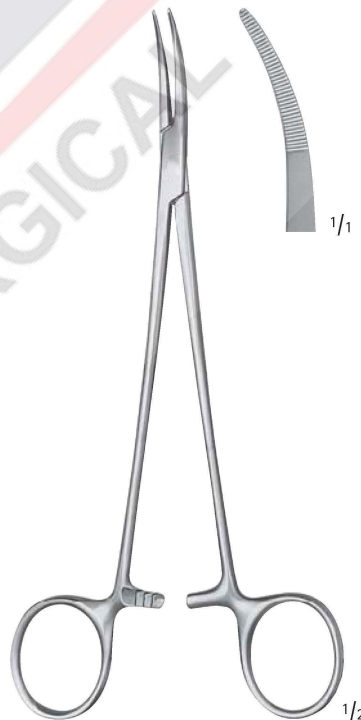

NISSEN

185 mm, 7 1/4 ""	HF 04-326-01
------------------	--------------



1:2

1/2

Präparier- und Ligaturklemmen
Dissecting and ligature forceps
Pincès à disséquer et à sutures
Pinzas para preparación y suturas
Pinze per preparazioni e suture



MIXTER
 230 mm – 9" | HF 04-330-01

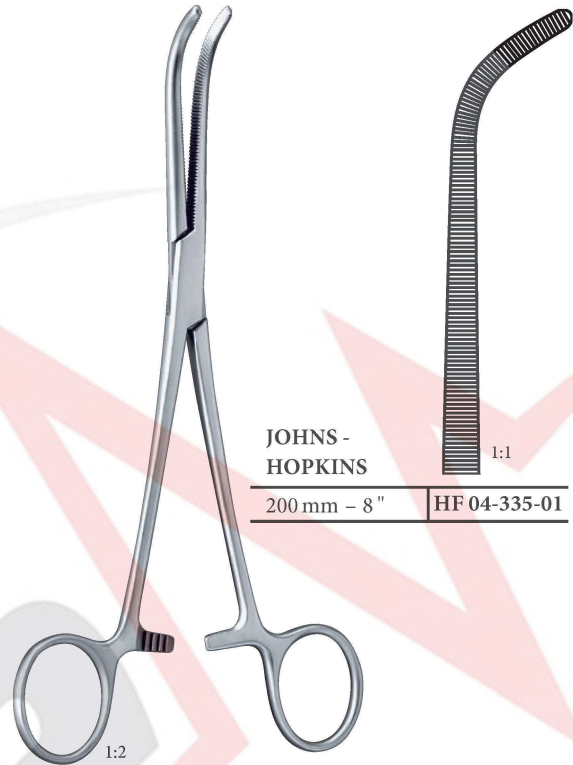

JOHNS - HOPKINS
 200 mm – 8" | HF 04-335-01

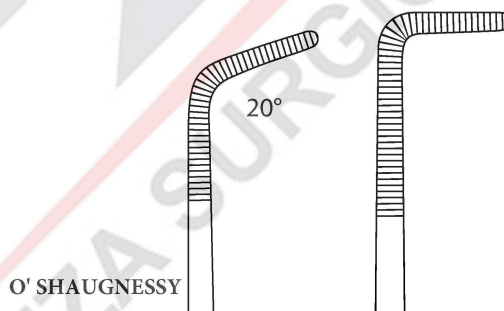

O' SHAUGHNESSY

140 mm – 5 1/2"	HF 04-340-01	HF 04-341-01
160 mm – 6 3/4"	HF 04-340-02	HF 04-341-02
180 mm – 7"	HF 04-340-03	HF 04-341-03
200 mm – 8"	HF 04-340-04	HF 04-341-04
220 mm – 8 3/4"	HF 04-340-05	HF 04-341-05
240 mm – 9"	HF 04-340-06	HF 04-341-06
280 mm – 11"	HF 04-340-07	HF 04-341-07
300 mm – 11 3/4"	HF 04-340-08	HF 04-341-08

Präparier- und Ligaturklemmen
Dissecting and ligature forceps
Pinces à disséquer et à sutures
Pinzas para preparación y suturas
Pinze per preparazioni e suture



WICKSTROM

210 mm – 8 ¹ / ₄ "	HF 04-345-01
240 mm – 9 ¹ / ₂ "	HF 04-345-02



CRAFOORD

180 mm – 7"	HF 04-350-01
240 mm – 9 ¹ / ₂ "	HF 04-350-02



SAROT

240 mm – 9 ¹ / ₂ "	HF 04-355-01	HF 04-356-01
350 mm – 14"	HF 04-355-02	HF 04-356-02

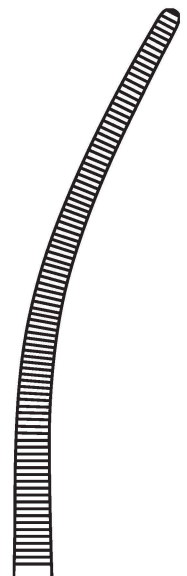

Klemmzangen – Peritoneumklemmen
Clamp forceps – Peritoneal forceps
Pinces-clamps – Pinces pour le péritoine
Pinzas-clamps – Pinzas para peritoneo
Pinze per peritoneo



**Baby-
Mikulicz**

140 mm – 4 1/2 "	HF 04-440-01
------------------	--------------



1:1

1x2



MIKULICZ

<u>200 mm – 8 "</u>	<u>HF 04-445-01</u>
---------------------	---------------------

<u>185 mm – 7 1/4 "</u>	<u>HF 04-445-02</u>
-------------------------	---------------------



1:1

1x2

Bronchus- und Gefäßklemmen
Bronches- and vascular clamps
Pinces vasculaires et pour bronches
Pinzas vasculares y bronquiales
Pinze vascolari e per bronchi



BABY - SATINSKY

150 mm - 6"

HF 04-505-01

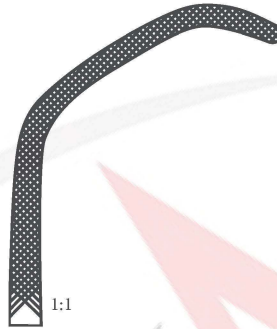

SATINSKY

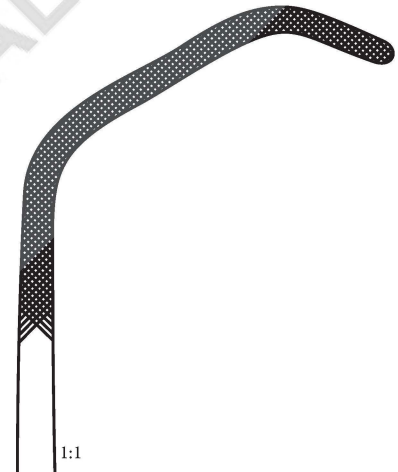

	Fig. 1	Fig. 1	Fig. 2	Fig. 2
265 mm - 10 1/2"	HF 04-510-01	HF 04-510-02	HF 04-511-01	HF 04-511-02

S-förmig gebogen
S-curved

S-förmig gebogen
S-curved

Tuchklemmen
Towel forceps
Pinces à champs
Pinzas de campo
Pinze fissateli



BERNHARD

100 mm - 4 "	HF 04-515-01
120 mm - 4 3/4 "	HF 04-515-02
140 mm - 5 1/2 "	HF 04-515-03
165 mm - 6 1/2 "	HF 04-515-04
180 mm - 7 "	HF 04-515-05



BACKHAUS

90 mm - 3 1/2 "	HF 04-520-01
110 mm - 4 1/4 "	HF 04-520-02
130 mm - 5 "	HF 04-520-03
150 mm - 6 "	HF 04-520-04
160 mm - 6 1/4 "	HF 04-520-05



ROEDER

130 mm - 5 "	HF 04-525-01
150 mm - 6 "	HF 04-525-02



110 mm - 4 " HF 04-530-01

mit Schlauchhalter
with clip for tube