



9th edition
Revised in 2019

www.plastilab-lb.com





LIFE... IN PLASTIC

JRZ PLASTILAB



TABLE OF CONTENT

01 | COMPANY PROFILE

Introduction.....	08
Mission.....	09
Vision.....	09
Values.....	09
History.....	10
Certifications and Global Presence.....	11
Quality Policy.....	12
Social Responsibility.....	13
Research and Development.....	14

02 | PETRI DISHES

Petri Dishes 60 mm.....	16
Petri Dishes 90 mm One Compartment.....	16
Petri Dishes 90 mm Two Compartments.....	17
Petri Dishes 90 mm Three Compartments.....	17
Petri Dishes 140 mm.....	18
Petri Dishes 90 mm Easy Tear Bags.....	18

03 | SPECIMEN CONTAINERS

Specimen Containers 30 mL PS.....	20
Specimen Containers 60 mL PS.....	22
Specimen Containers 60 mL PP.....	24
Specimen Containers 60 mL Blue.....	26
Specimen Containers 120 mL PP.....	26
Specimen Containers 150 mL PP.....	27
Stool Containers.....	29
24 Hour Urine Containers.....	30
Spoon for Specimen Containers.....	31

04 | SAFETY BOXES

Safety Boxes 1 L.....	34
Safety Boxes 1.8 L.....	34
Safety Boxes 3 L.....	35
Safety Boxes 5 L.....	35
Safety Boxes 10 L.....	36
Hangers.....	36

05 | TUBES

Vacurate® Vacuum Blood Collection Tubes.....	38
Vacurate® Vacuum Urine Collection Tubes.....	48
Tourniquets.....	48
Vacurate® Vacuum Tube Holders.....	49
Vacuum Tube Needles.....	49
Blood Collection Tubes 2.5 ML & 5 ML Push Cap.....	50
Blood Collection Tubes 10 ML.....	53
Blood Collection Tubes 2.5 ML & 5 ML Screw Cap.....	53
Conical Tubes 15 ML.....	55

Conical Tubes 50 ML.....	56
Test Tubes 5 ML.....	58
Caps for Test Tubes.....	58

06 | TIPS AND LOOPS

Micropipette Tips 5-200 µL.....	60
Micropipette Tips 100-1000 µL.....	60
Micropipette Tips in Rack 5-200 µL.....	61
Micropipette Tips in Rack 100-1000 µL.....	61
Inoculating Loops 1 µL.....	62
Inoculating Loops 10 µL.....	62

07 | VARIOUS MEDICAL SUPPLIES

Medicine Cups.....	64
Kidney Dishes.....	64
Burette.....	65
Blood Exchange Set.....	65
Umbilical Cord Clamps.....	66
Paper Rolls.....	66
Tongue Depressors.....	67
Cervix Spatulas.....	67
Male Urinals.....	68
Female Urinals.....	68

08 | CANNULAS

IV Cannulas 16 FG.....	70
IV Cannulas 18 FG.....	70
IV Cannulas 20 FG.....	71
IV Cannulas 22 FG.....	71
IV Cannulas 24 FG.....	72

09 | CATHETERS

Suction Catheters.....	74
2 Way Foley Balloon Catheters.....	75
3 Way Foley Balloon Catheters.....	76
Nelaton Catheters.....	76





COMPANY PROFILE

Introduction	08
Mission	09
Vision	09
Values	09
History	10
Certifications and Global Presence	11
Quality Policy	12
Social Responsibility	13
Research and Development	14

01



01

COMPANY PROFILE



INTRODUCTION

Founded in 1999, Plasti Lab produces plastic laboratory and medical supplies. By having innovation and a people-centric approach as the pillars of the company, Plasti Lab has emerged as a worldwide leader in its scope with sales covering all continents.





MISSION

Plasti Lab is committed to exceed customer expectations by striving to provide outstanding customer service, product quality, production flexibility, high production output, and competitive prices.

VISION

Plasti Lab aims to achieve sustained development on a worldwide scope and seeks to enhance its success as a global key player in the manufacture of plastic laboratory and medical products.

VALUES

Plasti Lab is a family owned company which believes in the importance of strong traditional values and morals.

We apply our deeply-rooted values within the Plasti Lab family.

We have an open and transparent environment, and firmly apply the principles of honesty, integrity, respect, accountability, and support for one another.

We work with the spirit of providing our community with the means to lead healthier lives, in addition to placing our focus on people's needs.



HISTORY

1999

Foundation of the company Plasti Lab and integration in the local Lebanese market for the supply of plastic laboratory disposables

2001

- First regional export sales
- First participation as an exhibitor in an exhibition in the Middle East

2003

Development and implementation of an effective Quality Management System that is in compliance with the ISO 9001 standard

2005

- Increase in the disposable product range and introduction of plastic medical disposables to Plasti Lab's product range
- First participation as an exhibitor in an exhibition in Europe

2006

International export sales in over 30 countries worldwide

2008

- Expansion of the factory and development leading to fully automated product lines
- Production capacity exceeding 10 TEU's (Twenty equivalent unit) per day
- Increase in the product range to include over 300 SKU's (Stock keeping unit)
- First international recognition: Receipt of the Quality Summit Award in New York for excellence and business prestige

2009

- CE marking and conformity to the product range
- Establishment of a branch office in Russia, "Plasti Lab-Rus"

2011

Development and implementation of a Quality Management System that is in compliance with the ISO 13485 standard

2013

Sales in over 70 countries worldwide

2014

- Increase in the product range of disposable products
- Introduction of a new line of reusable plastic medical supplies

EVOLUTION OF OUR LOGO



CERTIFICATIONS AND GLOBAL PRESENCE



CERTIFICATIONS

Plasti Lab has had the honor of receiving several prestigious awards and certifications in recognition for its outstanding quality and service.

Our dedication to providing high quality products through our effective Quality Management System has allowed us to obtain several accreditations and certifications such as the WHO-GMP, ISO 13485:2012, ISO 9001:2008, FDA approval and the CE mark.



GLOBAL PRESENCE

As part of achieving our vision of having a strong worldwide presence are exhibitions, which give us the perfect opportunity to meet new and potential customers, interact with our existing clients and showcase our latest products and innovations.





QUALITY POLICY

Founded in 1999, Plasti Lab produces plastic laboratory and medical supplies.

By having innovation and a people-centric approach as the pillars of the company, Plasti Lab has emerged as a worldwide leader in its scope with sales covering all continents.

Our main priorities are customer satisfaction, product excellence, and continual improvement.

We achieve customer satisfaction by going the extra mile in order to cater to our clients' each and every needs. Our expert sales team is composed of multi-lingual, trained, and culturally diverse employees.

Our product excellence is achieved through continual research and development, process validation, and quality assurance.

We seek continual improvement through our devoted workforce, constant training, and research and development department.



SOCIAL RESPONSIBILITY

Plasti Lab is an environmentally conscious company with a high awareness towards preserving our planet for future generations.

As a company and as individuals, we take great pride in contributing to the communities we live and work in.

We also care about the environment and are proud in many ways of the employees who work to safeguard it.

Accordingly, we have taken several measures in order to save energy and reduce waste. We have switched the lighting system from incandescent light bulbs to LED lights and installed light sensors in low traffic areas in order to preserve energy.

Additionally, we recycle unused plastic and resell them in order to be used for other purposes.

We have also placed filters on our generators as an initiative to reduce pollution, and use solar panels for our hot water consumption.



RESEARCH AND DEVELOPMENT

Our dynamic in-house research and development department is constantly aiming to develop new products and finding ways to further improve the existing ones.

Our R&D team consists of engineers, lab personnel, healthcare professionals, and users, who work hand-in-hand in order to achieve the quality that Plasti Lab prides itself with.

We develop and create new processes to optimize our production methods, reduce waste and increase efficiency.

PETRI DISHES

Petri Dishes 60 mm	16
Petri Dishes 90 mm One Compartment	16
Petri Dishes 90 mm Two Compartments	17
Petri Dishes 90 mm Three Compartments	17
Petri Dishes 140 mm	18
Petri Dishes 90 mm Easy Tear Bags	18

02

60 mm

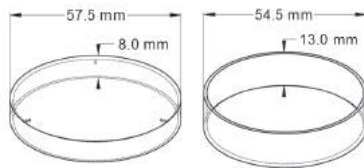
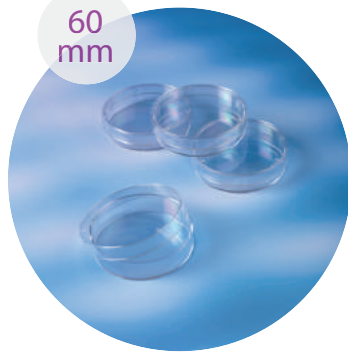

PETRI DISHES

PETRI DISH 60 MM

INTENDED USE

- Used to culture cells on solid media for microbiological studies

MATERIAL

- Manufactured using polystyrene

FEATURES

- Manufactured either aseptically or ETO sterilized under ISO 7 clean room conditions
- Crystal clear to ensure premium optical quality
- Optimal planarity
- Requires less media than others
- CE marked

Product code	Diameter (mm)	Sterility	Packing	Number of Vents	Inner Pack Quantity	Pieces per box
PD-600	60	Aseptic	Standard	3	10	1400
PD-601	60	Sterile	Standard	3	10	1400
PD-602	60	Aseptic	Standard	0	10	1400
PD-603	60	Sterile	Standard	0	10	1400
PD-604	60	Aseptic	Standard	6	10	1400
PD-605	60	Sterile	Standard	6	10	1400
PD-620	60	Aseptic	Standard	0	20	1400
PD-621	60	Sterile	Standard	0	20	1400

90 mm

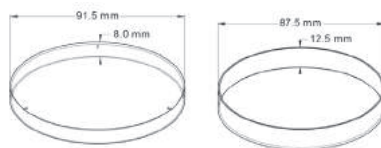
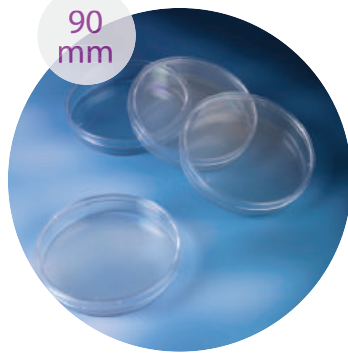

PETRI DISH 90 MM | One Compartment

INTENDED USE

- Used to culture cells on solid media for microbiological studies

MATERIAL

- Manufactured using polystyrene

FEATURES

- Manufactured either aseptically or ETO sterilized under ISO 7 clean room conditions
- Crystal clear to ensure premium optical quality
- Optimal planarity
- Requires less media than others
- Triple vented
- CE marked

Product code	Diameter (mm)	Height (mm)	Sterility	Material	Inner Pack Quantity	Pieces per box
PD-900	90	14.2	Aseptic	PS	20	500
PD-901	90	14.2	Sterile	PS	20	500
PD-950	90	15.8	Aseptic	PS	20	500
PD-951	90	15.8	Sterile	PS	20	500
PD-960	90	16.2	Aseptic	PS	20	500
PD-961	90	16.2	Sterile	PS	20	500

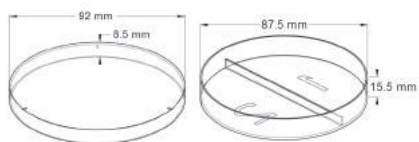
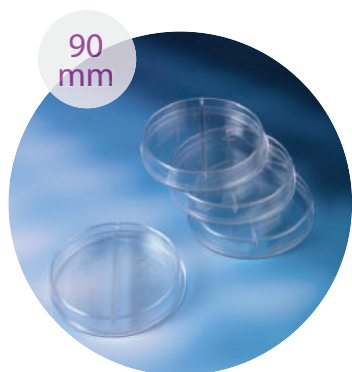

PETRI DISH 90 MM | Two Compartments

INTENDED USE

- Used to culture cells on solid media for microbiological studies

MATERIAL

- Manufactured using polystyrene

FEATURES

- Manufactured either aseptically or ETO sterilized under ISO 7 clean room conditions
- Crystal clear to ensure premium optical quality
- Optimal planarity
- Requires less media than others
- Triple vented
- CE marked

Product code	Diameter (mm)	Sterility	Material	Inner Pack Quantity	Pieces per box
PD-920	90	Aseptic	PS	20	500
PD-921	90	Sterile	PS	20	500

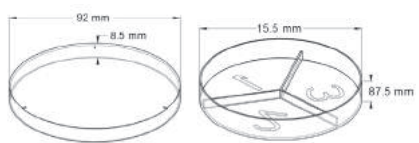
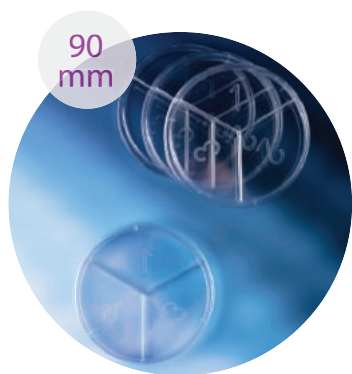

PETRI DISH 90 MM | Three Compartments

INTENDED USE

- Used to culture cells on solid media for microbiological studies

MATERIAL

- Manufactured using polystyrene

FEATURES

- Manufactured either aseptically or ETO sterilized under ISO 7 clean room conditions
- Crystal clear to ensure premium optical quality
- Optimal planarity
- Requires less media than others
- Triple vented
- CE marked

Product code	Diameter (mm)	Sterility	Material	Inner Pack Quantity	Pieces per box
PD-930	90	Aseptic	PS	20	500
PD-931	90	Sterile	PS	20	500

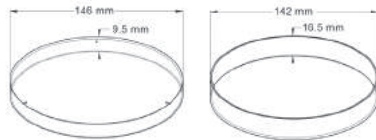
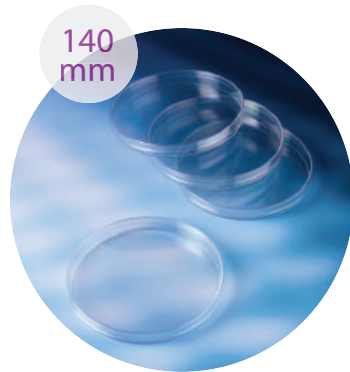

PETRI DISH 140 MM

INTENDED USE

- Used to culture cells on solid media for microbiological studies

MATERIAL

- Manufactured using polystyrene

FEATURES

- Manufactured either aseptically or ETO sterilized under ISO 7 clean room conditions
- Crystal clear to ensure premium optical quality
- Optimal planarity
- Requires less media than others
- CE marked

Product code	Diameter (mm)	Sterility	Material	Inner Pack Quantity	Pieces per box
PD-140	140	Aseptic	PS	5	240
PD-141	140	Sterile	PS	5	240

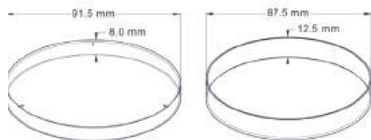
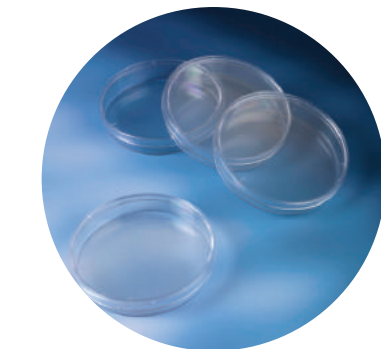

PETRI DISH 90 MM | Easy Tear Bags

INTENDED USE

- Used to culture cells on solid media for microbiological studies

MATERIAL

- Manufactured using polystyrene

FEATURES

- Manufactured either aseptically or ETO sterilized under ISO 7 clean room conditions
- Crystal clear to ensure premium optical quality
- Optimal planarity
- Requires less media than others
- Triple vented
- CE marked
- Easy tear perforated bags

Product code	Diameter (mm)	Height (mm)	Sterility	Packing	Inner Pack Quantity	Pieces per box
PD-902	90	14.2	Sterile	Double Bag	10	500
PD-903	90	14.2	Sterile	Standard	10	500
PD-991	90	14.2	Sterile	Perforated	20	500
PD-993	90	15.8	Sterile	Perforated	20	500
PD-995	90	16.2	Sterile	Perforated	20	500

SPECIMEN CONTAINERS

Specimen Containers 30 mL PS	20
Specimen Containers 60 mL PS	22
Specimen Containers 60 mL PP	24
Specimen Containers 60 mL Blue	26
Specimen Containers 120 mL PP	26
Specimen Containers 150 mL PP	27
Stool Containers	29
24 Hour Urine Containers	30
Spoon for Specimen Containers	31

03

SPECIMEN CONTAINERS



30 mL

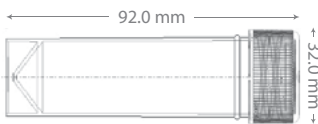

SPECIMEN CONTAINERS 30 ML | PS

INTENDED USE

- Used to collect, transport, and store a wide variety of samples

MATERIAL

- Container manufactured using Polystyrene
- Cap manufactured using high density Polyethylene

FEATURES

- Chemically inert and resistant to common laboratory reagents at room temperature
- Leak-proof design
- CE marked

Product code	Assembled	Volume (mL)	Container Material	Cap Color	Cap Material	Sterility	Label	Spoon	Pieces per box
SCS-300	Yes	30	PS	Red	HDPE	Aseptic	No	No	400
SCS-310	Yes	30	PS	White	HDPE	Aseptic	No	No	400
SCS-301	Yes	30	PS	Red	HDPE	Sterile	No	No	400
SCS-311	Yes	30	PS	White	HDPE	Sterile	No	No	400



30 mL

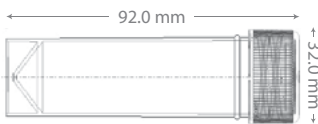

SPECIMEN CONTAINERS 30 ML | PS With Label

INTENDED USE

- Used to collect, transport, and store a wide variety of samples

MATERIAL

- Container manufactured using Polystyrene
- Cap manufactured using high density Polyethylene

FEATURES

- Chemically inert and resistant to common laboratory reagents at room temperature
- Leak-proof design
- CE marked

Product code	Assembled	Volume (mL)	Container Material	Cap Color	Cap Material	Sterility	Label	Spoon	Pieces per box
SCS-340	Yes	30	PS	Red	HDPE	Aseptic	Yes	No	400
SCS-350	Yes	30	PS	White	HDPE	Aseptic	Yes	No	400
SCS-341	Yes	30	PS	Red	HDPE	Sterile	Yes	No	400
SCS-351	Yes	30	PS	White	HDPE	Sterile	Yes	No	400



SPECIMEN CONTAINERS 30 ML | PS With Spoon

INTENDED USE

- Used to collect, transport, and store a wide variety of samples

MATERIAL

- Container manufactured using Polystyrene
- Cap manufactured using high density Polyethylene

FEATURES

- Chemically inert and resistant to common laboratory reagents at room temperature
- Leak-proof design
- CE marked

Product code	Assembled	Volume (mL)	Container Material	Cap Color	Cap Material	Sterility	Label	Spoon	Pieces per box
SCS-320	Yes	30	PS	Red	HDPE	Aseptic	No	Yes	400
SCS-330	Yes	30	PS	White	HDPE	Aseptic	No	Yes	400
SCS-321	Yes	30	PS	Red	HDPE	Sterile	No	Yes	400
SCS-331	Yes	30	PS	White	HDPE	Sterile	No	Yes	400



SPECIMEN CONTAINERS 30 ML | PS With Label & Spoon

INTENDED USE

- Used to collect, transport, and store a wide variety of samples

MATERIAL

- Container manufactured using Polystyrene
- Cap manufactured using high density Polyethylene

FEATURES

- Chemically inert and resistant to common laboratory reagents at room temperature
- Leak-proof design
- CE marked

Product code	Assembled	Volume (mL)	Container Material	Cap Color	Cap Material	Sterility	Label	Spoon	Pieces per box
SCS-360	Yes	30	PS	Red	HDPE	Aseptic	Yes	Yes	400
SCS-370	Yes	30	PS	White	HDPE	Aseptic	Yes	Yes	400
SCS-361	Yes	30	PS	Red	HDPE	Sterile	Yes	Yes	400
SCS-371	Yes	30	PS	White	HDPE	Sterile	Yes	Yes	400



SPECIMEN CONTAINERS 60 ML | PS

INTENDED USE

- Used to collect, transport, and store a wide variety of samples

MATERIAL

- Container manufactured using Polystyrene
- Cap manufactured using high density Polyethylene

FEATURES

- Chemically inert and resistant to common laboratory reagents at room temperature
- Leak-proof design
- CE marked

Product code	Assembled	Volume (mL)	Container Material	Cap Color	Cap Material	Sterility	Label	Spoon	Pieces per box
SCS-600	Yes	60	PS	Red	HDPE	Aseptic	No	No	500
SCS-610	Yes	60	PS	White	HDPE	Aseptic	No	No	500
SCS-601	Yes	60	PS	Red	HDPE	Sterile	No	No	500
SCS-611	Yes	60	PS	White	HDPE	Sterile	No	No	500

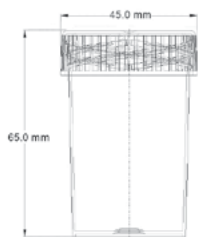

SPECIMEN CONTAINERS 60 ML | PS With Label

INTENDED USE

- Used to collect, transport, and store a wide variety of samples

MATERIAL

- Container manufactured using Polystyrene
- Cap manufactured using high density Polyethylene

FEATURES

- Chemically inert and resistant to common laboratory reagents at room temperature
- Leak-proof design
- CE marked

Product code	Assembled	Volume (mL)	Container Material	Cap Color	Cap Material	Sterility	Label	Spoon	Pieces per box
SCS-640	Yes	60	PS	Red	HDPE	Aseptic	Yes	No	500
SCS-650	Yes	60	PS	White	HDPE	Aseptic	Yes	No	500
SCS-641	Yes	60	PS	Red	HDPE	Sterile	Yes	No	500
SCS-651	Yes	60	PS	White	HDPE	Sterile	Yes	No	500

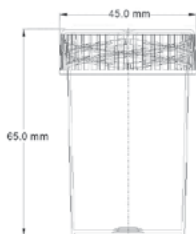

SPECIMEN CONTAINERS 60 ML | PS With Spoon

INTENDED USE

- Used to collect, transport, and store a wide variety of samples

MATERIAL

- Container manufactured using Polystyrene
- Cap manufactured using high density Polyethylene

FEATURES

- Chemically inert and resistant to common laboratory reagents at room temperature
- Leak-proof design
- CE marked

Product code	Assembled	Volume (mL)	Container Material	Cap Color	Cap Material	Sterility	Label	Spoon	Pieces per box
SCS-620	Yes	60	PS	Red	HDPE	Aseptic	No	Yes	500
SCS-630	Yes	60	PS	White	HDPE	Aseptic	No	Yes	500
SCS-621	Yes	60	PS	Red	HDPE	Sterile	No	Yes	500
SCS-631	Yes	60	PS	White	HDPE	Sterile	No	Yes	500

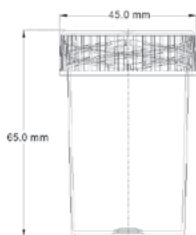

SPECIMEN CONTAINERS 60 ML | PS With Label & Spoon

INTENDED USE

- Used to collect, transport, and store a wide variety of samples

MATERIAL

- Container manufactured using Polystyrene
- Cap manufactured using high density Polyethylene

FEATURES

- Chemically inert and resistant to common laboratory reagents at room temperature
- Leak-proof design
- CE marked

Product code	Assembled	Volume (mL)	Container Material	Cap Color	Cap Material	Sterility	Label	Spoon	Pieces per box
SCS-660	Yes	60	PS	Red	HDPE	Aseptic	Yes	Yes	500
SCS-670	Yes	60	PS	White	HDPE	Aseptic	Yes	Yes	500
SCS-661	Yes	60	PS	Red	HDPE	Sterile	Yes	Yes	500
SCS-671	Yes	60	PS	White	HDPE	Sterile	Yes	Yes	500



60 mL

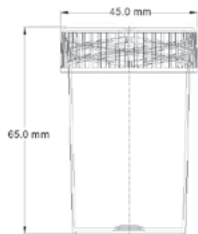

SPECIMEN CONTAINERS 60 ML | PP

INTENDED USE

- Used to collect, transport, and store a wide variety of samples

MATERIAL

- Container manufactured using Polypropylene
- Cap manufactured using high density Polyethylene

FEATURES

- Chemically inert and resistant to common laboratory reagents at room temperature
- Leak-proof design
- CE marked

Product code	Assembled	Volume (mL)	Container Material	Cap Color	Cap Material	Sterility	Label	Spoon	Pieces per box
SCP-600	Yes	60	PP	Red	HDPE	Aseptic	No	No	500
SCP-610	Yes	60	PP	White	HDPE	Aseptic	No	No	500
SCP-601	Yes	60	PP	Red	HDPE	Sterile	No	No	500
SCP-611	Yes	60	PP	White	HDPE	Sterile	No	No	500

SPECIMEN CONTAINERS 60 ML | PP With Label

INTENDED USE

- Used to collect, transport, and store a wide variety of samples

MATERIAL

- Container manufactured using Polypropylene
- Cap manufactured using high density Polyethylene

FEATURES

- Chemically inert and resistant to common laboratory reagents at room temperature
- Leak-proof design
- CE marked



60 mL

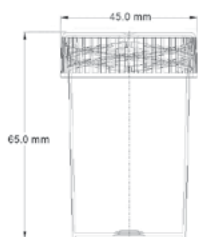

Product code	Assembled	Volume (mL)	Container Material	Cap Color	Cap Material	Sterility	Label	Spoon	Pieces per box
SCP-640	Yes	60	PP	Red	HDPE	Aseptic	Yes	No	500
SCP-650	Yes	60	PP	White	HDPE	Aseptic	Yes	No	500
SCP-641	Yes	60	PP	Red	HDPE	Sterile	Yes	No	500
SCP-651	Yes	60	PP	White	HDPE	Sterile	Yes	No	500

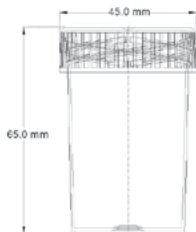

SPECIMEN CONTAINERS 60 ML | PP With Spoon

INTENDED USE

- Used to collect, transport, and store a wide variety of samples

MATERIAL

- Container manufactured using Polypropylene
- Cap manufactured using high density Polyethylene

FEATURES

- Chemically inert and resistant to common laboratory reagents at room temperature
- Leak-proof design
- CE marked

Product code	Assembled	Volume (mL)	Container Material	Cap Color	Cap Material	Sterility	Label	Spoon	Pieces per box
SCP-620	Yes	60	PP	Red	HDPE	Aseptic	No	Yes	500
SCP-630	Yes	60	PP	White	HDPE	Aseptic	No	Yes	500
SCP-621	Yes	60	PP	Red	HDPE	Sterile	No	Yes	500
SCP-631	Yes	60	PP	White	HDPE	Sterile	No	Yes	500

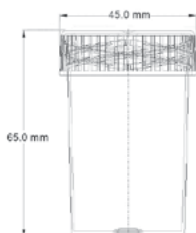

SPECIMEN CONTAINERS 60 ML | PP With Label & Spoon

INTENDED USE

- Used to collect, transport, and store a wide variety of samples

MATERIAL

- Container manufactured using Polypropylene
- Cap manufactured using high density Polyethylene

FEATURES

- Chemically inert and resistant to common laboratory reagents at room temperature
- Leak-proof design
- CE marked

Product code	Assembled	Volume (mL)	Container Material	Cap Color	Cap Material	Sterility	Label	Spoon	Pieces per box
SCP-660	Yes	60	PP	Red	HDPE	Aseptic	Yes	Yes	500
SCP-670	Yes	60	PP	White	HDPE	Aseptic	Yes	Yes	500
SCP-661	Yes	60	PP	Red	HDPE	Sterile	Yes	Yes	500
SCP-671	Yes	60	PP	White	HDPE	Sterile	Yes	Yes	500

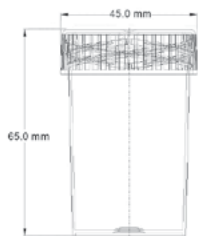
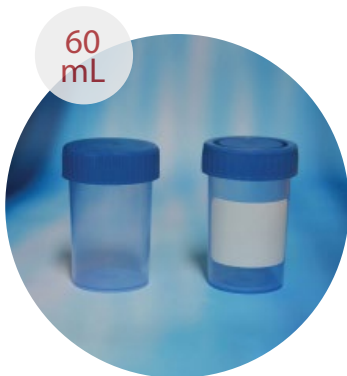

SPECIMEN CONTAINERS 60 ML | Blue

INTENDED USE

- Used to collect, transport, and store a wide variety of samples

MATERIAL

- Container manufactured using Polypropylene
- Cap manufactured using high density Polyethylene

FEATURES

- Chemically inert and resistant to common laboratory reagents at room temperature
- Leak-proof design
- CE marked

Product code	Assembled	Volume (mL)	Container Material	Cap Color	Cap Material	Sterility	Label	Spoon	Pieces per box
SCP-680	Yes	60	PP	Blue	HDPE	Aseptic	Yes	No	500
SCP-681	Yes	60	PP	Blue	HDPE	Sterile	Yes	No	500

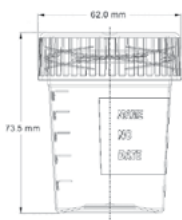

SPECIMEN CONTAINERS 120 ML | PP

INTENDED USE

- Used to collect, transport, and store a wide variety of samples

MATERIAL

- Container manufactured using Polypropylene
- Cap manufactured using high density Polyethylene

FEATURES

- Chemically inert and resistant to common laboratory reagents at room temperature
- Leak-proof design
- Molded-in graduation up to 100 mL
- Maximum capacity is 120 mL
- Frosted area for easy writing
- CE marked

Product code	Assembled	Volume (mL)	Container Material	Cap Color	Cap Material	Sterility	Label	Spoon	Pieces per box
SCP-100	No	120	PP	Red	HDPE	Aseptic	No	No	500
SCP-110	No	120	PP	White	HDPE	Aseptic	No	No	500
SCP-101	Yes	120	PP	Red	HDPE	Sterile	No	No	250
SCP-111	Yes	120	PP	White	HDPE	Sterile	No	No	250
SCP-141	Yes	120	PP	Red	HDPE	Sterile	Yes	No	250



120 mL

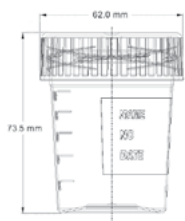

SPECIMEN CONTAINERS 120 ML | PP With Spoon

INTENDED USE

- Used to collect, transport, and store a wide variety of samples

MATERIAL

- Container manufactured using Polypropylene
- Cap manufactured using high density Polyethylene

FEATURES

- Chemically inert and resistant to common laboratory reagents at room temperature
- Leak-proof design
- Molded-in graduation up to 100 mL
- Maximum capacity is 120 mL
- Frosted area for easy writing
- CE marked

Product code	Assembled	Volume (mL)	Container Material	Cap Color	Cap Material	Sterility	Label	Spoon	Pieces per box
SCP-120	No	120	PP	Red	HDPE	Aseptic	No	Yes	500
SCP-130	No	120	PP	White	HDPE	Aseptic	No	Yes	500
SCP-121	Yes	120	PP	Red	HDPE	Sterile	No	Yes	250
SCP-131	Yes	120	PP	White	HDPE	Sterile	No	Yes	250



150 mL

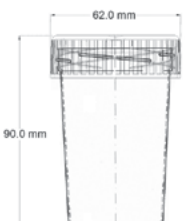

SPECIMEN CONTAINERS 150 ML | PP

INTENDED USE

- Used to collect, transport, and store a wide variety of samples

MATERIAL

- Container and cap manufactured using Polypropylene

FEATURES

- Chemically inert and resistant to common laboratory reagents at room temperature
- Leak-proof design
- Frosted area for easy writing
- CE marked

Product code	Assembled	Volume (mL)	Container Material	Cap Color	Cap Material	Sterility	Label	Spoon	Pieces per box
SCP-500	No	150	PP	Red	PP	Aseptic	No	No	500
SCP-510	No	150	PP	White	PP	Aseptic	No	No	500
SCP-501	Yes	150	PP	Red	PP	Sterile	No	No	250
SCP-511	Yes	150	PP	White	PP	Sterile	No	No	250

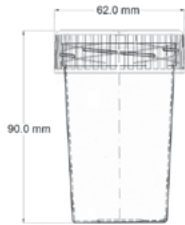

SPECIMEN CONTAINERS 150 ML | PP With Spoon

INTENDED USE

- Used to collect, transport, and store a wide variety of samples

MATERIAL

- Container and cap manufactured using Polypropylene

FEATURES

- Chemically inert and resistant to common laboratory reagents at room temperature
- Leak-proof design
- Frosted area for easy writing
- CE marked

Product code	Assembled	Volume (mL)	Container Material	Cap Color	Cap Material	Sterility	Label	Spoon	Pieces per box
SCP-520	No	150	PP	Red	PP	Aseptic	No	Yes	500
SCP-530	No	150	PP	White	PP	Aseptic	No	Yes	500
SCP-521	Yes	150	PP	Red	PP	Sterile	No	Yes	250
SCP-531	Yes	150	PP	White	PP	Sterile	No	Yes	250
SCP-541	Yes	150	PP	Red	PP	Sterile	Yes	No	250



SPECIMEN CONTAINERS | Stool Containers

INTENDED USE

- Used to collect, transport, and store a wide variety of samples

FEATURES

- Chemically inert and resistant to common laboratory reagents at room temperature
- Leak-proof design
- CE marked

Product Code	Description	Assembled	Volume (mL)	Container Material	Cap Color	Cap Material	Sterility	Label	Spoon	Pieces per box
SCS-360	Clear	Yes	30	PS	Red	HDPE	Aseptic	Yes	Yes	400
SCS-361	Clear	Yes	30	PS	Red	HDPE	Sterile	Yes	Yes	400
SCS-370	Clear	Yes	30	PS	White	HDPE	Aseptic	Yes	Yes	400
SCS-371	Clear	Yes	30	PS	White	HDPE	Sterile	Yes	Yes	400
SCS-630	Clear	Yes	60	PS	White	HDPE	Aseptic	No	Yes	500
SCS-631	Clear	Yes	60	PS	White	HDPE	Sterile	No	Yes	500
SCS-670	Clear	Yes	60	PS	White	HDPE	Aseptic	Yes	Yes	500
SCS-671	Clear	Yes	60	PS	White	HDPE	Sterile	Yes	Yes	500
SCP-630	Clear	Yes	60	PP	White	HDPE	Aseptic	No	Yes	500
SCP-631	Clear	Yes	60	PP	White	HDPE	Sterile	No	Yes	500
SCP-670	Clear	Yes	60	PP	White	HDPE	Aseptic	Yes	Yes	500
SCP-671	Clear	Yes	60	PP	White	HDPE	Sterile	Yes	Yes	500
SSP-620	Opaque	Yes	60	PP	Red	HDPE	Aseptic	No	Yes	500
SSP-621	Opaque	Yes	60	PP	White	HDPE	Sterile	No	Yes	500
SSP-630	Opaque	Yes	60	PP	White	HDPE	Aseptic	No	Yes	500
SSP-631	Opaque	Yes	60	PP	White	HDPE	Sterile	No	Yes	500
SSP-660	Opaque	Yes	60	PP	Red	HDPE	Aseptic	Yes	Yes	500
SSP-661	Opaque	Yes	60	PP	Red	HDPE	Sterile	Yes	Yes	500
SSP-670	Opaque	Yes	60	PP	White	HDPE	Aseptic	Yes	Yes	500
SSP-671	Opaque	Yes	60	PP	White	HDPE	Sterile	Yes	Yes	500
SSP-120	Opaque	No	120	PP	Red	HDPE	Aseptic	No	Yes	500
SSP-121	Opaque	Yes	120	PP	Red	HDPE	Sterile	No	Yes	500
SSP-130	Opaque	No	120	PP	White	HDPE	Aseptic	No	Yes	500
SSP-131	Opaque	Yes	120	PP	White	HDPE	Sterile	No	Yes	250
SSP-530	Opaque	No	150	PP	White	HDPE	Aseptic	No	Yes	500
SSP-531	Opaque	Yes	150	PP	White	HDPE	Sterile	No	Yes	250



SPECIMEN CONTAINERS | 24 Hour Urine Container

INTENDED USE

- Used for the collection of urine over 24 hours

MATERIAL

- 3L: Container and cap manufactured using Polyethylene
- 2.5L: Container manufactured using Polyethylene
- Cap manufactured using Polyethylene

FEATURES

- Leak-proof design
- The 2.5 Liter contains a small cap opening suitable for Vacurate® holder insertion, and hence easy urine withdrawal without dripping
- CE marked
- SCP-325H with Vacuum Specimen Collection insertion

Product code	Assembled	Volume (mL)	Container Material	Cap Material	Sterility	Pieces per box
SCP-300	Yes	3000	PE	PE	Aseptic	24
SCP-325	Yes	2500	PE	PE	Aseptic	30
SCP-325H	Yes	2500	PE	PE	Aseptic	30



SPECIMEN CONTAINERS | Spoon For Specimen Containers

INTENDED USE

- Used to collect, transport, and store a wide variety of samples

FEATURES

- Chemically inert and resistant to common laboratory reagents at room temperature
- Leak-proof design
- CE marked

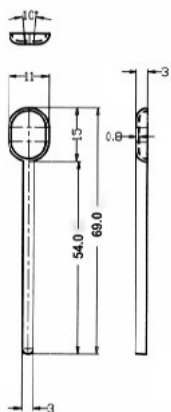

Product Code	Description	Color	Material	Inner Pack Quantity	Pieces per box
SS-600	Suitable for 60mL containers	Red	PS	200	20000
SS-610	Suitable for 60mL containers	White	PS	200	20000
SS-300	Suitable for 30, 120 and 150mL containers	Red	PS	200	20000
SS-310	Suitable for 30, 120 and 150mL containers	White	PS	200	20000

SHOP FLOOR | Specimen Containers

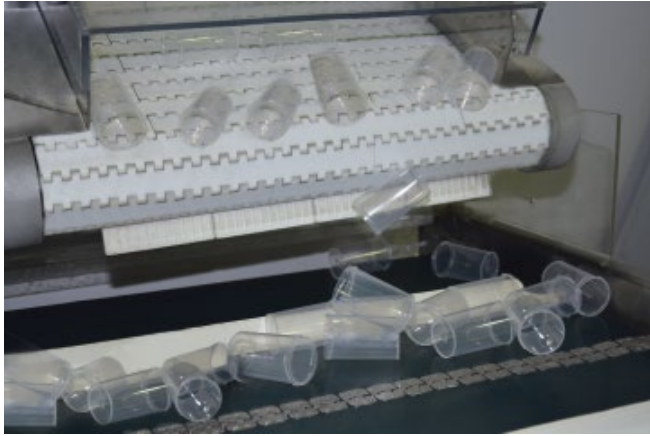

Fig 3.1. Fully automatic Specimen Container production line - Container feeding.



Fig 3.2. Fully automatic Specimen Container production line - Cap feeding.

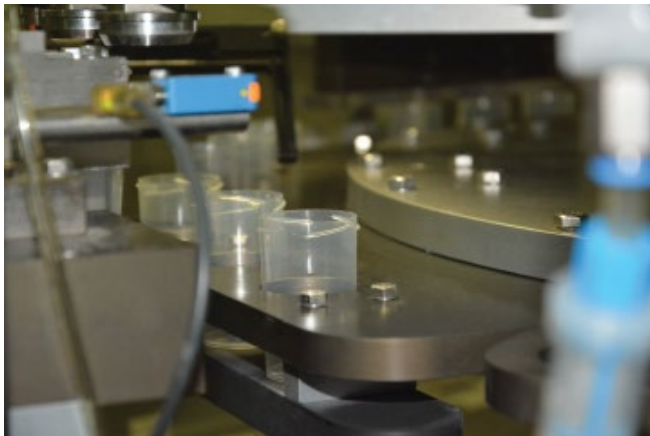

Fig 3.3. Fully automatic Specimen Container production line - Container loading.

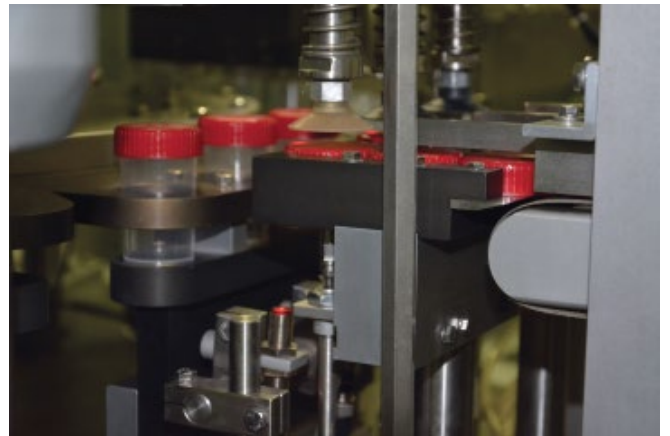

Fig 3.4. Fully automatic Specimen Container production line - Container / cap closure.



Fig 3.5. Fully automatic Specimen Container production line - Assembled product.



Fig 3.6. Fully automatic Specimen Container production line - Product packaging.



SAFETY BOXES

Safety Boxes 1 L	34
Safety Boxes 1.8 L	34
Safety Boxes 3 L	35
Safety Boxes 5 L	35
Safety Boxes 10 L	36
Hangers	36

04

SAFETY BOXES

1L

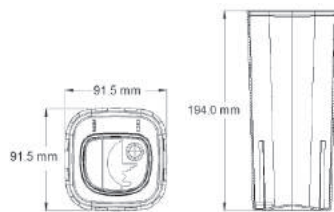

SAFETY BOXES 1 L

INTENDED USE

- Used for the safe disposal of contaminated products and sharps

MATERIAL

- Manufactured using polypropylene

FEATURES

- Designed and labelled in accordance to the UN3291 Standard
- Shock-proof container, resistant to solvents and perforation
- Easy to handle
- Permanent and damage-proof closure
- Puncture-resistant
- Stable on flat surfaces
- Leak-proof upon locking the lid
- Cover provided with a built-in flat opening having a temporary and permanent closing system

Product code	Total Capacity (L)	Useful Capacity (L)	Maximum Load (kg)	Pieces/box
SH-010	1	0.8	0.6	100

1.8L

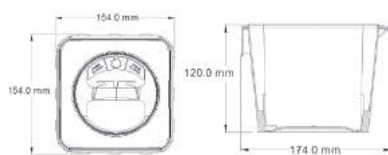

SAFETY BOXES 1.8 L

INTENDED USE

- Used for the safe disposal of contaminated products and sharps

MATERIAL

- Manufactured using polypropylene

FEATURES

- Designed and labelled in accordance to the UN3291 Standard
- Shock-proof container, resistant to solvents and perforation
- Easy to handle
- Permanent and damage-proof closure
- Handles manufactured to withstand the capacity and volume of each container
- Puncture-resistant
- Stable on flat surfaces
- Leak-proof upon locking the lid

Product code	Total Capacity (L)	Useful Capacity (L)	Maximum Load (kg)	Pieces/box
SH-018	1.8	1.44	1	45

3L

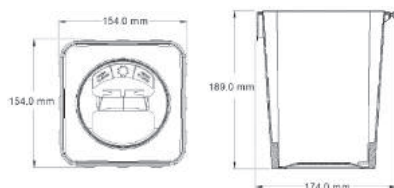

SAFETY BOXES 3 L

INTENDED USE

- Used for the safe disposal of contaminated products and sharps

MATERIAL

- Manufactured using polypropylene

FEATURES

- Designed and labelled in accordance to the UN3291 Standard
- Shock-proof container, resistant to solvents and perforation
- Easy to handle
- Permanent and damage-proof closure
- Handles manufactured to withstand the capacity and volume of each container
- Puncture-resistant
- Stable on flat surfaces
- Leak-proof upon locking the lid

Product code	Total Capacity (L)	Useful Capacity (L)	Maximum Load (kg)	Pieces/box
SH-030	3	2.4	2	36

5L

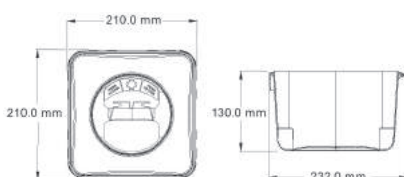

SAFETY BOXES 5 L

INTENDED USE

- Used for the safe disposal of contaminated products and sharps

MATERIAL

- Manufactured using polypropylene

FEATURES

- Designed and labelled in accordance to the UN3291 Standard
- Shock-proof container, resistant to solvents and perforation
- Easy to handle
- Permanent and damage-proof closure
- Handles manufactured to withstand the capacity and volume of each container
- Puncture-resistant
- Stable on flat surfaces
- Leak-proof upon locking the lid

Product code	Total Capacity (L)	Useful Capacity (L)	Maximum Load (kg)	Pieces/box
SH-050	5	4	3	30

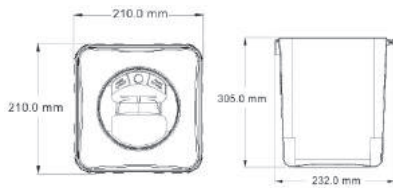

SAFETY BOXES 10 L

INTENDED USE

- Used for the safe disposal of contaminated products and sharps

MATERIAL

- Manufactured using polypropylene

FEATURES

- Designed and labelled in accordance to the UN3291 Standard
- Shock-proof container, resistant to solvents and perforation
- Easy to handle
- Permanent and damage-proof closure
- Handles manufactured to withstand the capacity and volume of each container
- Puncture-resistant
- Stable on flat surfaces
- Leak-proof upon locking the lid

Product code	Total Capacity (L)	Useful Capacity (L)	Maximum Load (kg)	Pieces per box
SH-100	10	8	5	20

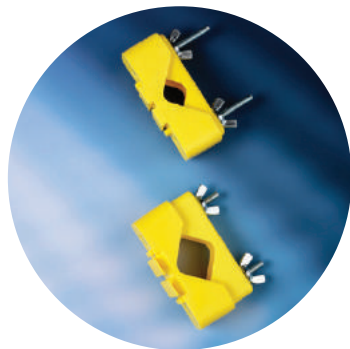

HANGERS

INTENDED USE

- Used for wall or trolley mounting of sharps containers

FEATURES

- Suitable for hanging 1.8 L, 3 L, 5 L and 10 L sharps containers

Product code
SH-001

TUBES

Vacurate® Vacuum Blood Collection Tubes	38
Vacurate® Vacuum Urine Collection Tubes	48
Tourniquets	48
Vacurate® Vacuum Tube Holders	49
Vacuum Tube Needles	49
Blood Collection Tubes 2.5 ML & 5 ML Push Cap	50
Blood Collection Tubes 10 ML	53
Blood Collection Tubes 2.5 ML & 5 ML Screw Cap	53
Conical Tubes 15 ML	55
Conical Tubes 50 ML	56
Test Tubes 5 ML	58
Caps For Test Tubes	58

05

TUBES

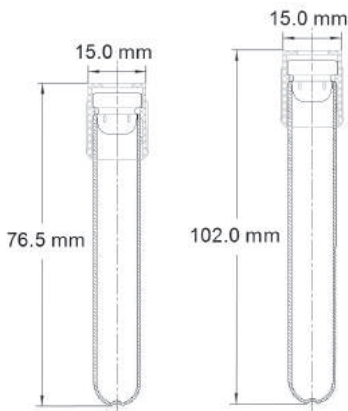
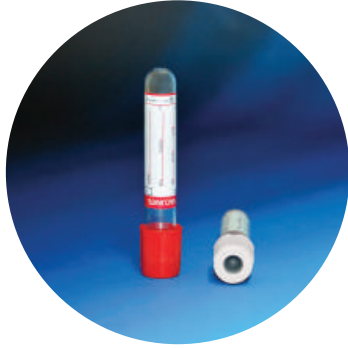

VACURATE® VACUUM BLOOD COLLECTION TUBES | Plain

INTENDED USE

- Used in various blood analysis applications and as discard tubes

MATERIAL

- Tubes manufactured using transparent PET
- Caps manufactured using polyethylene
- Additive: none

FEATURES

- Sterile
- Impact resistant and chemically resistant
- Precise and accurate withdrawal of predetermined blood volume through vacuum
- Color coded label and cap, indicating the additive type
- Supplied with plastic tube racks optimized for maximum accommodation and minimum space occupation
- CE marked
- Cap is enclosed with a leak-proof and self-sealing rubber stopper for safe and clean blood transfer

Product Code	Draw Volume (mL)	Tube Size (mm)	Cap Color	Quantity per Rack	Pieces per Box
VBC-200300	2	13x75	White	100	1000
VBC-300300	3	13x75	White	100	1000
VBC-400300	4	13x75	White	100	1000
VBC-600300	6	13x100	White	100	1000
VBC-200400	2	13x75	Red	100	1000
VBC-300400	3	13x75	Red	100	1000
VBC-400400	4	13x75	Red	100	1000
VBC-600400	6	13x100	Red	100	1000
VBC-700400	7	13x100	Red	100	1000
VBC-800400	8	16x100	Red	100	1000
VBC-900400	9	16x100	Red	100	1000

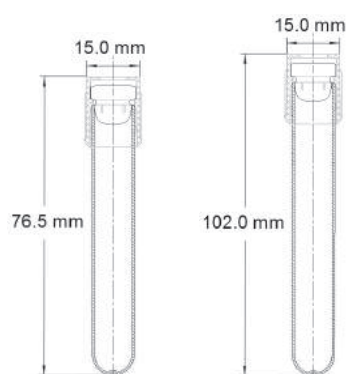

VACURATE® VACUUM BLOOD COLLECTION TUBES | Clot Activator

INTENDED USE

- Also known as serum tubes
- Used for determinations in serum for clinical routine chemistry

MATERIAL

- Tubes manufactured using transparent PET
- Caps manufactured using polyethylene
- Additive: Clot activator

FEATURES

- Sterile
- Impact resistant and chemically resistant
- Precise and accurate withdrawal of predetermined blood volume through vacuum
- Color coded label and cap, indicating the additive type
- Supplied with plastic tube racks optimized for maximum accommodation and minimum space occupation
- CE marked
- Cap is enclosed with a leak-proof and self-sealing rubber stopper for safe and clean blood transfer

Product Code	Draw Volume (mL)	Tube Size (mm)	Cap Color	Quantity per Rack	Pieces per Box
VBC-300408	3	13x75	Red	100	1000
VBC-400408	4	13x75	Red	100	1000
VBC-600408	6	13x100	Red	100	1000
VBC-700408	7	13x100	Red	100	1000
VBC-800408	8	16x100	Red	100	1000
VBC-900408	9	16x100	Red	100	1000
VBC-100408	10	16x100	Red	100	1000

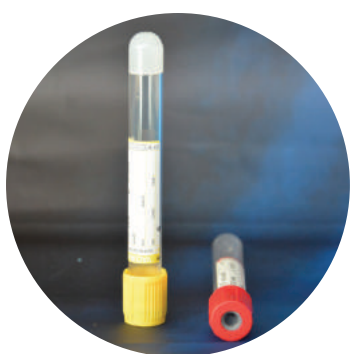

VACURATE® VACUUM BLOOD COLLECTION TUBES | Gel Separator + Clot Activator

INTENDED USE

- Also known as serum tubes
- Used for determinations in serum for clinical routine chemistry

MATERIAL

- Tubes manufactured using transparent PET
- Caps manufactured using polyethylene
- Additive: Clot activator and gel separator

FEATURES

- Sterile
- Impact resistant and chemically resistant
- Precise and accurate withdrawal of predetermined blood volume through vacuum
- Color coded label and cap, indicating the additive type
- Supplied with plastic tube racks optimized for maximum accommodation and minimum space occupation
- CE marked
- Cap is enclosed with a leak-proof and self-sealing rubber stopper for safe and clean blood transfer

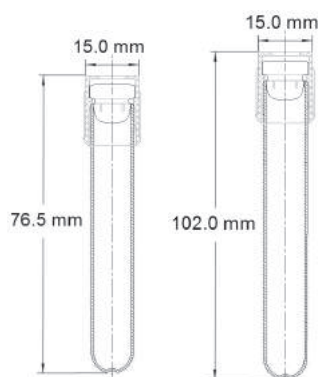

Product Code	Draw Volume (mL)	Tube Size (mm)	Cap Color	Quantity per Rack	Pieces per Box
VBC-350409	3.5	13x75	Red	100	1000
VBC-500409	5	13x100	Red	100	1000
VBC-350909	3.5	13x75	Golden	100	1000
VBC-500909	5	13x100	Golden	100	1000
VBC-350609	3.5	13x75	Dark Blue	100	1000
VBC-500609	5	13x100	Dark Blue	100	1000
VBC-600909	6	13x100	Golden	100	1000
VBC-700909	7	16x100	Golden	100	1000
VBC-800909	8	16x100	Golden	100	1000
VBC-900909	9	16x100	Golden	100	1000
VBC-100909	10	16x100	Golden	100	1000

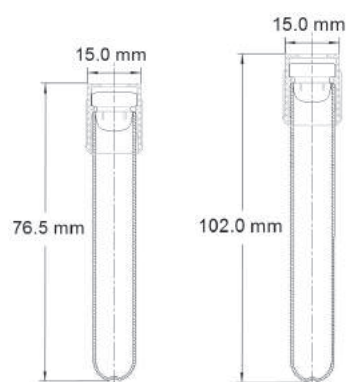
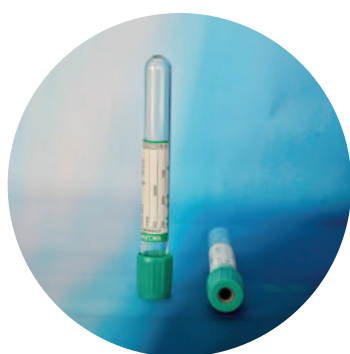

VACURATE® VACUUM BLOOD COLLECTION TUBES | Lithium Heparin

INTENDED USE

- Also known as plasma tubes
- Used for determinations in plasma for clinical routine chemistry

MATERIAL

- Tubes manufactured using transparent PET
- Caps manufactured using polyethylene
- Additive: Lithium Heparin

FEATURES

- Sterile
- Impact resistant and chemically resistant
- Precise and accurate withdrawal of predetermined blood volume through vacuum
- Color coded label and cap, indicating the additive type
- Supplied with plastic tube racks optimized for maximum accommodation and minimum space occupation
- CE marked
- Caps enclosed a leak-proof and self-sealing rubber stopper for safe and clean blood transfer

Product Code	Draw Volume (mL)	Tube Size (mm)	Cap Color	Quantity per Rack	Pieces per Box
VBC-200803	2	13x75	Green	100	1000
VBC-300803	3	13x75	Green	100	1000
VBC-400803	4	13x75	Green	100	1000
VBC-600803	6	13x100	Green	100	1000
VBC-700803	7	13x100	Green	100	1000
VBC-800803	8	16x100	Green	100	1000
VBC-900803	9	16x100	Green	100	1000
VBC-100803	10	16x100	Green	100	1000



VACURATE® VACUUM BLOOD COLLECTION TUBES | Lithium Heparin + Gel Separator

INTENDED USE

- Also known as plasma tubes
- Used for determinations in plasma for clinical routine chemistry

MATERIAL

- Tubes manufactured using transparent PET
- Caps manufactured using polyethylene
- Additive: Lithium Heparin and gel separator

FEATURES

- Sterile
- Impact resistant and chemically resistant
- Precise and accurate withdrawal of predetermined blood volume through vacuum
- Color coded label and cap, indicating the additive type
- Supplied with plastic tube racks optimized for maximum accommodation and minimum space occupation
- CE marked
- Cap is enclosed with a leak-proof and self-sealing rubber stopper for safe and clean blood transfer

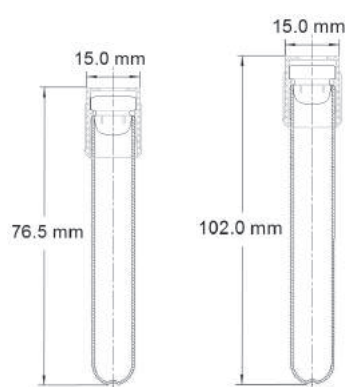

Product Code	Draw Volume (mL)	Tube Size (mm)	Cap Color	Quantity per Rack	Pieces per Box
VBC-301110	3	13x75	Turquoise	100	1000
VBC-501110	5	13x100	Turquoise	100	1000
VBC-601110	6	16x100	Turquoise	100	1000
VBC-701110	7	16x100	Turquoise	100	1000
VBC-801110	8	16x100	Turquoise	100	1000
VBC-901110	9	16x100	Turquoise	100	1000
VBC-101110	10	16x100	Turquoise	100	1000

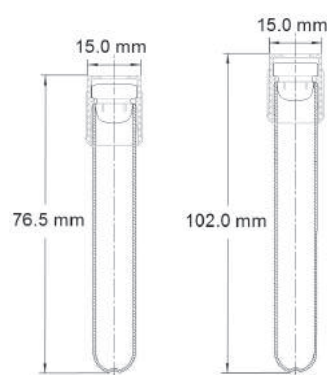
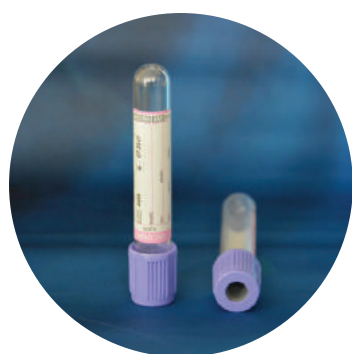

VACURATE® VACUUM BLOOD COLLECTION TUBES | K₂EDTA

INTENDED USE

- Used for determinations in whole blood for hematology

MATERIAL

- Tubes manufactured using transparent PET
- Caps manufactured using polyethylene
- Additive: Sprayed K₂EDTA

FEATURES

- Sterile
- Impact resistant and chemically resistant
- Precise and accurate withdrawal of predetermined blood volume through vacuum
- Color coded label and cap, indicating the additive type
- Supplied with plastic tube racks optimized for maximum accommodation and minimum space occupation
- CE marked
- Cap is enclosed with a leak-proof and self-sealing rubber stopper for safe and clean blood transfer

Product Code	Draw Volume (mL)	Tube Size (mm)	Cap Color	Quantity per Rack	Pieces per Box
VBC-200701	2	13x75	Lavender	100	1000
VBC-300701	3	13x75	Lavender	100	1000
VBC-400701	4	13x75	Lavender	100	1000
VBC-600701	6	13x100	Lavender	100	1000
VBC-700701	7	13x100	Lavender	100	1000
VBC-800701	8	16x100	Lavender	100	1000
VBC-900701	9	16x100	Lavender	100	1000
VBC-100701	10	16x100	Lavender	100	1000

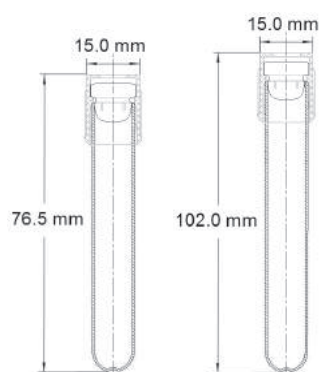
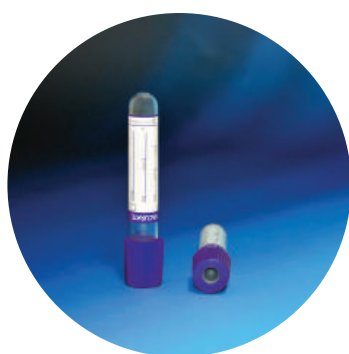

VACURATE® VACUUM BLOOD COLLECTION TUBES | K₃EDTA

INTENDED USE

- Used for determinations in whole blood for hematology

MATERIAL

- Tubes manufactured using transparent PET
- Caps manufactured using polyethylene
- Additive: Liquid K₃EDTA

FEATURES

- Sterile
- Impact resistant and chemically resistant
- Precise and accurate withdrawal of predetermined blood volume through vacuum
- Color coded label and cap, indicating the additive type
- Supplied with plastic tube racks optimized for maximum accommodation and minimum space occupation
- CE marked
- Cap is enclosed with a leak-proof and self-sealing rubber stopper for safe and clean blood transfer

Product Code	Draw Volume (mL)	Tube Size (mm)	Cap Color	Quantity per Rack	Pieces per Box
VBC-200502	2	13x75	Violet	100	1000
VBC-300502	3	13x75	Violet	100	1000
VBC-400502	4	13x75	Violet	100	1000
VBC-600502	6	13x100	Violet	100	1000
VBC-700502	7	13x100	Violet	100	1000
VBC-800502	8	16x100	Violet	100	1000
VBC-900502	9	16x100	Violet	100	1000
VBC-100502	10	16x100	Violet	100	1000

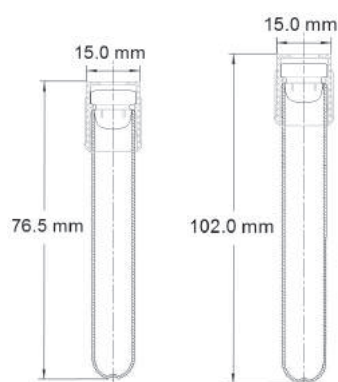
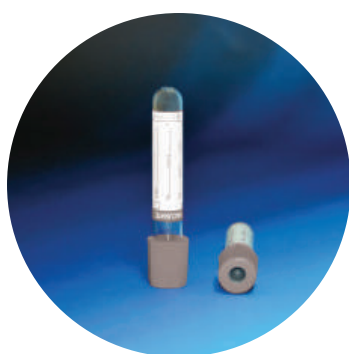

VACURATE® VACUUM BLOOD COLLECTION TUBES | Potassium Fluoride + K₃EDTA

INTENDED USE

- Also known as glucos tubes
- Used for glucose determinations

MATERIAL

- Tubes manufactured using transparent PET
- Caps manufactured using polyethylene
- Additive: Potassium Fluoride + K₃EDTA

FEATURES

- Sterile
- Impact resistant and chemically resistant
- Precise and accurate withdrawal of predetermined blood volume through vacuum
- Color coded label and cap, indicating the additive type
- Supplied with plastic tube racks optimized for maximum accommodation and minimum space occupation
- CE marked
- Cap is enclosed with a leak-proof and self-sealing rubber stopper for safe and clean blood transfer

Product Code	Draw Volume (mL)	Tube Size (mm)	Cap Color	Quantity per Rack	Pieces per Box
VBC-201007	2	13x75	Grey	100	1000
VBC-301007	3	13x75	Grey	100	1000
VBC-401007	4	13x75	Grey	100	1000
VBC-601007	6	13x100	Grey	100	1000
VBC-701007	7	13x100	Grey	100	1000
VBC-801007	8	16x100	Grey	100	1000
VBC-901007	9	16x100	Grey	100	1000

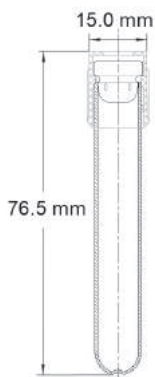
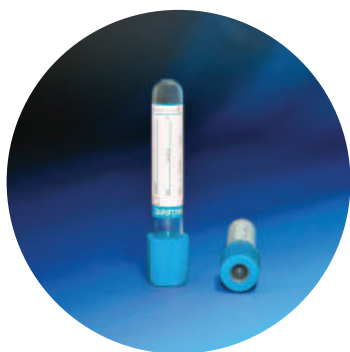

VACURATE® VACUUM BLOOD COLLECTION TUBES | Sodium Citrate 3.2%

INTENDED USE

- Also known as coagulation tubes
- Used for determinations in Plasma for coagulation testing

MATERIAL

- Tubes manufactured using transparent PET
- Caps manufactured using polyethylene
- Additive: Sodium Citrate 3.2%

FEATURES

- Sterile
- Impact resistant and chemically resistant
- Precise and accurate withdrawal of predetermined blood volume through vacuum
- Color coded label and cap, indicating the additive type
- Supplied with plastic tube racks optimized for maximum accommodation and minimum space occupation
- CE marked
- Cap is enclosed with a leak-proof and self-sealing rubber stopper for safe and clean blood transfer

Product Code	Draw Volume (mL)	Tube Size (mm)	Cap Color	Quantity per Rack	Pieces per Box
VBC-180104	1.8	13x75	Light Blue	100	1000
VBC-270104	2.7	13x75	Light Blue	100	1000
VBC-360104	3.6	13x75	Light Blue	100	1000
VBC-450104	4.5	13x100	Light Blue	100	1000

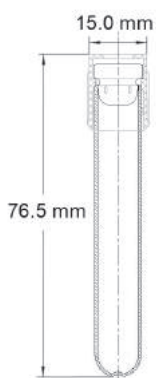
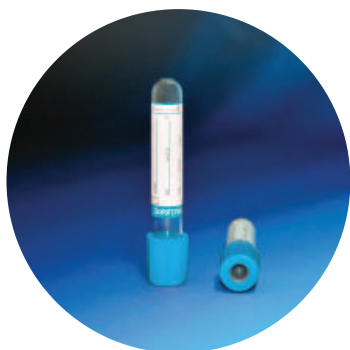

VACURATE® VACUUM BLOOD COLLECTION TUBES | Sodium Citrate 3.8%

INTENDED USE

- Also known as coagulation tubes
- Used in various blood analysis applications

MATERIAL

- Tubes manufactured using transparent PET
- Caps manufactured using polyethylene
- Additive: Sodium Citrate 3.8%

FEATURES

- Sterile
- Precision molded
- Impact resistant and chemically resistant
- Precise and accurate withdrawal of predetermined blood volume through vacuum
- Color coded label and cap, indicating the additive type
- Supplied with plastic tube racks optimized for maximum accommodation and minimum space occupation
- CE marked
- Cap is enclosed with a leak-proof and self-sealing rubber stopper for safe and clean blood transfer

Product Code	Draw Volume (mL)	Tube Size (mm)	Cap Color	Quantity per Rack	Pieces per Box
VBC-180105	1.8	13x75	Light Blue	100	1000
VBC-270105	2.7	13x75	Light Blue	100	1000
VBC-360105	3.6	13x75	Light Blue	100	1000
VBC-450105	4.5	13x100	Light Blue	100	1000

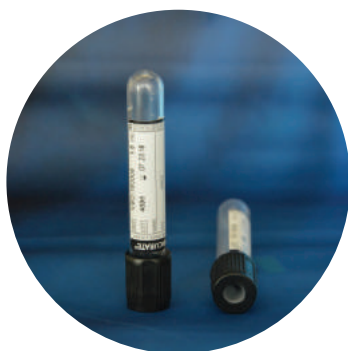

VACURATE® VACUUM BLOOD COLLECTION TUBES | Sodium Citrate 3.2% ESR

INTENDED USE

- Also known as coagulation tubes
- Used for determinations in Plasma for coagulation testing

MATERIAL

- Tubes manufactured using transparent PET
- Caps manufactured using polyethylene
- Additive: Sodium Citrate 3.2%

FEATURES

- Sterile
- Impact resistant and chemically resistant
- Precise and accurate withdrawal of predetermined blood volume through vacuum
- Color coded label and cap, indicating the additive type
- Supplied with plastic tube racks optimized for maximum accommodation and minimum space occupation
- CE marked
- Cap is enclosed with a leak-proof and self-sealing rubber stopper for safe and clean blood transfer

Product Code	Draw Volume (mL)	Tube Size (mm)	Cap Color	Quantity per Rack	Pieces per Box
VBC-160006	1.6	13x75	Black for ESR	100	1000
VBC-180006	1.8	13x75	Black for ESR	100	1000
VBC-240006	2.4	13x75	Black for ESR	100	1000



VACURATE® VACUUM URINE COLLECTION TUBES

INTENDED USE

- A closed system for a clean urine draw without coming into contact with the specimen
- Used in urinalysis

MATERIAL

- Tubes manufactured using transparent PET
- Caps manufactured using polyethylene
- Additive: no preservative

FEATURES

- Sterile
- CE marked
- Impact resistant and chemically resistant
- Precise and accurate withdrawal of predetermined urine volume through vacuum
- Color coded label and cap
- Cap is enclosed with a leak-proof and self-sealing rubber stopper for safe and clean urine transfer
- Supplied with plastic tube racks optimized for maximum accommodation and minimum space occupation

Product Code	Draw Volume	Tube Size	Cap Color	Qty per pack	Pieces per box
VUC-400211	4	13x75	Yellow	100	1000
VUC-400211	6	13x100	Yellow	100	1000



TOURNIQUETS

INTENDED USE

- Used for the constriction and control of blood circulation

MATERIAL

- Manufactured with a plastic buckle and an elastic band

FEATURES

- Ergonomic
- Easy to use

Product Code	Pieces per Box
VBCTQ-100	300



VACUUM TUBE HOLDERS

INTENDED USE

- Used to hold and accomodated the needle

MATERIAL

- Manufactured using polypropylene

FEATURES

- Simple design with a grip for proper handling during blood transfer

Product Code	Pieces per bag	Qty per box
VBCH-100	250	2000

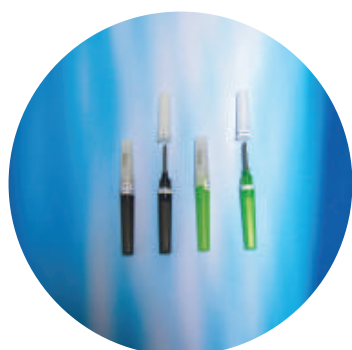

VACUUM TUBE NEEDLES

INTENDED USE

- Used to penetrate the vein and help in blood transfer

MATERIAL

- Manufactured using the latest technology in needle manufacturing

FEATURES

- Easy and simple to use with vacuum tube
- Sterile

Product Code	Size (FG)
VBCN-020	20
VBCN-021	21
VBCN-022	22
VBCN-023	23



BLOOD COLLECTION TUBES 2.5 ML & 5 ML | Push Cap, Round Bottom, Plain

INTENDED USE

- Used for blood testing and analysis

MATERIAL

- Tube manufactured using Polypropylene
- Cap manufactured using low density Polyethylene

FEATURES

- Leak-proof
- Fixed label indicating the blood volume to be drawn
- CE marked
- Free rack available
- Instructions for use available on each rack
- Color-coded in accordance to international standards

Product code	Volume on label (mL)	Cap type	Cap color	Bottom	Quantity per rack	Pieces per box
BCP-210	2.5 & 5.0	Push	Grey	Round	50	1000
BCP-900	Without label	Push	Grey	Round	50	1000



BLOOD COLLECTION TUBES 2.5 ML & 5 ML | Push Cap, Round Bottom, Sodium Citrate

INTENDED USE

- Used for blood testing and analysis

MATERIAL

- Tube manufactured using Polypropylene
- Cap manufactured using low density Polyethylene

FEATURES

- Leak-proof
- Fixed label indicating the blood volume to be drawn
- CE marked
- Free rack available
- Instructions for use available on each rack
- Color-coded in accordance to international standards

Product code	Volume on label (mL)	Cap type	Cap color	Bottom	Quantity per rack	Pieces per box
BCP-214	2.5	Push	Pink	Round	50	1000
BCP-514	5.0	Push	Pink	Round	50	1000



BLOOD COLLECTION TUBES 2.5 ML & 5 ML | Push Cap, Round Bottom, Lithium Heparin

INTENDED USE

- Used for blood testing and analysis

MATERIAL

- Tube manufactured using Polypropylene
- Cap manufactured using low density Polyethylene

FEATURES

- Leak-proof
- Fixed label indicating the blood volume to be drawn
- CE marked
- Free rack available
- Instructions for use available on each rack
- Color-coded in accordance to international standards

Product code	Volume on label (mL)	Cap type	Cap color	Bottom	Quantity per rack	Pieces per box
BCP-213	2.5	Push	Blue	Round	50	1000
BCP-513	5.0	Push	Blue	Round	50	1000



BLOOD COLLECTION TUBES 2.5 ML & 5 ML | Push Cap, Round Bottom, Fluoride Oxalate

INTENDED USE

- Used for blood testing and analysis

MATERIAL

- Tube manufactured using Polypropylene
- Cap manufactured using low density Polyethylene

FEATURES

- Leak-proof
- Fixed label indicating the blood volume to be drawn
- CE marked
- Free rack available
- Instructions for use available on each rack
- Color-coded in accordance to international standards

Product code	Volume on label (mL)	Cap type	Cap color	Bottom	Quantity per rack	Pieces per box
BCP-211	2.5	Push	Yellow	Round	50	1000
BCP-511	5.0	Push	Yellow	Round	50	1000

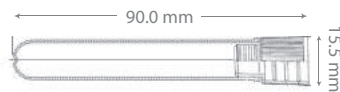

BLOOD COLLECTION TUBES 2.5 ML & 5 ML | Push Cap, Round Bottom, K₃EDTA

INTENDED USE

- Used for blood testing and analysis

MATERIAL

- Tube manufactured using Polypropylene
- Cap manufactured using low density Polyethylene

FEATURES

- Leak-proof
- Fixed label indicating the blood volume to be drawn
- CE marked
- Free rack available
- Instructions for use available on each rack
- Color-coded in accordance to international standards

Product code	Volume on label (mL)	Cap type	Cap color	Bottom	Quantity per rack	Pieces per box
BCP-212	2.5	Push	Green/Purple	Round	50	1000
BCP-512	5.0	Push	Green/Purple	Round	50	1000

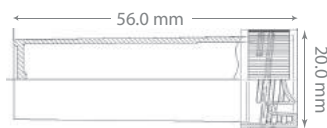

BLOOD COLLECTION TUBES 2.5 ML & 5 ML | Screw Cap, Flat bottom, Plain

INTENDED USE

- Used for blood testing and analysis

MATERIAL

- Tube manufactured using Polypropylene
- Cap manufactured using Polypropylene

FEATURES

- Leak-proof
- Fixed label indicating the blood volume to be drawn
- CE marked
- Free rack available
- Instructions for use available on each rack
- Color-coded in accordance to international standards

Product code	Volume on label (mL)	Cap type	Cap color	Bottom	Quantity per rack	Pieces per box
BCS-500	2.5 & 5.0	Screw	Red	Flat	50	1000

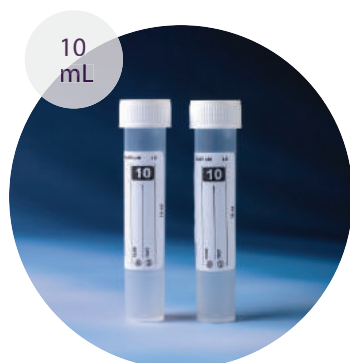

10 mL

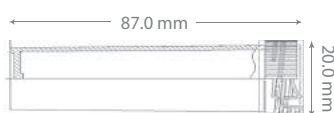

BLOOD COLLECTION TUBES 10 ML | Screw Cap, Flat bottom, Plain

INTENDED USE

- Used for blood testing and analysis

MATERIAL

- Tube manufactured using Polypropylene
- Cap manufactured using Polypropylene

FEATURES

- Leak-proof
- Fixed label indicating the blood volume to be drawn
- CE marked
- Free rack available
- Instructions for use available on each rack
- Color-coded in accordance to international standards

Product code	Volume on label (mL)	Cap type	Cap color	Bottom	Supplied in a Rack	Quantity per pack	Pieces per box
BCS-100	10.0	Screw	White	Flat	No	200	2000



2.5 & 5 mL

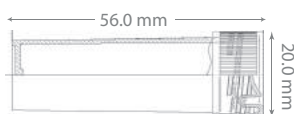

BLOOD COLLECTION TUBES 2.5 ML & 5 ML | Screw Cap, Flat bottom, Sodium Citrate

INTENDED USE

- Used for blood testing and analysis

MATERIAL

- Tube manufactured using Polypropylene
- Cap manufactured using Polypropylene

FEATURES

- Leak-proof
- Fixed label indicating the blood volume to be drawn
- CE marked
- Free rack available
- Instructions for use available on each rack
- Color-coded in accordance to international standards

Product code	Volume on label (mL)	Cap type	Cap color	Bottom	Quantity per rack	Pieces per box
BCS-204	2.5	Screw	Pink	Flat	50	1000
BCS-504	5.0	Screw	Pink	Flat	50	1000

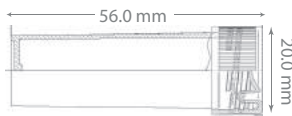
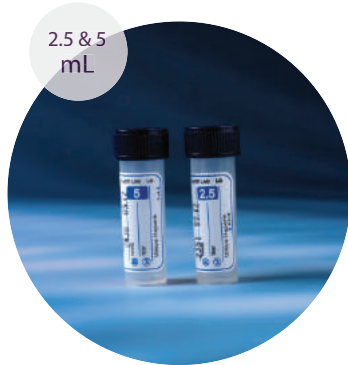

BLOOD COLLECTION TUBES 2.5 ML & 5 ML | Screw Cap, Flat bottom, Lithium Heparin

INTENDED USE

- Used for blood testing and analysis

MATERIAL

- Tube manufactured using Polypropylene
- Cap manufactured using Polypropylene

FEATURES

- Leak-proof
- Fixed label indicating the blood volume to be drawn
- CE marked
- Free rack available
- Instructions for use available on each rack
- Color-coded in accordance to international standards

Product code	Volume on label (mL)	Cap type	Cap color	Bottom	Quantity per rack	Pieces per box
BCS-203	2.5	Screw	Blue	Flat	50	1000
BCS-503	5.0	Screw	Blue	Flat	50	1000



BLOOD COLLECTION TUBES 2.5 ML & 5 ML | Screw Cap, Flat bottom, Fluoride Oxalate

INTENDED USE

- Used for blood testing and analysis

MATERIAL

- Tube manufactured using Polypropylene
- Cap manufactured using Polypropylene

FEATURES

- Leak-proof
- Fixed label indicating the blood volume to be drawn
- CE marked
- Free rack available
- Instructions for use available on each rack
- Color-coded in accordance to international standards

Product code	Volume on label (mL)	Cap type	Cap color	Bottom	Quantity per rack	Pieces per box
BCS-201	2.5	Screw	Yellow	Flat	50	1000
BCS-501	5.0	Screw	Yellow	Flat	50	1000



2.5 & 5 mL



BLOOD COLLECTION TUBES 2.5 ML & 5 ML | Screw Cap, Flat bottom, K₃EDTA

INTENDED USE

- Used for blood testing and analysis

MATERIAL

- Tube manufactured using Polypropylene
- Cap manufactured using Polypropylene

FEATURES

- Leak-proof
- Fixed label indicating the blood volume to be drawn
- CE marked
- Free rack available
- Instructions for use available on each rack
- Color-coded in accordance to international standards

Product code	Volume on label (mL)	Cap type	Cap color	Bottom	Quantity per rack	Pieces per box
BCS-202	2.5	Screw	Green	Flat	50	1000
BCS-502	5.0	Screw	Green	Flat	50	1000

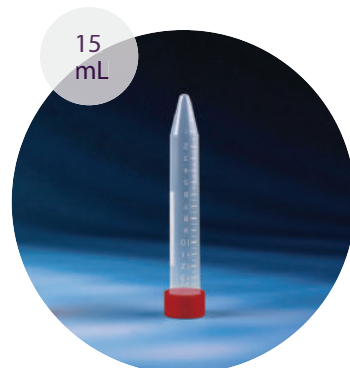

15 mL

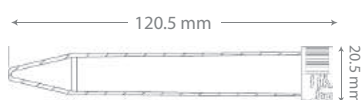

CONICAL TUBES 15 ML

INTENDED USE

- Used in centrifugation, sample storage, and molecular biology

MATERIAL

- Tube manufactured using Polypropylene
- Cap manufactured using Polypropylene

FEATURES

- Leak-proof
- Conical bottom suitable for centrifugation tests
- Silk screen printing
- Accurate and easy to read graduations
- Superior clarity
- Centrifugation can reach up to 11000 g
- CE marked

Product code	Description	Cap color	Sterility	Supplied on a rack	Inner pack quantity	Pieces per box
CTS-150	Screw Cap, Individually wrapped	Red	Sterile	No	1	250
CTS-151	Screw cap	Red	Sterile	No	10	1000
CTS-152	Screw cap	Red	Sterile	No	25	1000
CTS-155	Screw cap	Red	Sterile	No	50	1000
CTS-156	Screw cap	Red	Sterile	Yes	50	1000
CTS-155B	Screw cap, unassembled	Red	Sterile	No	50	1000

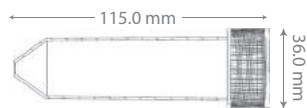

CONICAL TUBES 50 ML

INTENDED USE

- Used in centrifugation, sample storage, and molecular biology

MATERIAL

- Tube manufactured using Polypropylene
- Cap manufactured using high density Polyethylene

FEATURES

- Leak-proof
- Conical bottom suitable for centrifugation tests
- Silk screen printing
- Accurate and easy to read graduations
- Superior clarity
- Centrifugation can reach up to 11000 g
- CE marked

Product code	Description	Cap color	Sterility	Supplied on a rack	Inner pack quantity	Pieces per box
CTS-500	Screw cap, individually wrapped	Red	Sterile	No	1	500
CTS-502	Screw cap	Red	Sterile	No	25	500
CTS-510	Screw cap	Red	Sterile	No	100	500
CTS-506	Screw cap	Red	Sterile	Yes	25	500



Fig 5.2. Conical Tubes.

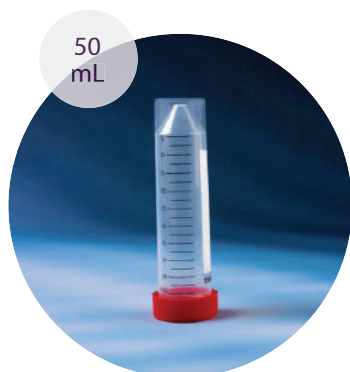

CONICAL TUBES 50 ML

INTENDED USE

- Used in centrifugation, sample storage, and molecular biology

MATERIAL

- Tube manufactured using Polypropylene
- Cap manufactured using high density Polyethylene

FEATURES

- Leak-proof
- Conical bottom suitable for centrifugation tests
- Silk screen printing
- Accurate and easy to read graduations
- Superior clarity
- Centrifugation can reach up to 11000 g
- CE marked

Product code	Description	Cap color	Sterility	Supplied on a rack	Inner pack quantity	Pieces per box
CTS-600	Screw cap, individually wrapped	Red	Sterile	No	1	500
CTS-601	Screw cap	Red	Sterile	No	10	500
CTS-602	Screw cap	Red	Sterile	No	25	500
CTS-610	Screw cap	Red	Sterile	No	100	500
CTS-606	Screw cap	Red	Sterile	Yes	25	500

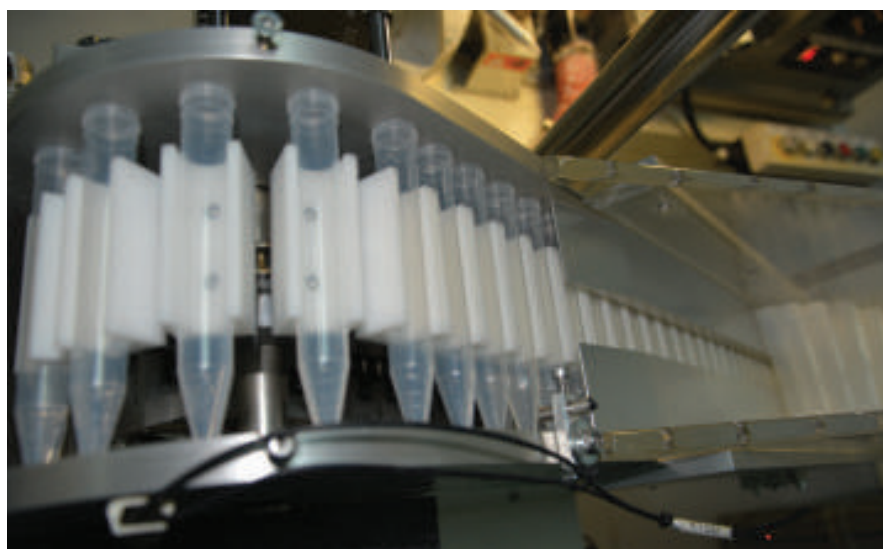
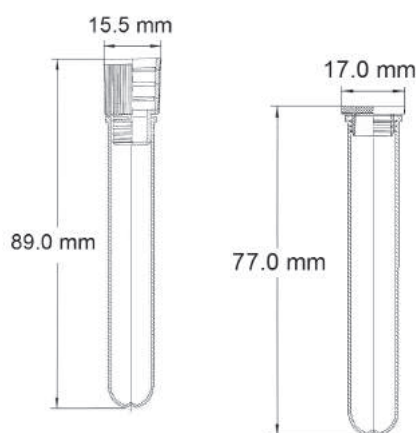
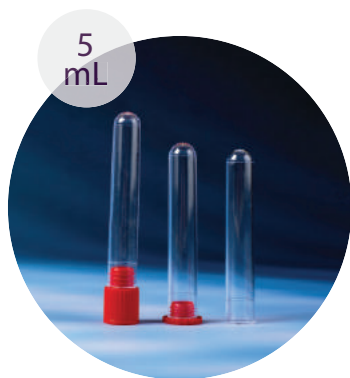

Fig 5.3. Conical Tubes.



TEST TUBES 5 ML | 12x75

INTENDED USE

- Used in dilutions, bacterial cultures, sample storage, centrifugation and precipitates, chromatography fraction collection and other applications

MATERIAL

- Tube manufactured using Polystyrene
- Cap manufactured using low density Polyethylene

FEATURES

- Precision molded
- Total transparency to ensure premium optical quality
- CE marked

Product code	Cap size	Cap color	Supplied on a rack	Inner pack quantity	Pieces per box
TT-500	-	-	-	500	6000
TT-501	Long	Blue	No	250	2000
TT-511	Long	Blue	Yes	50	1000
TT-502	Long	Yellow	No	250	2000
TT-512	Long	Yellow	Yes	50	1000
TT-503	Long	White	No	250	2000
TT-513	Long	White	Yes	50	1000
TT-504	Long	Red	No	250	2000
TT-514	Long	Red	Yes	50	1000
TT-505	Long	Violet	No	250	2000
TT-515	Long	Violet	Yes	50	1000
TT-506	Long	Dark Blue	No	250	2000
TT-516	Long	Dark Blue	Yes	50	1000
TT-507	Long	Pink	No	250	2000
TT-517	Long	Pink	Yes	50	1000
TT-509	Short	Red	No	250	2000
TT-519	Short	Red	Yes	50	1000

CAPS FOR TEST TUBES

MATERIAL

- Manufactured using medical grade LDPE

FEATURES

- Easy-on and easy-off application, ensuring a tight and leak-proof seal
- CE marked



Product code	Description of cap	Color	Inner pack quantity	Pieces per box
TC-501	Long	Blue	500	9000
TC-502	Long	Yellow	500	9000
TC-503	Long	White	500	9000
TC-504	Long	Red	500	9000
TC-505	Long	Violet	500	9000
TC-506	Long	Dark Blue	500	9000
TC-507	Long	Pink	500	9000
TC-508	Long	Green	500	9000
TC-509	Short	Red	500	21000

TIPS AND LOOPS

Micropipette Tips 5-200 μL	60
Micropipette Tips 100-1000 μL	60
Micropipette Tips in Rack 5-200 μL	61
Micropipette Tips in Rack 100-1000 μL	61
Inoculating Loops 1 μL	62
Inoculating Loops 10 μL	62

06

TIPS AND LOOPS



5-200
µL

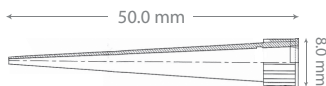

MICROPIPETTE TIPS 5-200 µL

INTENDED USE

- Used for the transport and sampling of a measured volume of liquid

MATERIAL

- Manufactured using polypropylene

FEATURES

- Precision molded tips
- DNase RNase free
- Packaged in sealed economical bulk bags or available in racks
- CE marked
- Standard color is yellow for easy identification. Other colors may be produced upon request

Product code	Volume Range (µL)	Color	Inner pack quantity	Pieces per box
MT-102	5-200	Yellow	1000	30000



100-1000
µL

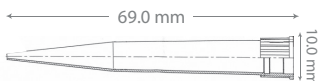

MICROPIPETTE TIPS 100-1000 µL

INTENDED USE

- Used for the transport and sampling of a measured volume of liquid

MATERIAL

- Manufactured using polypropylene

FEATURES

- Precision molded tips
- DNase RNase free
- Packaged in sealed economical bulk bags or available in racks
- CE marked
- Standard color is blue for easy identification. Other colors may be produced upon request

Product code	Volume Range (µL)	Color	Inner pack quantity	Pieces per box
MT-101	100-1000	Blue	1000	16000

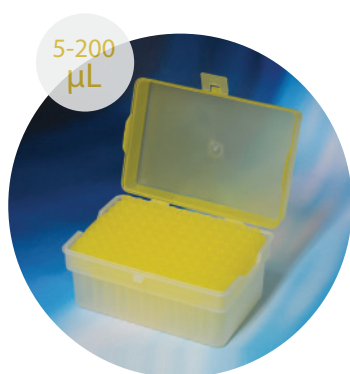

MICROPIPETTE TIPS IN RACK 5-200 μL

INTENDED USE

- Used for the transport and sampling of a measured volume of liquid

MATERIAL

- Tips manufactured using polypropylene
- Racks manufactured using polypropylene

FEATURES

- Precision molded tips
- ETO Sterilized
- Packaged in sealed economical bulk bags or available in racks
- Tips are DNase RNase free
- Standard color is yellow for easy identification. Other colors may be produced upon request
- CE marked

Product Code	Volume Range (μL)	Color	Pieces per rack	Racks per box
MT-202	5-200	Yellow	96	50

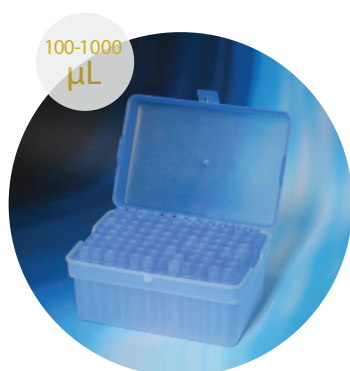

MICROPIPETTE TIPS IN RACK 100-1000 μL

INTENDED USE

- Used for the transport and sampling of a measured volume of liquid

MATERIAL

- Tips manufactured using polypropylene
- Racks manufactured using polypropylene

FEATURES

- Precision molded tips
- ETO Sterilized
- Packaged in sealed economical bulk bags or available in racks
- Tips are DNase RNase free
- Standard color is blue for easy identification. Other colors may be produced upon request
- CE marked

Product Code	Volume Range (μL)	Color	Pieces per rack	Racks per box
MT-201	100-1000	Blue	96	30

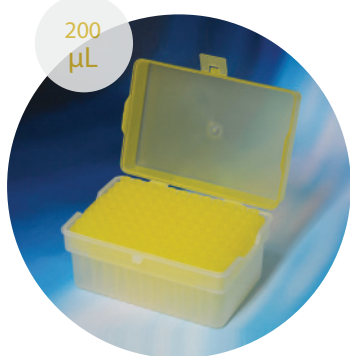

FILTER TIPS IN RACK 200 μL

INTENDED USE

- Used for the transport and sampling of a measured volume of liquid preventing cross contamination or “carry-over” from one sample to another.

MATERIAL

- Tips manufactured using polypropylene
- Racks manufactured using polypropylene

FEATURES

- Precision molded tips
- ETO Sterilized
- Packaged in racks
- Tips are DNase RNase free
- Standard color is yellow for easy identification. Other colors may be produced upon request
- CE marked

Product Code	Volume Range (μL)	Color	Pieces per rack	Racks per box
MT-222	100	Yellow	96	50
MT-212	200	Yellow	96	50

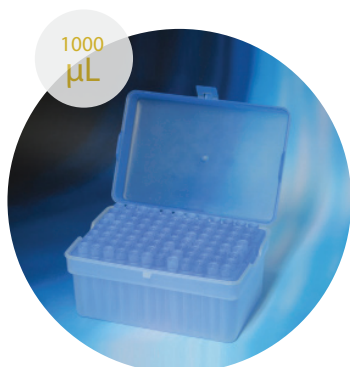

FILTER TIPS IN RACK 1000 μL

INTENDED USE

- Used for the transport and sampling of a measured volume of liquid preventing cross contamination or “carry-over” from one sample to another.

MATERIAL

- Tips manufactured using polypropylene
- Racks manufactured using polypropylene

FEATURES

- Precision molded tips
- ETO Sterilized
- Packaged in racks
- Tips are DNase RNase free
- Standard color is blue for easy identification. Other colors may be produced upon request
- CE marked

Product Code	Volume Range (μL)	Color	Pieces per rack	Racks per box
MT-211	1000	Blue	96	30

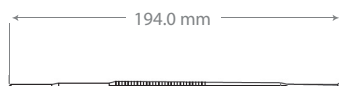
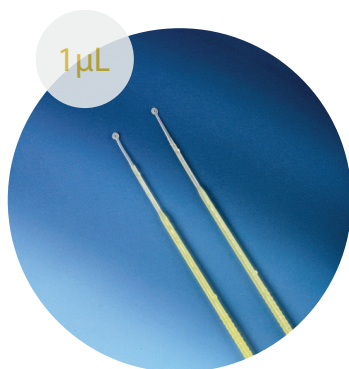

INOCULATING LOOPS 1 µL

INTENDED USE

- Used for the transfer of micro-organisms to growth media/staining slides

MATERIAL

- Manufactured using polypropylene

FEATURES

- Made for single use
- Safer to use than metal loops due to the absence of the need for flaming
- CE marked
- Acid-resistant
- Calibrated
- DNase RNase free
- Standard color is yellow for easy identification. Other colors may be produced upon request

Product code	Capacity (µL)	Color	Sterility	Inner pack quantity	Pieces per box
IL-011	1	Yellow	ETO	1	1250
IL-012	1	Yellow	ETO	5	5000
IL-013	1	Yellow	ETO	10	5000
IL-014	1	Yellow	ETO	20	5000

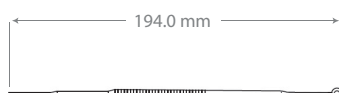
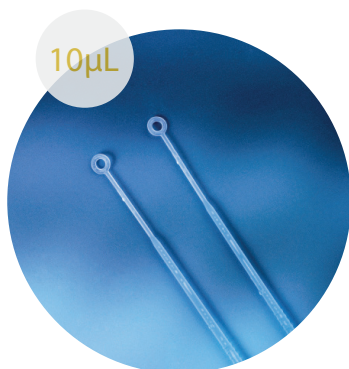

INOCULATING LOOPS 10 µL

INTENDED USE

- Used for the transfer of micro-organisms to growth media/staining slides

MATERIAL

- Manufactured using polypropylene

FEATURES

- Made for single use
- Safer to use than metal loops due to the absence of the need for flaming
- CE marked
- Acid-resistant
- Calibrated
- DNase RNase free
- Standard color is blue for easy identification. Other colors may be produced upon request

Product code	Capacity (µL)	Color	Sterility	Inner pack quantity	Pieces per box
IL-101	10	Blue	ETO	1	1250
IL-102	10	Blue	ETO	5	5000
IL-103	10	Blue	ETO	10	5000
IL-104	10	Blue	ETO	20	5000



VARIOUS MEDICAL SUPPLIES

Medicine Cups	64
Kidney Dishes	64
Burette	65
Blood Exchange Set	65
Umbilical Cord Clamps	66
Paper Rolls	66
Tongue Depressors	67
Cervix Spatulas	67
Male Urinals	68
Female Urinals	68

07

07

VARIOUS MEDICAL SUPPLIES



MEDICINE CUPS

INTENDED USE

- Used for oral medicine administration

MATERIAL

- Manufactured using polypropylene.

FEATURES

- Graduated with 30mL capacity
- Pliable and unbreakable
- CE marked

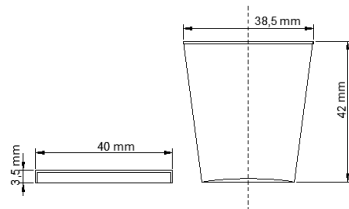

Product code	Description	Inner pack quantity	Pieces per box
MC-100	Without lid	100	5000
MC-101	Lid for Medicine Cup	100	1000
MC-102	Lid for Medicine Cup	100	2500



KIDNEY DISHES

INTENDED USE

- Used in medical and surgical wards to accommodate soiled dressings and other medical waste

MATERIAL

- Manufactured using polypropylene

FEATURES

- Graduated
- Autoclavable
- CE marked

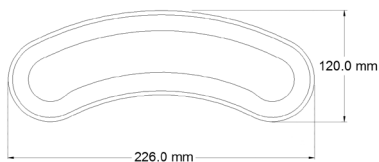

Product code	Description	Inner pack quantity	Pieces per box
KD-100	500mL graduated	50	250



BURETTE

INTENDED USE

- Used for dispensing precise amounts of a liquid reagent

FEATURES

- Clear and accurate graduation
- ETO sterilized, non-toxic, non-pyrogenic
- Individually packed

Product code	Inner pack quantity	Pieces per box
BS-150	25	100



BLOOD EXCHANGE SET

INTENDED USE

- Used for the removal of high concentrations of toxins in the blood which are not otherwise removable by diuresis, dialysis or chelation.
- Non-pyrogenic, non-toxic, and latex-free
- ETO sterilized

MATERIAL

- One blood transfusion set
- One extension tube with a needle and an injection site
- One extension tube
- One collection bag for discarded blood
- One X-ray opaque 5 Fr umbilical catheter
- One X-ray opaque 8 Fr umbilical catheter
- One 10mL luer locking syringe
- Two 20mL luer locking syringes
- One 25g needle
- One 4-way stopcock
- One 15cm ruler
- Three 50x50mm gauze swabs
- One table cover
- One pair of gloves
- One fenestrated drape
- One exchange transfusion record

Product code	Pieces per box
BE-100	10



UMBILICAL CORD CLAMPS

INTENDED USE

- Used for clamping the umbilical cord of newly born babies

MATERIAL

- Manufactured using acetal copolymer

FEATURES

- ETO Sterilized and individually wrapped
- Tamper-proof security lock to prevent accidental opening after clamping
- CE marked

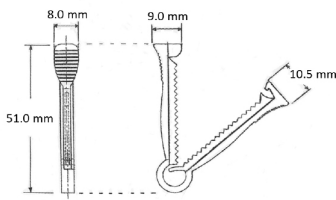

Product code	Sterility	Inner pack quantity	Pieces per box
CC-100	ETO	40	3000

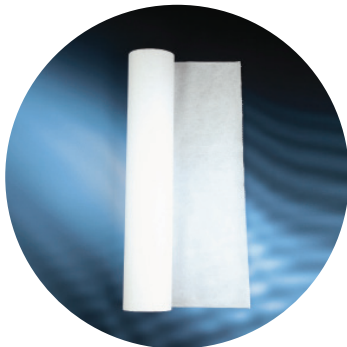

PAPER ROLLS

INTENDED USE

- Used on exam tables in clinical consultations

FEATURES

- High quality paper
- Perforated every 50cm

Product code	Color	Length (m)	Width (cm)	Pieces per box
PR-500	White	50	50	16



TONGUE DEPRESSORS

INTENDED USE

- Used in clinical oral consultations

MATERIAL

- Manufactured using polystyrene

FEATURES

- More hygienic and pleasant to use than wooden depressors
- Ergonomically shaped for a more accurate view
- Sterile depressors are individually wrapped in a packet, while non-sterile depressors are supplied in economical bags
- CE marked

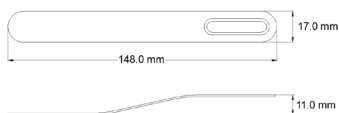

Product code	Sterility	Inner pack quantity	Pieces per box
TD-100	Non-Sterile	100	4800
TD-101	ETO	50	2400

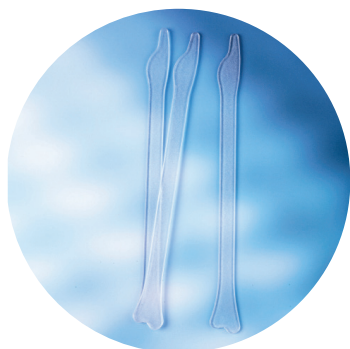

CERVIX SPATULAS

INTENDED USE

- Used for gynecological consultations

MATERIAL

- Manufactured using polystyrene

FEATURES

- More hygienic and pleasant to use than wooden spatulas
- Ergonomically shaped for a more accurate consultation
- Sterile spatulas are individually wrapped in a packet, while non-sterile spatulas are supplied in economical bags

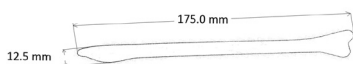

Product code	Sterility	Inner pack quantity	Pieces per box
CS-100	Non-Sterile	100	5000
CS-101	ETO	75	3600

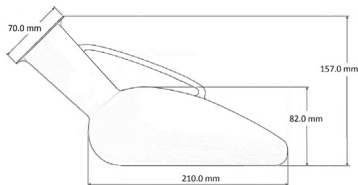

MALE URINALS CONTAINERS

INTENDED USE

- Used to help urination for health care patients who have difficulty getting out of bed

MATERIAL

- Manufactured using high-density polyethylene

FEATURES

- Has an opening for male genital insertion, long and narrow enough to prevent leakage while urination
- High practicality and simple to use
- Graduated both in mL and oz for easy determination of the urine amount produced

Product code	Pieces per box
UM-50	50

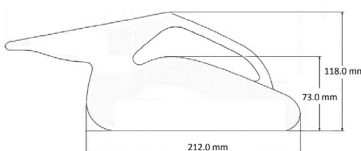
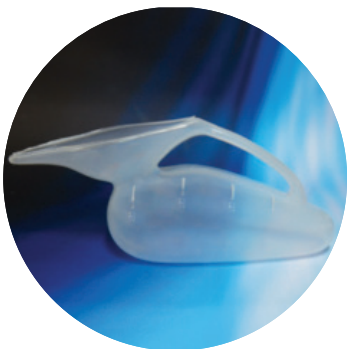

FEMALE URINALS CONTAINERS

INTENDED USE

- Used to help urination for health care patients who have difficulty getting out of bed

MATERIAL

- Manufactured using polypropylene

FEATURES

- Has a wide opening, enough to prevent leakage while urination
- High practicality and simple to use
- Graduated both in mL and oz for easy determination of the urine amount produced

Product code	Pieces per box
UF-50	50

CANNULAS

IV Cannulas 16 FG	70
IV Cannulas 18 FG	70
IV Cannulas 20 FG	71
IV Cannulas 22 FG	71
IV Cannulas 24 FG	72

08

08

CANNULAS

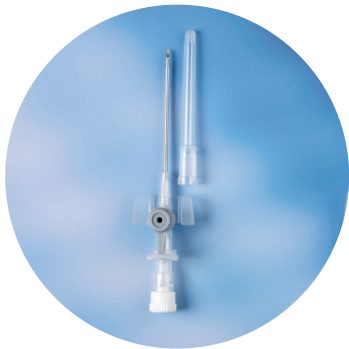

IV CANNULAS | 16 FG

INTENDED USE

- Used to obtain venous access for IV fluid and medication administration

FEATURES

- ETO Sterilized
- Non-toxic and non-pyrogenic
- The flash back chamber allows a visual image of the blood flow
- Triple point needle for easy and painless skin perforation
- Wings designed for an easy grasp
- Needle is covered in order to prevent any damage
- Has a luer lock plug
- Features an injection port
- Made for single use
- Color-coded in accordance to international standards
- CE marked

Product code	Size (FG)	Color	Inner pack quantity	Pieces per box
IV-016	16	Grey	50	2000



IV CANNULAS | 18 FG

INTENDED USE

- Used to obtain venous access for IV fluid and medication administration

FEATURES

- ETO Sterilized
- Non-toxic and non-pyrogenic
- The flash back chamber allows a visual image of the blood flow
- Triple point needle for easy and painless skin perforation
- Wings designed for an easy grasp
- Needle is covered in order to prevent any damage
- Has a luer lock plug
- Features an injection port
- Made for single use
- Color-coded in accordance to international standards
- CE marked

Product code	Size (FG)	Color	Inner pack quantity	Pieces per box
IV-018	18	Green	50	2000



IV CANNULAS | 20 FG

INTENDED USE

- Used to obtain venous access for IV fluid and medication administration

FEATURES

- ETO Sterilized
- Non-toxic and non-pyrogenic
- The flash back chamber allows a visual image of the blood flow
- Triple point needle for easy and painless skin perforation
- Wings designed for an easy grasp
- Needle is covered in order to prevent any damage
- Has a luer lock plug
- Features an injection port
- Made for single use
- Color-coded in accordance to international standards
- CE marked

Product code	Size (FG)	Color	Inner pack quantity	Pieces per box
IV-020	20	Pink	50	2000



IV CANNULAS | 22 FG

INTENDED USE

- Used to obtain venous access for IV fluid and medication administration

FEATURES

- ETO Sterilized
- Non-toxic and non-pyrogenic
- The flash back chamber allows a visual image of the blood flow
- Triple point needle for easy and painless skin perforation
- Wings designed for an easy grasp
- Needle is covered in order to prevent any damage
- Has a luer lock plug
- Features an injection port
- Made for single use
- Color-coded in accordance to international standards
- CE marked

Product code	Size (FG)	Color	Inner pack quantity	Pieces per box
IV-022	22	Blue	50	2000



IV CANNULAS | 24 FG

INTENDED USE

- Used to obtain venous access for IV fluid and medication administration

FEATURES

- ETO Sterilized
- Non-toxic and non-pyrogenic
- The flash back chamber allows a visual image of the blood flow
- Triple point needle for easy and painless skin perforation
- Wings designed for an easy grasp
- Needle is covered in order to prevent any damage
- Has a luer lock plug
- Features an injection port
- Made for single use
- Color-coded in accordance to international standards
- CE marked

Product code	Size (FG)	Color	Inner pack quantity	Pieces per box
IV-024	24	Yellow	50	2000



CATHETERS

Suction Catheters	74
2 way Foley Balloon Catheters	75
3 way Foley Balloon Catheters	76
Nelaton Catheters	76

09

CATHETERS



SUCTION CATHETERS

INTENDED USE

- Used for the removal of secretions from the trachea and bronchial tube, clearing the patient's airway thus helping him breathe properly

MATERIAL

- Manufactured using medical grade PVC tubes

FEATURES

- ETO sterilized
- Supplied with color coded funnel-shaped connector for easy identification of the size
- Individually packed in a flat sterile pouch
- Can be supplied with X-ray detectable material
- CE marked

Product code	Size (FG)	Color	Inner pack quantity	Pieces per box
SU-006	6	Dark teal	100	1000
SU-008	8	Blue	100	1000
SU-010	10	Black	100	1000
SU-012	12	White	100	1000
SU-014	14	Green	100	1000
SU-016	16	Orange	100	1000
SU-018	18	Red	100	1000
SU-020	20	Yellow	100	1000
SU-022	22	Violet	100	1000
SU-024	24	Blue	100	1000
SU-026	26	Pink	100	1000

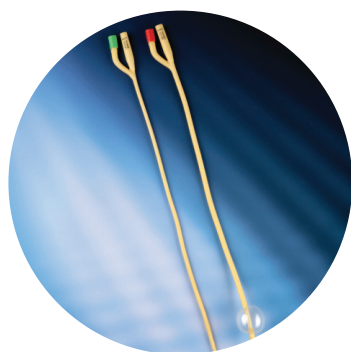

2 WAY FOLEY BALLOON CATHETERS

INTENDED USE

- Used for either short or long term urine drainage

MATERIAL

- Manufactured using natural latex rubber

FEATURES

- ETO sterilized
- Supplied with color-coded balloon ring
- Individually packed in flat sterilization pouches
- Smooth round shaft, minimizing trauma during insertion and withdrawal
- Soft and consistently inflated balloon makes the tube sit well on the bladder

Product code	Size (FG)	Color	Inner pack quantity	Pieces per box
FC-206	6	Dark teal	100	2000
FC-208	8	Blue	100	2000
FC-210	10	Black	100	2000
FC-212	12	White	100	2000
FC-214	14	Green	100	2000
FC-216	16	Orange	100	2000
FC-218	18	Red	100	2000
FC-220	20	Yellow	100	2000
FC-222	22	Violet	100	2000
FC-224	24	Blue	100	2000
FC-226	26	Pink	100	2000

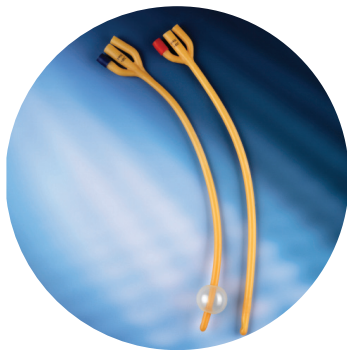

3 WAY FOLEY BALLOON CATHETERS

INTENDED USE

- Used for removing blood clots from the urinary bladder after prostate gland surgery, as well as the treatment and management of simple hematuria following disease or trauma

MATERIAL

- Manufactured using natural latex rubber

FEATURES

- ETO sterilized
- Supplied with color-coded balloon ring
- Individually packed in flat sterilization pouches
- Soft and consistently inflated balloon makes the tube sit well on the bladder

Product code	Size (FG)	Balloon Capacity (cc)	Color	Inner pack quantity	Pieces per box
FC-306	6	30-50	Dark teal	100	2000
FC-308	8	30-50	Blue	100	2000
FC-310	10	30-50	Black	100	2000
FC-312	12	30-50	White	100	2000
FC-314	14	30-50	Green	100	2000
FC-316	16	30-50	Orange	100	2000
FC-318	18	30-50	Red	100	2000
FC-320	20	30-50	Yellow	100	2000
FC-322	22	30-50	Violet	100	2000
FC-324	24	30-50	Blue	100	2000
FC-326	26	30-50	Pink	100	2000



NELATON CATHETERS

INTENDED USE

- Used for short-term urine drainage

MATERIAL

- Manufactured using non-toxic, non-irritant, medical grade PVC

FEATURES

- ETO sterilized
- Supplied with color-coded funnel-shaped connector for easy identification of the size and safe connection to the urine bag
- Individually packed in a flat sterile pouch
- CE marked

Product code	Size (FG)	Color	Inner pack quantity	Pieces per box
NC-006	6	Dark teal	100	2000
NC-008	8	Blue	100	2000
NC-010	10	Black	100	2000
NC-012	12	White	100	2000
NC-014	14	Green	100	2000
NC-016	16	Orange	100	2000
NC-018	18	Red	100	2000
NC-020	20	Yellow	100	2000