

NS500 Product Concept

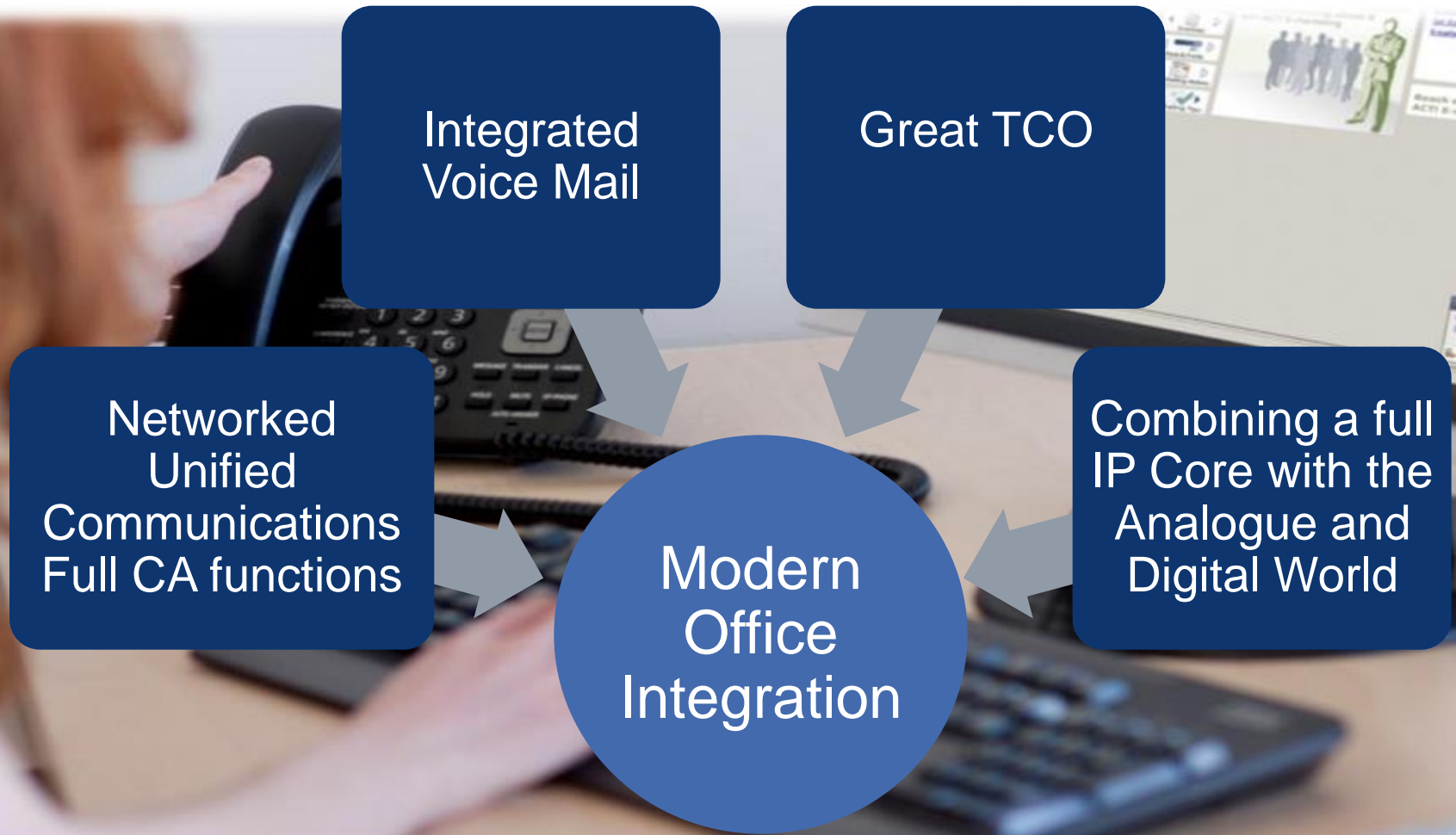

Product Concept NS500

The KX-NS500 is the successor to the TDA100/100D for the SMB Market



Smart Hybrid System

The KX-NS500 has sufficient capacity for both legacy and IP ports, and an activation key or expansion cabinet can be used to easily expand the system according to customer needs.

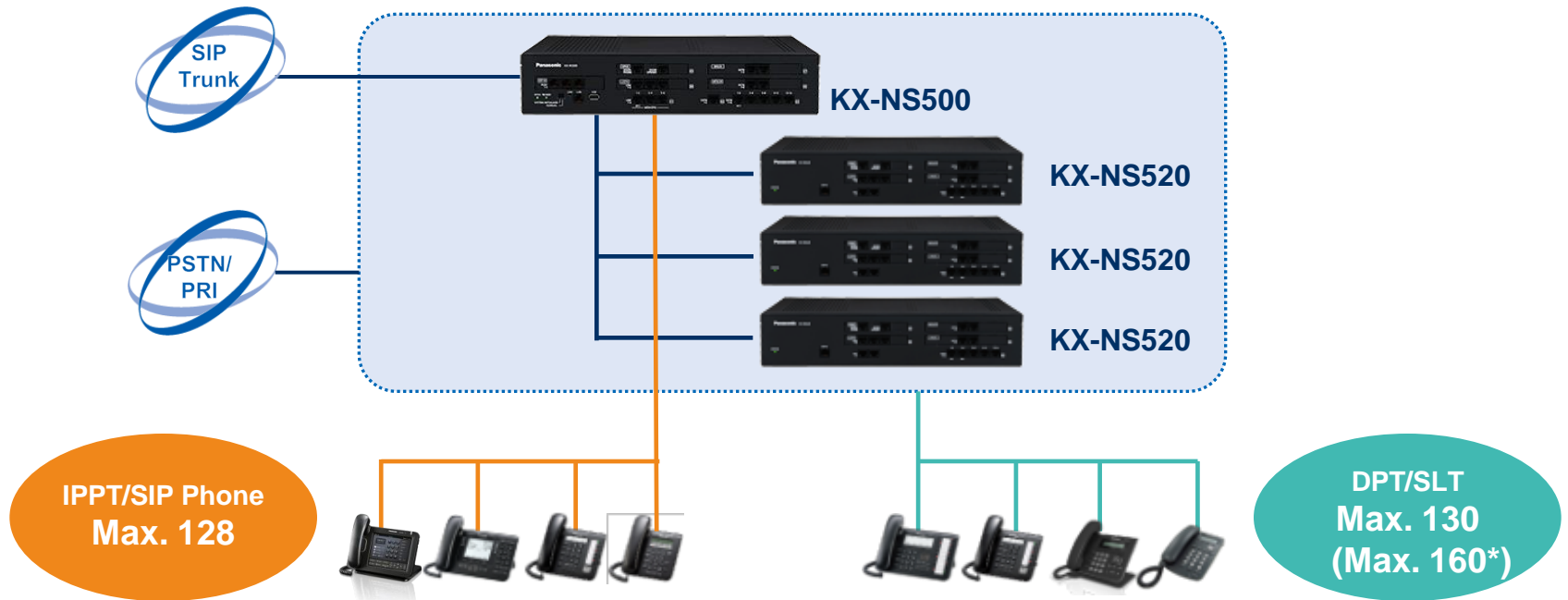

Maximum Trunks and Extensions

Types		Preinstalled	KX-NS500	With 1 KX-NS520	With 2 KX-NS520	With 3 KX-NS520
Legacy	Trunks	6 ch	36 ch	66 ch	96 ch	126 ch
	Extensions (DXDP*)	18	34 (40)	66 (80)	98 (120)	130 (160)
IP	Trunks	N/A	64 ch	64 ch	64 ch	64 ch
	Extensions	N/A	128	128	128	128

* When Digital XDP is used.

Preinstalled Activation Key

The following type and number of activation keys are preinstalled or come with a 60-days free trial on the mother board.

Smart Hybrid PBX KX-NS500



Preinstalled Activation Key

Free Activation Key

CA Basic-Express for all users

60-days free trial

Unified Messaging
(UM/E-mail Client/Message Backup/
Two-way Recording)

Mobile Extension

Communication Assistant
(CA PRO/CA Supervisor/CA Operator Console/CA Thin Client Server/CSTA Multiplexer)

3rd Party CTI interface

Call Centre Enhancement

Call Centre Solution

The KX-NS500 is designed to be used in call centre environments. Its built-in applications support the basic needs of supervisors at call center, such as Queue Announcement, Live Status Monitor, Activity Report, Automatic Conversation Recording, and NAS (Network Attached Storage).

Queue Announcement

“Four other people are waiting to connect”
 “And your estimated wait time is around 10 minutes.”

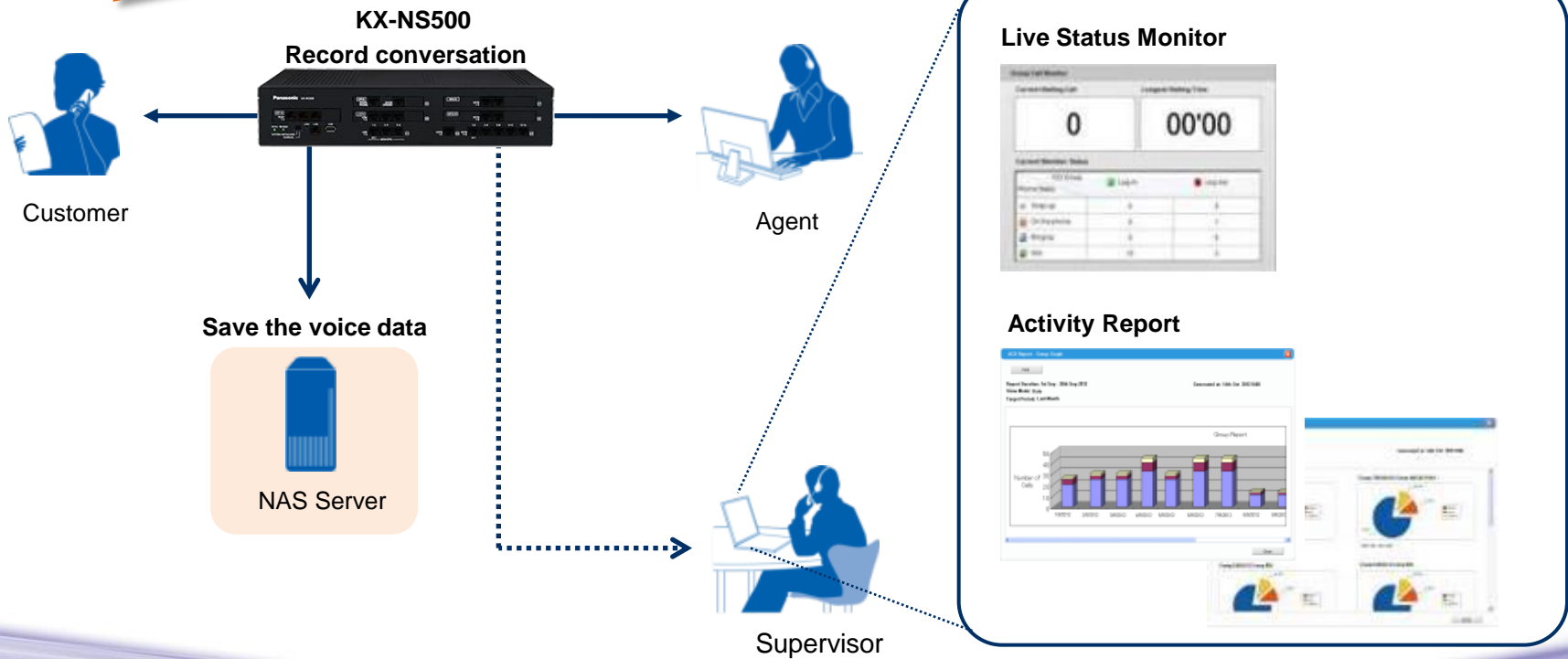

One Numbered Extension

Up to two extensions can be assigned the same extension number. For example, calls to an extension in the office can be received simultaneously on a softphone or a smartphone. Calls can also be switched between paired phones with a simple operation.

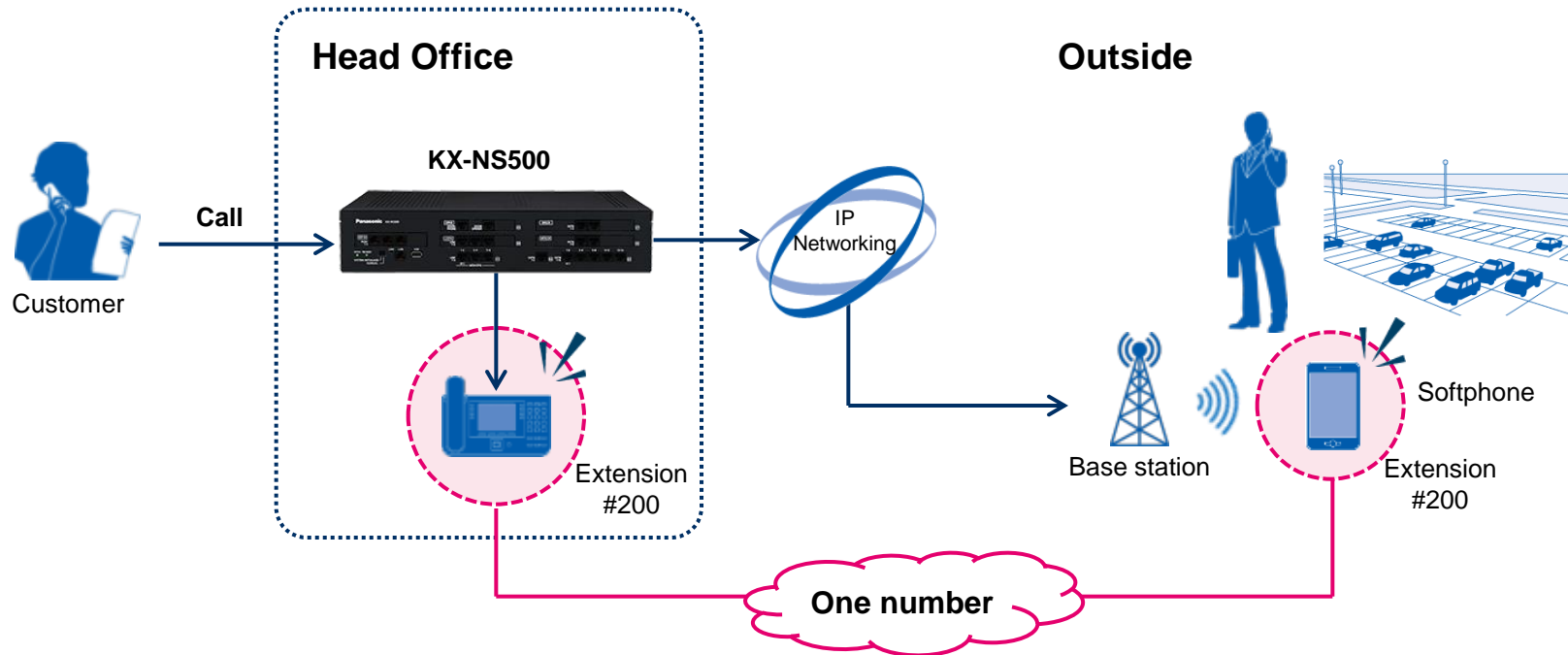

Simplified Maintenance

The installer can access KX-NS500 platforms using a web based console. Workloads are lighter than before with full maintenance functions, leading to reduced labor costs. Users can also use a web based console to configure terminals and the VM mailbox.

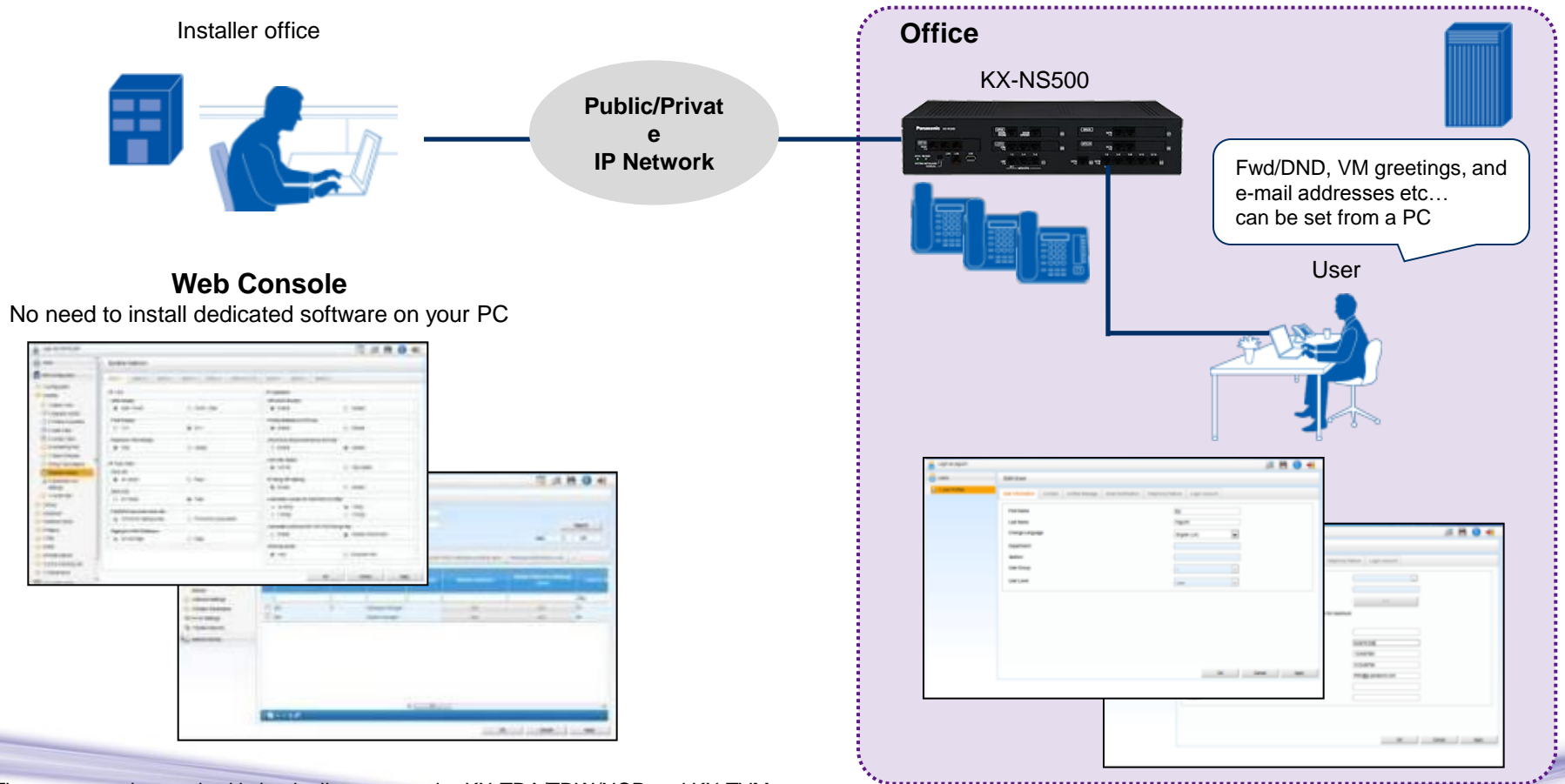

Installer office



Public/Private
IP Network

Office

KX-NS500



Fwd/DND, VM greetings, and e-mail addresses etc... can be set from a PC

User



Web Console

No need to install dedicated software on your PC

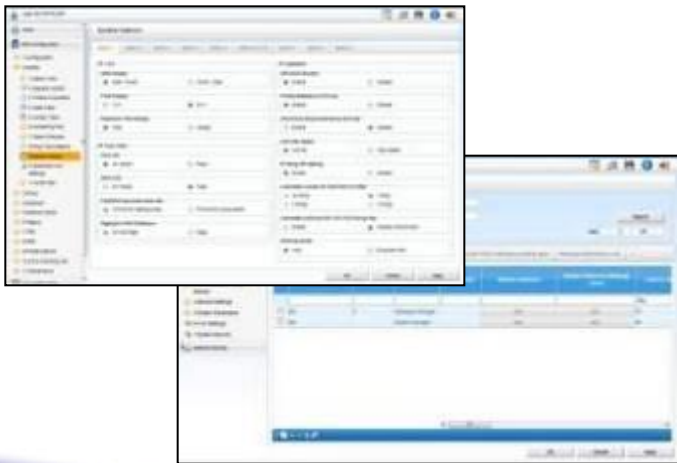

The programming method is basically same as the KX-TDA/TDW/NCP and KX-TVM. PTs programming is also available in the same way as the KX-TDA100D.

Built-in UC Server – Unified Communication



Built-in Voice Mail UC Server – Unified Communication

The KX-NS500 has a built-in messaging system that provides voice mail to subscribers. The Unified Messaging system can also provide voice guidance to outside callers, either directing them to their desired destination or to the mailbox of a subscriber, where they can leave a voice message.

Voice Mail Server



wav file



Built-in

UC Server

Communication Assistant



E-mail Notification Function

- Voice mail notification
- System alarm notification
- And more....

Smart Hybrid PBX KX-NS500





MS Outlook & IMAP4 Integration

- Microsoft Outlook plug-in
- IMAP4 protocol supported

Comparison with TDA/NCP/TDE Series

The KX-NS500 is more improved and varied than the KX-TDA/NCP/TDE series.

Model No.	KX-NS500 	KX-TDA100D 
Trunk Capacity	Legacy: Max 126 IP: Max 64	Legacy: Max 106
Extension Capacity	Legacy: Max 160 IP: Max 128	Legacy: Max 128 IP: Max 112
Voice Mail	Built-in VM functions (24ch/400h*)	Built-in ESVM
Maintenance	Web console/ Proprietary telephone	PC maintenance console/ Proprietary telephone
Eco Friendly	Eco mode (KX-UT/NT500 series), less power consumption compared to NCP/TDE	-

* To expand the channel up to 24 channel, you need to DSP , AK , replace the storage memory card.
 To expand the recording time up to 400 hours, you need to replace the storage memory card.

System Connection Diagram

Existing Equipment from Panasonic and Trunks can continue to be used, and the legacy capacity can easily be expanded simply by connecting an Expansion Cabinet.

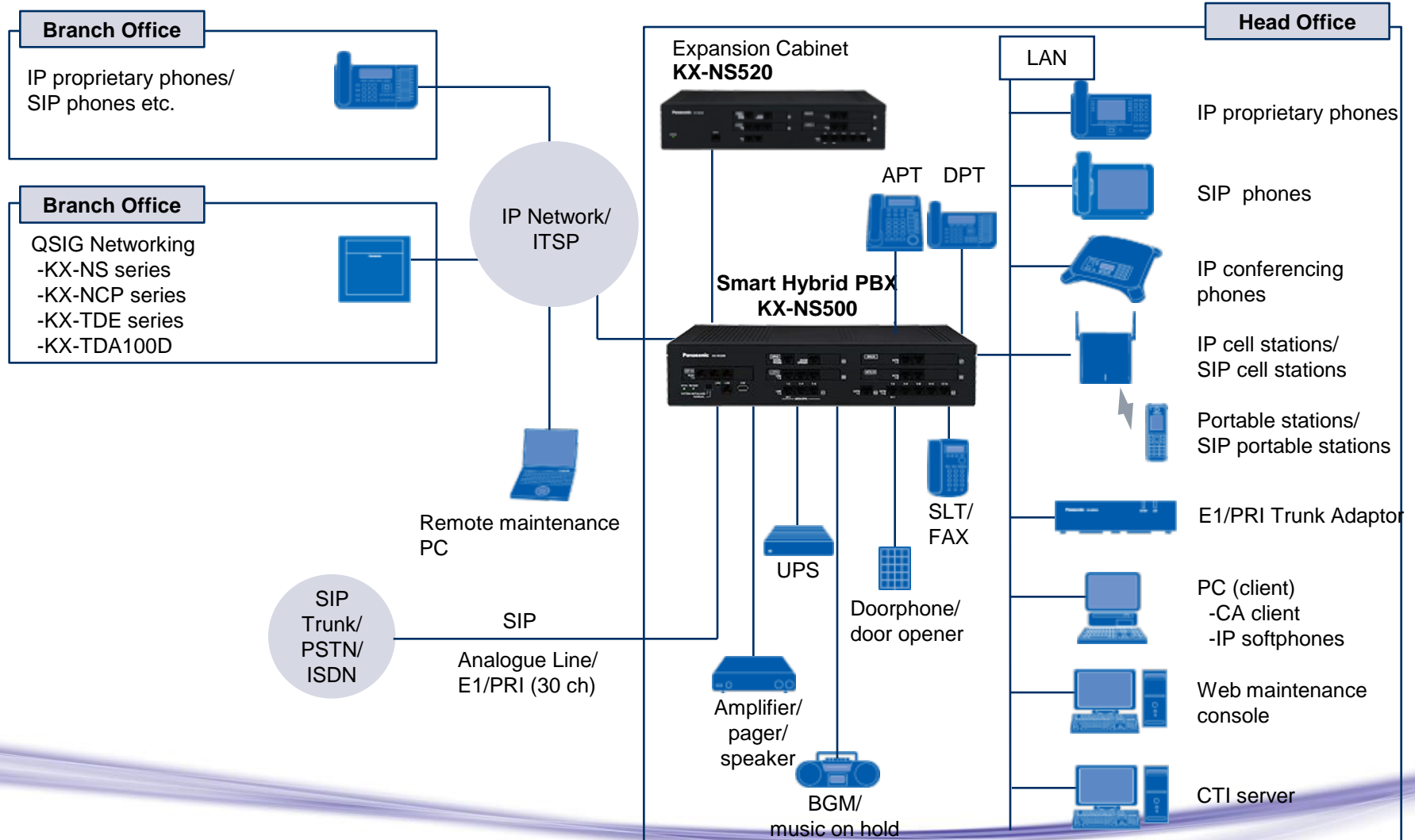

KX-NS500 Capacity

Maximum Terminal Equipment

Type	Preinstalled	KX-NS500	With 1 KX-NS520	With 2 KX-NS520	With 3 KX-NS520
Extensions (Legacy+IP) (DXDP*1)	18	162 (168)	194 (208)	226 (248)	258 (288)
Legacy (DXDP*1)	18 (20)	34 (40)	66 (80)	98 (120)	130 (160)
SLT	16	32	64	96	128
DPT (DXDP*1)	2 (4)	18 (24)	34 (48)	50 (72)	66 (96)
APT	N/A	8	16	24	32
IP	N/A	128			
IP-PT*2	N/A	128			
SIP*3	N/A	128			
CS	N/A	20	24	28	32
PT-interface CS (2ch) / (8ch)	2 / N/A	4 / 2	8 / 4	12 / 6	16 / 8
IP-CS/SIP-CS	N/A	16			
PS	128				
VM					
Built-in SVM (ch)	2				
Built-in UM	N/A	24			
TVM unit	2				
Doorphone	N/A	2	4	6	8
Door Opener	N/A	2	4	6	8
External Sensor	N/A	2	4	6	8

*1 When Digital XDP is used. *2 KX-NT500/300 Series, KX-NT265 (software version 2.0 or later only). *3 KX-UT Series, KX-NT700 and third party SIP phones (SIP hard phones/SIP softphones).

Product Lineup - Hardware

Main Unit KX-NS500

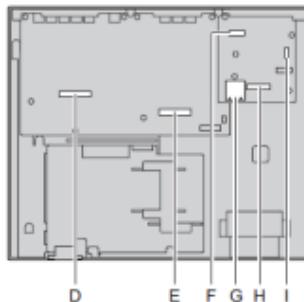
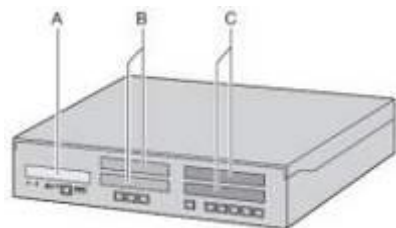

- A. Front cover plate for the EXP-M Slot
- B. Front cover plates for Trunk/Doorphone Card Slots
- C. Front cover plates for the Extension Card Slots
- D. Extension Card Slot
- E. Trunk/Doorphone Card Slot
- F. EXP-M Card Slot
- G. SD Card Slot
- H. DSP Card Slot
- I. RMT Card Slot

Component		Model	Description	Installed in
DSP	DSP S (63 resources)	KX-NS5110	VoIP DSP Card (S Type)	DSP Card Slot
	DSP M (127 resources)	KX-NS5111	VoIP DSP Card (M Type)	
	DSP L (254 resources)	KX-NS5112	VoIP DSP Card (L Type)	
Storage Memory For VM, ACD Report, SMDR expansion	XS (40 hours)	KX-NS5134	Storage Memory (XS Type)	Storage Memory Card Slot
	S (200 hours)	KX-NS5135	Storage Memory (S Type)	
	M (400 hours)	KX-NS5136	Storage Memory (M Type)	
Trunk	LCOT6	KX-NS5180	6-Port Analogue Trunk Card	Trunk Slot
	PRI30/E1	KX-NS5290CE	PRI30 / E1 Trunk Card	
	DPH2	KX-NS5162	Doorphone Interface Card	
Extension	DHLC4	KX-NS5170	4-Port Digital Hybrid Extension Card	Extension Slot
	DLC8	KX-NS5171	8-Port Digital Hybrid Extension Card	
	DLC16	KX-NS5172	16-Port Digital Hybrid Extension Card	
	MCSLC8	KX-NS5173	8-Port SLT Card	
	MCSLC16	KX-NS5174	16-Port SLT Card	
Expansion Master Card	EXP-M	KX-NS5130	3-ports Expansion Master Card	EXP-M Slot
Remote Modem	RMT	KX-TDA0196	Remote Modem Card	RMT Slot

KX-NS500 The Hybrid IP Solution

One Page Sales Point

Enough capacity by IP !
SIP for extension and trunk !

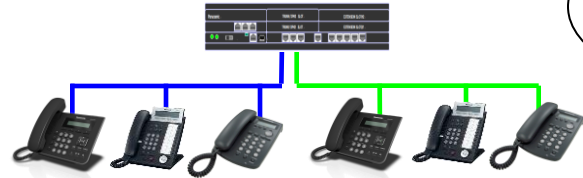

Digital Phone / SLT
Max.130
+ 30 by D-XDP

IP Phone
Max.128
Additionally

No need to buy other PBX again
to increase capacity in future

VoIP

Cost Saving

Business Improve

Smart Hybrid PBX



DISA for Automated Attendant w/o operator ! 2-ch DISA Built-in !

AA CTI

Full UC CTI functions!



Telephone Company

2-hour recording for DISA and Simple VM

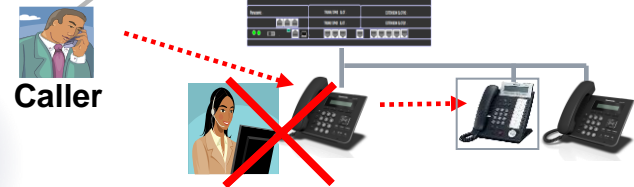

No need operator to transfer a call

Analog PT and old Digital PT connection
when PBX replacement !

PT

Cost Saving

Business Improve



No discard of your PT

VM, Recording and Call center feature by optional SD !

VM

Telephone Company

KX-TVM by SD



Supervisor can view recorded calls

New Terminals



Overview

Panasonic's full terminal line up from high end to low end provide various solutions to various types of businesses.

Smart Hybrid PBX KX-NS500



Digital Proprietary Telephone

- Full duplex speaker phone
- Supports EHS for wireless headsets



IP Proprietary Telephone

- Gigabit LAN/PC port
- PoE
- Full duplex speaker phone
- Supports EHS for wireless headsets



Wireless Terminals

- Multifunctional design
- Seamless communication while you move from place to place during a call



Digital Phone 'KX-DT5xx Series'

Lineup

For Executives/Supervisors

KX-DT546 with KX-DT590

- 6-Line Backlight LCD Display
- 24 Flexible CO Buttons
- Full Duplex Speakerphone
- Electronic Hook Switch
- Options:
KX-DT590 (Digital DSS console (48-Key))



For Standard Users

KX-DT543

- 3-Line Backlight LCD Display
- 24 Flexible CO Buttons
- Full Duplex Speakerphone
- Electronic Hook Switch
- Options:
KX-DT590 (Digital DSS console (48-Key))



For Simple Users

KX-DT521

- 1-Line Backlight LCD Display
- 8 Flexible CO Buttons
- Full Duplex Speakerphone
- Options:
KX-DT590 (Digital DSS console (48-Key))



A white model
is available
for each phone

Digital Phone 'KX-DT5xx Series'

KX-DT500 Terminals

The new terminals combine the functions of the KX-DT300 with new requirements from the market.

All Terminals available in black and white



KX-DT521
Business Phone



KX-DT543
Advanced Phone



KX-DT546
Advanced Phone

Digital Phone 'KX-DT5xx Series'

Features

High Audio Quality

Full Duplex Speakerphone

The speakerphone supports “full duplex”, enabling both parties to speak at the same time without their voice getting cut out.

Advanced speaker design

Speakers enhance the characteristics of low frequencies and contain a high performance D-class audio amp.

Larger acoustic chamber

The acoustic chamber reduces echo and vibration from the speaker.

Hands free communication

Electronic Hook Switch (EHS) supported (KX-DT546/KX-DT543)

By connecting an EHS headset, you can perform wireless communication.

Easy to Use Design

Small footprint reduces desk space

Longer handset curly cord



IP Phone 'KX-NT5xx Series'

Lineup

For Executives/Supervisors

KX-NT560

- 4.4 inch Backlight LCD Display
- 4 x 8 Self Labelling, Flexible CO Buttons
- 2 Giga Ethernet Ports (10/100/1000M)
- PoE
- Full Duplex Speakerphone
- Electronic Hook Switch
- Built-in Bluetooth Module
- Eco Mode



For Simple Users

KX-NT551

- 1-Line Backlight LCD Display
- 8 Flexible CO Buttons
- 2 Ethernet Ports (10/100/1000M)
- Full Duplex Speakerphone
- PoE
- Eco Mode



A white model
is available
for each phone

For Standard Users

KX-NT556/KX-NT553 with KX-NT505

- 6-Line Backlight LCD Display
(KX-NT553: 3-Line)
- 12 x 3 Self Labelling, Flexible CO Buttons
(KX-NT553: 12 x 2)
- 2 Ethernet Ports (10/100/1000M)
- PoE
- Full Duplex Speakerphone
- Electronic Hook Switch
- Eco Mode
- Options: KX-NT505 (Add on 48 key module)



KX-NT546/KX-NT543

- 6-Line Backlight LCD Display
(KX-NT543: 3-Line)
- 24 Flexible CO Buttons
- 2 Ethernet Ports (10/100M)
- PoE
- Speakerphone
- Electronic Hook Switch
- Eco Mode



Digital Phone 'KX-NT5xx Series'

KX-NT500 Terminals

The new terminals combine the functions of the KX-NT300 with new requirements from the market.

All Terminals available in black and white



KX-NT551
Standard Phone

KX-NT543
Business Phone

KX-NT546
Business Phone

Digital Phone 'KX-NT5xx Series'

KX-NT500 Terminals

The new terminals combine the functions of the KX-NT300 with new requirements from the market.

All Terminals available in black and white



KX-NT553
Business Phone



KX-NT556
Advanced Phone



KX-NT560
Advanced Phone

IP Phone 'KX-NT5xx Series'

Features

High Audio Quality

Full Duplex Speakerphone (KX-NT560/KX-NT55x Series/KX-NT511)

The speakerphone supports "full duplex", enabling both parties to speak at the same time without their voice getting cut out.

Supports the G.722 codec

G.722 codec provides calls with high quality and reduced stress.

Advanced speaker design

Speakers enhance the characteristics of low frequencies and contain a high performance D-class audio amp.

Larger acoustic chamber

The acoustic chamber reduces echo and vibration from the speaker.

Hands free communication

Built-in Bluetooth (KX-NT560 only)

Bluetooth for wireless calls using a supported headset.

Electronic Hook Switch (EHS) supported (Except for KX-NT551/KX-NT511)

By connecting an EHS headset, you can perform wireless communication.



IP Phone 'KX-NT5xx Series'

Features

High Speed Communication

Supports Gigabit Ethernet (not KX-NT546/KX-NT543)

Enables high-speed data transfer.

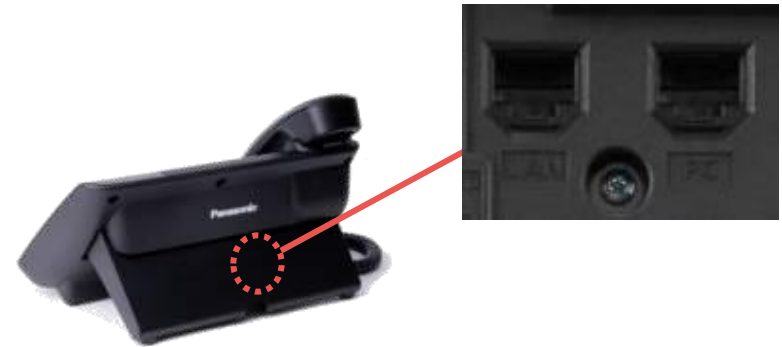

Easy to Use Design

Paper Label Free (KX-NT560/KX-NT556/KX-NT553)

Since the numbers are displayed on the screen, a paper label is not required.



Paper label free

Small footprint reduces desk space

Longer handset curly cord



Small footprint

Longer handset curly cord

Wireless Terminal



Wireless Terminal

Lineup

Standard Model

KX-TCA185



Slim & Light Model

KX-TCA285



IP65* Tough Type Model

KX-TCA385



- Noise Reduction
- Built in Bluetooth Headset interface (KX-TCA285/KX-TCA385)
- DECT Paging
- DECT for CTI
- Wireless XDP Parallel Function



*IP65 compliant: Protection against dust entering the handset, and protection against water spraying from any direction.

Wireless Terminal

Lineup

KX-TCA185



KX-TCA285



KX-TCA385



1

Full Duplex SP phone

2

Noise Reduction

3

Application Integration

4

Industry Thinnest and Rightest Body

KX-TCA385

5

Bluetooth

KX-TCA285/385

6

IP65

KX-TCA385

7

Robustness Body (IEC60068-2-32)

KX-TCA385

Wireless Terminal

Panasonic's full terminal line up from high end to low end provide various solutions to various types of businesses.

KX-TCA185 – Entry DECT Handset

- 1.8" Color Display
- 2.5mm Headset
- Noise Reduction
- 500 Phonebook Entries
- Up to 8h talktime



Wireless Terminal

Panasonic's full terminal line up from high end to low end provide various solutions to various types of businesses.

TCA285 – Comfort DECT Handset

- 1.8" Color Display
- 2.5mm Headset Socket
- Noise Reduction
- 500 Phonebook Entries
- Up to 10h talktime
- Vibration
- Bluetooth



Wireless Terminal

Panasonic's full terminal line up from high end to low end provide various solutions to various types of businesses.

KX-TCA385 – Industry DECT Handset

- IP65 Compliant
- 1.8" Color Display
- Noise Reduction
- 500 Phonebook Entries
- Up to 10h talktime
- Vibration
- Bluetooth



NS500 IP-Communication server

Panasonic NS500 IP Communication Server, always the right choice!



Wireless Mobility

Smart Hybrid PBX KX-NS500



**Full CA Integration
(MS Outlook)**



IP Enabled UT + NT5xx Series



**Design & Functionality & Price
New DT5xx series**