

“Güven & Kalite”  
“Trust & Quality”  
Sécurité et qualité  
Безопасность и качество



**ALMI**

**MEDİKAL ve ÖZEL SAĞLIK  
HİZMETLERİ TİC. LTD. ŞTİ.**

**Ofis:**

Gavremoğlu Mh. Nuh Naci Bey  
Cd. Hukukcular İş Mrkz. Kat 8  
No:31 KAYSERİ

T: (352) 222 88 46  
F: (352) 222 88 71

**Fabrika:**

Anbar Mh. Demirciler San. Sit. 22  
Cd. No:15 KAYSERİ

T: (+90 352) 311 30 75  
F: (+90 352) 311 30 85

www.almedmedikal.com  
almi@almedmedikal.com



**ALMI**

**Steril Tek Kullanımlık Cerrahi Örtü, Önlük ve Setler**

Sterile Disposable Surgical Drape, Gowns and Sets  
Jetable Drapage opératoire et casaques chirurgicales  
разполагам Покривало, Хирургична И СЕТ

## HAKKIMIZDA

Biz ALMİ MEDİKAL ve ÖZEL SAĞLIK HİZMETLERİ LTD. ŞTİ. olarak bütün bu düşüncelerden hareketle tek kullanımlık tekstil tıbbi malzemeleri en iyi şartlarda ALMED ticari markasıyla üreten bir firma olarak faaliyetlerimizi sürdürmekteyiz. Misyonumuz; “her zaman üretimde en iyi kaliteyi sağlamak ana ilkemizdir”.

Vizyonumuz; “Dünya da tercih edilen firma olmaktır”.

Amacımız her zaman insan sağlığını enfeksiyon tehlikelerinden koruyan üretimleri yapmak olacaktır. Biz inanıyoruz ki birgün her hastane ALMED markalı ürününü kullanacaktır.





### /ABOUT US

We ALMİ Co. Ltd. is the manufacturer of disposable medical textile products, by our registered ALMED trade mark in TURKEY. Our mission is “Best quality on the production is our main principle in every time”. Our vision is “Be on the preferable company in the world”.

Every time our object will be produced the materials that prevent of the human healthy against to infections hazards. We believe that one day every hospitals use ALMED disposable textile product.



## İÇİNDEKİLER /INDEX

S	ÜRÜN ADI 	PRODUCT NAME 	NOM DU PRODUIT 	КАТАЛОГ НА ИМЕ 	Sayfa/Page No:
1	GENEL CERRAHİ ÖRTÜ SETİ	GENERAL SURGICAL PACK	TROUSSE DE CHIRURGIE GÉNÉRALE	СЕТ ЗА ОБЩА ХИРУРГИЯ	4
2	GENEL CERRAHİ ÖRTÜ SETİ -B-	GENERAL SURGICAL PACK -B-	TROUSSE DE CHIRURGIE GÉNÉRALE -B-	СЕТ ЗА ОБЩА ХИРУРГИЯ -B-	5
3	LAPAROSKOPİ ÖRTÜ SETİ	LAPAROSCOPY PACK	TROUSSE DE LAPAROSCOPIE	СЕТ ЗА ЛАПАРОСКОПСКА ХИРУРГИЯ	6
4	MINOR CERRAHİ ÖRTÜ SETİ	MINORSURGICAL PACK	TROUSSE UNIVERSELLE MINEUR	СЕТ ЗА МАЛКА ХИРУРГИЯ	7
5	MINOR CERRAHİ ÖRTÜ SETİ -B-	MINORSURGICAL PACK -B-	TROUSSE UNIVERSELLE MINEUR -B-	СЕТ ЗА МАЛКА ХИРУРГИЯ -B-	8
6	PANSUMAN ÖRTÜ SETİ	DRESSING PACK	TROUSSE DE PANSEMENT	СЕТ ЗА ПРЕВРЪЗКА	9
7	ARTROSKOPİ ÖRTÜ SETİ	ARTHROSCOPY DRAPE SET	TROUSSE D'ARTHROSCOPIE	СЕТ ЗА АРТРОСКОПИЯ	10
8	ARTROSKOPİ ÖRTÜ SETİ (POSSUZ) -B-	ARTHROSCOPY DRAPE SET -B-	TROUSSE D'ARTHROSCOPIE -B-	СЕТ ЗА АРТРОСКОПИЯ БЕЗ ТОРБА	11
9	EXTREMİTE ÖRTÜ SETİ	EXTREMITY PACK	TROUSSE D'EXTREMİTE	СЕТ ЗА ОПЕРАЦИИ НА КОЛЯНИ И РАМЕННА СТАБА	12
10	ALT EXTREMİTE (DİZ) ÖRTÜ SETİ	UNDER EXTREMITY PACK	GENOU TROUSSE D'EXTREMİTE	ГОРНО ПОКРИВАЛО ЗА КРАЙ	13
11	ÜST EXTREMİTE (OMUZ) ÖRTÜ SETİ	TOP EXTREMITY PACK	ÉPAULE TROUSSE D'EXTREMİTE	ДОЛНО ПОКРИВАЛО ЗА КРАЙ	14
12	KALÇA ÖRTÜ SETİ	HIP DRAPE SET	TROUSSE DE HANCHE	СЕТ ЗА АРТРОПЛАСТИКА НА ТАЗОБЕДРЕНА СТАБА	15
13	EL CERRAHİ ÖRTÜ SETİ	HAND SURGERY DRAPE SET	TROUSSE DE CHIRURGIE DE LA MAIN	СЕТ ЗА ХИРУРГИЯ НА РЪКАТА	16
14	ANJİOGRAFİ ÖRTÜ SETİ	ANGIOGRAPHY DRAPE SET	TOUSSE D'ANGIOGRAPHIEA	СЕТ ЗА АНГИОГРАФСКИ	17
15	BY-PASS ÖRTÜ SETİ	BY-PASS DRAPE SET	TROUSSE DE BY-PASS	СЕТ ЗА БАЙ ПАС ОПЕРАЦИИ	18
16	KAPAK DEĞİŞİM ÖRTÜ SETİ	VALVE RPLACEMENT DRAPE SET	TROUSSE LE REMPLACEMENT VALVULAIRE	СЕТ ЗА КЛАПНО ПРОТЕЗИРАНЕ	19
17	KARDİOVASKÜLER ÖRTÜ SETİ	CARDIOVASCULER DRAPE SET	CHAMPS CARDIO-VASCULAIRES	СЕТ ЗА КАРДИОВАСКУЛАРНА ОПЕРАЦИЯ	20
18	DOĞUM ÖRTÜ SETİ	DELIVERY DRAPE SET	TROUSSE DÉLIVRAISON	СЕТ ЗА РАЖДАНЕ	21
19	I. V. F. ÖRTÜ SETİ	I. V. F. DRAPE SET	TROUSSE DE I.V.F.	СЕТ ЗА ИН ВИТРО	22
20	SEZARYAN ÖRTÜ SETİ	CAESAREAN DRAPE SET	TROUSSE DE CÉSARIENNE	СЕТ ЗА ЦЕЗАРОВО СЕЧЕНИЕ	23
21	QUART ÖRTÜ SETİ	QUART DRAPE SET	TROUSSE DE QUART	СЕТ ЗА ЦЕЗАРОВО СЕЧЕНИЕ	23
22	O. P. U. ÖRTÜ SETİ	O. P. U. DRAPE SET	TROUSSE DE O.P.U	СЕТ ЗА ИН ВИТРО О.Р.У.	24
23	KARANIOTOMİ ÖRTÜ SETİ	CRANIOTOMY DRAPE SET	TORUSSE DE CRANIOTOMIE	СЕТ ЗА НЕВРОХИРУРГИЯ	25
24	SPİNAL ÖRTÜ SETİ	SPINAL DRAPE SET	TROUSSE DE SPINAL	СЕТ ЗА СПИНАЛНА ХИРУРГИЯ	26
25	GÖZ ÖRTÜ SETİ-1	EYE DRAPE SET-1	TROUSSE DE SPINAL	СЕТ ЗА СПИНАЛНА ХИРУРГИЯ	27
26	LAZER GÖZ ÖRTÜ SETİ	LASER EYE DRAPE SET	CHIRURGIE GENERALE SET	СЕТ ЗА ЛАЗЕР НА ОКОТОТО	27
27	GÖZ ÖRTÜ SETİ-2	EYE DRAPE SET-2	TROUSSE AVEC AIRE À INCISER ET POCHÉ DE RECUEIL (DEUX)	СЕТ ЗА ОЧНИ ОПЕРАЦИИ-2	28
28	T. U. R. ÖRTÜ SETİ	T. U. R. DRAPE SET	TROUSSE DE T.U.R.	СЕТ ЗА Т.У.Р.	29
29	SİSTOSKOPİ ÖRTÜ SETİ	CYSTOSCOPY DRAPE SET	TROUSSE DE CYSTOSCOPIE	СЕТ ЗА ЦИСТОСКОПИЯ	30
30	KEMOTERAPİ ÖRTÜ SETİ	CHEMOTHERAPY DRAPE SET	TROUSSE DE CHIMIOTHÉRAPIE	СЕТ ЗА ХИМИОТЕРАПИЯ	31
31	BIOPSI (TESE) ÖRTÜ SETİ	BIOPSY (TESE) DRAPE SET	TROUSSE DE BIOPSIE	СЕТ ЗА БИОПСИЯ	32
32	K. B. B. ÖRTÜ SETİ	E. N. T. DRAPE SET	TROUSSE DE E.N.T.	СЕТ ЗА УНГ	33
33	TROİD ÖRTÜ SETİ	THYROID DRAPE SET	TROUSSE DE THYROÏDE	СЕТ ЗА ОПЕРАЦИЯ НА ЩИТОВИДНАТА ЖЛЕЗА	34
34	DİŞ ÖRTÜ SETİ	DENTAL DRAPE SET	TROUSSE DE DENTAIRE	СЕТ ЗА ДЕНТАЛНА ХИРУРГИЯ	35
35	İMLANT ÖRTÜ SETİ	IMPLANT DRAPE SET	TROUSSE DE İMLANT	СЕТ ЗА ПОСТАВЯНЕ НА İMLANT	36
36	PERKÛTAN ÖRTÜ SETİ	PERCUTANEUS PACK	TROUSSE DE PERCUTANÉE	СЕТ ЗА ПЕРКУТАННА ПУНКЦИЯ	37
37	JİNEKOLOJİ ÖRTÜ SETİ	GYNAECOLOGY PACK	TROUSSE DE GYNÉCOLOGIE	СЕТ ЗА ГИНЕКОЛОГИЯ	38
38	JİNEKOLOJİ ÖRTÜ SETİ (POŞLU)	GYNAECOLOGY PACK 2	TROUSSE DE GYNÉCOLOGIE SANS POCHÉ DE RECUEIL	СЕТ ЗА ГИНЕКОЛОГИЯ	39
39	SHUNT ÖRTÜ SETİ	SHUNT PACK	TORUSSE DE SHUNT	СЕТ ЗА МОЗЪЧНА ОПЕРАЦИЯ	40
40	OMUZ ÖRTÜ SETİ	SHOULDER PACK	TROUSSE DE ÉPAULE	СЕТ ЗА ОПЕРАЦИЯ НА РАМЕННА СТАБА	41
41	VERTEBRA ÖRTÜ SETİ	VERTEBRA PACK	TROUSSE DE VERTÈBRE	СЕТ ЗА ВЕРТЕБРАЛНА ХИРУРГИЯ	42
42	ABDOMİNAL ÖRTÜ SETİ	ABDOMINAL PACK SET	TROUSSE DE ABDOMINAL	СЕТ ЗА АБОМИНАЛНА ХИРУРГИЯ	43
43	ANJİOGRAFİ ÖRTÜ SETİ -B-	ANGIOGRAPHY DRAPE SET -B-	TOUSSE D'ANGIOGRAPHIEA -B-	СЕТ ЗА АНГИОГРАФСКИ	44
44	AKSESUARLAR	ACCESSORIES	ACCESSOIRES	АКСЕСОАРИ	45

## GENEL CERRAHİ ÖRTÜ SETİ

GENERAL SURGICAL PACK  
CHIRURGIE GENERALE SET  
ОБЩИЕ НАСТР ХИРУРГИЯ

3A010100

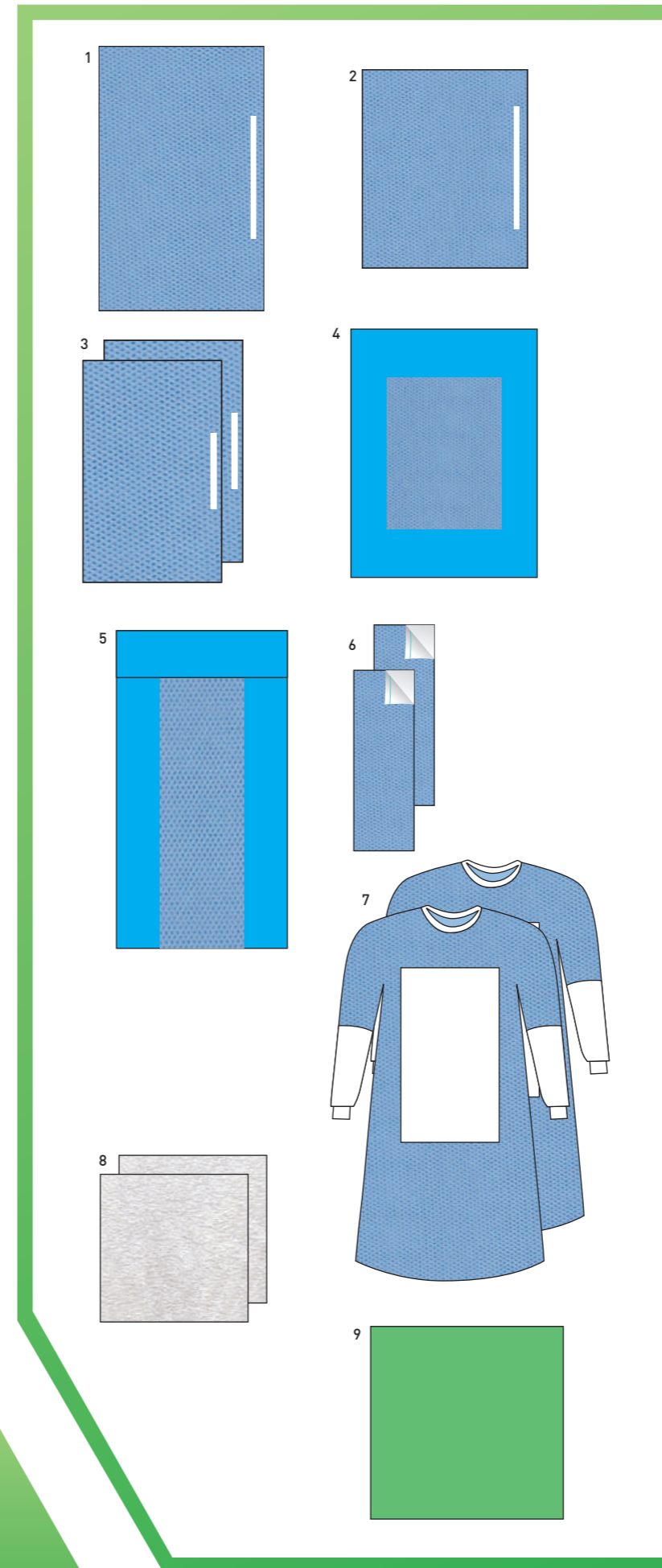

	Açıklama	Ebat	Adet
1	Anestezi Örtüsü	150x240 cm	1
2	Ayak Örtüsü	150x180 cm	1
3	Yan Bantlı Örtüsü	75x120 cm	2
4	Alet Masa Örtüsü PE/NW	150x200 cm	1
5	Mayo Masa Örtüsü PE/NW	78x145 cm	1
6	Yapışkan Bant	10x30 cm	2
7	Cerrahi Önlük	Korumalı	2
8	Medikal Havlu	40x40 cm	2
9	Sterilizasyon Bohçası	100x100 cm	1

	Description	Size	Pieces
1	Anesthesia Drape	150x240 cm	1
2	Leg Drape	150x180 cm	1
3	Drape With Adhesive	75x120 cm	2
4	Back Table Drape Pe/nw	150x200 cm	1
5	Mayo Stand Cover Pe/nw	78x145 cm	1
6	Op — Tape	10x30 cm	2
7	Surgical Gown	Reinforced	2
8	Medikal Towel	40x40 cm	2
9	Sterilization Wrap	100x100 cm	1

	Explication	Taille	Pcs
1	Champ adhésif	150x240 cm	1
2	Champ adhésif	150x180 cm	1
3	Champ adhésif	75x120 cm	2
4	Champ de table PE/NW	150x200 cm	1
5	Housse de Mayo PE/NW	78x145 cm	1
6	Bandelette adhésive	10x30 cm	2
7	Casaques chirurgicales	Renforcées	2
8	Essuie-mains	40x40 cm	2
9	Enveloppe de stérilisation	100x100 cm	1

	Описание	Размер	Зърно
1	Покривало за анестезия	150x240 cm	1
2	Покривало за краката	150x180 cm	1
3	Покривало с адхезия	75x120 cm	2
4	Покривало за масата PE/ NM	150x200 cm	1
5	Покривало за надоперационната масижа PE/ NM	78x145 cm	1
6	Лепяща лента	10x30 cm	2
7	Хирургична престилка	Защитена	2
8	Медицински кърпи	40x40 cm	2
9	Стерилизация пакет	100x100 cm	1

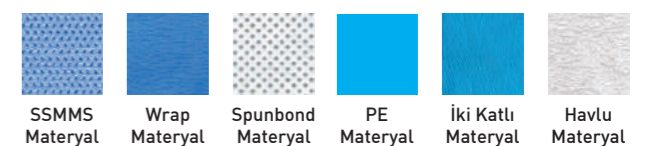

## GENEL CERRAHİ ÖRTÜ SETİ -B-

GENERAL SURGICAL PACK -B-  
TROUSSE DE CHIRURGIE GÉNÉRALE  
СЕТ ЗА ОБЩА ХИРУРГИЯ -B

3A010100-B

№	Açıklama	Ebat	Adet
1	Anestezi Örtüsü	150x240 cm	1
2	Ayak Örtüsü	150x180 cm	1
3	Yan Bantlı Örtüsü	75x120 cm	2
4	Alet Masa Örtüsü PE/NW	150x200 cm	1
5	Mayo Masa Örtüsü PE/NW	78x145 cm	1
6	Yapışkan Bant	10x30 cm	2

№	Description	Size	Pieces
1	Anesthesia Drape	150x240 cm	1
2	Leg Drape	150x180 cm	1
3	Drape With Adhesive	75x120 cm	2
4	Back Table Drape Pe/nw	150x200 cm	1
5	Mayo Stand Cover Pe/nw	78x145 cm	1
6	Op – Tape	10x30 cm	2

№	Açıklama	Taille	Pcs
1	Champ adhésif	150x240 cm	1
2	Champ adhésif	150x180 cm	1
3	Champ adhésif	75x120 cm	2
4	Champ de table	150x200 cm	1
5	Housse de Mayo	78x145 cm	1
6	Bandelette adhésive	10x30 cm	2

№	Описание	Размер	Зърно
1	Покривало за анестезия	150x240 cm	1
2	Покривало за краката	150x180 cm	1
3	Покривало с адхезия	75x120 cm	2
4	Покривало за масата PE/ NW	150x200 cm	1
5	Покривало за надоперационната масичка PE/ NW	78x145 cm	1
6	Лепяща лента	10x30 cm	2

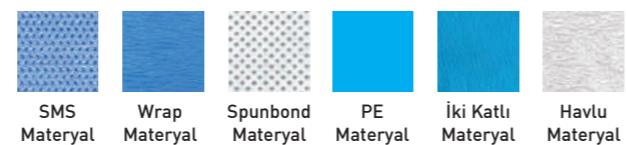

## LAPAROSKOPI ÖRTÜ SETİ

LAPAROSCOPY PACK  
TROUSSE DE LAPAROSCOPIE  
СЕТ ЗА ЛАПАРОСКОПСКА ХИРУРГИЯ

3A010400

№	Açıklama	Ebat	Adet
1	Laparoskopi Örtüsü	250x300 cm	1
2	Alet Masa Örtüsü PE/NW	150x200 cm	1
3	Mayo Masa Örtüsü PE/NW	78x145 cm	2
4	Yapışkan Bant	10x30 cm	2
5	Cerrahi Önlük	Korumalı	2
6	Medikal Havlu	40x40 cm	2
7	Sterilizasyon Bohçası	100x100 cm	1

№	Description	Size	Pieces
1	Laparoscopy Drape	250x300 cm	1
2	Back Table Drape PE/NW	150x200 cm	1
3	Mayo Stand Cover PE/NW	78x145 cm	2
4	Op – Tape	10x30 cm	2
5	Surgical Gown	Reinforced	2
6	Medical Towel	40x40 cm	2
7	Sterilization Wrap	100x100 cm	1

№	Explication	Taille	Pcs
1	Champ de laparoscopie	250x300 cm	1
2	Champ de table PE/NW	150x200 cm	1
3	Housse de Mayo PE/NW	78x145 cm	2
4	Bandelette adhésive	10x30 cm	2
5	Casaques chirurgicales	Renforcées	2
6	Essuie-mains	40x40 cm	2
7	Enveloppe de stérilisation	100x100 cm	1

№	Описание	Размер	Зърно
1	Лапароскопско покривало	250x300 cm	1
2	Покривало за хирургичната маса	150x200 cm	1
3	Покривало за над операционната масичка PE/ NW	78x145 cm	2
4	Лепяща лента	10x30 cm	2
5	Хирургична престилка	защитени	2
6	Медицинска кърпа	40x40 cm	2
7	Стерилизация пакет	100x100 cm	1

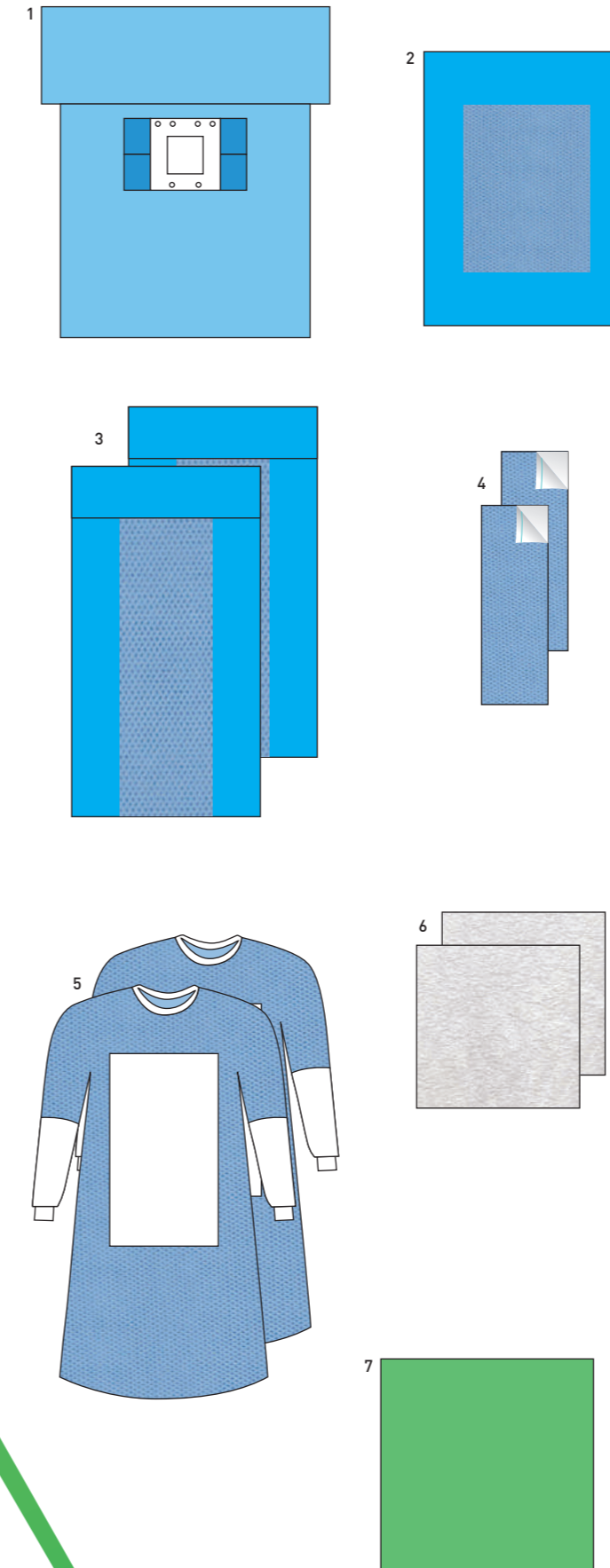
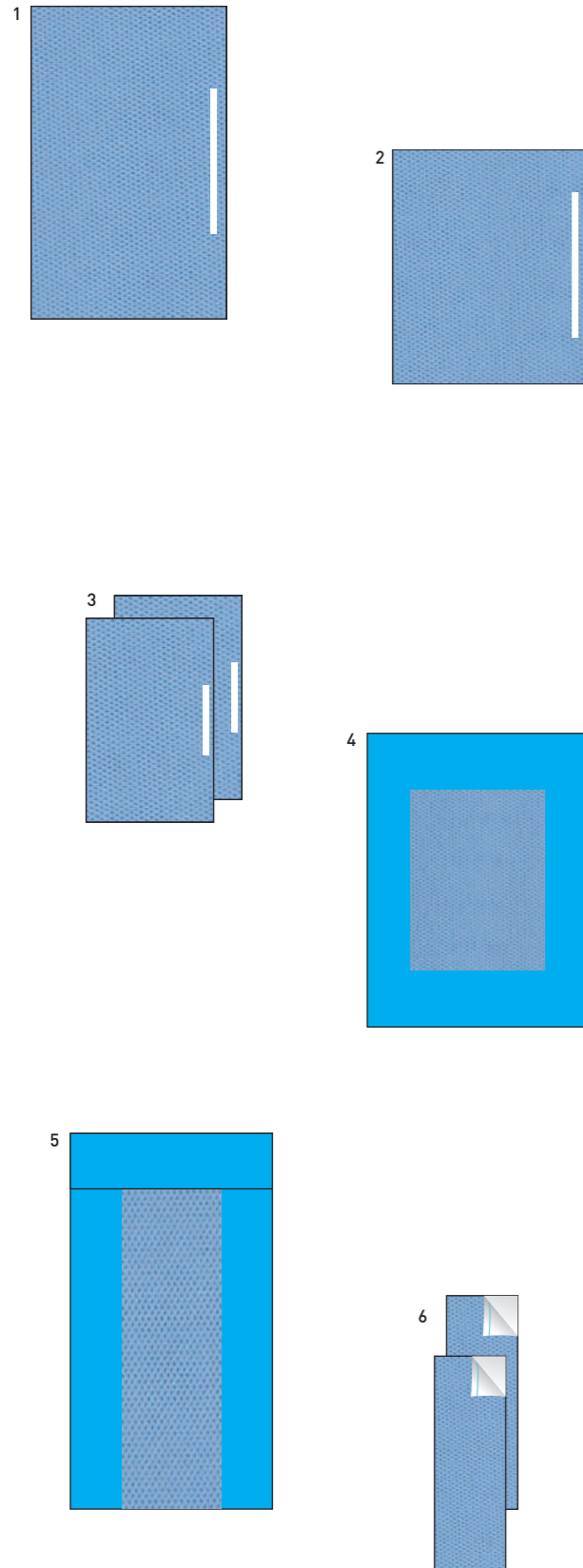
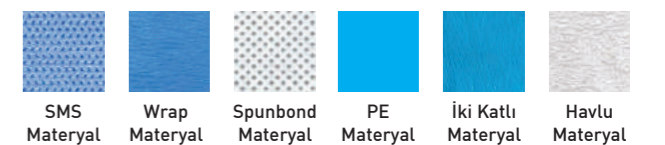

## MİNÖR CERRAHİ ÖRTÜ SETİ

MINOR SURGICAL PACK  
TROUSSE UNIVERSELLE MINEUR  
СЕТ ЗА МАЛКА ХИРУРГИЯ

3A010500

Açıklama	Ebat	Adet
1 -U- Örtü Seti	200x260 cm	1
2 Yan Bantlı Örtü	150x240 cm	1
3 Düz Örtü	150x180 cm	1
4 Alet Masa Örtüsü PE/NW	150x200 cm	1
5 Yapışkan Bant	10x30 cm	1
6 Cerrahi Önlük	Korumalı	2
7 Medikal Havlu	40x40 cm	2
8 Sterilizasyon Bohçası	100x100 cm	1

Description	Size	Pieces
1 U Drape	200x260 cm	1
2 Drape With Adhesive	150x240 cm	1
3 Drape	150x180 cm	1
4 Back Table Drape PE/NW	150x200 cm	1
5 Op - Tape	10x30 cm	1
6 Surgical Gown	Reinforced	2
7 Medical Towel	40x40 cm	2
8 Sterilization Wrap	100x100 cm	1

Explication	Taille	Pcs
1 Champ en U adhésif	200x260 cm	1
2 Champ adhésif	150x240 cm	1
3 Champ	150x180 cm	1
4 Champ de table PE/NW	150x200 cm	1
5 Bandelette adhésive	10x30 cm	1
6 Casaques chirurgicales	Renforcées	2
7 Essuie-mains	40x40 cm	2
8 Enveloppe de stérilisation	100x100 cm	1

Описание	Размер	Зърно
1 U покривало	200x260 cm	1
2 Покривало с адхезия	150x240 cm	1
3 Покривало	150x180 cm	1
4 Покривало за масата PE/ NM	150x200 cm	1
5 Лепяща лента	10x30 cm	1
6 Хирургична престилка	защитени	2
7 Медицински кърпи	40x40 cm	2
8 Стерилизация пакет	100x100 cm	1

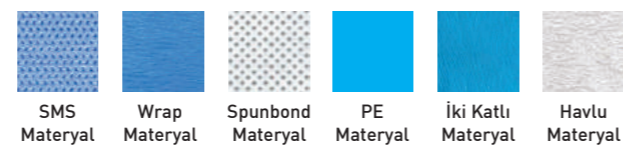
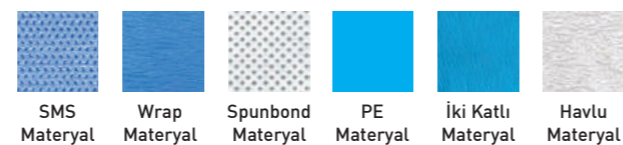
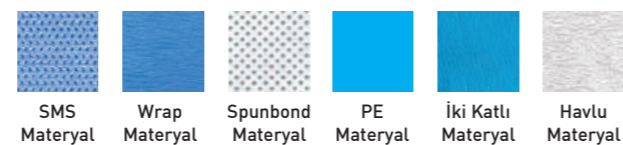
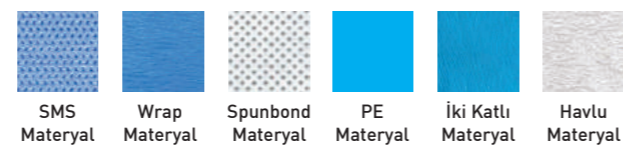
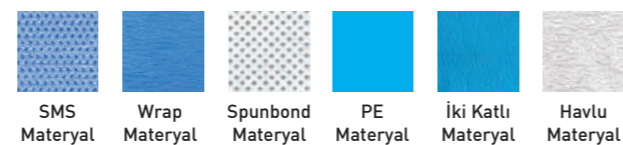
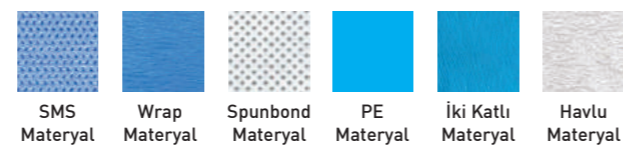
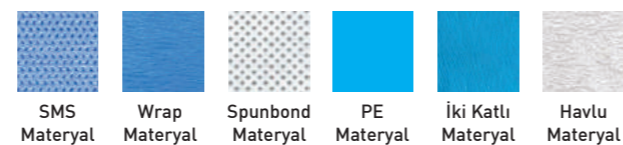
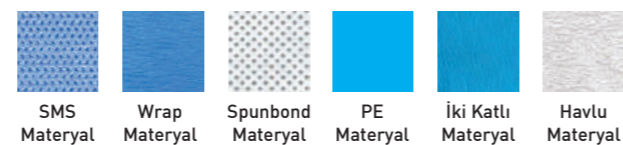
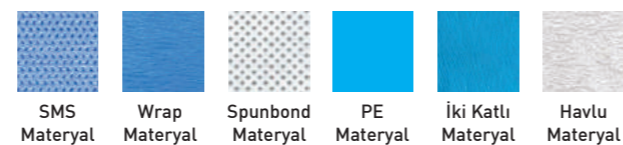
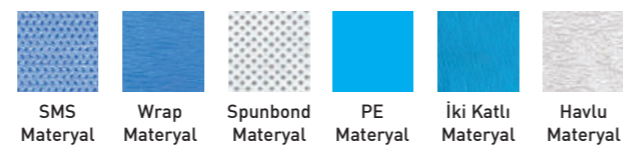
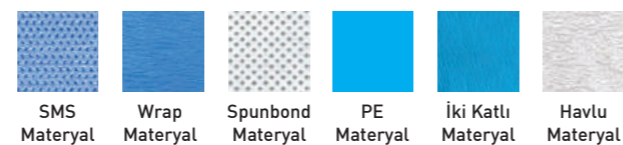
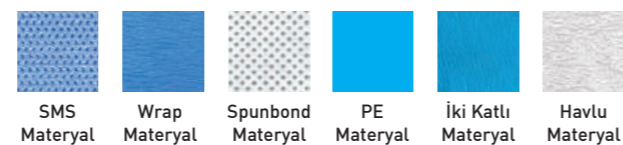
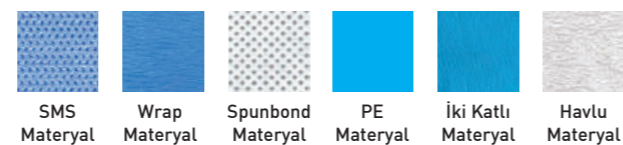
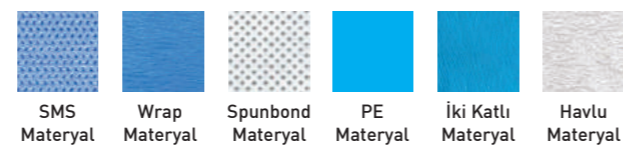
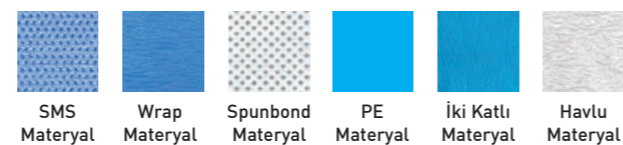
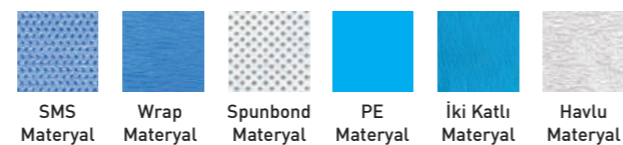
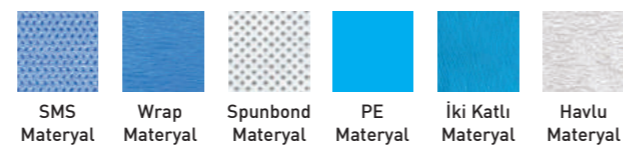
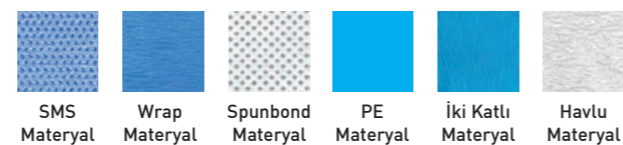
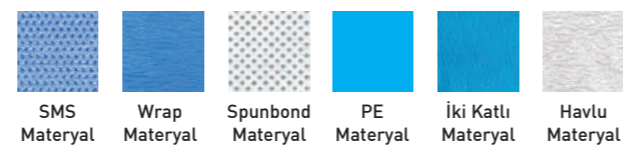
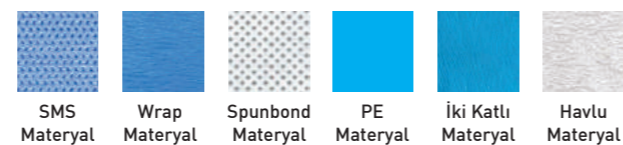
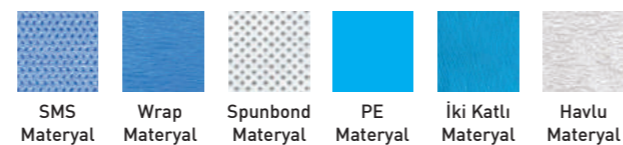
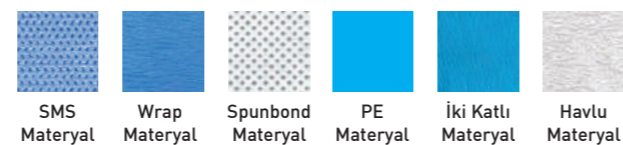
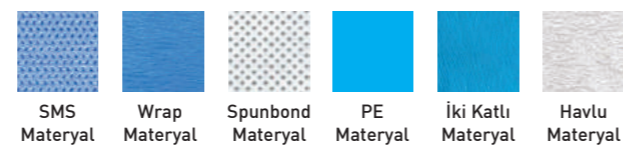
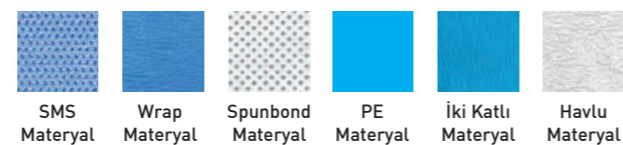
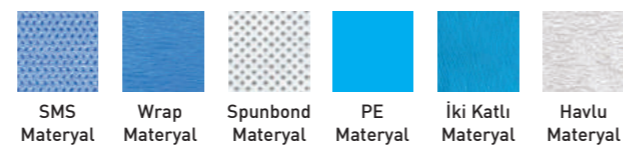
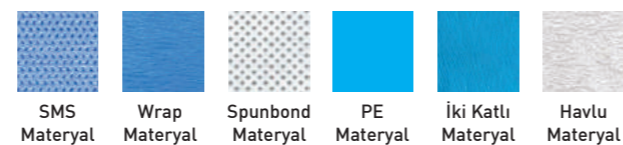
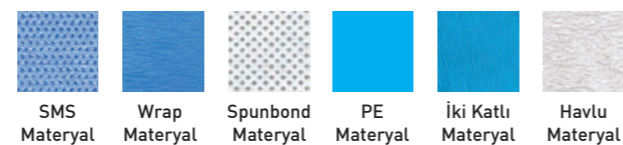
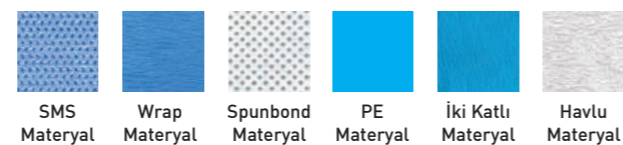
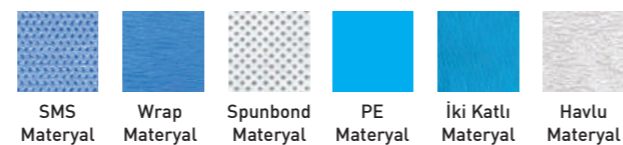
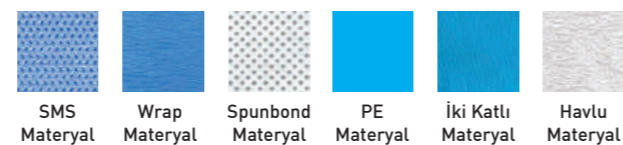
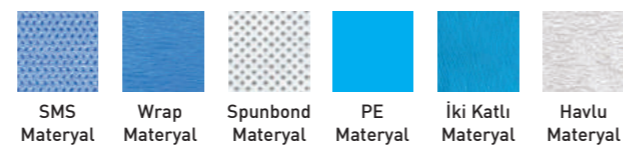
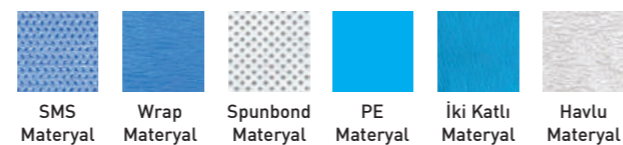
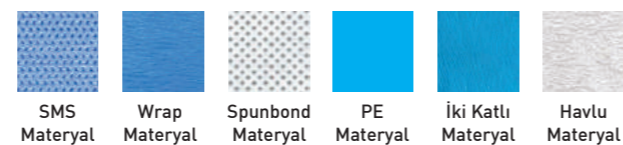
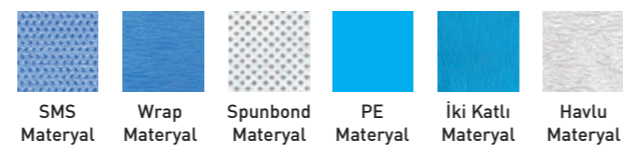
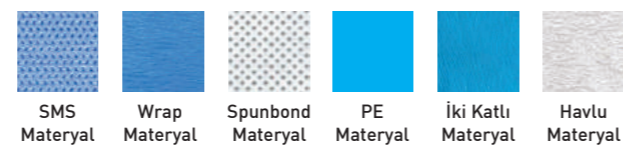
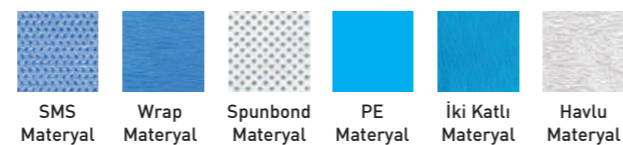
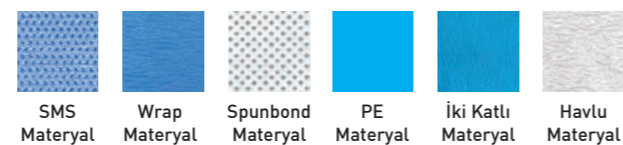
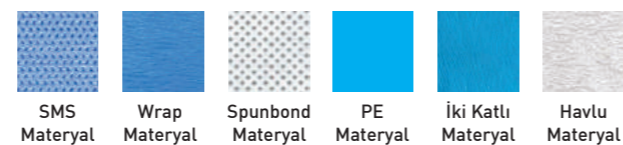
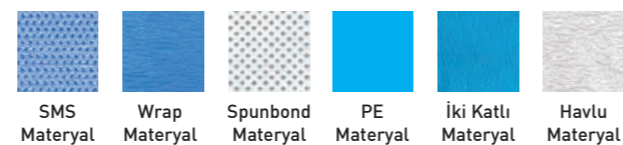
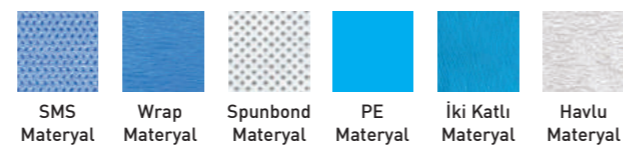
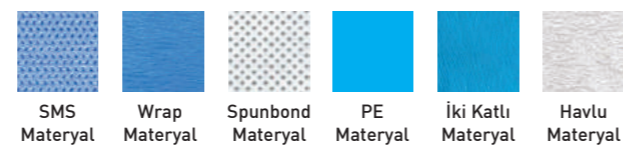
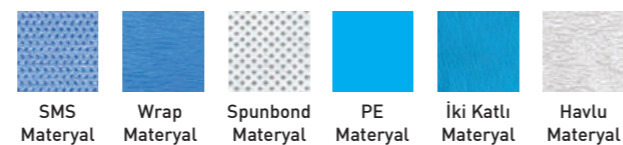
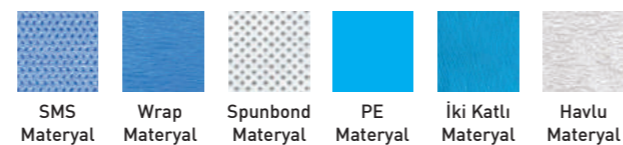
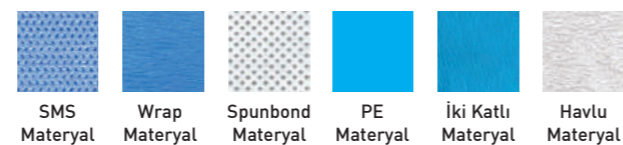
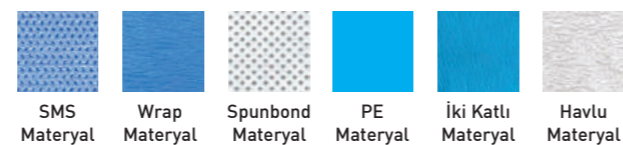
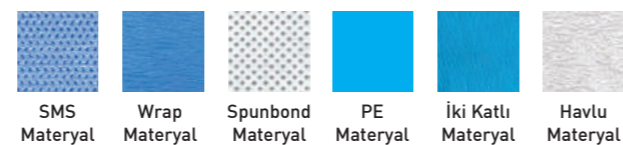
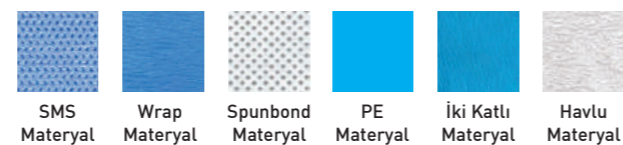
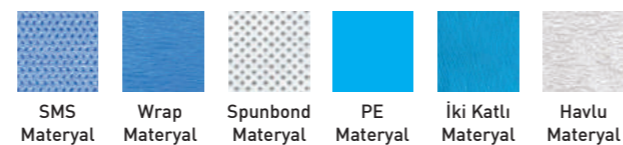
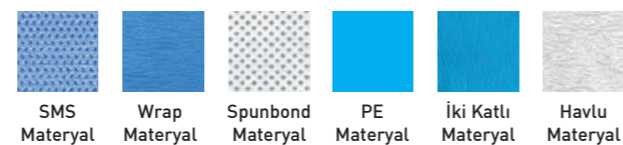
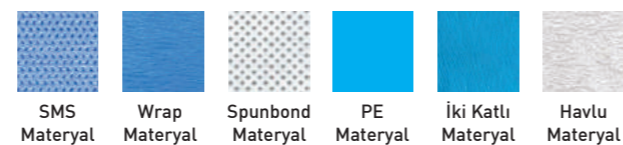
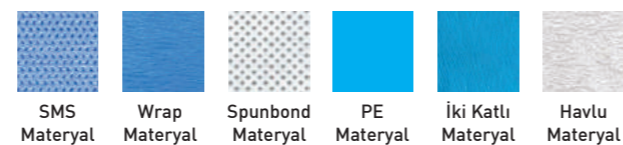
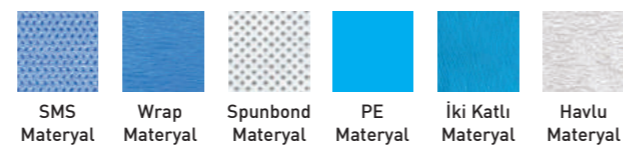
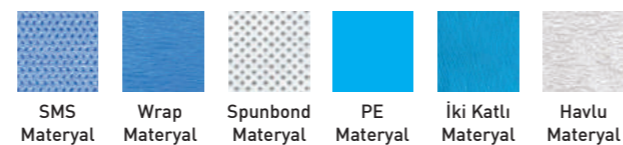
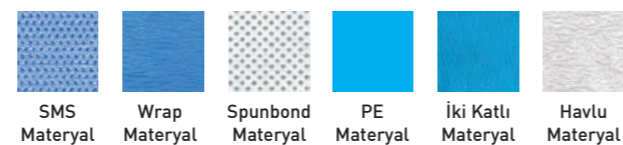
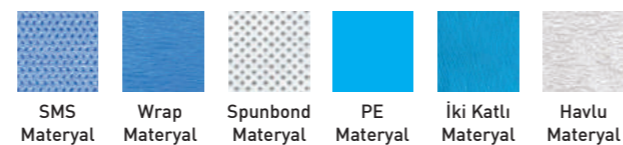
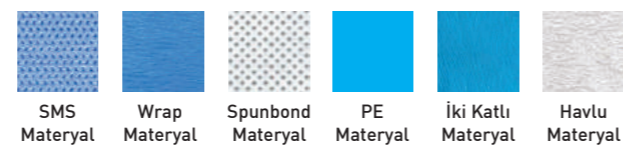
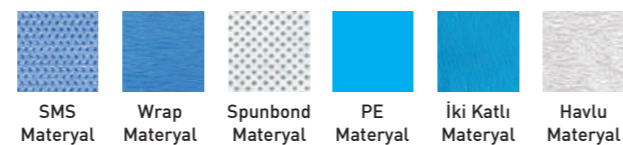
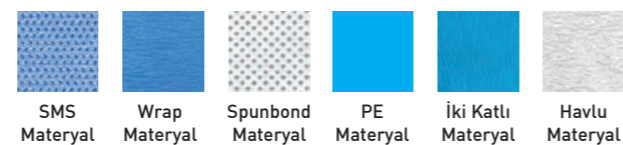
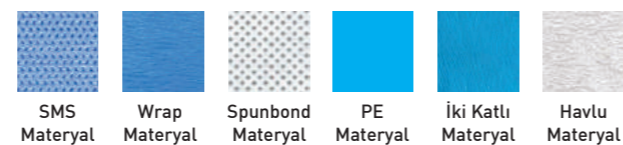
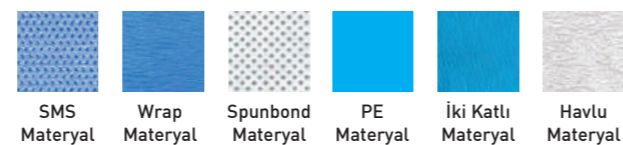
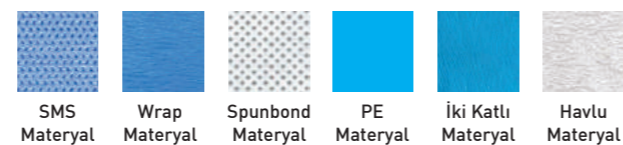
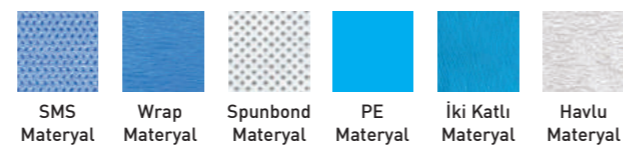
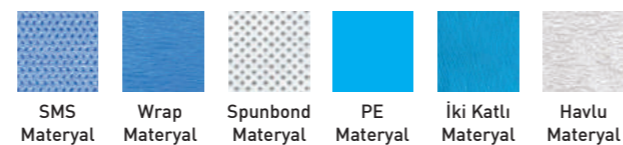
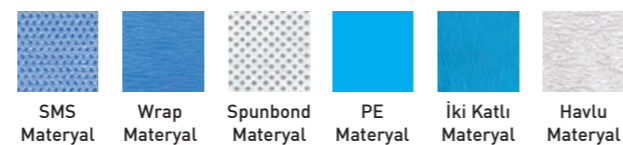
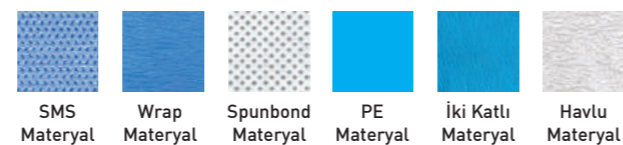
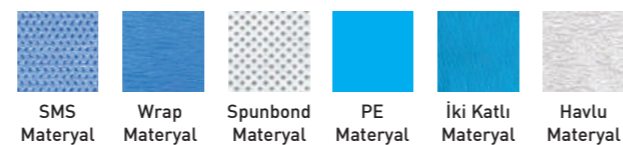
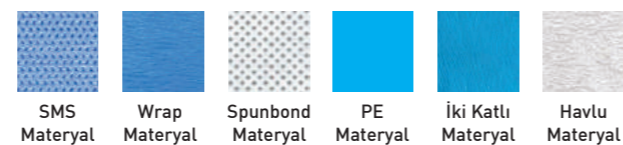
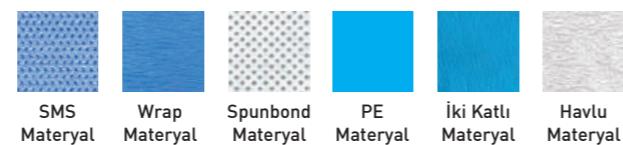
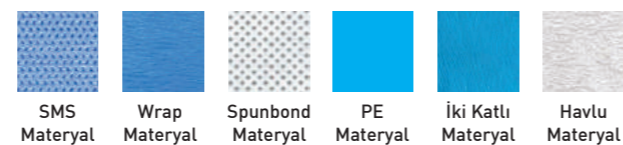
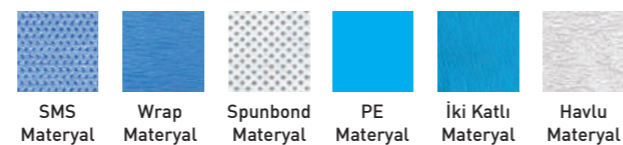
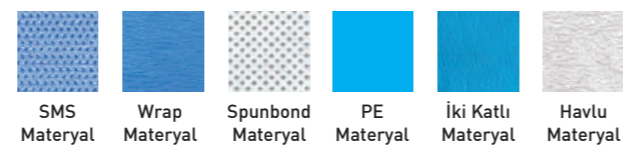
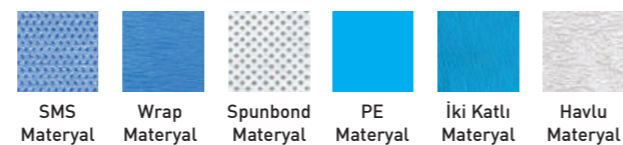
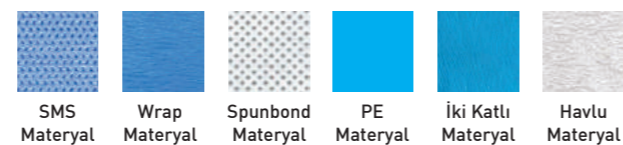
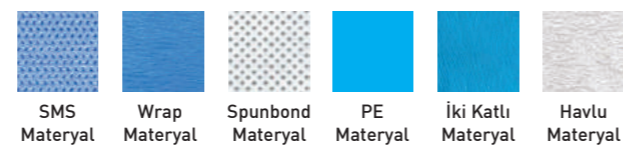
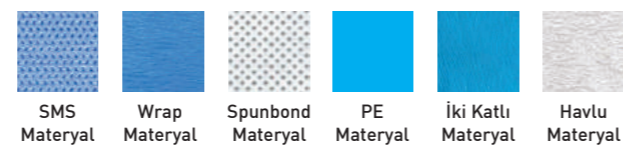
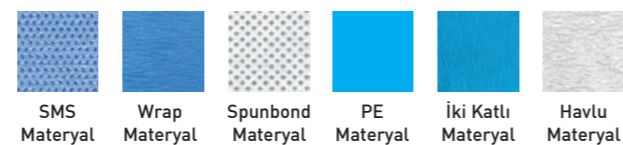
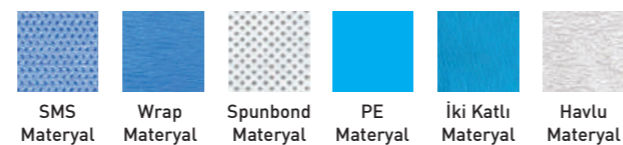
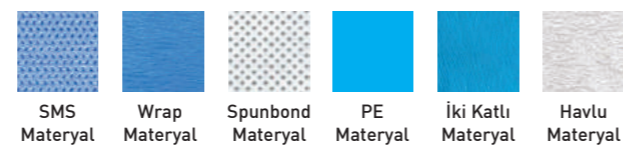
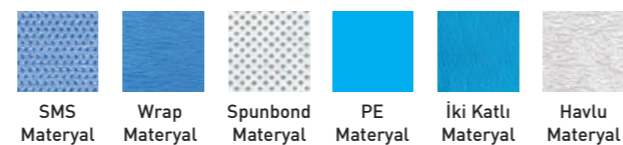
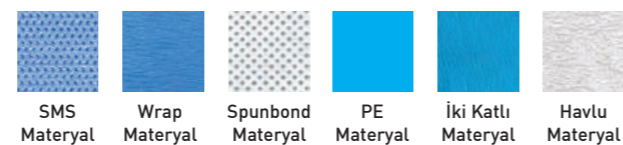
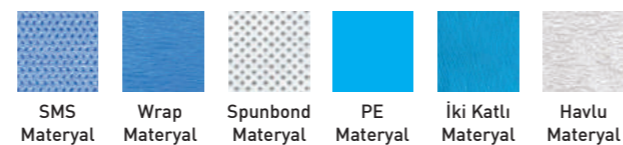
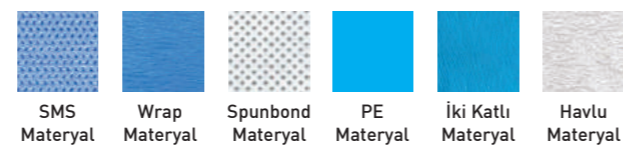
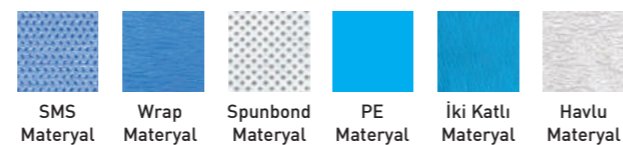
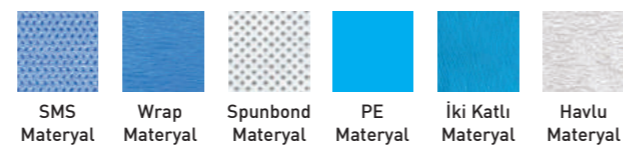
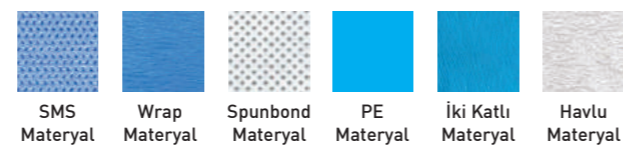
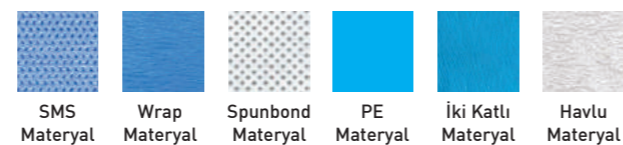
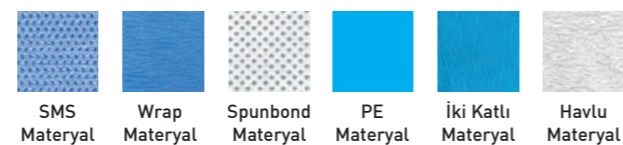
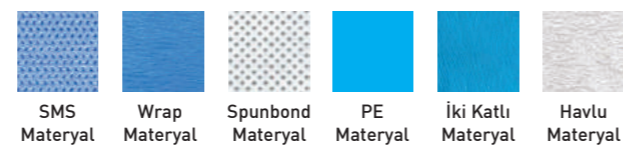
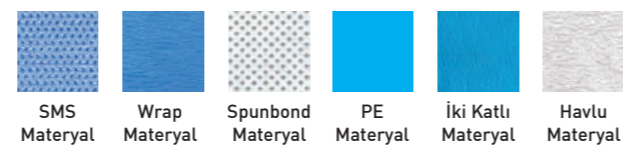
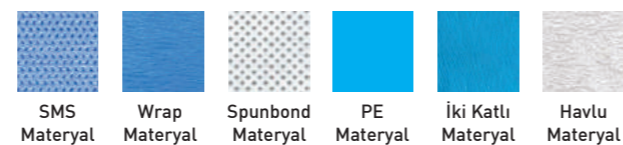
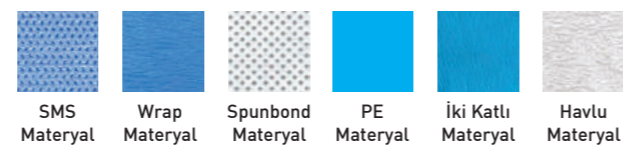
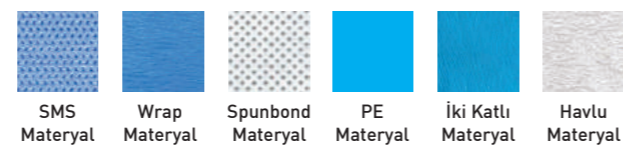
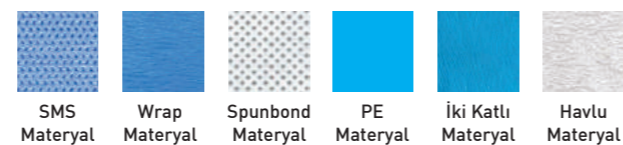
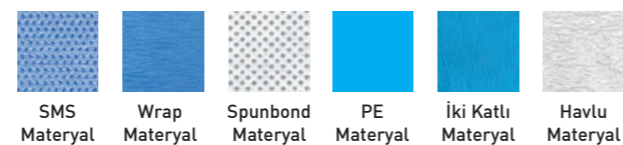
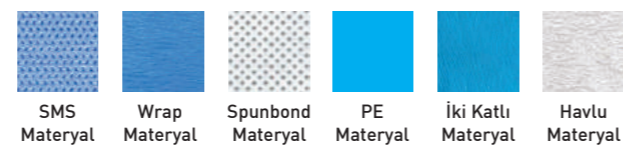
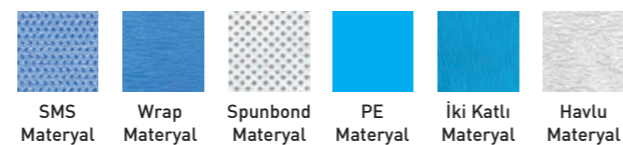
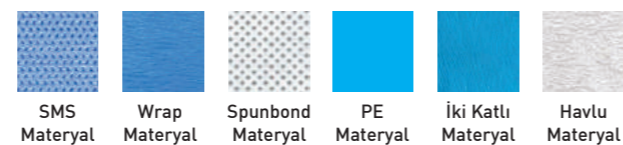
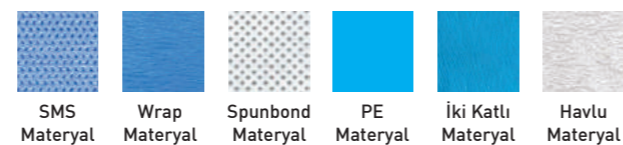
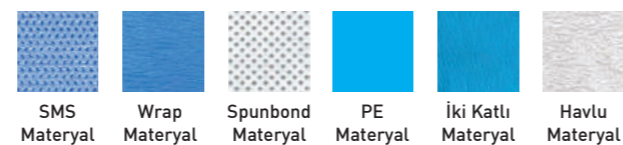
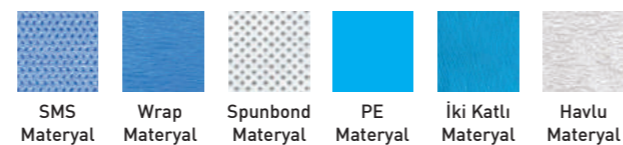
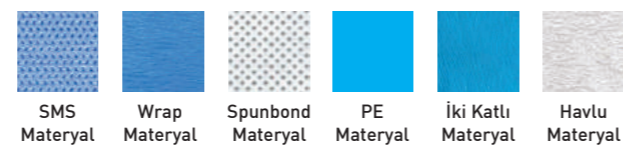
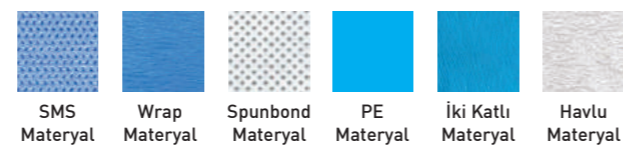
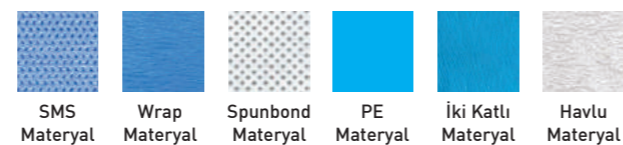
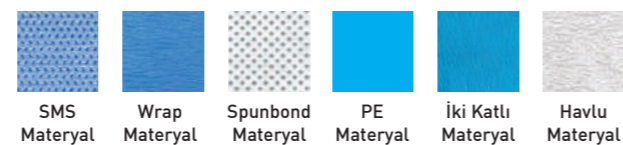
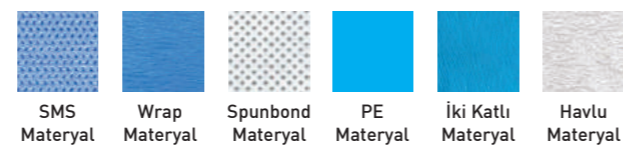
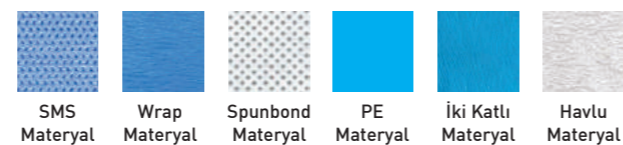
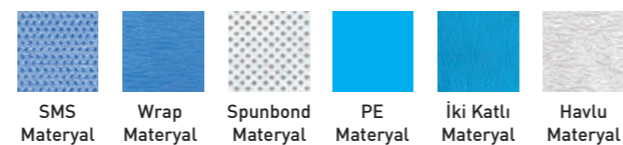
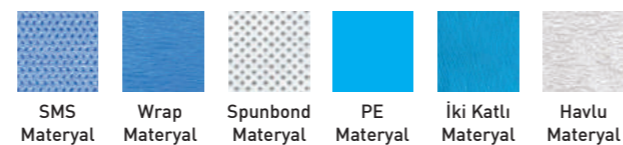
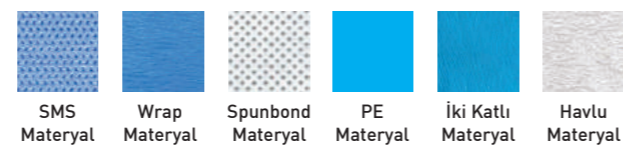
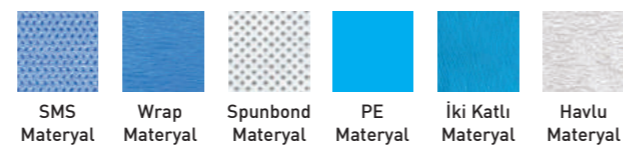
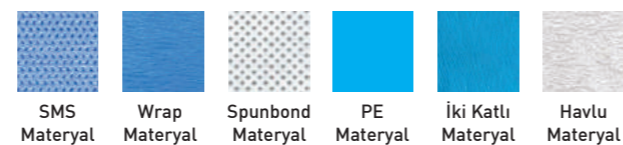
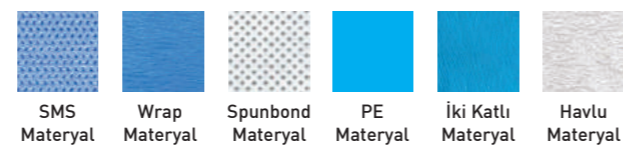
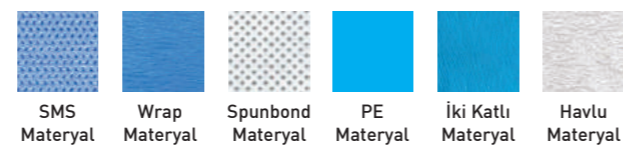
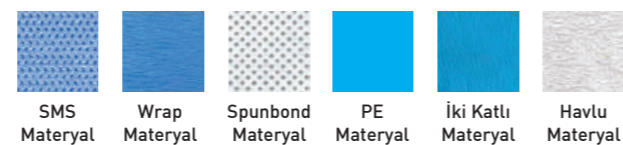
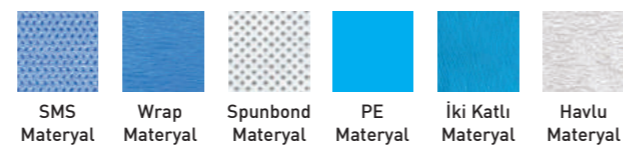
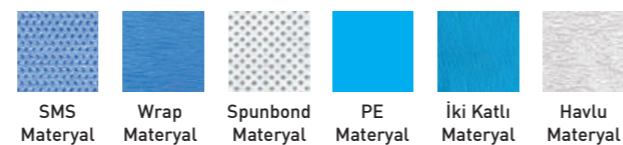
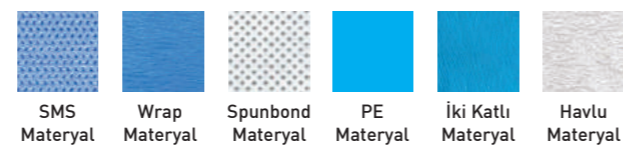
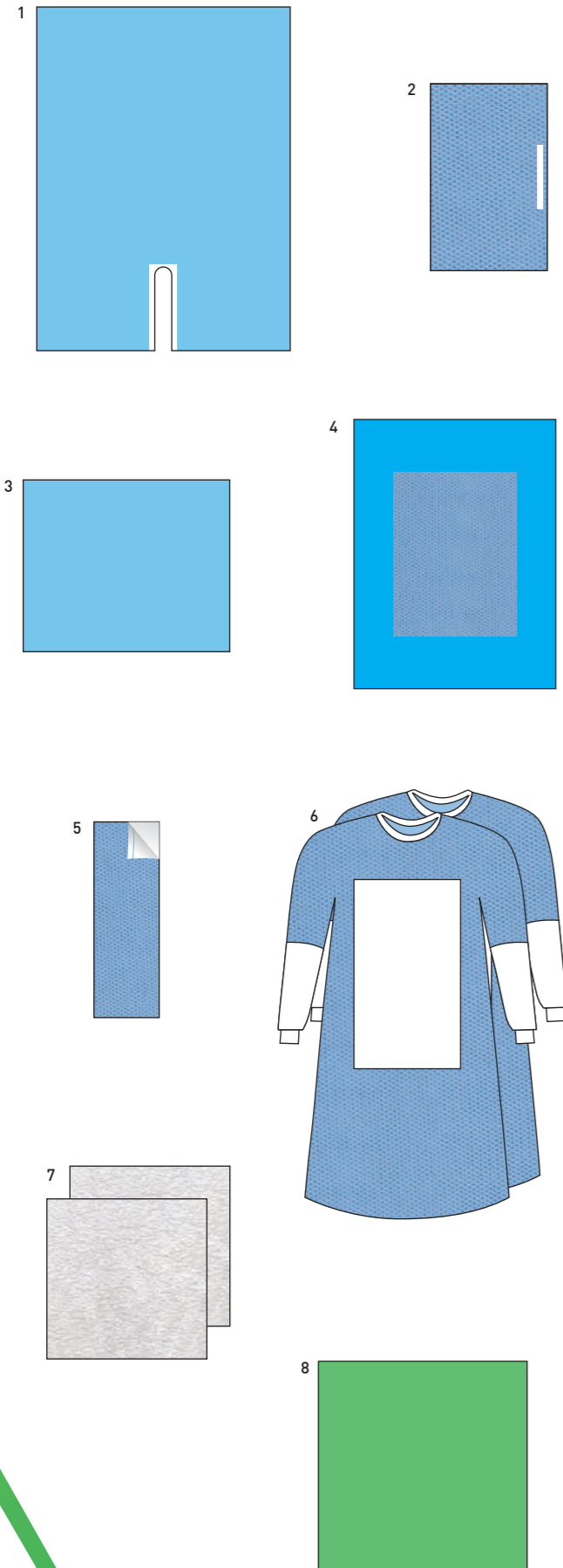
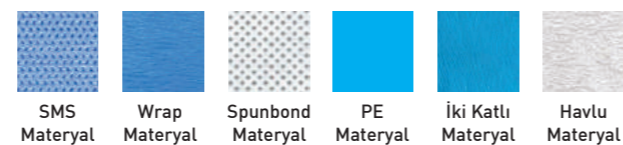

## PANSUMAN ÖRTÜ SETİ

DRESSING PACK  
TROUSSE DE PANSEMENT  
SET ЗА ПРЕВРЪЗКА

3A010600

Açıklama	Ebat	Adet
1 Bantlı Delikli Örtü	60x60 cm	1
2 Solüsyon Kabı	250 cc	1
3 Saplı Sünger	-	1
4 Üniversal Torba	28x34 cm	1
5 Medikal Havlu	40x40 cm	1
6 Gazlı Bez	7,5x7,5 cm	5
7 Cerrahi Eldiven	-	1
8 Sterilizasyon Bohçası	100x100 cm	1

Description	Size	Pieces
1 Drape With Tab	60x60 cm	1
2 Solution Cup	250 cc	1
3 Betadine Sponge	-	1
4 Universal Bag	28x34 cm	1
5 Medical Towel	40x40 cm	1
6 Spunc	7,5x7,5 cm	5
7 Surgical Gloves	-	1
8 Sterilization Wrap	100x100 cm	1

Explication	Taille	Pcs
1 Champ fenêtré adhésif	60x60 cm	1
2 Solition tasse	250 cc	1
3 Eponge de bétadine	-	1
4 Poche à intruments	28x34 cm	1
5 Essuie-mains	40x40 cm	1
6 Tampon de gaze	7,5x7,5 cm	5
7 Gants chirurgicaux	-	1
8 Enveloppe de stérilisation	100x100 cm	1

Описание	Размер	Зърно
1 Покривало с лента и дупка	60x60 cm	1
2 Съд за разтвор	250 cc	1
3 Гъба с дръжка	-	1
4 Универсална торба	28x34 cm	1
5 Медицински кърпи	40x40 cm	1
6 Марли	7,5x7,5 cm	5
7 Хирургични ръкавици	-	1
8 Стерилизация пакет	100x100 cm	1

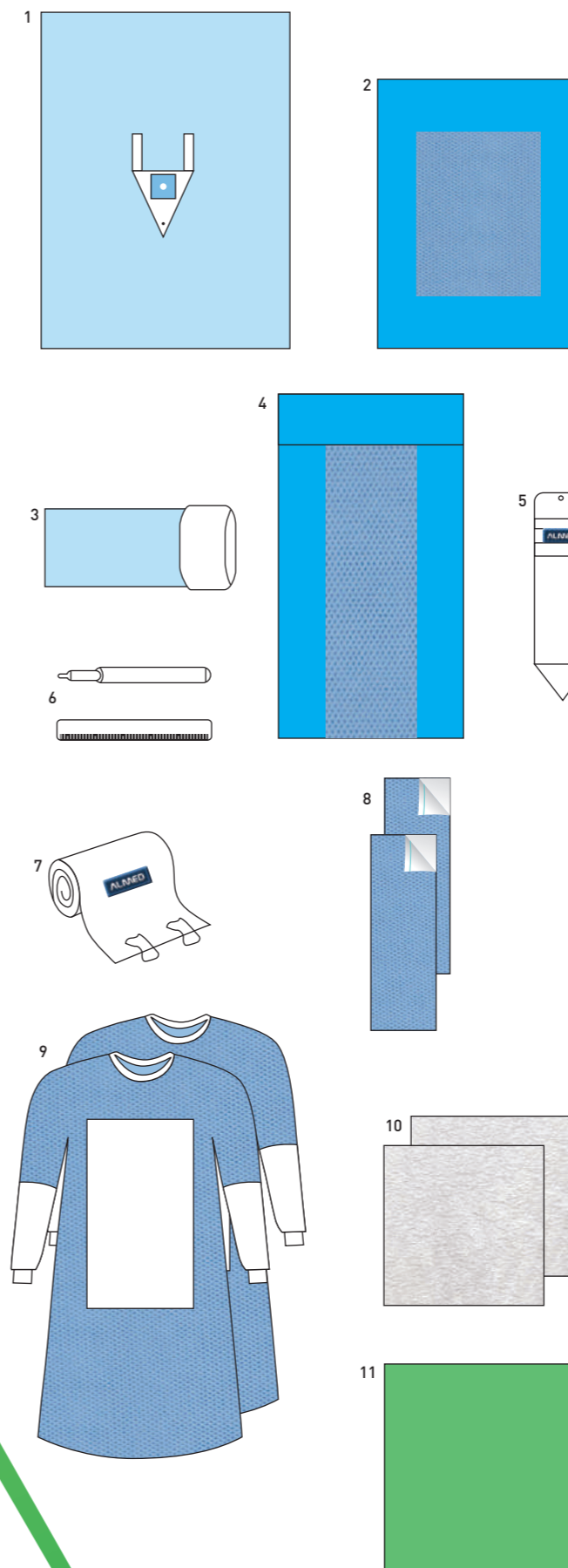
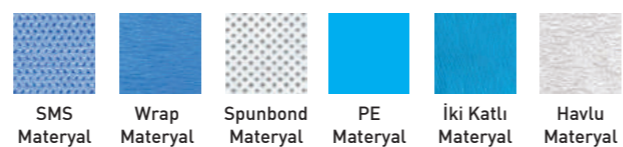
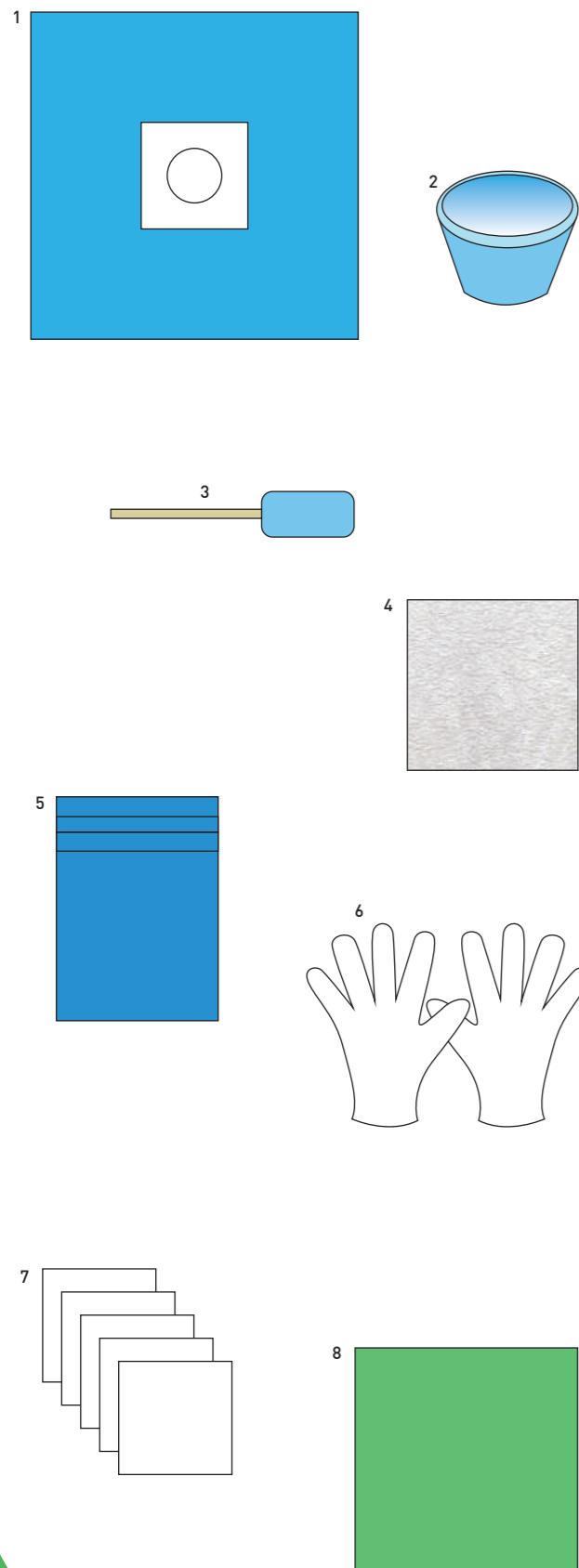
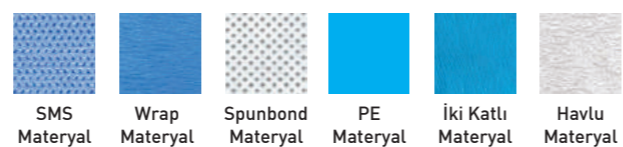

## ARTROSKOPİ ÖRTÜ SETİ

ARTHROSCOPY DRAPE PACK  
TROUSSE D'ARTHROSCOPIE  
SET ЗА АРТРОСКОПИЯ

3A020100

Açıklama	Ebat	Adet
1 Poşlu Artrroskopi Örtüsü	240x320 cm	1
2 Alet Masa Örtüsü	150x200 cm	1
3 Stokinet Bacak	40x75 cm	1
4 Mayo Masa Örtüsü PE/NW	78x145 cm	1
5 Kamera Kılıfı	13x250 cm	1
6 Cilt Kalem - Cetvel	-	1
7 Elastik Bandaj	10x200 cm	1
8 Yapışkan Bant	10x30 cm	2
9 Cerrahi Önlük Korumalı	Korumalı	2
10 Medikal Havlu	40x40 cm	2
11 Sterilizasyon Bohçası	100x100 cm	1

Description	Size	Pieces
1 Arthroscopy Drape Lcp	240x320 cm	1
2 Back Table Drape PE/NW	150x200 cm	1
3 Stockinette For Leg	40x75 cm	1
4 Mayo Stand Cover PE/NW	78x145 cm	1
5 Video Camera Cover	13x250 cm	1
6 Marker - Ruler	-	1
7 Elastic Bandage	10x200 cm	1
8 Op - Tape	10x30 cm	2
9 Surgical Gown	Reinforced	2
10 Medical Towel	40x40 cm	2
11 Sterilization Wrap	100x100 cm	1

Explication	Taille	Pcs
1 Champ d'arthroscopie avec poche de recueil	240x320 cm	1
2 Champ de table PE/NW	150x200 cm	1
3 Stockinette	40x75 cm	1
4 Housse de Mayo PE/NW	78x145 cm	1
5 Housse de caméra	13x250 cm	1
6 Marqueur - Dirigeant	-	1
7 Bandage élastique	10x200 cm	1
8 Bandelette adhésive	10x30 cm	2
9 Casaques chirurgicales	Renforcées	2
10 Essuie-mains	40x40 cm	2
11 Enveloppe de stérilisation	100x100 cm	1

Описание	Размер	Зърно
1 Покривало за артроскопия	240x320 cm	1
2 Покривало за масата PE/ NW	150x200 cm	1
3 Чорапи за крак	40x75 cm	1
4 Покривало за над операциялната масичка PE/ NW	78x145 cm	1
5 Калъф за камера	13x250 cm	1
6 Маркер за кожа	-	1
7 Еластичен бандаж	10x200 cm	1
8 Лепяща лента	10x30 cm	2
9 Хирургична престилка	защитени	2
10 Медицински кърпи	40x40 cm	2
11 Стерилизация пакет	100x100 cm	1

## ARTROSKOPİ ÖRTÜ SETİ (POŞSUZ) -B-

ARTHROSCOPY DRAPE PACK -B-  
TROUSSE D'ARTHROSCOPIE -B-  
SET ZA ARTROSKOPIJA BEZ TORBA

3A020100-B

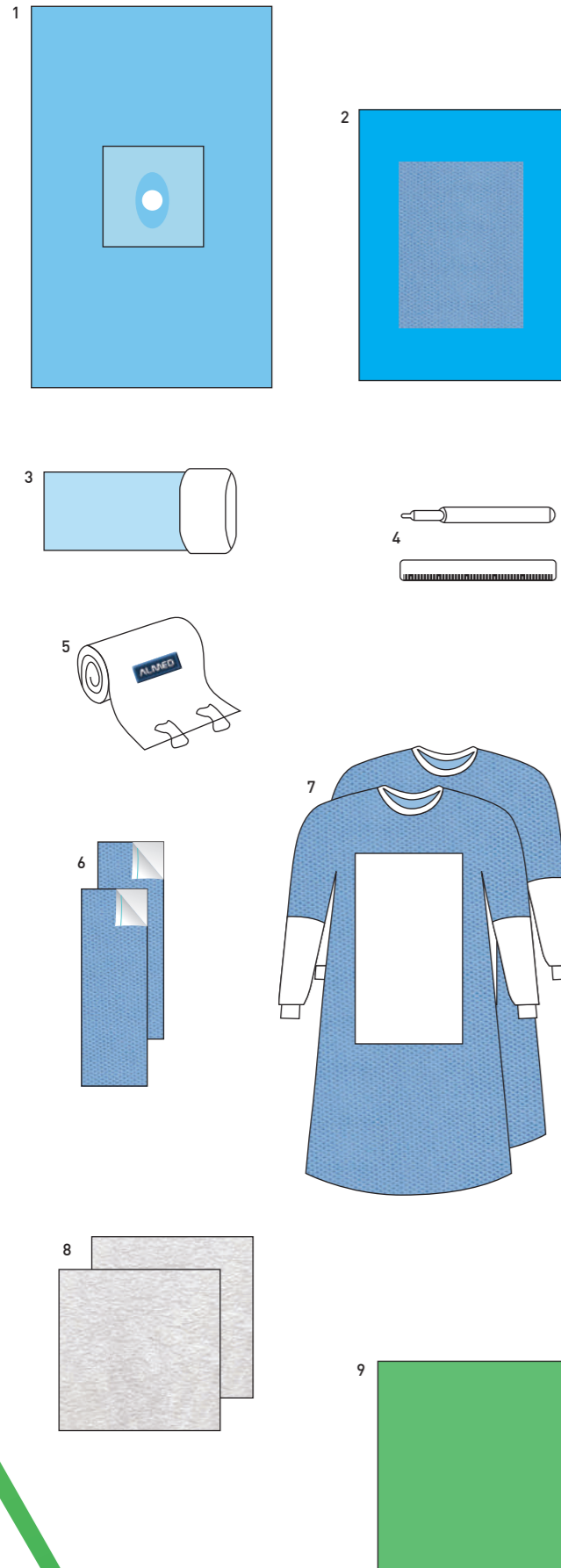

Ç	Açıklama	Ebat	Adet
1	Ekstremitte Örtüsü (Poşsuz)	200x310 cm	1
2	Alet Masa Örtüsü PE/NW	150x200 cm	1
3	Stokinet Bacak	40x75 cm	1
4	Cilt Kalem - Cetvel	-	1
5	Elastik Bandaj	10x200 cm	1
6	Yapışkan Bant	10x30 cm	2
7	Cerrahi Önlük	Korumalı	2
8	Medikal Havlu	40x40 cm	2
9	Sterilizasyon Bohçası	100x100 cm	1

UK	Description	Size	Pieces
1	Extremity Drape	200x310 cm	1
2	Back Table Drape PE/NW	150x200 cm	1
3	Stockinette For Leg	40x75 cm	1
4	Marker - Ruler	-	1
5	Elastic Bandage	10x200 cm	1
6	Op - Tape	10x30 cm	2
7	Surgical Gown	Reinforced	2
8	Medical Towel	40x40 cm	2
9	Sterilization Wrap	100x100 cm	1

FR	Explication	Taille	Pcs
1	Trousse d'extrémité	200x310 cm	1
2	Champ de table PE/NW	150x200 cm	1
3	Stockinette	40x75 cm	1
4	Marqueur - Dirigeant	-	1
5	Bandage élastique	10x200 cm	1
6	Bandelette adhésive	10x30 cm	2
7	Casaques chirurgicales	Renforcées	2
8	Essuie-mains	40x40 cm	2
9	Enveloppe de stérilisation	100x100 cm	1

BG	Описание	Размер	Зърно
1	Покривало	200x310 cm	1
2	Покривало за масата PE/ NM	150x200 cm	1
3	Чорапи за крак	40x75 cm	1
4	Маркер за кожа	-	1
5	Еластичен бандаж	10x200 cm	1
6	Лепяща лента	10x30 cm	2
7	Хирургична престилка	защитени	2
8	Медицински кърпи	40x40 cm	2
9	Стерилизация пакет	100x100 cm	1

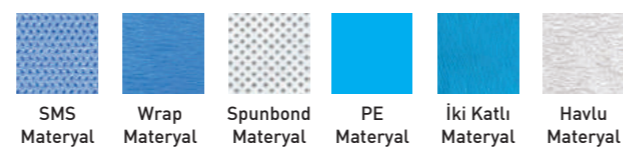

## EXTREMİTE ÖRTÜ SETİ

EXTREMITY DRAPE  
TROUSSE D'EXTREMİTE  
SET ZA OPERACIJI NA KOJANNA I RAMENNA STABA

3A020200

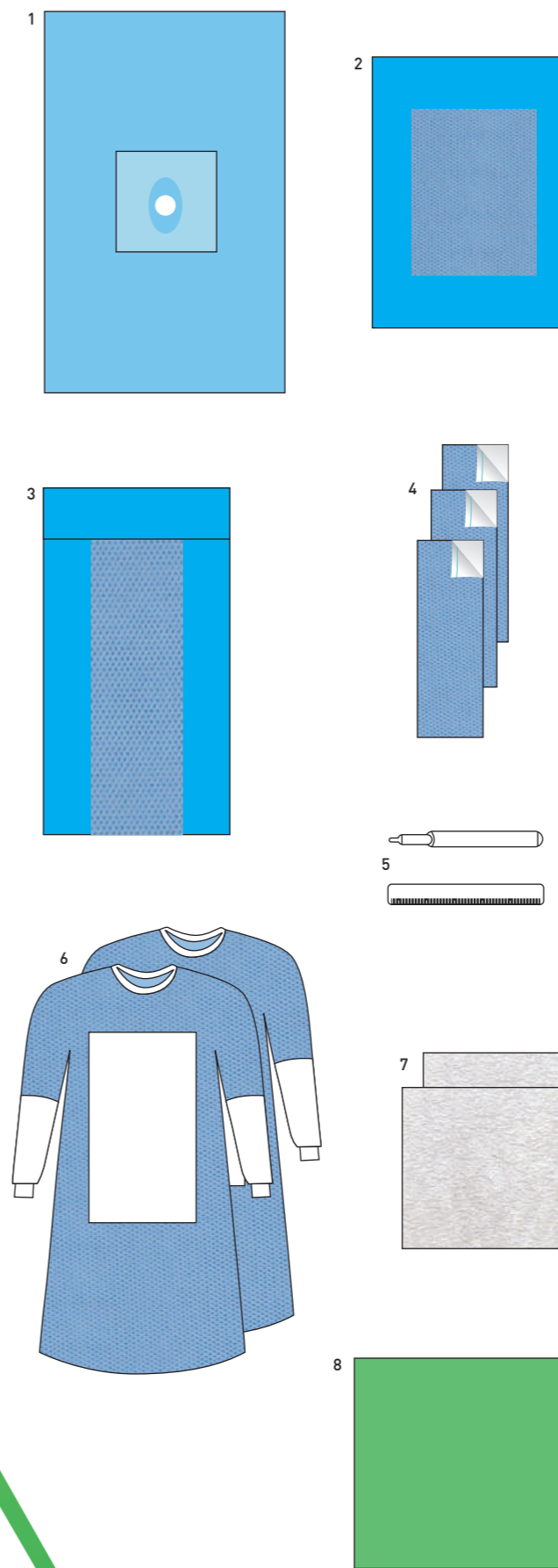

Ç	Açıklama	Ebat	Adet
1	Ekstremitte Örtüsü	200x300 cm	1
2	Alet Masa Örtüsü PE/NW	150x200 cm	1
3	Mayo Masa Örtüsü PE/NW	75x145 cm	1
4	Yapışkan Bant	10x30 cm	3
5	Cilt Kalem - Cetvel	-	1
6	Cerrahi Önlük	Korumalı	2
7	Medikal Havlu	40x40 cm	2
8	Sterilizasyon Bohçası	100x100 cm	1

UK	Description	Size	Pieces
1	Extremity Drape	200x300 cm	1
2	Back Table Drape PE/NW	150x200 cm	1
3	Mayo Stand Cover PE/NW	75x145 cm	1
4	Op - Tape	10x30 cm	3
5	Marker - Ruler	-	1
6	Surgical Gown	Reinforced	2
7	Medical Towel	40x40 cm	2
8	Sterilization Wrap	100x100 cm	1

FR	Explication	Taille	Pcs
1	Champ d'extrémité	200x300 cm	1
2	Champ de table PE/NW	150x200 cm	1
3	Housse de Mayo PE/NW	75x145 cm	1
4	Bandelette adhésive	10x30 cm	3
5	Marqueur - Dirigeant	-	1
6	Casaques chirurgicales	Renforcées	2
7	Essuie-mains	40x40 cm	2
8	Enveloppe de stérilisation	100x100 cm	1

BG	Описание	Размер	Зърно
1	Покривало	200x300 cm	1
2	Покривало за масата PE/ NM	150x200 cm	1
3	Покривало за над операционната масичка PE/ NM	75x145 cm	1
4	Лепяща лента	10x30 cm	3
5	Маркер за кожа	-	1
6	Хирургическа престилка	защитени	2
7	Медицински кърпи	40x40 cm	2
8	Стерилизация пакет	100x100 cm	1

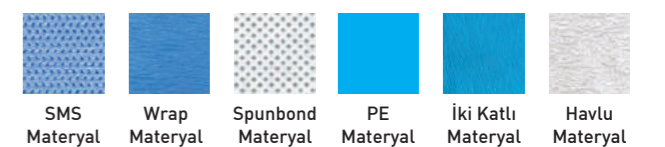

## ALT EXTREMİTE ( DİZ ) ÖRTÜ SETİ

UNDER EXTREMITY PACK  
GENOU TROUSSE D'EXTRÉMITÉ  
ГОРНО ПОКРИВАЛО ЗА КРАЙ

3A020200-B

Ç	Açıklama	Ebat	Adet
1	Alet Masa Örtüsü PE/NW	150x200 cm	2
2	Diz Örtüsü	240x320 cm	1
3	Bantlı Örtü	100x100 cm	1
4	Yapışkan Bant	10x30 cm	1
5	Cerrahi Önlük	Korumalı	2
6	Medikal Havlu	40x40 cm	2
7	Kamera Kılıfı	13x250 cm	1
8	Elastik Bandaj	10x200 cm	1
9	Stokinet	60x40 cm	1
10	Üniversal Torba	28x34 cm	1
11	Cilt Kalem - Cetvel	-	1
12	Sterilizasyon Bohçası	100x100 cm	1

UK	Description	Size	Pieces
1	Back Table Drape PE/NM	150x200 cm	2
2	Knee Drape	240x320 cm	1
3	Drape w/TAPE	100x100 cm	1
4	Op - Tape	10x30 cm	1
5	Surgical Gown	Reinforced	2
6	Medical Towel	40x40 cm	2
7	Video Camera Cover	13x250 cm	1
8	Elastic Bandage	10x200 cm	1
9	Stockinette	60x40 cm	1
10	Universal Bag	28x34 cm	1
11	Marker - Ruler	-	1
12	Sterilization Wrap	100x100 cm	1

F	Explication	Taille	Pcs
1	Champ de table PE/NW	150x200 cm	2
2	Champ de genou	240x320 cm	1
3	Champ adhésif	100x100 cm	1
4	Bandelette adhésive	10x30 cm	1
5	Casaques chirurgicales	Renforcées	2
6	Essuie-mains	40x40 cm	2
7	Housse de caméra	13x250 cm	1
8	Bandage élastique	10x200 cm	1
9	Stockinette	60x40 cm	1
10	Poche à instruments	28x34 cm	1
11	Marqueur - Dirigeant	-	1
12	Enveloppe de stérilisation	100x100 cm	1

B	Описание	Размер	Зърно
1	Покривало за масата PE/ NM	150X200 cm	2
2	Коляното на капак	240X320 cm	1
3	Покривало с лента и дупка	100X100 cm	1
4	Лепяща лента	10X30 cm	1
5	Хирургическа престилка	защитени	2
6	Медицински кърпи	40x40 cm	2
7	Калъф за камера	13x250 cm	1
8	Еластичен бандаж	10x200 cm	1
9	Чорапи за крак	60x40 cm	1
10	Универсална торба	28x34 cm	1
11	Маркер за кожа	-	1
12	Стерилизация пакет	100x100 cm	1

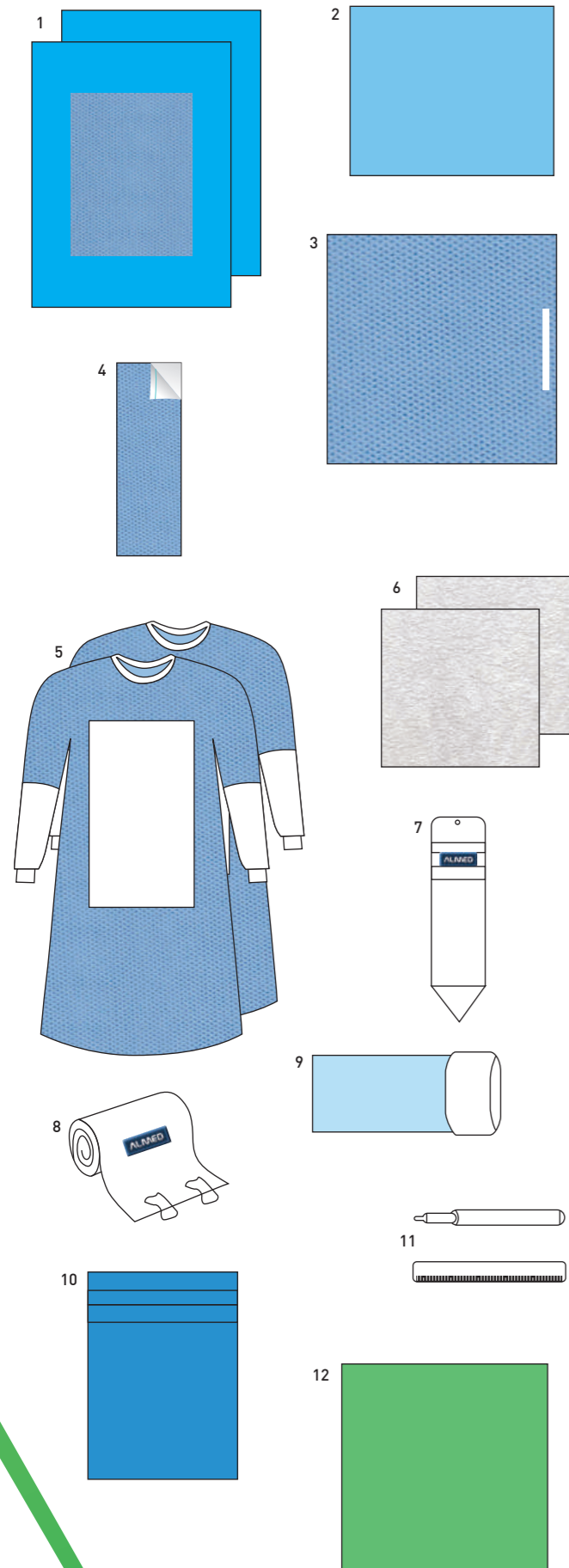

## ÜST EXTREMİTE ( OMUZ ) ÖRTÜ SETİ

TOP EXTREMITY PACK  
ÉPAULE TROUSSE D'EXTRÉMITÉ  
ДОЛНО ПОКРИВАЛО ЗА КРАЙ

3A020200-B

Ç	Açıklama	Ebat	Adet
1	Alet Masa Örtüsü PE/NW	150x200 cm	1
2	Omuz Örtüsü	240x320 cm	1
3	Bantlı Örtü	150x200 cm	1
4	Yapışkan Bant	10x30 cm	2
5	Bantlı Örtü	75x90 cm	3
6	Düz Örtü PE	100x100 cm	1
7	Cerrahi Önlük	Korumalı	2
8	Medikal Havlu	40x40 cm	2
9	Kamera Kılıfı	13x250 cm	1
10	El İçin Stokinet	20x60 cm	1
11	Elastik Bandaj	15x250 cm	1
12	Cilt Kalem - Cetvel	-	1
13	Sterilizasyon Bohçası	100x100 cm	1

UK	Description	Size	Pieces
1	Back Table Drape PE/NW	150x200 cm	1
2	Shoulder Drape	240x320 cm	1
3	Drape w/TAPE	150x200 cm	1
4	Op - Tape	10x30 cm	2
5	Drape w/TAPE	75x90 cm	3
6	Drape Pe	100x100 cm	1
7	Surgical Gown	Reinforced	2
8	Medical Towel	40x40 cm	2
9	Video Camera Cover	13x250 cm	1
10	Stockinette For Hand	20x60 cm	1
11	Elastic Bandage	15x250 cm	1
12	Marker - Ruler	-	1
13	Sterilization Wrap	100x100 cm	1

F	Explication	Taille	Pcs
1	Champ de table PE/NW	150x200 cm	1
2	Champ de épaule	240x320 cm	1
3	Ivoire	150x200 cm	1
4	Bandelette adhésive	10x30 cm	2
5	Champ fenêtré adhésif	75x90 cm	3
6	Champ	100x100 cm	1
7	Casaques chirurgicales	Renforcées	2
8	Essuie-mains	40x40 cm	2
9	Housse de caméra	13x250 cm	1
10	Stockinette	20x60 cm	1
11	Bandage élastique	15x250 cm	1
12	Marqueur - Dirigeant	-	1
13	Enveloppe de stérilisation	100x100 cm	1

B	Описание	Размер	Зърно
1	Покривало за масата PE/ NM	150x200 cm	1
2	Скапуларен	240x320 cm	1
3	Покривало с лента и дупка	150x200 cm	1
4	Лепяща лента	10x30 cm	2
5	Покривало с лента и дупка	75x90 cm	3
6	Покривало	100x100 cm	1
7	Хирургическа престилка	защитени	2
8	Медицински кърпи	40x40 cm	2
9	Калъф за камера	13x250 cm	1
10	Чорапи за крак	20x60 cm	1
11	Еластичен бандаж	15x250 cm	1
12	Маркер за кожа	-	1
13	Стерилизация пакет	100x100 cm	1

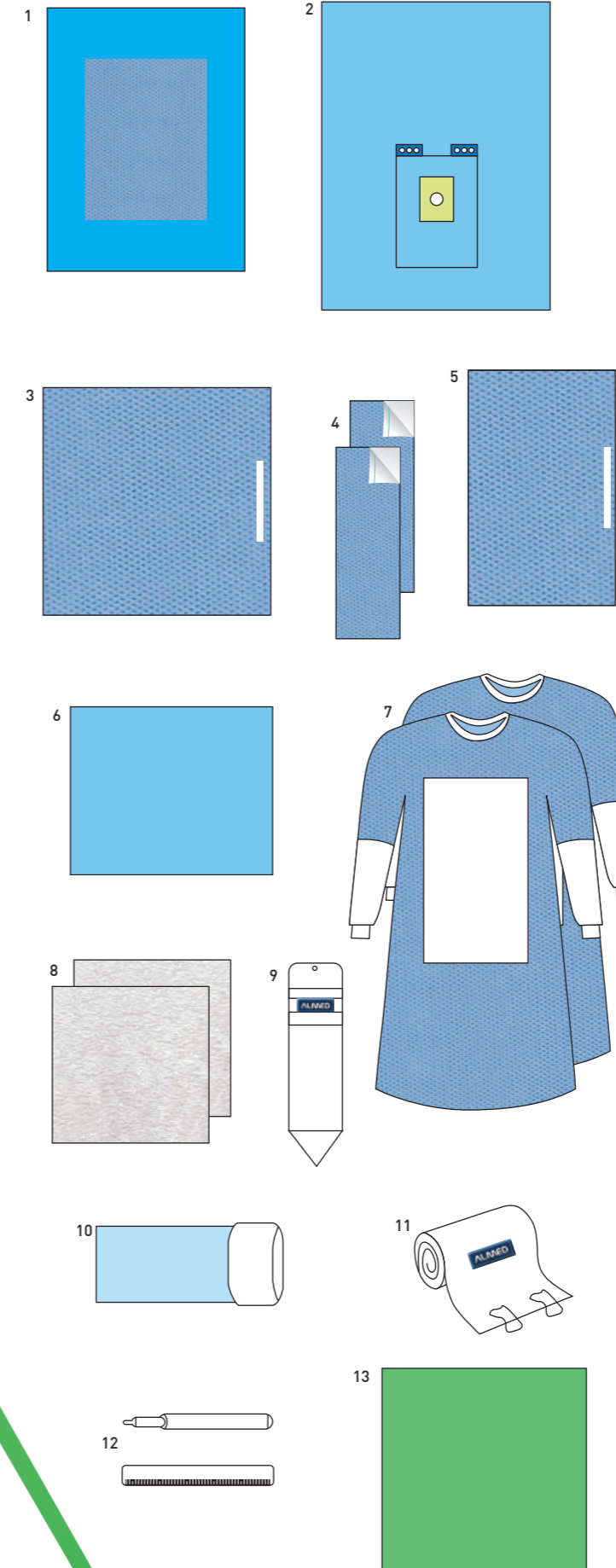



## KALÇA ÖRTÜ SETİ

HIP DRAPE PACK  
TROUSSE DE HANCHE  
SET ZA ARTROPLASTIKA NA TAZOBEĐRENA STABA

3A020300

Ç	Açıklama	Ebat	Adet
1	-U- Örtüsü	150x200 cm	1
2	Yan Bant Örtüsü	75x90 cm	1
3	Düz Örtü	150x180 cm	1
4	Alet Masa Örtüsü PE/NW	150x200 cm	1
5	Mayo Masa Örtüsü PE/NW	78x145 cm	1
6	Stokinet Bacak	40x60 cm	1
7	Yapışkan Bant	10x30 cm	2
8	Cerrahi Önlük	Korumalı	2
9	Medikal Havlu	40x40 cm	2
10	Universal Torba	50x60 cm	2
11	Cilt Kalem - Cetvel	-	1
12	Elastik Bandaj	10x200 cm	1
13	Sterilizasyon Bohçası	100x100 cm	1

UK	Description	Size	Pieces
1	U Drape	150x200 cm	1
2	Drape With Adhesive	75x90 cm	1
3	Drape	150x180 cm	1
4	Back Table Drape PE/NW	150x200 cm	1
5	Mayo Stand Cover PE/NW	78x145cm	1
6	Stockinette For Leg	40x60 cm	1
7	Op - Tape	10x30 cm	2
8	Surgical Gown	Reinforced	2
9	Medical Towel	40x40 cm	2
10	Universal Bag	50x60 cm	2
11	Marker - Ruler	-	1
12	Elastic Bandage	10x200 cm	1
13	Sterilization Wrap	100x100 cm	1

F	Explication	Taille	Pcs
1	Champ en U adhésif	150x200 cm	1
2	Champ adhésif	75x90 cm	1
3	Champ	150x180 cm	1
4	Champ de table PE/NW	150x200 cm	1
5	Housse de Mayo PE/NW	78x145 cm	1
6	Stockinette	40x40 cm	1
7	Bandelette adhésive	10x30 cm	2
8	Casaques chirurgicales	Renforcées	2
9	Essuie-mains	40x40 cm	2
10	Poche à instruments	50x60 cm	2
11	Marqueur - Dirigaeant	-	1
12	Bandage élastique	100x200 cm	1
13	Enveloppe de stérilisation	100x100 cm	1

B	Описание	Размер	Зърно
1	U Покривало	150x200 cm	1
2	Покривало с адхезия	75x90 cm	1
3	Покривало	150x180 cm	1
4	Покривало за масата PE/ NM	150x200 cm	1
5	Покривало за надоперационната масичка PE/ NM	78x145 cm	1
6	Чорап за крак	40x40 cm	1
7	Лепяща лента	10x30 cm	2
8	Хирургична престилка	защитени	2
9	Медицински кърпи	40x40 cm	2
10	Универсална торба	50x60 cm	2
11	Маркер за кожа	-	1
12	Еластичен бинт	100x200 cm	1
13	Стерилизация пакет	100x100 cm	1

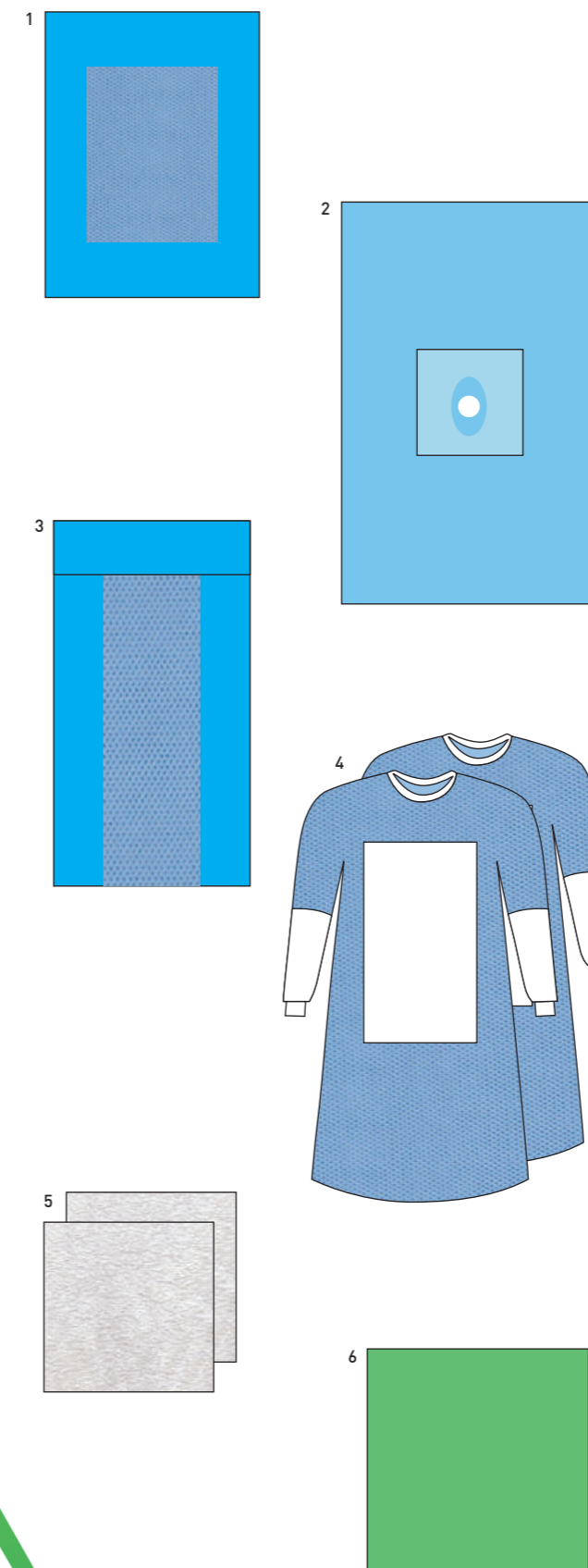
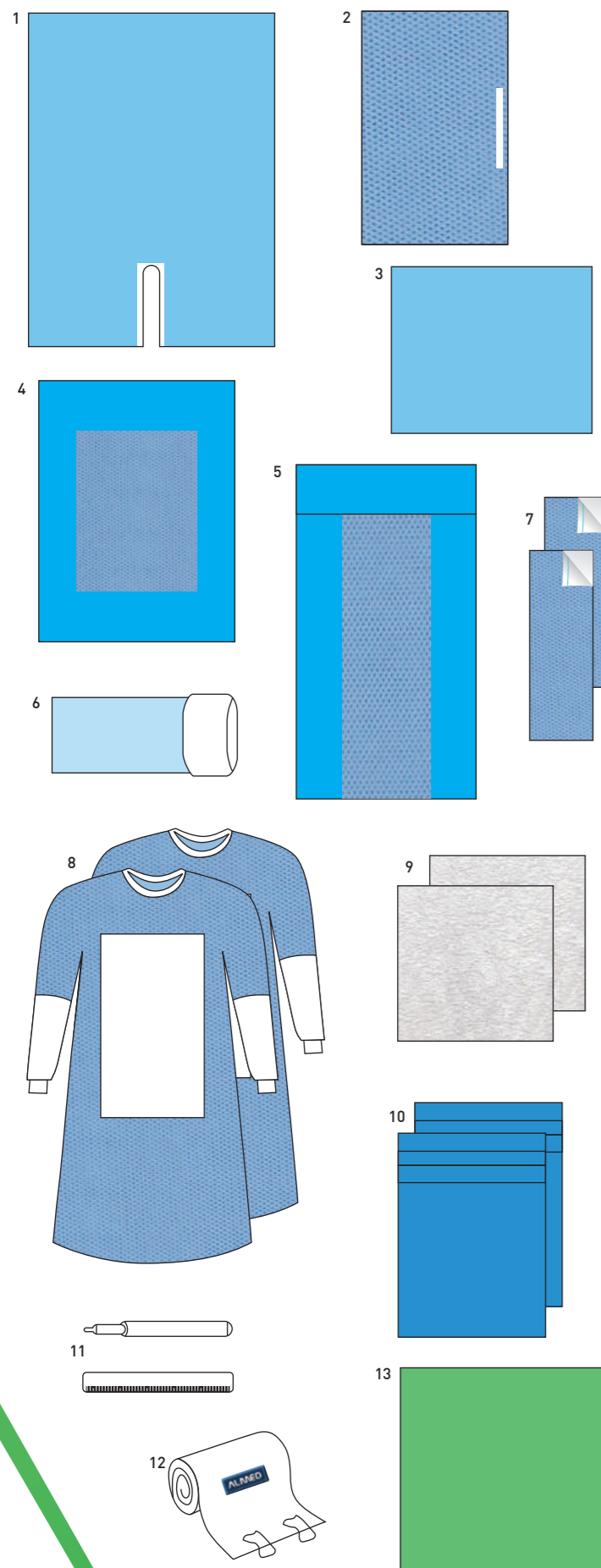

## EL CERRAHİ ÖRTÜ SETİ

HAND SURGERY DRAPE PACK  
TROUSSE DE CHIRURGIE DE LA MAIN  
SET ZA ХИРУРГИЯ НА РЪКАТА

3A020500

Ç	Açıklama	Ebat	Adet
1	Alet Masa Örtüsü PE/NW	150x200 cm	1
2	Extremite Örtüsü	200x300 cm	1
3	Mayo Masa Örtüsü PE/NW	78x145 cm	1
4	Cerrahi Önlük	Korumalı	2
5	Medikal Havlu	40x40 cm	2
6	Sterilizasyon Bohçası	100x100 cm	1

UK	Description	Size	Pieces
1	Back Table Drape PE/NW	150x200 cm	1
2	Extremity Drape	200x300 cm	1
3	Mayo Stand Cover PE/NW	78x145 cm	1
4	Surgical Gown	Reinforced	2
5	Medical Towel	40x40 cm	2
6	Sterilization Wrap	100x100 cm	1

F	Explication	Taille	Pcs
1	Champ de table PE/NW	150x200 cm	1
2	Champ d'extrémité	200x300 cm	1
3	Housse de Mayo PE/NW	78x145 cm	1
4	Casaques chirurgicales	Renforcées	2
5	Essuie-mains	40x40 cm	2
6	Enveloppe de stérilisation	100x100 cm	1

B	Описание	Размер	Зърно
1	Покривало	150x200 cm	1
2	Покривало за масата PE/ NM	200x300 cm	1
3	Покривало за надоперационната масичка PE/ NM	78x145 cm	1
4	Хирургична престилка	защитени	2
5	Медицински кърпи	40x40 cm	2
6	Стерилизация пакет	100x100 cm	1

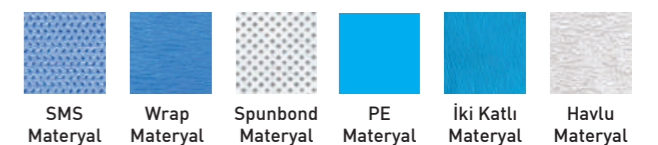

## ANJIOGRAFI ÖRTÜ SETİ

ANGIOGRAPHY DRAPE PACK  
TOUSSE D'ANGIOGRAPHIEA  
SET ZA ANGIOGRAFSKI

3A030100

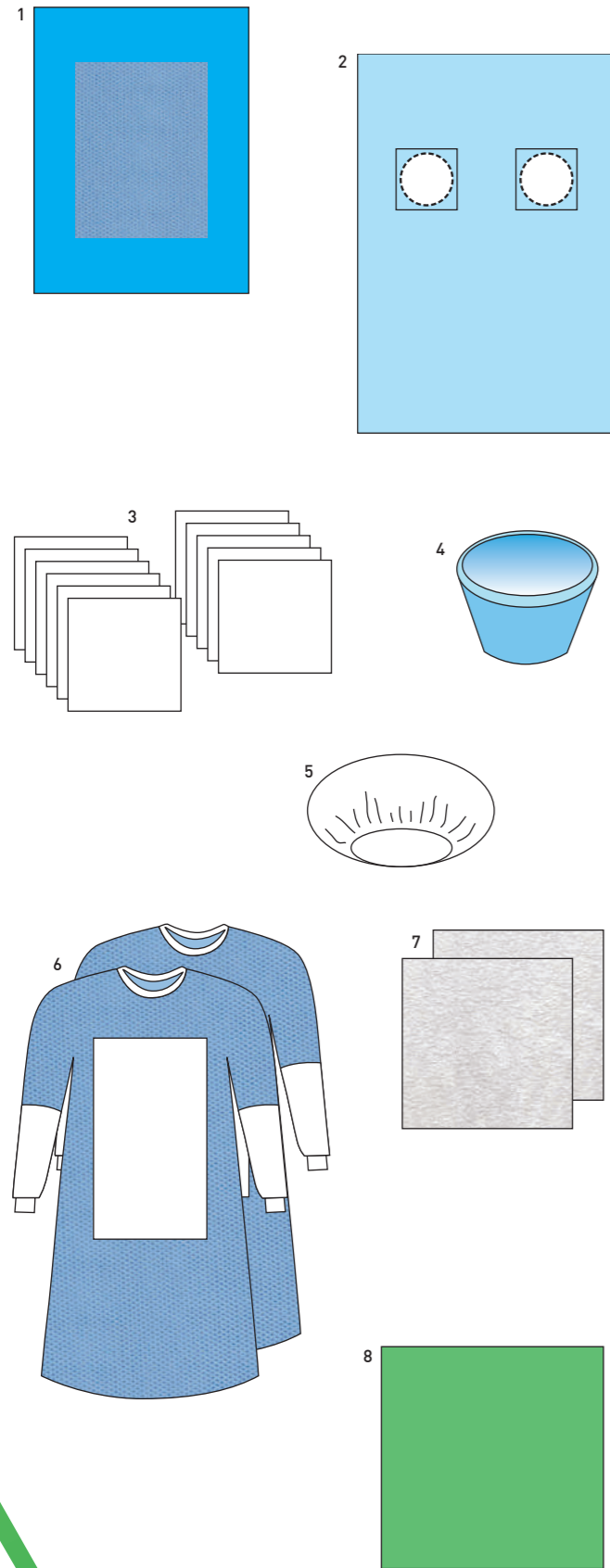

Ç	Açıklama	Ebat	Adet
1	Alet Masa Örtüsü PE/NW	100x150 cm	1
2	Anjio Örtüsü	150x300 cm	1
3	Gazlı Bez	7,5x7,5 cm	10
4	Solüsyon Kâbi	500 cc	1
5	Fluoroskopi Kılıfı	86 cm	1
6	Cerrahi Önlük	Korumalı	2
7	Medikal Havlu	40x40 cm	2
8	Sterilizasyon Bohçası	100x100 cm	1

UK	Description	Size	Pieces
1	Back Table Drape PE/NW	100x150 cm	1
2	Angiography Drape	150x300 cm	1
3	Spanc	7,5x7,5 cm	10
4	Solution Cup	500 cc	1
5	Fluoroscopy Cover	86cm	1
6	Reinforced Surgical Gown	Reinforced	2
7	Medical Towel	40x40 cm	2
8	Sterilization Wrap	100x100 cm	1

FR	Explication	Taille	Pcs
1	Champ de table PE/NW	100x150 cm	1
2	Champ d'angiographie	150x300 cm	1
3	Tampon de gaze	7,5x7,5 cm	10
4	Solition tasse	500 cc	1
5	Couverture de radioscopie	86 cm	1
6	Casaques chirurgicales	Korumalı	2
7	Essuie-mains	40x40 cm	2
8	Enveloppe de stérilisation	100x100 cm	1

RU	Описание	Размер	Зърно
1	Покривало за ангиография	150x300 cm	1
2	Покривало за масата PE/ NM	100x150 cm	1
3	Марли	7,5x7,5 cm	10
4	Калъф за микроскоп	500 cc	1
5	Хирургична престилка	86 cm	1
6	Хирургична престилка	защитени	2
7	Медицински кърпи	40x40 cm	2
8	Стерилизация пакет	100x100 cm	1

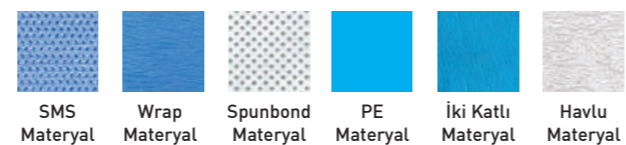

## BY - PASS ÖRTÜ SETİ

BY - PASS DRAPE PACK  
TROUSSE DE BY-PASS  
SET ZA BAÏ PAS OPERACIÏI

3A030200

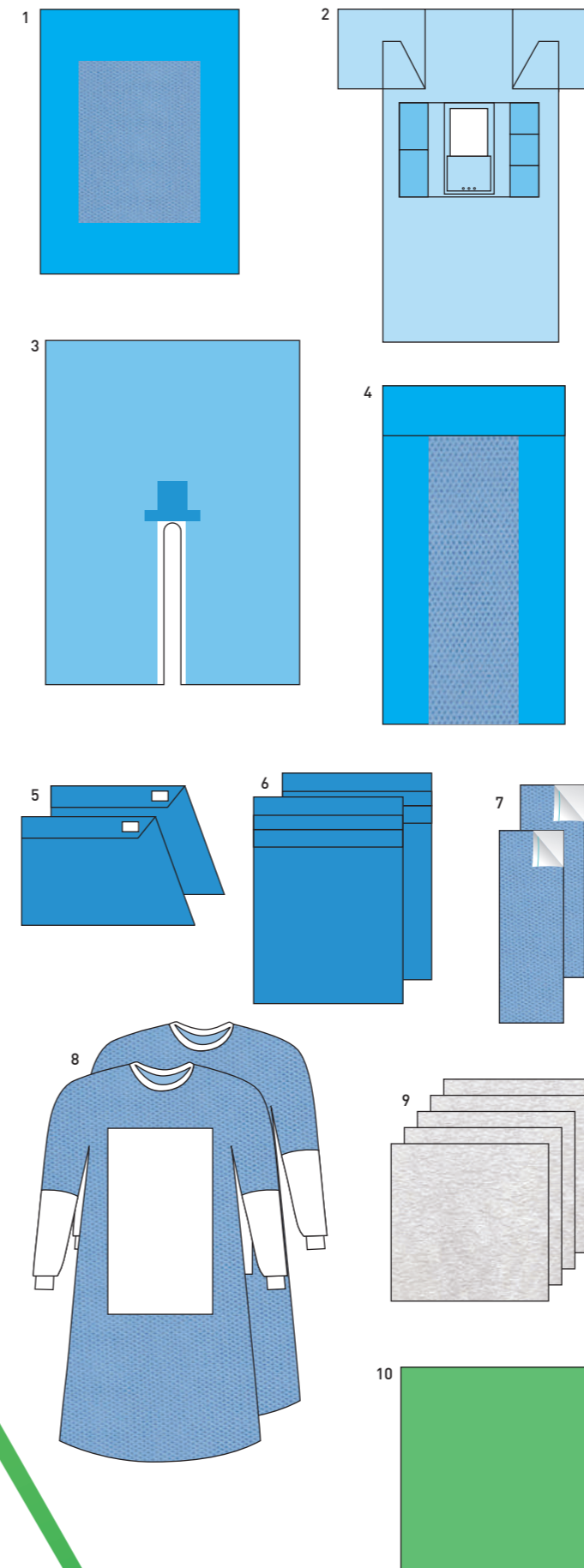

Ç	Açıklama	Ebat	Adet
1	Alet Masa Örtüsü PE/NW	150x200 cm	1
2	By-pass Ana Örtüsü	200x300 cm	1
3	By-pass Alt Örtüsü	150x240 cm	1
4	Mayo Masa Örtüsü	78x145 cm	1
5	Ayaklık	Standart	2
6	Seyyar Cep	28x34 cm	2
7	Yapışkan Bant	10x30 cm	2
8	Cerrahi Önlük	Korumalı	2
9	Medikal Havlu	40x40 cm	5
10	Sterilizasyon Bohçası	100x100 cm	1

UK	Description	Size	Pieces
1	Back Table Drape PE/NW	150x200 cm	1
2	By-pass Drape	200x300 cm	1
3	By - Pass Split Drape	150x240 cm	1
4	Mayo Stand Cover PE/NW	78x145 cm	1
5	Leggings	Standart	2
6	Universal Bag	28x34 cm	2
7	Op - Tape	10x30 cm	2
8	Surgical Gown	Reinforced	2
9	Medical Towel	40x40 cm	5
10	Sterilization Wrap	100x100 cm	1

FR	Explication	Taille	Pcs
1	Champ de table PE/NW	150x200 cm	1
2	Champm de By-Pass	200x300 cm	1
3	Trousse de By-Pass scission drapé	150x240 cm	1
4	Housse de Mayo PE/NW	78x145 cm	1
5	Jambières	Standart	2
6	Mobile Portable	28x34 cm	2
7	Bandelette adhésive	10x30 cm	2
8	Casaques chirurgicales	Renforcées	2
9	Essuie-mains	40x40 cm	5
10	Enveloppe de stérilisation	100x100 cm	1

RU	Описание	Размер	Зърно
1	Горно покривало за бай пас	150x200 cm	1
2	Долно покривало за бай пас	200x300 cm	1
3	Покривало за масата PE/ NM	150x240 cm	1
4	Покривало за над операционната масичка PE/ NM	78x145 cm	1
5	Клин за краката	Standart	2
6	Универсална торба	28x34 cm	2
7	Пляща лента	10x30 cm	2
8	Хирургична престилка	защитени	2
9	Медицински кърпи	40x40 cm	5
10	Стерилизация пакет	100x100 cm	1

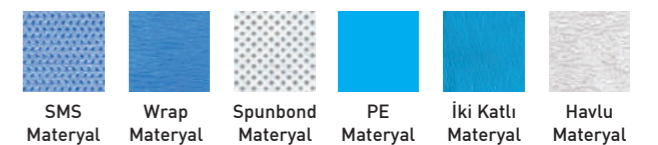

## KAPAK DEĞİŞİM ÖRTÜ SETİ

VALVE REPLACEMENT DRAPE PACK  
TROUSSE LE REMPLACEMENT VALVULAIRE  
SET ZA KLAŖNO PROTETIZIRANE

3A030300

Ç	Açıklama	Ebat	Adet
1	Alet Masa Örtüsü PE/NW	150x200 cm	1
2	K.V.C. Örtüsü	200x350 cm	1
3	Mayo Masa Örtüsü	78x145 cm	1
4	Yapışkan Bant	10x30 cm	2
5	Seyyar Cep	30x35 cm	2
6	Cerrahi Önlük	Korumalı	2
7	Medikal Havlu	40x40 cm	2
8	Sterilizasyon Bohçası	100x100 cm	1

UK	Description	Size	Pieces
1	Back Table Drape PE/NW	150x200 cm	1
2	K.V.C. Drape	200x350 cm	1
3	Mayo Stand Cover Pe/nw	78x145 cm	1
4	Op - Tape	10x30 cm	2
5	Universal Bag	30x35 cm	2
6	Surgical Gown	Reinforced	2
7	Medical Towel	40x40 cm	2
8	Sterilization Wrap	100x100 cm	1

FR	Explication	Taille	Pcs
1	Champ de table PE/NW	150x200 cm	1
2	Trousse de cardio-vasculaires	200x350 cm	1
3	Housse de Mayo PE/NW	78x145 cm	1
4	Bandelette adhésive	10x30 cm	2
5	Mobile Portable	30x35 cm	2
6	Casaques chirurgicales	Renforcées	2
7	Essuie-mains	40x40 cm	2
8	Enveloppe de stérilisation	100x100 cm	1

RU	Описание	Размер	Зърно
1	K.V.C. покривало	150x200 cm	1
2	Покривало за масата PE/ NM	200x350 cm	1
3	Покривало за над операционната масичка PE/ NM	78x145 cm	1
4	Съд за разтвор	10x30 cm	2
5	Калъф за микроскоп	30x35 cm	2
6	Хирургична престилка	защитени	2
7	Медицински кърпи	40x40 cm	2
8	Стерилизация пакет	100x100 cm	1

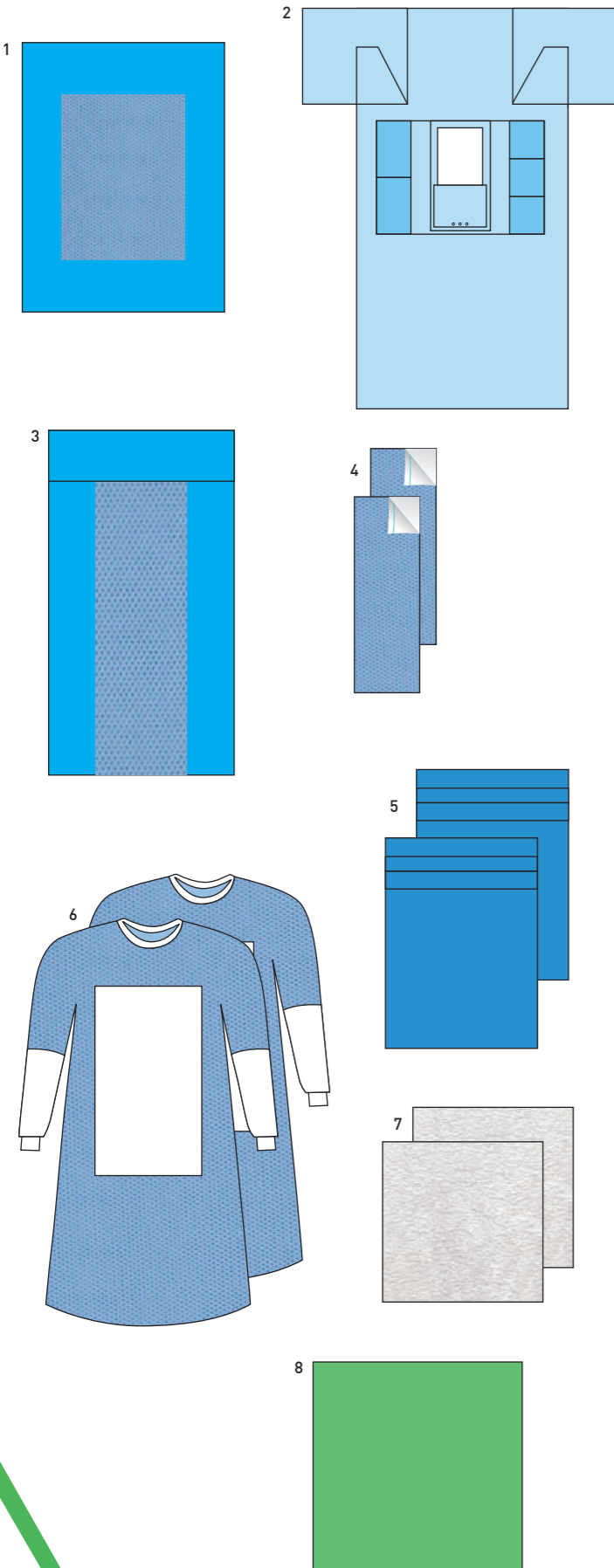
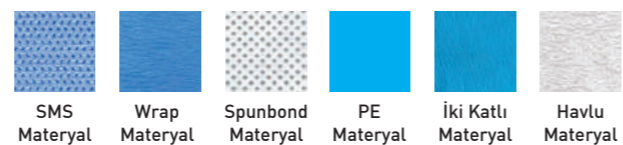

## KARDİOVASKÜLER ÖRTÜ SETİ

CARDIOVASCULAR DRAPE PACK  
CHAMPS CARDIO-VASCULAIRES  
SET ZA KARDİOVASKULARNA OPERACIJA

3A030400

Ç	Açıklama	Ebat	Adet
1	Yan Bantlı Örtü	50x90 cm	1
2	Yan Bantlı Örtü	100x100 cm	1
3	Yan Bantlı Örtü	150x200 cm	1
4	Alet Masa Örtüsü PE/NW	150x200 cm	1
5	Mayo Masa Örtüsü	78x145 cm	1
6	Cerrahi Önlük	Korumalı	2
7	Medikal Havlu	40x40 cm	2
8	Sterilizasyon Bohçası	100x100 cm	1

UK	Description	Size	Pieces
1	Drape With Adhesive	50x90 cm	1
2	Drape With Adhesive	100x100 cm	1
3	Drape With Adhesive	150x200 cm	1
4	Back Table Drape PE/NW	150x200 cm	1
5	Mayo Stand Cover PE/NW	78x145 cm	1
6	Reinforced Surgical Gown	Reinforced	2
7	Medical Towel	40x40 cm	2
8	Sterilization Wrap	100x100 cm	1

FR	Explication	Taille	Pcs
1	Champ adhésif	50x90 cm	1
2	Champ adhésif	100x100 cm	1
3	Champ adhésif	150x200 cm	1
4	Champ de table PE/NW	150x200 cm	1
5	Housse de Mayo PE/NW	78x145 cm	1
6	Casaques chirurgicales	Renforcées	2
7	Essuie-mains	40x40 cm	2
8	Enveloppe de stérilisation	100x100 cm	1

RU	Описание	Размер	Зърно
1	Покривало с адхезия	50x90 cm	1
2	Покривало с адхезия	100x100 cm	1
3	Покривало с адхезия	150x200 cm	1
4	Покривало за масата PE/ NM	150x200 cm	1
5	Покривало за над операционната масичка PE/ NM	78x145 cm	1
6	Хирургична престилка	защитени	2
7	Медицински кърпи	40x40 cm	2
8	Стерилизация пакет	100x100 cm	1

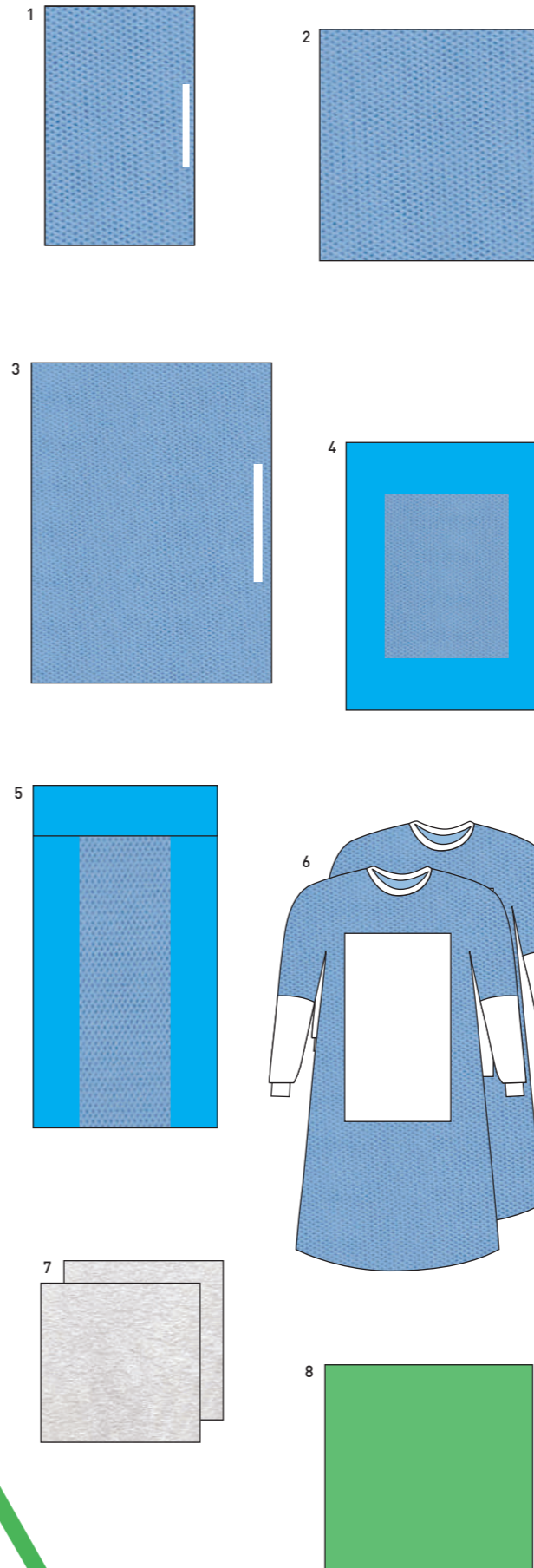
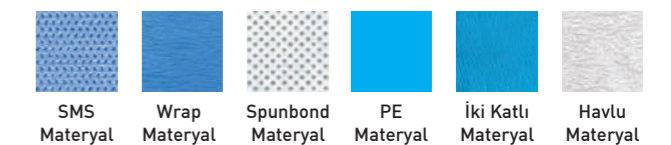

## DOĞUM ÖRTÜ SETİ

DELIVERY DRAPE SET  
TROUSSE DÉLIVRAISON  
SET ЗА РАЖДАНЕ

3A040200

Açıklama	Ebat	Adet
1 Yan Bantlı Örtü	75x150 cm	1
2 Bebek Örtüsü	75x75 cm	1
3 Alet Masa Örtüsü PE/NW	100x150 cm	1
4 Düz Örtü	75x100 cm	1
5 Bacak Kılıfı	30x120 cm	2
6 Kadın Bağı	Büyük	2
7 Cerrahi Önlük	Korumalı	2
8 Medikal Havlu	40x40 cm	2
9 Sterilizasyon Bohçası	100x100 cm	1

Description	Size	Pieces
1 Drape With Adhesive	75x150 cm	1
2 Baby Drape	75x75 cm	1
3 Back Table Drape PE/NW	100x150 cm	1
4 Drape	75x100 cm	1
5 Leg Drape	30x120 cm	2
6 Cetamenial	Large	2
7 Surgical Gown	Reinforced	2
8 Medical Towel	40x40 cm	2
9 Sterilization Wrap	100x100 cm	1

Explication	Taille	Pcs
1 Champ adhésif	75x150 cm	1
2 Champ de Bébé drapé	75x75 cm	1
3 Champ de table PE/NW	100x150 cm	1
4 Champ	75x100 cm	1
5 Stockinette	30x120 cm	2
6 Serviette hygiénique	Large	2
7 Casaques chirurgicales	Renforcées	2
8 Essuie-mains	40x40 cm	2
9 Enveloppe de stérilisation	100x100 cm	1

Описание	Размер	Зърно
1 Покривало с адхезия	75x150 cm	1
2 Покривало за бебето	75x75 cm	1
3 Покривало за масата PE/ NM	100x150 cm	1
4 Покривало	75x100 cm	1
5 Покривало за крака	30x120 cm	2
6 Дамска превръзка	голям	2
7 Хирургична престилка	защитени	2
8 Медицински кърпи	40x40 cm	2
9 Стерилизация пакет	100x100 cm	1

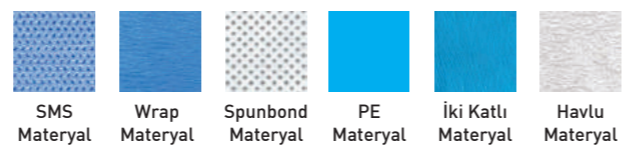

SMS Materyal Wrap Materyal Spunbond Materyal PE Materyal İki Katlı Materyal Havlu Materyal

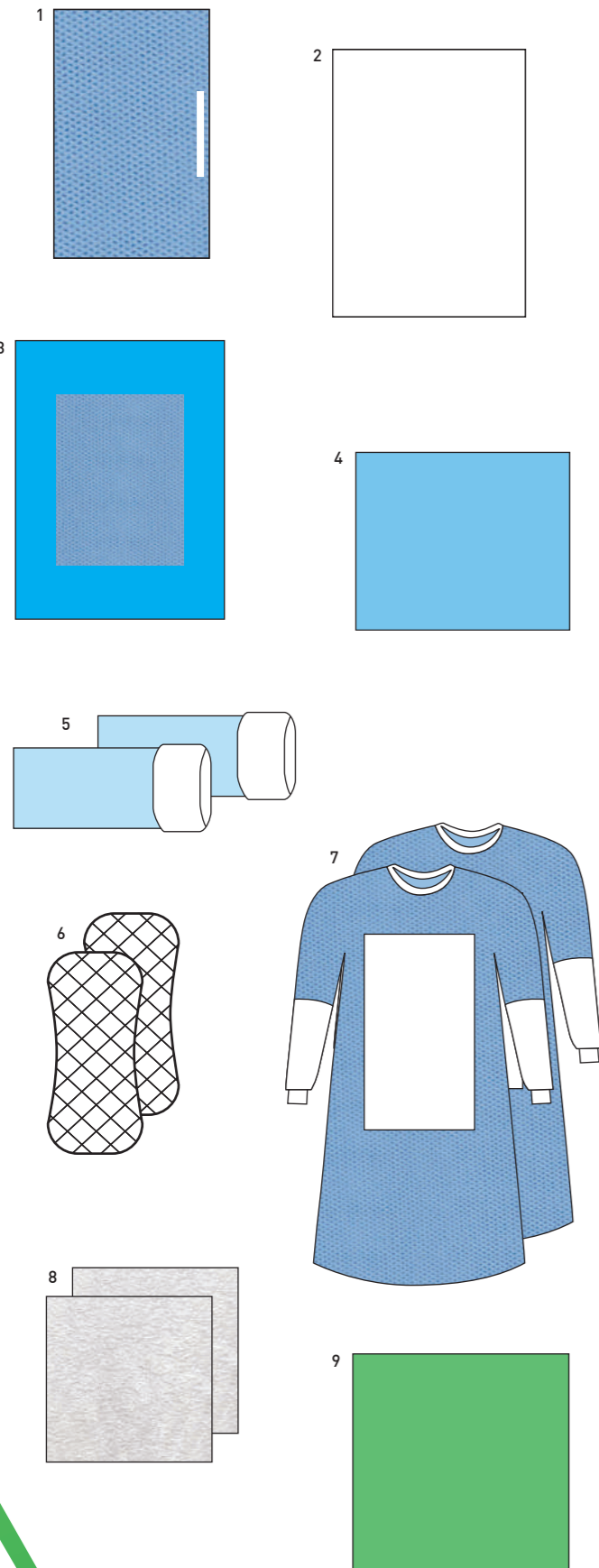

## I.V.F. ÖRTÜ SETİ ( TÜP BEBEK )

I.V.F. DRAPE SET  
TROUSSE DE I.V.F.  
SET ЗА ИИ ВИТРО

3A040300

Açıklama	Ebat	Adet
1 Alet Masa Örtüsü PE/NW	150x200 cm	1
2 I.V.F. Örtüsü	150x225 cm	1
3 Bacak Kılıfı	50x120 cm	2
4 Gazlı Bez	7,5x7,5 cm	10
5 Ünlversal Torba	50x60 cm	1
6 Kamera Kılıfı	13x250 cm	1
7 Cerrahi Önlük	Korumalı	2
8 Medikal Havlu	40x40 cm	2
9 Sterilizasyon Bohçası	100x100 cm	1

Description	Size	Pieces
1 Back Table Drape PE/NW	150x200 cm	1
2 I.V.F. Drape	150x225 cm	1
3 Leg Drape	50x120 cm	2
4 Spanc	7,5x7,5 cm	10
5 Universal Bag	50x60 cm	1
6 Video Camera Cover	13x250 cm	1
7 Surgical Gown	Reinforced	2
8 Medical Towel	40x40 cm	2
9 Sterilization Wrap	100x100 cm	1

Explication	Taille	Pcs
1 Champ de table PE/NW	150x200 cm	1
2 Champ de I.V.F.	150x225 cm	1
3 Stockinette	50x120 cm	2
4 Tampon de gaze	7,5x7,5 cm	10
5 Poche à intruments	50x60 cm	1
6 Housse de caméra	13x250 cm	1
7 Casaques chirurgicales	Renforcées	2
8 Essuie-mains	40x40 cm	2
9 Enveloppe de stérilisation	100x100 cm	1

Описание	Размер	Зърно
1 Ин витро покривало	150x200 cm	1
2 Покривало за масата PE/ NM	150x225 cm	1
3 Покривало за крака	50x120 cm	2
4 Марли	7,5x7,5 cm	10
5 Универсална торба	50x60 cm	1
6 Калъф за камера	13x250 cm	1
7 Хирургична престилка	защитени	2
8 Медицински кърпи	40x40 cm	2
9 Стерилизация пакет	100x100 cm	1

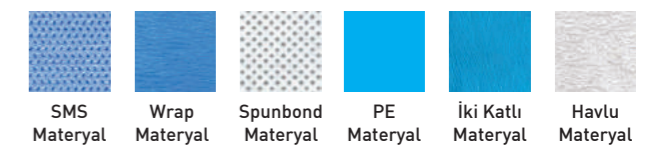

SMS Materyal Wrap Materyal Spunbond Materyal PE Materyal İki Katlı Materyal Havlu Materyal

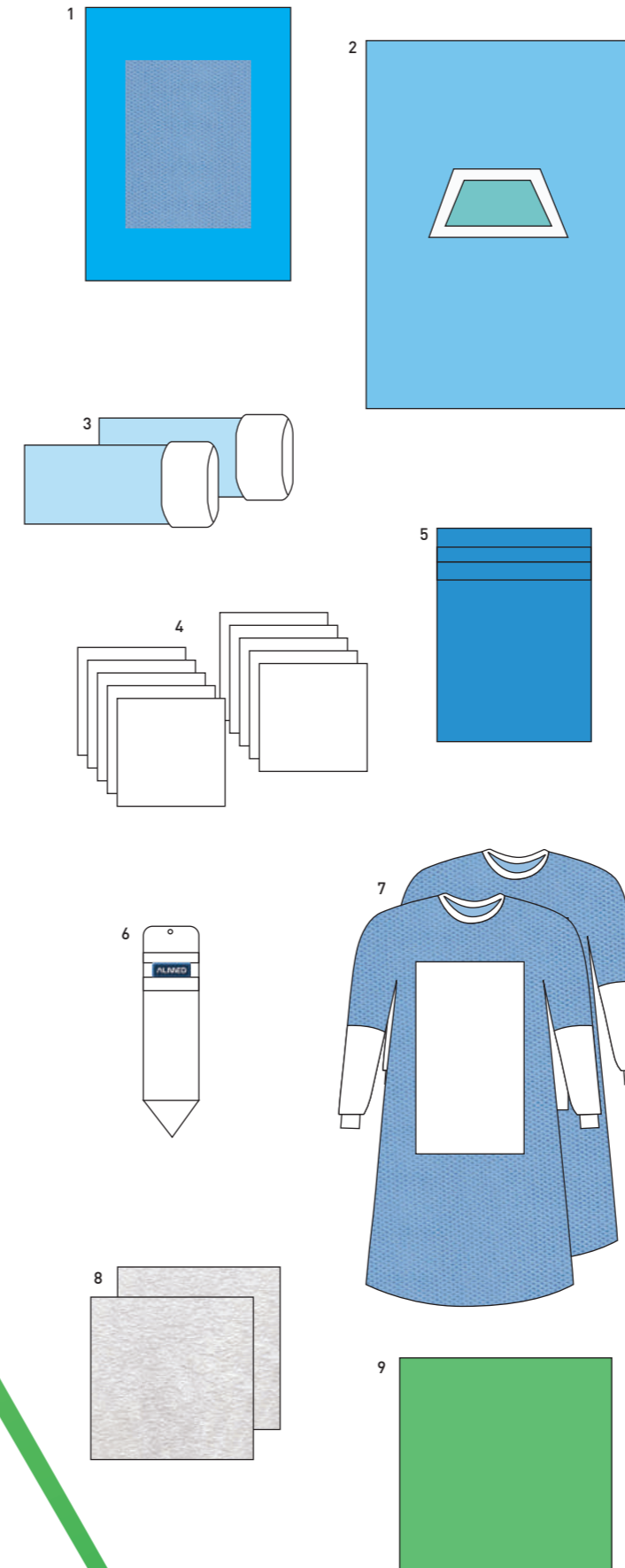

## SEZERYAN ÖRTÜ SETİ

CAESAREAN DRAPE SET  
TROUSSE DE CÉSARIENNE  
SET ЗА ЦЕЗАРОВО СЕЧЕНИЕ

3A04000

Açıklama	Ebat	Adet
1 Bebek Örtüsü	75x75 cm	1
2 Sezeryan Örtüsü	240x300 cm	1
3 Alet Masa Örtüsü Pe/nw	100x150 cm	1
4 Cerrahi Önlük	Korumalı	2
5 Medikal Havlu	40x40 cm	2
6 Sterilizasyon Bohçası	100x100 cm	1

Description	Size	Pieces
1 Baby Drape	75x75 cm	1
2 Caesarean Drape	240x300 cm	1
3 Back Table Drape PE/NW	100x150 cm	1
4 Reinforced Surgical Gown	Reinforced	2
5 Medical Towel	40x40 cm	2
6 Sterilization Wrap	100x100 cm	1

Explication	Taille	Pcs
1 Champ de bébé	75x75 cm	1
2 Champ de césarienne	240x300 cm	1
3 Champ de table PE/NW	100x150 cm	1
4 Casaques chirurgicales	Renforcées	2
5 Essuie-mains	40x40 cm	2
6 Enveloppe de stérilisation	100x100 cm	1

Описание	Размер	Зърно
1 Покривало за цезарово сечение	75x75 cm	1
2 Покривало за бебе	240x300 cm	1
3 Покривало за масата PE/ NM	100x150 cm	1
4 Хирургични ръкавици	защитени	2
5 Медицински кърпи	40x40 cm	2
6 Стерилизационен пакет	100x100cm	1

## QUART ÖRTÜ SETİ

QUAR DRAPE SET  
TROUSSE DE QUART  
SET ЗА ЦЕЗАРОВО СЕЧЕНИЕ

3A040600

Açıklama	Ebat	Adet
1 Düz Örtü	40x40 cm	1
2 Saplı Sünger	-	1
3 Anti Jel	-	1
4 Prob Naylonu	-	1

Description	Size	Pieces
1 Drape	40x40 cm	1
2 Betadine Spange	-	1
3 Anti Jel	-	1
4 Prob Nylon	-	1

Explication	Taille	Pcs
1 Champ	40x40 cm	1
2 Champ de table PE/NW	-	1
3 Contre jel	-	1
4 Prob Nylon	-	1

Описание	Размер	Зърно
1 Покривало	40x40 cm	1
2 Гъба с дръжка	-	1
3 Анти гел	-	1
4 Опаковка за проба	-	1

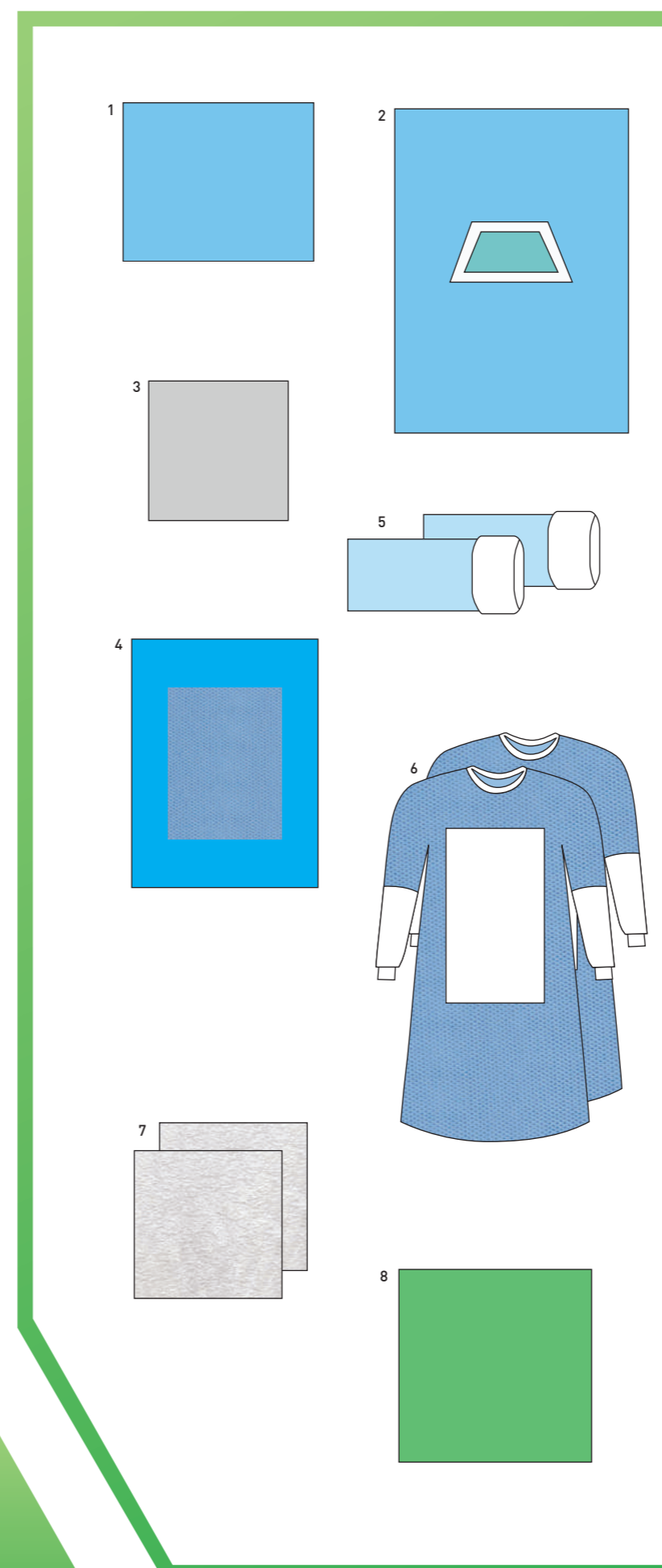
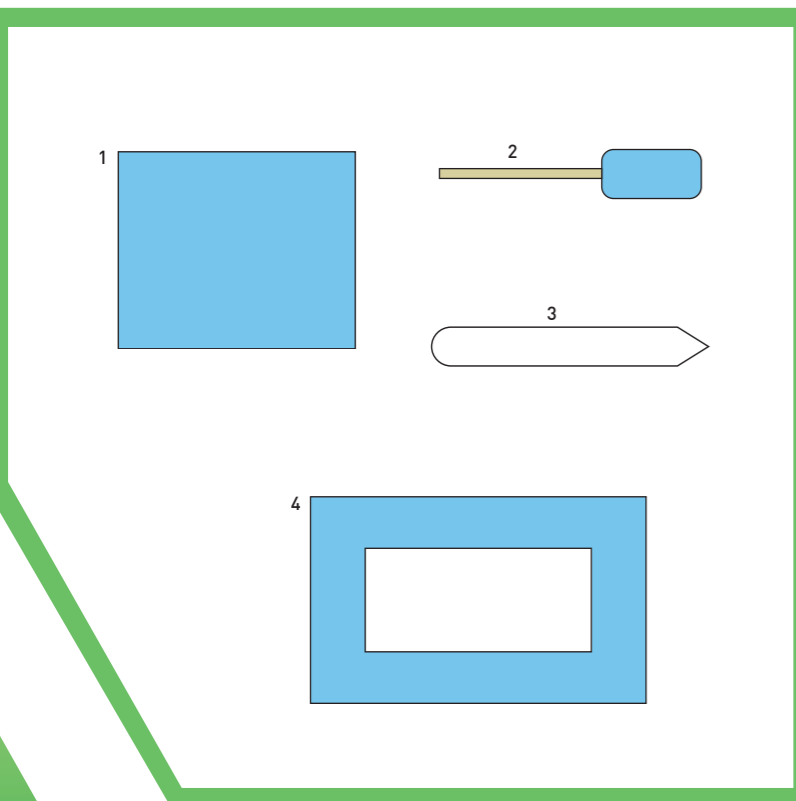
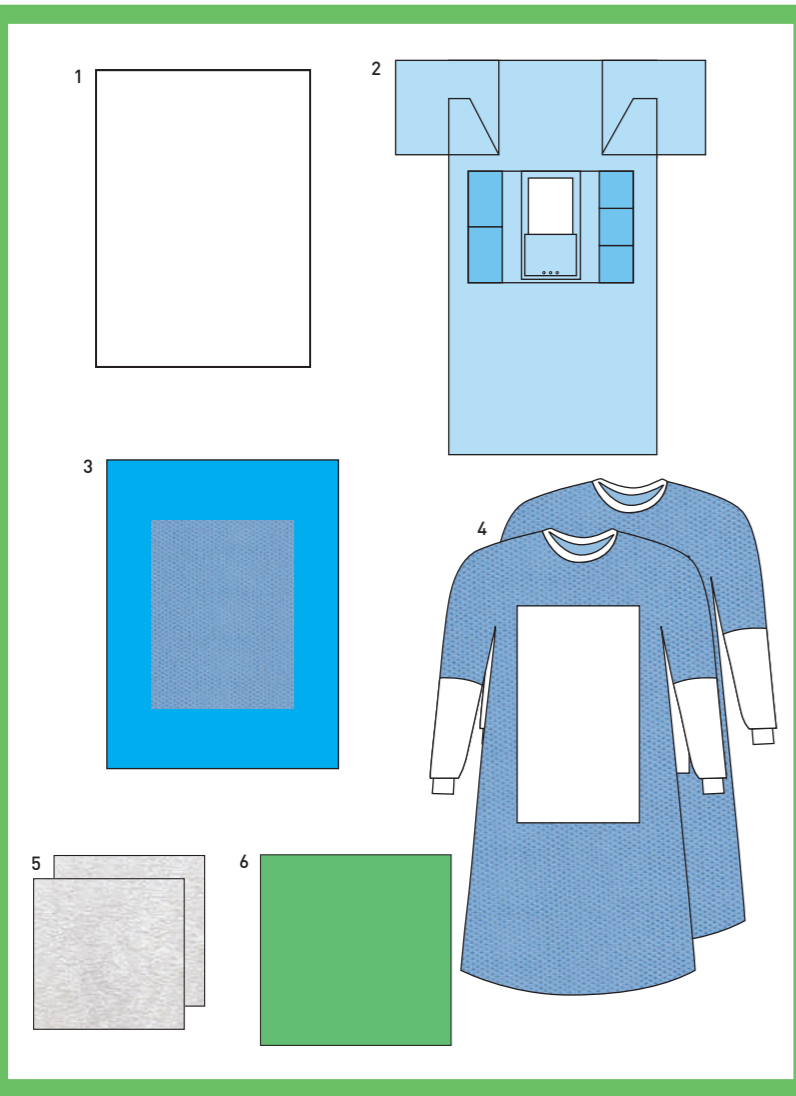

## O.P.U. ÖRTÜ SETİ

O.P.U. DRAPE SET  
TROUSSE DE O.P.U.  
SET ЗА ИИ ВИПРО О.Р.У.

3A040500

Açıklama	Ebat	Adet
1 Düz Örtü	100x100 cm	1
2 O.P.U. Örtüsü	130x150 cm	1
3 Şeffaf Örtü	60x60 cm	1
4 Alet Masa Örtüsü PE/NW	100x150 cm	1
5 Bacak Kılıfı	60x115 cm	2
6 Cerrahi Önlük	Korumalı	2
7 Medikal Havlu	40x40 cm	2
8 Sterilizasyon Bohçası	100x100 cm	1

Description	Size	Pieces
1 Drape	100x100 cm	1
2 O.P.U. Drape	130x150 cm	1
3 Transparent Drape	60x60 cm	1
4 Back Table Drape PE/NW	100x150 cm	1
5 Leg Drape	60x115 cm	2
6 Surgical Gown	Reinforced	2
7 Medical Towel	40x40 cm	2
8 Sterilization Wrap	100x100 cm	1

Explication	Taille	Pcs
1 Champ	100x100 cm	1
2 Champ de O.P.U.	130x150 cm	1
3 Champ à inciser	60x60 cm	1
4 Champ de table PE/NW	100x150 cm	1
5 Stockinette	60x115 cm	2
6 Casaques chirurgicales	Renforcées	2
7 Essuie-mains	40x40 cm	2
8 Enveloppe de stérilisation	100x100 cm	1

Описание	Размер	Зърно
1 O.P.U. покривало	100x100 cm	1
2 Покривало	130x150 cm	1
3 Прозрачно покривало	60x60 cm	1
4 Покривало за масата PE/ NM	100x150 cm	1
5 Покривало за крака	60x115 cm	2
6 Хирургична престилка	защитени	2
7 Медицинска престилка	40x40 cm	2
8 Стерилизационен пакет	100x100 cm	1

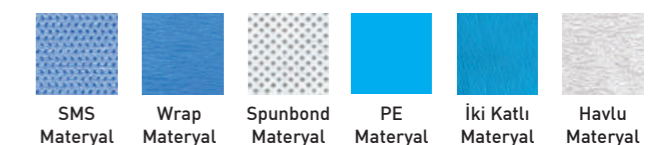

## KRANIOTOMİ ÖRTÜ SETİ

CRANIOTOMY SURGICAL PACK  
TORUSSE DE CRANIOTOMIE  
SET ZA NEBROXIRURGIJA

3A050100

Açıklama	Ebat	Adet
1 Düz Örtü	150x250 cm	2
2 Kraniotomi Örtüsü	250x280 cm	1
3 Yan Bantlı Düz Örtü	100x100 cm	4
4 Alet Masa Örtüsü PE/NW	150x200 cm	1
5 Mayo Masa Örtüsü	78x145 cm	1
6 Gazlı Bez	7,5x7,5 cm	10
7 Cilt Kalem - Cetvel	-	1
8 Cerrahi Önlük	Korumalı	2
9 Medikal Havlu	40x40 cm	2
10 Sterilizasyon Bohçası	100x100 cm	1

Description	Size	Pieces
1 Drape	150x250 cm	2
2 Craniotomy Drape	250x280 cm	1
3 Drape With Adhesive	100x100 cm	4
4 Back Table Drape PE/NW	150x200 cm	1
5 Mayo Stand Cover PE/NW	78x145 cm	1
6 Spunc	7,5x7,5 cm	10
7 Marker - Ruler	-	1
8 Surgical Gown	Reinforced	2
9 Medical Towel	40x40 cm	2
10 Sterilization Wrap	100x100 cm	1

Explication	Taille	Pcs
1 Champ	150x250 cm	2
2 Champ de craniotomie	250x280 cm	1
3 Champ adhésif	100x100 cm	4
4 Champ de table PE/NW	150x200 cm	1
5 Housse de Mayo PE/NW	78x145 cm	1
6 Tampon de gaze	7,5x7,5 cm	10
7 Marqueur — Dirigeant	-	1
8 Casaques chirurgicales	Renforcées	2
9 Essuie-mains	40x40 cm	2
10 Enveloppe de stérilisation	100x100 cm	1

Описание	Размер	Зърно
1 Сет за неврохирургия	150x250 cm	2
2 Покривало	250x280 cm	1
3 Покривало с адхезия	100x100 cm	4
4 Покривало за масата PE/ NM	150x200 cm	1
5 Покривало за над операционната масичка PE/ NM	78x145 cm	1
6 Марли	7,5x7,5 cm	10
7 Маркер за кожа	-	1
8 Хирургична престипка	защитени	2
9 Медицински кърпи	40x40 cm	2
10 Стерилизация пакет	100x100 cm	1

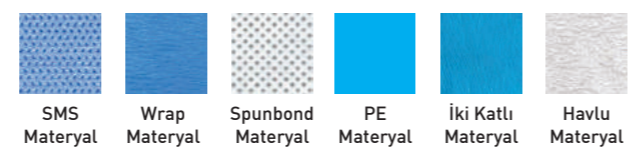

SMS Materyal Wrap Materyal Spunbond Materyal PE Materyal İki Katlı Materyal Havlu Materyal

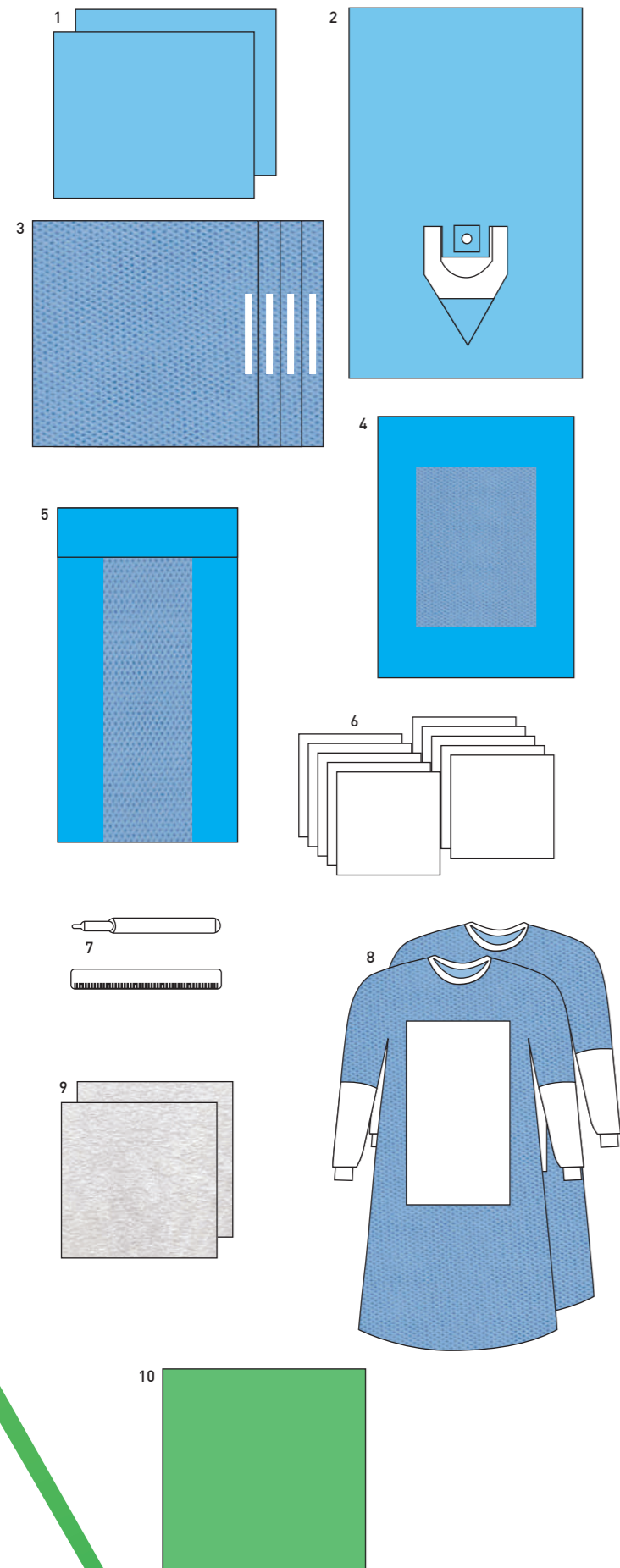

SMS Materyal Wrap Materyal Spunbond Materyal PE Materyal İki Katlı Materyal Havlu Materyal

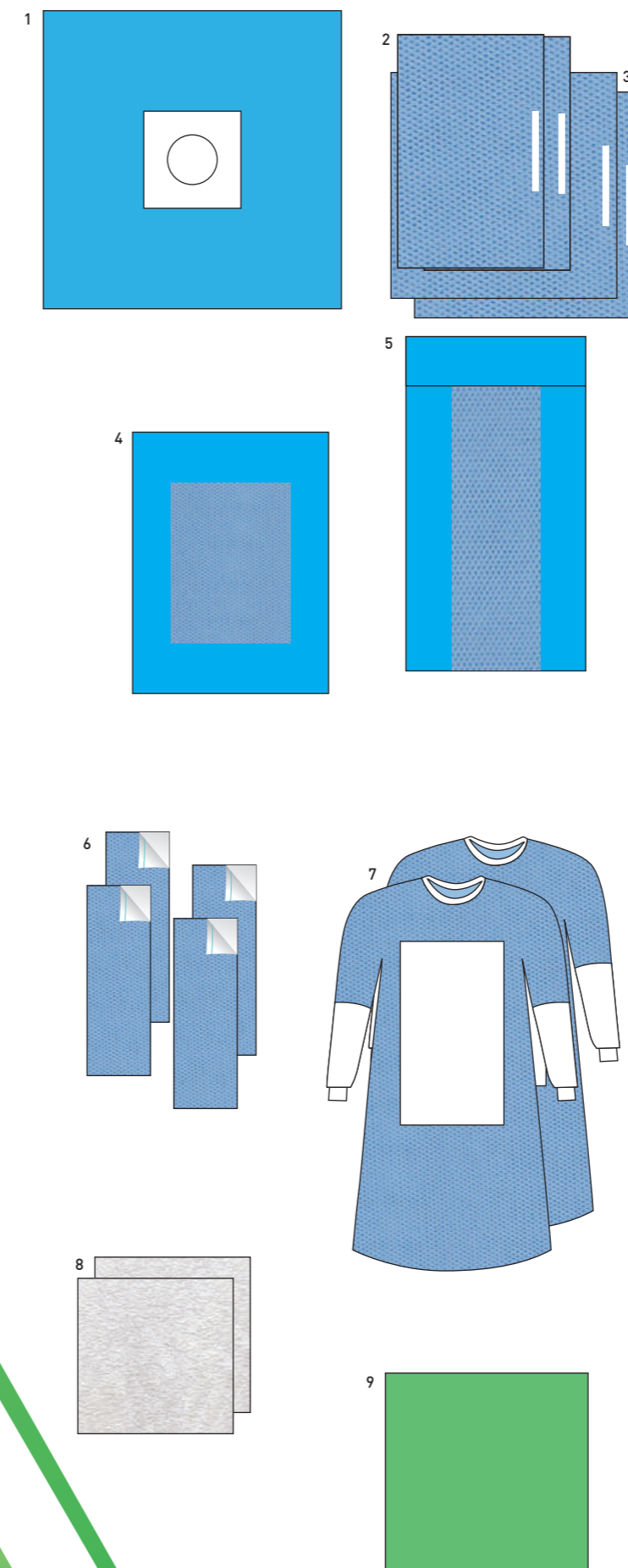

## SPİNAL ÖRTÜ SETİ

SPINAL SURGICAL PACK  
TROUSSE DE SPINAL  
SET ZA SPİNALNA XİRURGIJA

3A050300

Açıklama	Ebat	Adet
1 Bantlı Delikli Örtü	150x200 cm	1
2 Bantlı Örtü	100x150 cm	2
3 Bantlı Örtü	150x160 cm	2
4 Alet Masa Örtüsü PE/NW	100x150 cm	1
5 Mayo Masa Örtüsü	78x145 cm	1
6 Yapışkan Bant	10x30 cm	4
7 Cerrahi Önlük	Korumalı	2
8 Medikal Havlu	40x40 cm	2
9 Sterilizasyon Bohçası	100x100 cm	1

Description	Size	Pieces
1 Fenest Drape With Adhesive	150x200 cm	1
2 Drape With Adhesive	100x150 cm	2
3 Drape With Adhesive	150x160 cm	2
4 Back Table Drape PE/NW	100x150 cm	1
5 Mayo Stand Cover PE/NW	78x145 cm	1
6 Op - Tape	10x30 cm	4
7 Surgical Gown	Reinforced	2
8 Medical Towel	40x40 cm	2
9 Sterilization Wrap	100x100 cm	1

Explication	Taille	Pcs
1 Champ de la fenêtre	150x200 cm	1
2 Champ adhésif	100x150 cm	2
3 Champ adhésif	150x160 cm	2
4 Champ de table PE/NW	100x150 cm	1
5 Housse de Mayo PE/NW	78x145 cm	1
6 Bandelette adhésive	10x30 cm	4
7 Casaques chirurgicales	Renforcées	2
8 Essuie-mains	40x40 cm	2
9 Enveloppe de stérilisation	100x100 cm	1

Описание	Размер	Зърно
1 Покривало с адхезия ,дупка и ленти	150x200 cm	1
2 Покривало с адхезия	100x150 cm	2
3 Покривало с адхезия	150x160 cm	2
4 Покривало за масата PE/ NM	100x150 cm	1
5 Покривало за над операционната масичка PE/ NM	78x145 cm	1
6 Лепяща лента	10x30 cm	4
7 Хирургична престипка	защитени	2
8 Медицински кърпи	40x40 cm	2
9 Стерилизация пакет	100x100 cm	1

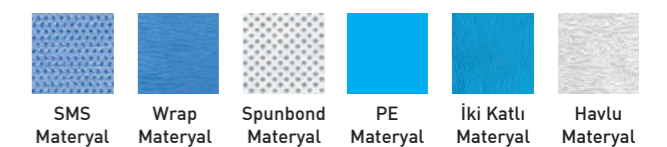

SMS Materyal Wrap Materyal Spunbond Materyal PE Materyal İki Katlı Materyal Havlu Materyal

## GÖZ ÖRTÜ SETİ 1

EYE DRAPE SET 1  
TROUSSE AVEC AIRE À INCISER ET POCHE DE RECUEIL  
SET ZA OČNI OPERACIJI-1

3A060100

Acıklama	Ebat	Adet
1 Tek Poşlu Göz Örtüsü	100x150 cm	1
2 Düz Örtü	150x180 cm	1
3 Alet Masa Örtüsü PE/NW	100x150 cm	1
4 Cerrahi Önlük	Standart	2
5 Medikal Havlu	40x40 cm	2
6 Sterilizasyon Bohçası	100x100 cm	1

Description	Size	Pieces
1 Fenestrated Eye Drape With Single Drape	100x150 cm	1
2 Drape	150x180 cm	1
3 Back Table Drape PE/NW	100x150 cm	1
4 Sugical Gown	Standart	2
5 Medical Towel	40x40 cm	2
6 Sterilization Wrap	100x100	1

Explication	Taille	Pcs
1 Champ avec aire à inciser et poche de recueil	100x150 cm	1
2 Champ	150x180 cm	1
3 Champ de table PE/NW	100x150 cm	1
4 Casaques chirurgicales	Standart	2
5 Essuie-mains	40x40 cm	2
6 Enveloppe de stérilisation	100x100	1

Описание	Размер	Зърно
1 Перфорирано покривало за очи с една част	100x150 cm	1
2 Покривало	150x180 cm	1
3 Покривало за масата PE/ NM	100x150 cm	1
4 Хирургични престилки	Standart	2
5 Медицински кърпи	40x40 cm	2
6 Стерилизация пакет	100x100	1

## LAZER GÖZ ÖRTÜ SETİ

LASER EYE DRAPE SET  
CHIRURGIE GENERALE SET  
SET ZA LAZER NA OKOTOTO

Acıklama	Ebat	Adet
1 Nylon PE	80x120 cm	1

Description	Size	Pieces
1 Nylon PE	80x120 cm	1

Explication	Taille	Pcs
1 Nylon PE	80x120 cm	1

Описание	Размер	Зърно
1 PE Найлон	80x120 cm	1

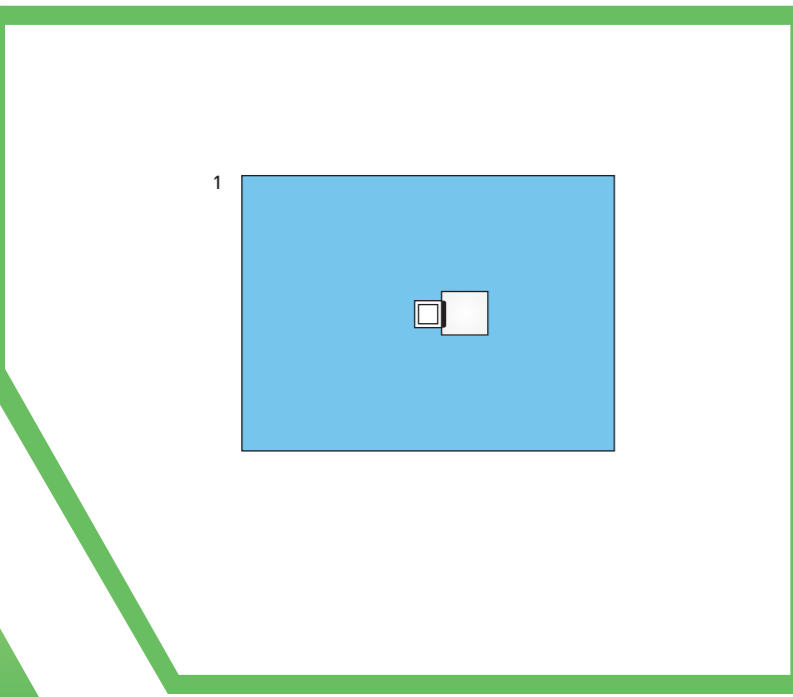
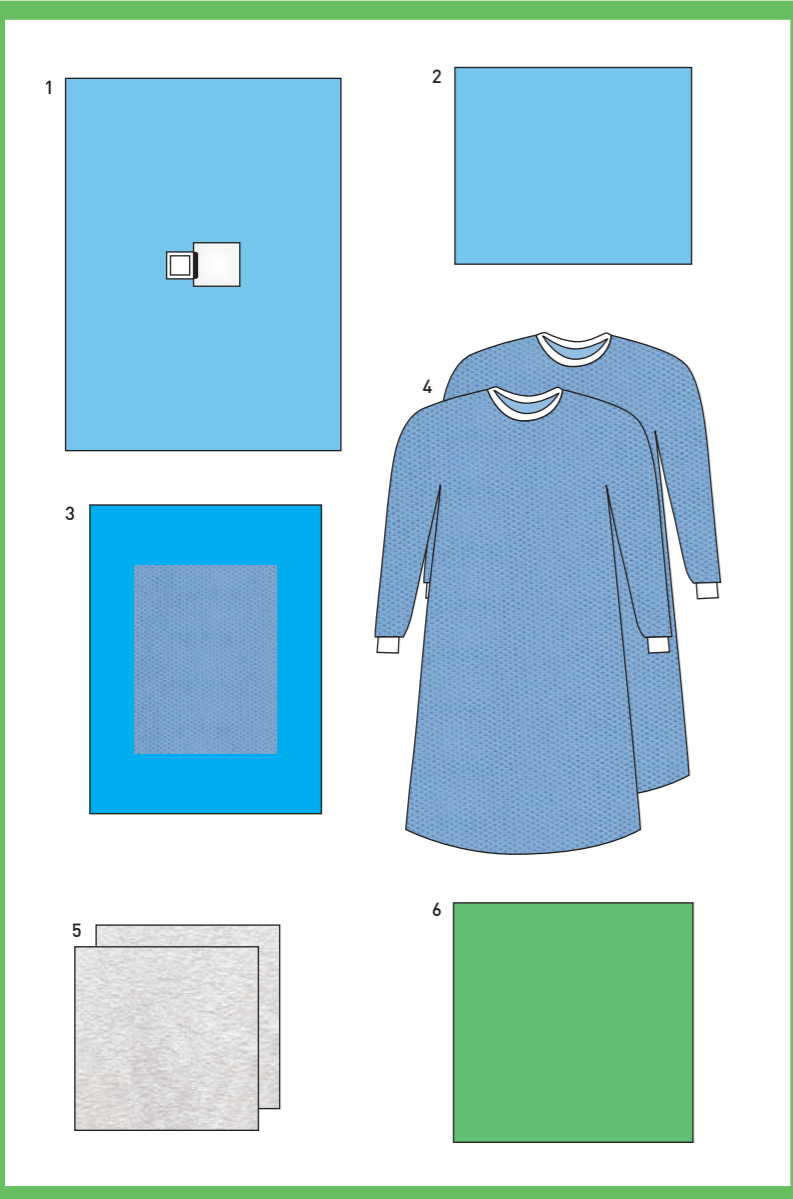
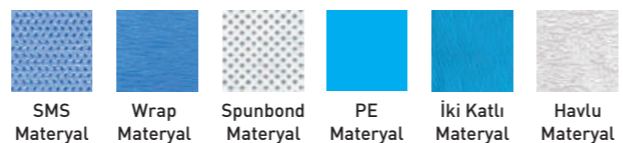

## GÖZ ÖRTÜ SETİ 2

EYE DRAPE SET 2  
TROUSSE AVEC AIRE À INCISER ET POCHE DE RECUEIL (DEUX)  
SET ZA OČNI OPERACIJI-2

3A060200

Acıklama	Ebat	Adet
1 Çift Poşlu Göz Örtüsü	135x240 cm	1
2 Düz Örtü	150x180 cm	1
3 Alet Masa Örtüsü PE/NW	100x150 cm	1
4 Cerrahi Önlük	Standart	2
5 Medikal Havlu	40x40 cm	2
6 Sterilizasyon Bohçası	100x100 cm	1

Description	Size	Pieces
1 Fenestrated Eye Drape With Double	135x240 cm	1
2 Drape	150x180 cm	1
3 Back Table Drape PE/NW	100x150 cm	1
4 Sugical Gown	Standart	2
5 Medical Towel	40x40 cm	2
6 Sterilization Wrap	100x100 cm	1

Explication	Taille	Pcs
1 Champ avec aire à inciser et poche de recueil	135x240 cm	1
2 Champ	150x180 cm	1
3 Champ de table PE/NW	100x150 cm	1
4 Casaques chirurgicales	Standart	2
5 Essuie-mains	40x40 cm	2
6 Enveloppe de stérilisation	100x100 cm	1

Описание	Размер	Зърно
1 Перфорирано покривало за очи с две части	135x240 cm	1
2 Покривало	150x180 cm	1
3 Покривало за масата PE/ NM	100x150 cm	1
4 Хирургични престилки	Standart	2
5 Медицински кърпи	40x40 cm	2
6 Стерилизация пакет	100x100 cm	1

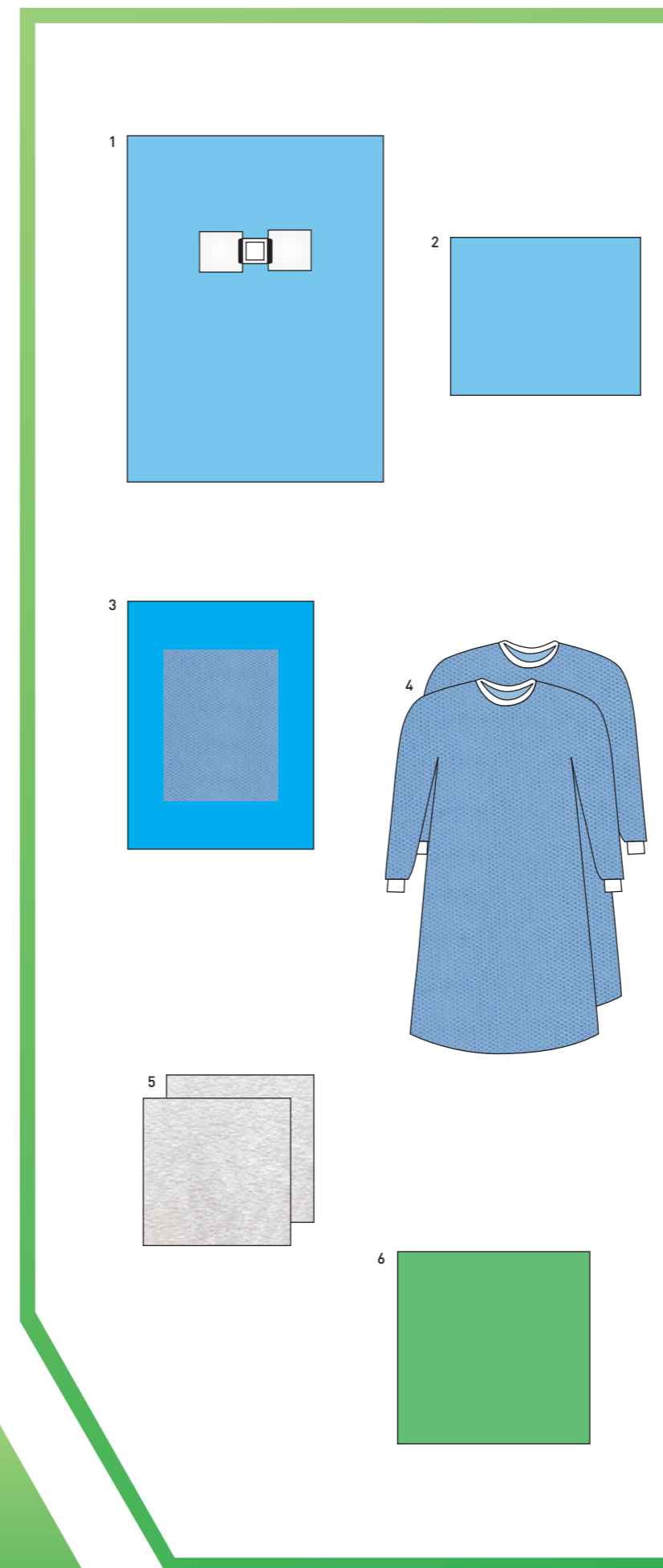
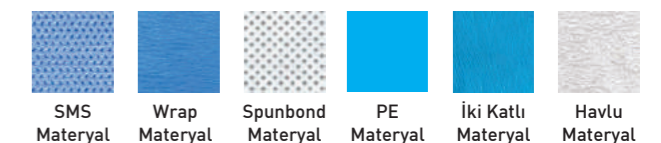

**T.U.R. ÖRTÜ SETİ**

T.U.R. Drape Set  
TROUSSE DE T.U.R.  
CET 3A T.Y.P.

3A070200

Ç	Açıklama	Ebat	Adet
1	T.U.R. Örtüsü	200x240 cm	1
2	Düz Örtü	100x120 cm	1
3	Alet Masa Örtüsü PE/NW	150x200 cm	1
4	Cerrahi Önlük	Korumalı	2
5	Medikal Havlu	40x40 cm	2
6	Sterilizasyon Bohçası	100x100 cm	1

UK	Description	Size	Pieces
1	T.U.R. Drape	200x240 cm	1
2	Drape	100x120 cm	1
3	Back Table Drape PE/NW	150x200 cm	1
4	Surgical Gown	Reinforced	2
5	Medical Towel	40x40 cm	2
6	Sterilization Wrap	100x100 cm	1

FR	Explication	Taille	Pcs
1	Champ de T.U.R.	200x240 cm	1
2	Champ	100x120 cm	1
3	Champ de table PE/NW	150x200 cm	1
4	Casaques chirurgicales	Renforcées	2
5	Essuie-mains	40x40 cm	2
6	Enveloppe de stérilisation	100x100 cm	1

BG	Описание	Размер	Зърно
1	Покривало за T.U.P.	200x240 cm	1
2	Покривало	100x120 cm	1
3	Покривало за масата PE/ NM	150x200 cm	1
4	Хирургична престилка	защитени	2
5	Медицински кърпи	40x40 cm	2
6	Стерилизация пакет	100x100 cm	1

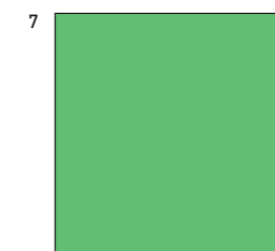
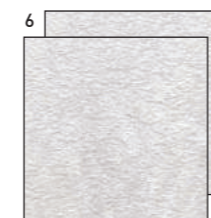
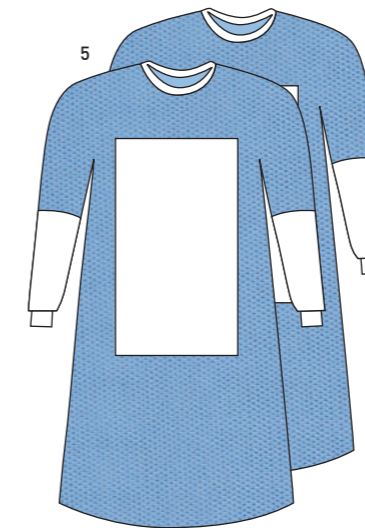
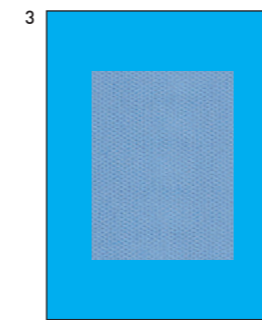
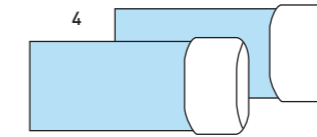
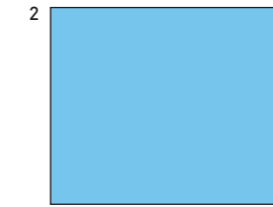
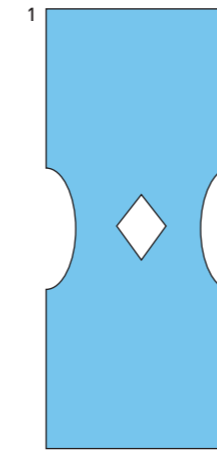
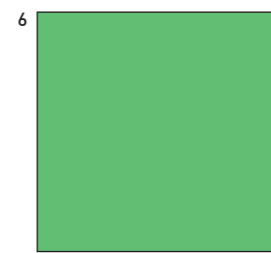
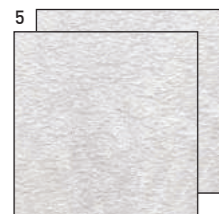
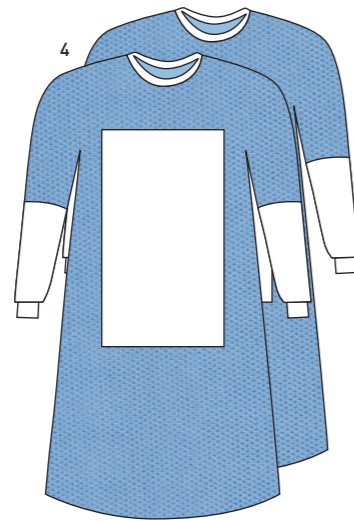
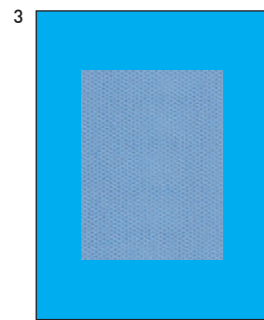
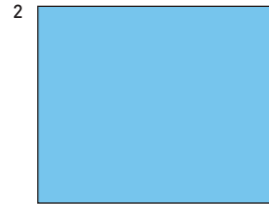
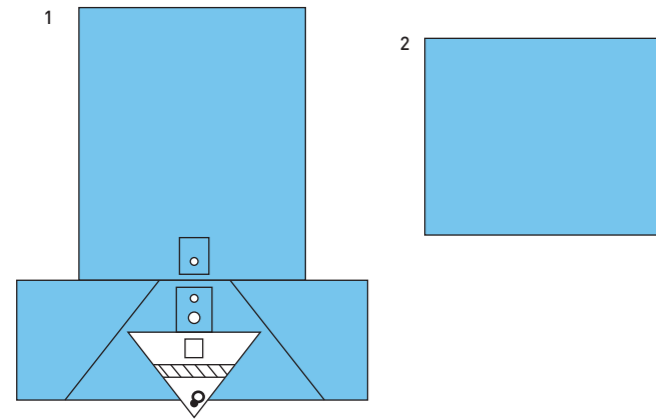
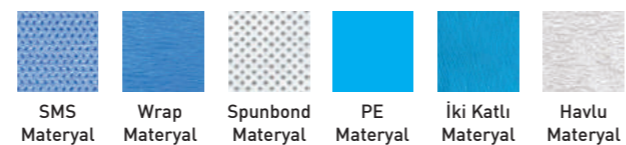
**SİSTOSKOPİ ÖRTÜ SETİ**

CYSTOSCOPY DRAPE SET  
TROUSSE DE CYSTOSCOPIE  
CET 3A ЦИСТОСКОПИЯ

3A070300

Ç	Açıklama	Ebat	Adet
1	Sistoskopy Örtüsü	75x150 cm	1
2	Düz Örtü	100x120 cm	1
3	Alet Masa Örtüsü PE/NW	150x200 cm	1
4	Bacak Kılıfı	60x115 cm	2
5	Cerrahi Önlük	Korumalı	2
6	Medikal Havlu	40x40 cm	2
7	Sterilizasyon Bohçası	100x100 cm	1

UK	Description	Size	Pieces
1	Cystoscopy Drape	75x150 cm	1
2	Drape	100x120 cm	1
3	Back Table Drape PE/NW	150x200 cm	1
4	Leg Drape	60x115 cm	2
5	Surgical Gown	Reinforced	2
6	Medical Towel	40x40 cm	2
7	Sterilization Wrap	100x100 cm	1

FR	Explication	Taille	Pcs
1	Champ de cystoscopie	75x150 cm	1
2	Champ	100x120 cm	1
3	Champ de table PE/NW	150x200 cm	1
4	Stockinette	60x115 cm	2
5	Casaques chirurgicales	Renforcées	2
6	Essuie-mains	40x40 cm	2
7	Enveloppe de stérilisation	100x100 cm	1

BG	Описание	Размер	Зърно
1	Покривало за цистоскопия	75x150 cm	1
2	Покривало	100x120 cm	1
3	Покривало за масата PE/ NM	150x200 cm	1
4	Покривало за крака	60x115 cm	2
5	Хирургическа престилка	защитени	2
6	Медицински кърпи	40x40 cm	2
7	Стерилизация пакет	100x100 cm	1

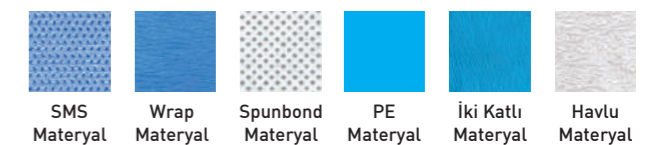



## KEMOTERAPİ ÖRTÜ SETİ

CHEMOTHERAPY DRAPE SET  
TROUSSE DE CHIMIOTHÉRAPIE  
СЕТ ЗА ХИМИОТЕРАПИЯ

3A080100

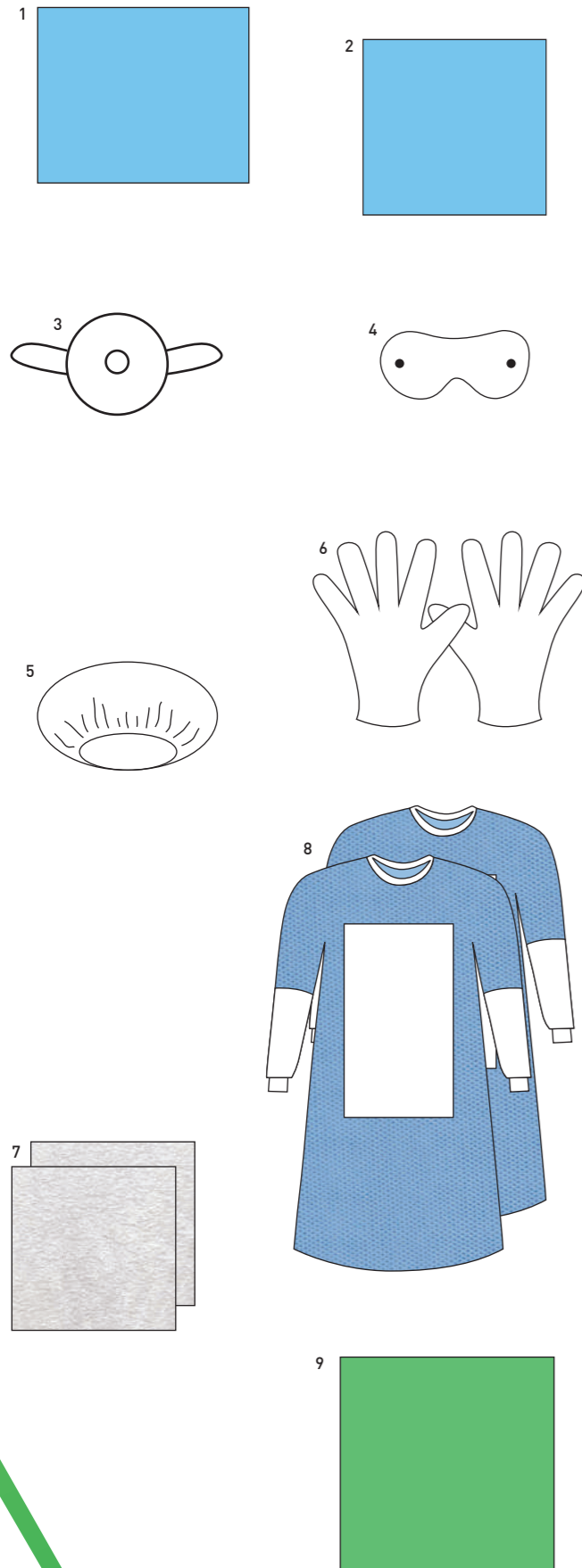

Açıklama	Ebat	Adet
1 Düz Örtü	40x120 cm	1
2 Düz Örtü	75x75 cm	1
3 Maske	-	1
4 Koruyucu Gözlük	-	1
5 Bone	-	1
6 Kemoterapi Eldiveni	-	1
7 Cerrahi Önlük	Korumalı	2
8 Medikal Havlu	40x40 cm	2
9 Sterilizasyon Bohçası	100x100 cm	1

Description	Size	Pieces
1 Drape	40x120 cm	1
2 Drape	75x75 cm	1
3 Mask	-	1
4 Protective Glasses	-	1
5 Bonnet	-	1
6 Chemotherapy Gloves	-	1
7 Surgical Gown	Reinforced	2
8 Medical Towel	40x40 cm	2
9 Sterilization Wrap	100x100 cm	1

Explication	Taille	Pcs
1 Champ	40x120 cm	1
2 Champ	75x75 cm	1
3 Maske chirurgicale	-	1
4 Des lunettes de protection	-	1
5 Bonnet	-	1
6 Chimiothérapie Gants	-	1
7 Casaques chirurgicales	Renforcées	2
8 Essuie-mains	40x40 cm	2
9 Enveloppe de stérilisation	100x100 cm	1

Описание	Размер	Зърно
1 Покривало	40x120 cm	1
2 Покривало	75x75 cm	1
3 Маска	-	1
4 Защита за очите	-	1
5 Шапка	-	1
6 Ръкавици за химиотерапевтия	-	1
7 Хирургична престилка	защитени	2
8 Медицински кърпи	40x40 cm	2
9 Стерилизация пакет	100x100 cm	1

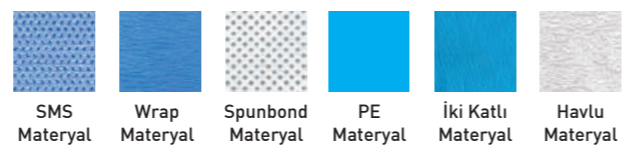

SMS Materyal Wrap Materyal Spunbond Materyal PE Materyal İki Katlı Materyal Havlu Materyal

## BİOPSİ ( TESE ) ÖRTÜ SETİ

BIOPSY ( TESE ) DRAPE SET  
TROUSSE DE BIOPSIE  
СЕТ ЗА БИОПСИЯ

3A090100

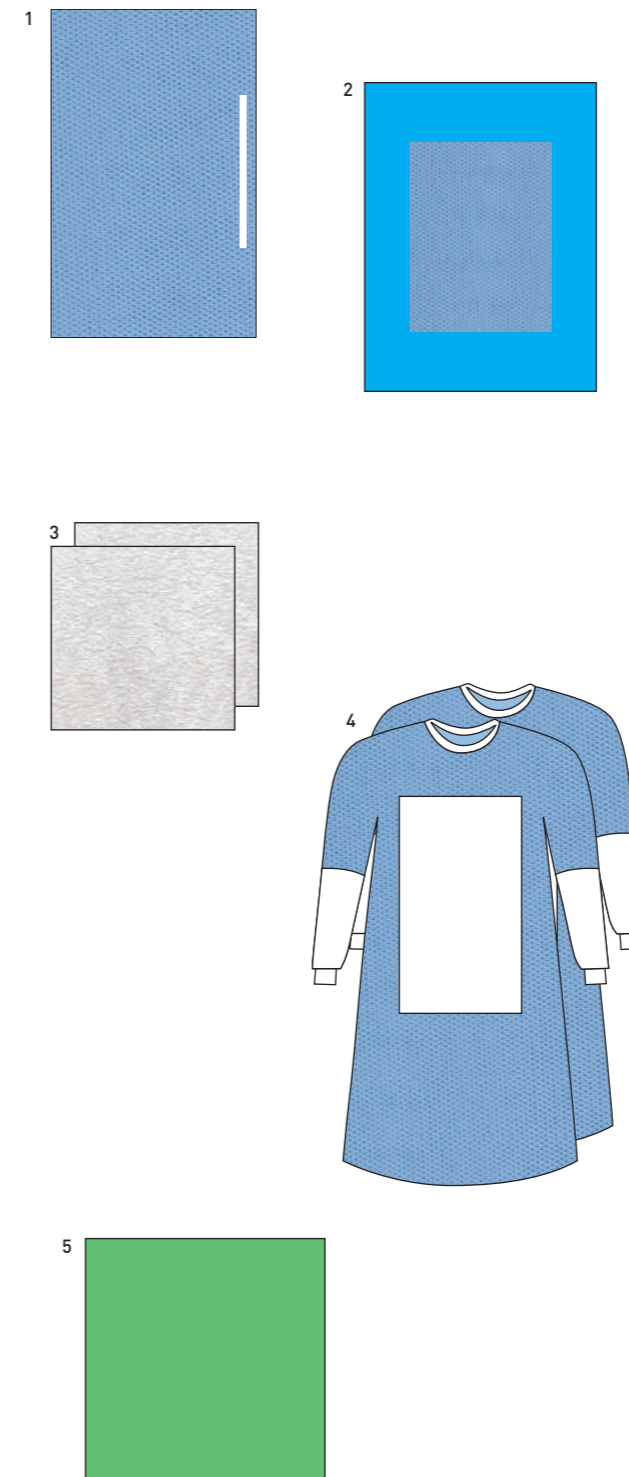

Açıklama	Ebat	Adet
1 Anestezi Örtüsü	150x300 cm	1
2 Alet Masa Örtüsü PE/NW	100x150 cm	1
3 Cerrahi Önlük	Korumalı	2
4 Medikal Havlu	40x40 cm	2
5 Sterilizasyon Bohçası	100x100 cm	1

Description	Size	Pieces
1 Anesthesia Drape	150x300 cm	1
2 Back Table Drape PE/NW	100x150 cm	1
3 Surgical Gown	Reinforced	2
4 Medical Towel	40x40 cm	2
5 Sterilization Wrap	100x100 cm	1

Explication	Taille	Pcs
1 Champ adhésif	150x300 cm	1
2 Champ de table PE/NW	100x150 cm	1
3 Casaques chirurgicales	Renforcées	2
4 Essuie-mains	40x40 cm	2
5 Enveloppe de stérilisation	100x100 cm	1

Описание	Размер	Зърно
1 Покривало за анестезиология	150x300 cm	1
2 Покривало за масата PE/ NM	100x150 cm	1
3 Хирургична престилка	защитени	2
4 Медицински кърпи	40x40 cm	2
5 Стерилизация пакет	100x100 cm	1

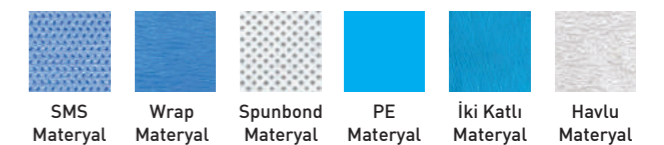

SMS Materyal Wrap Materyal Spunbond Materyal PE Materyal İki Katlı Materyal Havlu Materyal

**K.B.B. ÖRTÜ SETİ**E.N.T.DRAPE SET  
TROUSSE DE E.N.T.  
SET ZA УНГ

3A100100

Ç	Açıklama	Ebat	Adet
1	Yarıklı K.B.B. Örtüsü	150x250 cm	1
2	Yapışkan Bantlı Örtü	75x90 cm	1
3	Düz Örtü	75x80 cm	1
4	Alet Masa Örtüsü PE/NW	150x200 cm	1
5	Mayo Masa Örtüsü PE/NW	75x145 cm	1
6	Yapışkan Bant	10x30 cm	2
7	Cerrahi Önlük	Korumalı	2
8	Medikal Havlu	40x40 cm	2
9	Sterilizasyon Bohçası	100x100 cm	1

UK	Description	Size	Pieces
1	Split E.N.T. Drape	150x250 cm	1
2	Drape With Adhesive	75x90 cm	1
3	Drape	75x80 cm	1
4	Back Table Drape PE/NW	150x200 cm	1
5	Mayo Stand Cover PE/NW	75x145 cm	1
6	Op - Tape	10x30 cm	2
7	Surgical Gown	Reinforced	2
8	Medical Towel	40x40 cm	2
9	Sterilization Wrap	100x100 cm	1

FR	Explication	Taille	Pcs
1	Champ fenêtre de E.N.T.	150x250 cm	1
2	Bandelette adhésive	75x90 cm	1
3	Champ	75x80 cm	1
4	Champ de table PE/NW	150x200 cm	1
5	Housse de Mayo PE/NW	75x145 cm	1
6	Bandelette adhésive	10x30 cm	2
7	Casaques chirurgicales	Renforcées	2
8	Essuie-mains	40x40 cm	2
9	Enveloppe de stérilisation	100x100 cm	1

TR	Описание	Размер	Зърно
1	Разделено покривало за УНГ операции	150x250 cm	1
2	Покривало с адхезия	75x90 cm	1
3	Покривало	75x80 cm	1
4	Покривало за масата PE/ NM	150x200 cm	1
5	Покривало за над операционната масичка PE/ NM	75x145 cm	1
6	Лепяща лента	10x30 cm	2
7	Хирургична престилка	защитени	2
8	Медицински кърпи	40x40 cm	2
9	Стерилизация пакет	100x100 cm	1

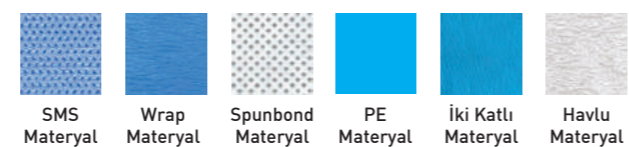

SMS Materyal Wrap Materyal Spunbond Materyal PE Materyal İki Katlı Materyal Havlu Materyal

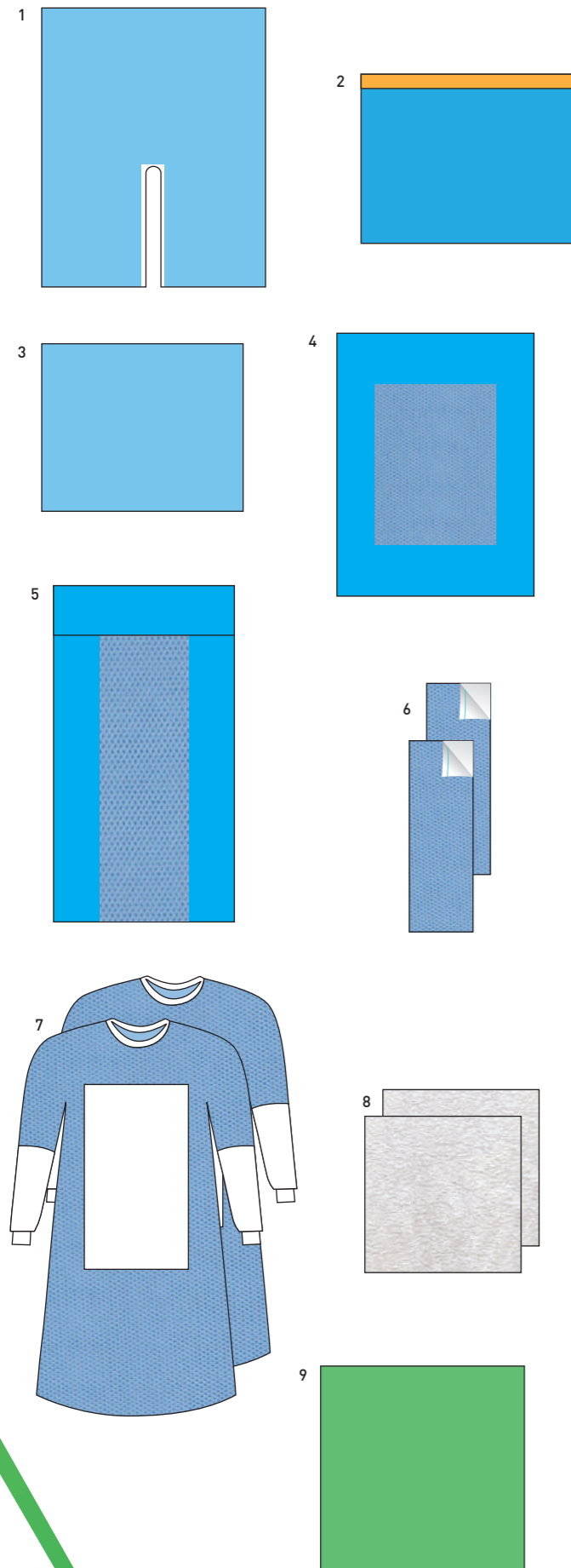

SMS Materyal Wrap Materyal Spunbond Materyal PE Materyal İki Katlı Materyal Havlu Materyal

**TROİD ÖRTÜ SETİ**THYROID DRAPE SET  
TROUSSE DE THYROIDÉ  
SET ZA ОПЕРАЦИЯ НА ЩИТОВИДНАТА ЖЛЕЗА

3A100400

Ç	Açıklama	Ebat	Adet
1	Troid Örtüsü	240x320 cm	1
2	Alet Masa Örtüsü PE/NW	100x150 cm	1
3	Yapışkan Bant	10x30 cm	2
4	Cerrahi Önlük	Korumalı	2
5	Medikal Havlu	40x40 cm	2
6	Sterilizasyon Bohçası	100x100 cm	1

UK	Description	Size	Pieces
1	Thyroid Drape	240x320 cm	1
2	Back Table Drape PE/NW	100x150 cm	1
3	Op - Tape	10x30 cm	2
4	Surgical Gown	Reinforced	2
5	Medical Towel	40x40 cm	2
6	Sterilization Wrap	100x100 cm	1

FR	Explication	Taille	Pcs
1	Champ de thyroïde	240x320 cm	1
2	Champ de table PE/NW	100x150 cm	1
3	Bandelette adhésive	10x30 cm	2
4	Casaques chirurgicales	Renforcées	2
5	Essuie-mains	40x40 cm	2
6	Enveloppe de stérilisation	100x100 cm	1

TR	Описание	Размер	Зърно
1	Покривало	240x320 cm	1
2	Покривало за масата PE/ NM	100x150 cm	1
3	Лепяща лента	10x30 cm	2
4	Хирургична престилка	защитени	2
5	Медицински кърпи	40x40 cm	2
6	Стерилизация пакет	100x100 cm	1

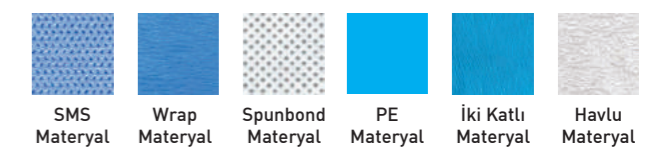

SMS Materyal Wrap Materyal Spunbond Materyal PE Materyal İki Katlı Materyal Havlu Materyal

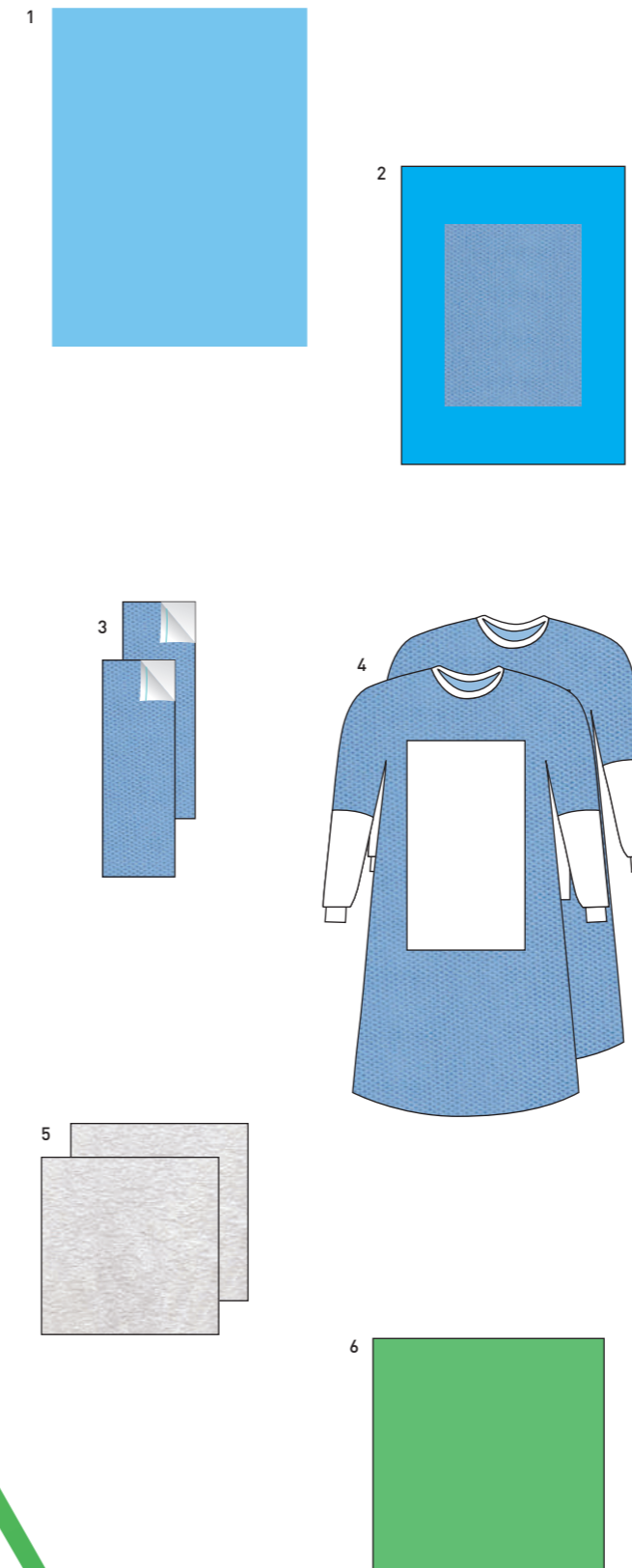

## DİŞ ÖRTÜ SETİ

DENTAL DRAPE SET  
TROUSSE DE DENTAIRE  
SET ЗА ДЕНТАЛНА ХИРУРГИЯ

3A110100

Açıklama	Ebat	Adet
1 Delikli Örtü	150x200 cm	1
2 Bantlı Örtü	150x150 cm	1
3 Alet Masa Örtüsü PE/NW	100x150 cm	1
4 Seffaf Hortum Kılıfı	8x200 cm	3
5 Cerrahi Önlük	Standart	1
6 Medikal Havlu	40x40 cm	1
7 Sterilizasyon Bohçası	100x100 cm	1

Description	Size	Pieces
1 Drape With Hole	150x200 cm	1
2 Drape With Adhesive	150x150 cm	1
3 Back Table Drape PE/NW	100x150 cm	1
4 Hose Cover	8x200 cm	3
5 Surgical Gown	Standart	1
6 Medical Towel	40x40 cm	1
7 Sterilization Wrap	100x100 cm	1

Explication	Taille	Pcs
1 Ivoire	150x200 cm	1
2 Champ adhésif	150x150 cm	1
3 Champ de table PE/NW	100x150 cm	1
4 Le revêtement du tuyau	8x200 cm	3
5 Casaques chirurgicales	Standart	1
6 Essuie-mains	40x40 cm	1
7 Enveloppe de stérilisation	100x100 cm	1

Описание	Размер	Зърно
1 Покривало с дупка	150x200 cm	1
2 Покривало с адхезия	150x150 cm	1
3 Покривало за масата PE/ NW	100x150 cm	1
4 Прозрачен калъф за тръба	8x200 cm	3
5 Хирургична престилка	Standart	1
6 Медицински кърпи	40x40 cm	1
7 Стерилизация пакет	100x100 cm	1

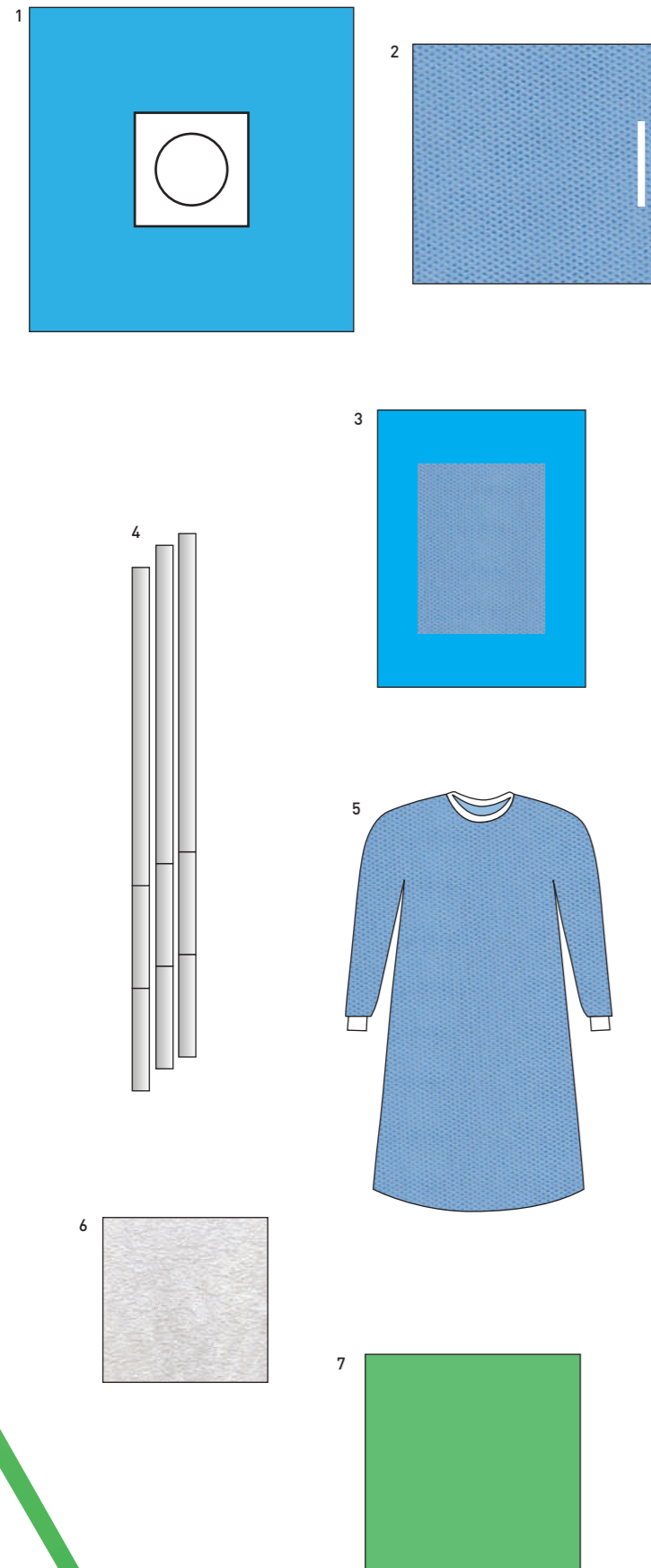
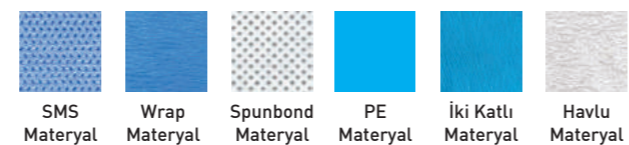

## İMLANT ÖRTÜ SETİ

IMPLANT DRAPE SET  
TROUSSE DE IMPLANT  
SET ЗА ПОСТАВЯНЕ НА ИМПЛАНТ

3A110200

Açıklama	Ebat	Adet
1 Düz Örtü	75x80 cm	1
2 Yapışkan Bant	15x15 cm	2
3 Gazlı Bez	5x5 cm	10
4 PE Naylon	10x120 cm	2
5 Üiversal Torba	30x35 cm	1
6 Cerrahi Önlük	Standart	1
7 Medikal Havlu	40x40 cm	1
8 Sterilizasyon Bohçası	100x100 cm	1

Description	Size	Pieces
1 Drape	75x80 cm	1
2 Op Tape	15x15 cm	2
3 Spanc	5x5 cm	10
4 PE Bag	10x120 cm	2
5 Universal Bag	30x35 cm	1
6 Op - Tape	Standart	1
7 Medical Towel	40x40 cm	1
8 Sterilization Wrap	100x100 cm	1

Explication	Taille	Pcs
1 Champ	75x80 cm	1
2 Bandelette adhésive	15x15 cm	2
3 Tampon de gaze	5x5 cm	10
4 PE Nylon	10x120 cm	2
5 Poche à intruments	30x35 cm	1
6 Casaques chirurgicales	Standart	1
7 Essuie-mains	40x40 cm	1
8 Enveloppe de stérilisation	100x100 cm	1

Описание	Размер	Зърно
1 Покривало	75x80 cm	1
2 Лепяща лента	15x15 cm	2
3 Марли	5x5 cm	10
4 PE торбичка	10x120 cm	2
5 Универсална торба	30x35 cm	1
6 Хирургична престилка	Standart	1
7 Медицински кърпи	40x40 cm	1
8 Стерилизация пакет	100x100 cm	1

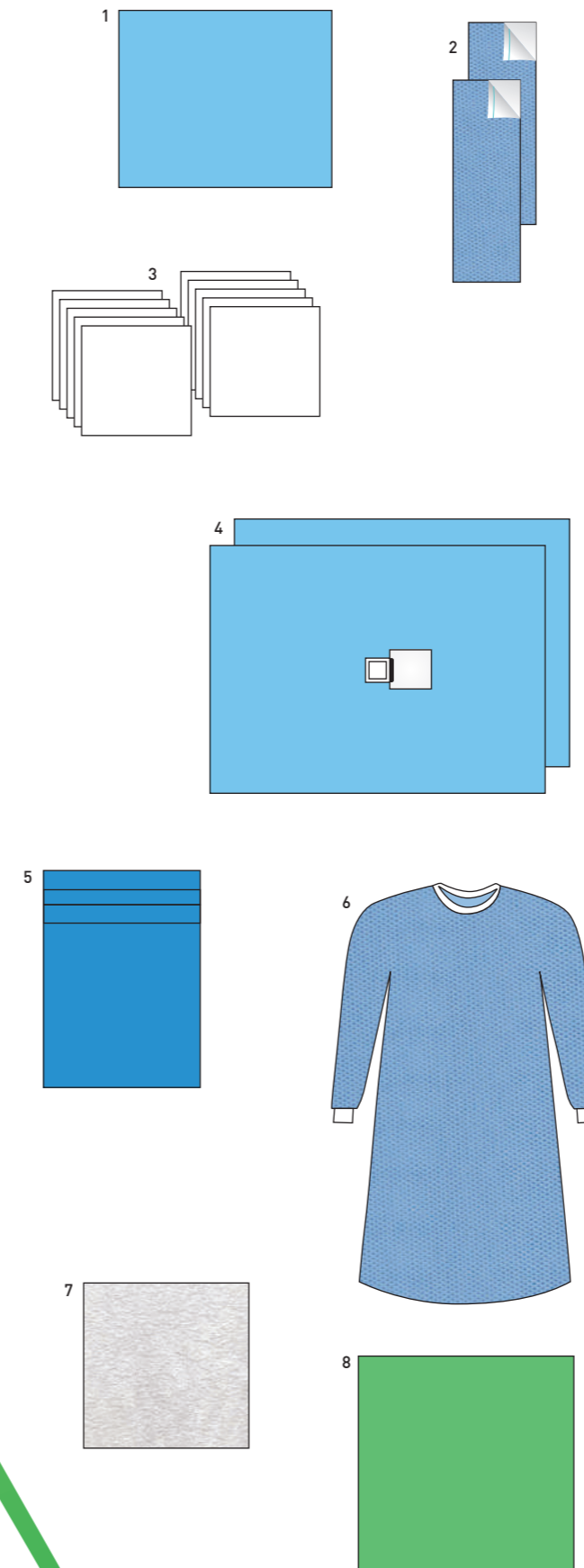
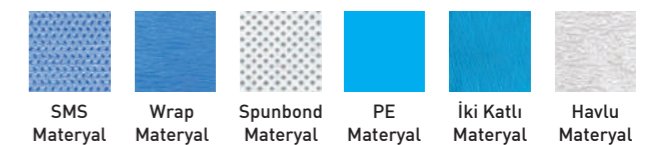

## PERKÜTAN SETİ

PERCUTANEOUS PACK  
TROUSSE DE PERCUTANÉE  
SET ZA PERKUTANNA PUNKCIJA

3A120100

Açıklama	Ebat	Adet
1 Alet Masa Örtüsü PE/NW	150x200 cm	1
2 Perkütan Örtü Seti	150x300 cm	1
3 Flüroskopi Kılıfı	90 cm	1
4 Kamera Kılıfı	13x250 cm	1
5 Medikal Bant	10x50 cm	1
6 Cerrahi Önlük	Korumalı	2
7 Medikal Havlu	40x40 cm	2
8 Sterilizasyon Bohçası	100x100 cm	1

Description	Size	Pieces
1 Back Table Drape PE/NW	150x200 cm	1
2 Percutaneous Cover Set	150x300 cm	1
3 Fluoroscopy Cover	90 cm	1
4 Camera Cover	13x250 cm	1
5 Adhesive Tape	10x50 cm	1
6 Surgical Gown	Reinforced	2
7 Medical Towel	40x40 cm	2
8 Sterilization Wrap	100x100 cm	1

Explication	Taille	Pcs
1 Champ de table PE/NW	150x200 cm	1
2 Champ de percutanée	150x300 cm	1
3 Couverture de radioscopie	90 cm	1
4 Solüsyon Kabi	13x250 cm	1
5 Housse de caméra	10x50 cm	1
6 Casaques chirurgicales	Renforcées	2
7 Essuie-mains	40x40 cm	2
8 Enveloppe de stérilisation	100x100 cm	1

Описание	Размер	Зърно
1 Покривало за масата PE/ NM	150x200 cm	1
2 Покривало за перкутанна пункция	150x300 cm	1
3 Покривало за ел. микроскопа	90 cm	1
4 Капъф за камерата	13x250 cm	1
5 Лента с адхезия	10x50 cm	1
6 Хирургична престилка	Защитена	2
7 Медицински кърпи	40x40 cm	2
8 Стерилизация пакет	100x100 cm	1

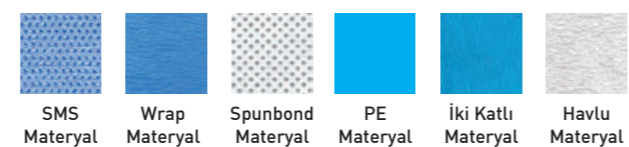

## JİNEKOLOJİ ÖRTÜ SETİ

GYNAECOLOGY PACK  
TROUSSE DE GYNÉCOLOGIE  
SET ZA GİNEKOLOGİJA

3A120200

Açıklama	Ebat	Adet
1 Jinekoloji Örtüsü	75x120 cm	1
2 Bantlı Örtü	80x100 cm	1
3 Bacak Kılıfı	80x120 cm	1
4 Alet Masa Örtüsü PE/NW	150x200 cm	1
5 Cerrahi Önlük	Korumalı	2
6 Medikal Havlu	40x40 cm	2
7 Sterilizasyon Bohçası	100x100 cm	1

Description	Size	Pieces
1 Gynaecology Drape	75x120 cm	1
2 Drape With Adhesive	80x100 cm	1
3 Leg Drape	80x120 cm	1
4 Back Table Drape PE/NW	150x200 cm	1
5 Surgical Gown	Reinforced	2
6 Medical Towel	40x40 cm	2
7 Sterilization Wrap	100x100 cm	1

Explication	Taille	Pcs
1 Champs de gynécologie	75x120 cm	1
2 Champ adhésif	80x100 cm	1
3 Stockinette	80x120 cm	1
4 Champ de table PE/NW	150x200 cm	1
5 Casaques chirurgicales	Renforcées	2
6 Essuie-mains	40x40 cm	2
7 Enveloppe de stérilisation	100x100 cm	1

Описание	Размер	Зърно
1 Покривало за гинекология	75x120 cm	1
2 Покривало с адхезия	80x100 cm	1
3 Покривало за крака	80x120 cm	1
4 Покривало за масата PE/ NM	150x200 cm	1
5 Хирургична престилка	Защитена	2
6 Медицински кърпи	40x40 cm	2
7 Стерилизация пакет	100x100 cm	1

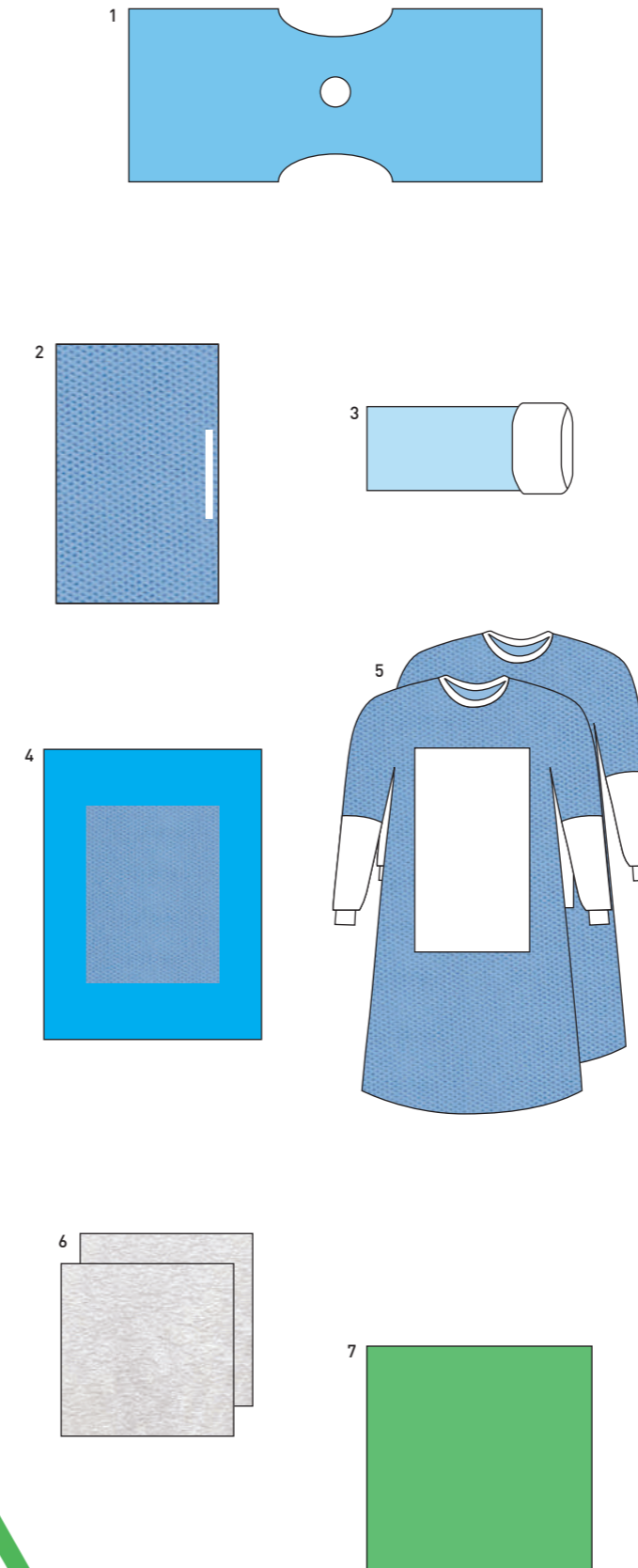
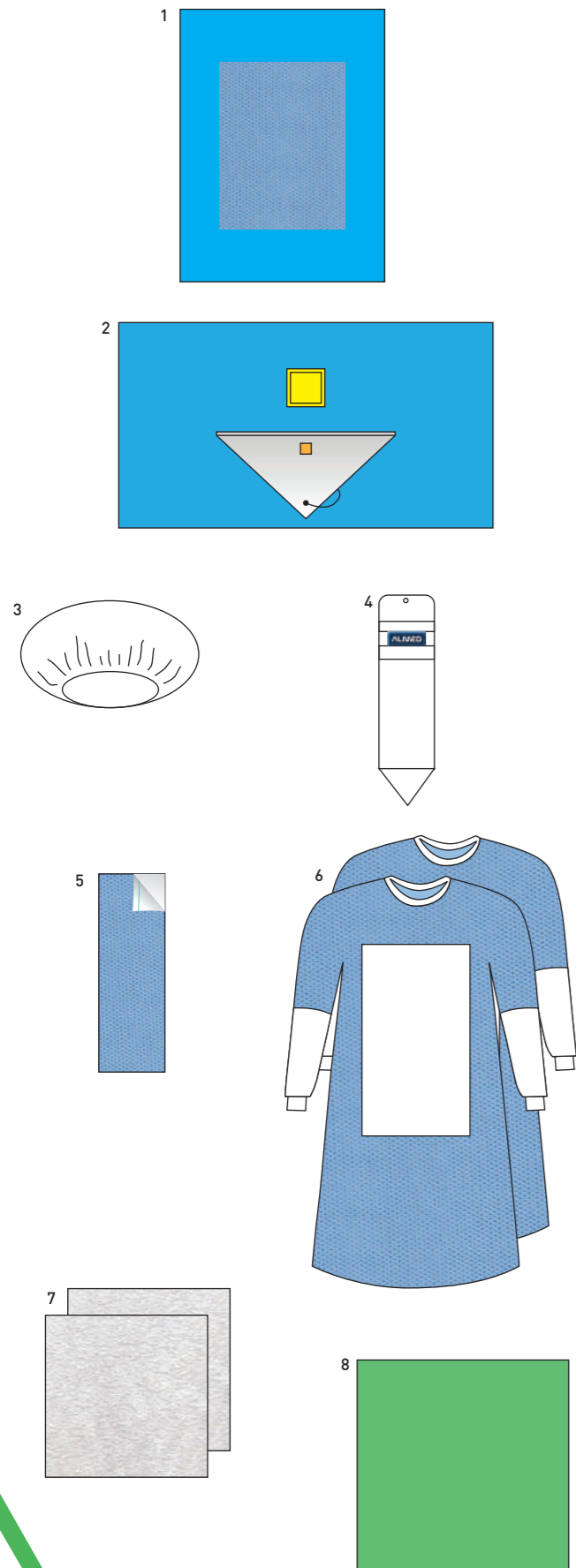
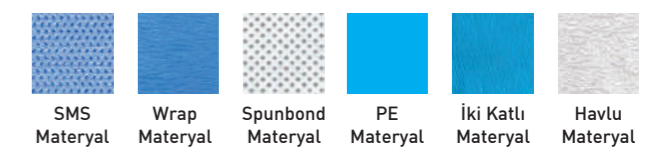

## JİNEKOLOJİ ÖRTÜ SETİ ( POŞLU)

GYNÆCOLOGY PACK 2 3A040550  
TROUSSE DE GYNÆCOLOGIE SANS POCHE DE RECUEIL  
SET ЗА ГИНЕКОЛОГИЯ

Ç	Açıklama	Ebat	Adet
1	Jinekoloji Örtüsü Poşlu	100x150 cm	1
2	Bacak Kılıfı	55x120 cm	2
3	Düz Örtü	100x150 cm	1
4	Alet Masa Örtüsü PE/NW	150x200 cm	1
5	Sterilizasyon Bohçası	75x75 cm	1

UK	Description	Size	Pieces
1	Gynaecology Drape	100x150 cm	1
2	Leg Drape	55x120 cm	2
3	Drape	100x150 cm	1
4	Back Table Drape PE/NW	150x200 cm	1
5	Sterilization Wrap	75x75 cm	1

FR	Explication	Taille	Pcs
1	Gynécologie poche de couverture	100x150 cm	1
2	Stockinette	55x120 cm	2
3	Champ	100x150 cm	1
4	Champ de table PE/NW	150x200 cm	1
5	Enveloppe de stérilisation	75x75 cm	1

RU	Описание	Размер	Зърно
1	Покривало за гинекология	100x150 cm	1
2	Покривало за крака	55x120 cm	2
3	Покривало	100x150 cm	1
4	Покривало за масата PE/ NM	150x200 cm	1
5	Стерилизация пакет	75x75 cm	1

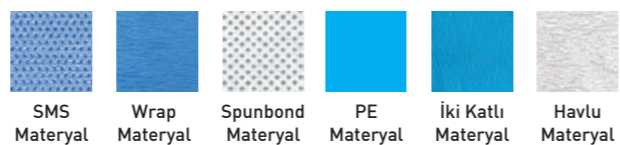

## SHUNT SETİ

SHUNT PACK  
TORUSSE DE SHUNT  
SET ЗА МОЗЪЧНА ОПЕРАЦИЯ

Ç	Açıklama	Ebat	Adet
1	Shunt Örtüsü	150x300 cm	1
2	Anestezi Örtüsü	150x240 cm	1
3	Düz Örtü	150x180 cm	2
4	Yapışkan Bantlı Örtü	100x220 cm	2
5	Alet Masa Örtüsü PE/NW	150x200 cm	1
6	Mayo Masa Örtüsü	78x145 cm	1
7	Sterilizasyon Bohçası	100x100 cm	1

UK	Description	Size	Pieces
1	Shunt Cover Set	150x300 cm	1
2	Anesthesia Drape	150x240 cm	1
3	Drape	150x180 cm	2
4	Drape With Adhesive	100x220 cm	2
5	Back Table Drape PE/NW	150x200 cm	1
6	Mayo Stand Cover PE/NWN	78x145 cm	1
7	Sterilization Wrap	100x100 cm	1

FR	Explication	Taille	Pcs
1	Champ de shunt	150x300 cm	1
2	Champ adhésif	150x240 cm	1
3	Champ	150x180 cm	2
4	Champ adhésif	100x220 cm	2
5	Champ de table PE/NW	150x200 cm	1
6	Housse de Mayo PE/NW	78x145 cm	1
7	Enveloppe de stérilisation	100x100 cm	1

RU	Описание	Размер	Зърно
1	Специално покривало	150x300 cm	1
2	Покривало за анестезия	150x240 cm	1
3	Покривало	150x180 cm	2
4	Покривало с лепяща лента	100x220 cm	2
5	Покривало за масата PE/ NM	150x200 cm	1
6	Покривало за над операционната масичка	78x145 cm	1
7	Стерилизация пакет	100x100 cm	1

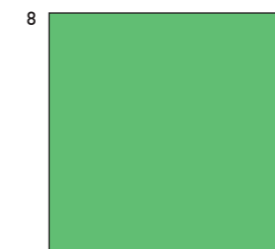
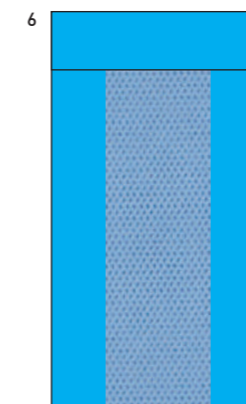
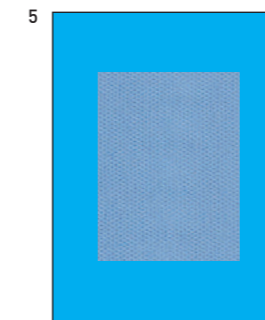
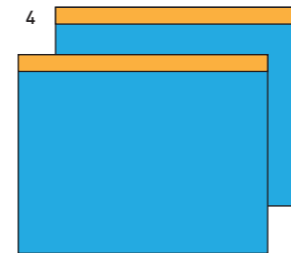
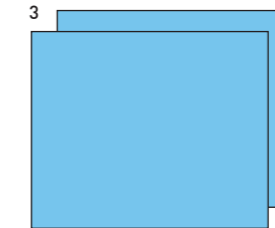
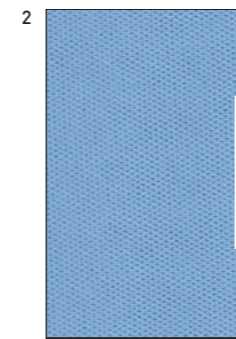
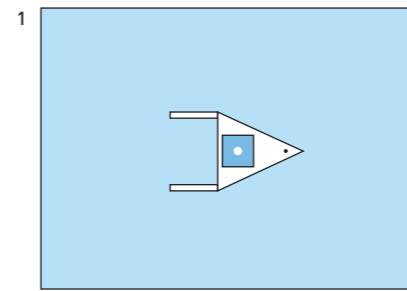
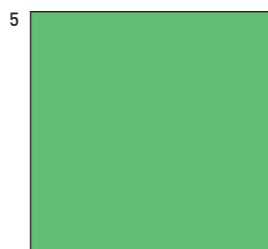
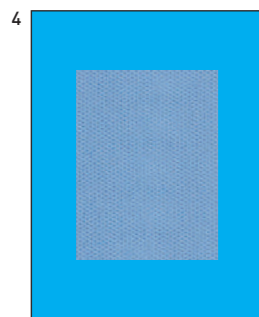
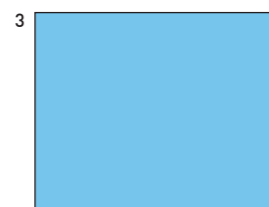
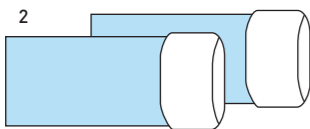
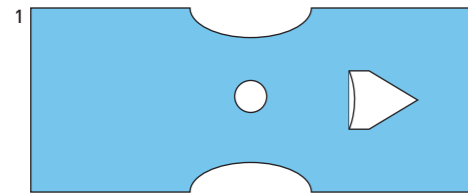
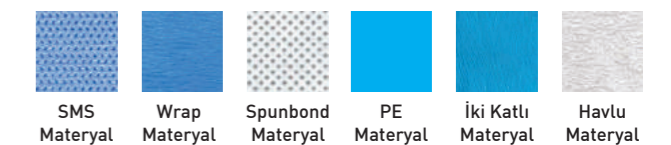

## OMUZ ÖRTÜ SETİ

SHOULDER PACK SET  
TROUSSE DE ÉPAULE  
SET ЗА ОПЕРАЦИЯ НА РАМЕННА СТАВА

3A020254

🇹🇷 Açıklama	Ebat	Adet
1 Ekstremitte Örtüsü	200x320 cm	1
2 Yapışkan Bantlı Örtü	75x100 cm	4
3 Alet Masa Örtüsü PE/NW	150x200 cm	1
4 Mayo Masa Örtüsü PE/NW	78x145 cm	1
5 Stokinet	40x75 cm	1
6 Kamera Kılıfı	13x250 cm	1
7 Cilt Kalem - Cetvel	?	1
8 İdeal Bandaj	15x200 cm	1
9 Yapışkan Bant	10x50 cm	4
10 Gazlı Bez	10x10 cm	40
11 Cerrahi Önlük	Korumalı	4
12 Medikal Havlu	40x40 cm	4
13 Sterilizasyon Bohçası	100x100 cm	1

🇬🇧 Description	Size	Pieces
1 Extremity Drape	200x320 cm	1
2 Op Tape	75x100 cm	4
3 Back Table Drape PE/NW	150x200 cm	1
4 Mayo Stand Cover PE/NW	78x145 cm	1
5 Stockinette	40x75 cm	1
6 Camera Cover	13x250 cm	1
7 Marker - Ruler	?	1
8 Flexible Bandage	15x200 cm	1
9 Op Tape	10x50 cm	4
10 Gauzes	10x10 cm	40
11 Surgical Gown	Reinforced	4
12 Medical Towel	40x40 cm	4
13 Sterilization Wrap	100x100 cm	1

🇫🇷 Explication	Taille	Pcs
1 Trousse d'extrémité	200x320 cm	1
2 Champ adhésif	75x100 cm	4
3 Champ de table PE/NW	150x200 cm	1
4 Housse de Mayo PE/NW	78x145 cm	1
5 Stockinette	40x75 cm	1
6 Housse de caméra	13x250 cm	1
7 Marqueur - Dirigaeant	?	1
8 Bandage Idéal	15x200 cm	1
9 Bandelette adhésive	10x50 cm	4
10 Tampon de gaze	10x10 cm	40
11 Casaques chirurgicales	Renforcées	4
12 Essuie-mains	40x40 cm	4
13 Enveloppe de stérilisation	100x100 cm	1

🇲🇩 Описание	Размер	Зърно
1 Покривало за раменната става	200x320 cm	1
2 Лепяща лента	75x100 cm	4
3 Покривало за масата PE/ NW	150x200 cm	1
4 Покривало за надоперационната масичка PE/ NW	78x145 cm	1
5 Чорап	40x75 cm	1
6 Капъф за камера	13x250 cm	1
7 Маркер за кожа	?	1
8 Еластичен бинт	15x200 cm	1
9 Лепяща лента	10x50 cm	4
10 Марли	10x10 cm	40
11 Хирургични престилки подсилени	Защитена	4
12 Медицински кърпи	40x40 cm	4
13 Стерилизация пакет	100x100 cm	1

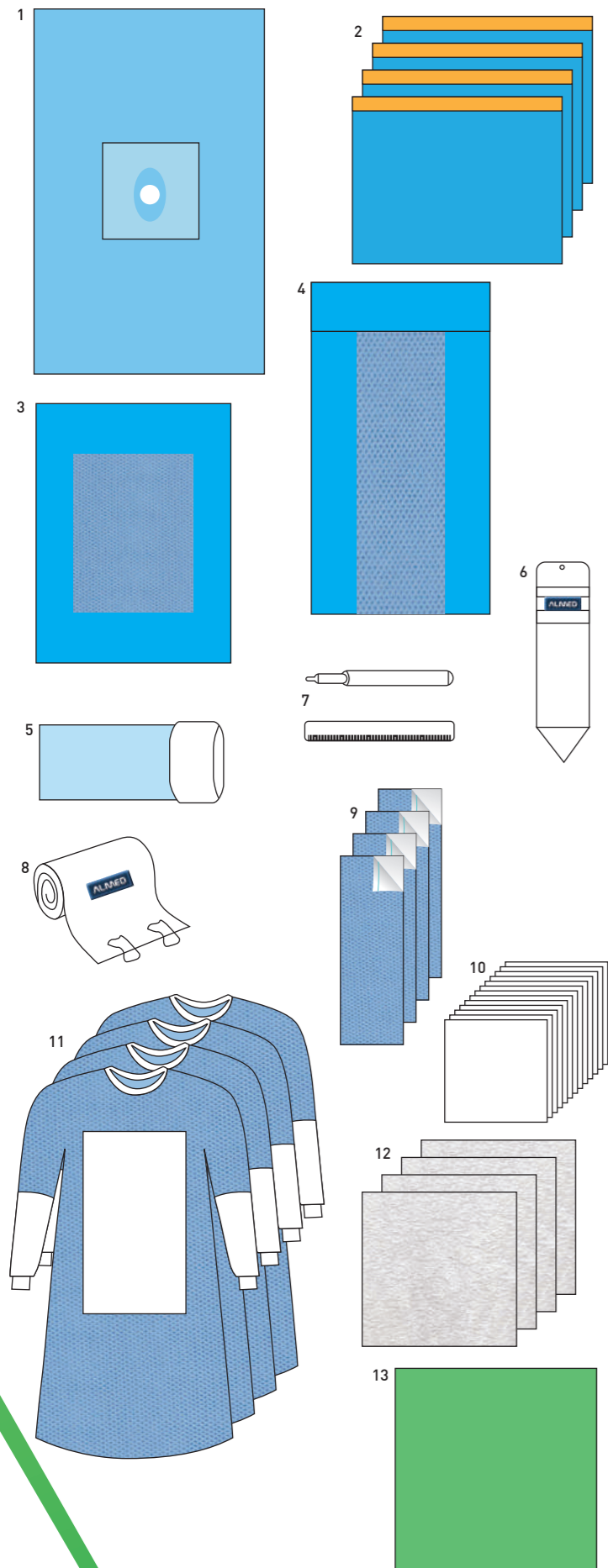

## VERTEBRA SETİ

SHUNT PACK  
TROUSSE DE VERTÈBRE  
SET ЗА ВЕРТЕБРАЛНА ХИРУРГИЯ

3A02032

🇹🇷 Açıklama	Ebat	Adet
1 Yapışkan Bantlı Örtü	75x100 cm	2
2 Yapışkan Bantlı Örtü	100x120 cm	2
3 Anestezi Örtüsü	150x240 cm	1
4 Ayak Örtüsü	150x160 cm	1
5 Alet Masa Örtüsü PE/NW	150x200 cm	1
6 Mayo Masa Örtüsü PE/NW	78x145 cm	1
7 Cilt Kalem - Cetvel	?	1
8 Medikal Bant	10x50 cm	2
9 Atık Torbası	35x40 cm	2
10 Cerrahi Önlük	Korumalı	2
11 Medikal Havlu	40x40 cm	2
12 Sterilizasyon Bohçası	100x100 cm	1

🇬🇧 Description	Size	Pieces
1 Drape With Adhesive	75x100 cm	2
2 Drape With Adhesive	100x120 cm	2
3 Anesthesia Drape	150x240 cm	1
4 Foot Drape	150x160 cm	1
5 Back Table Drape PE/NW	150x200 cm	1
6 Mayo Stand Cover PE/NW	78x145 cm	1
7 Marker - Ruler	?	1
8 Op Tape	10x50 cm	2
9 Universal Bag	35x40 cm	2
10 Surgical Gown	Reinforced	2
11 Medical Towel	40x40 cm	2
12 Sterilization Wrap	100x100 cm	1

🇫🇷 Explication	Taille	Pcs
1 Champ adhésif	75x100 cm	2
2 Champ adhésif	100x120 cm	2
3 Champ adhésif	150x240 cm	1
4 Champ adhésif	150x160 cm	1
5 Champ de table PE/NW	150x200 cm	1
6 Housse de Mayo PE/NW	78x145 cm	1
7 Marqueur - Dirigaeant	?	1
8 Sparadrap	10x50 cm	2
9 Sac à déchets	35x40 cm	2
10 Casaques chirurgicales	Renforcées	2
11 Essuie-mains	40x40 cm	2
12 Enveloppe de stérilisation	100x100 cm	1

🇲🇩 Описание	Размер	Зърно
1 Покривало с адхезия	75x100 cm	2
2 Покривало с адхезия	100x120 cm	2
3 Покривало с адхезия	150x240 cm	1
4 Покривало за крак	150x160 cm	1
5 Покривало за масата PE/ NW	150x200 cm	1
6 Покривало за надоперационната масичка PE/ NW	78x145 cm	1
7 Маркер за кожа	?	1
8 Лепяща лента	10x50 cm	2
9 Универсална торбичка	35x40 cm	2
10 Хирургична престилка	Защитена	2
11 Медицински кърпи	40x40 cm	2
12 Стерилизация пакет	100x100 cm	1

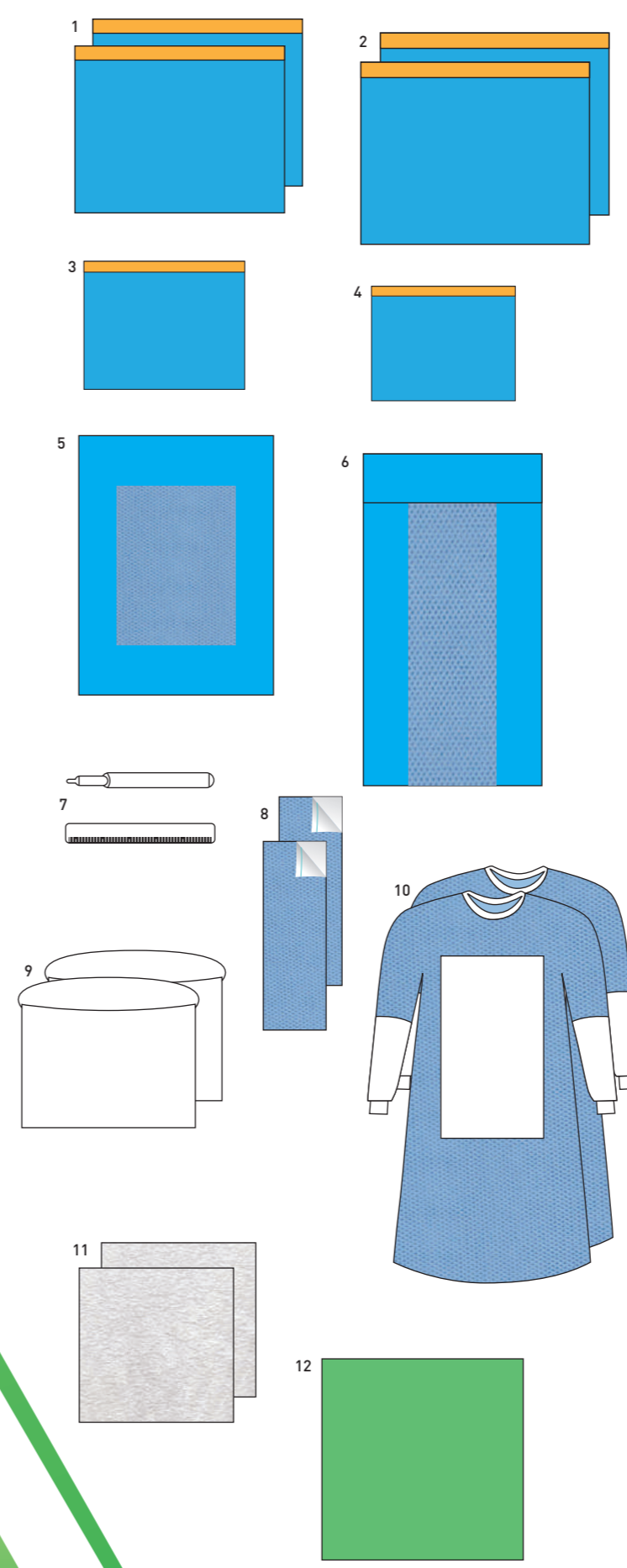

**ABDOMİNAL ÖRTÜ SETİ**

ABDOMINAL PACK  
TROUSSE DE ABDOMINAL  
SET ZA AБОМИНАЛНА ХИРУРГИЯ

3A010120

№	Açıklama	Ebat	Adet
1	Abdominal Örtü	240x320 cm	1
2	Alet Masa Örtüsü PE/NW	100x150 cm	1
3	Mayo Masa Örtüsü PE/NW	78x145 cm	1
4	Sterilizasyon Bohçası	100x100 cm	1

№	Description	Size	Pieces
1	Abdominal Drape	240x320 cm	1
2	Back Table Drape PE/NW	100x150 cm	1
3	Mayo Stand Cover PE/NW	78x145 cm	1
4	Sterilization Wrap	100x100 cm	1

№	Explication	Taille	Pcs
1	Champ de Abdominal	240x320 cm	1
2	Champ de table PE/NW	100x150 cm	1
3	Housse de Mayo PE/NW	78x145 cm	1
4	Enveloppe de stérilisation	100x100 cm	1

№	Описание	Размер	Размер
1	Покривало за абдомен	240x320 cm	1
2	Покривало за масата PE/ NM	100x150 cm	1
3	Покривало за надоперационната масичка PE/ NM	78x145 cm	1
4	Стерилизация пакет	100x100 cm	1

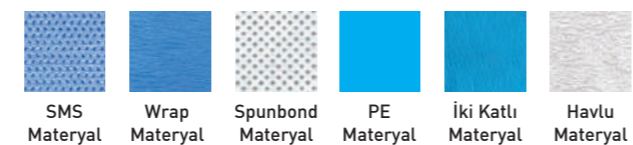
**ANJİOGRAFİ ÖRTÜ SETİ -B-**

ANGIOGRAPHY DRAPE SET -B-  
TOUSSE D'ANGIOGRAPHIEA -B-  
SET ZA ANJİOGRAFCKI

3A030100-B

№	Açıklama	Ebat	Adet
1	Anjiografi Örtüsü	200x300 cm	1
2	Fluoroskopi Kılıfı	85 cm	1
3	Cerrahi Önlük	Standart	1
4	Medikal Havlu	40x40 cm	1
5	Alet Masa Örtüsü PE/NW	100x150 cm	1
6	Sterilizasyon Bohçası	75x75 cm	1

№	Description	Size	Pieces
1	Angiography Drape	200x300 cm	1
2	Fluoroscopy Cover	85 cm	1
3	Surgical Gown	Standard	1
4	Medical Towel	40x40 cm	1
5	Back Table Drape PE/NW	100x150 cm	1
6	Sterilization Wrap	75x75 cm	1

№	Explication	Taille	Pcs
1	Champ d'angiographie	200x300 cm	1
2	Couverture de radioscopie	85 cm	1
3	Casaques chirurgicales	Standard	1
4	Essuie-mains	40x40 cm	1
5	Champ de table PE/NW	100x150 cm	1
6	Enveloppe de stérilisation	75x75 cm	1

№	Описание	Размер	Зърно
1	Покривало за ангиография	200x300 cm	1
2	Покривало за ел. микроскопа	85 cm	1
3	Хирургична престилка	стандарт	1
4	Медицински кърпи	40x40 cm	1
5	Покривало за масата PE/ NM	100x150 cm	1
6	Стерилизация пакет	75x75 cm	1

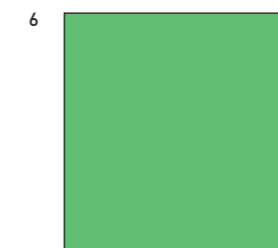
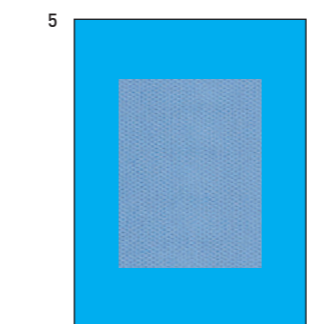
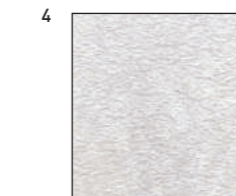
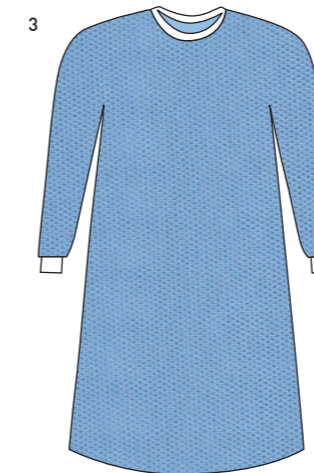
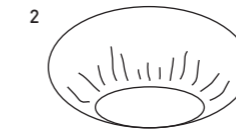
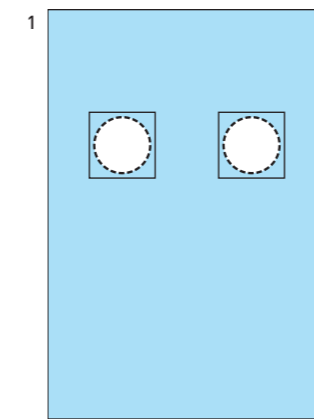
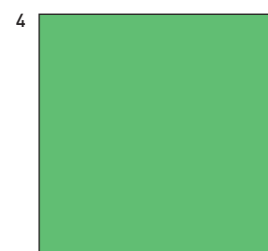
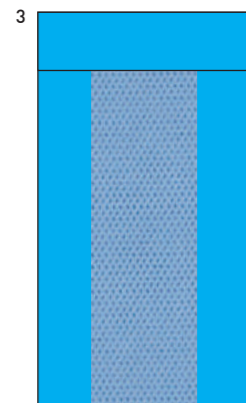
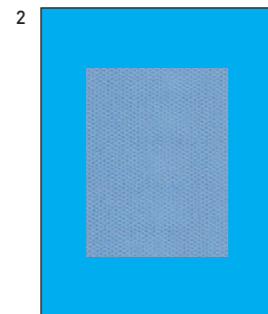
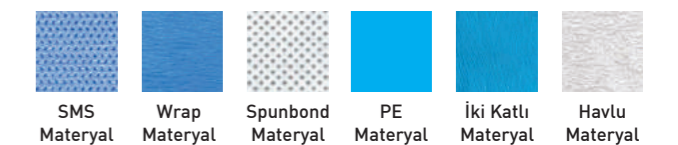



**Led Ekran Kılıfı**  
Led Screen Cover



**Mikroskop Kılıfı**  
Microscope Cover

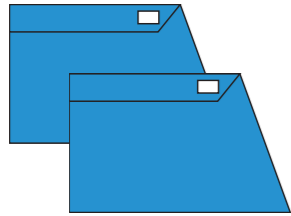

**Ayak Kılıfı**  
Foot Cover

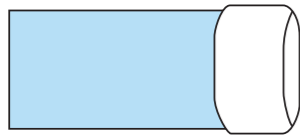

**Stokinet**  
Stockinette



**Medikal Bant**  
Adhesive

Ürünlerimiz İstenilen renk ve ebatta yapılabilmektedir.



**Akardiyon Bone**  
Surgical Cap



**Maske**  
Surgical Mask



**Sedye Örtüsü**  
Stretcher Cover



**Çarşaf ve Yastık Kılıfı**  
Bed Sheets and Pillow Cases



**Galoş PE**  
Shoe Cover PE



**Tek Kullanımlık Terlik**  
Disposable Slippers

Ürünlerimiz İstenilen renk ve ebatta yapılabilmektedir.

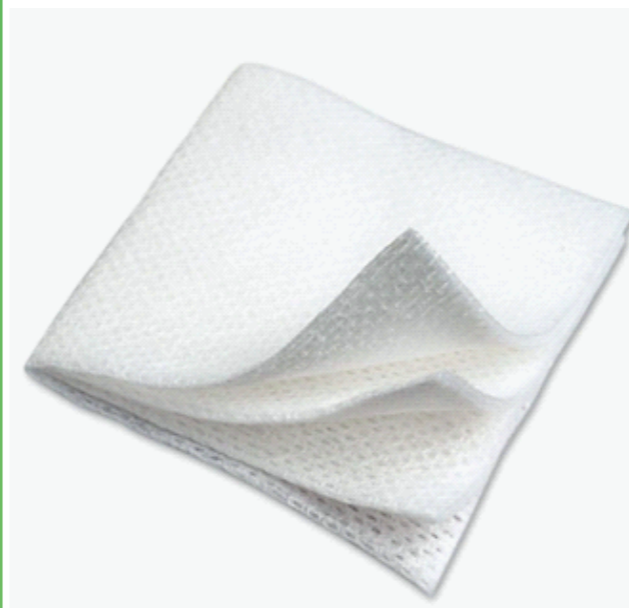

Nonwoven Dressing Pads: 4x4cm,5x5cm,  
7,5x7,5cm, 10x10cm, 15x15cm, 20x20cm



Non woven Dressing  
Pads for Surgical  
Operation. All pads  
Sterilized by EO.

CATALOGUE REF.	SİZES
1A402101	4X4cm
1A402102	5x5cm
1A402103	7,5x7,5cm
1A402103	10x10cm

Ürünlerimiz İstenilen renk ve ebatta yapılabilmektedir.

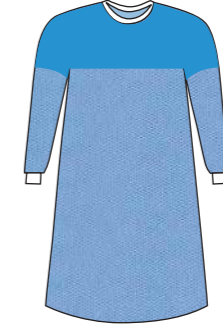

**Üroloji Önlüğü**  
Urology Gown  
2A200400

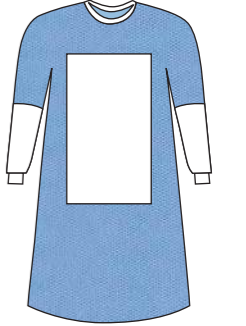

**Korumalı Cerrahi Önlük**  
Surgical Gown With Protection  
2A200200

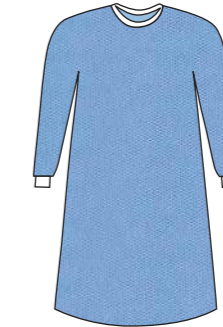

**Standart Cerrahi Önlük**  
Surgical Gown Without Protection  
2A200100

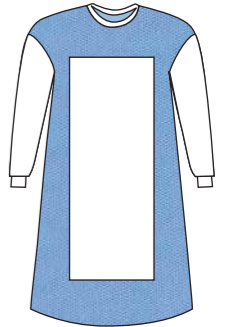

**Tam Korumalı Cerrahi Önlük**  
Surgical Gown With Full Protection  
2A200300

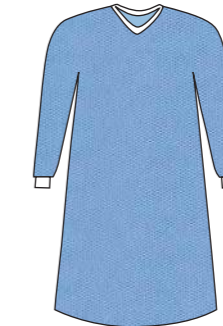

**Non Steril Hasta Önlüğü**  
Non Sterile Patient Gown  
1A400200

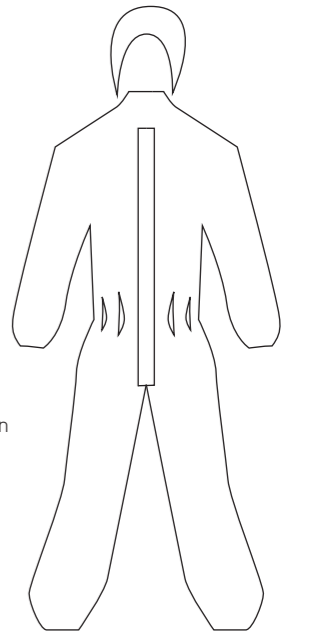

**Tulum**  
Coverall Isolation Gown

Ürünlerimiz İstenilen renk ve ebatta yapılabilmektedir.