

**Integral Dental Unit Chair
Operation Manual
(technical manual)**



Ningbo Runyes Medical Instrument Co., Ltd.

Add: 032 Building, No. 456, Tonghui Road, Jiangbei Investment
& Pioneering Park C, 315033, Ningbo, China

Tel : +86-574-27709922

Fax: +86-574-27709923

Email: runyes@runyes.com

<http://www.runyes.com>



Shanghai International Holding Corp.GmbH (Europe)
Eiffestrasse 80, 20537 Hamburg, Germany

Tel : +49-40-2513175

Fax : +49-40-255726

Version Number: 2020-04-11

Important information

This instruction is the installation, operation and maintenance manual of Care Series Dental Unit. Please read carefully before using the machine.

Care series products including following models: Care-11、Care-22、Care-33

Without the written permission of Runyes Medical Corporation, any forms of modification ,spread, reprint and sales of this instruction is forbidden.

Runyes company reserves the final explanation right, illustration right and changing right of this instruction.

Product Name:

Product Model:

Serial no:

Date of manufacture:

Voltage:

Attention

Caution: power must be connected with reliable grounding line.

Warning: Please cut off the power supply and the gas supply before cleaning or maintaining.

Noting: Please cut off the power supply and the gas supply after work.

Noting : Dental units should be used in the ventilated room that the humidity not exceeding 80%, temperature not exceeding 40%.

Suggestions:









































1. Please don't install or use this device near water or when you are wet.
2. Please place the device on firm, clean and level floor(uneven floor will affect the device's performance or even cause accident).
3. Please install this device on safe place in case that someone steps on the power cord.
4. Please install the device in clean, dry, ventilated and cool places.
5. If the device can't work normally, please read "Trouble shooting" in page 32 of this manual or you can contact supplier or us. We will solve the problem for you as soon as possible.

Contents

1. Summary.....	1
1.1 Usage.....	1
1.2 Composition.....	1
1.3 Classification.....	1
1.4 The installer's duty.....	1
1.5 The use'r duty.....	1
1.6 Attentions.....	1
2. Product introduction and features.....	2
2.1 Dental unit standard configuration.....	2
2.2 Dental chair standard configuration.....	2
2.3 Dental unit features.....	2
2.4 Dental chair feature.....	3
3. Structure diagram.....	3
4. Environment requirements.....	4
5. Technical parameters.....	5
6. Plane layout drawing.....	6
7. Installation.....	7
7.1 Preparations.....	7
7.2 Dental unit installation.....	7
7.3 LCD supporting installation (as picture 5 shows).....	8
7.4 Lamp arm and lamp installation.....	9
7.5 Pipeline Installation.....	9
7.6 Power supply installation.....	9
7.7 Doctor chair installation.....	9
7.8 Care 11/22 dental chair cushion, backrest and headrest installation.....	9
7.9 Care 33 dental chair cushion, backrest and headrest installation.....	10
8. Device debugging.....	10
8.1 Dental chair parts.....	10
8.2 Side box part.....	12
8.2.1 Side box main part.....	12
8.2.2 Ceramic cuspidor, mouth wash water and cuspidor flush water.....	12
8.2.3 Water temperature indicator (care 22/33 standard).....	12
8.2.4 Water storage.....	12
8.3 Assistant console.....	15
8.3.1 Assistant control panel.....	16
8.3.2 Three-way syringe.....	16
8.3.3 Suction.....	16
8.3.4 Strong suction.....	16
8.4 Instrument tray.....	17
8.4.1 Instrument tray.....	18
8.4.2 Orbicular manometer.....	18
8.4.3 Air Brake left (right) Switch.....	18
8.4.4 Adjustable value for Air.....	18
8.4.5 Adjustable value for Water.....	18
8.4.6 Main Control Panel.....	18
8.4.7 X ray Film Viewer.....	18
8.4.8 Three-way syringe.....	18
8.4.9 High Speed Turbine Hand piece.....	18
8.4.10 High Speed Turbin Hand piece "Blowing"Function.....	19
8.4.11 Low Speed Motor Hand Piece.....	19
8.4.12 Ultrasonic scaler (Option).....	19
8.4.13 Key operation and setting instructions.....	19
8.4.14 Universal Key Setting (CARE 33).....	22

8.5 Foot Switch.....	22
8.5.1 "F1"Foot Switch Instruction.....	22
8.5.2 "F2"Foot Switch Instruction.....	23
8.5.3 "F5"Foot Switch Instruction.....	23
8.6 Oral Lamp.....	23
8.6.1 Halogen Lamp.....	24
8.6.2 LED Lamp.....	24
8.6.3 DCI LED Lamp.....	24
8.6.3.1 Lamp button standard operation.....	25
8.6.3.2 Infrared sensor.....	25
8.6.3.3 Editing infrared sensor function.....	26
9. Device debugging.....	26
9.1 Device debugging.....	26
9.2 Debug High Speed Turbine Hand Piece.....	27
9.3 Debug Low Speed Motor Hand Piece.....	27
9.4 Debug three-way syringe.....	27
9.5 Debug Dental lamp.....	27
9.6 Debug Dental Chair.....	27
9.7 The preparation before operating the sentel unit.....	28
9.8 CARE 11 Side box horizontal adjustment.....	28
9.9 CARE 22&33 side box horizontal adjustment.....	29
9.10 Side box water storage bottle air pressure adjustment.....	29
9.11 CARE 11 balance arm force adjustment.....	29
9.12 CARE 22&33 balance arm force adjustment.....	30
9.13 CARE 11 balance arm horizontal adjustment.....	30
9.14 CARE 22&33 balance arm horizontal adjustment.....	31
9.15 Lamp arm force adjustment.....	31
9.16 Adjustment of the hanger.....	31
10. Precaution.....	32
11. Trouble shooting.....	32
11.1 The whole equipment has no electricity.....	32
11.2 The dental unit has no air no air pressure is not enough.....	33
11.3 The dental unit has no water or water pressure is not enough.....	33
11.4 Oral Lamp is off.....	33
11.5 Oral Lamp does not focalize.....	33
11.6 Film viewer is off.....	33
11.7 The suction is not strong enough.....	33
11.8 The suction of weak suction is not enough.....	33
11.9 The drain of rinse basin in not smooth.....	33
11.10 The rotation speed of high speed turbine hand piece is low and week.....	33
11.11 Low speed motor hand piece does not work or the rotation speed is too low.....	33
11.12 Hang rack switch can not control water and supply.....	33
11.13 Simple troubleshooting.....	36
12. Maintenance.....	38
12.1 Dental unit and dental chair maintenance.....	38
12.2 Hand piece maintenance.....	38
12.3 Three-way syringe maintenance.....	38
12.4 Oral Lamp maintenance.....	38
12.5 Strong(weak)suction maintenance.....	38
12.6 Ceramic basin drain tube maintenance.....	38
12.7 Air filter decompression valve maintenance.....	38
12.8 Water filter maintenance.....	39
12.9 Disinfection of dental chair piping system.....	39
12.10 Chemical disinfection.....	39
12.11 Ordinary cleaning.....	39
13. Circuit Diagram.....	40
14. Water/Air pipeline diagram.....	41
15. Transportation and storage.....	42
16. Electromagnetic compatibility.....	42
17. Packing List.....	45

Icon Description

	Attention: Failure to follow the instructions will lead to equipment damage.		Manufacturer
	Warning: Failure to follow the instructions will result in equipment damage and operator injury. Failure to follow the instructions will lead to equipment damage.		Type B equipment(Electric shock protection)
	Remarks: other important information, besides warning and attention		Ground protection
	Alternating current		Class II equipment
	Manufacturing date		
	Electronic waste equipment		Refer to user manual
	Meet EU requirement		Light key: on/off on
	Set key		Adjust light intensity
	Rinse basin flush key		Stop blue light
	Heating key		Infrared sensor
	Mouthwash water key		
	Withdraw key		Water fine tuning
	Reset key		Air fine tuning
	1		Water storage air switch
	2		
	3		
	R Spitting and gargling position key		Water source transformation switch
	Backrest lean forward key		
	Backrest lean back key		
	Seat up key		
	Seat down key		

1. Summary

1.1 Usage

Care series (top mounted and down mounted type) dental unit is suitable for modern dental hospital or clinic. It is used for diagnosing, treatment or operation. for tooth extraction; tooth scaling, tooth filling and implant.

This device can be divided into top mounted type (U) and down mounted type (D). This device is easier to use, needs less maintenance and has longer service life.

1.2 Composition

This device is composed of dental unit, dental chair and doctor stool. Dental unit is composed of high speed handpiece (optional), low speed handpiece (optional), oral lamp, film viewer, instrument tray, syringe gun, mouthwash water supply device, weak suction, strong suction, cuspidor, foot control pedal, water filter.

1.3 Classification

Class I Type B fixed device

1.4 The installer's duty

The installer should:

- Make sure the electricity voltage meet the manufacturer's demand;
 - Make sure there is a switch to cut off power during installation for safety.
 - Install and detect this device according to the operation manual.
- Provide the user with this operation manual.

1.5 The user's duty

The user should:

- Using this device according to this operation manual.
- Maintain this device according to the time list made by the producer. The manufactures or the dealers shall not assume any liability if any damage or injure is caused by the improper modification or maintenance conducted by the user that is not designated by us.
- Please inform the sanitation department, the manufacturer or the dealer of the device immediately when accident is related with this device.
- The report given by the manufacturer should include the model NO. And series NO.. The users could get these information from the technical label.

! 1.6 Attentions

- According to existing legal rules, this device can only be used by trained people
- Caution: power must be connected with reliable grounding line.
- Cut off the power before cleaning or mending
- Do not use this device in a flammable mixture of gas and air anesthesia or oxygen or nitrous oxide
- Do not use this device in strong electromagnetic environment, or the device will be damaged.

2. Product introduction and features

2.1 Dental unit standard configuration

NO.	Configure	Quantity	Function Description	Remarks
1	Four-hole high speed turbine handpiece (optional)	Two sets	With blowing and anti-absorption functions	
2	Four-hole low speed motor handpiece (optional)	One sets	With straight and bend head tube	
3	Three-way syringe	Two sets		
4	Constant rinse water temperature system	One sets	Adjustable range 30°C - 45 °C	Care-22/Care-33 standard
5	Dental lamp	One sets		
6	Film viewer (optional for down mounted)	One sets		
7	Rotatable cuspidor	One sets		Care-11U/11D/22U/22D
8	Integral luxury cuspidor	One sets		Care-33U/33D
9	Rotatable side-box	One sets	Available for four hand operation	Care-22U/22D/33U/33D
10	Suction	One sets	time delay function	
11	Strong suction	One sets	time delay function	
12	Clean water system for handpiece	One sets	Clean water system for handpiece	
13	New design of foot switch	One sets	Fashionable and flexible	
14	New design of doctor chair	One handles	Ergonomic design backrest, beautiful and practical	

2.2 Dental chair standard configuration

1	With DC 24voltage motor, lower noise, easier to control and more reliable
2	Linkage compensation structure comply to the human engineering design
3	With safety protection function, make the users have more safe guards
4	With chair lock system
5	Digital computer program setting (three chair position user-defined memory)

2.3 Dental unit features

1	Linkage compensation structure comply to ergonomic design and make the patient more comfortable
2	prevention for leg/foot clamping. Safety protection setting ensure the safety of the doctors.
3	Chair will be locked while handpiece is working, ensure the safety of doctors
4	Integrated PU base with perfect combination of luxury and steady. (Care-22/Care-33 standard)
5	New luxury armrest

2.4 Dental chair features

1	Air turbine high speed hand piece has anti-resorption function
2	Air turbine high speed hand piece has the blowing function
3	Chair will be locked while handpiece is working, ensure the safety of Seat cushion and backrest: Care 11 apply sofa leather, Care 22 and 33 apply imported sewing leather
4	Film viewer - clamshell design.(optional for down mounted)
5	Constant temperature water supply system& adjustable temperature option(standard for care 22/33)
6	Built-in water storage system standard for care 22
7	Water storage insufficiency alert system (standard for care 22)
8	Rotatable luxury cuspidor (standard for care 11)

3. Structure diagram

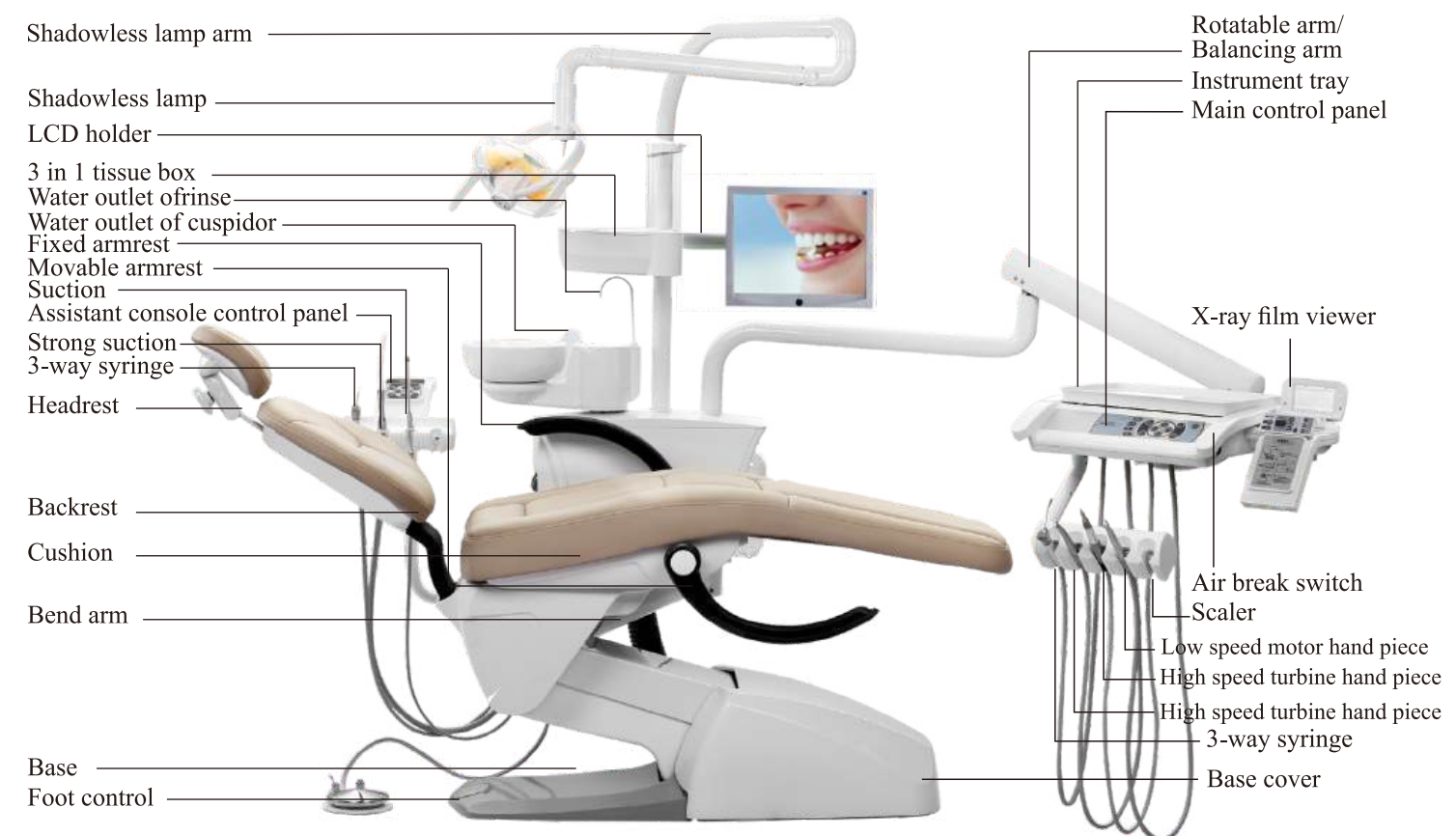

4. Environment requirements

Items	Environment requirement
Preconditions	<ol style="list-style-type: none"> 1. Temperature: 5°C~ 40°C 2. Relative humidity: ≤ 80% 3. Pressure: 860Hpa~1060Hpa
Power supply	<ol style="list-style-type: none"> 1. The devices used in medical should conform to the installation rules. All the water and electricity installation should be accorded with national regulations 2. The power used: AC230 50Hz/60Hz
Water supply	<ol style="list-style-type: none"> 1. conformance to local drinking water regulations. 2. Cleaning all the pipes before using 3. Pressure: 0.2 MPa ~ 0.4 MPa 4. Water flowing rate: no less than 10L/min 5. The water hardness limit is less than 2.14mmol/L 6. PH valve :6.8-8.5 7. Maximum particle diameter less than 100 microns
Air supply	<ol style="list-style-type: none"> 1. Clean, dry and no oil 2. Pressure: 0.55MPa ~0.7 MPa 3. Air flowing rate: no less than 50 L/min 4. use the air source supply which has related exhausting pressure as 0.8MPa.
Waste water pipe	The arrangement of the waste water pipeline should slope one centimeter in the direction of draining off water every meter pipeline.

5. Technical parameters

Items	Technical parameters	
Power supply	230V-50HZ	
Power	600VA	
Fuse	C6X20 T2AL、 T3AH、 T5AL、 6.3AL、 T8AL	
High Speed Turbine hand piece	Unload speed: ≥300000r/min Working pressure: 0.26MPa	
Low Speed hand piece	Unload speed: ≥200000r/min	
Foot switch	IPX 1	
Lamp luminance	Halogen lamp 8000Lx -15000Lx	DCI LED High-end 23000-30000Lux DCI LED Mid-range 17500-18800Lux DCI LED Low-end 4000-12600Lux
Lamp bulb	Halogen lamp 12V-50W DCI LED 24V-0.25A	
Film-viewer luminance	≥2000 Lx	
Rinse water thermostat	24V-80W Temperature range 35-45 ° C	
Linear motor	24V = 100W	
Instrument tray load	1KG	
Dental chair max load	180KG	
Maximum height from ground	Care 11/22 800mm Care 33 830mm	
Minimum height from ground	390mm	
Elevation and depression angel of backrest	0° - 80°	
Cycle Time	One minute for working and 15minutes for rest	
Pipeline color identification	Blue pipeline for water. Yellow/black pipeline for air	
Equipment weight	Net weight: 225 KG Gross weight: 336 KG	
Package(2 boxes)	Dental chair	Length:1450mm Width:900mm Height:935mm
	Dental unit	Length:1610mm Width:1130mm Height:1340mm
1 Box	Dental unit(short)	Length:1610mm Width:1130mm Height:1275mm

6. Plane layout drawing

1. water supply pipe: white PPR hot melt pipe, reserve 4cent copper internal teeth interface. (PPR hot melt pipe, 4 cent inner outer teeth straight through valve is recommended)
2. air supply pipe: the same as water supply pipe.
3. waste water pipe: white PVC drain pipe, main pipe $\Phi 75\text{mm}$, branch pipe $\Phi 50\text{mm}$
4. VGA monitor and USB data wire pipe: white PVC threading pipe $\Phi 32\text{mm}$, reserve one iron wire for threading.
5. negative pressure pipe: blue UPVC water supply pipe, main pipe outer diameter 50mm, branch pipe outer diameter 32mm, pipe connect to the chair diameter 25mm
6. negative pressure signal wire: white PVC pipe, 4cent($\Phi 20\text{mm}$) pipe sleeve 3*1mm 2 wire.
7. power cord: white PVC pipe, 4cent($\Phi 20\text{mm}$) pipe sleeve 3*1mm, 5mm 2 wire.

Notes: do not use right angle connector between drain pipe and negative pressure pump, 45-degree connector is recommended.

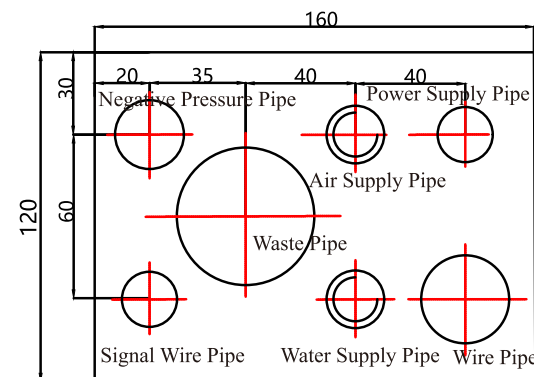
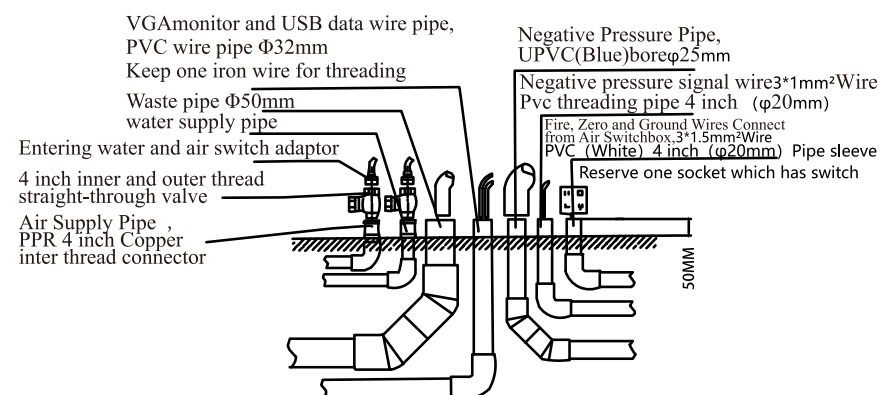
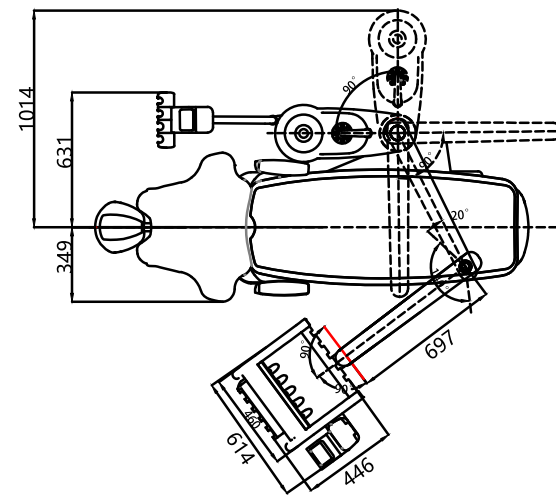
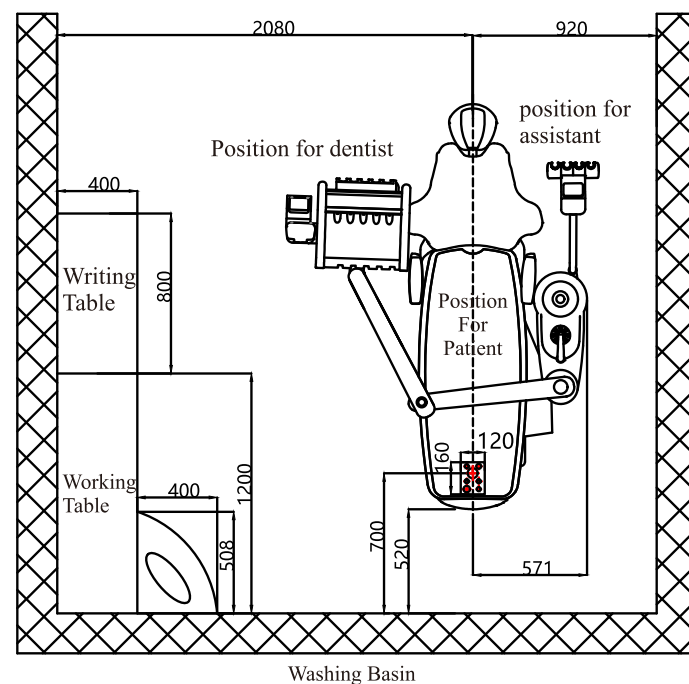

7. Installation

7.1 Preparations

- 1> Confirm the installation position according to the actual situations layout of clinic, light and operation convenience of the clinic, and ensure the device can work on the clean, dry and ventilated place.
- 2> Ensure the floor hold the device is solid and level, reserve enough space for operation
- 3> The socket of power supply is triangle socket with ground wire.
- 4> Open the packing box of the treatment machine, take out spare parts.
- 5> Check accompanying documents: instructions, qualification card, guarantee card and packing list.
- 6> Check if the equipment is intact and accessories are complete.
- 7> Arrange the water inlet pipe, air inlet pipe, water outlet pipe and power cord within the range of the base box according to the structure drawing below.
- 8> Standards and requirements of the water inlet pipe, air inlet pipe, water outlet pipe and power cord:

Item	Standards	Height above the ground	Remarks
Inlet pipe for water	$\Phi 15\text{mm}(\frac{1}{2}')$	20mm	$\frac{6}{8}$ " Pipe threads; safety valve switch should be installed in the connector
Inlet pipe for air	$\Phi 15\text{mm}(\frac{1}{2}')$	20mm	$\frac{6}{8}$ " Pipe threads; safety valve switch should be installed in the connector
water outlet pipe	$\Phi 40\text{mm}(1\frac{1}{2}')$	20mm	
Line cord	2mm^2	50mm	

7.2 Dental unit installation

- 1> Open the packing box of the dental unit, take out spare parts.
- 2> Check enclosed documents: Instructions, quality certificate, guarantee card and packing list.
- 3> Dental unit installation procedures as below:
 1. Use the NO. 14 tool to unload the fixed screws on pallet (as picture 1 shows). Then connect the power, switch on the power, lift the dental chair and open the base box cover.
 2. Screw off the two M8 screws with NO. 14 tool (as picture 2 shows) so that the dental unit can be moved away from the baseboard. Please fix the two screws on the baseboard.
 3. Move the dental unit to the appointed position
(Attention! Please carry the base of the dental unit. Do not carry the backrest or seating cushion)

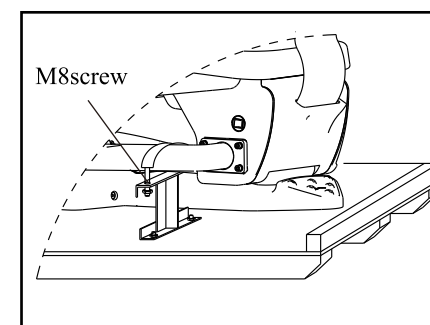

Fig-1

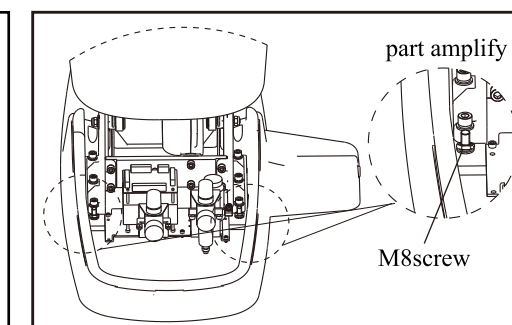

Fig-2



Remove the screw sleeve when disassembling the machine, then remove the screw. After lifting the machine off the wooden bracket, screw back the screw in time. Then cover the screw socket.

4 > Fission type disassembling step

1. Switch on the power, lift the dental chair, open the base box cover. Screw off the two M8X45 using the NO. 6 tool (as picture 2 shows) so that the dental unit can be moved away from the baseboard. Please fix the two screws on the baseboard. (Attention! Please carry the base of the dental unit rather than the backrest or seating cushion).
2. Remove the side box from the fixed iron plate. Attention! Several people should work together during this process.(as picture 3 shows).
3. Move the side box board to the dental chair connection. After connecting the joint in the installation hole, please use the NO.8 tool to connect the side box and dental chair with M10X45 screws. Several people are needed during this process. (As picture 4 shows)
4. Move the dental unit to the specific position

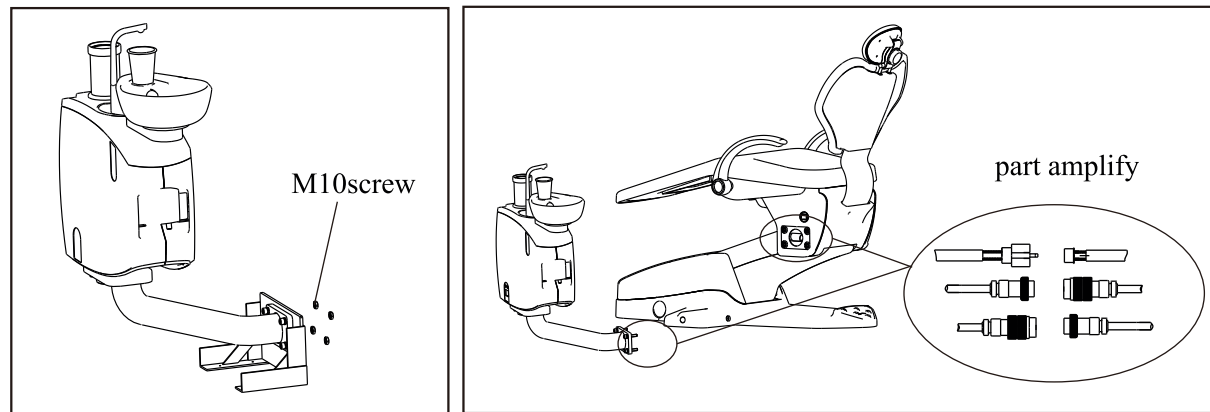

Fig-3

Fig-4

7.3 LCD supporting installation (as picture 5 shows)

- 1 > Thread the core line through the supporting stand, and fix the M4 screws
- 2 > Joint the connector with the connector in the side box standing. Attention! One is the shadowless lamp power, and the other is the display power. Put display power cord into the side box standing. (Attention! Please do not damage the wire during installation)
- 3 > Put the lamp pole into the standing and install the lamp arm in a suitable place. (Attention! Do not forget to install the decoration ring during installation)

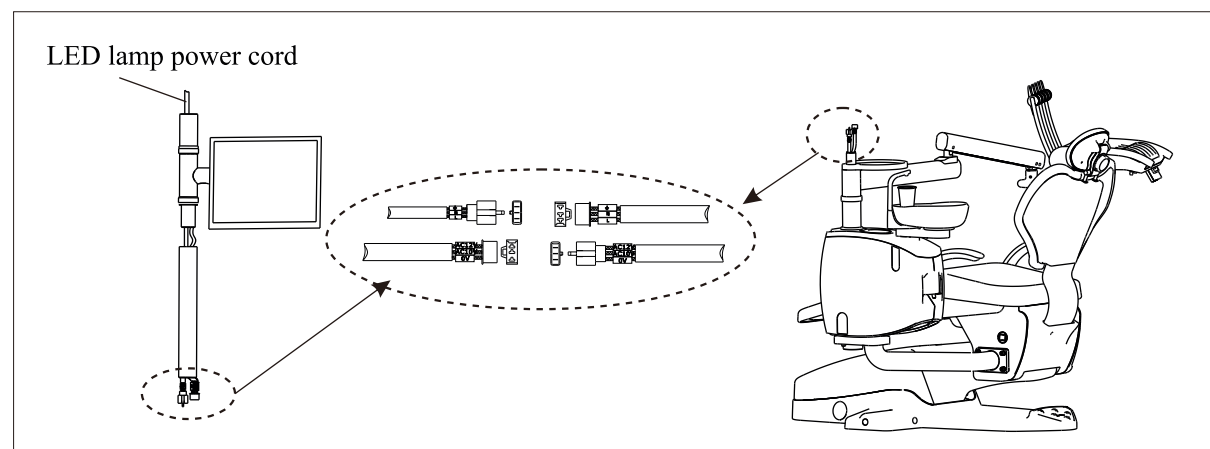

Fig-5

7.4 Lamp arm and lamp installation

1. Wires on the lamp arm should thrill through the lamp column and connecting well.
2. Connect the wire connector of the lamp arm with the one in the column of the side box, and put them into the column
3. Insert lamp column into column hole on side box, install the lamp arm on the suitable place (Attention: avoid damage the wire when install)
4. Take out the lamp, unscrew the lamp, then fix the lamp to lamp arm and tighten the screw.(Attention: connect the wire and tighten the screw)

7.5 Pipeline Installation

1. Drain the water inlet pipe and air inlet pipe to get rid of the dirt and impurity in the pipeline, keep the pipes unblocked, before connecting the pipeline to dental unit.
2. Connect $\Phi 8$ high pressure air pipe to water pipe (green) and air pipe (yellow), ensure no leak between pipes. (attention: if the air inlet pipe and water inlet pipe have no independent switch, find the two 1/4 ball valves in accessories and install to the water inlet pipe and air inlet pipe. It will be more convenient for maintenance)
3. Insert the drain pipe of dental unit into the drain pipe connector, keep the water outlet and air outlet pipe unblocked. (Attention: Pay attention to the color of the pipes.)

7.6 Power supply installation

1. Insert the power supply wire into the socket with ground line.
2. Open the switch on the bottom of the dental unit.

7.7 Doctor chair installation

1. Open the packing box.
2. Press down the five wheels of the chair soleplate (or twist into by wrench).
3. Put the thick side of the air spring into the chair soleplate.
4. Connect the chair side with the armrest, and put it on the side of thin air spring.

7.8 Care 11/22 dental chair cushion, backrest and headrest installation

- put the cushion to the dental chair and press, fit the 4 buckles to the slot, then use M8 inner hexagon screw to fix.

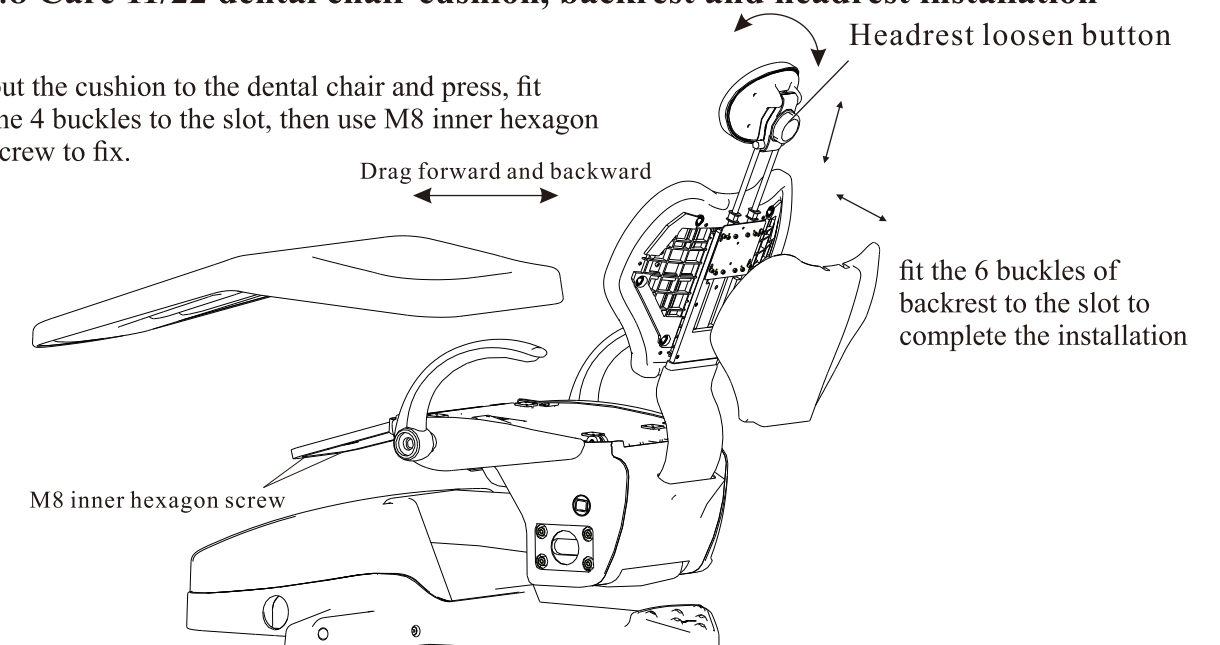

7.9 Care 33 dental chair cushion, backrest and headrest installation

1> cushion installation

- (1) turn the 2 buckles to horizontal position
- (2) put the cushion on the cushion board, aim the square hole and install in
- (3) ensure the iron plate is in right position, then turn the buckles to fix

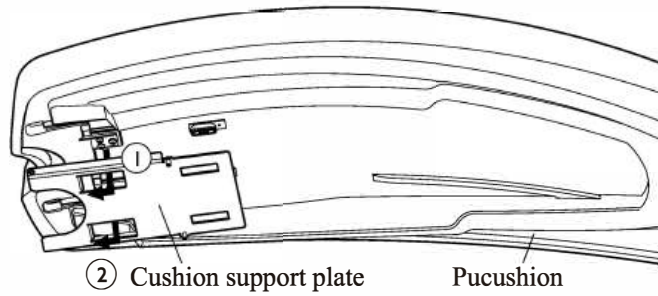

Warning: incorrect installing of cushion will cause damage to equipment and injuries to people

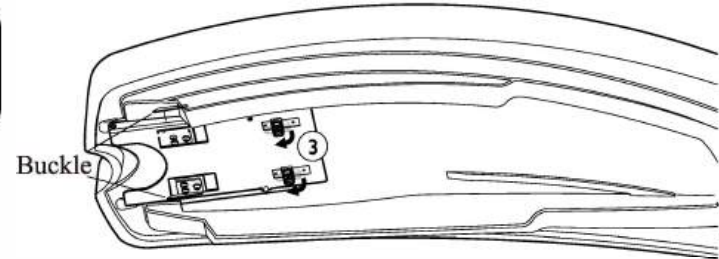

2> backrest installation

- (1) move the backrest to 45-degree position
- (2) aim the holes on the backrest to the plat head screw on the metal plate, then install in.
- (3) press the backrest and push to the cushion direction to fit the plat head screws in the lock hole.
- (4) ensure all of the 4 plat screws are in the lock holes, and keep pushing till the backrest is totally fix to the metal plate.

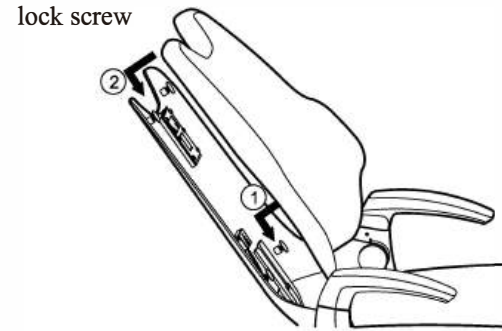

3> headrest installation

- (1) aim the lock hole on the headrest to the plat head screw on the headrest plate
- (2) press the headrest and push to the cushion direction till the screws are lock to the holes
- (3) fix the headrest to the plate with #6-32 screw

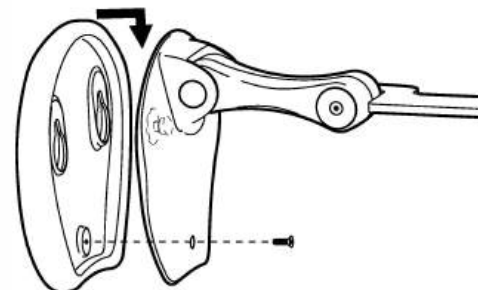

8. Device debugging

8.1 Dental chair parts

- 1> Dental chair adopt 24V straight line driving motor, low noise
- 2> Dental chair limited position measurement (see drawings below)
- 3> Headrest can be lifted and rotated
- 4> Right armrest can be rotated
- 5> buttons on the back of dental chair control the cushion and backrest to move up and down (Care 33)
- 6> Anti clamping function on the back of chair frame

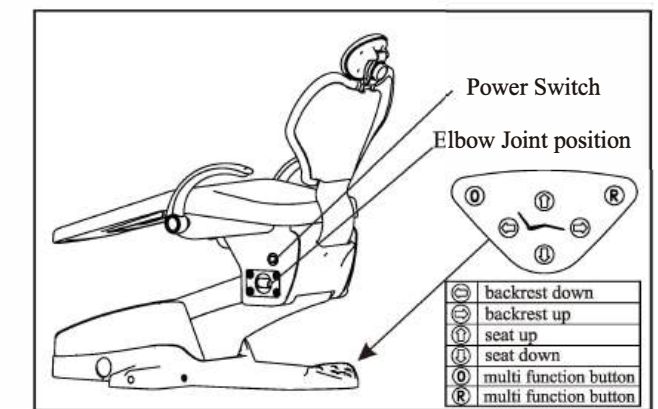
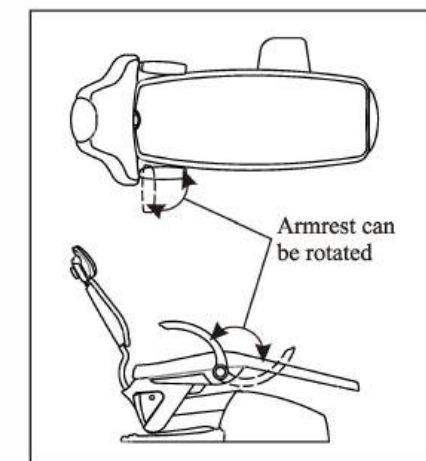
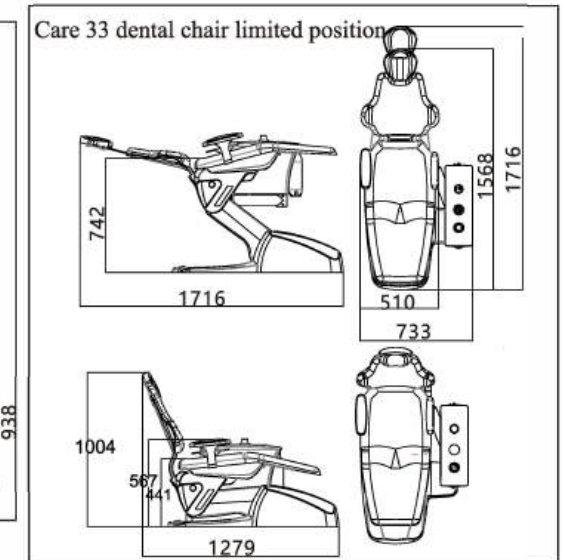
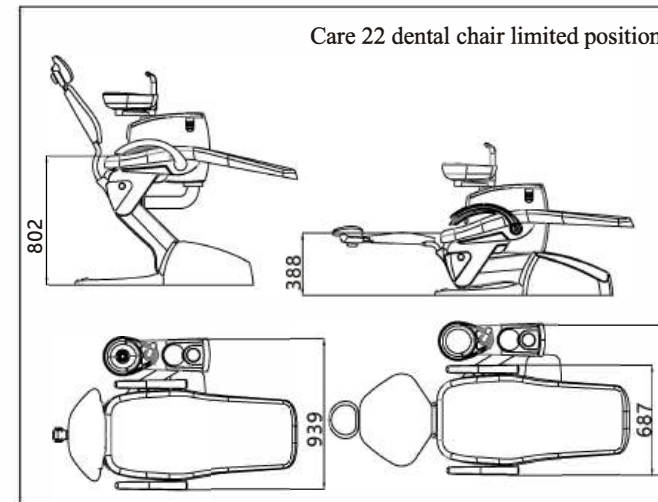
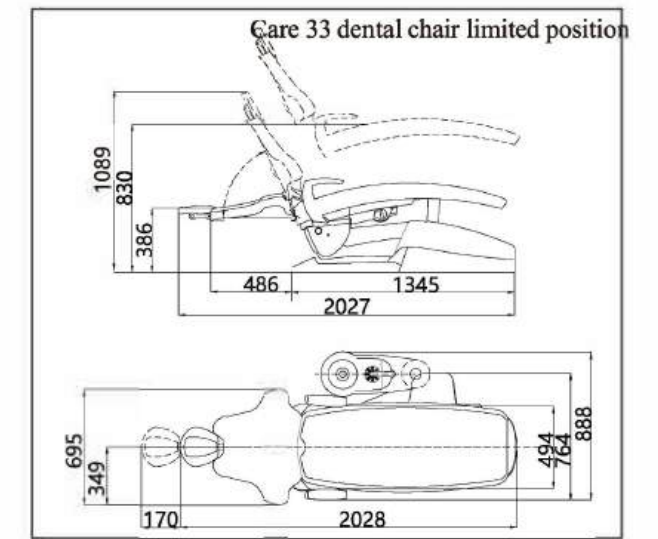
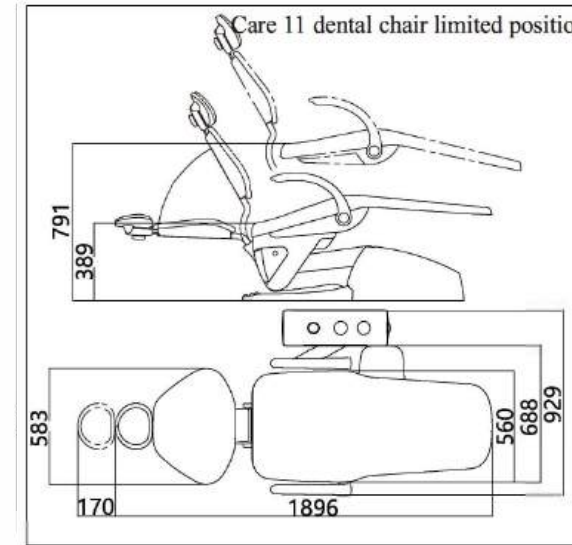

Attention: maximum load of armrest is 20KG

8.2 Side box part

8.2.1 Side box main part

Care 22/33 side box can be rotated in 0-90°, convenient for different treatment and four hand operation

8.2.2 Ceramic cuspidor, mouth wash water and cuspidor flush water

1> Care 11/22 ceramic cuspidor can be rotated in 0-90°

Care 33 cuspidor is fixed

2> Users can open the side box to adjust the flow of mouth wash water and cuspidor flush water. Tighten the pipe pressure valve to reduce the flow, or loosen the valve to increase the flow.

Attention: do not loosen the valve too much, or will cause water leakage.

8.2.3 Water temperature indicator (care 22/33 standard)

1> the indicator indicates the temperature of the water in the water heater.

2> press the mouth washing water heating button, choose the temperature between 35 and 45°C.

3> ensure the measured temperature is the same as the display temperature before use.

8.2.4 Water storage

The dental chair has two water supply modes for instruments: water storage water supply system and external water supply system.

1> water storage supplies pure water to handpieces, syringe and scaler

2> the volume of water storage bottle is 1000ml

3> the water must be medical grade pure water or distilled water

4> care 22 side box has internal water storage bottle, do not need to take off the bottle for filling water

4.1 turn off the water storage bottle air switch

4.2 after no air leak sound from the water storage bottle air switch, open the cap of the bottle

4.3 Use water funnel to fill water, close the cap after filling water

4.4 turn on water storage bottle air switch

5> Fill water for care 11/33 side box water storage bottle

5.1 turn off the water storage bottle air switch on the bottom of side box

5.2 after no air outlet sound from the water storage bottle air switch, take down the bottle

5.3 after filling water, install it back to side box, ensure there is no leakage

5.4 turn on water storage bottle air switch

6> find the water source change switch from the top or bottom of side box, it is for choosing water storage water supply system and external water supply system

Here we suggest you to use the purified or distilled water as the main water source of instrument.

It is not only good for the patients, but also do good to the air pipelines of dental unit's instruments (such as high-speed hand piece, low speed hand piece, three-way syringe and ultrasonic scaler), which can extend the service life.

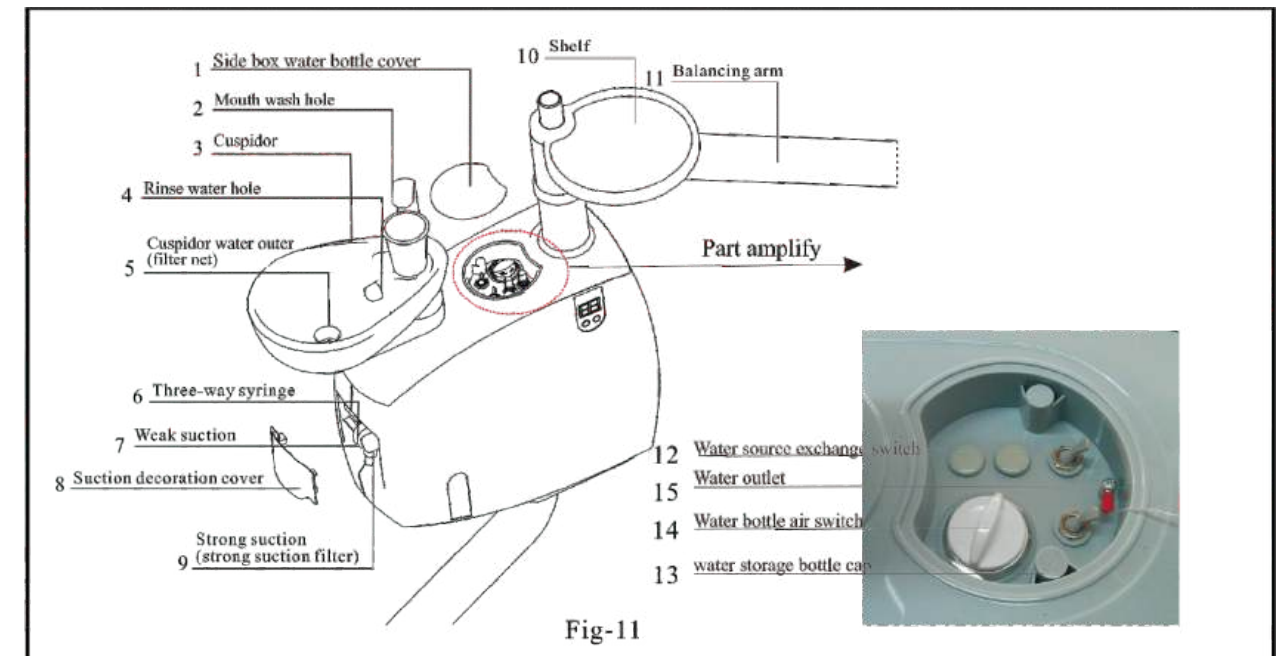
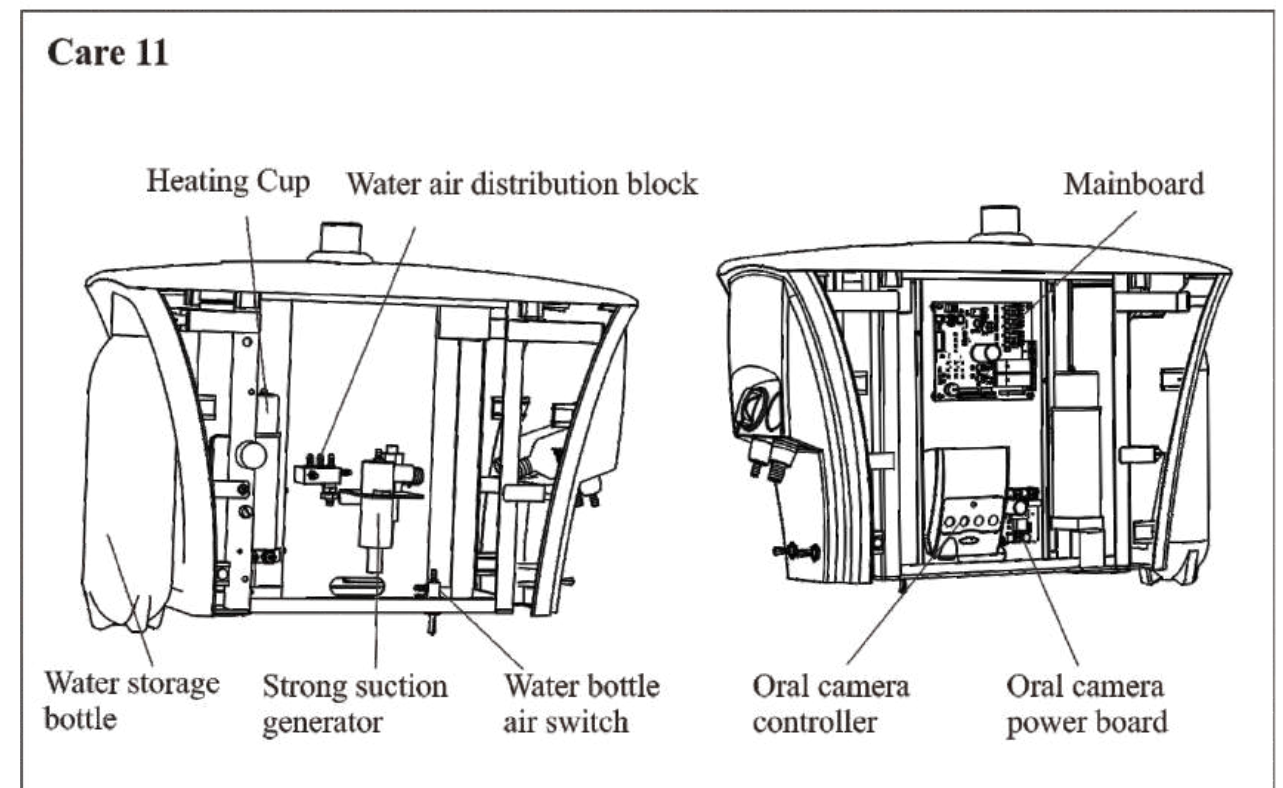
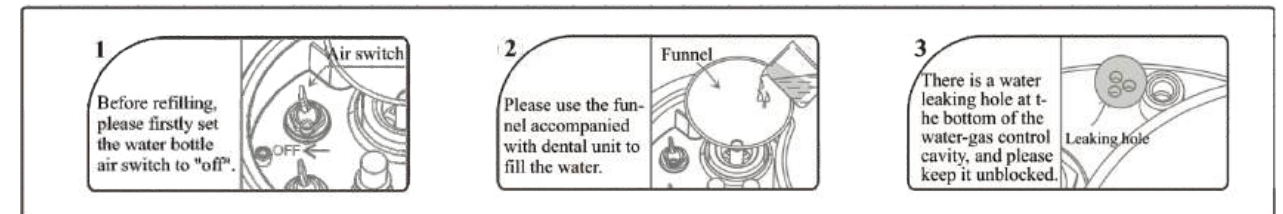
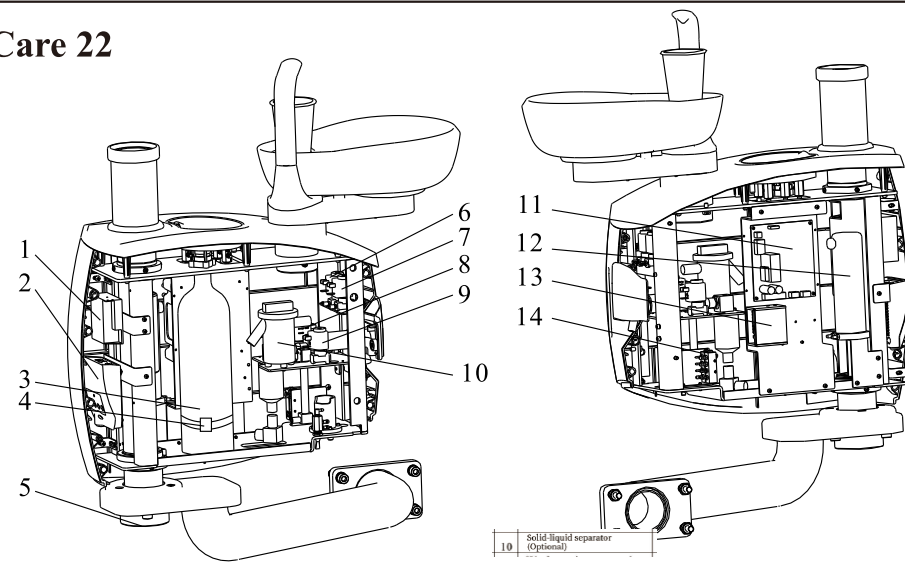

Fig-11



Care 22



NO.	Name	NO.	Name	NO.	Name	NO.	Name
1	DC5V power supply	5	Outlet connection	9	Weak suction valve	13	Curing light mainboard (optional)
2	Oral camera main control	6	Mouth wash valve	10	Solid-liquid separator (Optional)	14	Water air distribution block
3	Water storage bottle	7	Rinse water valve	11	Mainboard		
4	Water level sensor	8	Strong suction valve	12	Heating cup		

Care 33

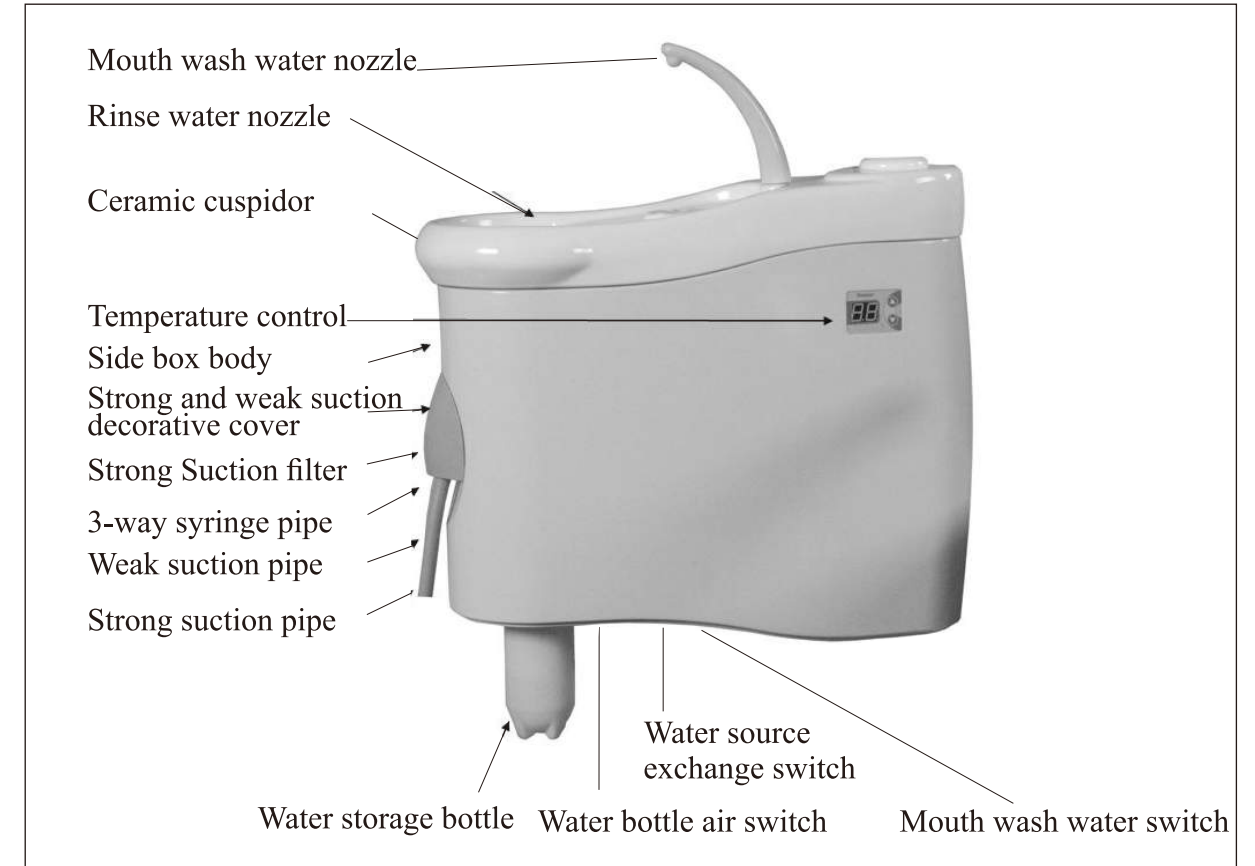
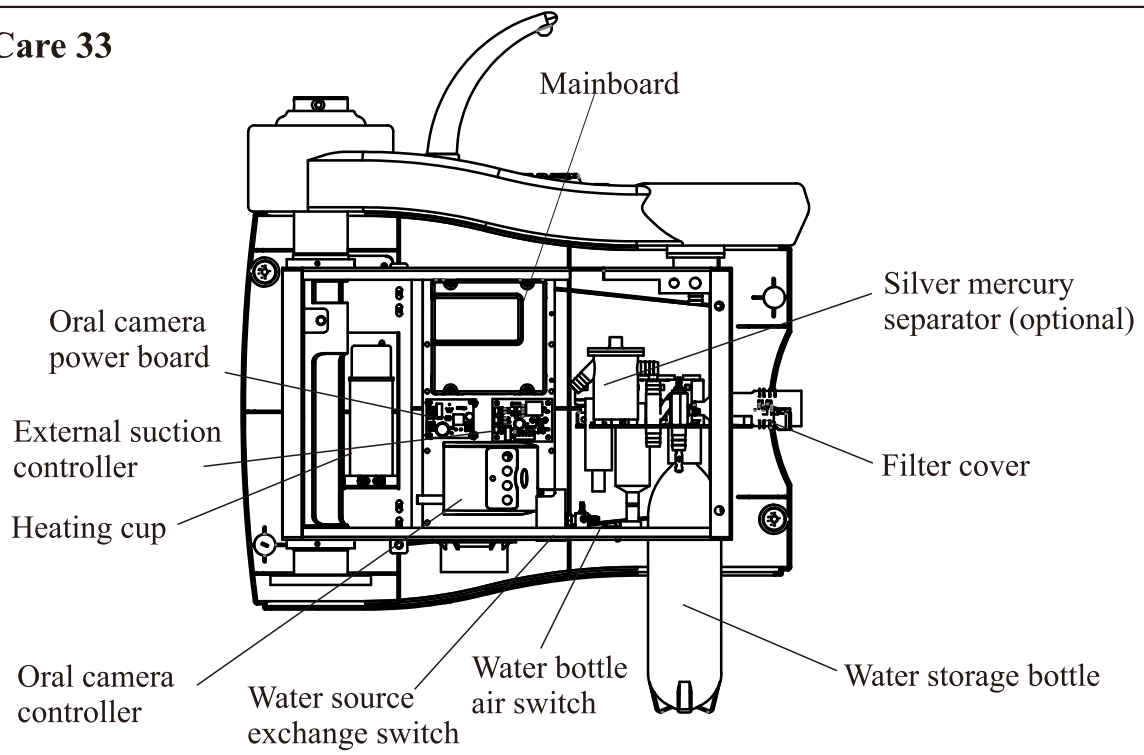

8.3 Assistant console

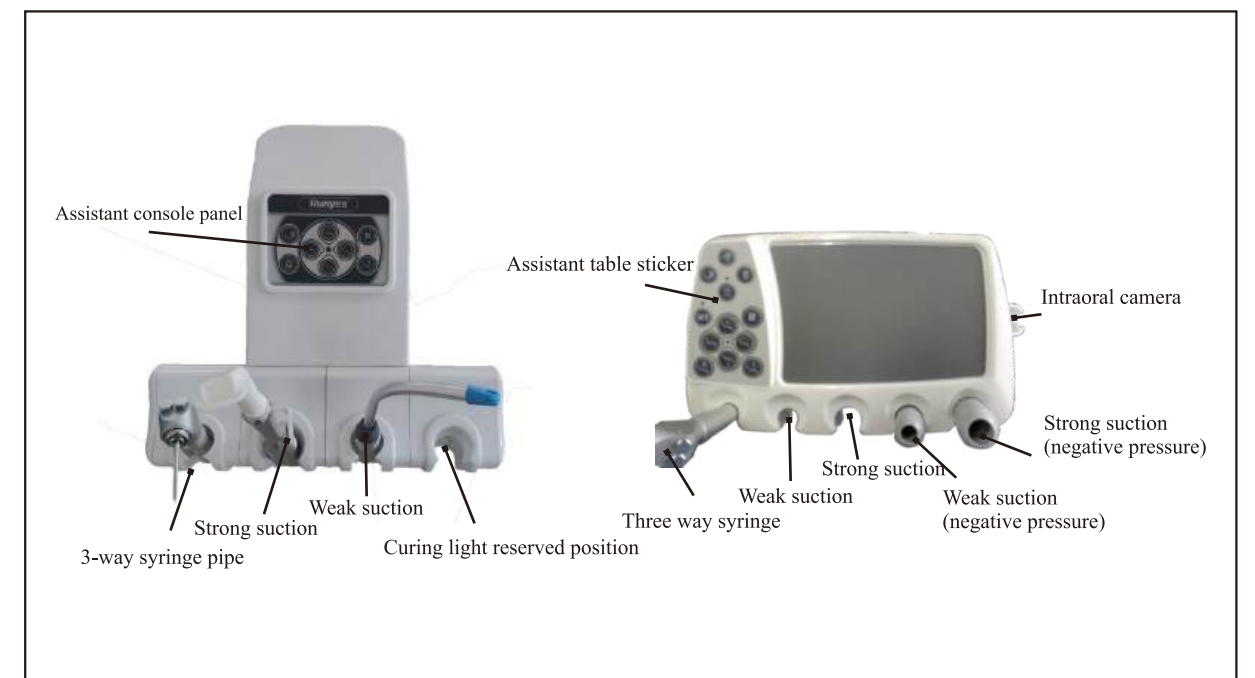

8.3.1 Assistant control panel

Please see "main (assistant) control panel" on page 20

8.3.2 Three-way syringe

1. The 3-way syringe on the assistant console is connected with the mouth wash heating system. So once the heating system is opened, this 3-way syringe will have constant temperature water.
2. Other operation method please refer to the "adjustment of 3-way syringe" on page 27.

8.3.3 Suction

1. It's mainly used to suck the mobile substance in the mouth during operation. The suction provide the negative pressure by water suction or air suction .
2. When the suction is taken up, it starts to work.
3. When the work is over, put the aspirator back to the rack, which will continue to work for 5 seconds (delay setting), then it will stop automatically.
- 4) When water pressure is not less than 300kpa, vacuum is not less than 13kpa, water suction rate will not be less than 0.42L/min
- 5) Pipette and pipe joint length is 6mm
- 6) Mesh size of strong suction filter is 1mm, daily cleaning and disinfection is recommended

8.3.4 Strong suction

1. It's mainly used for operation and cleaning.
2. The power source to produce vacuum negative pressure is the compressor air.
3. When the work finished, put the strong aspirator back to the rack, which will continue to work for 5 seconds to eliminate the impurity remained in the pipe. (Attention! Please clean the strong suction filter often.) picture 14
- 4) The vacuum degree is no less than 13kPa and the flow rate is no less than 1.2L/min when the air pressure is 300kPa.
- 5) Pipette and pipe joint length is 10.5mm
- 6) Mesh size of strong suction filter is 1mm, daily cleaning and disinfection is recommended

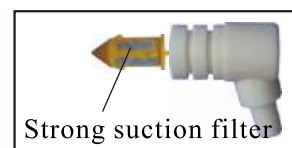
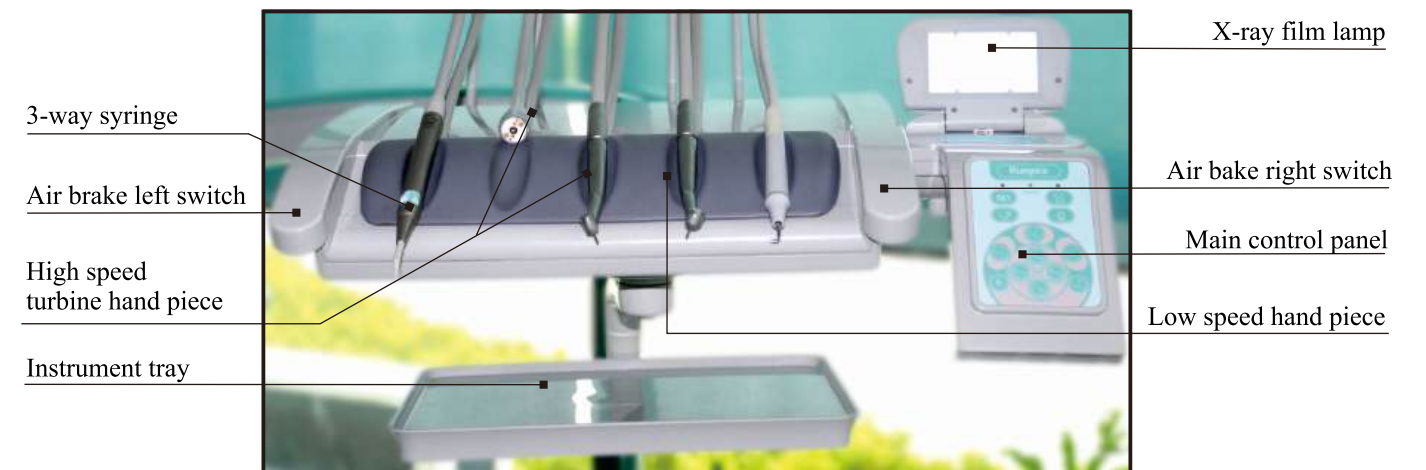

Fig-14

8.4 Instrument tray

Top mounted type control panel:



Hanging type:

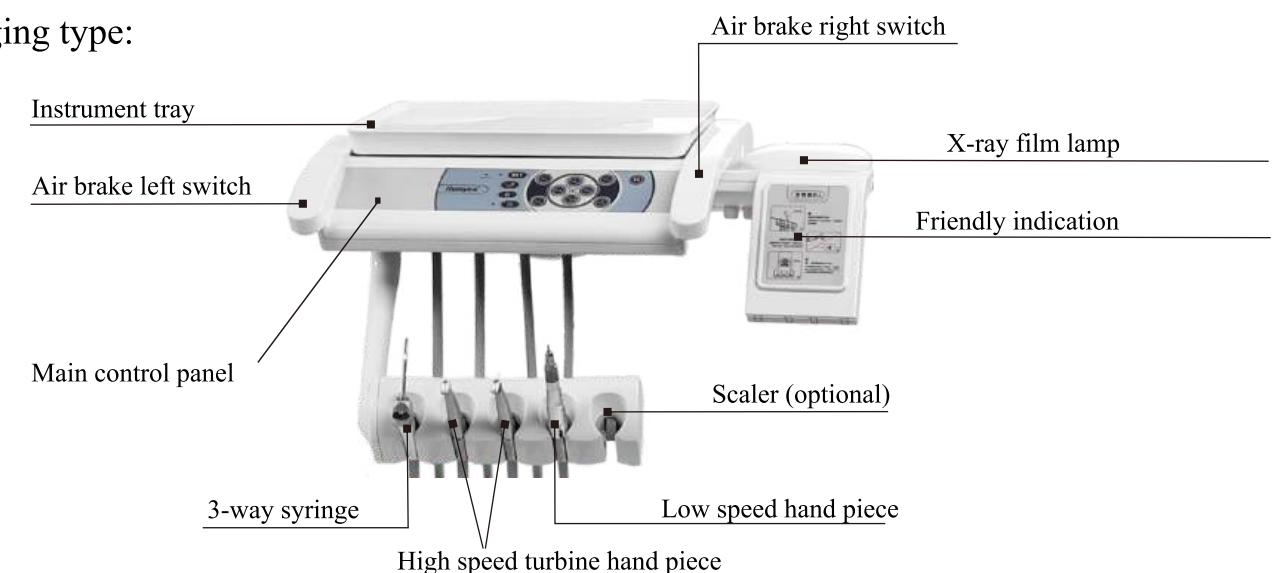

Note: care 11 series dental unit has the same working principle and operation method.

8.4.1 Instrument tray

1. The main function is to place the drug and instruments needed by treatment.
2. The load ability of apparatus tray is lower than 1KG.

8.4.2 Orbicular manometer

1. The main function is to show the air pressure of high or low speed hand piece.
2. The working air pressure of high-speed turbine hand piece is 0.22Mpa~0.25Mpa, the regulation switch is on the air pressure regulation valve under the instruments tray.
3. The working air pressure of low-speed motor hand piece is 0.3Mpa~0.32Mpa, the regulation switch is on the air pressure regulation valve under the apparatus tray.

8.4.3 Air Brake left (right) Switch

1. The main function is to control the up and down of the mechanical arm.
2. Press the air brake left (right) switch button with hand, adjust the instrument arm (instrument tray) to height, then release air break button.

8.4.4 Adjustable value for Air

1. The main function is to regulate the input air pressure of the high or low speed hand piece.
2. Clockwise rotation of regulation knob is to decrease pressure and anticlockwise reverse. Regulate slowly and notice the number of the rectangular manometer.

8.4.5 Adjustable value for Water

1. The main function is to regulate the input water flux of the high or low speed hand piece.
2. Clockwise rotation of regulation knob is to decrease flux and anticlockwise reverse. Regulate slowly and notice the drainage state of the turbine hand piece.

8.4.6 Main Control Panel

1. The main function is to control various kinds of functions of Dental chair and unit.
2. About operation mode, please refer to “main (Assistant) control panel” at 20 page.

8.4.7 X ray Film Viewer

1. The main function is to show part of X-ray film.
2. Open up Viewer shell, and light is on; vice versa.

8.4.8 Three-way syringe

1. The main function is to swash and air-dry the part of treatment position.
2. About the operation mode, please refer to “three-way syringe Debugging” at 27 page.

8.4.9 High Speed Turbine Hand piece

1. The main function is for treatment and operation.
2. About the operation mode, please refer to “High Speed Turbine Hand piece Debugging” at 13 page and the requirements of use specification.

8.4.10 High Speed Turbin Hand piece “Blowing” Function

“Blowing” function interpretation:

In order to be convenient for the users to clean the working zone after using the equipment.

After the High-speed gas turbine hand-pieces stop working, user need to press the “blowing” button by feet, the hand-pieces will burst gas from its pipe. So you don't need to exchange the three-ways syringe (this function can only used for two High-speed gas turbine hand-pieces).

8.4.11 Low Speed Motor Hand Piece

1. The main function is for treatment and operation.
2. About the operation mode, please refer to “Low Speed Turbine Hand piece Debugging” and the requirements of use specification.

8.4.12 Ultrasonic scaler (Option)

1. The main function is for scaling the teeth.
2. About operation mode please refer to the operation manual of ultrasonic scaler.

8.4.13 Key operation and setting instructions
 **Set key :**

1. The set key is the general control switch for all the functional keys
2. When start-up the setting key, its LED indicator light(green)flashes and buzzer has sound.
3. The dental unit has the following functional keys: Mouth Wash Key、 Rinse Basin Water Key、 Memory Chair Position Key1,2,3.

 **Rinse Basin Water Key**

1. Its main function is to control the time of rinse basin water valve on the side box.
2. Rinse basin water timing setting as following:
 - 2.1 Press the setting key for 2 seconds, the buzzer sounds “DI”, and at the same time the setting indicator light turns on, which indicates to enter the normal setting status.
 - 2.2 Set the rinse time by the times of pressing the key, and the buzzer has the sound indication:
 - 2.2.1 Press the rinse key and buzzer sounds one time “DU”, the setting indicator light flashes once at the same time, namely indicates the rinse is 30 minutes and then stop automatically.
 - 2.2.2 Press the rinse key twice and buzzer sounds two times “DU”, the setting indicator light flashes twice at the same time, namely indicates the rinse is 60 minutes and then stop automatically.
 - 2.2.3 Press the rinse key three times and buzzer sounds three times “DU”, the setting indicator light flashes three times at the same time, namely indicates the rinse will not stop automatically (namely works all the time).
 - 2.2.4 Press the rinse key four times and buzzer sounds four times “DU”, the setting indicator light flashes four times at the same time, namely indicates the rinse will stop automatically 12 seconds later (the function is only for examination).
 - 2.3 Press the setting key after finishing the setup, the buzzer sounds “DU-DU” and the indicator light turns off, which indicates the rinse timing has been stored and exit the normal setting at the same time.

Mouth Wash Heating Key:

1. The key is for the on-off action of heater.
2. While water is heating, the heating indicator light is flickering.
3. The key can control the on and off of the water temperature, and the water temperature can be adjusted between 30°~45°.
4. User can select the heated temperature by himself. Detailed operation, please see the instrument on the side box.

Attention: It is forbidden to heat without water.

Mouth Wash key:

1. Its main function is to control the time of mouth wash valve on the side box.
2. The water supply timing setting as following:
 - 2.1 Press the setting key for 2 seconds and the buzzer sounds “DI”, and at the same time the setting indicator light turns on, indicates to enter the normal setting status.
 - 2.2 Continuously press the mouth wash key, the mouth wash indicator light turns on and mouth wash flows out, when the water of the cup reaches the user's demand, release the mouth wash key, and mouth wash stops.
 - 2.3 Press the setting key again, the buzzer sounds “DI- DI”, and the setting indicator light turns off at the same time and indicates the water has been stored, exit the normal setting at the same time. There are buttons of mouth wash on the main and auxiliary control panels and foot switch.
3. There are rinse solution key in the main board panel, assistant console panel and foot control.

User Memory Chair Position Setting Key 1、2、3 Specification

1. This series Dental unit has three memory chair position for users. After user setting the limit position, and the three user memory chair positions will have their default positions.
2. The operation as following:
 - 2.1 The setting of the three user memory chair position is the same without priority order.
 - 2.2 Please set the dental chair to the ideal position.
 - 2.3 Press the setting key for 2 seconds, then the buzzer sounds “DI” and the setting indicator light turns on at the same time, indicates that the chair enters the normal setting status.
 - 2.4 Press the user memory chair position key (such as S2 key), the buzzer sounds “DI”, indicates that the position is chose.;
 - 2.5 Press the setting key again, the buzzer sounds “DI-DI” and the setting key indicator light automatically turns off at the same time, indicates that the position is stored and exit the normal setting.

Attention: During the operation course, only need to press any key on the control panel, namely stop the operation.

Reset Key:

1. After treatment, just press the reset key, the dental chair will be back to the original position.
2. Start up the key, the chair will drop to the lowest position, the backrest forward to the extreme limit position.
3. The reset key has been set before leaving factory, and user needn't set up.
4. The reset key has buttons on the main and auxiliary control panel.

Attention: During the operation, only need to press any key on the control panel, namely stop the operation.

Mouth Wash Position:

1. During the treatment, when the patient needs to gargle (or spit), just press the key and the backrest will forward to the extreme limit position, which is convenient for spitting.
 2. After the sufferer gargle (or spit) and press the key again, the backrest will be back to previous position.
 3. Spit position key is to follow the last position of backrest automatically and the user needn't set up.
 4. The spit position key has button on the main and auxiliary control panel of treatment machine.
- Attention: During the operation course, only need to press any key on the control panel, namely stop the operation.**

Backrest Forward Key :

1. Press this key and then the backrest will move forward.
2. Reaching the needed position, release the key, then the backrest will stop moving at once (if press the key all along, the backrest will automatically stop after reaching the limit position).
3. Backrest forward key has buttons on the main and auxiliary control panel and foot control switch.

Backrest Backward Key :

1. Press this key and then the backrest will move backward.
2. Reaching the needed position, release the key, then the backrest will stop moving at once (if press the key all along, the backrest will automatically stop after reaching the limit position).
3. Backrest backward key has buttons on the main and auxiliary control panel and foot control switch.

Dental Chair Up Movement Key:

1. Press this key and then the chair will go up.
2. Reaching the needed position, release the key, then the chair will stop at once (if press the key all along, the chair will automatically stop after reaching the limit position).
3. Dentistry chair rise key has buttons on the main and auxiliary control panel and foot control switch.

Dental Chair Down Movement Key:

1. Press this key and then the chair will go down.
2. Reaching the needed position, release the key, then the chair will stop at once (if press the key all along, the chair will automatically stop after reaching the limit position).
3. Dental chair drop key has buttons on the main and auxiliary control panel and foot control switch.

Light on/off button

1. This button is used to control the on/off state of the lamp.
2. This button exists on assistant table sticker and lamp sticker.

8.4.14 Universal Key Setting (CARE 33)

The top left key 0 and the top right key R on the foot pedal of the unit are the universal keys, which can be set to any button except the SET button on the main control board. The setting method is as follows:

- 1> Press the SET button for 2s, and you will hear a “Di” sound, and the SET indicator will light up and enter the normal setting state.
- 2> Click the universal key you want to set (such as the top left key 0) to enter the state to set the top left universal key.
- 3> Press the corresponding button of the function you want on the main control board (except the SET button. If you press the SET button, it will end the normal setting state. At this time, the top left universal key 0 is set to the oral lamp switch function. Same as the top right universal key R), exits the top left universal key setting state and the universal key setting is automatically saved.
- 4> Follow step 2 and 3 to set the top right universal key R
- 5> Press the SET button to exit the normal setting state

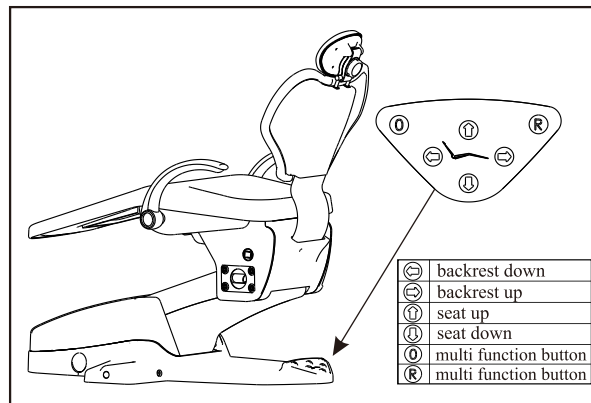

8.5 Foot Switch

This Series are now equipped with 2 types of foot switch. We provide other types for selecting, too. We. will inform user immediately if we modify something..



NO.: F1



NO.: F2



NO.: F5

8.5.1 “F1” Foot Switch Instruction

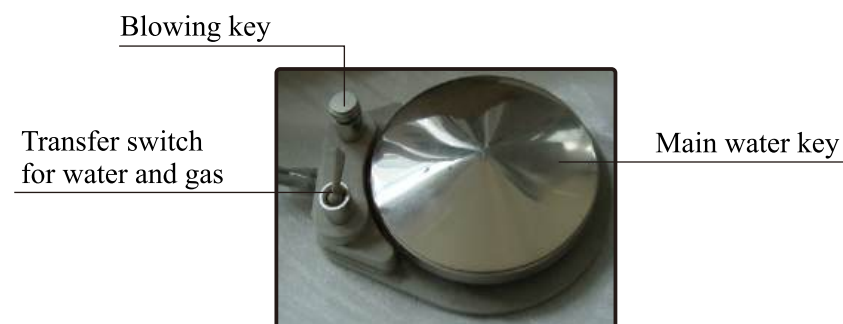

8.5.2 “F2” Foot Switch Instruction

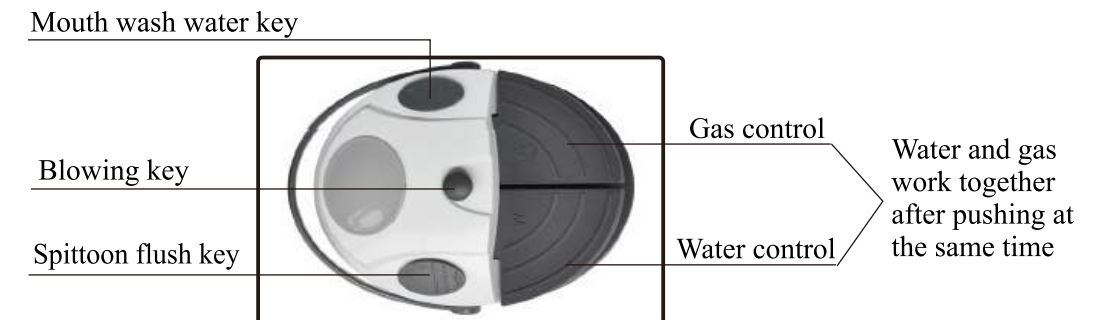

8.5.3 “F5” Foot Switch Instruction

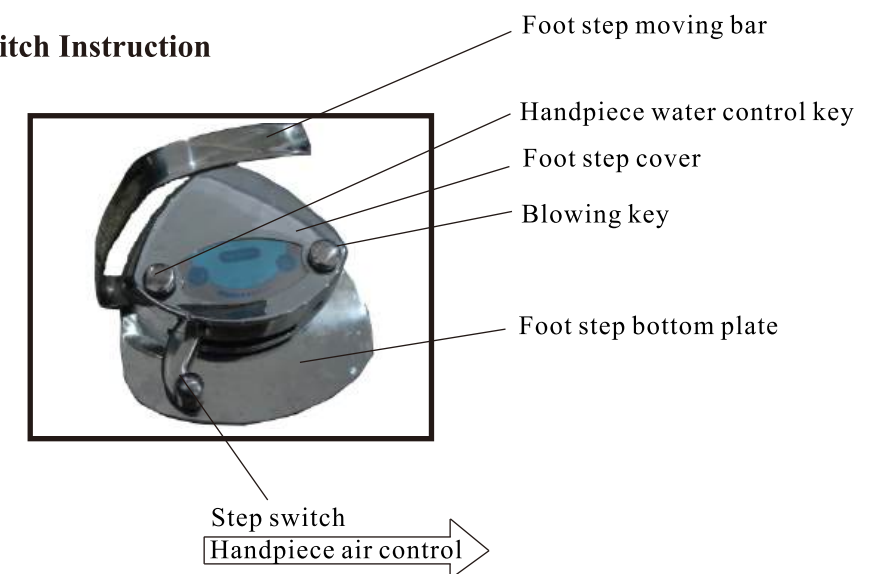

8.6 Oral Lamp

At present, different models are equipped with different styles of oral lamps. Clients can also choose different styles of oral lamps according to their needs.



Halogen Lamp



LED Lamp



DCI LED Lamp

8.6.1 Halogen Lamp

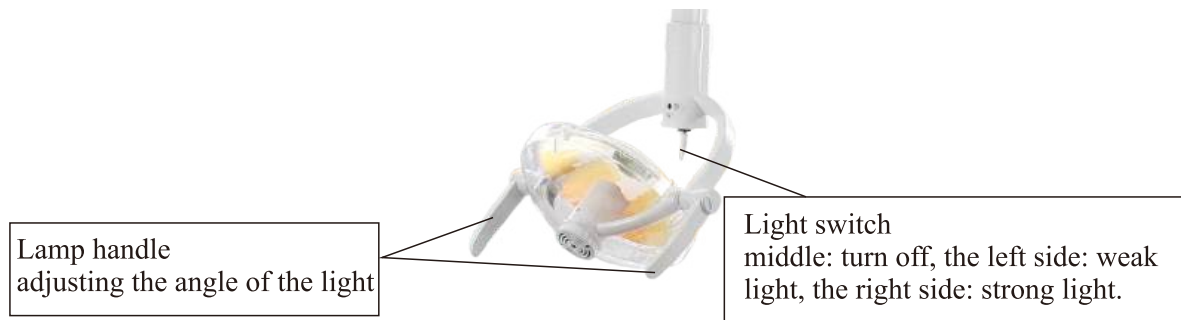

8.6.2 LED Lamp

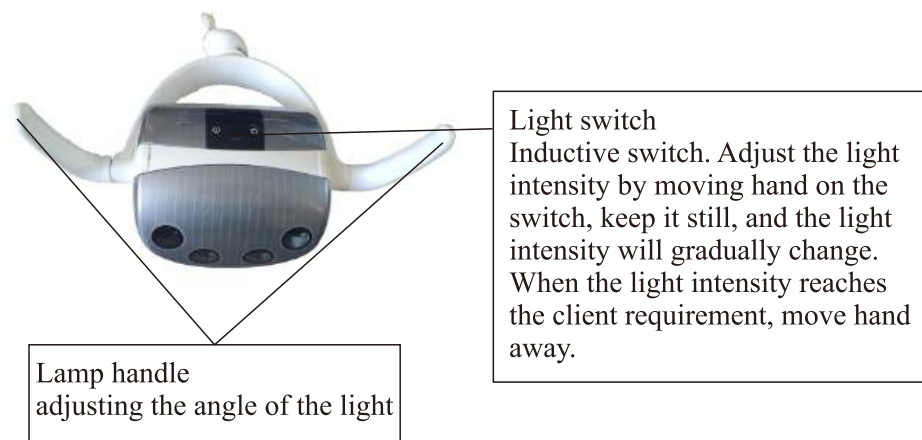

8.6.3 DCI LED Lamp

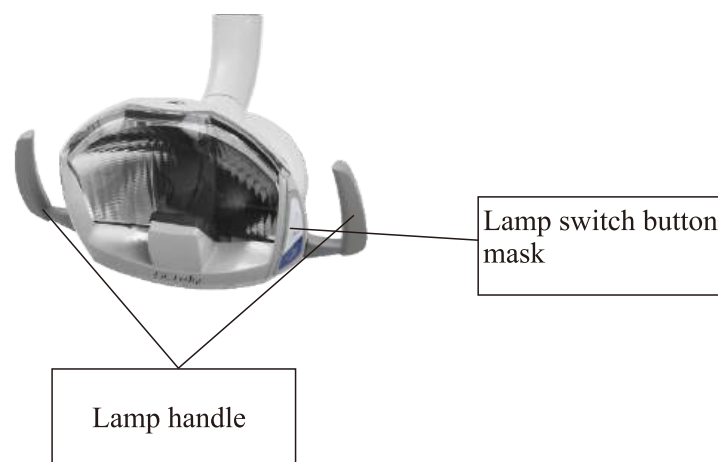

8.6.3.1 Lamp button standard operation

Switch:
Used to control the opening and closing of LED lamp

Illuminance:
For switching between high/medium/low illumination

Blue light cut-off function:
Used to switch between blue light cut-off mode and normal mode

The button mask of the lamp is located on both sides of the lamp head. Once the lamp holder is grasped, it is convenient to operate the button.

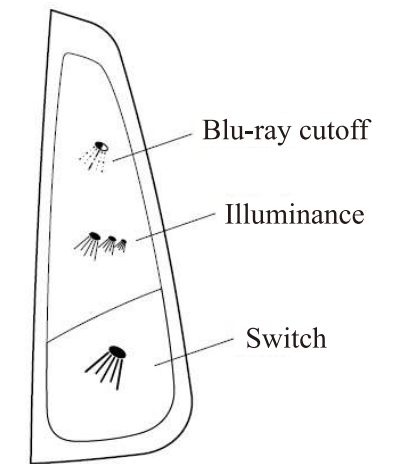

Lamp switch right button mask (Located on the right side of the lamp)

8.6.3.2 Infrared sensor

The DCI lamp head is equipped with 2 editable infrared sensors, the right sensor is factory set to illuminance function, and the left sensor is set to blue light cut-off function.

Operate the sensor by hand waving about 2 inches in front of the sensor (the hand should not be placed at the intersection of 2 sensors)

Note: Sunlight and direct light may activate or passivate the sensor. If this happens due to direct sunlight, keep it black or turn off the sensor.

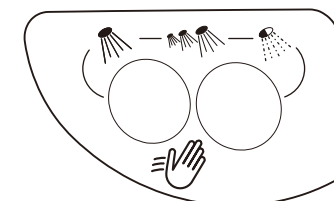

Left sensor (located at the bottom of the lamp head)

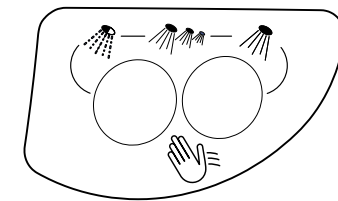

Right sensor (located at the bottom of the lamp head)

8.6.3.3 Editing infrared sensor function

- 1> Sensor can be edited as the function of any other light button
- (1) Make sure the lamp is off
 - (2) In order to assign a function to the right infrared sensor: press and hold a button on the lamp operation panel for 5 seconds to set the function to the infrared sensor.
 - (3) Repeat the above steps for the left sensor to assign a new function.
- 2> Revoking sensor function editing
- (1) Make sure the lamp is off
 - (2) In order to disable the function in the right infrared sensor, press and hold the blue light cut-off and illumination button for 5 seconds at the same time.
 - (3) If the left sensor function needs to be disabled, repeat the operation on the left side. To restore the previous function in the sensor, repeat the above steps or follow the steps to edit a new function.

9. Device debugging

9.1 Power supply inspection

- 1> Power source inspection:
The integrated dental equipment is made on/off by the power switch.
Insert the socket and press the power supply switch on the base box. If the power indication lamp turns green, it means that the power is normal.
- 2> Water supply inspection:
Turn on the water switch and take up the three-way syringe on the assistant support of side box.
Press spraying switch, when water is spurted, it means water supply is normal.
- 3> Water distiller:
In order to ensure the normal usage of the machine, there is a water inlet distiller. Generally, when using more than half a month or the water outlet is not clear, please clean or change a filter cartridge in the water filter. The way of changing, please see the "Trouble shooting" on page 30.
- 4> Air supply inspection:
1. Turn on switch for air and check manometer on the side of the apparatus tray, its value should be 0.55MPa (It has been adjusted before leaving factory)
 2. If the air pressure is too big or small, then air pressure of air filter decompression valve must be modified to the demanded value. The process is as follows:
 - 2.1 Open the base box cover, pull up the knob on the top of the air filter decompression valve first, then rotate the knob, clockwise rotation is pressure to increase and anticlockwise reverse.
 - 2.2 After adjusting the air pressure, press down the knob on the top of the air filter decompression valve.
 3. Take up the three-way syringe on the assistant support of side box and turn on the whiffing switch, when air is whiffing, namely gas supply is normal.

9.2 Debug High Speed Turbine Hand Piece

1. Take down the hand piece connector from the rack and step on the food control switch to discharge the water and air in the pipeline.
2. Then connect the high speed turbine hand piece, debug according to the usage specification.
3. The working pressure of the high-speed turbine hand piece is 0.22MPa~0.25MPa.
(Refer to the rectangular manometer on the side of the apparatus tray).
4. If you want to adjust the working pressure of the high-speed turbine hand piece, please adjust the air control regulation valve under the front of apparatus tray, clockwise rotation is pressure to decrease and anticlockwise reverse. Be careful to adjust.

Attention: Please do not start up by over-pressure or operate the high-speed turbine hand piece by unloading, or it will shorten the service life.

9.3 Debug Low Speed Motor Hand Piece

1. Take down the hand piece connector on the rack and step on the food control switch to discharge the water and air in the pipeline.
2. Then connect the low speed motor hand piece, debug according to the usage specification.
3. The working pressure of the low-speed motor hand piece is 0.3MPa~0.35MPa.
(Refer to the rectangular manometer on the side of the apparatus tray).
4. If you want to adjust the working pressure of the low-speed motor hand piece, please adjust the air control regulation valve under the front of apparatus tray, clockwise rotation is pressure to decrease and anticlockwise reverse. Be careful to adjust.

Attention: Please do not start up by over-pressure or operate the low-speed motor hand piece by unloading, or it will shorten the service life.

9.4 Debug three-way syringe

1. The left button of three-way syringe is for water and the right button is for air.
2. When press the water or the air button respectively, should distinguish the water and air, which are alike with the shape graph of button.
3. When press two buttons at the same time, the gusher will be fog state.
4. If hot water or hot fog is need, you can press the heating button.

9.5 Debug Dental lamp

1. Turn on the switch of Oral lamp, and observe whether light switch on the strong and weak position is normal.
2. Face to the oral lamp and turn on the switch by the left for weak light and strong by the right.

9.6 Debug Dental Chair

1. The dental chair has three functions--rise, drop, and control gradient, which locate on the control panel of apparatus tray, the auxiliary control panel on the assistant support of side box and the orbicular control switch for the feet control. About control mode, please refer to "Parts Operation" at page 12
2. During the operation, the chair will stop if you press any key.
3. The chair has the safe protection for falling. If touch the obstacle object during the falling course, it shall stop falling and rise back for the some distances automatically to avoid accidents.

Attention: Because the movable function, when the dental chair move up and move down, make sure that dental unit will not touch other objects within the movable range to avoid accident.

9.7 The preparation before operating the sentel unit.

Before operation the dentist need to switch on the air source switch, then lay down the arm rest and lower the chair to the lowest point for patient's convenience to sit on and off.

9.8 CARE 11 Side box horizontal adjustment

Adjustment method

- 1>Check the tilt direction of the side box
- 2> Loosen 6 set screws properly
- 3>Put the side box to the horizontal position
- 4>Tighten the 6 set screws

A total of 6 inner hexagonal flat-end set screws are used to adjust the level of the side box

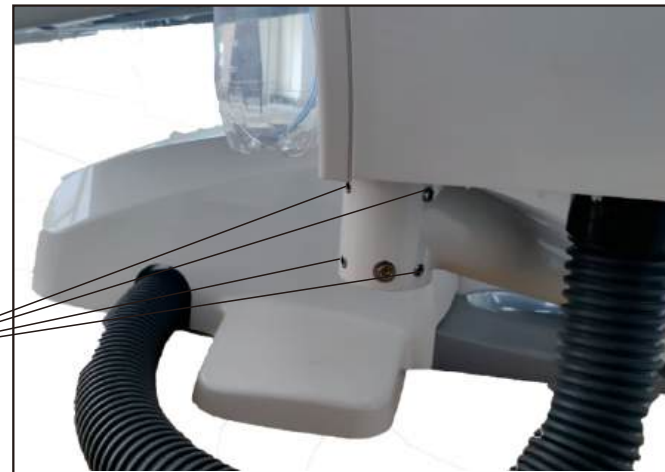

9.9 CARE 22&33 side box horizontal adjustment

1 > Properly loosen the 3 inner hexagonal cylindrical screws

2 > Twist these 3 inner hexagonal flat-end set screws to adjust the side box to the horizontal level

3 > Retighten the loosened screw in step 1



9.10 Side box water storage bottle air pressure adjustment

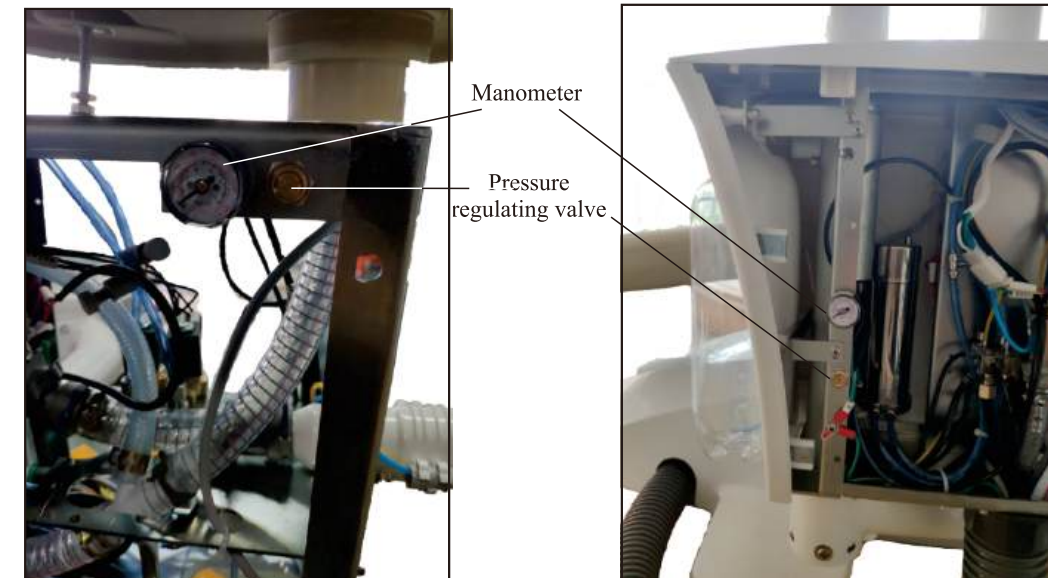

Open the side box cover, find the pressure regulator to adjust the air pressure inside the water storage bottle, the value of the pressure gauge on the side shows the current pressure in the bottle (recommended pressure is 0.2mpa)

9.11 CARE 11 balance arm force adjustment

If the balance arm force is too large or too small during use, it can be adjusted by user. The adjustment method is:

- 1>Remove the balance arm trim cover
- 2>Press the balance arm to the lowest point
- 3>Insert the Allen key into the adjustable screw as shown on the right.
- 4>Adjust clockwise to increase the force, counterclockwise to decrease the force

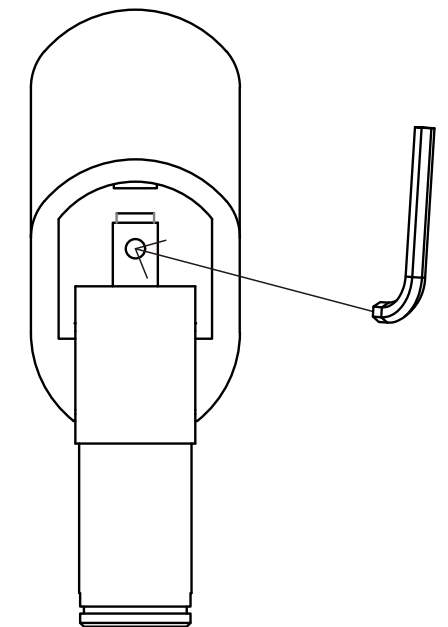

9.12 CARE 22&33 balance arm force adjustment

If the balance arm force is too large or too small during use, it can be adjusted by user. The adjustment method is:

- 1>Remove the balance arm upper cover
- 2>Press the balance arm to the lowest point
- 3>Rotate the adjustable nut to adjust the balance arm force

Adjusting nut

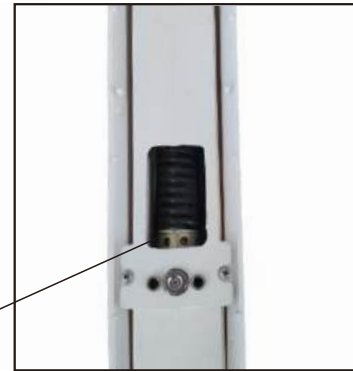

9.13 CARE 11 balance arm horizontal adjustment

If the instrument tray is too tilted during use, it can be adjusted by user. The adjustment method is:

- 1>Remove the balance arm trim cover and then press the balance arm to the lowest point
- 2>Loosen the adjustable screw in the angle A and the angle B shown in the picture
- 3>Adjust the instrument tray to a horizontal position
- 4>Tighten the loose adjustable screw

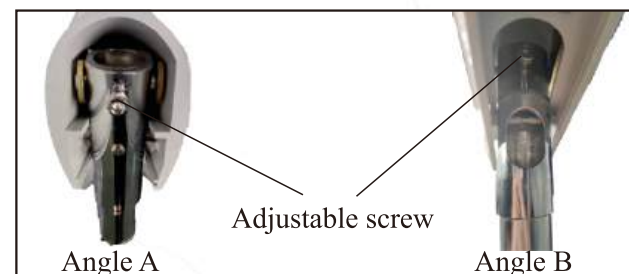
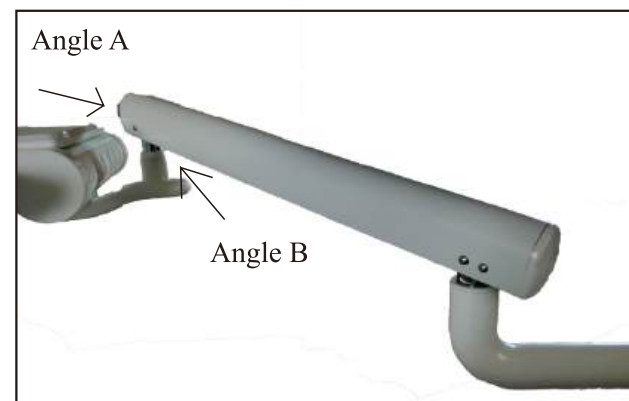

Adjustable screw

Angle A

Angle B

9.14 CARE 22&33 balance arm horizontal adjustment

If the instrument tray is too tilted during use, it can be adjusted by user. The adjustment method is:

- 1>Remove the balance arm upper cover
- 2> Remove the set screw on the outside of the adjustable block of the instrument tray
- 3> Insert the Allen key into the instrument tray adjustable block
- 4>Rotate the Allen key to adjust the instrument tray to the horizontal level

Adjustable Plate

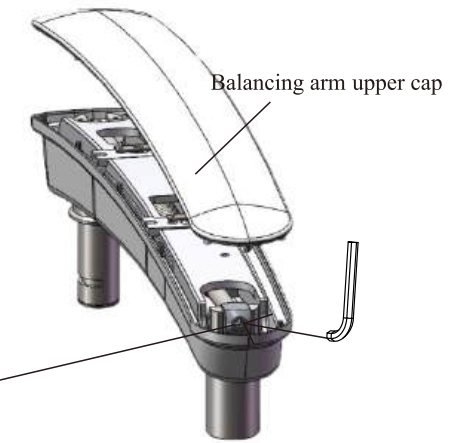

Balancing arm upper cap

9.15 Lamp arm force adjustment

The force of the lamp arm will be adjusted to the appropriate level at the factory. During the use, there may be cases where the arm strength is not enough and need to be fine-tuned. The adjustment method is as follows:

- 1>Remove the trim cover on the lamp arm
- 2>Rotate the adjustable nut to adjust the force to an appropriate level.
- 3>Put back the trim cover

Adjustable Nut



9.16 Adjustment of the hanger

If the down-mounted unit hanger rotation is too flexible during use, the hex set screw can be tightened. If the hanger is difficult to be rotated, loosen the screw.



10. Precaution

- ⚠ Danger: The power supply must be connected with reliable grounding line.
- ⚠ Warning: Must cut off the power supply when repair, maintain or clean the dental unit.
- ⚠ Attention: Please cut off the water, electricity and gas supply when you leave office.
- ⚠ To avoid risk of electric shock, this equipment must only be connected to a supply mains with protective earth
- ⚠ During the operation by the dentist, please don't do any maintenance/repair to the dental unit.off (see picture 9).

1. During the operation, make sure there is no object existing within the operation scope needed by dental unit.
2. Discharge the water in the air filter decompression valve in time.
3. Clean or replace the water filter core in time.
4. Do not adjust the working pressure of the turbine hand piece too high, or it will shorten the service life.
5. Do not start up the turbine hand piece without pill, or it will shorten the service life seriously.
6. After adjust the position of the pillow rack, must ensure the pillow rack is locked before using..
7. There is reflecting plating film on the reflecting piece of cold light lamp, please do not use the coarse things to clean and reduce the cleaning times as much as possible.
8. The temperature is very high when oral lamp is using, please do not touch it by hand.
9. When replace the bulb of oral lamp, do not touch the new bulb by hand directly as the grease on the hand may cause the lamp burst during the use course.
10. It is forbidden to turn on the mouth wash heating without water.
11. Do not pile up too heavy objects on the instrument tray.
12. Please set the dental chair to the normal position after work
13. Try to keep clean, dry working environment to pretend the service life of equipments.
14. The max. load of armrest is 20KG. Please do not over the weight in order to avoid damaging it.
15. The pictures in this manual are for reference only and the actual ones shall prevail.
16. No contraindications.
17. Please do not run the device without supervision.

11. Trouble Shooting

11.1 The whole equipment has no electricity

Warning: If change the fuse and power cable. it will cause the change to the equipment; so they should be replaced by the professional personnel appointed by the manufacturer .

Reason analysis

1. The power supply switch is off.
2. The circuit fuse is broken.



Trouble shooting

1. Turn on the power supply switch.
2. Replace the fuse, the process is as following:
(The fuse lies in the ground box) :
 - 2.1 Cut off the power supply
 - 2.2 Twist the tube seat of fuse counter-clockwise and take the fuse out.
 - 2.3 Replace the new fuse according to the related standard.mentioned in chapter 5; then tighten it by clockwise direction.
3. How to change the main power cable.
 - 3.1 Cut off the electricity
 - 3.2 Unscrew the tension disc by the cross screwdriver Loosen the main power cable.connector and take off the main power cable.
 - 3.3 Insert the new main power cable into the connector and tighten the screw, then make it through the tension disc and tighten the screw.

11.2 The dental unit has no air or air pressure is not enough

Reason analysis

1. The air supply is off.
2. The water is congregated too much in the filtration cup of air filter decompression valve.
3. Water and gas valve is off.
4. Need to drain for the air filter decompression valve if the following situations happen:
 - 4.1 The use time is more than one week.
 - 4.2 The water occupies three quarter cubage in the filtration cup.
 - 4.3 The water changes color (not clarity water) in the filtration cup.

Trouble shooting

1. Turn on the air supply.
2. The drainage process of the air filter decompression valve is as following:
(The air filter decompression valve lies in the ground box.) :
 - 2.1 Cut off the power supply.
 - 2.2 Open the ground box cover, contact the drainage valve core upwards forcibly by hand or hard objects on the bottom of decompression valve, namely drain off the water, release after water drainage is over.
 - 2.3 To keep the clean environment, put such absorbing things as cloth, tissue, sponge, etc. on the water exit.



11.3 The dental unit has no water or water pressure is not enough

Reason analysis

1. The water supply is off.
2. The impurity may block the filter core.
3. Water and gas valve is off.
4. Must clean or replace the filter core if one of the following situations happens:
 - 4.1 The use time is more than one year.
 - 4.2 Pressure loss of the filter core is 0.1Mpa.
 - 4.3 Filtering water is polluted.
 - 4.4 Water output was turbid.



Trouble shooting

1. Open the water supply switch.
2. The process to clean or replace the filter core is as following:
 - 2.1 The water filter lies in the ground box.
 - 2.2 Cut off the power and water supply.
 - 2.3 Open the ground box cover and twist the down part of water filter counter-clockwise.
 - 2.4 Twist the screw that is in the middle part of filter to fix the filter core, namely remove the filter core for cleaning or replacing.
 - 2.5 After that, install the water filter well.

Attention: While installing the filter core, must not overexert in case to crush the core. Pay attention to install water filter cover and keep airproof.

11.4 Oral Lamp is off

Reason analysis

1. The power supply is off.
2. The bulb is off.

Trouble shooting

1. Turn on the power supply switch.
2. Replace the bulb (AC12V/55W) and the process is as following:
 - 2.1 Cut off the power supply.
 - 2.2 Open the fore cover of the cold light lamp.
 - 2.3 Twist the protection cover of the bulb down.
 - 2.4 Take the old bulb down and replace a new one.
 - 2.5 Install the protection cover and fore cover according to the abovementioned steps.

Attention! Be careful of hotness! The bulb must not be replaced until the cold light lamp cools down.

**11.5 Oral Lamp does not focalize**

Reason analysis

1. The focal-length is not suitable.
2. The focal-length is unsuitable after replace the new bulb.

Trouble shooting

Adjust the screw behind the cold light lamp by the hexagon wrench to the suitable position.

**11.6 Film viewer is off**

Reason analysis

1. The power supply is off.
2. The bulb is off.

Trouble shooting

1. Turn on the power switch.
2. Replace the bulb (supply by the manufacturer or supplier, and the process is as following:
 - 2.1 Cut off the power supply.
 - 2.2 Open the face cover of apparatus tray.
 - 2.3 Take U type energy-save lamp out and replace a new one.
 - 2.4 Check whether the lamp is plugged in firmly, install according to the original shape.

Attention: Must cut off power supply when replacing film reading lamp.

**11.8 The suction of weak suction is not enough**

Reason analysis

1. Aspirator pipeline is blocked.
2. Water pressure is too low.

Trouble shooting

1. Clean the aspirator pipeline and eliminate the impurity.
2. Check the filter core, clean or replace the filter core.
3. Turn on the switch regulation valve of the weak aspirator under the side-box, the power source of the aspirator will switch to compressor air source.

11.9 The drain of rinse basin is not smooth

Reason analysis

1. Drain pipeline is blocked.
2. Plastic tube is crooked.

Trouble shooting

1. Clean the drain pipeline and eliminate the impurity.
2. Replace a new drain tube.

11.10 The rotation speed of high speed turbine hand piece is low and weak

Reason analysis

1. Air supply pressure of the hand piece is too low.
2. The bearing of hand piece is broken.

Trouble shooting

1. Adjust the air input pressure of the hand piece (working pressure is 0.22MPa~0.25MPa).
2. Replace the bearing according to the specification of the high speed turbine hand piece.

11.11 Low speed motor hand piece does not work or the rotation speed is too low

Reason analysis

1. Air supply pressure of the hand piece is too low.
2. The bottom timing and turning regulation loop position of low speed turbine hand piece is wrong.

Trouble shooting

1. Adjust the air input pressure of the hand piece (working pressure is 0.3MPa~0.32MPa).
2. Turn the regulation loop to get the suitable rotation speed and direction.

11.12 Hang rack switch can not control water and air supply

Reason analysis

If insert the hang rack, the hand piece, strong and weak aspirators can not control water and air supply, thus the phenomenon of water and air leak appears.

Trouble shooting

1. Disconnect the hang rack, and check whether the hang rack switch is damaged.
2. If damaged, need to replace the hang rack switch, and the replacing method is as following:
 - 2.1 Cut off the power supply.
 - 2.2 Loosen the installation screw and taken the rack out.
 - 2.3 Measure the both ends of hang rack switch by the multi-meter on the state of resistance $R \times 10$.
 - 2.4 Touch the free point of hang rack switch by hand, see whether it is able to connect and disconnect, if it is on the state of connecting and disconnecting for long time, means it is damaged, need to replace the hang rack switch at once.

11.13 Simple troubleshooting

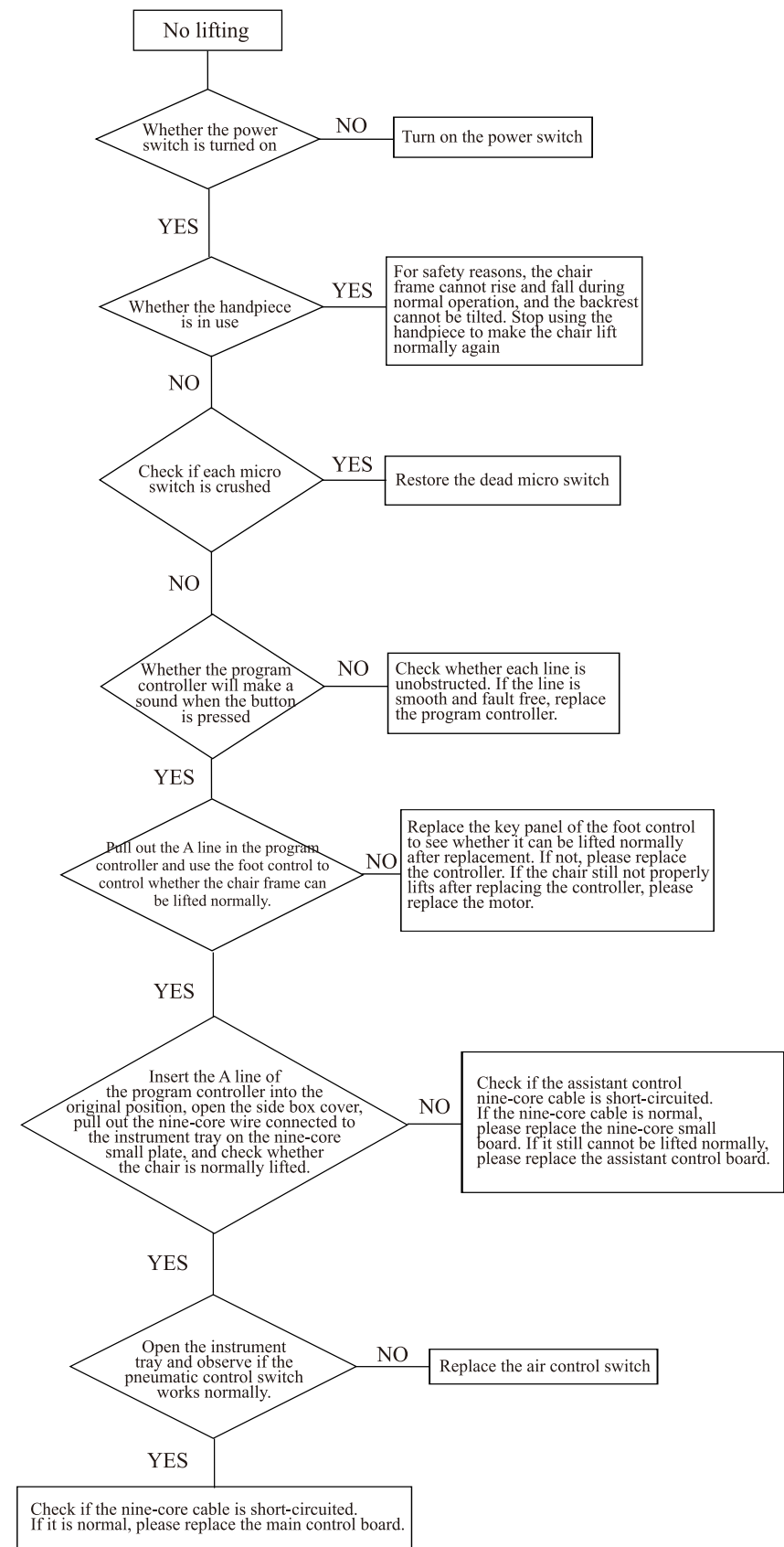
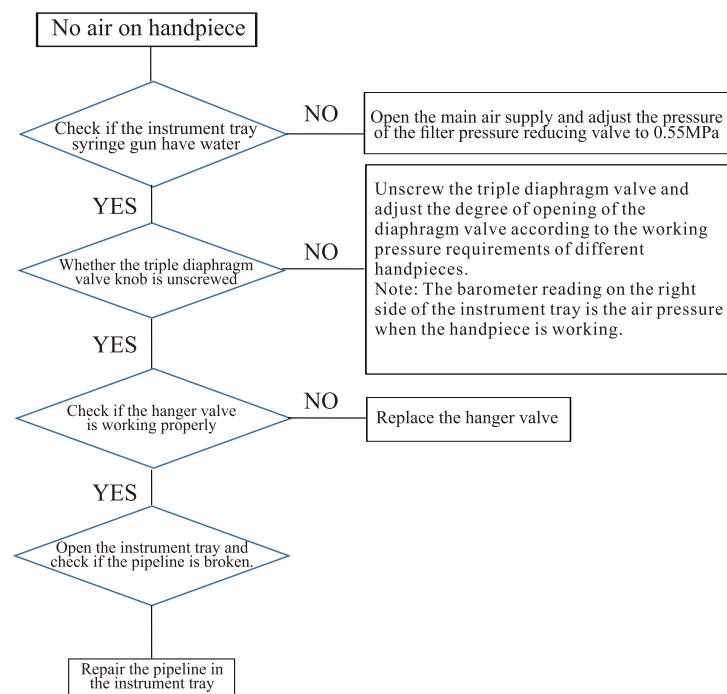
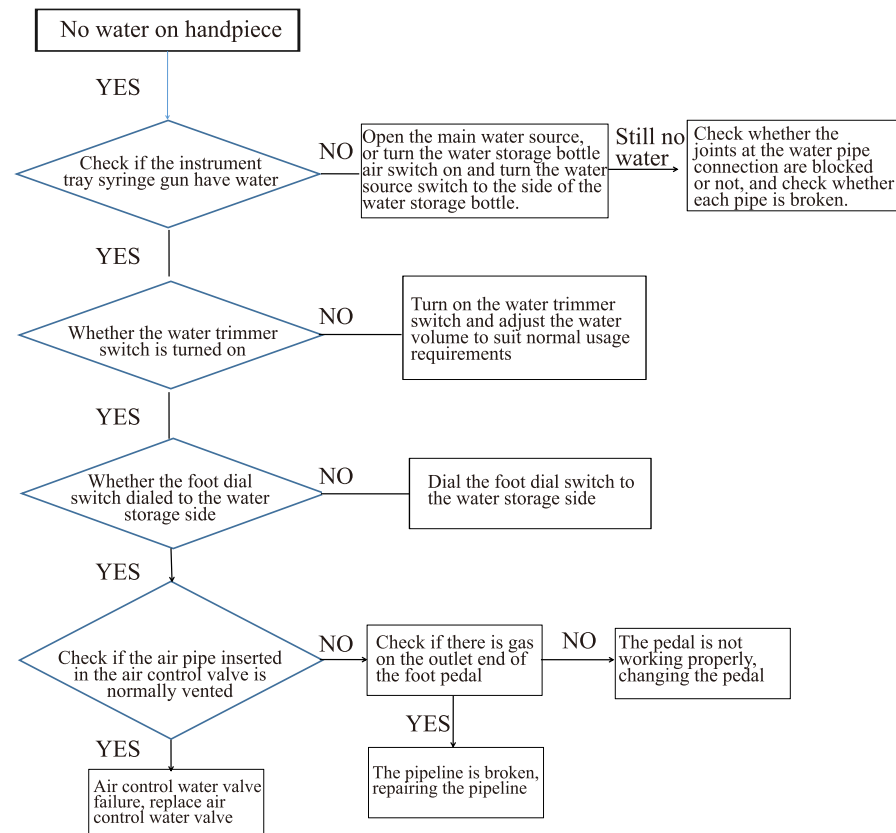

12. Maintenance

The regular maintenance for dentistry integrated treatment machine can reduce the failure, and keep your equipment in the good working state and pretend the service life.

12.1 Dental unit and dental chair maintenance

Clean the machine by the neuter wash every day, and notice whether the wash will cause damage to the surface of the machine.

Before the maintenance personnel repair the equipment, please ensure the equipment is power off.

The device can be cleaned with a mild detergent and warm water. Some medical disinfectants in the clinic can also clean the equipment, and some disinfectants may fade the surface of the machine after repeated use. Frequent cleaning with soapy water in accordance with the instructions in the instructions can reduce the probability of fading. Do not use powder cleaners, sponge scouring pads or abrasive scrubbers to clean any spray or plastic or metal surfaces. Use a soft hair brush and a mild detergent to clean the surface

12.2 Hand piece maintenance

1. Before and after the work every day, you should clean and lubricate the turbine hand piece by cleanser and lubricant of hand piece, to keep the inner of hand piece is clean and lubricated.
2. Do not use it without the pill.
3. Notice the working pressure of the hand piece frequently and ensure it works in rated pressure scope.
4. To avoid cross infection, the strict disinfection and sterilization of high temperature after the treatment and operation is necessary . The sterilization method is as following:
 - 4.1 Scrub the surface by brush and clean by alcohol for disinfection purpose.
 - 4.2 Clean and lubricate by the cleanser and lubricant of the hand piece.
 - 4.3 Pack by special disinfection bag of hang piece, and mark the time.
 - 4.4 Put it in high temperature and high pressure sterilizing utensil (sterilizing temperature is within 135 c°).

12.3 Three-way syringe maintenance

1. Scrub the surface by brush and clean by alcohol for disinfection purpose.
2. Pack by special disinfection bag, and mark the time.
3. Put it in high temperature and high pressure sterilizing utensil (sterilizing temperature is within 135 c°).

12.4 Oral Lamp maintenance

1. The lamp is maintained in the nunder nor mal tmperature under nor mal temperature,clean gently by the soft cloth.
2. Do not clean the lamp surface, can only blow the dust by the compressor air.

12.5 Strong (weak) suction maintenance

Should absorb some amount clear water after using each time, to guarantee the pipeline is smooth.

12.6 Ceramic basin drain tube maintenance

1. Clean the filter net of the ceramic basin once everyday.
2. Should pour a lot of clear water into the basin to wash everyday under nor mal temperature for avoiding the drain tube been blocked.

12.7 Air filter decompression valve maintenance

1. You should drain once every week.
2. Please refer to the operation of “The whole machine has no air or air pressure is not enough” at 26th page.

12.8 Water filter maintenance

1. Should drain once half or one year (clean or replace according to the water quality and use frequency of users).
2. Please refer to the operation of “The whole machine has no water or water pressure is not enough” at 26th page.

12.9 Disinfection of dental chair piping system

- 1> It is recommended to disinfect the piping system with the following disinfectant
 - 1> Peroxyacetic acid
 - 2> Glutaraldehyde
 - 3> Hydrogen peroxide
 - 4> Acetic acid
- 2> Fill the water storage bottle with diluted disinfectant
- 3> Put the water source switch to the side of the water storage bottle
- 4> Press the water button on the syringe to spray the diluted disinfectant. Take the handpiece from the hanger and step on the pedal to spray the diluted disinfectant. Repeat the previous procedure so that each line is sterilized with the diluted disinfectant for at least 10 minutes. If the disinfectant in the water storage bottle is used up, please replenish it.
- 5> Rinse the spittoon and drain with a diluted disinfectant.
- 6> Rinse for at least 10 minutes.
- 7> After disinfection is completed, repeat steps 4 and 5 with distilled or negative ion water.
- 8> The piping system should be disinfected at least once a week. It is recommended to disinfect once a day.

12.10 Chemical disinfection

In addition to using chemical disinfectants, wash the equipment with soapy water (with warm water) at least once a day. This cleaning reduces chemical disinfectant residues and reduces the effects of damage. Pay attention to the disinfection instructions provided by the manufacturer each time you use a chemical disinfectant. When using centralized disinfection, check the mixing ratio according to the label instructions. The recommended concentration on the machine surface will not cause damage to the machine surface. If the concentration is higher than the recommended value, this will affect the surface of the equipment.

12.11 Ordinary cleaning

Use a 10% soap solution with warm water and wipe the PU surface with a soft cloth and rinse with water and dry. The cleaning frequency is determined according to the number of uses. It is recommended to clean the PU surface between different patients.

Stains

Use a detergent cleaner such as Formular 409 or Fantastik. Wipe with a soft cloth or a brush. Rinse with clean water and dry.

Other intractable stains

Carefully wipe the stained area with a lighter oil (naphtha) or with alcohol, gently wipe the surface with a soft cloth, rinse with water and dry.

Other opinions

Wipe with a soft cloth to avoid wiping with a paper towel. When using a strong cleaning agent such as alcohol, it is recommended to wipe first in an inconspicuous place. Do not use hard solvents for industrial use. In order to restore luster, furniture spray wax can be used. As for the dental chair, allow to stand for 30 seconds and wipe with a clean cloth.

Acceptable disinfectant:Duodenal/
quaternary ammonium/glutaraldehyde



Note: These disinfectants can damage the surface of the equipment. The following disinfectants are not recommended:
Strong phenol/phenolic mixture/Sodium hypochlorite / household bleach/Sodium bromide/High concentration alcohol
Household cleaners (for dental equipment only)
Citric acid
Iodophor
Sodium chloride
Hydrogen (0.5%)

13. Circuit Diagram

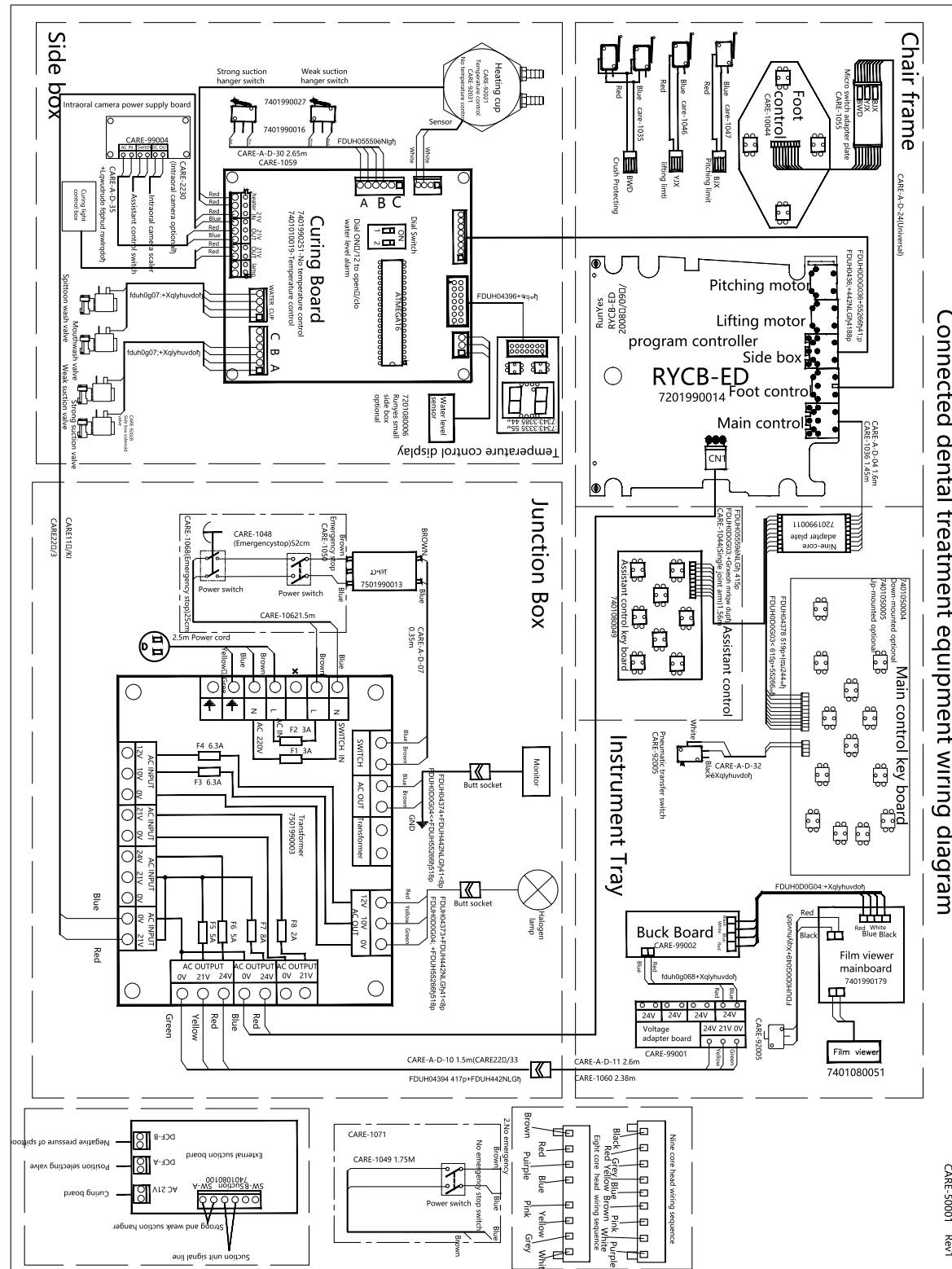

14. Water/Air pipeline diagram

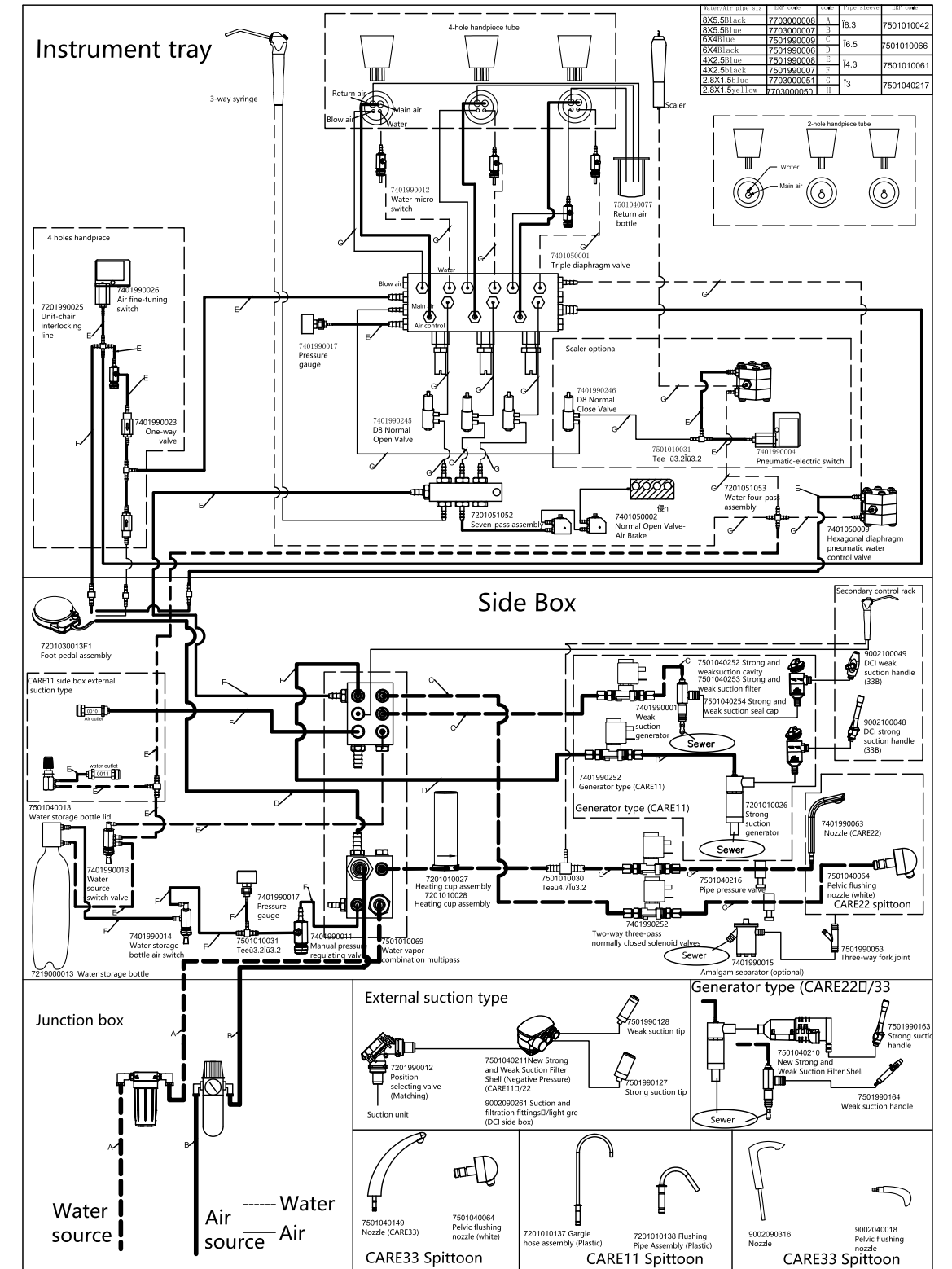

15. Transportation and storage

- 1> Transportation requirements are as specified in the order contract. Avoid violent collisions and rain and snow during transportation.
- 2> The packaged dental unit should be stored in a room with a relative humidity of no more than 93%, no corrosive gas and good ventilation.
- 3> Ambient temperature range: -40 to +55 degrees Celsius;
- 4> Relative humidity range: $\leq 95\%$;
- 5> Atmospheric pressure range: 550hpa ~ 1060hpa;
- 6> Avoid direct sunlight when storing
- 7> Waste, residue, and the product itself. Dispose of equipment that has been scrapped after the service life. Dispose of in accordance with local laws and regulations.

16. Electromagnetic compatibility



note:
(Care-11U, Care-11D, Care-22U, Care-22D, Care-33U, Care33D integral dental unit) meet the YY0505-2012 standard electromagnetic compatibility requirements.

Users should install and use the electromagnetic compatibility information provided in the attached file.

Portable and mobile RF communications equipment may affect the performance of Care-11U, Care-11D, Care-22U, Care-22D, Care-33U, Care33D integral dental unit and avoid strong electromagnetic interference when used, such as near cell phones. Microwave oven, etc.

The instructions for the guide and the manufacturer are detailed in the appendix.



Warning:

Equipment or system should not be used in close proximity or stacked with other equipment. If they must be used close to or stacked, they should be observed to operate properly in the configuration in which they are used.

In addition to the transducers and cables sold by the manufacturer of the device or system as spare parts for internal components, the use of additional accessories, transducers and cables may result in increased emissions or immunity of the device or system.

Use of accessories, transducers or cables with specified equipment, and systems outside of the regulations may result in increased emissions or reduced immunity of the equipment or system.

Emission and Immunity test		Basic Standard	Compliant Level/Note
Electromagnetic compatible emission	Radiated Emission	CISPR 11	Group 1, Class B
	Conducted Emission	CISPR 11	Group 1, Class B
	Harmonic Current	IEC61000-3-2	Class A
	Voltage Fluctuations and Flickers	IEC61000-3-3	Clause 5 of IEC 61000-3-3
Electromagnetic compatible immunity	Electrostatic Discharge	IEC 61000-4-2	Contact: $\pm 8KV$ Air: $\pm 2KV \pm 4KV \pm 8KV \pm 15KV$
	Radiated RF Electromagnetic Fields	IEC 61000-4-3	3 V/m 80 MHz to 2.7 GHz 1KHz 80%AM
	Electrical Fast Transients and Bursts	IEC 61000-4-4	power port: $\pm 2kV$
	Surges	IEC 61000-4-5	line-to-line: $\pm 0.5KV \pm 1KV$ Line-to-ground: $\pm 0.5KV \pm 1KV \pm 2KV$
	Conducted Disturbance, Induced by RF Fields	IEC 61000-4-6	3Vrms 150 kHz to 80 MHz 6 Vrms ISM frequency band
	Power Frequency Magnetic Field	IEC 61000-4-8	30A/m 50Hz/60Hz
	Voltage Dips, Short Interruptions and Voltage Variations	IEC 61000-4-11	0% UT, 0.5T at 0e, 45e, 90e, 135e, 180e, 225e, 270e and 315e 0% UT, 1T at 0e; 70% UT, 25T at 0e; 0% UT, 250T

WARNING: Use of accessories, transducers and cables other than those specified or provided by the manufacturer of this equipment could result in increased electromagnetic emissions or decreased electromagnetic immunity of this equipment and result in improper operation.

WARNING: Use of this equipment adjacent to or stacked with other equipment should be avoided because it could result in improper operation. If such use is necessary, this equipment and the other equipment should be observed to verify that they are operating normally.

WARNING: Portable RF communications equipment (including peripherals such as antenna cables and external antennas) should be used no closer than 30 cm (12 inches) to any part of the [CARE-11 CARE-22 CARE-33], including cables specified by the manufacturer. Otherwise, degradation of the performance of this equipment could result.

17. Packing List

Test Frequency (MHz)	Band (MHz)	Modulation	LMMUNITY TEST LEVEL (V/m)
385	380-390	Pulse Modulation 18Hz	27
450	430-470	FM ±5kHz deviation 1kHz sine	28
710	704-787	Pulse Modulation 217Hz	9
745			
780			
810	800-960	Pulse Modulation 18Hz	28
870			
930			
1720	1700-1990	Pulse Modulation 217Hz	28
1845			
1970			
2450	2400-2570	Pulse Modulation 217Hz	28
5240	5100-5800	Pulse Modulation 217Hz	9
5500			
5785			

NO.	NAME	Company	Quantity	Remark
1	Dental unit		1	
2	Doctor seat		1	
3	Dental light and accessories		1	
4	Lamp column and accessories		1	
5	1000ML water storage bottle		1	
6	Syringe gun nozzle		2	
7	Flush nozzle		1	
8	Mouthwash nozzle		1	
9	O-rings (d6 × Ø1.8, d5 × Ø1.8)		2	
10	Strong suction		1	
11	Weak suction		2	
12	Ø8 XØ5.5 blue PU tube		1	
13	Ø8 X Ø5.5 black PU tube		1	
14	1/2 connector		2	
15	Assembly studs		2	
16	1/4 ball valve		2	
17	1/4 connector		4	
18	Fuses (2A 3A 5A 6.3A 8A)		2	
19	Positioning pins		4	
20	Lamp tube decoration set		2	
21	Product Instruction Manual		1	
22	Quality Assurance		2	
23	Certificate		2	
24	Strong weak suction adapter (external suction option)		1	
25	Hanger buckle (external suction option)	portion	1	
26	Scaler (optional)	portion	1	
27	Curing light (optional)			
28	Built-in Oral Camera (optional)			
29	Monitor (optional)			
30	Nurse chair (optional)			
31	High speed handpiece (optional)			
32	Low speed handpiece (optional)			
33	Instrument tray sub-disc assembly (top-mounted option)			
34	Metal storage tray (children)			
35	Spittoon accessories			
36	Assembly screws			
37	Strong and weak suction decorative board (CARE22&33)			
38	Low-speed electric motor handpiece (optional)			
39	High-speed electric motor handpiece (optional)	portion		
40	Funnel (CARE22)	portion		

Exception please check packing list “APPENDIX”

