









**Ohrspekula : Ear specula
Spéculums auriculaires
Espéculos auriculares
Specoli auricolari**



| Toynbee |  1:1 |  1:1 |  1:1 |  1:1 |
|----------------|---|---|---|---|
| | Fig. 1 | Fig. 2 | Fig. 3 | Fig. 4 |
| | 4.5 mm Ø | 5.5 mm Ø | 6.5 mm Ø | 7.5 mm Ø |
| 36 mm – 1 1/2" | ES 15-10-01 | ES 15-10-02 | ES 15-10-03 | ES 15-10-04 |





Satz, für Erwachsene
Set, for adults



| Richnau Holmgren |  1:1 |  1:1 |  1:1 |  1:1 |
|------------------|---|---|---|---|
| | Fig. 0 | Fig. 1 | Fig. 2 | Fig. 3 |
| | 3 mm Ø | 4 mm Ø | 5 mm Ø | 6 mm Ø |
| | ES 15-15-01 | ES 15-15-02 | ES 15-15-03 | ES 15-15-04 |





Ohrspekula : Ear specula
Spéculums auriculaires : Espéculos auriculares
Specoli auricolari



| Gruber |  1:1 |  1:1 |  1:1 |  1:1 |
|--------|---|---|---|---|
| | Fig. 1 | Fig. 2 | Fig. 3 | Fig. 4 |
| | a = 4.5 mm | a = 5.5 mm | a = 6.5 mm | a = 7.5 mm |
| | ES 15-20-01 | ES 15-20-02 | ES 15-20-03 | ES 15-20-04 |







Satz für Erwachsene
Set for adults



| Gruber |  1:1 |  1:1 |  1:1 |  1:1 |
|--------|---|---|---|---|
| | Fig. 1 | Fig. 2 | Fig. 3 | Fig. 4 |
| | 4.5 mm Ø | 5.5 mm Ø | 6.5 mm Ø | 7.5 mm Ø |
| | ES 15-25-01 | ES 15-25-02 | ES 15-25-03 | ES 15-25-04 |





Satz für Erwachsene
Set for adults



| Zoller |  1:1 |  1:1 |  1:1 |  1:1 |  1:1 |  1:1 |
|--------|---|---|---|--|---|---|
| | Fig. 1 | Fig. 2 | Fig. 3 | Fig. 4 | Fig. 5 | Fig. 6 |
| | 5.5 x 6.5 mm | 6.5 x 7.5 mm | 7.5 x 8.5 mm | 8.5 x 9.5 mm | 9.5 x 10.5 mm | 10.5 x 11.5 mm |
| | ES 15-30-01 | ES 15-30-02 | ES 15-30-03 | ES 15-30-04 | ES 15-30-05 | ES 15-30-06 |

Satz für Erwachsene, schwarz
Set for adults, black







| Politzer |  1:1 |  1:1 |  1:1 |  1:1 |
|----------|---|---|---|---|
| | Fig. 1 | Fig. 2 | Fig. 3 | Fig. 4 |
| | 2 mm Ø | 3 mm Ø | 4 mm Ø | 5 mm Ø |
| | ES 15-35-01 | ES 15-35-02 | ES 15-35-03 | ES 15-35-04 |

Satz für Erwachsene
Set for adults



Ohrspekula : Ear specula
Spéculums auriculaires : Espéculos auriculares
Specoli auricolari



| Boucheron |  1:1 |  1:1 |  1:1 |  1:1 |
|-----------|---|---|---|---|
| | Fig. 1 | Fig. 2 | Fig. 3 | Fig. 4 |
| | 4.5 mm Ø | 5.5 mm Ø | 6.5 mm Ø | 7.5 mm Ø |
| | ES 15-40-01 | ES 15-40-02 | ES 15-40-03 | ES 15-40-04 |





Satz für Erwachsene
Set for adults



| Boucheron |  1:1 |  1:1 |  1:1 |
|-----------|---|---|---|
| | Fig. 0 | Fig. 1 | Fig. 2 |
| | 3.0 mm Ø | 4.5 mm Ø | 5.5 mm Ø |
| | ES 15-45-01 | ES 15-45-02 | ES 15-45-03 |





Satz für Kinder
Set for children



| Hartmann |  1:1 |  1:1 |  1:1 |  1:1 |
|----------|---|---|---|---|
| | Fig. 1 | Fig. 2 | Fig. 3 | Fig. 4 |
| | 4.5 mm Ø | 5.5 mm Ø | 6.5 mm Ø | 7.5 mm Ø |
| | ES 15-50-01 | ES 15-50-02 | ES 15-50-03 | ES 15-50-04 |

Satz für Erwachsene
Set for adults











| Hartmann |  1:1 |  1:1 |  1:1 |  1:1 |  1:1 |
|----------|---|---|---|---|---|
| | Fig. 1 | Fig. 2 | Fig. 3 | Fig. 4 | Fig. 5 |
| | 2.0 mm Ø | 3.5 mm Ø | 5.0 mm Ø | 6.5 mm Ø | 7.5 mm Ø |
| | ES 15-55-01 | ES 15-55-02 | ES 15-55-03 | ES 15-55-04 | ES 15-55-05 |









Satz für Erwachsene, schwarz
Set for adults, black

Ohrküretten : Ear cures
Curettes auriculaires : Cures auriculaires
Curette auricolari





| | | | | | | | | |
|--------------|---|---|---|---|---|---|---|---|
| Buck |  1:1 |  1:1 |  1:1 |  1:1 |  1:1 |  1:1 |  1:1 |  1:1 |
| | Fig. 000 | Fig. 00 | Fig. 0 | Fig. 1 | Fig. 2 | Fig. 3 | Fig. 4 | Fig. 5 |
| 165mm-6 1/2" | EC 15-10-01 | EC 15-10-02 | EC 15-10-03 | EC 15-10-04 | EC 15-10-05 | EC 15-10-06 | EC 15-10-07 | EC 15-10-08 |

stumpf
blunt
 mousse
 roma
 smussa

| | | | | | | | | |
|--------------|---|---|---|---|---|---|---|---|
| |  1:1 |  1:1 |  1:1 |  1:1 |  1:1 |  1:1 |  1:1 |  1:1 |
| | Fig. 000 | Fig. 00 | Fig. 0 | Fig. 1 | Fig. 2 | Fig. 3 | Fig. 4 | Fig. 5 |
| 165mm-6 1/2" | EC 15-15-01 | EC 15-15-02 | EC 15-15-03 | EC 15-15-04 | EC 15-15-05 | EC 15-15-06 | EC 15-15-07 | EC 15-15-08 |









scharf
sharp
 tranchante
 cortante
 tagliente

  **Abbildungen zeigen den Außendurchmesser.**
Pictures show the outer diameter.
 Illustrations représentent le diamètre externe.
 Ilustraciones presentan el diametro externo. Le
 illustrazioni mostrano il diametro esterno.









Ohrküretten : Ear cures
Curettes auriculaires : Curetas auriculares
Curette auricolari



Buck

| | | | | | | | | |
|---|---|---|---|--|---|---|---|-------------|
|  |  |  |  |  |  |  |  | |
| 1:1 | 1:1 | 1:1 | 1:1 | 1:1 | 1:1 | 1:1 | 1:1 | |
| Fig. 000 | Fig. 00 | Fig. 0 | Fig. 1 | Fig. 2 | Fig. 3 | Fig. 4 | Fig. 5 | |
| 165 mm-6 1/2" | EC 15-20-01 | EC 15-20-02 | EC 15-20-03 | EC 15-20-04 | EC 15-20-05 | EC 15-20-06 | EC 15-20-07 | EC 15-20-08 |

gebogen, stumpf
curved, blunt
 courbe, tranchante
 curva, cortante
 curva, smussa

| | | | | | | | | |
|---|---|---|---|--|---|---|---|-------------|
|  |  |  |  |  |  |  |  | |
| 1:1 | 1:1 | 1:1 | 1:1 | 1:1 | 1:1 | 1:1 | 1:1 | |
| Fig. 000 | Fig. 00 | Fig. 0 | Fig. 1 | Fig. 2 | Fig. 3 | Fig. 4 | Fig. 5 | |
| 165 mm-6 1/2" | EC 15-25-01 | EC 15-25-01 | EC 15-25-01 | EC 15-25-01 | EC 15-25-01 | EC 15-25-01 | EC 15-25-01 | EC 15-25-01 |

gebogen, scharf
curved sharp
 courbe, pointue
 curva, aguda
 curva, tagliente

1:1

Ohrküretten und scharfe Löffel
Ear cures and sharp spoons
Curettes auriculaires et cuillères tranchantes
Curetas y cucharillas auriculares cortantes
Curette auricolari e cucchiari taglienti



Langenbeck
 130 mm – 5"
 EC 15-30-01

stumpf
blunt



Jansen
 170 mm – 6³/₄"
 EC 15-35-01

scharf
sharp



Gross
 120 mm – 4³/₄"
 EC 15-40-01

scharf, voll
sharp, not fenestrated



Jansen
 120 mm – 4³/₄"
 EC 15-45-01

stumpf, gefenstert
blunt, fenestrated





Jansen
 160 mm – 6¹/₄"
 EC 15-50-01

scharf
sharp

Ohrschlingen – Håkchen
Ear loops – hooks
Anses – crochets auriculaires
Asas – ganchos auriculares
Anse – uncini auricolari





1:2

| Billeau |  1:1 |  1:1 |  1:1 |
|--------------|---|---|---|
| 165 mm – 6½" | EH 15-10-01 | EH 15-10-02 | EH 15-10-03 |









1:2

| Lucae |  1:1 |  1:1 |  1:1 |
|--------------|---|---|---|
| 140 mm – 5½" | EH 15-15-01 | EH 15-15-02 | EH 15-15-03 |



1:2

| Wagener |  1:1 |  1:1 |  1:1 |  1:1 |  1:1 |  1:1 |  1:1 |
|--------------|---|---|---|---|---|---|---|
| 140 mm – 5½" | EH 15-20-01 | EH 15-20-02 | EH 15-20-03 | EH 15-20-04 | EH 15-20-05 | EH 15-20-06 | EH 15-20-07 |

Ohrhäkchen - Messer
Ear hooks - knives
Crochets - couteaux auriculaires
Ganchos - cuchillos auriculares
Uncini - coltelli auricolari

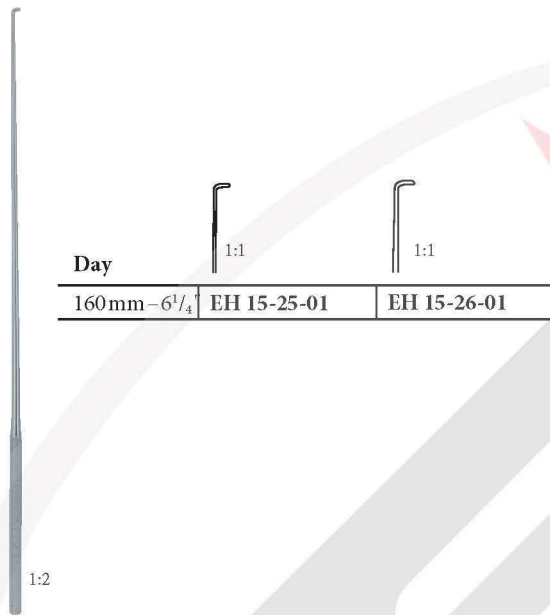

| | | |
|------------|---|---|
| Day |  1:1 |  1:1 |
| | 160mm - 6 ¹ / ₄ " | EH 15-25-01 EH 15-26-01 |



| | |
|---|-------------|
| Muck | |
| 135mm - 5 ¹ / ₄ " | EH 15-30-01 |



| | |
|---|-------------|
| Gerzog-sexton | |
| 170mm - 6 ³ / ₄ " | EH 15-35-01 |

Parazentesenadeln
Paracentesis needles
Aiguilles de paracentèse
Agujas para paracentesis
Aghi per paracentesi



1:1

Politzer

150 mm - 6"

PN 15-10-01



1:1

Gerzog

160 mm - 6 1/4"

PN 15-15-01



1:1

Buck

160 mm - 6 1/4"

PN 15-20-01



1:1



1:1



1:2



1:2

Lucae

180 mm - 7"

PN 15-25-01

PN 15-26-01



1:1



1:2

Lucae

190 mm - 7 1/2"

PN 15-30-01



1:1



1:2

Politzer

170 mm - 6 3/4"

PN 15-35-01



1:1



1:2

Politzer

160 mm - 6 1/4"

PN 15-40-01

Nadel senkrecht
Needle vertical



1:1



1:2

Politzer

160 mm - 6 1/4"

PN 15-45-01

Nadel waagrecht
Needle horizontal

Ohrpolypenschnürer
Ear polypus snares
Serre noeuds auriculaires
Polipótomos auriculares
Serranodi auricolari



| | |
|----------|---------------|
| | 10 m - 33 ft. |
| 0.3 mm Ø | EP 15-10-01 |
| 0.4 mm Ø | EP 15-10-02 |



| | |
|-------------------|-------------|
| 0.2 mm Ø x 75 mm | EP 15-15-01 |
| 0.3 mm Ø x 100 mm | EP 15-15-02 |

in Bündeln mit 12 Stück
in bundles of 12 pieces



Krause 1:2
 160 mm - 6¹/₄" **EP 15-100-01**



Krause-Voss 1:2
 160 mm - 6¹/₄" **EP 15-105-01**



Lange-Wilde 1:2
 170 mm - 6³/₄" **EP 15-110-01**

Ohrpolypenzangen : Ear polypus forceps
Pinces pour polypes auriculaires : Pinzas para pólipos auriculares
Pinze per polipi auricolari

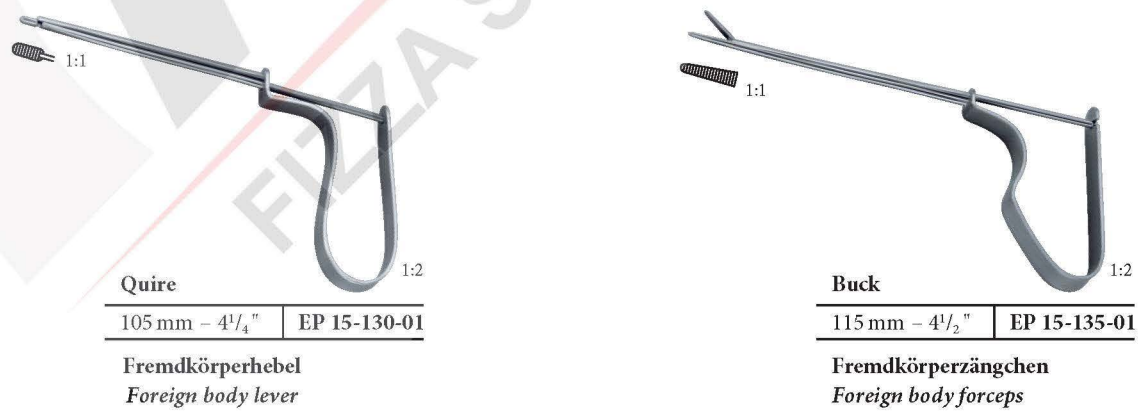
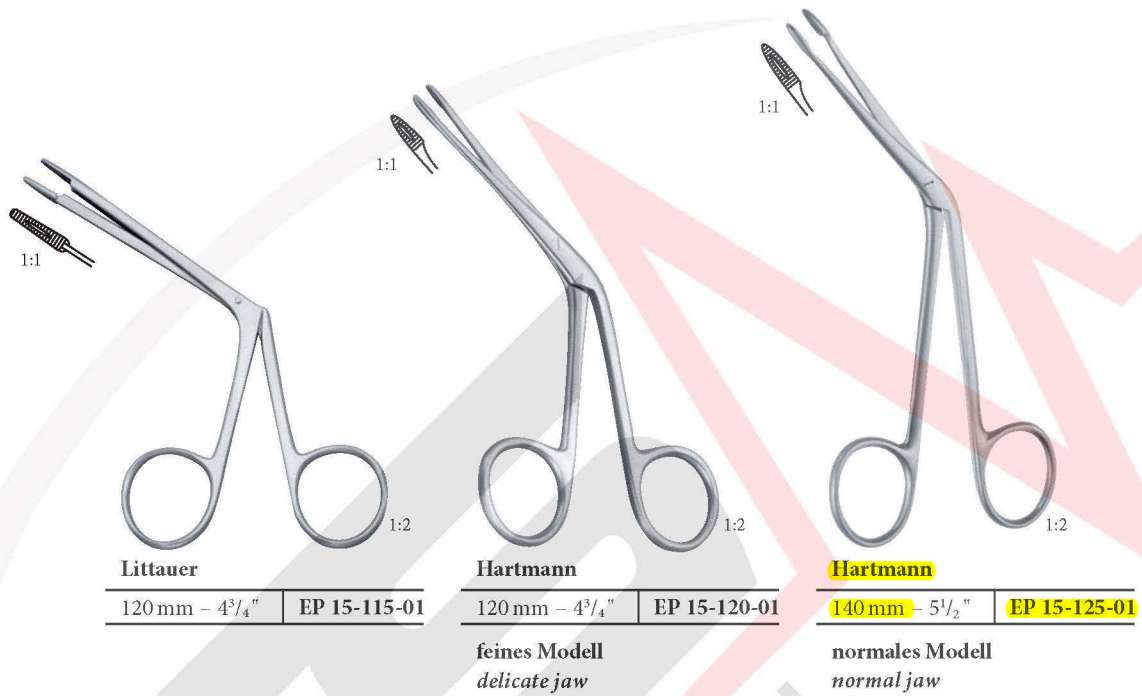

Ohrzängchen : Ear forceps
Pincés auriculaires : Pinzas auriculares
Pinze auricolari



Hartmann-Wullstein

| | |
|--------------------|--------------|
| x = 85 mm - 3 1/4" | EF 15-100-01 |
|--------------------|--------------|



Hartmann-Wullstein

| | |
|--------------------|--------------|
| | 1 mm Ø |
| x = 85 mm - 3 1/4" | EF 15-105-01 |



Hartmann

| | |
|---------------------|--------------|
| x = 85 mm - 3 1/4" | EF 15-110-01 |
| x = 140 mm - 5 1/2" | EF 15-110-02 |
| x = 160 mm - 6 1/4" | EF 15-110-03 |



Haetmann

| | |
|---------------------|--------------|
| x = 85 mm - 3 1/4" | EF 15-115-01 |
| x = 140 mm - 5 1/2" | EF 15-115-01 |

1x2

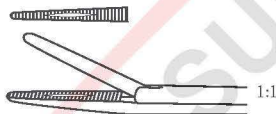

Hartmann-Noyes

| | |
|--------------------|--------------|
| x = 90 mm - 3 1/2" | EF 15-120-01 |
|--------------------|--------------|

Struempel

| | |
|----|--------------------|
| | x = 85 mm - 3 1/4" |
| 0° | EF 15-125-01 |

| | |
|-----|--------------|
| 45° | EF 15-125-02 |
|-----|--------------|

| | |
|-----|--------------|
| 90° | EF 15-125-03 |
|-----|--------------|



Hartmann-Weingartner

| | |
|--------------------|--------------|
| x = 85 mm - 3 1/4" | EF 15-130-01 |
|--------------------|--------------|



Hartmann

| | |
|----------|--------------------|
| | x = 85 mm - 3 1/4" |
| 2.0 mm Ø | EF 15-135-01 |
| 2.5 mm Ø | EF 15-135-02 |
| 3.0 mm Ø | EF 15-135-03 |

Ohrzängchen : Ear forceps
Pinces auriculaires : Pinzas auriculares
Pinze auricolari



Hartmann

| | |
|-----------------|--------------|
| 4x0,4 mm, 80 mm | EF 15-140-01 |
| 4x0,5 mm, 80 mm | EF 15-140-02 |



SURGERY HNO – ENT

Mikro-Ohrzängchen : *Micro ear forceps*
 Micro pinces auriculaires : *Micro-pinzas auriculares*
 Micro-pinze auricolari



McGee



3.5 mm x 0.8 mm | EF 15-145-01

Drahtbiegezängchen
Wire bending forceps

Fuller



80 mm – 3 1/4" | EF 15-150-01

Einführungszängchen für Teflonprothesen
Introducing forceps for teflon prosthesis

Dieter

x = 80 mm – 3 1/4"



EF 15-155-01

Hammerkopffzängchen
Malleus nipper

oben schneidend

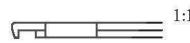

EF 15-155-02

unten schneidend
down-cutting

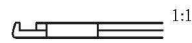

EF 15-155-03

rechts schneidend
right-cutting

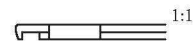





EF 15-155-04

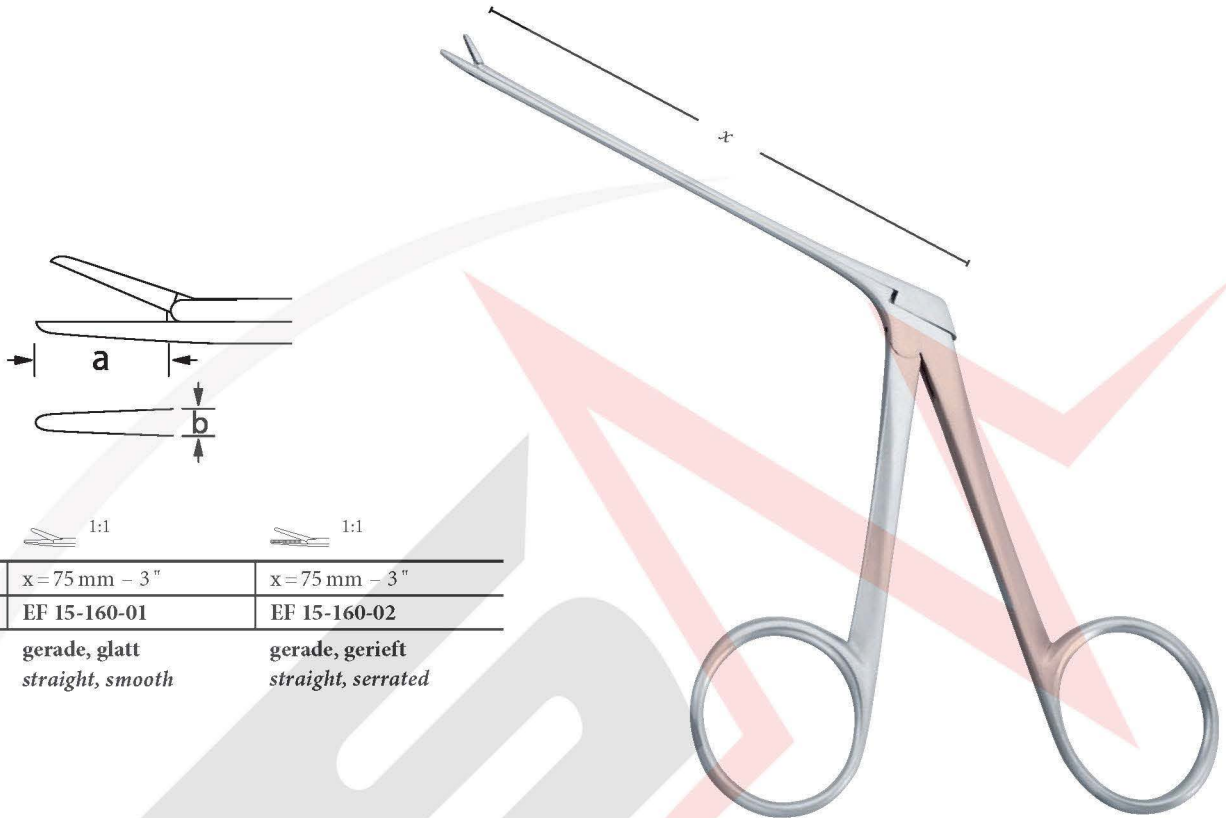

links schneidend

Mikro-Ohrzängchen : Micro ear forceps
Micro pinces auriculaires : Micro-pinzas auriculares
Micro-pinze auricolari



| Mini McGee | |  1:1 |  1:1 |
|-------------------|---|---|---|
| a x b | x = 75 mm – 3" | x = 75 mm – 3" | x = 75 mm – 3" |
| 3.5 mm x 0.6 mm | EF 15-160-01 | EF 15-160-02 | |
| | gerade, glatt <i>straight, smooth</i> | gerade, gerieft <i>straight, serrated</i> | |

| |  1:1 |  1:1 |  1:1 |
|-----------------|---|---|---|
| a x b | x = 75 mm – 3" | x = 75 mm – 3" | x = 75 mm – 3" |
| 3.5 mm x 0.6 mm | EF 15-161-01 | EF 15-161-02 | EF 15-161-03 |
| 4.0 mm x 0.8 mm | EF 15-162-01 | EF 15-162-02 | EF 15-162-03 |
| | gerade, glatt <i>straight, smooth</i> | gerade, gerieft <i>straight, serrated</i> | aufgebogen, gerieft <i>curved upwards, serrated</i> |



| |  1:1 |  1:1 |  1:1 |
|-----------------|---|---|---|
| a x b | x = 75 mm – 3" | x = 75 mm – 3" | x = 75 mm – 3" |
| 3.5 mm x 0.6 mm | EF 15-163-01 | EF 15-163-02 | EF 15-163-03 |
| 4.0 mm x 0.8 mm | EF 15-164-01 | EF 15-164-02 | EF 15-164-03 |
| | rechts gebogen, gerieft <i>curved to right, serrated</i> | links gebogen, gerieft <i>curved to left, serrated</i> | abwärts gebogen, gerieft <i>angled down, serrated</i> |

Mikro-Löffelzängchen : *Micro cup forceps*

Micro pinces auriculaires à cuillère : Micro-pinzas auriculares a cucharilla

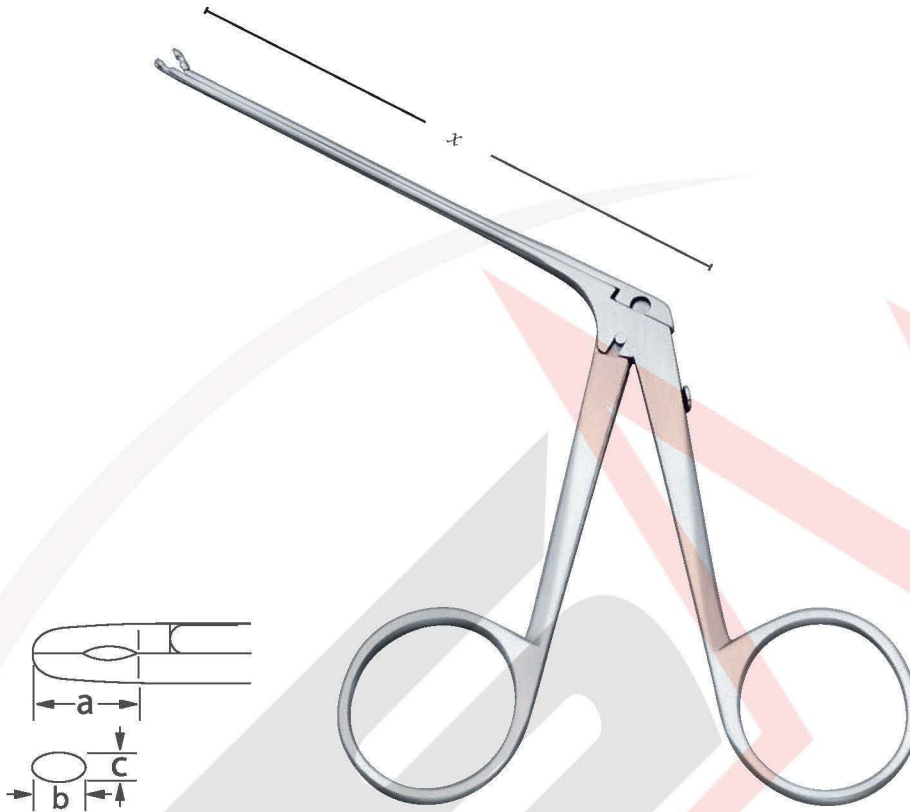
Micro-pinze auricolari a cucchiaio



| | | | |
|----------------------------|---|---|---|
| |  1:1 |  1:1 |  1:1 |
| | x = 75 mm - 3" | x = 75 mm - 3" | x = 75 mm - 3" |
| a=4.0mm b=1.0mm x c=0.9 | EF 15-165-01 | EF 15-165-02 | EF 15-165-03 |

| | | | |
|----|--|--|---|
| mm | <i>gerade, oval straight, oval</i> | <i>aufgebogen, oval curved upwards, oval</i> | <i>links gebogen, oval curved to left, oval</i> |
|----|--|--|---|

| | | |
|----------------------------|---|---|
| |  1:1 |  1:1 |
| | x = 75 mm - 3" | x = 75 mm - 3" |
| a=4.0mm b=1.0mm x c=0.9 | EF 15-166-01 | EF 15-166-02 |



| | | |
|----|---|---|
| mm | <i>rechts gebogen, oval curved to right, oval</i> | <i>abwärts gebogen, oval curved downwards, oval</i> |
|----|---|---|

Mikro-Löffelzängchen : *Micro cup forceps*

Micro pinces auriculaires à cuillère : Micro-pinzas auriculares a cucharilla



Micro-pinze auricolari a cucchiaio



| | | |
|---------------------------------------|---|--|
| |  1:1 |  1:1 |
| | x = 80 mm - 3 ¹ / ₄ " | x = 80 mm - 3 ¹ / ₄ " |
| a = 3.5 mm b = 0.6 mm x c = 0.5 mm | EF 15-170-01 | EF 15-170-02 |
| a = 4.0 mm b = 1.0 mm x c = 0.9 mm | EF 15-171-01 | EF 15-171-02 |

**gerade, oval
straight, oval**

**aufgebogen, oval
curved upwards, oval**

| | | |
|---------------------------------------|---|--|
| |  1:1 |  1:1 |
| | x = 80 mm - 3 ¹ / ₄ " | x = 80 mm - 3 ¹ / ₄ " |
| a = 3.5 mm b = 0.6 mm x c = 0.5 mm | EF 15-175-01 | EF 15-175-02 |
| a = 4.0 mm b = 1.0 mm x c = 0.9 mm | EF 15-176-01 | EF 15-176-02 |

**rechts gebogen, oval
curved to right, oval**

**aufgebogen, oval
curved to left, oval**

Mikro-Ohrscheren : Micro ear scissors
Micro ciseaux auriculaires : Micro-tijeras para oidos
Micro-forbici auricolari

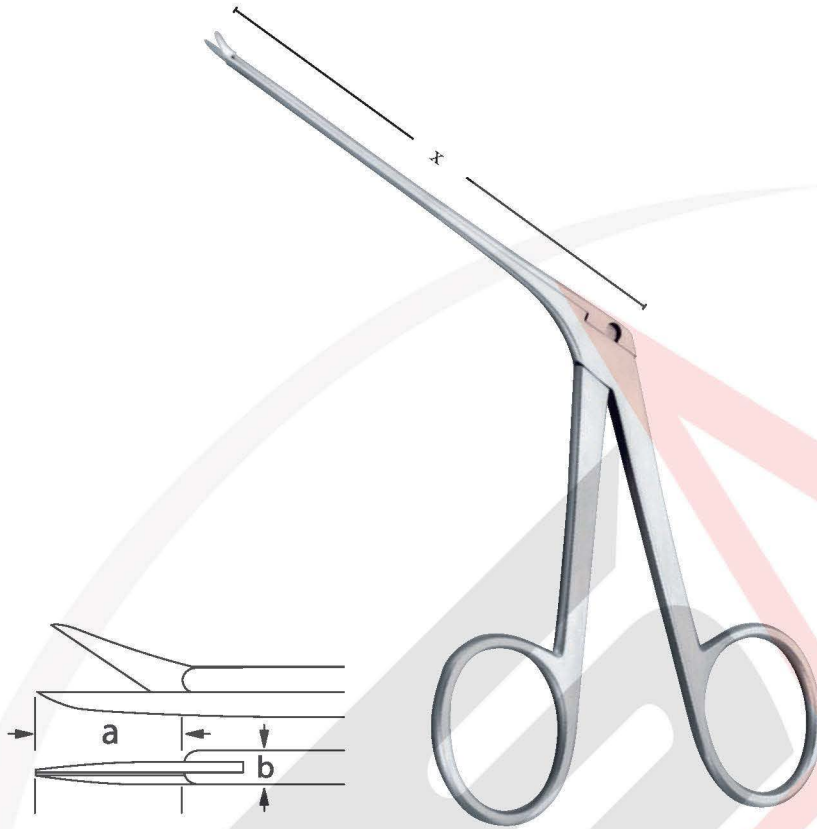

| Belucci | | Belucci | |
|------------------------|--|--|--|
| a x b | x = 75 mm – 3" | x = 75 mm – 3" | |
| 4.0 mm x 0.8 mm | EF 15-180-01 | EF 15-180-02 | |
| sehr fein very fine | gerade, spitz/spitz straight, sharp/sharp | aufgebogen, stumpf/stumpf curved upwards, blunt/blunt | |

| a x b | x = 75 mm – 3" | x = 75 mm – 3" | |
|------------------------|---|---|--|
| 4.0 mm x 0.8 mm | EF 15-181-01 | EF 15-181-02 | |
| sehr fein very fine | rechts gebogen, spitz/spitz curved to right, sharp/sharp | links gebogen, spitz/spitz curved to left, sharp/sharp | |

| | x = 75 mm – 3" | | |
|-----------------|---|--|--|
| 4.0 mm x 0.8 mm | EF 15-181-03 | | |
| | gerade, spitz/stumpf straight, sharp/blunt | | |

Mikro-Ohrscheren : *Micro ear scissors*

Micro ciseaux auriculaires : *Micro-tijeras para oidos*

Micro-forbici auricolari

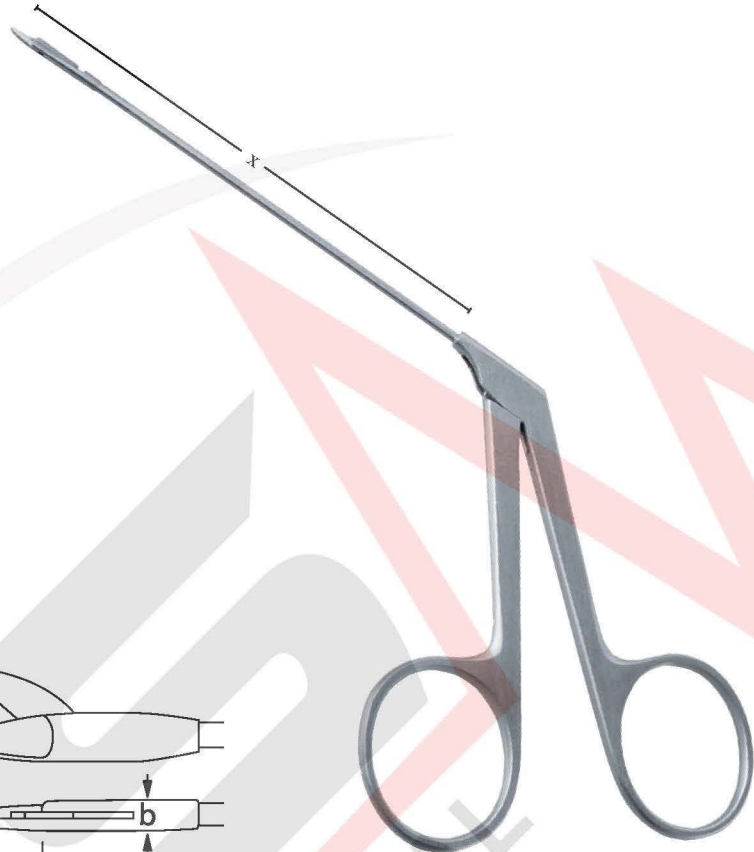

| Wullstein | 1:1 | 1:1 |
|-----------------|---|---|
| a x b | x = 80 mm - 3 ¹ / ₄ " | x = 80 mm - 3 ¹ / ₄ " |
| 4.0 mm x 0.8 mm | ES 15-185-01 | ES 15-185-02 |
| | gerade, spitz/spitz <i>straight, sharp/sharp</i> | aufgebogen, spitz/spitz <i>curved upwards, sharp/sharp</i> |

| Wullstein | 1:1 | 1:1 |
|-----------------|--|--|
| a x b | x = 80 mm - 3 ¹ / ₄ " | x = 80 mm - 3 ¹ / ₄ " |
| 4.0 mm x 0.8 mm | ES 15-186-01 | ES 15-186-02 |
| | rechts gebogen, spitz/spitz <i>curved to right, sharp/sharp</i> | links gebogen, spitz/spitz <i>curved to left, sharp/sharp</i> |

Ohr Mikro-Raspatorien und Sonden : *Micro ear-raspatories and probes*
Micro-raspatori e sonde auricolari

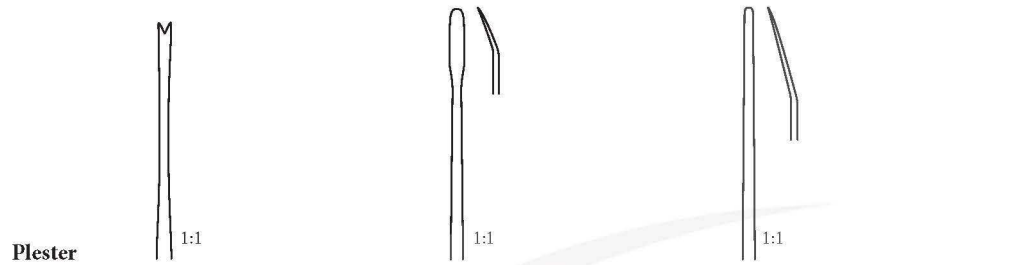

| | | | |
|-----------------|---|--|---------------------------------------|
| Plester | | | |
| 160 mm – 6 1/4" | EP15-190-01 | EP 15-190-02 | EP 15-190-03 |
| | Führungsgabel <i>Wire guide</i> | Raspatorium <i>Raspatory</i> | Elevatorium <i>Elevator</i> |

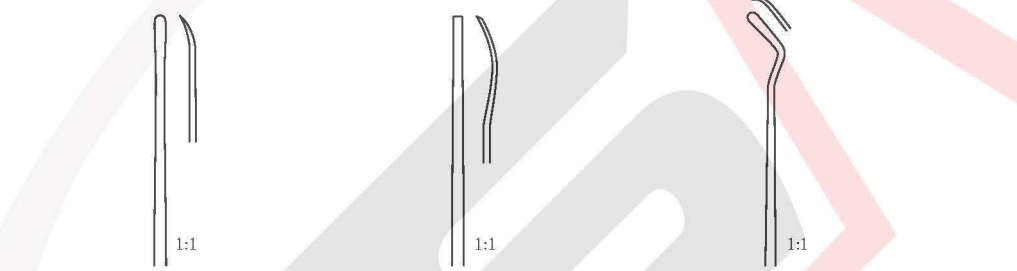

| | | | |
|-----------------|--|--|---|
| | 1.8 mm | 1.0 mm | |
| 160 mm – 6 1/4" | EP 15-195-01 | EP 15-195-02 | EP 15-195-03 |
| | Raspatorium <i>Raspatory</i> | Raspatorium <i>Raspatory</i> | Dissektor, doppelt links gebogen <i>Dissector, double curved left</i> |

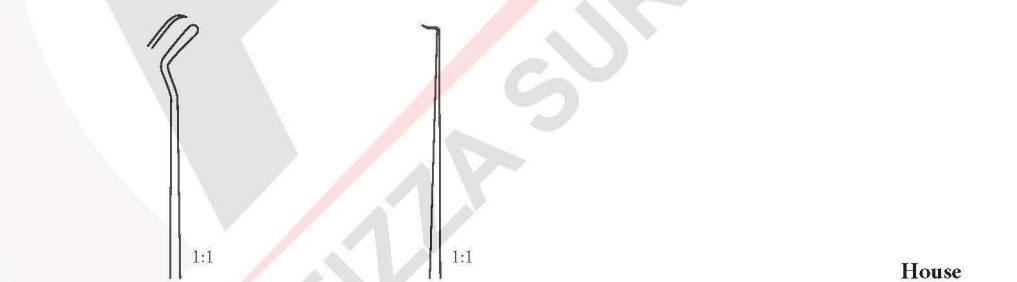

| | | |
|-----------------|---|--|
| 160 mm – 6 1/4" | EP 15-200-01 | EP 15-200-02 |
| | Dissektor, doppelt rechts gebogen <i>Dissector, double curved right</i> | Handinstrument zum Andrücken von Drahtprothesen <i>Instrument for placing wire prothesis</i> |





| | |
|--------------|-----------------|
| House | |
| | 160 mm – 6 1/4" |
| 3.5 mm | EP 15-205-01 |
| 4.0 mm | EP 15-205-02 |
| 4.5 mm | EP 15-205-03 |
| 5.0 mm | EP 15-205-04 |

Messsonde
Measuring rod





Ohrsichelmesser - Rundschnittmesser
Ear sickleknifes - Circular cutting knife
Couteaux faucilles - Couteaux ronds
Cuchillos en forma de hoz - Cuchillos redondos
Coltelli auricolari







Rosen

| | | | |
|---|---|---|---|
|  |  |  |  |
| 1:1 | 1:1 | 1:1 | 1:1 |
| 1.5 mm Ø - 90° | 45° | 45° | |
| 160 mm - 6 1/4" | EK 15-210-01 | EK 15-210-02 | EK 15-210-03 |
| Rundschnittmesser <i>Circular cutting</i> | Trommelfellmesse <i>r Tympanum knife</i> | Lanzenmesser <i>Lancet knife</i> | Lanzenmesser <i>Lancet knife</i> |

Schuknecht

| | | | |
|--|--|---|---|
|  |  |  |  |
| 1:1 | 1:1 | 1:1 | 1:1 |
| 160 mm - 6 1/4" | EK 15-215-01 | EK 15-215-02 | EK 15-220-01 |
| Rollermesser, parallel <i>Roller knife, parallel</i> | Rollermesser, rechtwinklig <i>Roller knife, right angled</i> | Sichelmesser, leicht gebogen <i>Sickle knife, slightly curved</i> | Diszisionsmesser, gerade <i>Discision knife, straight</i> |

Plester

| | | | |
|---|---|---|---|
|  |  |  |  |
| 1:1 | 1:1 | 1:1 | 1:1 |
| 160 mm - 6 1/4" | EK 15-225-01 | 45° | 160 mm - 6 1/4" |
| Lappenmesser <i>Flap knife</i> | | 3.0 mm Ø | EK 15-230-01 |
| | | 2.6 mm Ø | EK 15-230-02 |
| | | 2.0 mm Ø | EK 15-230-03 |
| | | 1.5 mm Ø | EK 15-230-04 |
| | | 1.0 mm Ø | EK 15-230-05 |
| | | | Rundschnittmesser <i>Circular cutting Knife</i> |

Zollner

| | | |
|-----------------|--|--|
| | 1 mm | 1 mm |
| 160 mm - 6 1/4" | EK 15-235-01 | EK 15-235-02 |
| | Raspatorium <i>Raspatory</i> | Raspatorium <i>Raspatory</i> |

Mikro-Ohrinstrumente : Instruments for micro ear-surgery
Instrumentes pour la micro-chirurgie auriculaire
Instrumentos para la micro-cirugia auricular
Strumenti per micro-chirurgia auricolare



Zöllner

90°

EM 15-240-01

Rundschnittmesser, nach oben gebogen
Round knife, angled up



90°

EM 15-240-02

Rundschnittmesser, nach unten gebogen
Round knife, angled down



EM 15-240-03

Sichelmesser, nach oben gebogen
Sickle knife, angled up



EM 15-240-04

Sichelmesser, nach unten gebogen
Sickle knife, angled down



EM 15-240-05

Lanzennmesser, links gebogen
Lancet knife, curved to left



EM 15-240-06

Lanzennmesser, rechts gebogen
Lancet knife, curved to right



EM 15-240-07

Raspatorium, links gebogen
Raspatory, curved to left



EM 15-240-08

Raspatorium, rechts gebogen
Raspatory, curved to right



EM 15-240-09

Führungsgabel
Wire guide

Mikro-Ohrinstrumente
Instruments for micro ear-surgery
Instrumentos para la micro-chirurgie auriculaire
Instrumentos para la micro-cirugía auricular
Strumenti per micro-chirurgia auricolare

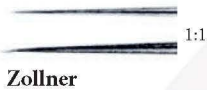

Zollner



| | | |
|--------------|--------------|--------------|
| EM 15-245-01 | EM 15-245-02 | EM 15-245-03 |
|--------------|--------------|--------------|

Nadel fein, gerade, spitz
Needle fine, straight, sharp

Häkchen, nach oben gebogen
Hook, angled up

Häkchen, nach unten gebogen
Hook, angled down



| | | |
|--------------|--------------|--------------|
| EM 15-245-04 | EM 15-245-05 | EM 15-245-06 |
|--------------|--------------|--------------|

Häkchen, nach oben gebogen
Hook, angled up

Häkchen, nach unten gebogen
Hook, angled down

Häkchen, nach oben gebogen
Hook, angled up



| | | |
|--------------|--------------|--------------|
| EM 15-245-07 | EM 15-245-08 | EM 15-245-09 |
|--------------|--------------|--------------|

Häkchen, nach unten gebogen
Hook, angled down

Häkchen, rund nach oben gebogen
Hook, curved up

Häkchen, rund nach unten gebogen
Hook, curved down

Stimmgabeln : Tuning forks

Diapasons : Diapasones

Diapasoni



1:2

Lucae

c 128

TF 15-250-01

verschiebbar bis h
variable up to h (engl. b)

1:2

Rydel-Seiffer

C64 / c 128

TF15-255-01

mit Dämpfer C64, ohne Dämpfer c 128
with clamps C64, without clamps c 128

1:2

French

C₂16

TF 15-260-01

1:2

C₁32

TF 15-261-01

Stimmgabeln : Tuning forks

Diapasons : Diapasones

Diapasoni



Hartmann

| | | | |
|--------------|--------------|--------------------|--------------------|
| C 64 | c 128 | c ¹ 256 | a ¹ 440 |
| TF 15-265-01 | TF 15-265-02 | TF 15-265-03 | TF 15-270-01 |

Lärmtrommel | Assourdiseur
Noise drum | Aparato de ruido
 Assordatore



Barany

ND 15-275-01

Stimmgabeln : Tuning forks
 Diapasons : Diapasones
 Diapasoni



Hartmann

| | | | | | |
|--------------|--------------------|--------------------|---------------------|---------------------|---------------------|
| c 128 | c ¹ 256 | c ² 512 | c ³ 1024 | c ⁴ 2048 | C ⁵ 4096 |
| TF 15-280-01 | TF 15-280-02 | TF 15-280-03 | TF 15-280-04 | TF 15-280-05 | TF 15-280-06 |

Stimmgabeln : Tuning forks

Diapasons : Diapasones

Diapasoni



SURGERY HNO – ENT

Mikro-Ohrnadeln und Häkchen : Micro ear-needles and hooks
Micro-aiguilles et crochets auriculaires : Micro-agujas y ganchos auriculares
Micro-uncini ed aghi auricolari



| |
|--|
| 160 mm – 6 ¹ / ₄ " |
| MN 15-290-01 |

Nadel fein, gerade, spitz
Needle fine, straight, sharp



| |
|--|
| 160 mm – 6 ¹ / ₄ " |
| MN 15-290-02 |

Nadel, leicht gebogen, spitz
Needle, slightly curved, sharp



| |
|--|
| 160 mm – 6 ¹ / ₄ " |
| MN 15-290-03 |

Nadel, stark gebogen, spitz
Needle, strong curved, sharp

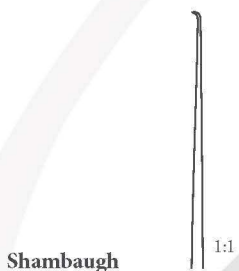

| | |
|--|--|
| Shambaugh | |
| 160 mm – 6 ¹ / ₄ " | 160 mm – 6 ¹ / ₄ " |
| 45° | 90° |
| 0.4 mm | MH 15-295-01 |
| 0.6 mm | MH 15-295-02 |
| 0.8 mm | MH 15-295-03 |
| 1.0 mm | MH 15-295-04 |
| MH 15-296-01 | MH 15-296-01 |
| MH 15-296-02 | MH 15-296-02 |
| MH 15-296-03 | MH 15-296-03 |
| MH 15-296-04 | MH 15-296-04 |

Häkchen, abgewinkelt
Hook, angled

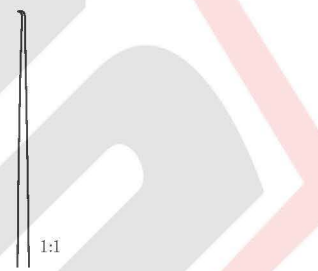

| | |
|--|---------------------|
| 160 mm – 6 ¹ / ₄ " | |
| 1.0 mm | MH 15-300-01 |
| 2.5 mm | MH 15-300-02 |

Häkchen, retrograd gebogen
Hook, retrograd

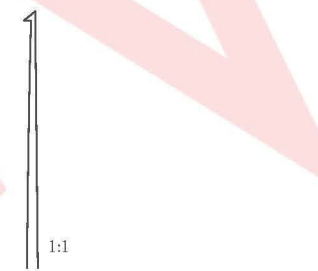

| | |
|--|---------------------|
| 0.6 mm | |
| 160 mm – 6 ¹ / ₄ " | MH 15-301-01 |

Häkchen, retrograd gebogen
Hook, retrograd



| | |
|----------------|---------------------|
| Plester | |
| 0.4 mm – 90° | MH 15-305-01 |

Fussplattenhäkchen, abgewinkelt, stumpf
Foot plate hook, angled, blunt



| | |
|----------------|---------------------|
| Plester | |
| 0.4 mm – 45° | MH 15-310-01 |

Antrum Häkchen, aufgewinkelt, stumpf
Antrum hook, angled, blunt

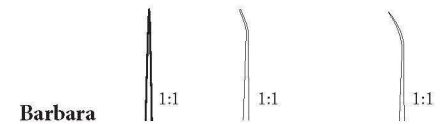

| | | |
|---------------------|---------------------|---------------------|
| Barbara | | |
| MH 15-315-01 | MH 15-315-02 | MH 15-315-03 |

spitz/gerade **stumpf/gewinkelt** **spitz/gebogen**
sharp/straight *blunt/angled* *sharp/curved*

SURGERY HNO – ENT

Mikro-Ohrnadeln und Häkchen : Micro ear-needles and hooks
Micro-aiguilles et crochets auriculaires : Micro-agujas y ganchos auriculares
Micro-uncini ed aghi auricolari

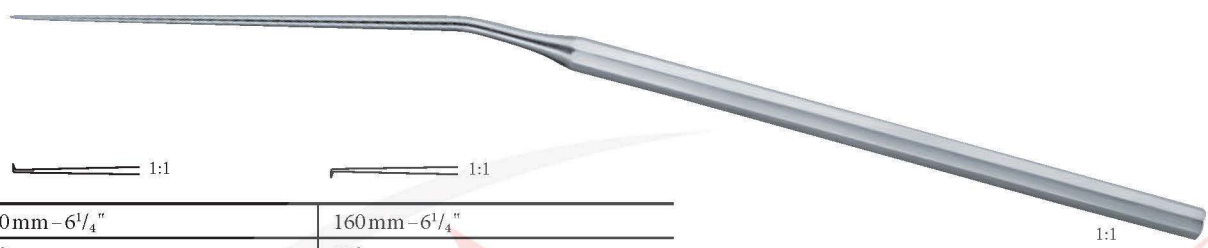

Shambaugh

| | | |
|--------|---|---|
| | 160mm – 6 ¹ / ₄ " | 160mm – 6 ¹ / ₄ " |
| | 90° | 90° |
| 0.3 mm | MH 15-320-01 | MH 15-321-01 |
| 0.6 mm | MH 15-320-02 | MH 15-321-02 |
| 1.0 mm | MH 15-320-03 | MH 15-321-03 |

Häkchen, nach oben gebogen
Hook, curved up

Häkchen, nach unten gebogen
Hook, curved down

McGee

| | | |
|--------|---|---|
| | 160mm – 6 ¹ / ₄ " | 160mm – 6 ¹ / ₄ " |
| 0.5 mm | MH 15-325-01 | MH 15-330-01 |
| 1.0 mm | MH 15-325-02 | MH 15-330-02 |

Häkchen, rund, nach oben gebogen
Hook, round, curved up

Häkchen, rund, nach unten gebogen
Hook, round, curved down

Barbara

| | |
|-------------|--------------|
| | 0.5 mm |
| 155 mm – 6" | MH 15-335-01 |

Rosen

| | |
|--|--------------|
| | 0.5 mm |
| 160 mm – 6 ¹ / ₄ " | MN 15-340-01 |

Nadel, leicht gebogen
Needle, slightly curved

McGee

| | | | | |
|--------|---|---|---|---|
| | 160mm – 6 ¹ / ₄ " | 160mm – 6 ¹ / ₄ " | 160mm – 6 ¹ / ₄ " | 160mm – 6 ¹ / ₄ " |
| | 25° | 25° | 45° | 45° |
| 0.3 mm | MH 15-345-01 | MH 15-346-01 | MH 15-347-01 | MH 15-348-01 |
| 0.6 mm | MH 15-345-01 | MH 15-346-02 | MH 15-347-02 | MH 15-348-02 |
| 1.0 mm | MH 15-345-01 | MH 15-346-03 | MH 15-347-03 | MH 15-348-03 |

Häkchen, nach oben gebogen
Hook, curved up





Häkchen, nach unten gebogen
Hook, curved down

Häkchen, nach oben gebogen
Hook, curved up

Häkchen, nach unten gebogen
Hook, curved down

Mikro-hrraspatorien : Micro ear-raspatories
Micro-raspateurs auriculaires : Micro-raspatorias auriculares
Micro-raspatori auricolari



| | | | | |
|--------------|---|---|---|---|
| Fisch |  1:1 |  1:1 |  1:1 |  1:1 |
| | 155 mm - 6" | 155 mm - 6" | 155 mm - 6" | 155 mm - 6" |
| | ER 15-10-01 | ER 15-10-02 | ER 15-10-03 | ER 15-10-04 |
| | rechts abgewinkelt <i>angled to the right</i> | links abgewinkelt <i>angled to the left</i> | rechts abgewinkelt <i>angled to the right</i> | links abgewinkelt <i>angled to the left</i> |

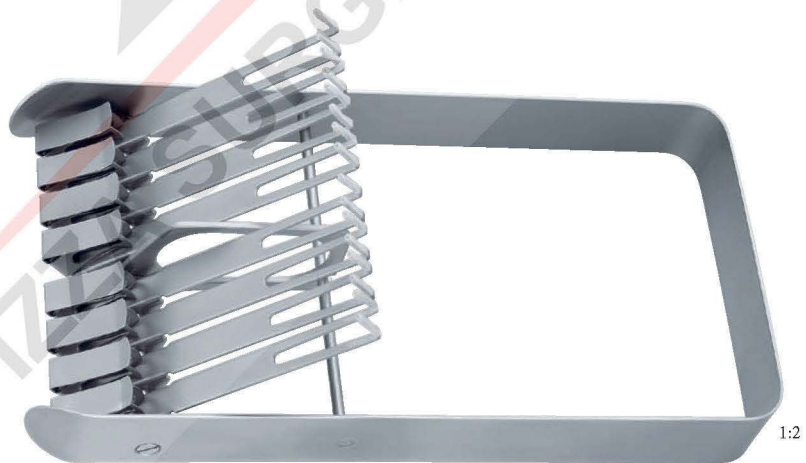

ER 15-15-01

Rack für 8 Mikro-Ohr-Instrumente mit Sechs- oder Achtkantgriff
Rack for 8 each micro ear instruments with hexagonal or octagonal handle

Mikro-Ohrlöffel : *Micro ear-spoons*
 Micro-curettes auriculaires : *Micro-curetas auriculares*
 Micro-cucchiai auricolari



House
 170 mm – 6³/₄" MS 15-20-01

Löffel, stark gebogen
 Spoon, strong curved

170 mm – 6³/₄" MS 15-25-01

Löffel, leicht gebogen
 Spoon, slightly curves



Shea

1:1

| | | |
|---|-----------------|-----------------|
| | 1.5 mm x 2.5 mm | 1.5 mm x 2.5 mm |
| 160mm – 6 ¹ / ₄ " | MS 15-30-01 | MS 15-35-01 |

gerade
 straight



1:1

gebogen
 curved

Mikro-Ohrlöffel : Micro ear-spoons

Micro-curettes auriculaires : Micro-curetas auriculares

Micro-cucchiai auricolari



Sinus spoon

| | |
|---|-------------|
| 190mm – 7 ¹ / ₂ " | MS 15-33-01 |
|---|-------------|

9,5x4 mm angular bend, elongated



Sinus spoon

| | |
|---|-------------|
| 190mm – 7 ¹ / ₂ " | MS 15-34-01 |
|---|-------------|

6x3 mm forehead spoon, hard curved,



House

| | | |
|-------------|---|---|
| |  1:1 |  1:1 |
| | 1.0 mm Ø und 1.2 mm Ø | 1.5 mm Ø und 1.8 mm Ø |
| 150 mm – 6" | MS 15-45-01 | MS 15-50-01 |

Löffel, leicht gebogen
Spoon, slightly curved

Löffel, leicht gebogen
Spoon, slightly curves

1:1

| | | |
|--------------|---|---|
| House |  1:1 |  1:1 |
| | 1.0 mm Ø und 1.2 mm Ø | 1.5 mm Ø und 1.8 mm Ø |
| 150 mm – 6" | MS 15-35-01 | MS 15-40-01 |

Löffel stark gebogen
Spoon strong curved

Löffel stark gebogen
Spoon strong curves



1:1

Mikro-Ohrmeissel und Hämmer : *Micro ear-chisels and hammers*
Micro burins et marteaux auriculaires : Micro cincels y martillos para orejas
Micro scalpelli e martelli per orecchio

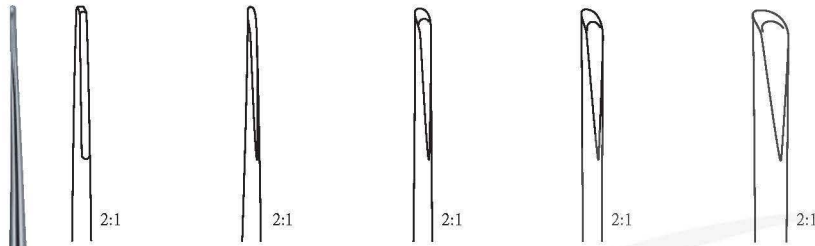

Heermann

| | | | | |
|--------------|-------------|-------------|-------------|-------------|
| 0.7 mm | 0.7 mm | 1.0 mm | 1.5 mm | 3.0 mm |
| MS 15-55-01 | MS 15-55-02 | MS 15-55-03 | MS 15-55-04 | MS 15-55-05 |
| Flachmeissel | Hohlmeissel | Hohlmeissel | Hohlmeissel | Hohlmeissel |



1:1



Heermann
MS 15-60-01



1:2

Heermann

| | |
|--|-------------|
| 195 mm – 7 ³ / ₄ " | MC 15-65-01 |
|--|-------------|

Hammer, Metall
Metal hammer



1:2

Cottle

| | |
|--|-------------|
| | 250 g |
| 190 mm – 7 ¹ / ₂ " | MH 15-70-01 |

Hammer, Metall
Metal hammer

Ohr raspatorien : Ear-raspatories
Raspateurs auriculaires : Raspatorias auriculares
Raspatori auricolari



Wullstein

| | | |
|----------------|-------------|-------------|
| 160mm – 6 1/4" | ER 15-20-01 | ER 15-21-01 |
|----------------|-------------|-------------|

| | |
|---------------------------|--------------------------|
| gerade <i>straight</i> | gebogen <i>curved</i> |
|---------------------------|--------------------------|



Rosen

| | | |
|--|--------|--------|
| | 2.5 mm | 1.5 mm |
|--|--------|--------|

| | | |
|-------------|-------------|-------------|
| 175 mm – 7" | ER 15-25-01 | ER 15-30-01 |
|-------------|-------------|-------------|

| | |
|---|---|
| bajonettförmig <i>bayonet shaped</i> | bajonettförmig <i>bayonet shaped</i> |
|---|---|

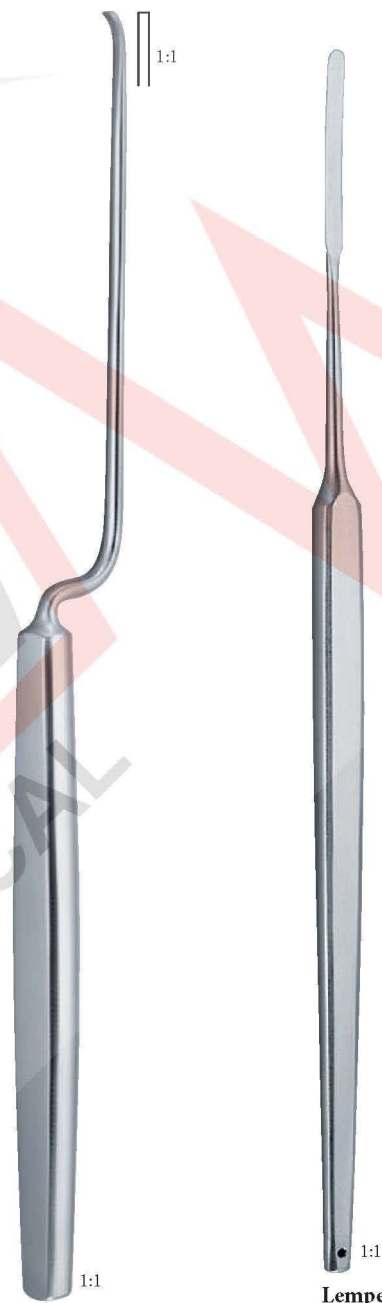

Lempert

| |
|-------------|
| ER 15-35-01 |
|-------------|

| |
|----------------|
| 160mm – 6 1/4" |
| 3.0 mm |

Ohr-Knochenstanzen : *Bone-rongeurs*

Rongeurs auriculaires : Pinzas osteótomos auriculares





Conchotomi auricolari



Citelli

| | |
|--|--|
| x = 60 mm | 170 mm – 6 ³ / ₄ ” |
|  1.5 mm | BR 15-10-01 |
|  2.2 mm | BR 15-10-02 |
|  3.0 mm | BR 15-10-03 |



| | | | | |
|-----------------|---|---|---|---|
| Kerrison |  |  |  |  |
| 200 mm – 8” | 3 x 3 mm | 4 x 4 mm | 5 x 5 mm | 6 x 6 mm |
| x = 80 mm | BR 15-15-01 | BR 15-15-02 | BR 15-15-03 | BR 15-15-04 |

SURGERY HNO – ENT

Ohr-Knochenstanzen : *Bone-rongeurs*

Rongeurs auriculaires : Pinzas osteótomos auriculares

Conchotomi auricolari

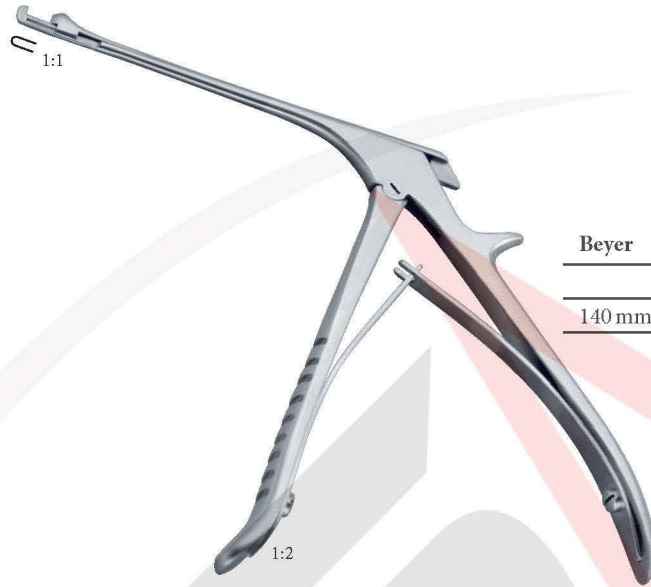

Beyer

| | |
|--|--------------------|
| | 1 mm |
| 140 mm – 5 ¹ / ₂ " | BR 15-20-01 |



Beyer

| | |
|--|--------------------|
| | 2 mm |
| 190 mm – 7 ¹ / ₂ " | BR 15-25-01 |

Bohrer : Burrs
Fraises : Brocas
Perforatori

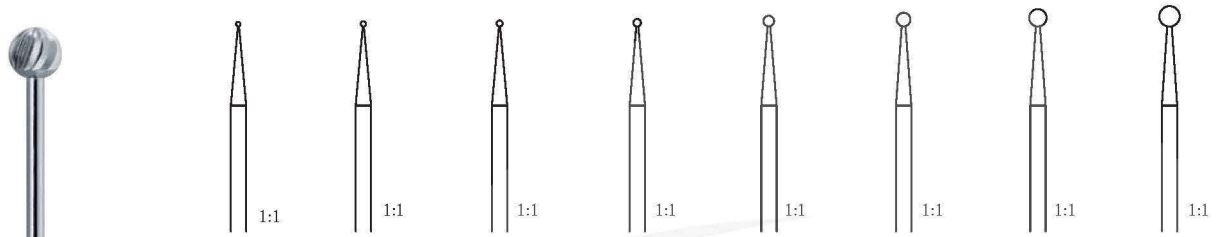

Rosen-Bohrer

| | 0.6 mm Ø | 0.7 mm Ø | 0.8 mm Ø | 1.0 mm Ø | 1.4 mm Ø | 1.8 mm Ø | 2.3 mm Ø | 2.7 mm Ø |
|---|-------------|-------------|-------------|-------------|-------------|-------------|-------------|-------------|
| 70 mm – 2 ³ / ₄ " | EB 15-10-01 | EB 15-10-02 | EB 15-10-03 | EB 15-10-04 | EB 15-10-05 | EB 15-10-06 | EB 15-10-07 | EB 15-10-08 |

„Rosen“-Bohrer, 70 mm lang, Schaft-Ø 2.35 mm, rostfrei
 “Rosen” burrs, 70 mm long, shank diameter 2.35 mm, stainless

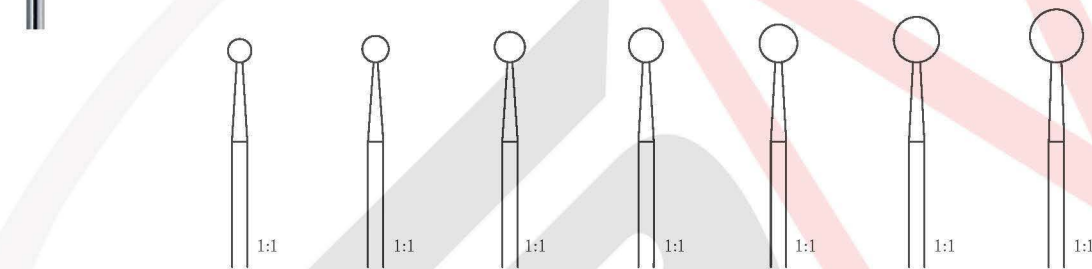

| | 3.1 mm Ø | 3.5 mm Ø | 4.0 mm Ø | 4.5 mm Ø | 5.0 mm Ø | 6.0 mm Ø | 7.0 mm Ø |
|---|-------------|-------------|-------------|-------------|-------------|-------------|-------------|
| 70 mm – 2 ³ / ₄ " | EB 15-10-09 | EB 15-10-10 | EB 15-10-11 | EB 15-10-12 | EB 15-10-13 | EB 15-10-14 | EB 15-10-15 |

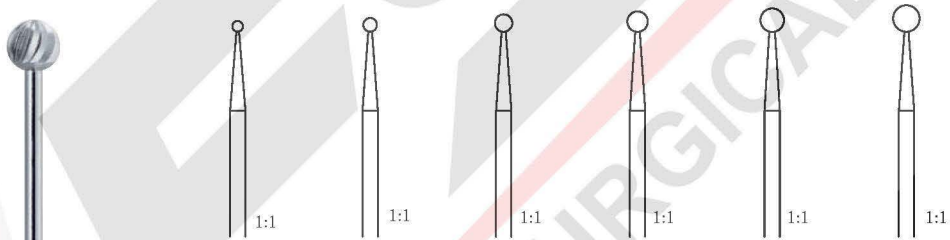

Rosen-Bohrer

| | 1.4 mm Ø | 1.8 mm Ø | 2.3 mm Ø | 2.7 mm Ø | 3.1 mm Ø | 3.5 mm Ø |
|---|-------------|-------------|-------------|-------------|-------------|-------------|
| 95 mm – 3 ³ / ₄ " | EB 15-15-01 | EB 15-15-02 | EB 15-15-03 | EB 15-15-04 | EB 15-15-05 | EB 15-15-06 |

„Rosen“-Bohrer, 95 mm lang, Schaft-Ø 2.35 mm, rostfrei
 “Rosen” burrs, 95 mm long, shank diameter 2.35 mm, stainless

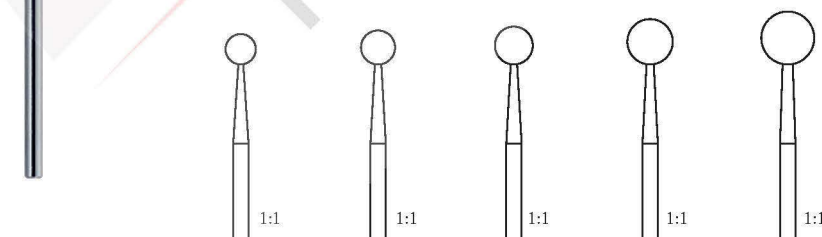

| | 4.0 mm Ø | 4.5 mm Ø | 5.0 mm Ø | 6.0 mm Ø | 7.0 mm Ø |
|---|-------------|-------------|-------------|-------------|-------------|
| 95 mm – 3 ³ / ₄ " | EB 15-15-07 | EB 15-15-08 | EB 15-15-09 | EB 15-15-10 | EB 15-15-11 |

Bohrer : Burrs

Fraises : Brocas

Perforatori

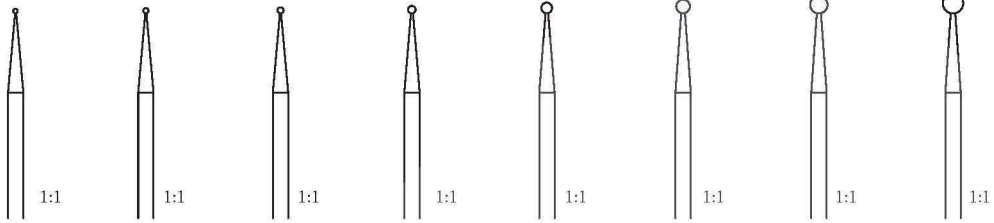

Diamant bohrer

| | 0.6 mm Ø | 0.7 mm Ø | 0.8 mm Ø | 1.0 mm Ø | 1.5 mm Ø | 1.8 mm Ø | 2.3 mm Ø | 2.7 mm Ø |
|---|-------------|-------------|-------------|-------------|-------------|-------------|-------------|-------------|
| 70 mm – 2 ³ / ₄ " | EB 15-20-01 | EB 15-20-02 | EB 15-20-03 | EB 15-20-04 | EB 15-20-05 | EB 15-20-06 | EB 15-20-07 | EB 15-20-08 |

Diamantbohrer, 70mm lang, Schaft-Ø 2.35 mm

Diamond dust polishing burrs, 70 mm long, shank diameter 2.35 mm

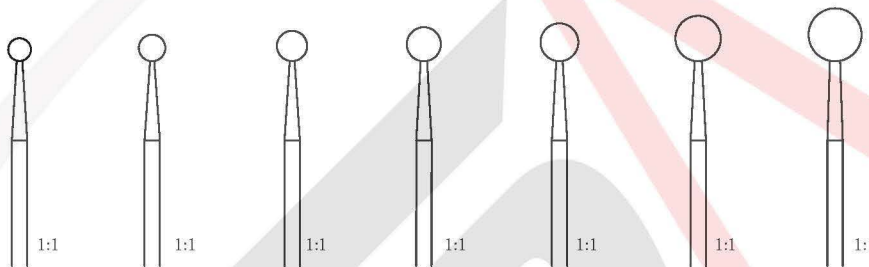

| | 3.0 mm Ø | 3.5 mm Ø | 4.0 mm Ø | 4.5 mm Ø | 5.0 mm Ø | 6.0 mm Ø | 7.0 mm Ø |
|---|-------------|-------------|-------------|-------------|-------------|-------------|-------------|
| 70 mm – 2 ³ / ₄ " | EB 15-20-10 | EB 15-20-11 | EB 15-20-12 | EB 15-20-13 | EB 15-20-14 | EB 15-20-15 | EB 15-20-16 |

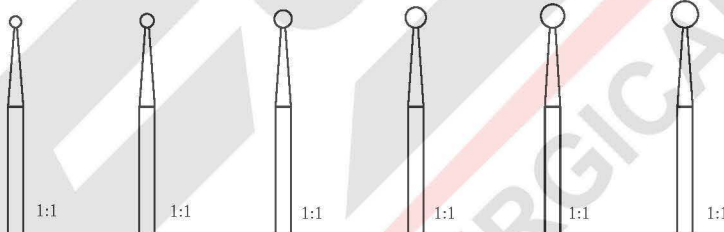

Diamant bohrer

| | 1.5 mm Ø | 1.8 mm Ø | 2.3 mm Ø | 2.7 mm Ø | 3.0 mm Ø | 3.5 mm Ø |
|---|-------------|-------------|-------------|-------------|-------------|-------------|
| 95 mm – 3 ³ / ₄ " | EB 15-25-01 | EB 15-25-02 | EB 15-25-03 | EB 15-25-04 | EB 15-25-05 | EB 15-25-06 |

Diamantbohrer, 95 mm lang, Schaft-Ø 2.35 mm

Diamond dust polishing burrs, 95 mm long, shank diameter 2.35 mm

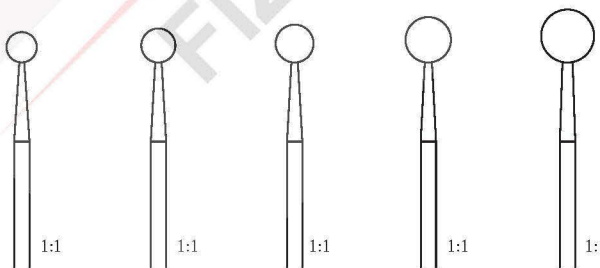

| | 4.0 mm Ø | 4.5 mm Ø | 5.0 mm Ø | 6.0 mm Ø | 7.0 mm Ø |
|---|-------------|-------------|-------------|-------------|-------------|
| 95 mm – 3 ³ / ₄ " | EB 15-25-07 | EB 15-25-08 | EB 15-25-09 | EB 15-25-10 | EB 15-25-11 |

SURGERY HNO – ENT

Nasenspekula : *Nasal specula*
Spéculums nasaux : Especulos nasales
Specoli nasali



**Thudichum
(Goldsmith)**

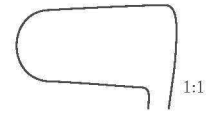
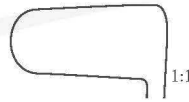

| | | | |
|----------------|----------------|-----------------|-----------------|
| | 21 mm x 9.5 mm | 21 mm x 10.5 mm | 21 mm x 11.5 mm |
| 65 mm – 2 1/2" | NS 15-10-01 | NS 15-10-02 | NS 15-10-03 |



Hartmann

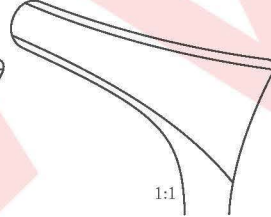
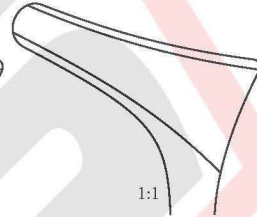
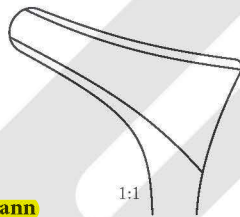

| | | | |
|-----------------|-------------|-------------|-------------|
| 160 mm – 6 1/4" | NS 15-15-01 | NS 15-15-02 | NS 15-15-03 |
|-----------------|-------------|-------------|-------------|



Hartmann-Halle

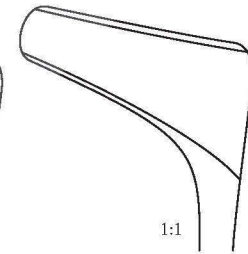
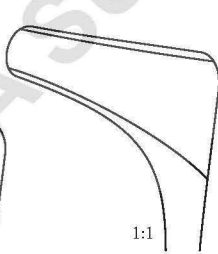
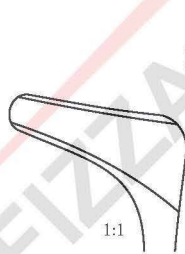

| | | | |
|-------------|-------------|-------------|-------------|
| 150 mm – 6" | NS 15-20-01 | NS 15-20-02 | NS 15-20-03 |
|-------------|-------------|-------------|-------------|

SURGERY HNO – ENT

Nasenspekula : Nasal specula
Spéculums nasaux : Especulos nasales
Specoli nasali



Tieck-Halle

135 mm – 5 1/4"

NS 15-25-01

für Säuglinge
for babies

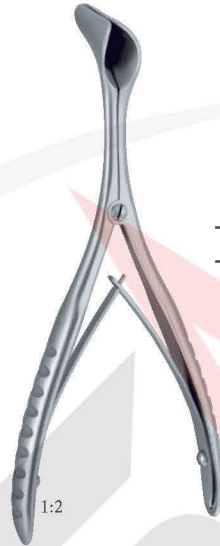
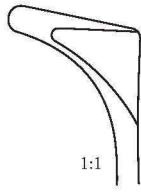

Schwarz

140 mm – 5 1/2"

NS 15-30-01

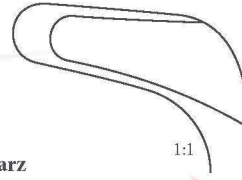

Killian

x = 35 mm
 130 mm – 5"

NS 15-35-01

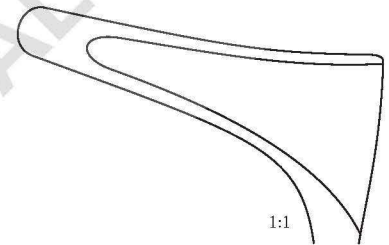

x = 50 mm

NS 15-35-02

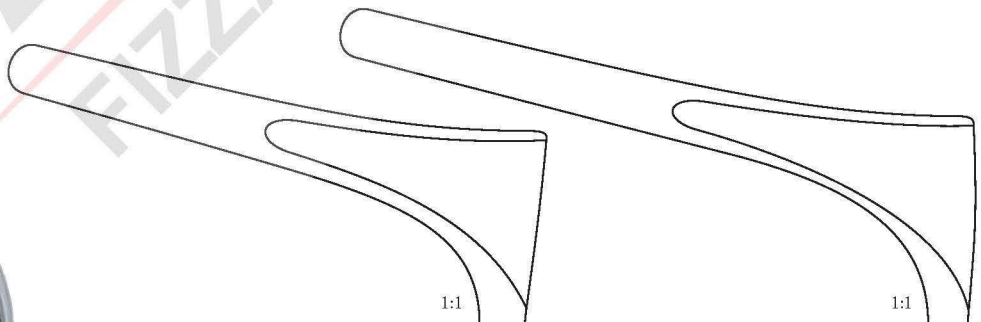

x = 75 mm

130 mm – 5"

NS 15-35-03

x = 90 mm

NS 15-35-04

SURGERY HNO – ENT

Nasenspekula : *Nasal specula*
Spéculums nasaux : Especulos nasales
Specoli nasali



Beckmann

150 mm – 6"

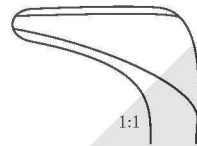

NS 15-40-01

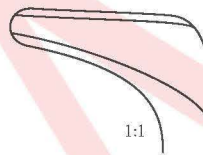

NS 15-40-02

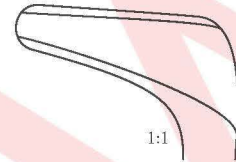

NS 15-40-03



Mod. Wien

145 mm – 5³/₄"

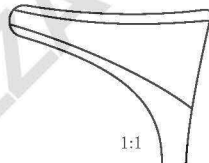

NS 15-45-01

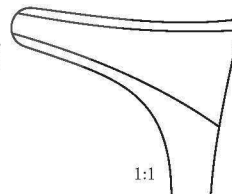

NS 15-45-02

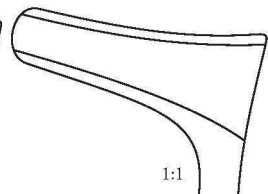

NS 15-45-03

SURGERY HNO – ENT

Nasenspekula : Nasal specula
Spéculum nasaux : Especulos nasales
Specoli nasali

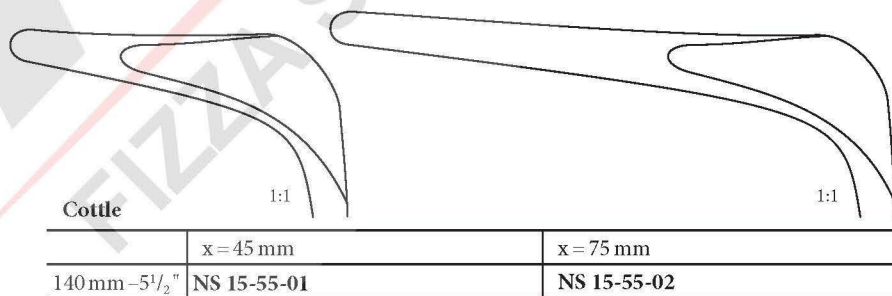
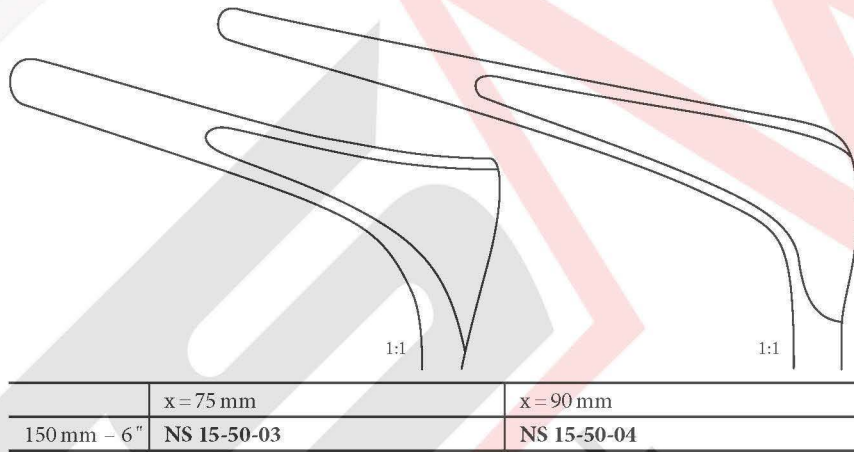
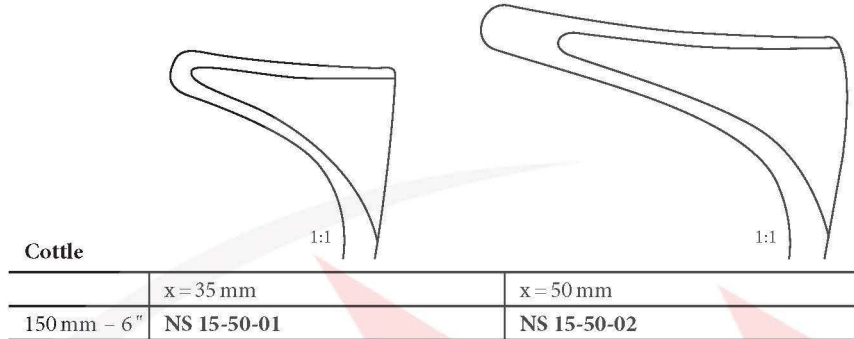

schwarz verchromt
black, chrome plated

SURGERY HNO – ENT

Nasenpolypenzangen – Septumzangen : Nasal polypus and septum forceps
Pinces à polypes et la cloison nasale : Pinzas para pólipos y el tabique nasal
Pinze per polipi e setto nasale



Westmacott

| | |
|-------------|-------------|
| 200 mm – 8" | NF 15-10-01 |
|-------------|-------------|

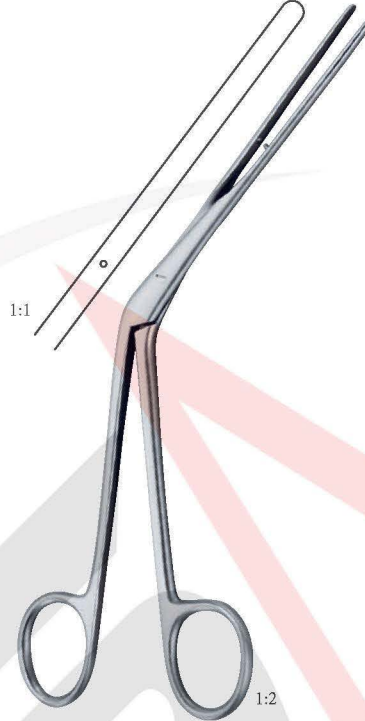

Lubet-Barbon

| | |
|-------------|-------------|
| 200 mm – 8" | NF 15-15-01 |
|-------------|-------------|



Hartmann

| | |
|--|-------------|
| 160 mm – 6 ¹ / ₄ " | NF 15-20-01 |
| 200 mm – 8" | NF 15-20-02 |

Nasentamponzange : Nasal dressing forceps
Pince à pansement pour le nez : Pinza nasale para tamponiamento
Pinza per tamponamento nasale

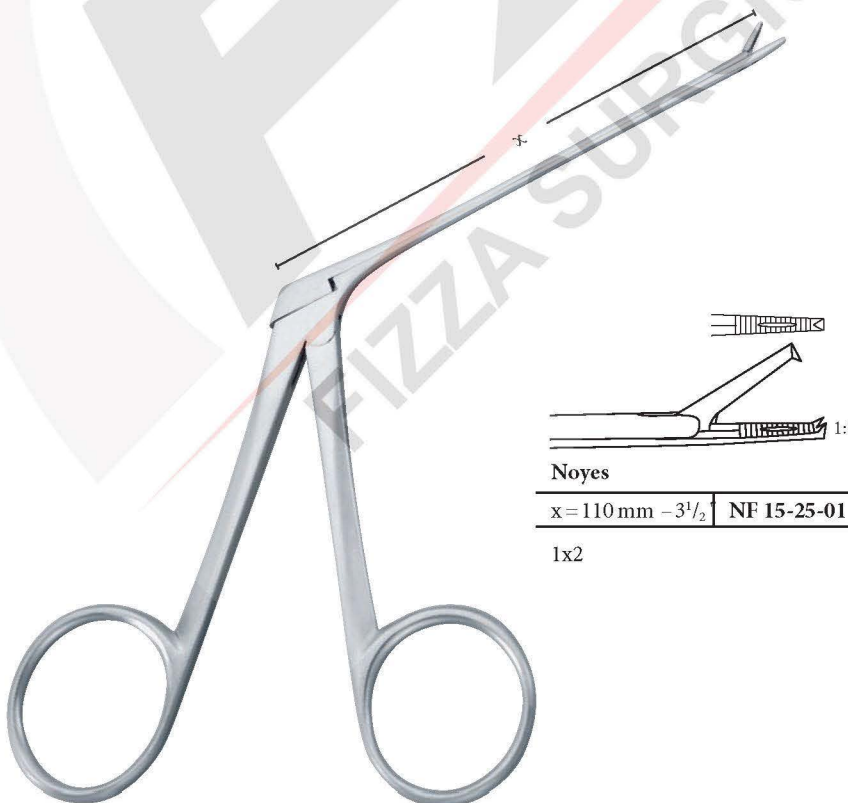

Noyes

| | |
|--|-------------|
| x = 110 mm – 3 ¹ / ₂ " | NF 15-25-01 |
|--|-------------|

 1x2

SURGERY HNO – ENT

Nasenpolypenzangen – Septumzangen : Nasal polypus and septum forceps
Pinces à polypes et la cloison nasale : Pinzas para pólipos y el tabique nasal
Pinze per polipi e setto nasale



Tilley

| | |
|--------------|-------------|
| 140 mm – 5½" | NF 15-20-01 |
|--------------|-------------|



HEymann-Knight

| | |
|-------------|-------------|
| 180 mm – 7" | NF 15-25-01 |
|-------------|-------------|



Craig

| | |
|-------------|-------------|
| 180 mm – 7" | NF 15-30-01 |
|-------------|-------------|

SURGERY HNO – ENT

Nasenpolypenzangen : *Nasal polypus*

Pinces à polypes nasales : *Pinzas para pólipos nasales*

Pinze per polipi nasali



Heymann



| | | | |
|-------------|-------------|-------------|-------------|
| 180 mm – 7" | NF 15-35-01 | NF 15-35-02 | NF 15-35-03 |
|-------------|-------------|-------------|-------------|

1:2



Littauer

| | |
|-------------|-------------|
| 180 mm – 7" | NF 15-40-01 |
|-------------|-------------|

1:2



Knight

| | |
|-------------|-------------|
| 180 mm – 7" | NF 15-45-01 |
|-------------|-------------|

1:2

SURGERY HNO – ENT

Scharfe Nasenzangen : *Nasal cutting forceps*

Pincers coupantes pour le nez : Pinzas nasales cortantes

Pinze taglianti per naso



| Luc | 1:1 | | 1:1 | |
|-------------|----------------------------------|-------------|-----------------------|-------------|
| | Fig. 1 | Fig. 2 | Fig. 1 | Fig. 2 |
| 200 mm – 8" | NF 15-50-01 | NF 15-50-02 | NF 15-51-01 | NF 15-51-02 |
| | gefenstert <i>fenestrated</i> | | voll <i>plaine</i> | |

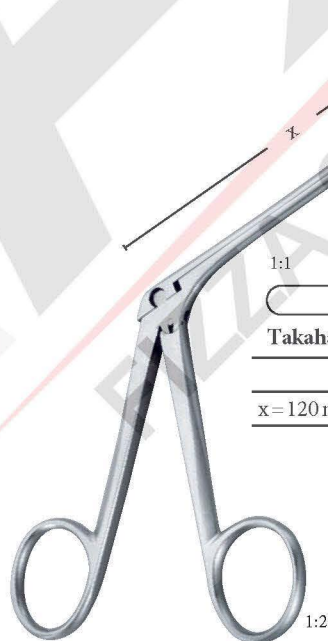

| Takahashi | | |
|--|----------------|----------------|
| 1:1 | 1:1 | 1:1 |
| | 3.5 mm x 10 mm | 3.5 mm x 10 mm |
| x = 120 mm – 4 ³ / ₄ " | NF 15-55-01 | NF 15-55-02 |

SURGERY HNO – ENT

Scharfe Nasenzangen : *Nasal cutting forceps*

Pinces coupantes pour le nez : Pinzas nasales cortantes

Pinze taglienti per naso



Bruenings

190 mm – 7½"



NF 15-60-01



NF 15-60-02



NF 15-60-03

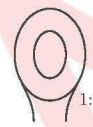

NF 15-60-04



x=120mm – 4¾"

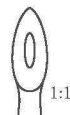

Weil

NF 15-65-01

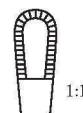

Watson-Williams

NF 15-65-02



NF 15-65-03

SURGERY HNO - ENT

Scharfe Nasenzangen : Nasal cutting forceps

Pinces coupantes pour le nez : Pinzas nasales cortantes

Pinze taglienti per naso

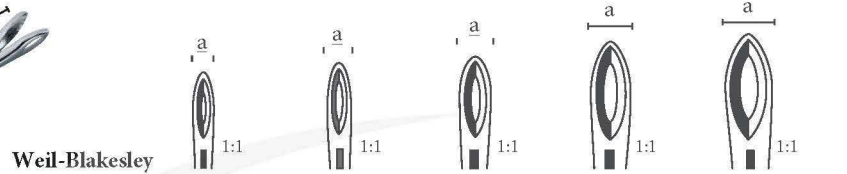
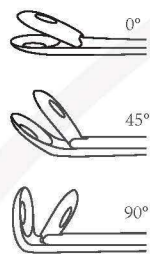

| Weil-Blakesley | | | | | |
|--|-------------|-------------|-------------|-------------|-------------|
| | Fig. 1 | Fig. 2 | Fig. 3 | Fig. 4 | Fig. 5 |
| | a=3.0 mm | a=3.6 mm | a=4.2 mm | a=4.8 mm | a=5.8 mm |
| x=120 mm - 4 ³ / ₄ " | NF 15-70-01 | NF 15-70-02 | NF 15-70-03 | NF 15-70-04 | NF 15-70-05 |

| | | | | | |
|--|-------------|-------------|-------------|-------------|--|
| x=120 mm - 4 ³ / ₄ " | NF 15-71-01 | NF 15-71-02 | NF 15-71-03 | NF 15-71-04 | |
|--|-------------|-------------|-------------|-------------|--|

| | | | | | |
|--|-------------|-------------|-------------|--|--|
| x=120 mm - 4 ³ / ₄ " | NF 15-72-01 | NF 15-72-02 | NF 15-72-03 | | |
|--|-------------|-------------|-------------|--|--|

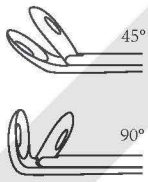

| | Fig. 1 | Fig. 2 | Fig. 3 | Fig. 4 | Fig. 5 |
|--|----------|----------|----------|----------|----------|
| | a=3.0 mm | a=3.6 mm | a=4.2 mm | a=4.8 mm | a=5.8 mm |

| | | | | | |
|---------------|-------------|-------------|-------------|-------------|-------------|
| x=180 mm - 7" | NF 15-73-01 | NF 15-73-02 | NF 15-73-03 | NF 15-73-04 | NF 15-73-05 |
|---------------|-------------|-------------|-------------|-------------|-------------|

| | | | | | |
|---------------|-------------|-------------|-------------|-------------|--|
| x=180 mm - 7" | NF 15-74-01 | NF 15-74-02 | NF 15-74-03 | NF 15-74-04 | |
|---------------|-------------|-------------|-------------|-------------|--|

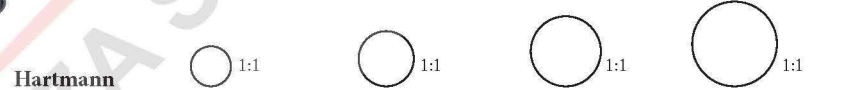

| Hartmann | | | | |
|--|-------------|-------------|-------------|-------------|
| x=120 mm - 4 ³ / ₄ " | NF 15-75-01 | NF 15-75-02 | NF 15-75-03 | NF 15-75-04 |

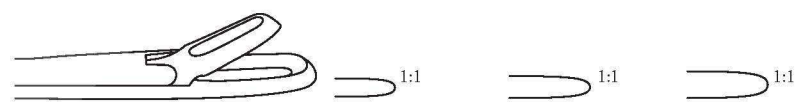

| Myles | | | |
|--|---------------|---------------|---------------|
| | Fig. 1 | Fig. 2 | Fig. 3 |
| | 2.0 x 10.0 mm | 2.5 x 12.0 mm | 3.0 x 14.0 mm |
| x=120 mm - 4 ³ / ₄ " | NF 15-80-01 | NF 15-80-02 | NF 15-80-03 |



Mackay-Gruenwald
x=130 mm - 4³/₄" | **NF 15-76-01**

FS
FIZZA SURGICAL

SURGERY HNO - ENT

Scharfe Nasenzangen : *Nasal cutting forceps*

Pincès coupantes pour le nez : *Pinzas nasales cortantes*

Pinze taglienti per naso



Schmeden

x = 120 mm - 4³/₄"



1:1

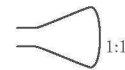

1:1



1:1

| | | | |
|--|-------------|-------------|-------------|
| | NF 15-85-01 | NF 15-85-02 | NF 15-85-03 |
|--|-------------|-------------|-------------|



Tomati

x = 120 mm - 4³/₄" NF 15-90-01

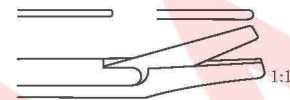

Struycken

| | | |
|--|-------------|-------------|
| | 0.9 mm | 1.2 mm |
| x = 120 mm - 4 ³ / ₄ " | NF 15-95-01 | NF 15-95-02 |



Henke

x = 120 mm - 4³/₄" NF 15-100-01

Nasenschere : *Nasal scissors*

Ciseaux nasales : *Tijera nasal*

Forbice nasale

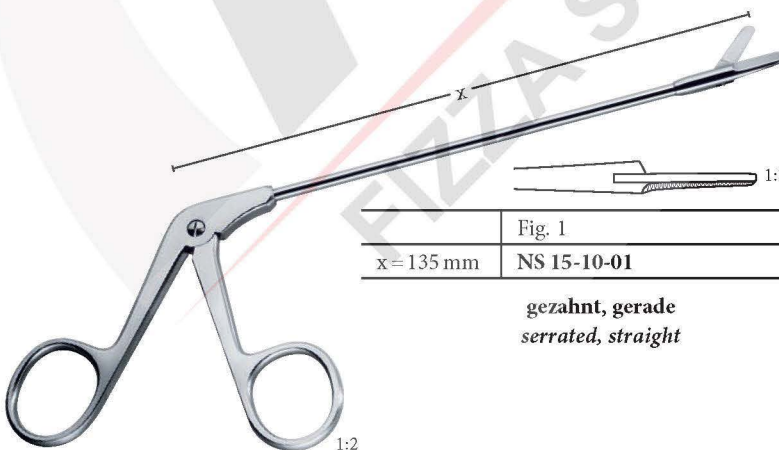

Fig. 1

NS 15-10-01

gezahnt, gerade
serrated, straight



Fig. 2

NS 15-10-02

gezahnt, rechts
serrated, right



Fig. 3

NS 15-10-03

gezahnt, links
serrated, left

| | | | |
|------------|-------------|-------------|-------------|
| x = 135 mm | NS 15-10-01 | NS 15-10-02 | NS 15-10-03 |
|------------|-------------|-------------|-------------|

SURGERY HNO – ENT

Scharfe Nasenzangen : Nasal cutting forceps
Pinces coupantes pour le nez : Pinzas nasales cortantes
Pinze taglienti per naso

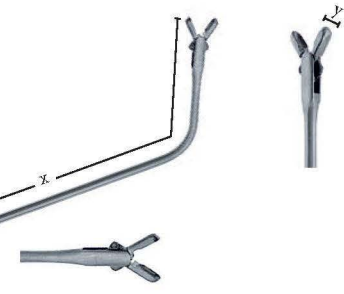

| | |
|-----------------|--------------|
| | y = 3 mm |
| x = 100 mm – 4" | NF 15-105-01 |

gerade vertikal, doppelt beweglich
straight vertical, double action



| | |
|-----------------|--------------|
| | y = 3 mm |
| x = 100 mm – 4" | NF 15-105-02 |

gerade hor., doppelt beweglich
straight hor., double action



| | |
|-----------------|--------------|
| | y = 3 mm |
| x = 100 mm – 4" | NF 15-105-03 |

gerade hor., einfach beweglich, kurz
straight hor., single action, short



| | |
|-----------------|--------------|
| | y = 3 mm |
| x = 100 mm – 4" | NF 15-105-04 |

45° vertikal, doppelt beweglich
45° vertical, double action



| | |
|-----------------|--------------|
| | y = 3 mm |
| x = 100 mm – 4" | NF 15-105-05 |

45° hor., doppelt beweglich
45° hor., double action



| | |
|-----------------|--------------|
| | y = 3 mm |
| x = 100 mm – 4" | NF 15-105-06 |

45° vert., einfach beweglich, kurz
45° vert., single action, short



| | |
|-----------------|--------------|
| | y = 3 mm |
| x = 100 mm – 4" | NF 15-105-07 |

70° vertikal, doppelt beweglich
70° vertical, double action



| | |
|-----------------|--------------|
| | y = 3 mm |
| x = 100 mm – 4" | NF 15-105-08 |

70° hor., doppelt beweglich
70° hor., double action



| | |
|-----------------|--------------|
| | y = 3 mm |
| x = 100 mm – 4" | NF 15-105-09 |

110° hor., doppelt beweglich
110° hor., double action

| | |
|-----------------|--------------|
| | y = 3 mm |
| x = 100 mm – 4" | NF 15-105-10 |

70° vert., einfach beweglich, kurz
70° vert., single action, short

| | |
|-----------------|--------------|
| | y = 3 mm |
| x = 100 mm – 4" | NF 15-105-11 |

70° hor., einfach beweglich
70° hor., single action

Scharfe Nasenzangen : Nasal cutting forceps
Pincés coupantes pour le nez : Pinzas nasales cortantes
Pinze taglianti per naso

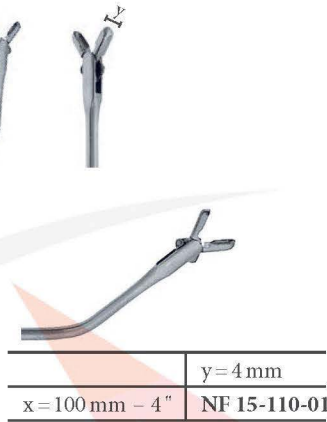

45° vertikal, doppelt beweglich
 45° vertical, double action

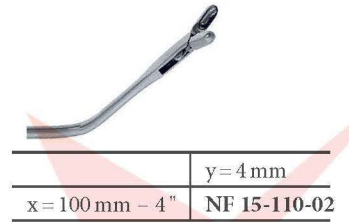

45° hor., doppelt beweglich, kurz
 45° hor., double action, short



45° vertikal, einfach beweglich, kurz
 45° vertical, single action, short short

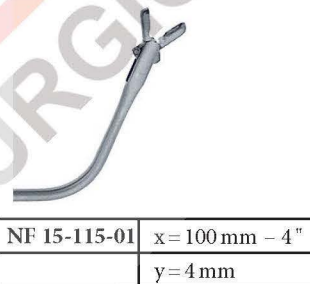

70° vertikal, doppelt beweglich
 70° vertical, double action

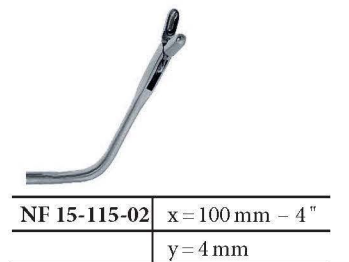

70° hor., doppelt beweglich, kurz
 70° hor., double action, short

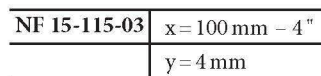

70° vertikal, einfach beweglich, kurz
 70° vertical, single action, short short

SURGERY HNO - ENT

Zirkular Stanze : *Circular forceps*

Pince circulaire : *Pinza circular*

Pinza a taglio circolare

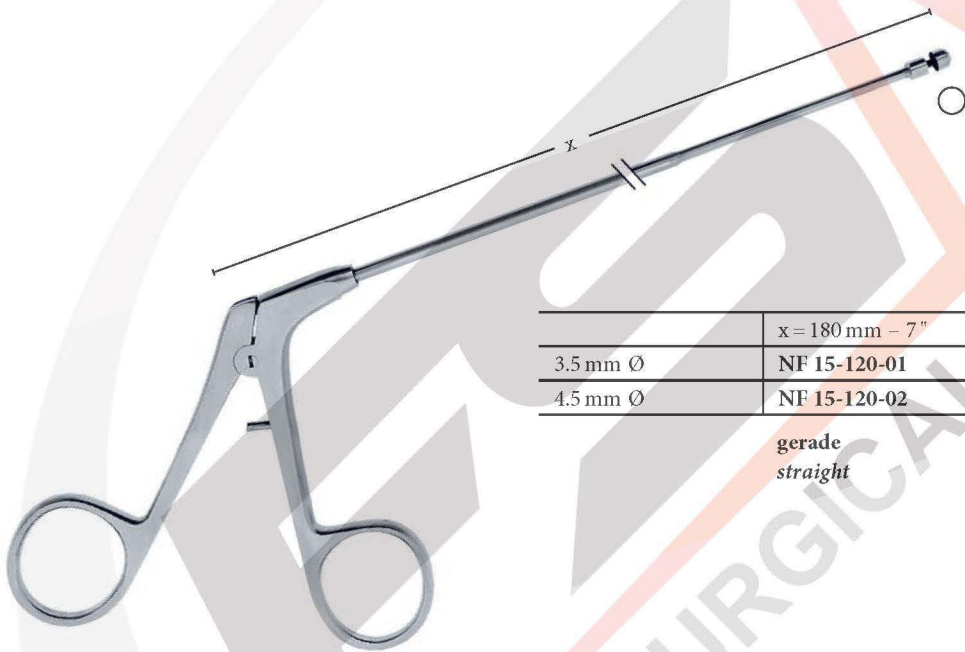

| | | |
|----------|-----------------|-----------------|
| | x = 180 mm - 7" | x = 180 mm - 7" |
| 3.5 mm Ø | NF 15-120-01 | NF 15-120-01 |
| 4.5 mm Ø | NF 15-120-02 | NF 15-120-02 |

gerade
straight

aufgebogen
curved upwards

SURGERY HNO - ENT

Antrumstanze : Antrum punch

Pince pour l'antrum : Pinza antrum

Pinze antrum

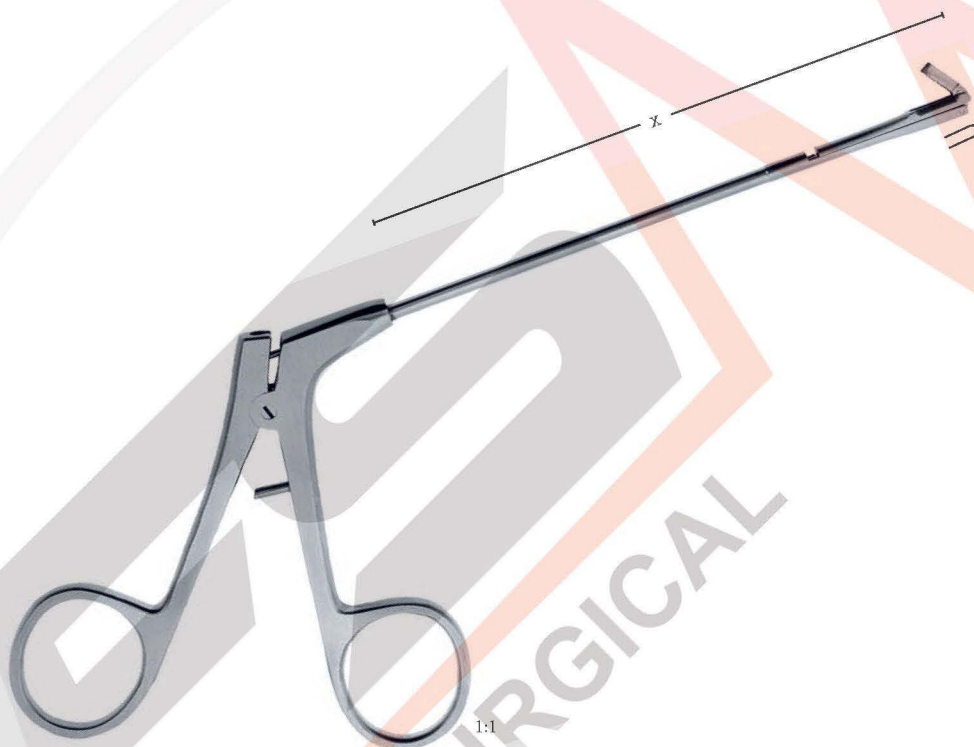

Ostrum

| | | | |
|-----------------|--|--|--|
| x = 100 mm | Fig. 1 | Fig. 2 | Fig. 3 |
| 1.5 mm x 4.5 mm | AP 15-10-01 | AP 15-10-02 | AP 15-10-03 |
| | rückwärts nach oben schneidend backward, up-cutting | rückwärts nach rechts schneidend backward, cut to the right | rückwärts nach links schneidend backward, cut to the left |

SURGERY HNO – ENT

Keilbeinstanzen : Punches sphenoid bone

Pinces pour le sinus sphénoïdal : Pinzas para esfenoides

Pinze sfenoidali taglienti



| Hajek | Hajek-Kofler |
|---------------------|---------------------|
| x = 140 mm – 5 1/2" | x = 140 mm – 5 1/2" |
| 4 mm x 4 mm | 3.5 mm x 3.5 mm |
| PB 15-10-01 | PB 15-10-02 |

| Hajek | Hajek-Kofler |
|---------------------|---------------------|
| x = 140 mm – 5 1/2" | x = 140 mm – 5 1/2" |
| 4 mm x 4 mm | 3.5 mm x 3.5 mm |
| PB 15-15-01 | PB 15-15-02 |

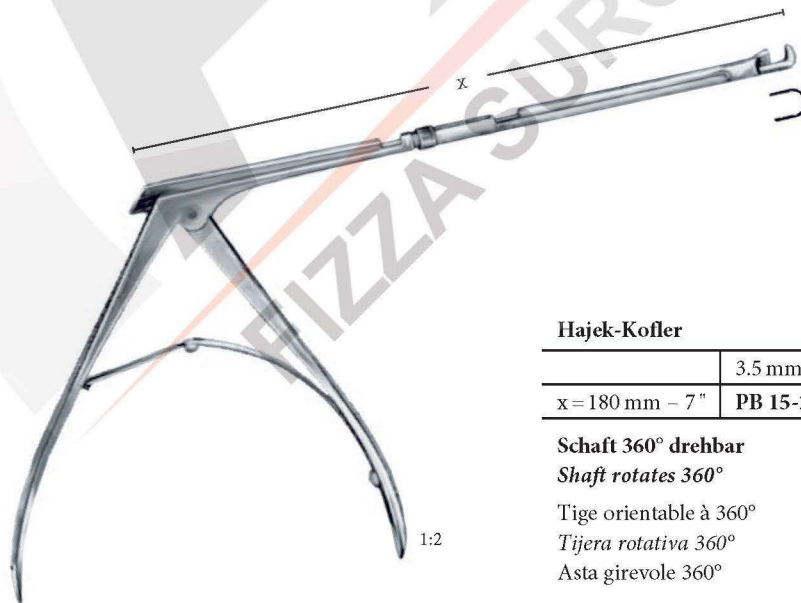

| Hajek-Kofler | |
|-----------------|--------------------|
| | 3.5 mm |
| x = 180 mm – 7" | PB 15-20-01 |

Schaft 360° drehbar

Shaft rotates 360°

Tige orientable à 360°

Tijera rotativa 360°

Asta girevole 360°

SURGERY HNO – ENT

Keilbeinstanzen : *Punches sphenoid bone*

Pinces pour sinus sphénoïdal : Pinzas para esfenoides

Pinze sfenoidali taglienti



Hajek-Claus

200 mm – 8"

PB 15-25-01



Kerrison

x = 90 mm – 3 1/2"

200 mm – 8"

4 mm x 4 mm

5 mm x 5 mm

6 mm x 6 mm

PB 15-30-01

PB 15-30-02

PB 15-30-03

SURGERY HNO – ENT

Nasenpolypenschnürer : *Nasal polypus snares*
 Serre noeuds pour polypes : *Polipótomos nasales*
 Serranodi nasali



| | |
|-------------------|-------------|
| 0.3 mm Ø x 100 mm | NP 15-10-01 |
|-------------------|-------------|

in Bündeln mit 12 Stück
in bundles of 12 pieces



Krause

| | |
|---|-------------|
| 260 mm – 10 ¹ / ₄ " | NP 15-15-01 |
|---|-------------|



Krause-Voss

| | |
|---|-------------|
| 260 mm – 10 ¹ / ₄ " | NP 15-20-01 |
|---|-------------|

mit 2 Aufsätzen
with 2 inserts



Lange-Wilde

| | |
|--|-------------|
| 240 mm – 9 ¹ / ₂ " | NP 15-25-01 |
|--|-------------|

SURGERY HNO – ENT

Nasenmesser : *Nasal knives*

Bistouris pour nez : *Cuchillos nasales*

Bisturi per naso



Fomon

165 mm – 6 1/2"

NK 15-10-01

1:2



1:2

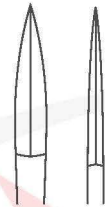

1:1



1:1



1:1



1:1

Joseph

| | Fig. 1 | Fig. 2 | Fig. 1 | Fig. 2 |
|-----------------|-------------|-------------|-------------|-------------|
| 160 mm – 6 1/4" | NK 15-15-01 | NK 15-15-02 | NK 15-15-03 | NK 15-15-04 |

scharf/spitz
sharp/sharp

gerade
straight

gebogen
curved

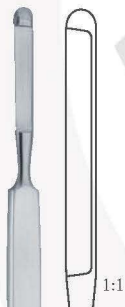

1:2

Joseph

140 mm – 5 1/2"

NK 15-20-01

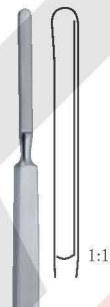

1:2

Cottle

150 mm – 6"

NK 15-25-01



1:2

Joseph

175 mm – 7"

NK 15-30-01



1:2

Bruenings

165 mm – 6 1/2"

NK 15-35-01

NK 15-40-01

Ersatzklinge
Spare blade

SURGERY HNO - ENT

Nasennmesser : *Nasal knives*

Bistouris pour nez : *Cuchillos nasales*

Bisturi per naso

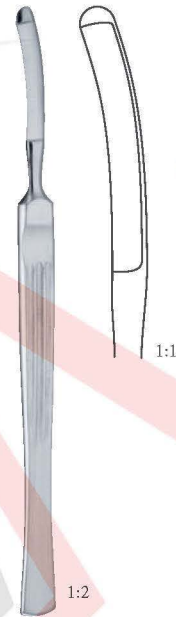

Freer

| | | |
|-----------------|-------------|-------------|
| 190 mm - 6 1/2" | NK 15-45-01 | NK 15-46-01 |
|-----------------|-------------|-------------|

Converse

| | |
|-----------------|-------------|
| 160 mm - 6 1/4" | NK 15-50-01 |
|-----------------|-------------|



Freer

| | |
|-------------|-------------|
| 150 mm - 6" | NK 15-55-01 |
|-------------|-------------|



Freer

| | |
|-------------|-------------|
| 150 mm - 6" | NK 15-60-01 |
|-------------|-------------|



Freer

| | |
|-------------|-------------|
| 150 mm - 6" | NK 15-65-01 |
|-------------|-------------|

SURGERY HNO - ENT

Tonsillenmesser : *Tonsil knives*

Couteaux à tonsils : *Bisturis para amigdales*

Bisturi per tonsille



1:2



1:2



1:2

Freer

| | | |
|---|-------------|-------------|
| 210mm - 8 ¹ / ₄ " | TK 15-10-01 | TK 15-10-02 |
|---|-------------|-------------|

200 mm - 8"

TK 15-15-01

Sichelmesser

Sickle knife



1:2

Bruenings

230 mm - 9"

TK 15-20-01



1:2

Abraham

220 mm - 8³/₄"

TK 15-25-01



1:2

Fischer

230 mm - 9"

TK 15-30-01



1:1



1:2

200 mm - 8"

TK 15-35-01

scharf
sharp

SURGERY HNO – ENT

Antrumküretten : Antrum curettes

Curettes d'antrum : Curetas para el antrum

Curette per antrum

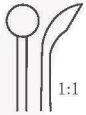

1:1



1:1

200 mm – 8"

AC 15-10-01

200 mm – 8"

AC 15-10-02



1:1

200 mm – 8"

7mmx11mm

AC 15-15-01



1:1

1:2



1:1

Pratt

210 mm – 8¹/₄"

AC 15-20-01



1:1

1:2



1:1

Faulkner

210 mm – 8¹/₄"

AC 15-25-01

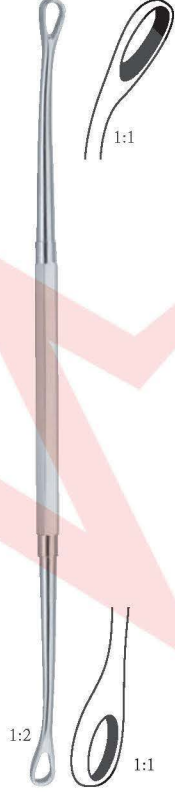

1:1

1:2



1:1

Coakley

200 mm – 8"

AC 15-30-01



1:2

Coakley



1:1



1:1

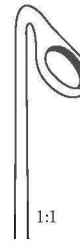

1:1



1:1



1:1



1:1

| | Fig. 1 | Fig. 2 | Fig. 3 | Fig. 4 | Fig. 5 | Fig. 6 |
|--|-------------|-------------|-------------|-------------|-------------|-------------|
| 170 mm – 6 ³ / ₄ " | AC 15-35-01 | AC 15-35-02 | AC 15-35-03 | AC 15-35-04 | AC 15-35-05 | AC 15-35-06 |
| AC 15-35-00 | x | x | x | x | x | x |

Satz
Set

Septumlevatorien – Raspatorien : *Septum elevators – raspatories*
Elevadores – legras para el tabique nasal : *Elevatori – periostotomi per setto*
Elevateurs – rugines pour la cloison nasale

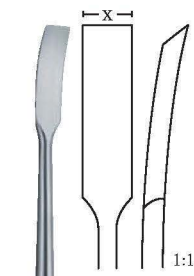

x

1:1



1:2

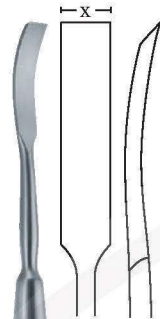

x

1:1



1:2

Lempert

| | | |
|----------|-------------|-------------|
| | 205 mm – 8" | 180 mm – 7" |
| x = 6 mm | SE 15-10-01 | SE 15-10-02 |



x

1:1



1:2

Freer

| | |
|-----------------|-------------|
| | x = 4 mm |
| 160 mm – 6 1/4" | SE 15-15-01 |



1:1



1:2

Cottle

| | |
|-----------------|-------------|
| | x = 8 mm |
| 190 mm – 7 1/2" | SE 15-20-01 |

scharf
sharp



x

1:1



1:2

Joseph

| | |
|-----------------|-------------|
| | x = 5 mm |
| 160 mm – 6 1/4" | SE 15-25-01 |

Periost Elevatorien
Periostal elevators



4 mm

1/2



1/2

Joseph

| | |
|----------------|-------------|
| | x = 4 mm |
| 165 mm, 6 1/2" | SE 15-26-01 |



Sewall

| | |
|-------------|-------------|
| 200 mm - 8" | SE 15-30-01 |
|-------------|-------------|

Antrum Elevatorium
Antrum Elevator



Halle

| | |
|-------------|-------------|
| 180 mm - 7" | SE 15-35-01 |
|-------------|-------------|

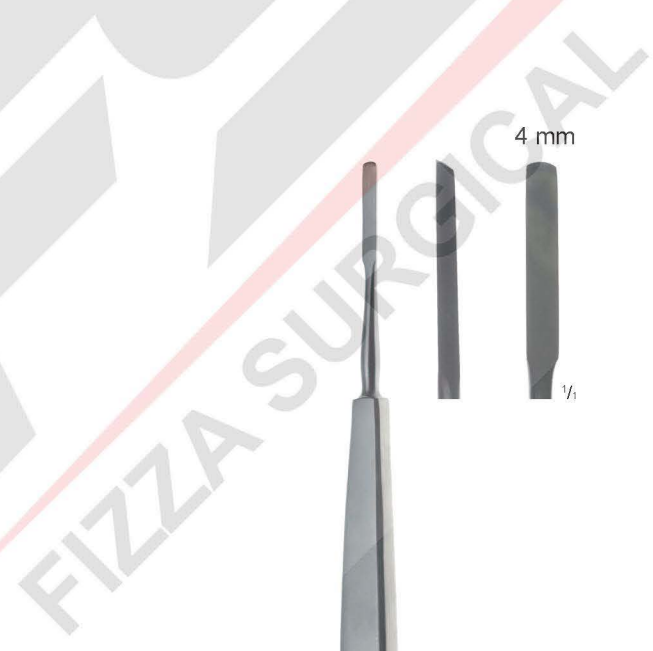

FOMON

| | |
|----------------|-------------|
| 170 mm, 6 3/4" | SE 15-35-01 |
|----------------|-------------|

LEMPERT

| | |
|----------------|-------------|
| 185 mm, 7 1/4" | SE 15-35-01 |
|----------------|-------------|

Septumelevatorien – Raspatorien : *Septum elevators – raspatories*
Elevadores – legras para el tabique nasal : *Elevatori – periostotomi per setto*
Elevateurs – rugines pour la cloison nasale

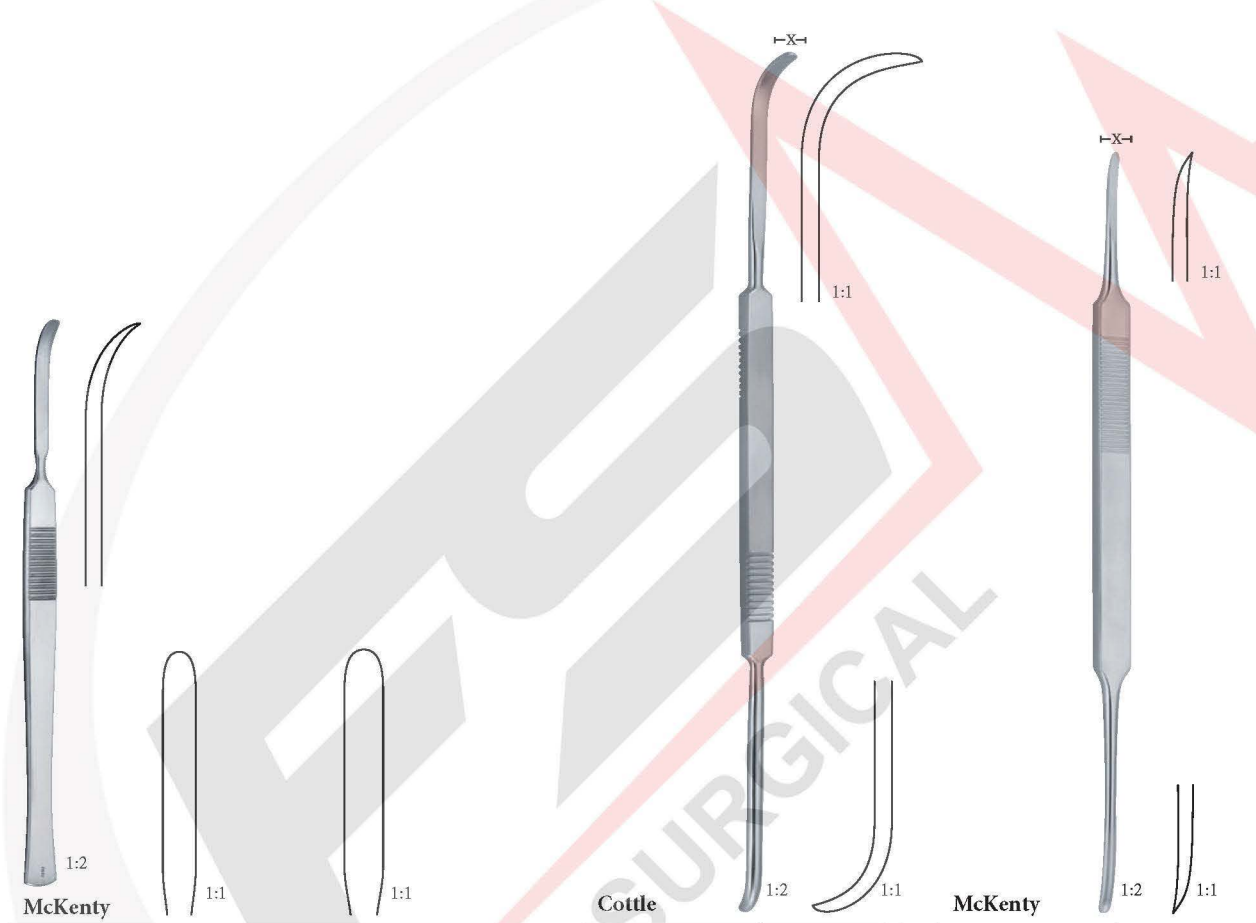

McKenty

| | | |
|-------------|-------------|-------------|
| | 4 mm | 5 mm |
| 150 mm – 6" | SE 15-40-01 | SE 15-40-02 |

scharf
sharp

Cottle

| | |
|-----------------|-------------|
| | x = 5 mm |
| 235 mm – 9 1/4" | SE 15-45-01 |

scharf
sharp









McKenty

| | |
|-------------|-------------|
| | x = 4 mm |
| 205 mm – 8" | SE 15-50-01 |

scharf
sharp

Septumelevatorien – Raspatorien : Septum elevators – raspatories
Elevadores – legras para el tabique nasal : Elevatori – periostotomi per setto
Elevateurs – rugines pour la cloison nasale



| | | | | | | | | | | | |
|------------------------------|---|---|------------------------------|---|---|-----------------|---|---|--------------|---|---|
| Killian |  1:2 |  1:1 | Killian |  1:2 |  1:1 | Freer |  1:2 |  1:1 | Freer |  1:2 |  1:1 |
| 180 mm – 7" | x = 4 mm | SE 15-55-01 | 230 mm – 9" | x = 4.5 mm | SE 15-60-01 | 190 mm – 7½" | SE 15-65-01 | SE 15-70-01 | 180 mm – 7" | SE 15-70-01 | |
| scharf/stumpf sharp/blunt | | | scharf/stumpf sharp/blunt | | | stumpf blunt | | scharf/stumpf sharp/blunt | | | |

SURGERY HNO – ENT

Septum elevator – Raspatorien : Septum elevators – raspatories
Elevadores – legras para el tabique nasal : Elevatori – periostotomi per setto
Elevateurs – rugines pour la cloison nasale



Freer
205 mm – 8" | SE 15-75-01

scharf/stumpf
sharp/blunt



Freer
195 mm – 7³/₄" | SE 15-76-01

scharf/stumpf
sharp/blunt



Pennington
215 mm – 8¹/₂" | SE 15-80-01

stumpf
blunt



Joseph-Masing
215 mm – 8¹/₂" | SE 15-85-01

scharf
sharp

SURGERY HNO – ENT

Periostelevatorien : Periosteal elevators

Elevateurs pour la périoste : Legras para periostio

Elevatori per il periosto

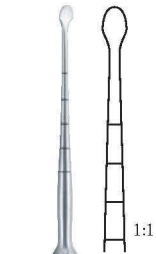

1:1

Masing

| | |
|-------------|-------------|
| 200 mm – 8" | PE 15-10-01 |
|-------------|-------------|



1:2



1:1

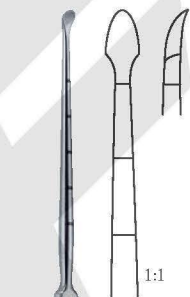

1:1

Cottle

| | |
|--|-------------|
| 220 mm – 8 ³ / ₄ " | PE 15-20-01 |
|--|-------------|



1:2



1:1



Ballenger-Hajek

| | |
|--|-------------|
| 190 mm – 7 ¹ / ₄ " | PE 15-15-01 |
|--|-------------|

| | |
|--|-------------|
| 220 mm – 8 ³ / ₄ " | PE 15-15-02 |
|--|-------------|



1:1

Cottle

| | |
|--|-------------|
| 210 mm – 8 ¹ / ₄ " | PE 15-25-01 |
|--|-------------|

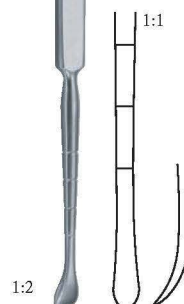

1:2



1:1

SURGERY HNO – ENT

Septumelevatorien : *Septum elevators*

Elevateurs pour la cloison nasale : *Elevadores para el tabique nasal*

Elevatori per setto



1:2

Boies

| | |
|--------------|-------------|
| 190 mm – 7½" | SE 15-90-01 |
|--------------|-------------|

Nasenfraktur Elevatorium, stumpf
Nasal fracture elevator, blunt



1:2

Goldman

| | |
|--------------|-------------|
| 170 mm – 6¾" | SE 15-95-01 |
|--------------|-------------|

Septumfraktur Elevatorium
Septum displacer



Watson-Cheyne

| | |
|--------------|--------------|
| 130 mm – 5" | 190 mm – 7½" |
| SE 15-100-01 | SE 15-101-01 |

Raspatorium
Raspatory



SURGERY HNO – ENT

Nasensägen : Nasal saws
 Scies nasales : Sierras nasales
 Seghe nasali



Joseph

| | |
|--|--|
| 190 mm – 7 ¹ / ₂ ” | 190 mm – 7 ¹ / ₂ ” |
| NS 15-100-01 | NS 15-100-02 |



Joseph

| |
|--|
| 190 mm – 7 ¹ / ₂ ” |
| NS 15-105-01 |

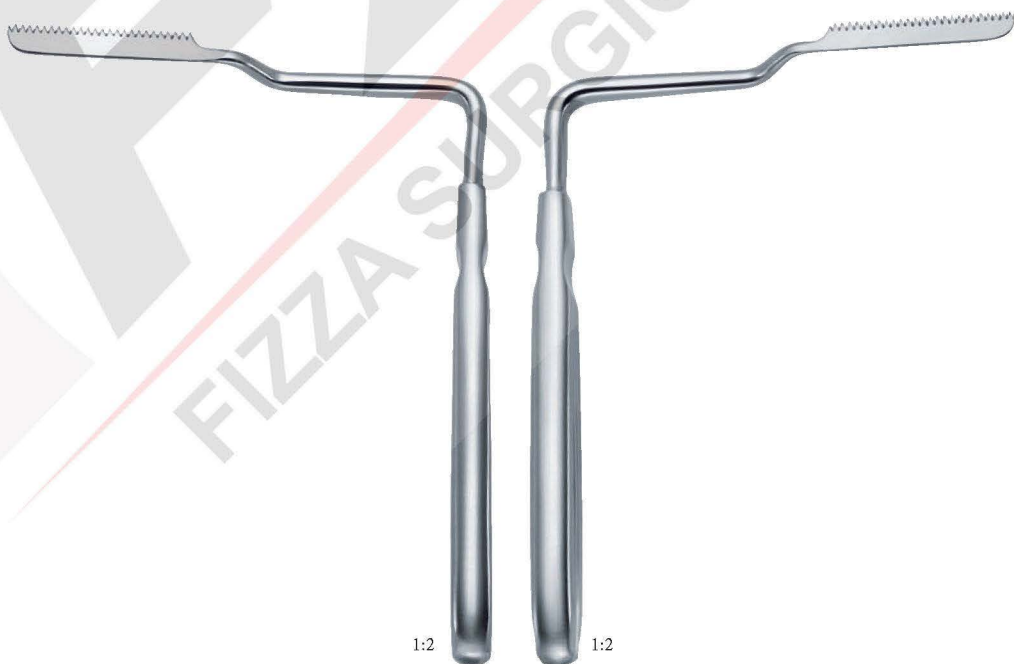

Joseph

| | |
|--|--|
| 170 mm – 6 ³ / ₄ ” | 170 mm – 6 ³ / ₄ ” |
| NS 15-110-01 | NS 15-111-01 |

Nasenraspeln : *Nasal rasps*
 Râpes nasales : *Limas nasales*
 Raspe nasali

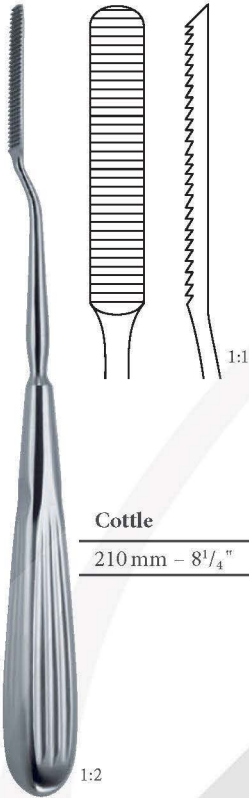

Cottle

| | |
|--|-------------|
| 210 mm - 8 ¹ / ₄ " | NR 15-10-01 |
|--|-------------|

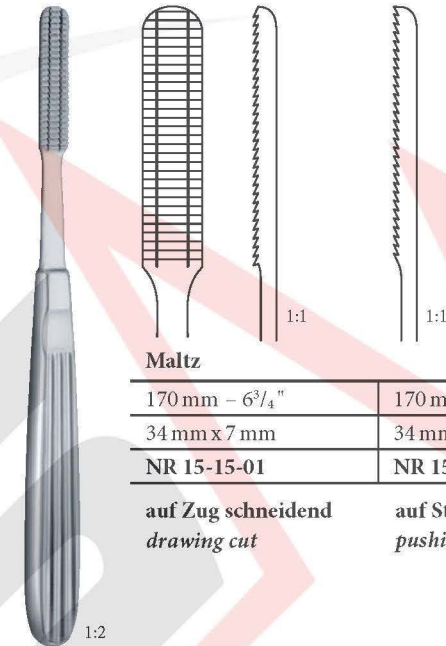

Maltz

| | |
|--|--|
| 170 mm - 6 ³ / ₄ " | 170 mm - 6 ³ / ₄ " |
| 34 mm x 7 mm | 34 mm x 7 mm |
| NR 15-15-01 | NR 15-16-01 |

auf Zug schneidend
drawing cut

auf Stoss schneidend
pushing cut

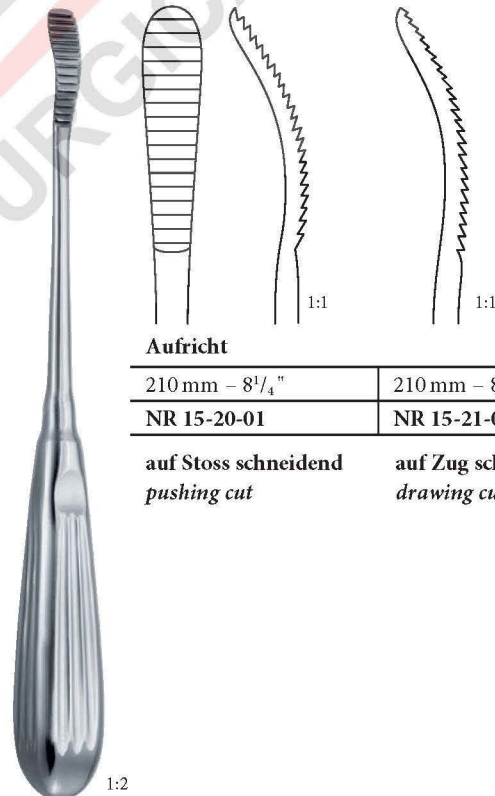

Aufricht

| | |
|--|--|
| 210 mm - 8 ¹ / ₄ " | 210 mm - 8 ¹ / ₄ " |
| NR 15-20-01 | NR 15-21-01 |

auf Stoss schneidend
pushing cut

auf Zug schneidend
drawing cut

Nasenraspeln : Nasal rasps
Râpes nasales : Limas nasales
Raspe nasali

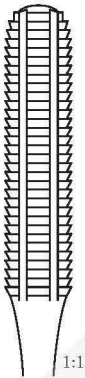
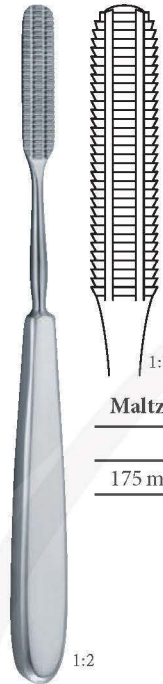

Maltz

| | |
|-------------|--------------|
| | 40 mm x 9 mm |
| 175 mm - 7" | NR 15-25-01 |

1:2



Wiener

| | | |
|-------------|-------------|-------------|
| | Ø 3.5 mm | Ø 3.5 mm |
| 180 mm - 7" | NR 15-30-01 | NR 15-31-01 |

1:2

Antrum Raspeln

Antrum rasps

Râpes pour le fosse nasale

Limas para el antrum

Raspe per antrum



1:1



1:1



1:2



Gallaher

| | | |
|-----------------|-----------------|-----------------|
| 160 mm - 6 1/4" | 160 mm - 6 1/4" | 160 mm - 6 1/4" |
| NR 15-37-01 | NR 15-35-01 | NR 15-36-01 |

1:1

1:1

1:1



1:2



1:1



1:1

Fomom

| |
|-----------------|
| 210 mm - 8 1/4" |
| NR 15-40-01 |

SURGERY HNO - ENT

Raspeln mit Hartmetall : Rasps with tungsten carbide

Râpes avec inserts de carbure de tungstène : Limas con carburo de tungsteno

Raspe con tungsteno

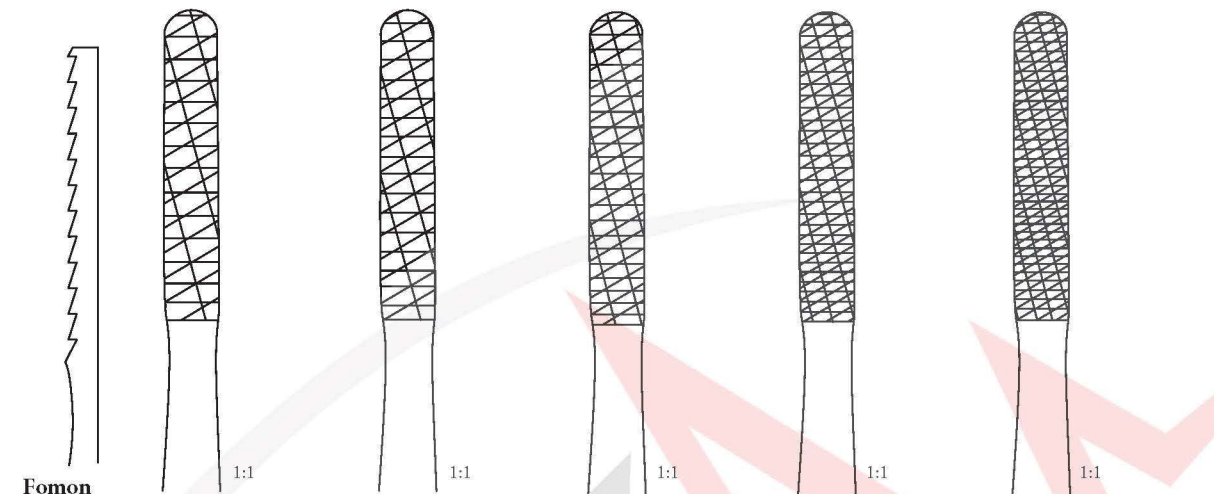

Fomon

| | | | | | |
|----------------------|----------------|----------------|----------------|----------------|----------------|
| | Fig. 1 | Fig. 3 | Fig. 5 | Fig. 7 | Fig. 9 |
| Zähne : Teeth | 12 | 16 | 24 | 36 | 52 |
| 200 mm - 8" | NR 15-45-01 TC | NR 15-45-02 TC | NR 15-45-03 TC | NR 15-45-04 TC | NR 15-45-05 TC |

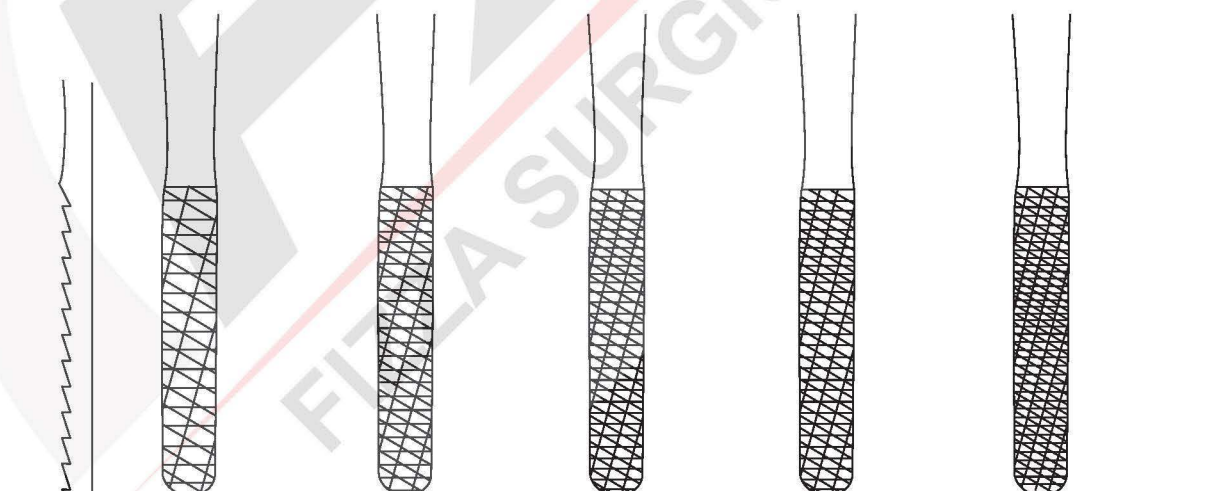

Fomon TC

| | | | | | |
|----------------------|--------|--------|--------|--------|---------|
| | Fig. 2 | Fig. 4 | Fig. 6 | Fig. 8 | Fig. 10 |
| Zähne : Teeth | 14 | 20 | 30 | 44 | 62 |

**Zähne
Teeth**



1:1