

Moto[®] MEDIAL

PARTIAL KNEE SYSTEM



Surgical Technique

Joint

Spine

Sports Med

CAUTION

- Some specific instruments are fixed to the bone by means of dedicated pins. Before using the pins, ensure that they are intact and fully functional. **BENT OR DEFECTIVE PINS CANNOT BE USED AND MUST BE REPLACED BY NEW ONES.** Pins extraction must be performed as to avoid pin bending. This results in axial alignment between the pin and the dedicated extractor
- It is strongly recommended not to impact or hammer on any instruments unless otherwise specified in the surgical technique

For detailed instructions contact your local Medacta sales representative.

TABLE OF CONTENTS

1. INTRODUCTION	4
1.1 Indications	4
1.2 Contraindications	4
1.3 Technique philosophy	4
2. PRE-OPERATIVE PLANNING	5
2.1 Radiological Planning	5
2.2 Clinical Planning	5
2.3 Preoperative x-ray Template	5
3. SURGICAL APPROACH	6
3.1 Limb Positioning	6
3.2 Incision and Exposure	6
3.3 Osteophyte Resection	6
4. TIBIAL RESECTION	7
4.1 Assembling and Positioning the Extramedullary Alignment Guide	7
4.2 Setting the Tibial Transverse Resection Level	8
4.3 Sagittal Resection	9
4.4 Tibial Transverse Resection	10
4.5 Flexion and extension Gap Assessment	10
4.6 Tibia Cut Adjustment	11
5. FEMORAL RESECTION	12
5.1 Extension Alignment Check	12
5.2 Distal Resection	12
5.3 Extension Gap Control	14
5.4 Posterior Femoral Condyle Pre-cut	15
5.5 Femoral Sizing and Posterior Cut and Chamfer	15
6. TIBIA FINISHING	19
6.1 Tibial Sizing and Keel Preparation	19
6.2 Tibial Pegs Preparation	20
7. TRIALING	22
8. FEMUR FINISHING	24
9. FINAL IMPLANT COMPONENTS	25
9.1 Tibial Component	25
9.2 Femoral Component	26
9.3 Insert Component	26
10. SUMMARY STEPS	28
11. SELECTION OF THE PROSTHETIC COMPONENTS - SIZE MATCHING	30
12. IMPLANTS NOMENCLATURE	31
13. INSTRUMENTATION NOMENCLATURE	34

1. INTRODUCTION

This brochure describes the surgical technique of the MOTO Partial Knee System for a Medial Unicompartmental Replacement.

MOTO Medial is designed to replace the medial compartment of the knee. The system contains both implants and instruments designed to enable the surgeon to perform a safe and reproducible unicompartmental reconstruction of the knee; assessing soft tissue balance of the knee at each step. MOTO Medial consists of femoral, tibial base and tibial insert components.

1.1 INDICATIONS

The MOTO Partial Knee System is designed for cemented use in partial knee arthroplasty, if there is evidence of sufficient sound bone to seat and support the components. Partial replacement of the articulating surfaces of the knee is indicated when only one side of the joint is affected due to the compartmental primary degenerative or post-traumatic degenerative disease, previous tibial condyle or plateau fractures, deformity or revision of previous arthroplasty.

1.2 CONTRAINDICATIONS

Partial knee replacement is contraindicated in the following cases:

- Progressive local or systemic infection
- Muscular loss, neuromuscular disease or vascular deficiency of the affected limb, making the operation unjustifiable
- Osteoporosis or osteomalacia
- Metabolic disorders which may impair bone formation
- Rapid joint destruction, marked bone loss or bone resorption apparent on roentgenogram
- Incomplete or deficient soft tissue surrounding the knee
- Severe instability secondary to advanced destruction of condylar structures
- Unicompartmental replacement is contraindicated in patients who have a permanent valgus or varus deformity that requires correction in order for the knee to function satisfactorily post-op

Mental or neuromuscular disorders may create an unacceptable risk to the patient and can be a source of postoperative complications. It is the surgeon's responsibility to ensure that the patient has no known allergy to the materials used.

1.3 TECHNIQUE PHILOSOPHY

Unicompartmental knee arthroplasty (UKA) is primarily a soft tissue surgery, and one-millimeter resections of bone truly make a difference. The MOTO Medial technique is based on key intra-op check points and precise bone resection options with the aim to achieve soft tissue balance and stability of the knee throughout the entire range of motion.

Aim for a slight alignment under-correction and have appropriate ligamentous tension restored, with physiologic gap laxity. It is suggested to aim for a varus/valgus opening of 1-2mm in extension and 2-3mm in flexion.

The most important feature of this technique is the tibial cut, which drives the remainder of bone resections. This is a two-step procedure, performed using adjustable "Shims" and "Spacers" to evaluate the initial resection and refine it, if needed, to ensure the appropriate minimum tibial resection is achieved.

Flexion and extension gaps are then balanced independently by appropriate femoral bone resections.

2. PRE-OPERATIVE PLANNING

2.1 RADIOLOGICAL PLANNING

Full length anterior-posterior, lateral, sunrise and Rosenberg radiographs are required to determine the unique alignment and global severity of knee disease. Valgus stress x-rays are used to determine compartment compliance and lateral compartment integrity.

2.2 CLINICAL PLANNING

The goals are to assess the location of pain, range of motion, strength, ligamentous stability and patellofemoral function.

2.3 PREOPERATIVE X-RAY TEMPLATE

The size of both femoral and tibial components can be estimated preoperatively by means of X-ray templates.

Available templates allow for a magnification factor of: 100% (1:1, standard), 110% (available on demand) and 115% (available on demand).

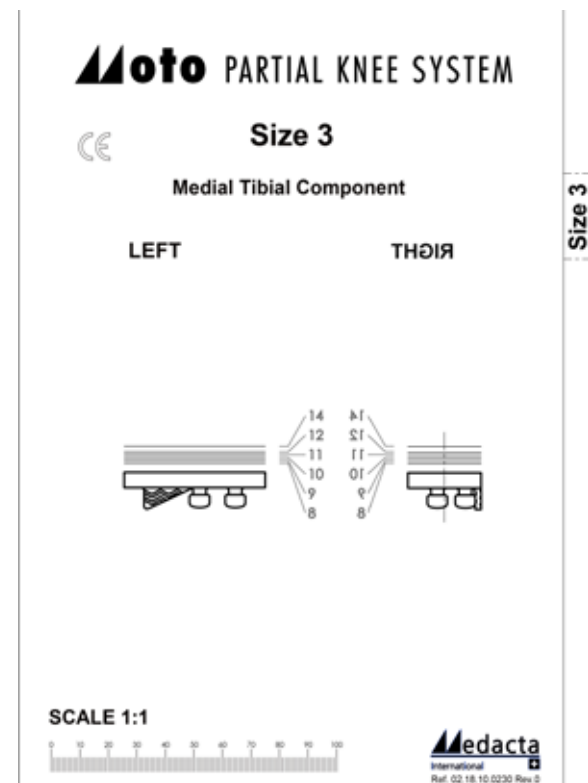
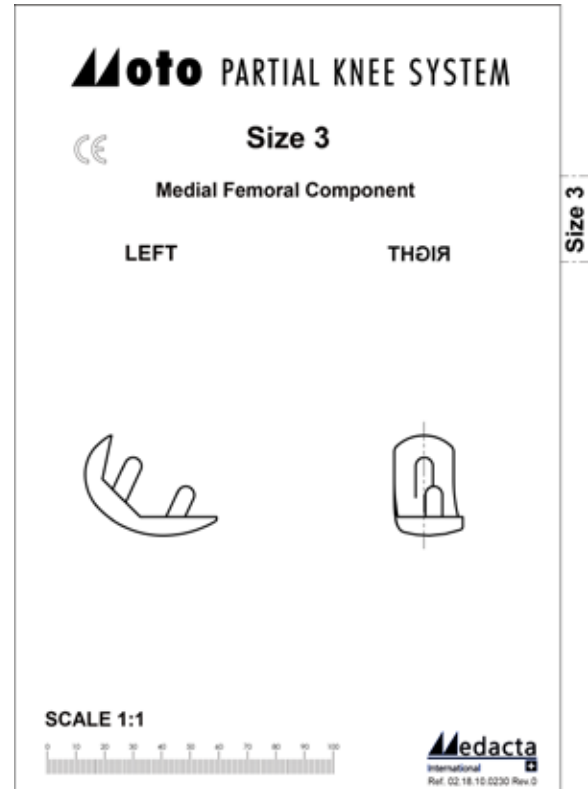

3. SURGICAL APPROACH

3.1 LIMB POSITIONING

With the patient in the supine position, two common options for positioning the limb are: Adjustable leg holder with the standard operating table: The lower limb is prepped and draped free below the tourniquet.

Leg free hanging: The non-operative leg is placed in a leg holder and the operative leg is positioned hanging free with about 15-20 degrees of hip flexion. It is prepped and draped free below the tourniquet.



3.2 INCISION AND EXPOSURE

With the knee at 90 degrees of flexion, make a straight incision starting 1 cm above the superior pole of the patella. It should extend distally to just medial of the tibial tubercle, and overlap the medial 1/5 of the patella.

Use sharp dissection to expose the capsule and subcutaneous flaps.

Begin the arthrotomy along the medial border of the patella and extend distally to just medial of the tibial tubercle. At its upper end, the incision should extend approximately 1 cm into the vastus medialis.

TIP

Do not hesitate to extend the incision as needed for visualization and/or protection of soft tissues.



Exchange the superficial retractor for a deep retractor. Resect the anterior horn of the medial meniscus and the medial portion of the retropatellar fat pad. This will expose the medial compartment and the intercondylar notch.

Perform a minimal dissection along the medial joint line from the patellar tendon, medially, to allow for tibial plateau exposure and retractor placement. Make sure not to disrupt any superficial medial collateral ligament (MCL) fibers.

Examine the anterior cruciate ligament (ACL) and lateral compartment and confirm the antero-medial wear pattern on the medial tibial plateau.

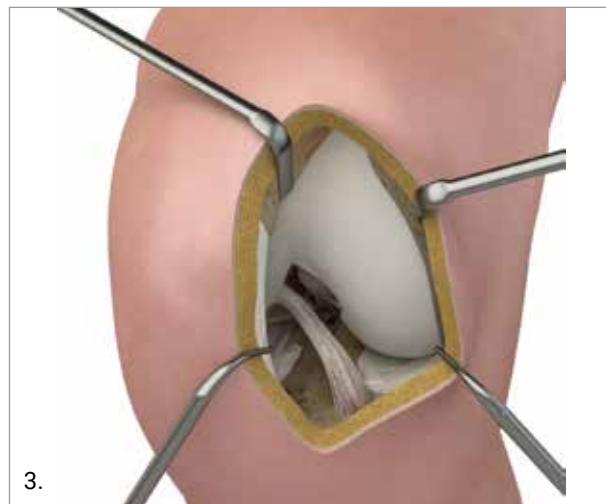

3.3 OSTEOPHYTE RESECTION

Remove osteophytes from the medial femoral condyle, medial patella border and in the intercondylar notch, such that they do not interfere with the choice of implant size or with the assessment of joint stability (tenting of the MCL). It is critical to remove the always-present notch osteophyte at the lateral border of the medial femoral condyle. This creates room to insert the sagittal saw blade into the intercondylar notch during the tibial resection, and is necessary to enable the correct trajectory of the sagittal cut.



4. TIBIAL RESECTION

4.1 ASSEMBLING AND POSITIONING THE EXTRA-MEDULLARY ALIGNMENT GUIDE

The tibial extramedullary system consists of the following components:

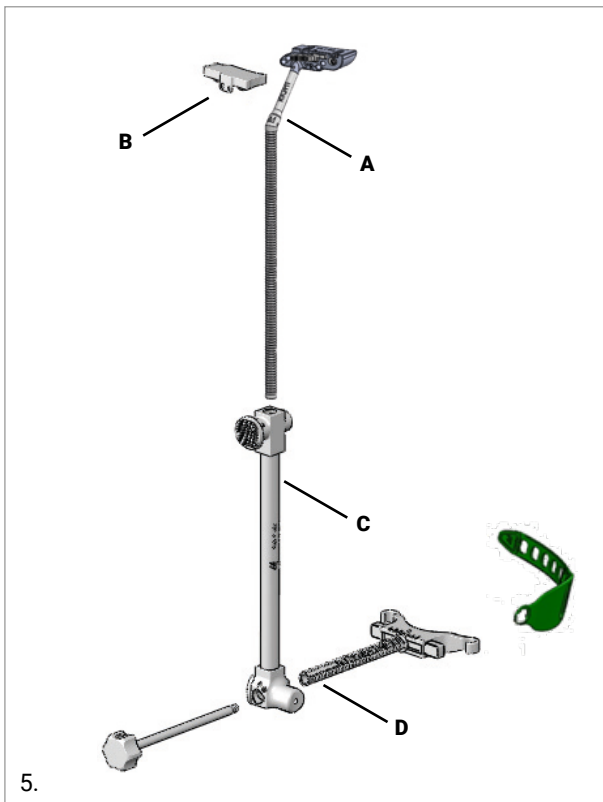

- A - Tibia cutting guide - Right or Left
- B - Shim (0mm, +1mm, +2mm, +3mm, +4mm, +5mm) - Right or Left
- C - Extramedullary guide - distal part
- D - Ankle clamp (body + v/v regulation screw + silicon strap)

Pushing the distal button of the extramedullary guide - distal part (C), slide the ankle clamp body (D) onto the distal "D-shape" dovetail of the extramedullary guide. Release the button, insert the screw for varus/ valgus regulation and tighten the knob to temporarily hold the clamp in place.

Pushing the frontal proximal button of the extramedullary guide - distal part (C), insert the tibia cutting guide of the correct operative side (A) into the proximal end of the extramedullary guide - distal part (C) and release the button.

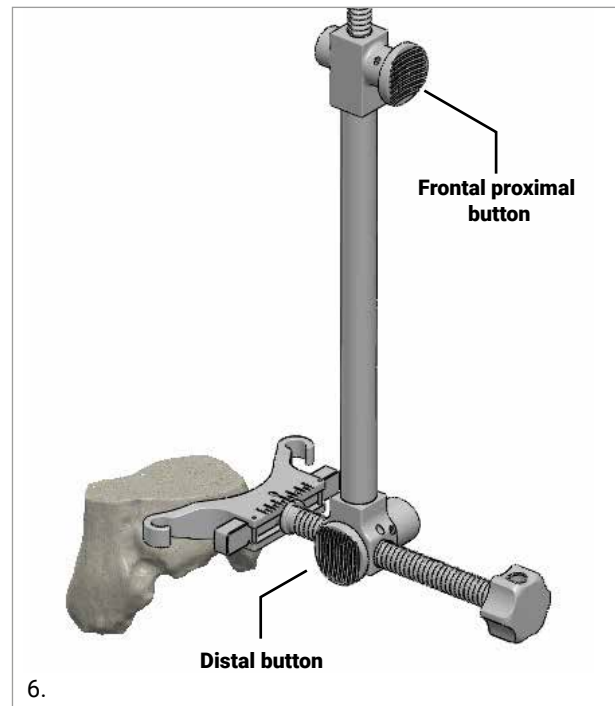

Slide the thickest shim (0mm) onto the dedicated tracks at the top of the tibia cutting guide. Secure the shim at the top of the tibia cutting guide, by turning (with the screwdriver) the dedicated peg clockwise (right guide) or counterclockwise (left guide).



Position the assembly on the tibia. Secure the distal portion of the assembly by placing the silicone strap around the ankle proximal to the malleoli. Make sure that the ankle clamp points towards the ankle center and the cutting guide is centered at the proximal tibia.

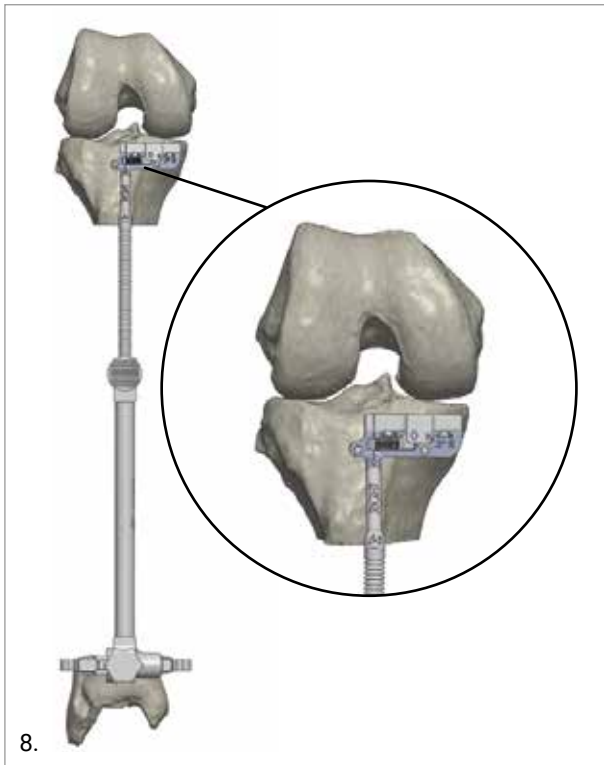

Height is adjusted with the upper push button. Push the button and slide the tibia cutting guide to adjust the height (a graduation in 2mm increments is permitted).

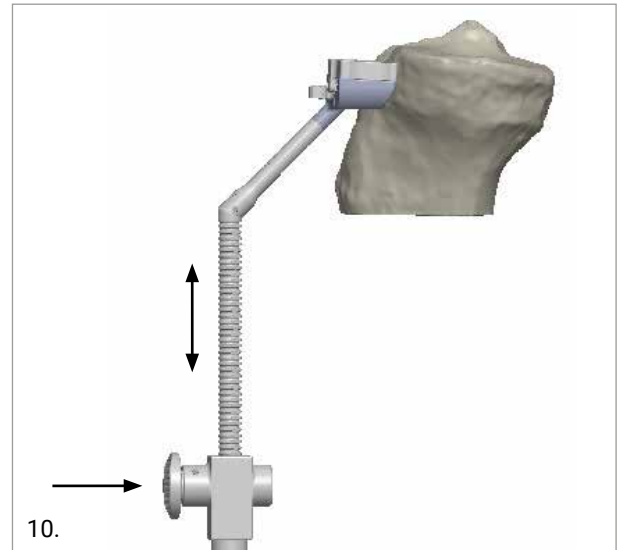

Use an angel wing to indicate if:

- The tibial cut will resect a conservative wafer of bone just below the lowest defect
- The cut matches the anatomic posterior tibial slope

4.2 SETTING THE TIBIAL TRANSVERSE RESECTION LEVEL

The tibial extramedullary system allows for adjustment in all three planes, coronal (height), frontal (varus/ valgus) and sagittal (slope). The numbers indicated on the malleolar clamp body allow for a reference which has no direct anatomical meaning but could be useful for repositioning or readjustment.

Unscrew the knob and adjust the varus/valgus by translating the guide medially or laterally.

To achieve neutral alignment, set the guide parallel to the tibial axis (tibial spine to center of the talus, slightly medial to the midpoint of the ankle) and tighten the knob to secure it in place.

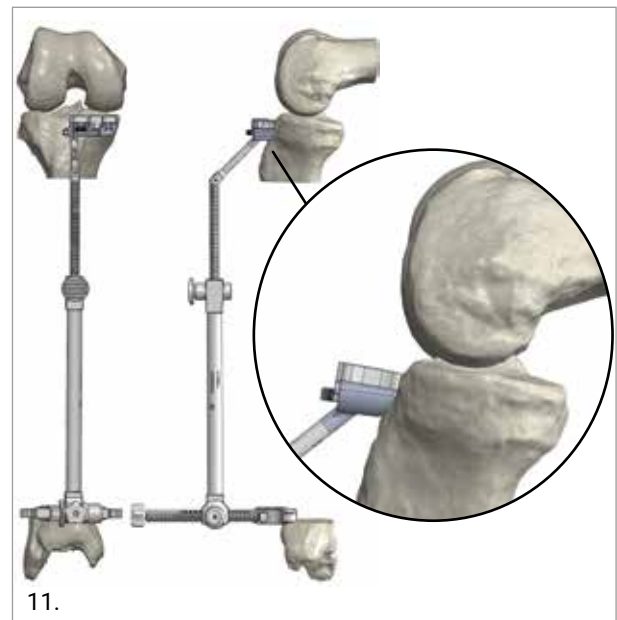
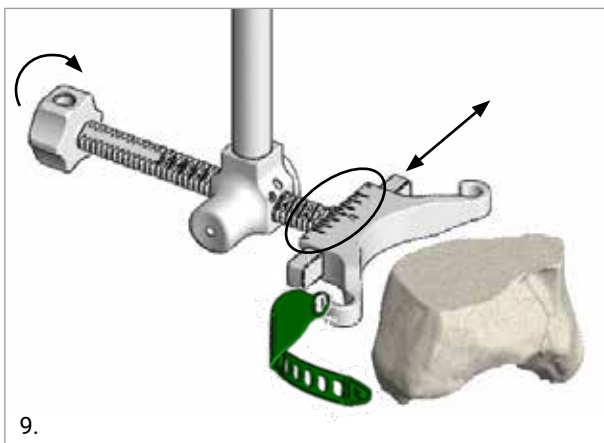

If more or less slope is required this can be adjusted by pushing the distal button and sliding the extramedullary guide anterior-posteriorly along the ankle clamp rod (a graduation in 2mm increments is permitted). When changing the slope, ensure that the ankle clamp still points to the center of the ankle.

The tibial guide has 3 degrees of posterior slope built-in. If the rod is parallel to the tibial crest, the resulting tibial cut will have a 3° slope.

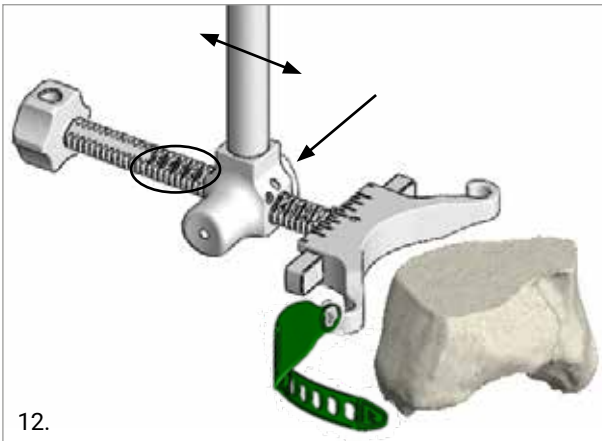

12.

TIP

Match the anatomic slope of the patient, avoiding excessive tibial slope (ideally tibial slope should not exceed 5 degrees).

TIP

In general, setting the slope adjustment to number "13" indicated on the malleolar clamp rod is a good starting place and adjust as needed from there.

An angel wing can be placed on the plane of the tibia cut guide to confirm the desired resection level and slope. When the height adjustment, frontal alignment and posterior slope are deemed satisfactory, fix the guide with a single threaded headed pin by using one of the pin holes marked with a line (green in the Figure 13).

Add an additional pin if further fixation is required.

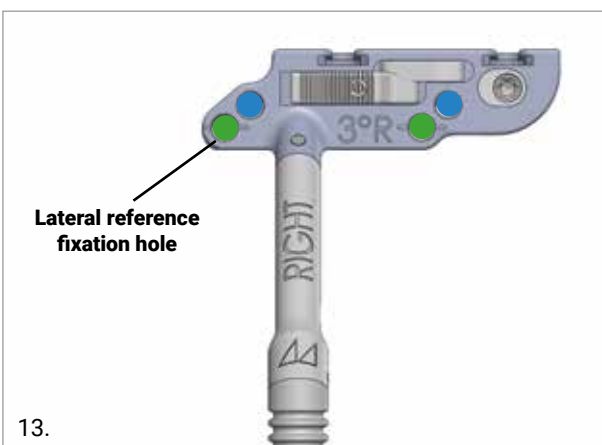

13.

- Reference holes for fixation
- Repositioning holes (+ 3mm recut)

TIP

If possible, use the lateral pin option because the hole will be located lateral to the sagittal saw cut.

4.3 SAGITTAL RESECTION

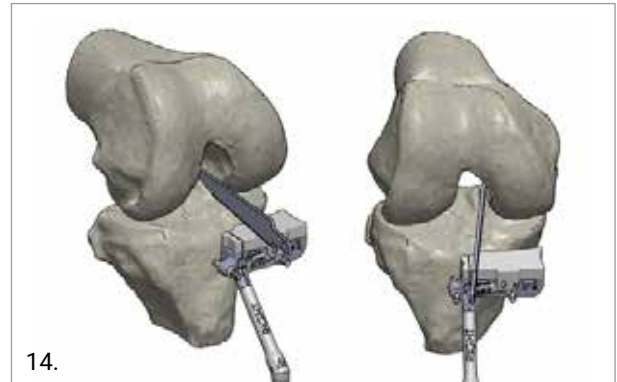

14.

With the knee in flexion, place the tip of a single-sided reciprocating saw in the notch against the lateral wall of the medial femoral condyle, and just under the posterior cruciate ligament (PCL).

Cut freehand close to the peak of the medial tibial spine. It is imperative to keep the saw blade parallel to the guide to avoid notching of the posterior tibia cortex. The saw blade should make contact with the tibial guide anteriorly first and then complete the cut posteriorly. This helps to avoid posterior notching and tibial plateau fracture.



15.

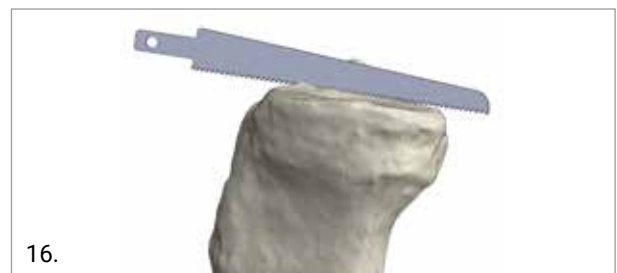

16.

CAUTION

Ensure the trajectory of the saw blade is not internally rotated. Also, the blade should not be lateral to the apex of the medial tibial spine (typically 2-3mm lateral to the lateral wall of the medial femoral condyle).

TIP

This cut may disrupt the medial-most fibers of the ACL as they insert onto the tibia, but should not cut into the main body of the ligament itself.

CAUTION

Avoid the following factors which can contribute to the risk of postoperative tibia fracture:

- Notching the posterior cortex during the sagittal cut
- Positioning the sagittal cut too far medial to the tip of the anterior tibial spine
- Creating more than two pin holes in the proximal tibia and/or in line with sagittal cut
- Making excessively deep tibia depth resection into softer metaphyseal bone

4.4 TIBIAL TRANSVERSE RESECTION

Place a retractor medially to protect the MCL.

Ensure the oscillating saw blade is coplanar with the cutting guide surface. Perform the transverse tibial cut, stopping laterally once the sagittal cut is reached. Avoid undercutting the tibia spine.



17.



18.

TIP

To avoid undercutting the tibial spine, the free reciprocating sagittal saw blade may be placed in the sagittal bone cut.

The wafer of bone can be seen to “jump” once the sagittal and transverse resections are complete. Remove the wafer of bone, and perform a clean-up cut on any proud areas which are directly visible. Examine the wafer of bone for thickness and slope.

Bring the knee into extension and check that the tibial bone resection completely covers the medial femoral condyle. If it does not, evaluate for the need to add more external rotation to the sagittal cut, or to lateralize the sagittal cut.

4.5 FLEXION AND EXTENSION GAP ASSESSMENT

Eight two-sided gap spacers (range 4-19) are available for gap measurements, with the following sizes: 4-5, 6-7, 8-9, 10-11, 12-13, 14-15, 16-17, 18-19.



19.

With the knee at 90 degrees of flexion, insert the gap spacer to determine the flexion gap. When determining the thickness of the flexion gap, choose the thickest spacer which fits the gap with little or no resistance. Verify the varus/valgus alignment and slope of the tibial resection by means of the telescopic alignment rod through the gap spacer.

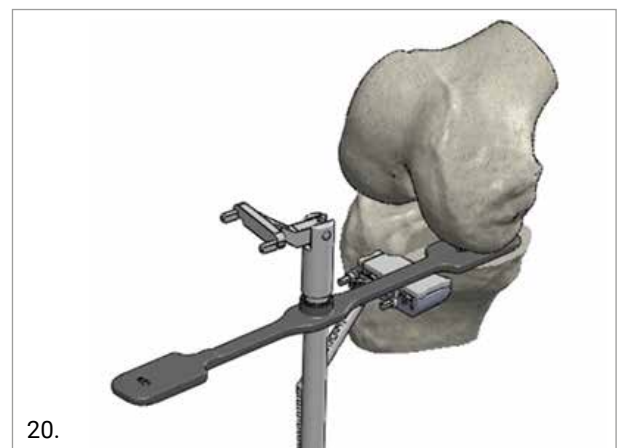

20.

If the first tibial resection is too conservative and the thinnest gap spacer (“4”) cannot be inserted into the joint, recut the tibia by repositioning the tibial cutting guide. Use the top row of holes (shown in blue in the Figure 21). This will allow for a +3mm tibial resection.



21.

- Reference holes for fixation
- Repositioning holes (+ 3mm recut)

At this time, determine the flexion gap with gap spacers. Next, bring the knee into full extension. Check the extension gap using gap spacers in the same manner. The correct spacer is the thickest spacer that fills the extension gap with little to no resistance while maintaining a slightly under-corrected varus alignment.

The information collected in the flexion and extension gap assessment will be used to determine the bone resection plan to correctly balance the knee, as described below.

The goal is a tibia resection that allows a final tibial gap of "9" in flexion, with a varus/valgus opening that corresponds to the desired laxity. The authors aim for approximately 2-3mm of varus/valgus opening in flexion. A target flexion gap of "9" is recommended as it provides the surgeon with +/- 1mm of intraoperative sizing flexibility.

4.6 TIBIA CUT ADJUSTMENT

If the spacer which fits in flexion is "9", no further tibial resection is needed. If the spacer is less than "9", more resection is needed to achieve the desired "9" gap.

To recut the proximal tibia, shims are applied to the tibial cutting guide, allowing for a resection of +1mm, +2mm, +3mm, +4mm, or +5mm. A resection of +6mm is obtained by directly cutting on the tibia cutting guide, with no shim applied.

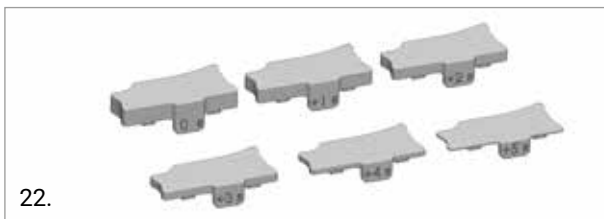

Determine the appropriate shim thickness to be used to recut the proximal tibia according to the following formula:

$$\text{Gap Spacer} + \text{Shim Thickness} = "9"$$

With the aid of the frontal lever on the tibia cutting guide, remove the 0mm shim. Then apply the appropriate chosen shim onto the tibia cutting guide. Place a retractor medially to protect the MCL and re-cut the tibia.

If the resection is greater than 1 millimeter, deepen the sagittal cut first and then perform the transverse cut. Recut until your flexion gap is "9".



EXAMPLE

After the initial tibia resection, the flexion gap is measured at "6". Remove the 0mm shim from the tibial guide and replace it with the +3mm shim, allowing for another 3mm tibial cut. This will result in a flexion gap of "9".

$$["6" \text{ gap spacer}] + [+3\text{mm shim}] = "9" \text{ flexion gap}$$

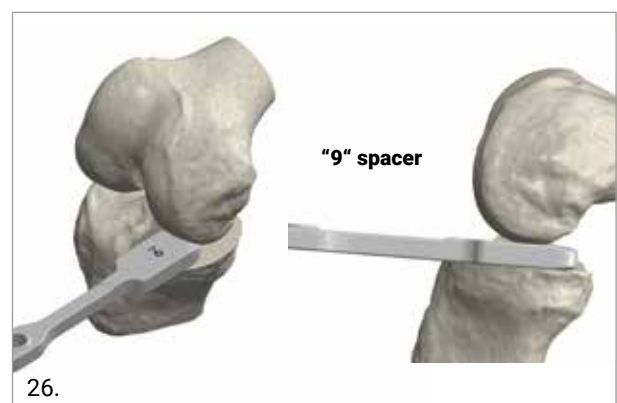
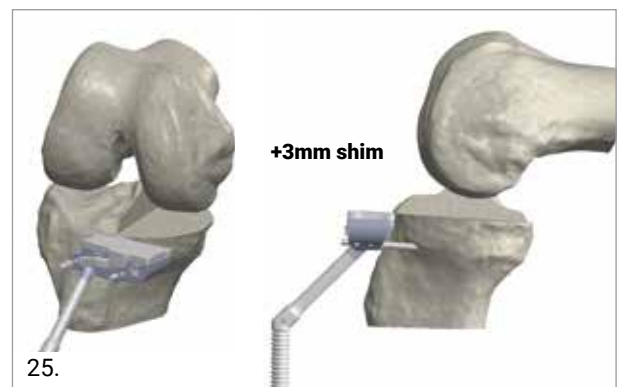
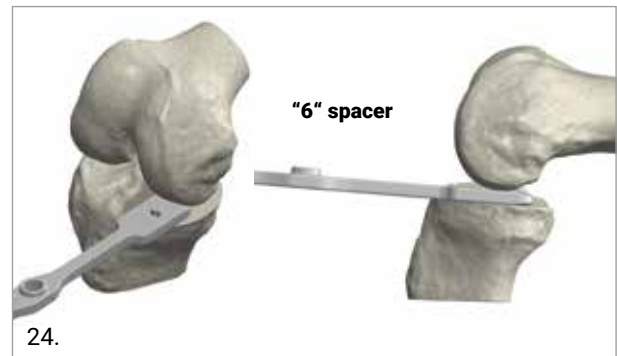

Use the spacers to confirm the gaps after a tibia recut is made. When the tibia resection is deemed satisfactory, remove the pin(s) and the tibial jig.

OPTION

If less tibial resection is desired, see paragraph 7.4 to review femoral precut options for increasing the flexion gap via posterior femoral condylar resections.

5. FEMORAL RESECTION

5.1 EXTENSION ALIGNMENT CHECK

The following instruments are available for checking the joint line and implant alignment:

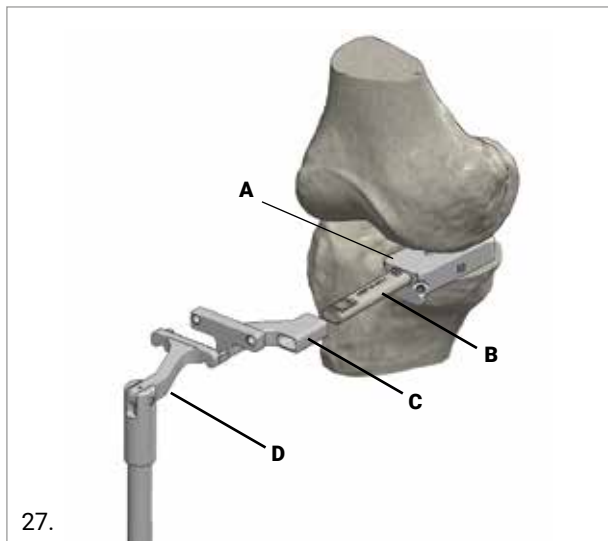

- A. Distal spacers - 8, 9, 10, 11, 12, 13, 14
- B. Connector for distal spacer
- C. Offset alignment connector
- D. Telescopic alignment rod

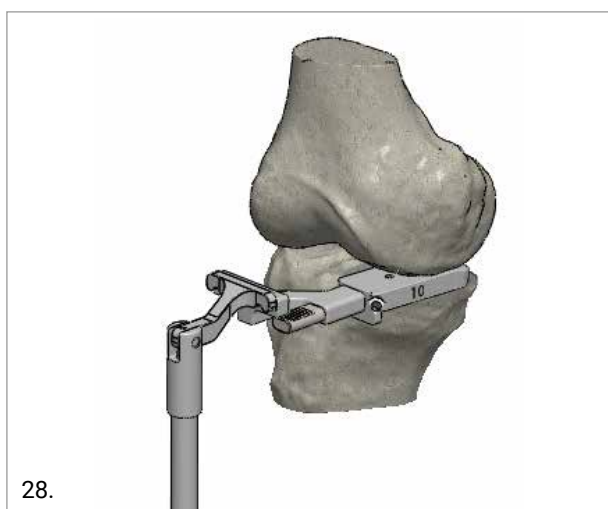

Bring the leg into full extension and insert the appropriate distal spacer thickness into the joint until the anterior lip stops in contact with the anterior aspect of the tibia. The distal spacer thickness should equal the gap spacer thickness previously determined in extension. The spacer must be fully inserted into the joint space and sit flush on resected tibia surfaces, both on the sagittal and transverse cut.

Assemble the connector (B) and the offset alignment corrector (C) to the spacer (A). Insert the telescopic alignment rod (D) into the offset, centering it on the tibia. Assess alignment by verifying that the telescopic rod is in line with the center of the ankle and approaches the center of the hip (the degree of alignment under-correction is a function of patient's anatomy).

Make certain that the knee is not over corrected into valgus, and allows for the desired laxity.

NOTICE: The tibial jig has been designed with a 3° built-in posterior slope. The connector of the distal spacer is angled 3° relative to the distal spacer to compensate for the flexion-extension angle.

Remove the telescopic rod and the offset alignment connector.

5.2 DISTAL RESECTION

The distal femoral resection can be adjusted depending on gap balancing requirements.

Distal cutting guides are available in the following resection thicknesses: "4"/"5", "6" (corresponding to the distal thickness of the femoral component) and "7"/"8".

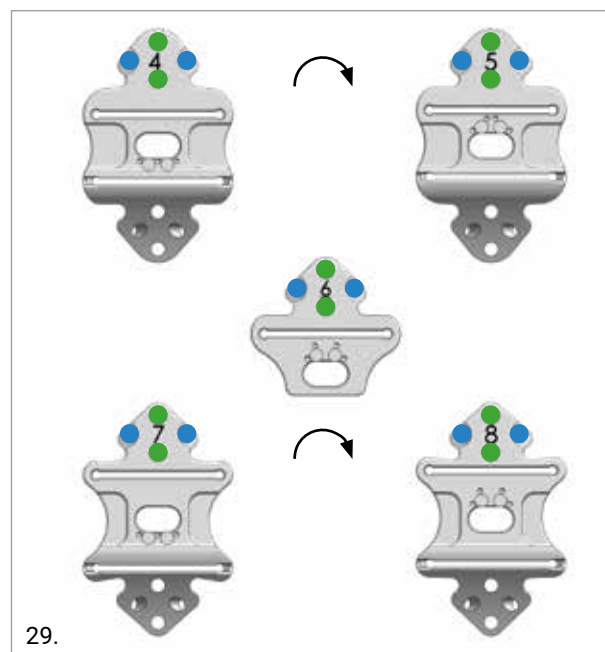

- Reference fixation and repositioning holes
- Oblique fixation holes

The goal is a distal resection that allows a final extension gap of "15", with a varus/valgus opening that corresponds to the desired laxity. The authors aim for approximately 1-2mm of varus/valgus opening in extension.

The target "15" extension gap reflects the combined thickness of the distal femoral component ("6") and the "9" tibia tray and poly thickness.

OPTION

Stand alone distal cutting guides for 4mm, 5mm, 6mm, 7mm and 8mm are available as an optional solution (Figure 30).

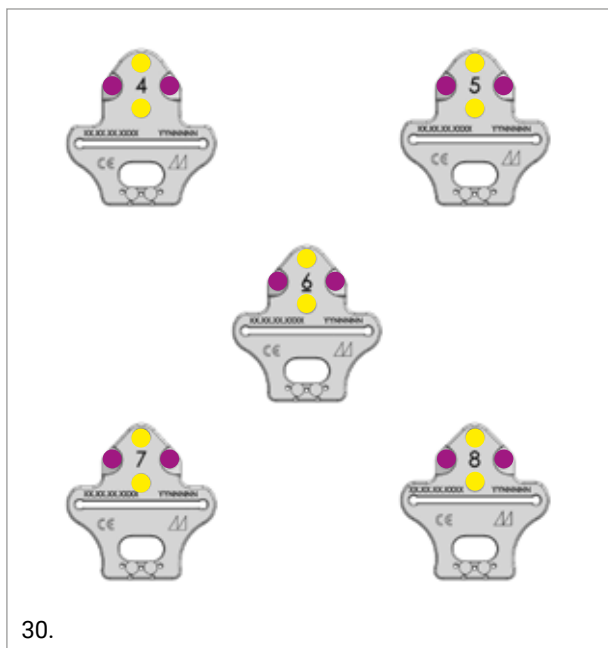

- Reference fixation and repositioning holes
- Oblique fixation holes

CAUTION

Reference fixation holes, repositioning holes and oblique fixation holes of the stand alone distal cutting guides do not correspond to the ones of the standard distal cutting guides highlighted in Figure 29.

Select the distal cutting guide thickness that when combined with the validated distal spacer thickness, results in an extension gap of "15". Assemble it over the connector of the distal spacer.

EXAMPLE

After the tibial resection, the extension gap is measured at "10". Choose the 5mm distal cutting guide. This will result in a final extension gap of "15".
 ["10" tibia only distal spacer] + ["5" distal resection] = "15" extension gap (tibia plus distal femur)



Adjust rotation by confirming that the distal spacer block is flush against the sagittal cut.

Apply an axial load to make sure that the MCL is not loose and to accommodate the desired laxity.

Fix the cutting guide by means of two headless threaded pins inserted in the central parallel holes (green in Figure 29, yellow in Figure 30). If additional fixation is desired, a threaded headed pin may be added in one of the oblique holes (blue in Figure 29, purple in Figure 30).



With the MCL retractor in place, perform the distal femur resection through the saw capture slot.

Once the initial cut in extension has been performed, remove the connector rod and the distal spacer block. Flex the knee to 90 degrees and complete the distal resection to avoid inadvertent injury to the ACL and/or MCL. It is imperative that the connector rod is removed from the distal spacer block prior to flexing the knee.

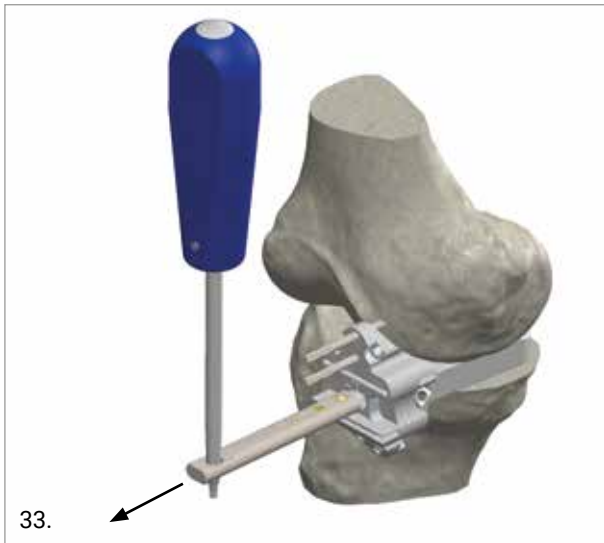

TIP
To facilitate the removal of the connector rod, insert a screwdriver into the hole and pull the connector rod out.



5.3 EXTENSION GAP CONTROL

Remove the distal cutting block by sliding it over the pins.

With the knee in extension check the extension gap and the knee stability by means of the “15” gap spacer, simulating the target total implant thickness (distal femur and “9” tibia tray plus poly).

Verify that the varus/valgus opening corresponds to the desired laxity. The authors aim for approximately 1-2mm of varus/valgus opening in extension.

Check the correct alignment by means of the telescopic alignment rod.

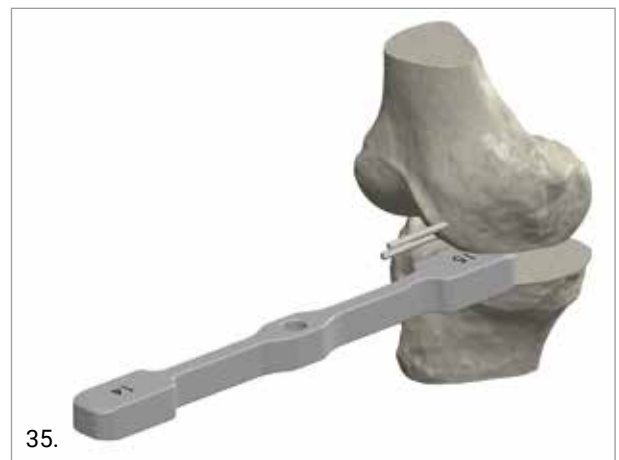

If necessary, recut the distal femur using the appropriate distal cut guide positioned on the previous parallel pins.



Once the distal resection is complete and the correct extension gap and alignment are achieved, remove the pins.

5.4 POSTERIOR FEMORAL CONDYLE PRE-CUT

After the initial tibial resection a posterior femoral condyle (PFC) pre-cut can be used to achieve the target "9" flexion gap, instead of or in combination with a shim aided tibial re-cut.

There are two instances where a pre-cut is particularly useful:

- 1 - In a knee where the flexion gap is significantly tighter than the extension gap
- 2 - In a knee where tibial bone preservation is prioritized by minimizing the depth of the tibial resection

A 1mm posterior pre-cut can be accomplished by simply rasping the posterior apex of cartilage on the femoral condyle. A posterior pre-cut of 2mm or 3mm can be performed using the dedicated posterior shaving guides.

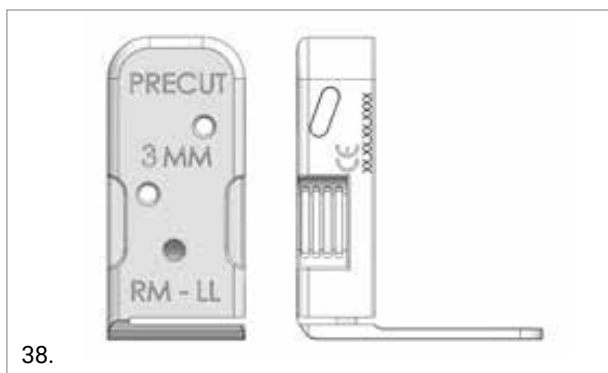
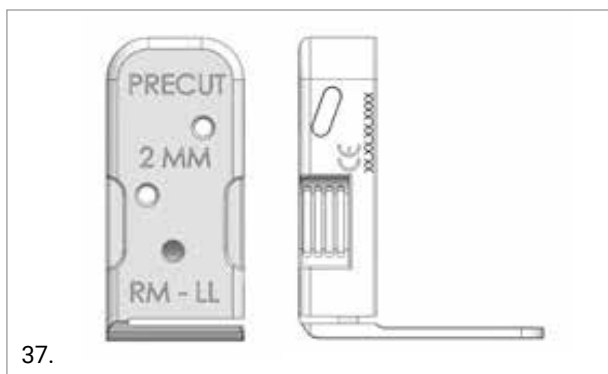

EXAMPLE 1

After the initial tibial resection, the flexion gap is measured at "7" and the extension gap is measured at "10". Plan for a +2mm femoral pre-cut to achieve the target "9" flexion gap without further increasing the extension gap and, at the same time, reducing the difference between flexion and extension gaps.

$["7" \text{ gap spacer}] + [+2\text{mm PFC pre-cut}] = "9" \text{ flexion gap}$

EXAMPLE 2

After the initial tibial resection, the flexion gap is measured at "5" and the extension gap at "7". Select the +2 shim to resect additional tibia and plan for a +2mm femoral pre-cut to get the target "9" flexion.

$["5" \text{ gap spacer}] + [+2\text{mm shim}] + [+2\text{mm PFC pre-cut}] = "9" \text{ flexion gap}$

The 2mm or 3mm pre-cut is to be performed after the distal femoral resection, providing more stable positioning of the shaving guide on the femur. Take this option into account when planning the tibia recut needed to achieve the target "9" flexion gap.

In case a 2mm or 3mm pre-cut has been planned to achieve the target "9" flexion gap, position the chosen shaving guide onto the cut surface of the distal femur and the posterior plate in contact with the posterior condyle.

Fix the guide with pins and cut through the saw capture slot.

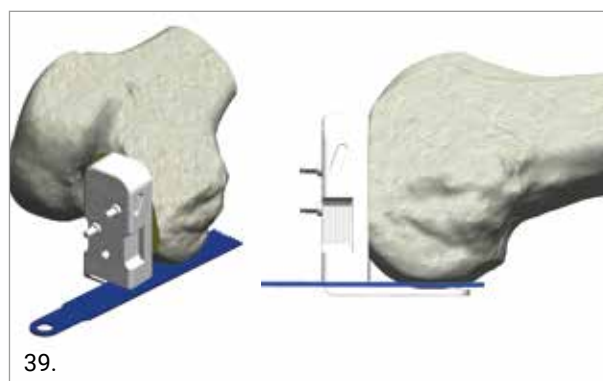

After having performed the pre-cut, check the flexion gap again with gap spacers.

5.5 FEMORAL SIZING AND POSTERIOR CUT AND CHAMFER

Size specific femoral sizers are available to determine the size of the femoral component and the anterior- posterior positioning of the implant.



One femoral gauge per size is available, in right and left versions.

The outside contour of the sizers matches the contour of the corresponding implant, both in the medio-lateral and antero-posterior direction.

The sizer allows for a +2mm resection with respect to the implant thickness (posterior decompression). This will anteriorize the femoral component by 2mm as well as opens the flexion space by 2mm because it accounts for the intact cartilage in the flexion space.

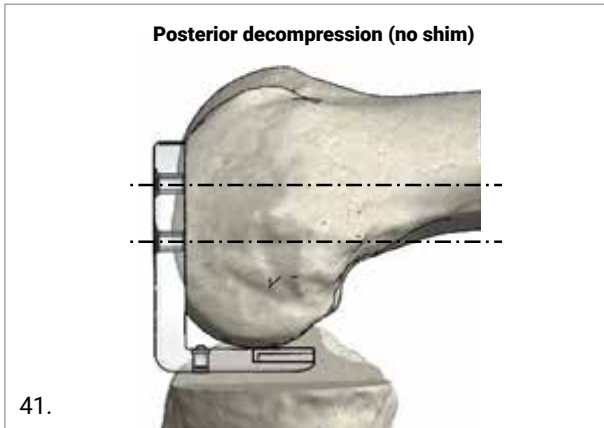

OPTION

A 2mm thick shim is available to be coupled with the femoral sizers, allowing for a resection equal to the implant thickness (line-to-line resection of the posterior femoral condyle).

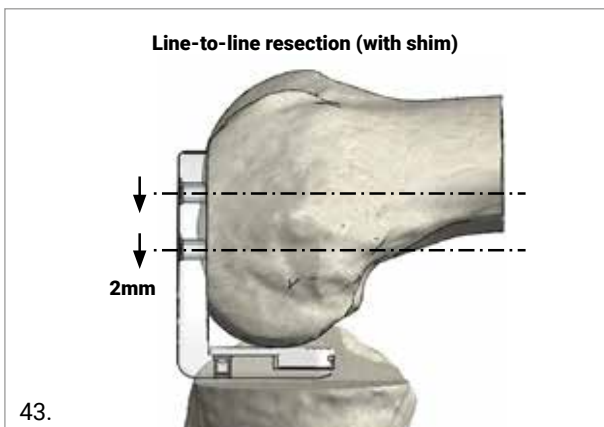
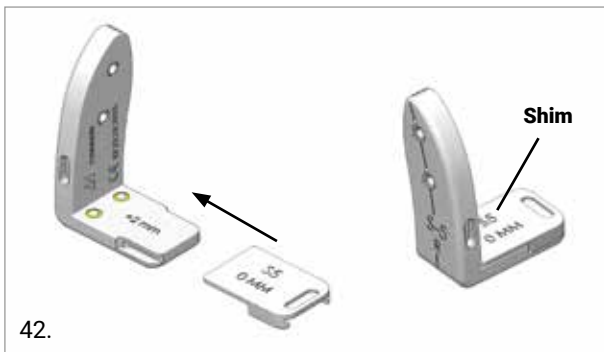

With the knee in flexion, apply the appropriate sizer to the distal femoral cut. Either using the shim or not, the sizer must be placed flush on the distal resection surface and the posterior plate must be placed in contact with the posterior condyle.

Ensure there is no medial overhang present, and that the block has approximately 2mm of cut surface at the superior tip.

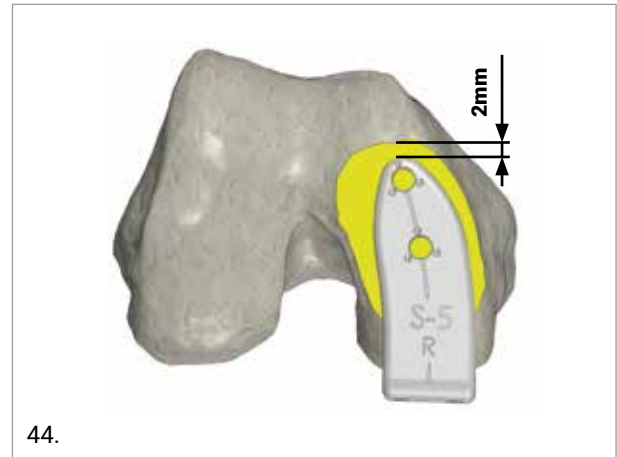

TIP

If between sizes, choose the smaller size. This prevents compartment overhang and patellar impingement.

Confirm rotational alignment and medial/lateral positioning.

TIP

There will be the opportunity to adjust medial/lateral positioning after trial reduction.

When the proper size is selected and positioned, drill the upper hole with the 3.2mm stop-drill. Then fix the femoral sizer position with one pin. The rotation of the component can still be adjusted.

Once the optimal coverage has been obtained, drill the lower fixation hole.



TIP

To increase sizer stability while drilling, the 2mm or 3mm spacer can be positioned between the lower surface of the gauge and the tibial resection plane.



Remove the pin and sizer and position the posterior cutting guide of the corresponding size.

Femoral components are designed into three groups: sizes 1-2, 3-7, 8-10. The three groups of femoral sizes have increasing chamfers thicknesses to add mechanical strength to the biggest sizes.

Posterior cutting guides are available for each size range, in right and left versions.

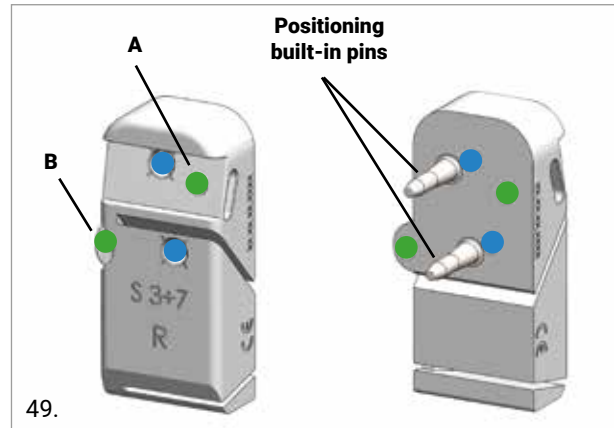

- Fixation holes
- + 2mm repositioning holes for built-in pins

Position the guide by inserting the built-in pins into the two holes previously drilled through the femoral sizer. The cutting block can be held and positioned on the bone by means of the femoral impactor - slide hammer.

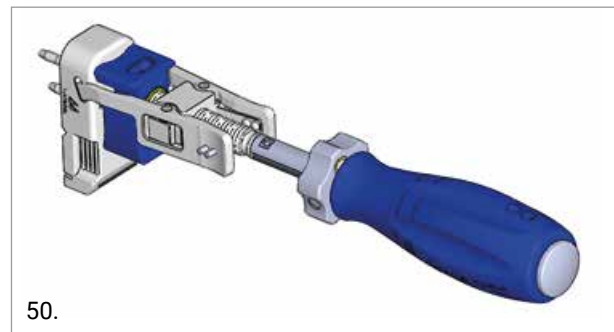

Assemble the posterior cutting guide to the femoral impactor. Open the femoral impactor by turning the handle counter-clockwise. Apply pressure to open the levers and attach the femoral impactor (with "TOP" etching facing downwards) on the lateral pockets located on the posterior cutting guide. Then release the pressure on the levers.

Turn the femoral impactor handle clockwise until the blue slider is firmly in contact with the posterior cutting guide. Then, position the posterior cutting guide onto the bone. To ensure good contact between the posterior cutting guide and the distal resection surface, unlock the ring of the impactor and use the integrated slide hammer to impact the guide on the bone.

The impaction can also be performed using a mallet on the end of the handle, being careful not to use excessive force.

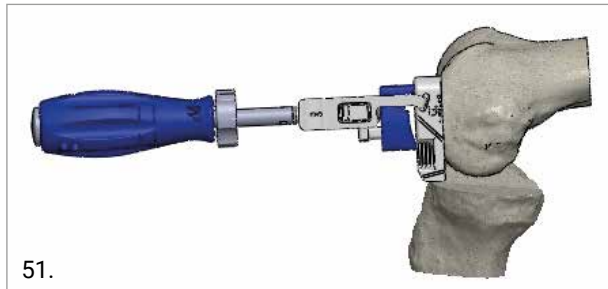

51.

Remove the impactor and check that the posterior cutting guide is perfectly in contact with the distal resection. Fix the position of the cutting guide using a short threaded headed pin (hole A shown in green in Figure 52).

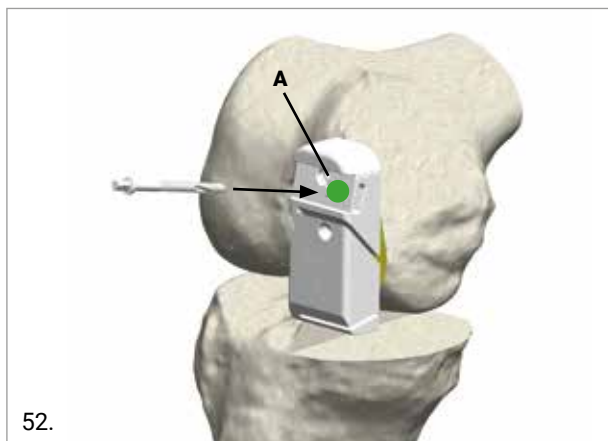

52.

With the knee in flexion, and MCL retractor in position, first perform the posterior cut through the posterior slot of the cutting block (shown in green in the Figure 53).

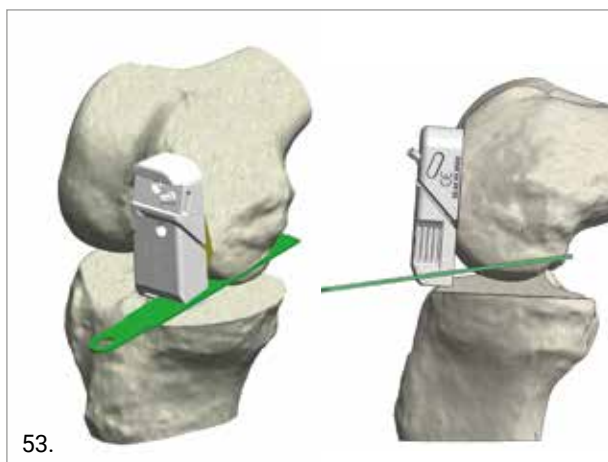

53.

Next perform the posterior chamfer resection through the chamfer slot of the cutting block (shown in blue in the Figure 54).

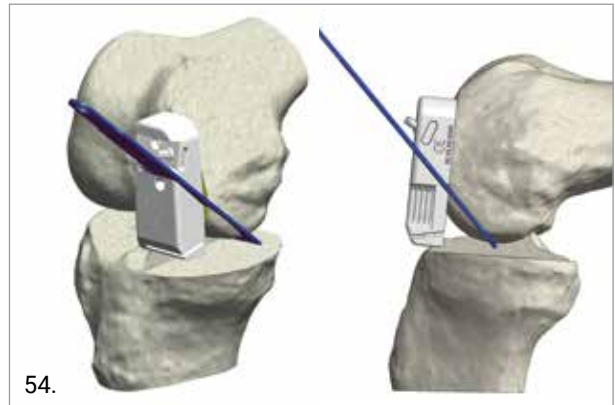

54.

Remove the pin and cutting block and confirm cuts. Position the trial femoral component on the bone and make sure that the resections match the internal profile of the femoral component.

CAUTION

After having performed the femoral resections, ensure that all surfaces are flat. Remove any remaining posterior osteophytes as they could limit flexion or extension, and the remainder of the medial meniscus.

If a downsize from size 3 to 2 or from 8 to 7 is needed, there will be a slight gap at the chamfer that will have to be filled with cement.

If an upsize from 2 to 3 or from 7 to 8 is needed, it is required that the chamfer be recut. Two dedicated recut guides (right and left versions) allow for the recut of the chamfer to adapt the resections to a bigger femur size. In all other upsizing cases this step is not required.

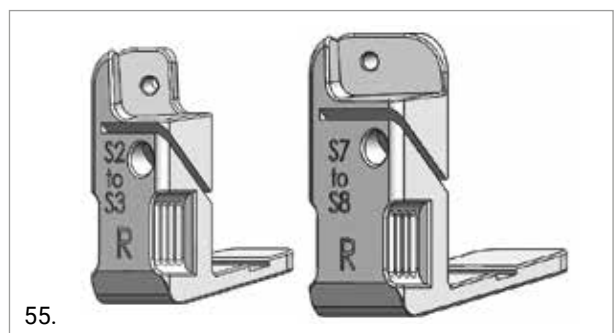

55.

Position the posterior chamfer recutting guide flush to the distal and posterior cut surfaces and fix it using a pin and a screw. Perform the chamfer recut through the slot.

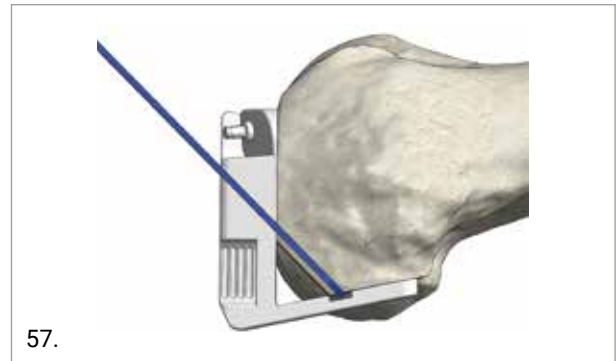
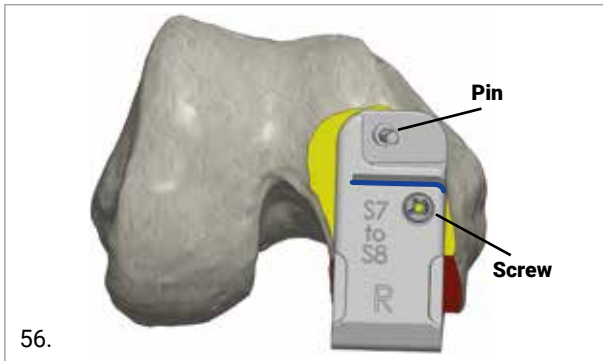

6. TIBIA FINISHING

6.1 TIBIAL SIZING AND KEEL PREPARATION

Assess the tibial size using the tibia templates. Four tibial templates, each bearing two sizes (1-2, 3-4, 5-6 and 7-8), are available. Place the template on the resected surface of the tibia. The straight edge should rest against the surface created by the sagittal cut and the posterior hook in contact with the posterior tibia cortex.

Select the template that best covers the resected proximal tibia in both the antero-posterior and medio-lateral dimensions. The goal is to cover as much of the tibia as possible, without any overhang. Any margin for anterior/posterior overhang should be anterior.

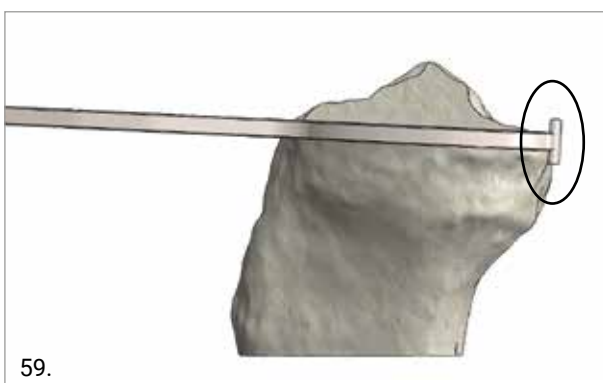
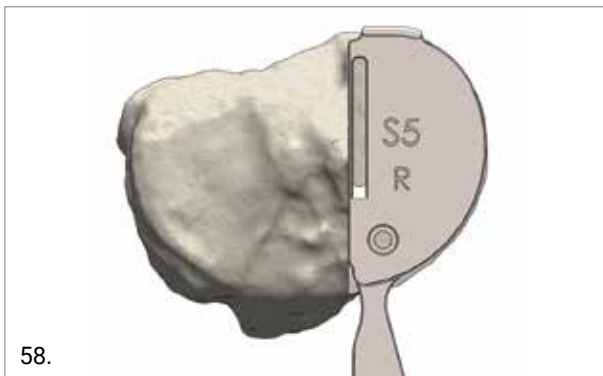

TIP
If the femoral component seems excessively large compared to tibial size, evaluate the sagittal cut. Consider lateralizing or adding external rotation to the sagittal cut, if appropriate, to gain a tibial component size.

CAUTION
It is very important to have the hook against the posterior tibial cortex. This will help avoid breaching the posterior cortex while preparing the keel.

Once the optimal coverage has been achieved, with the appropriate tibia template sizer flush on the tibial surface, insert a short-headed screw into the anterior fixation hole to fix the position of the tibia sizer. The screw is in the same position as the anterior peg of the final tibia implant.

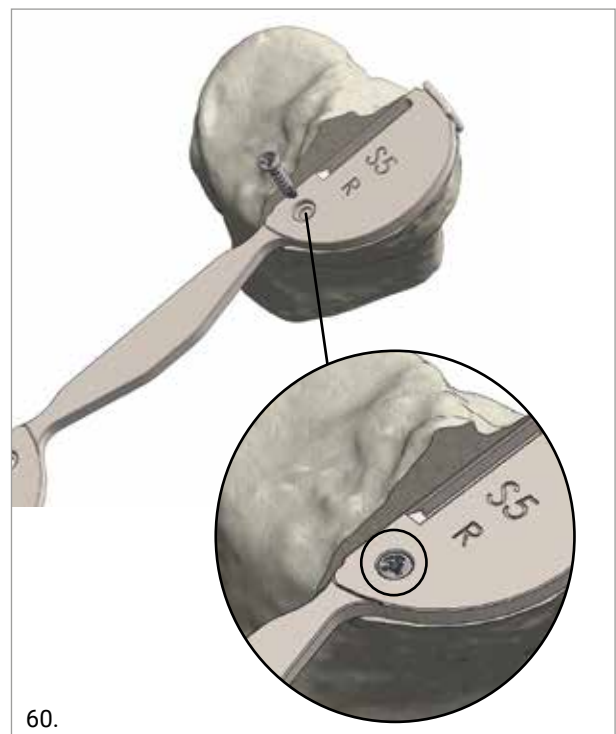

To prepare the keel for the trial and final implant, use the impactor by inserting its keel into the dedicated slot of the tibia template sizer.

Make sure the keel preparation impactor sits flush on the tibia template sizer surface. Hammer on the top of the impactor.

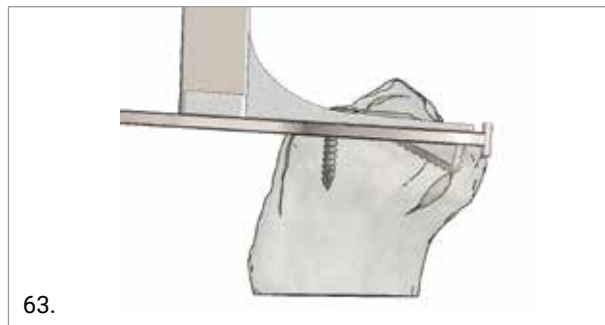

TIP

If the bone is sclerotic you may need to use an osteotome prior to using the impactor for keel preparation.

6.2 TIBIAL PEGS PREPARATION

Remove the screw and the tibia template sizer.

Select the proper size tibial baseplate trial with integrated keel.



Assemble the tibial trial to the tibial impactor, sliding the impactor into the dedicated rail of the chosen trial baseplate.



Flex the knee and position the trial baseplate onto the resected tibial surface so that the integrated keel engages into the slot previously prepared. Lightly impact the tibial baseplate so it sits flush on the tibial surface.



The medio-lateral aspect of the trial baseplate is 1mm wider than the final implant. This is to avoid impingement during the liner insertion. The keel integrated into the impactor has the same size of final implant keel.

Remove the tibial impactor.

Fix the baseplate using a short-headed screw and drill the two tibial peg holes for the fixation peg using the 12mm stop drill bit. Peg holes are angled 5° posteriorly to facilitate drilling, to prevent impingement with the femur and to allow for a 1mm cement mantle around the pegs.

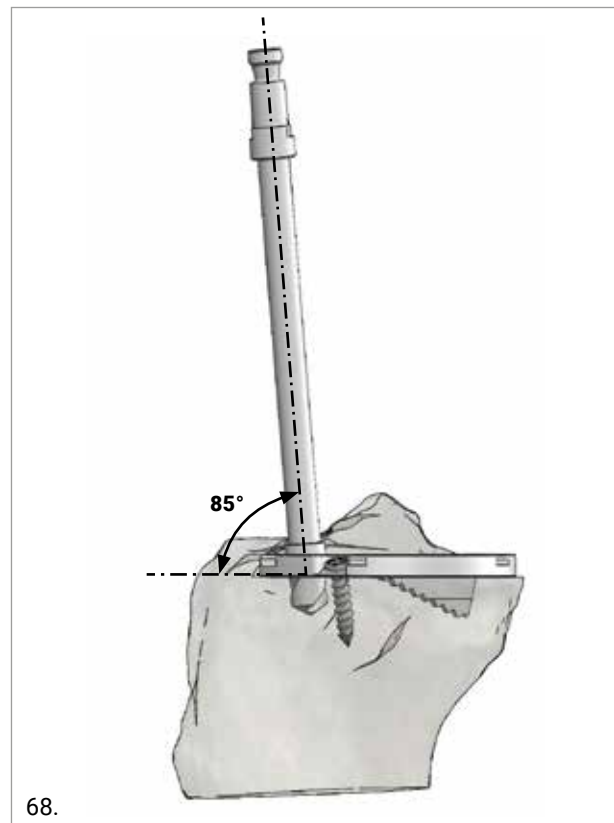
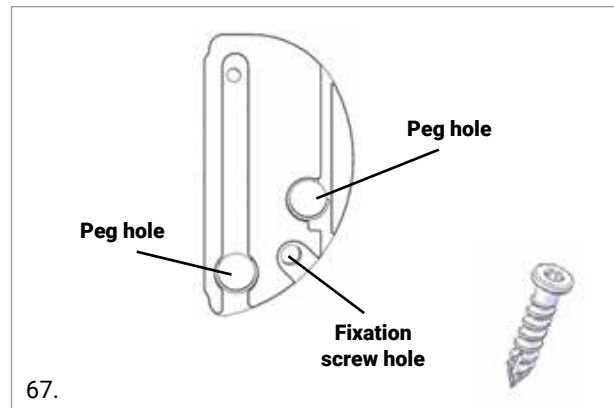

TIP

Make certain the tibial peg drill is fully inserted to allow enough depth for the implant pegs.

7. TRIALING

Choose the trial insert (typically 8 or 9) and slide it onto the rails of the trial tibial baseplate.

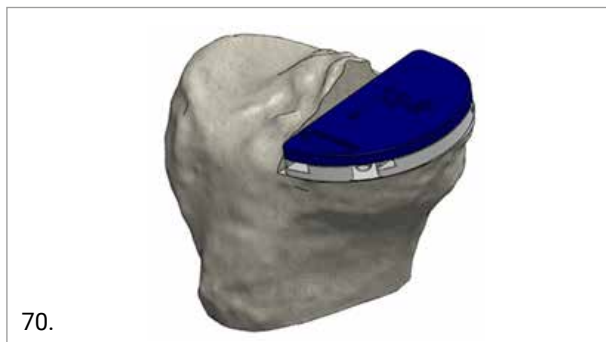
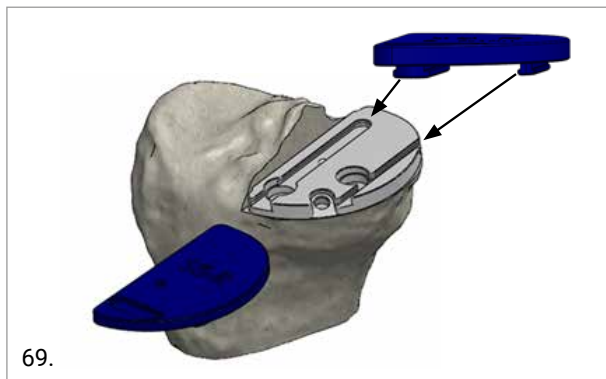

CAUTION

The 7mm thick trial is only available as an on-demand item for use with the 7mm E-Cross poly implant. Before surgery, check with the Medacta representative if the instrumentation includes the 7mm trial insert and if the E-Cross 7mm poly is available to be implanted.

Place the trial femoral component onto the femur and adjust its medio-lateral position to best articulate with the center of the tibial trial throughout a full arc of motion.

CAUTION

Remove any prominent spurs or osteophytes on the posterior femoral condyle as they could inhibit flexion. Check that there is no posterior overhang of femoral component. If this is the case, a smaller femoral size might be considered.

TIP

Determine the optimal medio-lateral position of trial femur during trial reduction, by viewing the contact between femoral component and trial tibia insert.

Once the optimal position is acquired, fix the femoral trial using one or two screws. Two fixation holes are available

for sizes from 3 to 10. One fixation hole is available for small sizes 1 and 2.

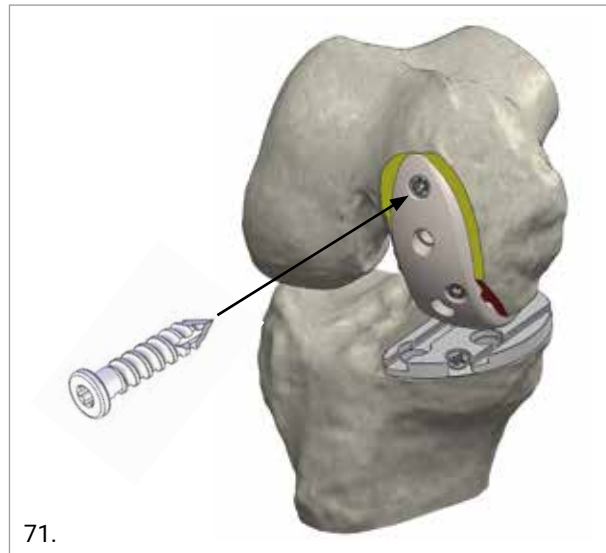

With all trial components in place, test the knee for stability and balance throughout the range of motion. Assess ligamentous balance.

The position of the centerline engraved on the insert top surface, compared to the femoral trial engraving, provides an indication of the medio/lateral final implant position.

Ideally, with varus-valgus stress, there should be a 1-2mm opening in extension, and 2-3mm opening in flexion. It is imperative, however, that knee alignment is not over-corrected into valgus.

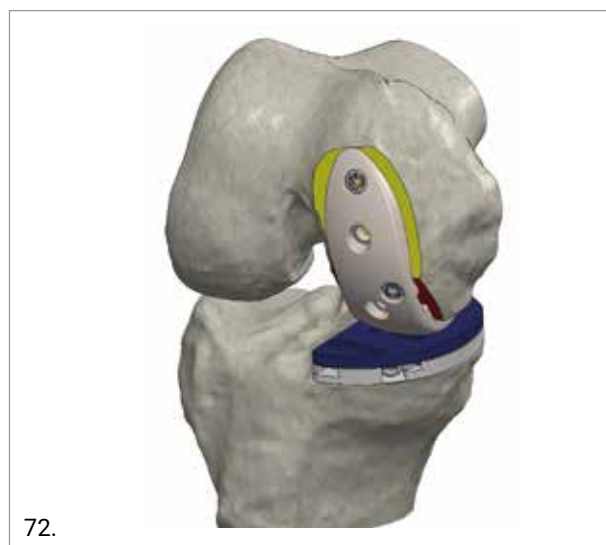

TIP

Insert the 2mm spacer to confirm flexion and extension gaps and ensure they are not too tight.

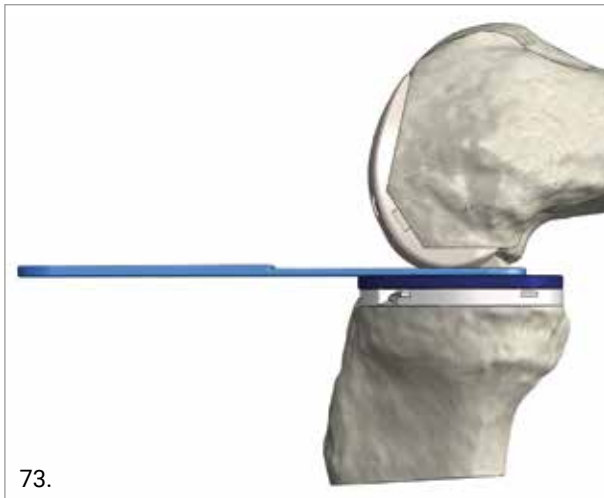

In the event that the trial reduction is tight in flexion and good in extension, an option is to shift the femoral component 2mm anteriorly.

Re-apply the posterior cutting block previously used to the distal femur, fixing it with the prior threaded headed pin (green A hole shown in the Figure 75). Drill the holes marked (blue) with the 3.2mm stop-drill. Remove the fixation pin and cutting block, and re-apply the cutting block to the distal femur, positioning it by inserting built-in pins into the newly drilled holes (blue). Fix the cutting block with a threaded headed pin in the other hole (green B hole) and repeat the posterior and chamfer cuts. This will increase the flexion gap by 2mm.

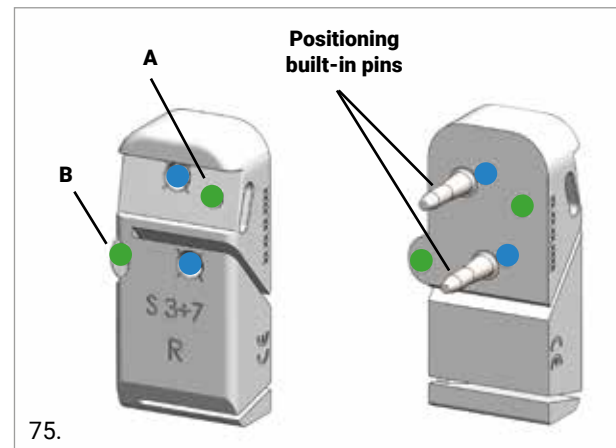

- Fixation holes
- + 2mm repositioning holes built-in pins

CAUTION

Pay particular attention to the coverage, specifically if a femoral size 3 or 8 was chosen. The +2mm anterior shift could lead to the need to downsize the femur to a size 2 or 7, with thinner chamfers. In this case there will be a slight gap at the chamfer that will have to be filled with cement.

8. FEMUR FINISHING

Once proper balance is achieved, confirm the M/L position of the femoral trial. Combine the drill guide with the femoral trial, inserting the two drill guide centering cylinder in correspondance of the two trial peg holes. Insert the drill into the guide for the femoral fixation pegs.

Trial pegs are available to verify the proper peg hole preparation. Use the screwdriver for easier peg handling.

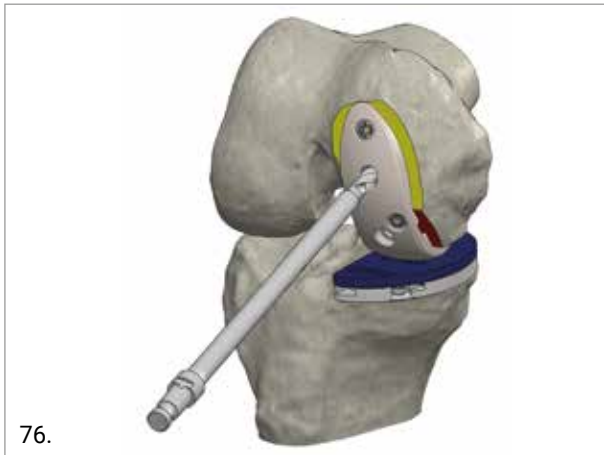

Size 1 through 7 femoral components have two fixation pegs in the same position. Sizes (8-10) have a third peg to increase stabilization.

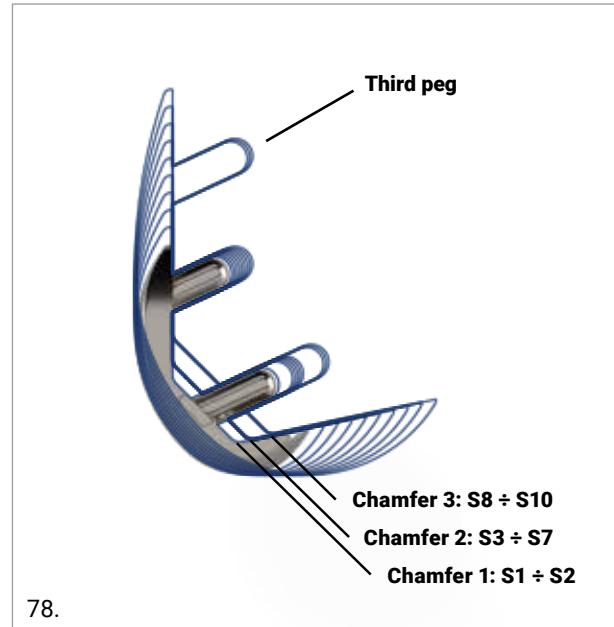

9. FINAL IMPLANT COMPONENTS

When the trials are satisfactory, the femoral and tibial trials can be removed. Next irrigate, the wound and bony surfaces.

If there are any sclerotic areas, these can be prepped with shallow drill holes to aid in cement interdigitation. Dry bony surfaces.

The final implant is intended to be cemented. The bone cement must be prepared according to the relevant instructions for use, provided by the cement manufacturer.

Implant the tibial component first.

9.1 TIBIAL COMPONENT

The resected surface should be thoroughly cleaned. Once the cement has reached the right viscosity according to its instructions for use, it must be applied evenly to the undersurface of the tibial baseplate to fill the cement pockets.

Apply cement, and pressurize with gun or manually into the bony surfaces and peg holes, taking care not to extrude excess cement posteriorly.



Assemble the plastic adapter on the tibial impactor.

Slide the impactor until a click is heard, confirming the adapter is firmly locked into the impactor.

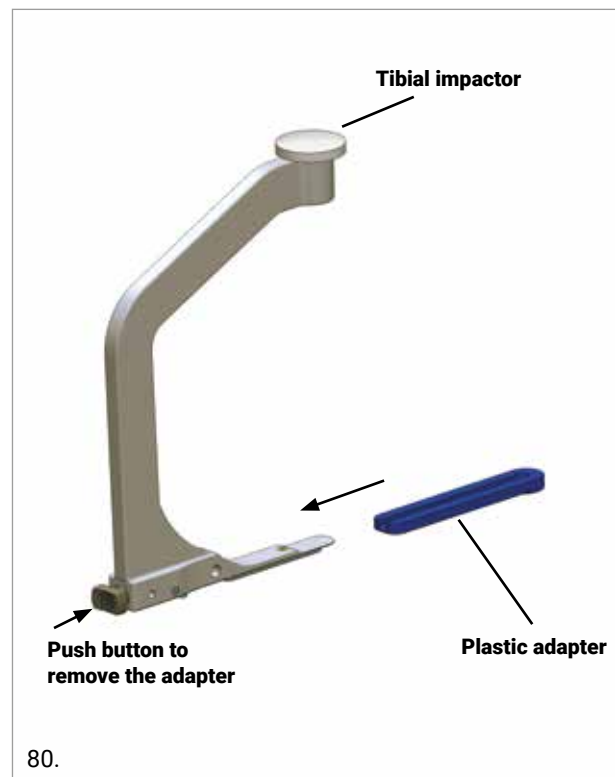

Place the tibial component into proper position. Apply pressure, from posterior to anterior, using the dedicated impactor to allow cement extrusion anteriorly. Tap the final tibial baseplate into position. Remove excess cement at each opportunity, carefully checking that no cement remains on the implant surface, especially in the locking mechanism grooves.

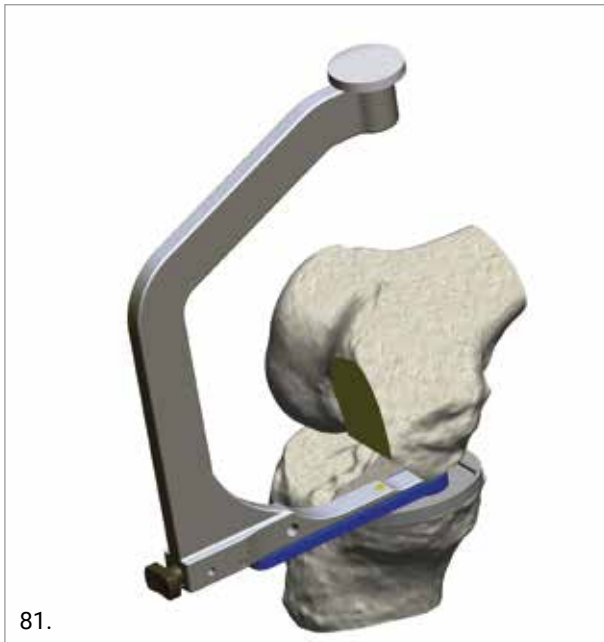

To disassemble the adapter, push the button on the back of the impactor and slide the adapter off.

9.2 FEMORAL COMPONENT

The resected surface should be thoroughly cleaned and dried. Apply cement on the internal surface of the femoral component into the corresponding cement pockets. Apply cement and pressurize with gun or manually into the bony surfaces and peg holes, taking care not to extrude excess cement posteriorly.

Engage the femoral impactor onto the final femoral component and complete the impaction with the knee flexed at 90° using the femoral impactor (TOP etching facing upwards). The extruded cement must be carefully cleaned from the femur, checking that no cement remains on the articular surface. Complete impaction of the femoral component using the femoral impactor.

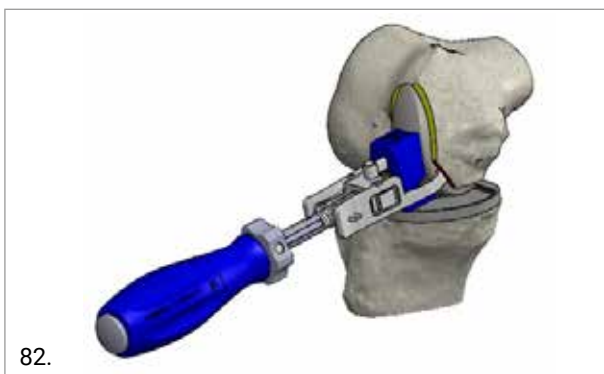

9.3 INSERT COMPONENT

Clip the trial insert to the baseplate and lightly pressurize in extension.

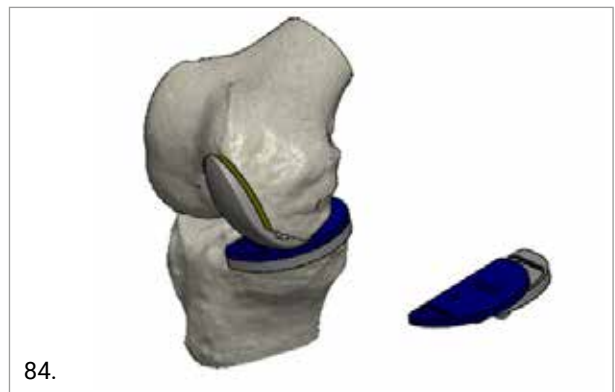

TIP

Use the 2mm plastic spacer to enhance the pressurization. Remove excess cement.



After the cement has cured, repeat the trial reduction with the trial insert clipped in the final tibial component. Confirm the appropriate thickness of the final insert by testing knee stability in flexion and extension to optimize range of motion, alignment, and stability.

Remove any remaining excess cement and, after the cement has cured, implant the polyethylene insert to the baseplate by first engaging the posterior flange. Then apply downward pressure on the insert with 2mm plastic spacer.

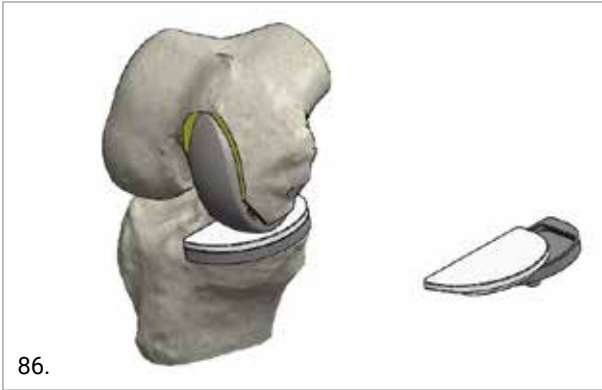

Irrigate and close the wound in the standard fashion.

10. SUMMARY STEPS

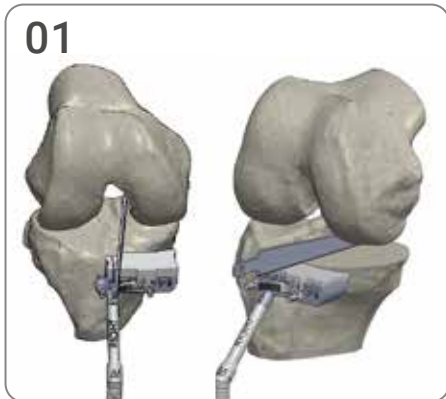

01

Tibial cut guide positioning.
Sagittal resection

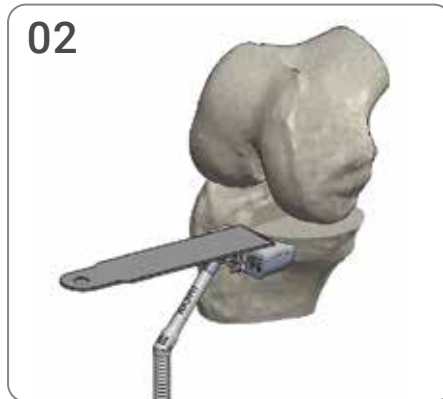

02

Transverse resection



03

Flexion gap check.
Alignment check



07

Extension gap check



08

Distal spacer and distal
resection guide positioning



09

Distal resection



13

Posterior and chamfer
resections



14

Tibia sizing



15

Tibial preparation:
keel and pegs



04
Extension gap check.
Alignment check



05
Tibia recut to achieve "9"*
flexion gap**



06
Flexion gap check



10
Confirm "15"* extension gap

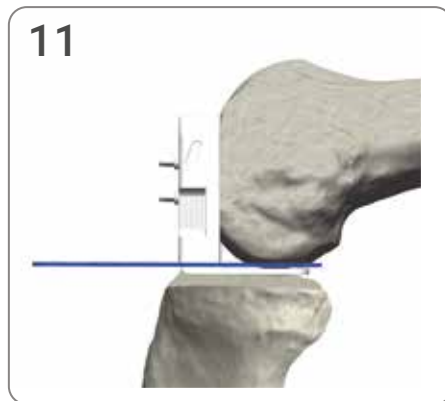

11
**Posterior femoral condyle
pre-cut (option)



12
Femur sizing and holes
preparation



16
Trialing



17
M/L position adjustment
and peg holes preparation



18
Final component
implantation

* Or desired target thickness

**If you wish to minimize or avoid recutting the tibia, utilize the posterior femoral condylar precut to achieve the "9" flexion gap

11. SELECTION OF THE PROSTHETIC COMPONENTS - SIZE MATCHING

Tibial inserts must be matched with tibial trays of the same size only. Any tibial insert can be matched with all sizes of the femoral components. The matching capabilities are shown in tables 1 and 2.

TABLE 1: MATCHING CAPABILITIES FOR TIBIAL INSERTS AND TIBIAL BASEPLATE

		TIBIAL INSERT							
Size		1	2	3	4	5	6	7	8
TIBIAL BASEPLATE	1	✓							
	2		✓						
	3			✓					
	4				✓				
	5					✓			
	6						✓		
	7							✓	
	8								✓

TABLE 2: MATCHING CAPABILITIES FOR TIBIAL INSERTS AND FEMORAL COMPONENTS

		TIBIAL INSERT							
Size		1	2	3	4	5	6	7	8
FEMORAL COMPONENT	1	✓	✓	✓	✓	✓	✓	✓	✓
	2	✓	✓	✓	✓	✓	✓	✓	✓
	3	✓	✓	✓	✓	✓	✓	✓	✓
	4	✓	✓	✓	✓	✓	✓	✓	✓
	5	✓	✓	✓	✓	✓	✓	✓	✓
	6	✓	✓	✓	✓	✓	✓	✓	✓
	7	✓	✓	✓	✓	✓	✓	✓	✓
	8*	✓	✓	✓	✓	✓	✓	✓	✓
	9*	✓	✓	✓	✓	✓	✓	✓	✓
	10*	✓	✓	✓	✓	✓	✓	✓	✓

* On demand size: check before surgery with Medacta representative if these femoral sizes are available in hospital stock.

12. IMPLANTS NOMENCLATURE

FEMORAL COMPONENT

LEFT MEDIAL SIDE	SIZE	RIGHT MEDIAL SIDE
02.18.001LM	1	02.18.001RM
02.18.002LM	2	02.18.002RM
02.18.003LM	3	02.18.003RM
02.18.004LM	4	02.18.004RM
02.18.005LM	5	02.18.005RM
02.18.006LM	6	02.18.006RM
02.18.007LM	7	02.18.007RM
02.18.008LM*	8	02.18.008RM*
02.18.009LM*	9	02.18.009RM*
02.18.010LM*	10	02.18.010RM*

* On demand size: check before surgery with Medacta representative if these femoral sizes are available in hospital stock.

FEMORAL COMPONENT TINBN

LEFT MEDIAL SIDE	SIZE	RIGHT MEDIAL SIDE
02.18.701LM	1	02.18.701RM
02.18.702LM	2	02.18.702RM
02.18.703LM	3	02.18.703RM
02.18.704LM	4	02.18.704RM
02.18.705LM	5	02.18.705RM
02.18.706LM	6	02.18.706RM
02.18.707LM	7	02.18.707RM
02.18.708LM*	8	02.18.708RM*
02.18.709LM*	9	02.18.709RM*
02.18.710LM*	10	02.18.710RM*

TIBIAL TRAY

LEFT MEDIAL SIDE	SIZE	RIGHT MEDIAL SIDE
02.18.TF1.LM	1	02.18.TF1.RM
02.18.TF2.LM	2	02.18.TF2.RM
02.18.TF3.LM	3	02.18.TF3.RM
02.18.TF4.LM	4	02.18.TF4.RM
02.18.TF5.LM	5	02.18.TF5.RM
02.18.TF6.LM	6	02.18.TF6.RM
02.18.TF7.LM	7	02.18.TF7.RM
02.18.TF8.LM	8	02.18.TF8.RM

TIBIAL INSERT

LEFT MEDIAL SIDE	SIZE	LABEL HEIGHT	RIGHT MEDIAL SIDE	LEFT MEDIAL SIDE	SIZE	LABEL HEIGHT	RIGHT MEDIAL SIDE
02.18.IF1.08.LM	1	8	02.18.IF1.08.RM	02.18.IF5.08.LM	5	8	02.18.IF5.08.RM
02.18.IF1.09.LM		9	02.18.IF1.09.RM	02.18.IF5.09.LM		9	02.18.IF5.09.RM
02.18.IF1.10.LM		10	02.18.IF1.10.RM	02.18.IF5.10.LM		10	02.18.IF5.10.RM
02.18.IF1.11.LM		11	02.18.IF1.11.RM	02.18.IF5.11.LM		11	02.18.IF5.11.RM
02.18.IF1.12.LM		12	02.18.IF1.12.RM	02.18.IF5.12.LM		12	02.18.IF5.12.RM
02.18.IF1.14.LM		14	02.18.IF1.14.RM	02.18.IF5.14.LM		14	02.18.IF5.14.RM
02.18.IF2.08.LM	2	8	02.18.IF2.08.RM	02.18.IF6.08.LM	6	8	02.18.IF6.08.RM
02.18.IF2.09.LM		9	02.18.IF2.09.RM	02.18.IF6.09.LM		9	02.18.IF6.09.RM
02.18.IF2.10.LM		10	02.18.IF2.10.RM	02.18.IF6.10.LM		10	02.18.IF6.10.RM
02.18.IF2.11.LM		11	02.18.IF2.11.RM	02.18.IF6.11.LM		11	02.18.IF6.11.RM
02.18.IF2.12.LM		12	02.18.IF2.12.RM	02.18.IF6.12.LM		12	02.18.IF6.12.RM
02.18.IF2.14.LM		14	02.18.IF2.14.RM	02.18.IF6.14.LM		14	02.18.IF6.14.RM
02.18.IF3.08.LM	3	8	02.18.IF3.08.RM	02.18.IF7.08.LM	7	8	02.18.IF7.08.RM
02.18.IF3.09.LM		9	02.18.IF3.09.RM	02.18.IF7.09.LM		9	02.18.IF7.09.RM
02.18.IF3.10.LM		10	02.18.IF3.10.RM	02.18.IF7.10.LM		10	02.18.IF7.10.RM
02.18.IF3.11.LM		11	02.18.IF3.11.RM	02.18.IF7.11.LM		11	02.18.IF7.11.RM
02.18.IF3.12.LM		12	02.18.IF3.12.RM	02.18.IF7.12.LM		12	02.18.IF7.12.RM
02.18.IF3.14.LM		14	02.18.IF3.14.RM	02.18.IF7.14.LM		14	02.18.IF7.14.RM
02.18.IF4.08.LM	4	8	02.18.IF4.08.RM	02.18.IF8.08.LM	8	8	02.18.IF8.08.RM
02.18.IF4.09.LM		9	02.18.IF4.09.RM	02.18.IF8.09.LM		9	02.18.IF8.09.RM
02.18.IF4.10.LM		10	02.18.IF4.10.RM	02.18.IF8.10.LM		10	02.18.IF8.10.RM
02.18.IF4.11.LM		11	02.18.IF4.11.RM	02.18.IF8.11.LM		11	02.18.IF8.11.RM
02.18.IF4.12.LM		12	02.18.IF4.12.RM	02.18.IF8.12.LM		12	02.18.IF8.12.RM
02.18.IF4.14.LM		14	02.18.IF4.14.RM	02.18.IF8.14.LM		14	02.18.IF8.14.RM

E-CROSS TIBIAL INSERT

LEFT MEDIAL SIDE	SIZE	LABEL HEIGHT	RIGHT MEDIAL SIDE	LEFT MEDIAL SIDE	SIZE	LABEL HEIGHT	RIGHT MEDIAL SIDE
02.18.EIF1.07.LM	1	7	02.18.EIF1.07.RM	02.18.EIF5.07.LM	5	7	02.18.EIF5.07.RM
02.18.EIF1.08.LM		8	02.18.EIF1.08.RM	02.18.EIF5.08.LM		8	02.18.EIF5.08.RM
02.18.EIF1.09.LM		9	02.18.EIF1.09.RM	02.18.EIF5.09.LM		9	02.18.EIF5.09.RM
02.18.EIF1.10.LM		10	02.18.EIF1.10.RM	02.18.EIF5.10.LM		10	02.18.EIF5.10.RM
02.18.EIF1.11.LM		11	02.18.EIF1.11.RM	02.18.EIF5.11.LM		11	02.18.EIF5.11.RM
02.18.EIF1.12.LM		12	02.18.EIF1.12.RM	02.18.EIF5.12.LM		12	02.18.EIF5.12.RM
02.18.EIF1.14.LM		14	02.18.EIF1.14.RM	02.18.EIF5.14.LM		14	02.18.EIF5.14.RM
02.18.EIF2.07.LM	2	7	02.18.EIF2.07.RM	02.18.EIF6.07.LM	6	7	02.18.EIF6.07.RM
02.18.EIF2.08.LM		8	02.18.EIF2.08.RM	02.18.EIF6.08.LM		8	02.18.EIF6.08.RM
02.18.EIF2.09.LM		9	02.18.EIF2.09.RM	02.18.EIF6.09.LM		9	02.18.EIF6.09.RM
02.18.EIF2.10.LM		10	02.18.EIF2.10.RM	02.18.EIF6.10.LM		10	02.18.EIF6.10.RM
02.18.EIF2.11.LM		11	02.18.EIF2.11.RM	02.18.EIF6.11.LM		11	02.18.EIF6.11.RM
02.18.EIF2.12.LM		12	02.18.EIF2.12.RM	02.18.EIF6.12.LM		12	02.18.EIF6.12.RM
02.18.EIF2.14.LM		14	02.18.EIF2.14.RM	02.18.EIF6.14.LM		14	02.18.EIF6.14.RM
02.18.EIF3.07.LM	3	7	02.18.EIF3.07.RM	02.18.EIF7.07.LM	7	7	02.18.EIF7.07.RM
02.18.EIF3.08.LM		8	02.18.EIF3.08.RM	02.18.EIF7.08.LM		8	02.18.EIF7.08.RM
02.18.EIF3.09.LM		9	02.18.EIF3.09.RM	02.18.EIF7.09.LM		9	02.18.EIF7.09.RM
02.18.EIF3.10.LM		10	02.18.EIF3.10.RM	02.18.EIF7.10.LM		10	02.18.EIF7.10.RM
02.18.EIF3.11.LM		11	02.18.EIF3.11.RM	02.18.EIF7.11.LM		11	02.18.EIF7.11.RM
02.18.EIF3.12.LM		12	02.18.EIF3.12.RM	02.18.EIF7.12.LM		12	02.18.EIF7.12.RM
02.18.EIF3.14.LM		14	02.18.EIF3.14.RM	02.18.EIF7.14.LM		14	02.18.EIF7.14.RM
02.18.EIF4.07.LM	4	7	02.18.EIF4.07.RM	02.18.EIF8.07.LM	8	7	02.18.EIF8.07.RM
02.18.EIF4.08.LM		8	02.18.EIF4.08.RM	02.18.EIF8.08.LM		8	02.18.EIF8.08.RM
02.18.EIF4.09.LM		9	02.18.EIF4.09.RM	02.18.EIF8.09.LM		9	02.18.EIF8.09.RM
02.18.EIF4.10.LM		10	02.18.EIF4.10.RM	02.18.EIF8.10.LM		10	02.18.EIF8.10.RM
02.18.EIF4.11.LM		11	02.18.EIF4.11.RM	02.18.EIF8.11.LM		11	02.18.EIF8.11.RM
02.18.EIF4.12.LM		12	02.18.EIF4.12.RM	02.18.EIF8.12.LM		12	02.18.EIF8.12.RM
02.18.EIF4.14.LM		14	02.18.EIF4.14.RM	02.18.EIF8.14.LM		14	02.18.EIF8.14.RM

13. INSTRUMENTATION NOMENCLATURE

The following trays are needed for a MOTO Medial Unicompartmental Replacement:

REF.	DESCRIPTION
02.18S.201	MOTO Medial Partial Knee - Tibial & Distal cut
02.18S.202	MOTO Medial Partial Knee - Femoral
02.18S.203	MOTO Medial Partial Knee - Trial inserts

MOTO Medial Partial Knee INSTRUMENT - Tibial & Distal cut 02.18S.201

REF.	DESCRIPTION	QUANTITY
02.18.10.0001	Extramedullary guide - distal part	1
02.18.10.0002	Ankle clamp	1
02.18.10.0277	Tibia cutting guide - Right	1
02.18.10.0278	Tibia cutting guide - Left	1
02.18.10.0006	Shim +0mm - Right	1
02.18.10.0007	Shim +1mm - Right	1
02.18.10.0008	Shim +2mm - Right	1
02.18.10.0009	Shim +3mm - Right	1
02.18.10.0010	Shim +4mm - Right	1
02.18.10.0011	Shim +5mm - Right	1
02.18.10.0012	Shim +0mm - Left	1
02.18.10.0013	Shim +1mm - Left	1
02.18.10.0014	Shim +2mm - Left	1
02.18.10.0015	Shim +3mm - Left	1
02.18.10.0016	Shim +4mm - Left	1
02.18.10.0017	Shim +5mm - Left	1
02.18.10.0018	Gap spacer 4-5	1
02.18.10.0019	Gap spacer 6-7	1
02.18.10.0020	Gap spacer 8-9	1
02.18.10.0021	Gap spacer 10-11	1
02.18.10.0022	Gap spacer 12-13	1
02.18.10.0023	Gap spacer 14-15	1
02.18.10.0024	Gap spacer 16-17	1
02.18.10.0281	Gap spacer 18-19	1
02.18.10.0025	Distal spacer 8	1
02.18.10.0026	Distal spacer 9	1
02.18.10.0027	Distal spacer 10	1
02.18.10.0028	Distal spacer 11	1
02.18.10.0029	Distal spacer 12	1
02.18.10.0280	Distal spacer 13	1

REF.	DESCRIPTION	QUANTITY
02.18.10.0030	Distal spacer 14	1
02.18.10.0031	Connector rod for distal spacer	1
02.18.10.0032	Offset alignment connector - Right	1
02.18.10.0260	Distal cutting guide 7-8	1
02.18.10.0259	Distal cutting guide 6	1
02.18.10.0258	Distal cutting guide 4-5	1
02.18.10.0209	Telescopic alignment rod	1
02.18.10.0270	Tibial template size 1-2	1
02.18.10.0271	Tibial template size 3-4	1
02.18.10.0272	Tibial template size 5-6	1
02.18.10.0273	Tibial template size 7-8	1
02.18.10.0500	Trial tibial tray size 1 - Right	1
02.18.10.0502	Trial tibial tray size 2 - Right	1
02.18.10.0504	Trial tibial tray size 3 - Right	1
02.18.10.0506	Trial tibial tray size 4 - Right	1
02.18.10.0508	Trial tibial tray size 5 - Right	1
02.18.10.0510	Trial tibial tray size 6 - Right	1
02.18.10.0512	Trial tibial tray size 7 - Right	1
02.18.10.0514	Trial tibial tray size 8 - Right	1
02.18.10.0501	Trial tibial tray size 1 - Left	1
02.18.10.0503	Trial tibial tray size 2 - Left	1
02.18.10.0505	Trial tibial tray size 3 - Left	1
02.18.10.0507	Trial tibial tray size 4 - Left	1
02.18.10.0509	Trial tibial tray size 5 - Left	1
02.18.10.0511	Trial tibial tray size 6 - Left	1
02.18.10.0513	Trial tibial tray size 7 - Left	1
02.18.10.0515	Trial tibial tray size 8 - Left	1
02.18.10.0275	Trial tibia impactor	1
02.18.10.0276	Adapter for tibial implant impactor	1
02.07.10.0532	Caliper	1
02.18.10.0274	Keel Impactor	1
02.18.10.0208	Drill bit for tibia pegs	1
02.07.10.4742	Pin Adaptor Hudson Coupling - Conical Assembly	1
02.18.10.0206	Screwdriver T10	1
02.02.10.0146	Pin impactor	on demand
02.07.10.4673	Rasp	1
02.18.10.0207	Motorized screwdriver Torx T10	1
02.18.10.0087	Screw HA5 - L=20mm	6
02.02.10.0130	Drill Ø3.2mm L=130mm	1
02.02.10.0145/A	Pin Ø3.2mm L=70mm	on demand
02.02.10.0145/B	Pin Ø3.2mm L=90mm	on demand
02.07.10.2295	Pin Ø3.2mm L=70mm ISO5835-Meche-Head-Triangle	3
02.07.10.2294	Pin Ø3.2mm L=40mm ISO5835-Meche-Head-Triangle	3

REF.	DESCRIPTION	QUANTITY
02.07.10.2297	Pin Ø3.2mm L=70mm ISO5835-Meche-Triangle	3
02.07.10.2194	Sword Pin Ø3.2mm L=22mm	on demand
02.08.10.0120	UKM Pin Ø3.2mm L=55mm	on demand
02.07.10.4740	Threaded Pin Ø3.2mm L=70mm longer connection	3
02.07.10.4741	Threaded Pin Ø3.2mm L=85mm longer connection	on demand
U40.211.15	Angled osteotome 15mm / 23cm	1
02.08.10.0003	Angel wing	1
02.18.10.0003	Lace for ankle clamp	5
02.18.10.0268	Trial peg	4
02.18.10.0267	Pin Ø3.2mm L=55mm HA3.5 Meche Head Triangle	3
02.18.10.0279	Ø3.2mm stop drill bit for built-in pins	1
02.18.10.8001	MOTO Medial Partial Knee - Tibial & Distal cut Tray	1
02.18.10.0336	4mm distal cutting guide	On Demand
02.18.10.0337	5mm distal cutting guide	On Demand
02.18.10.0338	6mm distal cutting guide	On Demand
02.18.10.0339	7mm distal cutting guide	On Demand
02.18.10.0340	8mm distal cutting guide	On Demand

MOTO Medial Partial Knee INSTRUMENT - Femoral 02.18S.202

REF.	DESCRIPTION	QUANTITY
02.18.10.0036	Femoral gauge S1 Right	1
02.18.10.0037	Femoral gauge S2 Right	1
02.18.10.0038	Femoral gauge S3 Right	1
02.18.10.0039	Femoral gauge S4 Right	1
02.18.10.0040	Femoral gauge S5 Right	1
02.18.10.0041	Femoral gauge S6 Right	1
02.18.10.0042	Femoral gauge S7 Right	1
02.18.10.0043	Femoral gauge S8 Right	on demand
02.18.10.0044	Femoral gauge S9 Right	on demand
02.18.10.0045	Femoral gauge S10 Right	on demand
02.18.10.0261	Posterior cutting guide #1-2 Right	1
02.18.10.0263	Posterior cutting guide #3-7 Right	1
02.18.10.0265	Posterior cutting guide #8-10 Right	on demand
02.18.10.0063	Posterior chamfer recutting guide S2 to S3 - Right	1
02.18.10.0065	Posterior chamfer recutting guide S7 to S8 - Right	on demand
02.18.10.0376	Trial femur S1 - Right	1
02.18.10.0378	Trial femur S2 - Right	1
02.18.10.0380	Trial femur S3 - Right	1
02.18.10.0382	Trial femur S4 - Right	1
02.18.10.0384	Trial femur S5 - Right	1
02.18.10.0386	Trial femur S6 - Right	1
02.18.10.0388	Trial femur S7 - Right	1
02.18.10.0390	Trial femur S8 - Right	on demand
02.18.10.0392	Trial femur S9 - Right	on demand
02.18.10.0394	Trial femur S10 - Right	on demand
02.18.10.0056	2-3mm spacer for femoral gauges	2
02.18.10.1269	Drill bit for femoral pegs	1
02.18.10.0211	UKA femoral impactor - slide hammer	1
02.08.10.0227	Femoral Impactor	1
02.18.10.0222	2mm posterior condyle precut - RM-LL	1
02.18.10.0224	2mm posterior condyle precut - LM-RL	1
02.18.10.0282	3mm posterior condyle precut - RM-LL	1
02.18.10.0283	3mm posterior condyle precut - LM-RL	1
02.18.10.1304	Drill guide	1
02.18.10.0262	Posterior cutting guide #1-2 Left	1
02.18.10.0264	Posterior cutting guide #3-7 Left	1
02.18.10.0266	Posterior cutting guide #8-10 Left	on demand
02.18.10.0064	Posterior chamfer recutting guide S2 to S3 - Left	1
02.18.10.0066	Posterior chamfer recutting guide S7 to S8 - Left	on demand
02.18.10.0046	Femoral gauge S1 Left	1
02.18.10.0047	Femoral gauge S2 Left	1
02.18.10.0048	Femoral gauge S3 Left	1
02.18.10.0049	Femoral gauge S4 Left	1
02.18.10.0050	Femoral gauge S5 Left	1

REF.	DESCRIPTION	QUANTITY
02.18.10.0051	Femoral gauge S6 Left	1
02.18.10.0052	Femoral gauge S7 Left	1
02.18.10.0053	Femoral gauge S8 Left	on demand
02.18.10.0054	Femoral gauge S9 Left	on demand
02.18.10.0055	Femoral gauge S10 Left	on demand
02.18.10.0377	Trial femur S1 - Left	1
02.18.10.0379	Trial femur S2 - Left	1
02.18.10.0381	Trial femur S3 - Left	1
02.18.10.0383	Trial femur S4 - Left	1
02.18.10.0385	Trial femur S5 - Left	1
02.18.10.0387	Trial femur S6 - Left	1
02.18.10.0389	Trial femur S7 - Left	1
02.18.10.0391	Trial femur S8 - Left	on demand
02.18.10.0393	Trial femur S9 - Left	on demand
02.18.10.0395	Trial femur S10 - Left	on demand
02.18.10.0212	Shim for femoral gauge S1	1
02.18.10.0213	Shim for femoral gauge S2	1
02.18.10.0214	Shim for femoral gauge S3	1
02.18.10.0215	Shim for femoral gauge S4	1
02.18.10.0216	Shim for femoral gauge S5	1
02.18.10.0217	Shim for femoral gauge S6	1
02.18.10.0218	Shim for femoral gauge S7	1
02.18.10.0219	Shim for femoral gauge S8	on demand
02.18.10.0220	Shim for femoral gauge S9	on demand
02.18.10.0221	Shim for femoral gauge S10	on demand
02.02.10.0788	Pin extractor	on demand
02.18.10.8002	MOTO Medial Partial Knee - Femoral Tray	1

MOTO Medial Partial Knee INSTRUMENT - Trial inserts 02.18S.203

REF.	DESCRIPTION	QUANTITY
02.18.10.0110	Trial insert size 1R - 8	1
02.18.10.0111	Trial insert size 1R - 9	1
02.18.10.0112	Trial insert size 1R - 10	1
02.18.10.0113	Trial insert size 1R - 11	1
02.18.10.0114	Trial insert size 1R - 12	1
02.18.10.0115	Trial insert size 1R - 14	1
02.18.10.0116	Trial insert size 2R - 8	1
02.18.10.0117	Trial insert size 2R - 9	1
02.18.10.0118	Trial insert size 2R - 10	1
02.18.10.0119	Trial insert size 2R - 11	1
02.18.10.0120	Trial insert size 2R - 12	1
02.18.10.0121	Trial insert size 2R - 14	1
02.18.10.0122	Trial insert size 3R - 8	1
02.18.10.0123	Trial insert size 3R - 9	1
02.18.10.0124	Trial insert size 3R - 10	1
02.18.10.0125	Trial insert size 3R - 11	1
02.18.10.0126	Trial insert size 3R - 12	1
02.18.10.0127	Trial insert size 3R - 14	1
02.18.10.0128	Trial insert size 4R - 8	1
02.18.10.0129	Trial insert size 4R - 9	1
02.18.10.0130	Trial insert size 4R - 10	1
02.18.10.0131	Trial insert size 4R - 11	1
02.18.10.0132	Trial insert size 4R - 12	1
02.18.10.0133	Trial insert size 4R - 14	1
02.18.10.0134	Trial insert size 5R - 8	1
02.18.10.0135	Trial insert size 5R - 9	1
02.18.10.0136	Trial insert size 5R - 10	1
02.18.10.0137	Trial insert size 5R - 11	1
02.18.10.0138	Trial insert size 5R - 12	1
02.18.10.0139	Trial insert size 5R - 14	1
02.18.10.0140	Trial insert size 6R - 8	1
02.18.10.0141	Trial insert size 6R - 9	1
02.18.10.0142	Trial insert size 6R - 10	1
02.18.10.0143	Trial insert size 6R - 11	1
02.18.10.0144	Trial insert size 6R - 12	1
02.18.10.0145	Trial insert size 6R - 14	1
02.18.10.0146	Trial insert size 7R - 8	1
02.18.10.0147	Trial insert size 7R - 9	1
02.18.10.0148	Trial insert size 7R - 10	1
02.18.10.0149	Trial insert size 7R - 11	1
02.18.10.0150	Trial insert size 7R - 12	1
02.18.10.0151	Trial insert size 7R - 14	1
02.18.10.0152	Trial insert size 8R - 8	1

REF.	DESCRIPTION	QUANTITY
02.18.10.0153	Trial insert size 8R - 9	1
02.18.10.0154	Trial insert size 8R - 10	1
02.18.10.0155	Trial insert size 8R - 11	1
02.18.10.0156	Trial insert size 8R - 12	1
02.18.10.0157	Trial insert size 8R - 14	1
02.18.10.0158	Trial insert size 1L - 8	1
02.18.10.0159	Trial insert size 1L - 9	1
02.18.10.0160	Trial insert size 1L - 10	1
02.18.10.0161	Trial insert size 1L - 11	1
02.18.10.0162	Trial insert size 1L - 12	1
02.18.10.0163	Trial insert size 1L - 14	1
02.18.10.0164	Trial insert size 2L - 8	1
02.18.10.0165	Trial insert size 2L - 9	1
02.18.10.0166	Trial insert size 2L - 10	1
02.18.10.0167	Trial insert size 2L - 11	1
02.18.10.0168	Trial insert size 2L - 12	1
02.18.10.0169	Trial insert size 2L - 14	1
02.18.10.0170	Trial insert size 3L - 8	1
02.18.10.0171	Trial insert size 3L - 9	1
02.18.10.0172	Trial insert size 3L - 10	1
02.18.10.0173	Trial insert size 3L - 11	1
02.18.10.0174	Trial insert size 3L - 12	1
02.18.10.0175	Trial insert size 3L - 14	1
02.18.10.0176	Trial insert size 4L - 8	1
02.18.10.0177	Trial insert size 4L - 9	1
02.18.10.0178	Trial insert size 4L - 10	1
02.18.10.0179	Trial insert size 4L - 11	1
02.18.10.0180	Trial insert size 4L - 12	1
02.18.10.0181	Trial insert size 4L - 14	1
02.18.10.0182	Trial insert size 5L - 8	1
02.18.10.0183	Trial insert size 5L - 9	1
02.18.10.0184	Trial insert size 5L - 10	1
02.18.10.0185	Trial insert size 5L - 11	1
02.18.10.0186	Trial insert size 5L - 12	1
02.18.10.0187	Trial insert size 5L - 14	1
02.18.10.0188	Trial insert size 6L - 8	1
02.18.10.0189	Trial insert size 6L - 9	1
02.18.10.0190	Trial insert size 6L - 10	1
02.18.10.0191	Trial insert size 6L - 11	1
02.18.10.0192	Trial insert size 6L - 12	1
02.18.10.0193	Trial insert size 6L - 14	1
02.18.10.0194	Trial insert size 7L - 8	1
02.18.10.0195	Trial insert size 7L - 9	1

REF.	DESCRIPTION	QUANTITY
02.18.10.0196	Trial insert size 7L - 10	1
02.18.10.0197	Trial insert size 7L - 11	1
02.18.10.0198	Trial insert size 7L - 12	1
02.18.10.0199	Trial insert size 7L - 14	1
02.18.10.0200	Trial insert size 8L - 8	1
02.18.10.0201	Trial insert size 8L - 9	1
02.18.10.0202	Trial insert size 8L - 10	1
02.18.10.0203	Trial insert size 8L - 11	1
02.18.10.0204	Trial insert size 8L - 12	1
02.18.10.0205	Trial insert size 8L - 14	1
02.18.10.0230	MOTO Medial component - Template 100%	1
02.18.10.0231	MOTO Medial component - Template 110%	On demand
02.18.10.0232	MOTO Medial component - Template 115%	On demand
02.18.10.8003	MOTO Medial Partial Knee - Trial inserts Tray	1
02.18.10.0599	Trial insert size 1R - 7mm	On demand
02.18.10.0600	Trial insert size 1L - 7mm	On demand
02.18.10.0601	Trial insert size 2R - 7mm	On demand
02.18.10.0602	Trial insert size 2L - 7mm	On demand
02.18.10.0603	Trial insert size 3R - 7mm	On demand
02.18.10.0604	Trial insert size 3L - 7mm	On demand
02.18.10.0605	Trial insert size 4R - 7mm	On demand
02.18.10.0606	Trial insert size 4L - 7mm	On demand
02.18.10.0607	Trial insert size 5R - 7mm	On demand
02.18.10.0608	Trial insert size 5L - 7mm	On demand
02.18.10.0609	Trial insert size 6R - 7mm	On demand
02.18.10.0610	Trial insert size 6L - 7mm	On demand
02.18.10.0611	Trial insert size 7R - 7mm	On demand
02.18.10.0612	Trial insert size 7L - 7mm	On demand
02.18.10.0613	Trial insert size 8R - 7mm	On demand
02.18.10.0614	Trial insert size 8L - 7mm	On demand

NOTES

Part numbers subject to change.

NOTE FOR STERILISATION

The instrumentation is not sterile upon delivery. It must be cleaned before use and sterilised in an autoclave in accordance with the regulations of the country, EU directives where applicable and following the instructions for use of the autoclave manufacturer. For detailed instructions please refer to the document "Recommendations for cleaning decontamination and sterilisation of Medacta International orthopaedic devices" available at www.medacta.com.



**REDEFINING BETTER
IN ORTHOPAEDICS
AND SPINE SURGERY**

MEDACTA.COM



Medacta International SA
Strada Regina - 6874 Castel San Pietro - Switzerland
Phone +41 91 696 60 60 - Fax +41 91 696 60 66
info@medacta.ch

Find your local dealer at: [medacta.com/locations](https://www.medacta.com/locations)

All trademarks are property of their respective owners and are registered at least in Switzerland.
This document is not intended for the US market.
Please verify approval of the devices described in this document with your local Medacta representative.

MOTO® Medial
Surgical Technique

ref: 99.38MM.12-s200
rev. 05

Last update: October 2020
CE 0476