

## ***STERILIZATION CONTAINER SYSTEM***

**BASIC CONTAINER MODEL**



**BIO-BARRIER CONTAINER MODEL**



**STAINLESS STEEL ITEMS  
& ACCESSORIES**





## CONTENTS

### **BASIC MODEL CONTAINER**

**PAGE 1-31**

FULL SIZE	02-07
MEDIUM SIZE	08-13
HALF SIZE	14-19
LARGE SIZE	20-25
LONG SIZE	26-31

### **BIO-BARRIER MODEL CONTAINER**

**PAGE 2-32**

FULL SIZE	34-39
MEDIUM SIZE	40-45
HALF SIZE	46-51
LARGE SIZE	52-57
LONG SIZE	58-63

### **DENTAL , MINI & SPECIAL CONTAINER**

**PAGE 64-80**

LARGE DENTAL MODEL	65-68
DENTAL MODEL	69-70
1/2 DENTAL MODEL	71-72
MINI MODEL	73-74
FLAT MODEL	75-76
ENDOSCOPY MODEL	77-78
IMPLANT MODEL	79
MINI IMPLANT MODEL	79
SCOPE MODEL	80

### **STAINLESS STEEL EQUIPMENT & ACCESSORIES**

**PAGE 81-115**

STAINLESS STEEL INSTRUMENTS TRAYS	82-96
ACCESSORIES	97
ID LABELS & SILICONE MAT	97-98
SILICONE HANDLE & GASKETS FOR LIDS	99
FILTERS & FILTER ACCESSORIES	99-100
SECURITY SEALS	101
INSTRUMENT ORGANISATION SYSTEM	102-107
STAINLESS STEEL EQUIPMENTS	108-115



## ABOUT US :

**ORSAMTIP** is one of the Turkish leading manufacturers in Medical industry ,since 2007. **ORSAMTIP** is specializing in the development, production and marketing of : Sterile container system , stainless steel equipments for hospitals & sterilization units , in accordance with the standards of ISO9001,ISO 13485 & the instruction of CE 2007/42/EEC.

With a 12 years' experience in sterilization field ,**ORSAMTIP** provides now professional consultancy service or a turnkey installation service for the central sterilization unit, including the design and project drawing of the central sterilization unit in accordance with standards. With an experienced expert staff :device selection & feasibility studies according to your hospital's capacity and budget is guaranteed.

We provide & install :

- Steam Sterilizers
- Large Capacity Steam sterilizer for Pharmaceutical & Pharmaceutical Industry
- Hydrogen Peroxide (H<sub>2</sub>O<sub>2</sub>) Gas Plasma sterilizer
- Washing, Disinfection and Drying Devices
- Sterilization containers
- Stainless steel Equipments

## OUR VALUES :

**Innovation**  
Study & provide solutions



**Quality**  
To value the accomplishment  
sions of mission



**Performance**  
Set priorities  
& be effective  
in execution



**Collaboration**  
Encourage team  
performance by  
promoting diversity



**Courage**  
Give your opinion  
receive & shar  
constructive feedback



**Integrity**  
Defend & apply  
high ethical values



**ORSAMTIP** Basic model container systems : are designed for perfect steam flow and penetration for loads ,suitable to the standards and can be used with single use paper filter or reusable PTFE Teflon filters.

**ORSAMTIP** Basic model sterilization container systems are manufactured as five different length, width and height and can be supplied with perforated or non-perforated boxes, perforated lids and safety lids for effective external protection .



**1/1 FULL SIZE**



**3/4 MEDIUM SIZE**



**1/2 HALF SIZE**



**LARGE SIZE**



**LONG SIZE**



# ***STERILE CONTAINER SYSTEM***

## ***BASIC MODEL***











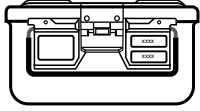

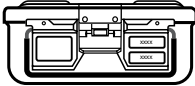























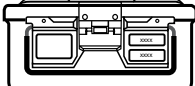























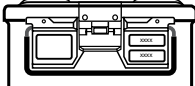























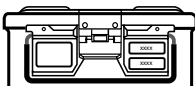























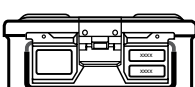













» 1/1 FULL SIZE

# 1/1 FULL SIZE MODEL

W: 285 mm

L: 600 mm



Specifications		Lid (Perforated)		Safety Lid	
		Box (Non Perforated)	Box (Perforated)	Box (Non Perforated)	Box (Perforated)
H: 110 mm		OC 010.10 	OC 011.10 	OC 012.10 	OC 013.10 
		OC 020.10 	OC 021.10 	OC 022.10 	OC 023.10 
		OC 030.10 	OC 031.10 	OC 032.10 	OC 033.10 
		OC 040.10 	OC 041.10 	OC 042.10 	OC 043.10 
		OC 050.10 	OC 051.10 	OC 052.10 	OC 053.10 
		OC 060.10 	OC 061.10 	OC 062.10 	OC 063.10 
H: 135 mm		OC 010.13 	OC 011.13 	OC 012.13 	OC 013.13 
		OC 020.13 	OC 021.13 	OC 022.13 	OC 023.13 
		OC 030.13 	OC 031.13 	OC 032.13 	OC 033.13 
		OC 040.13 	OC 041.13 	OC 042.13 	OC 043.13 
		OC 050.13 	OC 051.13 	OC 052.13 	OC 053.13 
		OC 060.13 	OC 061.13 	OC 062.13 	OC 063.13 
H: 155 mm		OC 010.15 	OC 011.15 	OC 012.15 	OC 013.15 
		OC 020.15 	OC 021.15 	OC 022.15 	OC 023.15 
		OC 030.15 	OC 031.15 	OC 032.15 	OC 033.15 
		OC 040.15 	OC 041.15 	OC 042.15 	OC 043.15 
		OC 050.15 	OC 051.15 	OC 052.15 	OC 053.15 
		OC 060.15 	OC 061.15 	OC 062.15 	OC 063.15 
H: 205 mm		OC 010.20 	OC 011.20 	OC 012.20 	OC 013.20 
		OC 020.20 	OC 021.20 	OC 022.20 	OC 023.20 
		OC 030.20 	OC 031.20 	OC 032.20 	OC 033.20 
		OC 040.20 	OC 041.20 	OC 042.20 	OC 043.20 
		OC 050.20 	OC 051.20 	OC 052.20 	OC 053.20 
		OC 060.20 	OC 061.20 	OC 062.20 	OC 063.20 
H: 255 mm		OC 010.25 	OC 011.25 	OC 012.26 	OC 013.26 
		OC 020.25 	OC 021.25 	OC 022.26 	OC 023.26 
		OC 030.25 	OC 031.25 	OC 032.26 	OC 033.26 
		OC 040.25 	OC 041.25 	OC 042.26 	OC 043.26 
		OC 050.25 	OC 051.25 	OC 052.26 	OC 053.26 
		OC 060.25 	OC 061.25 	OC 062.26 	OC 063.26 

Ps: All container measurements cover the outer size of the lids.

**BOX (perforated)**

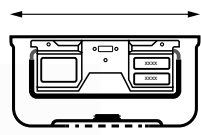
**outside dimension**

**outside dimension**

**inside dimension**

code	outside dimension	inside dimension	weight
<b>OC 01.10</b>	600 x 272 h:100 mm	543 x 258 h:83 mm	2216 g
<b>OC 01.11</b>	600 x 272 h:116 mm	543 x 258 h:99 mm	2362 g
<b>OC 01.13</b>	600 x 272 h:138 mm	543 x 258 h:121 mm	2520 g
<b>OC 01.19</b>	600 x 272 h:190 mm	543 x 258 h:173 mm	2873 g
<b>OC 01.23</b>	600 x 272 h:235 mm	543 x 258 h:218 mm	3290 g

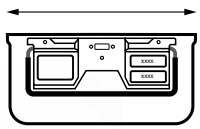

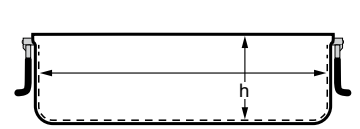



**BOX (non perforated)**

**outside dimension**

**outside dimension**

**inside dimension**







code	outside dimension	inside dimension	weight
<b>OC 00.10</b>	600 x 272 h:100 mm	543 x 258 h:94 mm	1900 g
<b>OC 00.11</b>	600 x 272 h:116 mm	543 x 258 h:110 mm	2096 g
<b>OC 00.13</b>	600 x 272 h:138 mm	543 x 258 h:132 mm	2205 g
<b>OC 00.19</b>	600 x 272 h:190 mm	543 x 258 h:184 mm	2648 g
<b>OC 00.23</b>	600 x 272 h:235 mm	543 x 258 h:229 mm	3040 g

**PERFORATED LIDS**

code	color	weight
<b>OC 011</b>		1310 g
<b>OC 021</b>		
<b>OC 031</b>		
<b>OC 041</b>		
<b>OC 051</b>		
<b>OC 061</b>		







Dimension: 602 x 285 mm

**REMOVAL LIDS (non perforated)**

code	color	weight
<b>OC 012</b>		1046 g
<b>OC 022</b>		
<b>OC 032</b>		
<b>OC 042</b>		
<b>OC 052</b>		
<b>OC 062</b>		

Dimension: 602 x 285 mm

**SAFETY LIDS**

code	color	weight
<b>OC 013</b>		1100 g
<b>OC 023</b>		
<b>OC 033</b>		
<b>OC 043</b>		
<b>OC 053</b>		
<b>OC 063</b>		

Dimension: 606 x 288 mm

## BASKET MADE FROM STAINLESS STEEL WIRE MESH

### WIRE BASKET

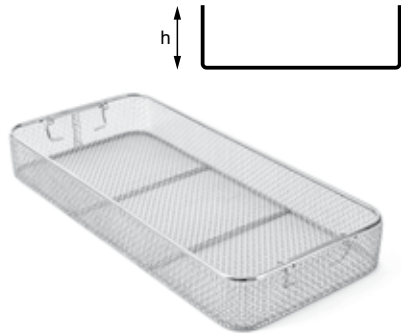

code	outside dimension
<b>OW 010.03</b>	540 x 245 h:30 mm
<b>OW 010.05</b>	540 x 245 h:50 mm
<b>OW 010.07</b>	540 x 245 h:70 mm
<b>OW 010.10</b>	540 x 245 h:100 mm

<b>OW 020.03</b>	480 x 245 h:30 mm
<b>OW 020.05</b>	480 x 245 h:50 mm
<b>OW 020.07</b>	480 x 245 h:70 mm
<b>OW 020.10</b>	480 x 245 h:100 mm

### WIRE BASKET WITH LID

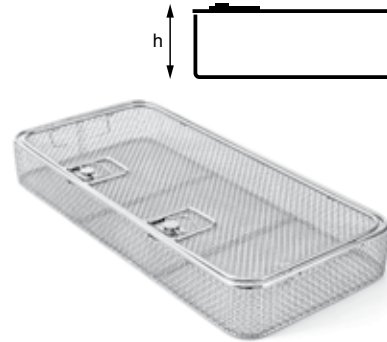

code	outside dimension
<b>OW 011.03</b>	540 x 245 h:35 mm
<b>OW 011.05</b>	540 x 245 h:55 mm
<b>OW 011.07</b>	540 x 245 h:75 mm
<b>OW 011.10</b>	540 x 245 h:105 mm
<b>OW 011</b>	ONLY LID, for baskets

<b>OW 021.03</b>	480 x 245 h:35 mm
<b>OW 021.05</b>	480 x 245 h:55 mm
<b>OW 021.07</b>	480 x 245 h:75 mm
<b>OW 021.10</b>	480 x 245 h:105 mm
<b>OW 021</b>	ONLY LID, for baskets

## WIRE BASKET WITH PERFORATED METAL PLATE

### WIRE BASKET

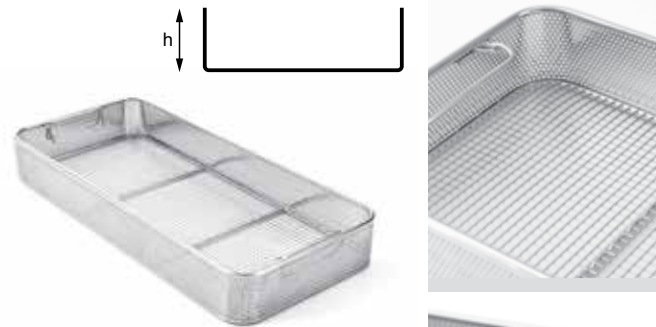

code	outside dimension
<b>OM 010.05</b>	540 x 245 h:50 mm
<b>OM 010.07</b>	540 x 245 h:70 mm
<b>OM 010.10</b>	540 x 245 h:100 mm

<b>OM 020.05</b>	480 x 245 h:50 mm
<b>OM 020.07</b>	480 x 245 h:70 mm
<b>OM 020.10</b>	480 x 245 h:100 mm

### WIRE BASKET WITH LID



code	outside dimension
<b>OM 011.05</b>	540 x 245 h:55 mm
<b>OM 011.07</b>	540 x 245 h:75 mm
<b>OM 011.10</b>	540 x 245 h:105 mm
<b>OM 011</b>	ONLY LID, for baskets

<b>OM 021.05</b>	480 x 245 h:55 mm
<b>OM 021.07</b>	480 x 245 h:75 mm
<b>OM 021.10</b>	480 x 245 h:105 mm
<b>OM 021</b>	ONLY LID, for baskets

## BASKET MADE FROM STAINLESS STEEL SHEET

### BASKET

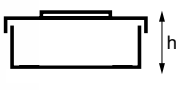
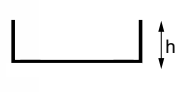
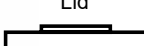

	code	outside dimension
Box and Lid 	<b>OP 011.03</b>	546 x 259 h:34 mm
	<b>OP 011.05</b>	546 x 259 h:54 mm
	<b>OP 011.07</b>	546 x 259 h:74 mm
	<b>OP 011.10</b>	546 x 259 h:104 mm
Box 	<b>OP 010.03</b>	540 x 253 h:40 mm
	<b>OP 010.05</b>	540 x 253 h:60 mm
	<b>OP 010.07</b>	540 x 253 h:80 mm
	<b>OP 010.10</b>	540 x 253 h:110 mm
Lid 	<b>OP 011</b>	ONLY LID, for baskets

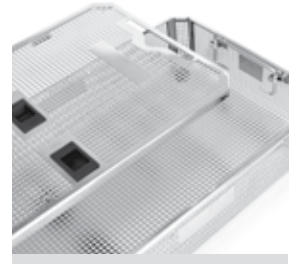

### BASKET

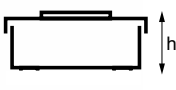
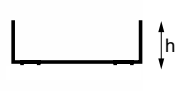
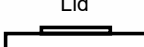

	code	outside dimension
Box and Lid 	<b>OP 021.03</b>	491 x 259 h:34 mm
	<b>OP 021.05</b>	491 x 259 h:54 mm
	<b>OP 021.07</b>	491 x 259 h:74 mm
	<b>OP 021.10</b>	491 x 259 h:104 mm
Box 	<b>OP 020.03</b>	485 x 253 h:30 mm
	<b>OP 020.05</b>	485 x 253 h:50 mm
	<b>OP 020.07</b>	485 x 253 h:70 mm
	<b>OP 020.10</b>	485 x 253 h:100 mm
Lid 	<b>OP 021</b>	ONLY LID, for baskets



code	height
<b>OA 916</b>	10 mm



### STAND



code	height
<b>OA 915</b>	5 mm



## IDENTIFICATION (aluminium)

### LABEL HOLDER



code **OA 931**

### LABELS



code	color
<b>OA 014</b>	Grey
<b>OA 024</b>	Yellow
<b>OA 034</b>	Red
<b>OA 044</b>	Blue
<b>OA 054</b>	Green
<b>OA 064</b>	Black

Coloured identification labels  
Engraved to your specification



 Grey coloured recommended for use in low temperature sterilization.  
Color fading By effect of Hydrogen Peroxide Gas Plasma on other colors.

**DIVIDERS**



**OA 941.13**  
540 x 250 x 130 mm  
**OA 941.18**  
540 x 250 x 180 mm

**WIRE BASE**



**OA 940.03**  
545 x 255 x 30 mm

**DIVIDERS**



**OA 942.13**  
540 x 250 x 130 mm  
**OA 942.18**  
540 x 250 x 180 mm

**RACK (for endoscopy)**

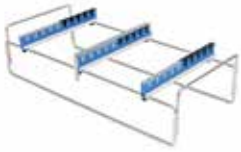

**OA 801**  
505x250x125 mm  
• Holds 10 endoscopic instruments  
• Fits into a 1/1 size 200 mm deep container  
• Wire basket 1/1 50 mm  
• Silicone mat 520 x 230 mm

**DRAPE RETAINER**



**OA 967.03**  
545 x 255 x 30 mm

**DRAPE RETAINER**



**OA 967**  
545 x 255 mm

**ALUMINIUM BASKET (with lid)**



**OB 01.05**  
245 x 130 x 55 mm

**ALUMINIUM BASKET (with lid)**



**OB 01.07**  
245 x 130 x 70 mm

**ALUMINIUM BASKET (with lid)**



**OB 01.10**  
245 x 130 x 105 mm

**SILICONE MAT**



**OA 508**  
520 x 230 mm  
**OA 5010**  
475 x 230 mm



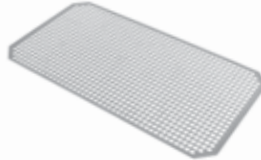



**SILICONE MESH MAT**



**OA 602**  
485 x 250 mm  
**OA 603**  
534 x 247 mm

**SILICONE HANDLE**



**OA 016**   
**OA 026**   
**OA 036**   
**OA 046**   
**OA 056**   
**OA 066** 

**PAPER FILTER**



**OA 201**  
Single use 100 pcs  
with indicator. Diameter:  
184 mm

**TEFLON FILTER**



**OA 101**  
Number of sterilization  
cycle > 2000  
• Diameter: 194 mm



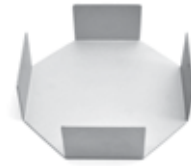



**FILTER DISPENSER**

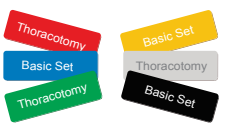

**OA 401**

**IDENTIFICATION LABELS (aluminium)**

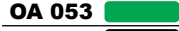

**OA 013**   
**OA 023**   
**OA 033**   
**OA 043**   
**OA 053**   
**OA 063** 

**LABELS (paper)**

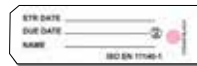

**OA 001**  
100 pcs. With indicator.  
For small size and  
special containers

**LABELS (paper)**



**OA 002**  
100 pcs. With indicator.  
For full and  
Half size containers



**SECURITY SEAL (blue)**

**OA 742**  
100 pcs. with indicator.  
made of plastic



**SECURITY SEAL (red)**

**OA 732**  
100 pcs. with indicator.  
made of plastic



**AUTO LOCK MECHANISM**

**OA 703**  
(2 Pcs)



**SECURITY SEAL (blue)**

**OA 741**  
100 pcs. made of plastic



**SECURITY SEAL (red)**

**OA 731**  
100 pcs. made of plastic



**DISPOSAL STAMP**

**OA 008**  
40 x 35 x 9 mm  
Requested number or  
letter must be informed  
during the order.



**LABEL HOLDER**

**OA 007**  
50 x 35 x 13 mm  
Holder for identification  
labels

# ***STERILE CONTAINER SYSTEM***

## ***BASIC MODEL***



» 3/4 MEDIUM SIZE

## 3/4 MIDDELE SIZE MODEL

W: 285 mm

L: 475 mm

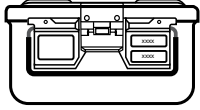

Specifications		Lid (Perforated)		Safety Lid	
		Box (Non Perforated)	Box (Perforated)	Box (Non Perforated)	Box (Perforated)
H:110 mm		OC 110.10	OC 111.10	OC 112.10	OC 113.10
		OC 120.10	OC 121.10	OC 122.10	OC 123.10
		OC 130.10	OC 131.10	OC 132.10	OC 133.10
		OC 140.10	OC 141.10	OC 142.10	OC 143.10
		OC 150.10	OC 151.10	OC 152.10	OC 153.10
		OC 160.10	OC 161.10	OC 162.10	OC 163.10
H:130 mm		OC 110.13	OC 111.13	OC 112.13	OC 113.13
		OC 120.13	OC 121.13	OC 122.13	OC 123.13
		OC 130.13	OC 131.13	OC 132.13	OC 133.13
		OC 140.13	OC 141.13	OC 142.13	OC 143.13
		OC 150.13	OC 151.13	OC 152.13	OC 153.13
		OC 160.13	OC 161.13	OC 162.13	OC 163.13
H:155 mm		OC 110.15	OC 111.15	OC 112.16	OC 113.16
		OC 120.15	OC 121.15	OC 122.16	OC 123.16
		OC 130.15	OC 131.15	OC 132.16	OC 133.16
		OC 140.15	OC 141.15	OC 142.16	OC 143.16
		OC 150.15	OC 151.15	OC 152.16	OC 153.16
		OC 160.15	OC 161.15	OC 162.16	OC 163.16

Ps: All container measurements cover the outer size of the lids.

**BOX (perforated)**

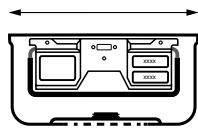
**outside dimension**

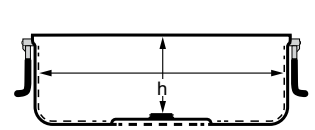
**outside dimension**

**inside dimension**

code	outside dimension	inside dimension	weight
<b>OC 11.10</b>	475 x 272 h:100 mm	422 x 258 h:83 mm	1792 g
<b>OC 11.11</b>	475 x 272 h:116 mm	422 x 258 h:99 mm	1836 g
<b>OC 11.13</b>	475 x 272 h:138 mm	422 x 258 h:121 mm	1980 g
<b>OC 11.18</b>	475 x 272 h:185 mm	422 x 258 h:168 mm	2240 g

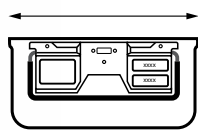

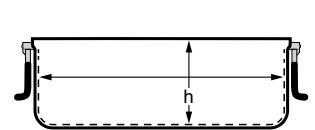



**BOX (non perforated)**

**outside dimension**

**outside dimension**

**inside dimension**







code	outside dimension	inside dimension	weight
<b>OC 10.10</b>	475 x 272 h:100 mm	422 x 258 h:94 mm	1609 g
<b>OC 10.11</b>	475 x 272 h:116 mm	422 x 258 h:110 mm	1714 g
<b>OC 10.13</b>	475 x 272 h:138 mm	422 x 258 h:132 mm	1842 g
<b>OC 10.18</b>	475 x 272 h:185 mm	422 x 258 h:179 mm	2117 g

**PERFORATED LIDS**

code	color	weight
<b>OC 111</b>		1005 g
<b>OC 121</b>		
<b>OC 131</b>		
<b>OC 141</b>		
<b>OC 151</b>		
<b>OC 161</b>		







Dimension: 477 x 285 mm

**REMOVAL LIDS (non perforated)**

code	color	weight
<b>OC 112</b>		940 g
<b>OC 122</b>		
<b>OC 132</b>		
<b>OC 142</b>		
<b>OC 152</b>		
<b>OC 162</b>		

Dimension: 477 x 285 mm

**SAFETY LIDS**

code	color	weight
<b>OC 113</b>		903 g
<b>OC 123</b>		
<b>OC 133</b>		
<b>OC 143</b>		
<b>OC 153</b>		
<b>OC 163</b>		

Dimension: 483 x 290 mm

## BASKET MADE FROM STAINLESS STEEL WIRE MESH

### WIRE BASKET

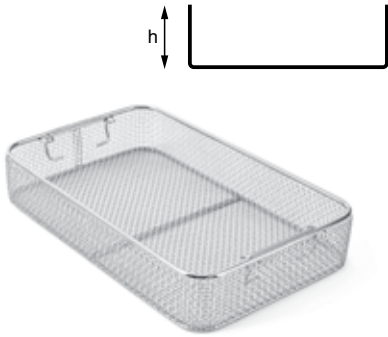

code	outside dimension
<b>OW 110.03</b>	405 x 245 x h:30 mm
<b>OW 110.05</b>	405 x 245 x h:50 mm
<b>OW 110.07</b>	405 x 245 x h:70 mm
<b>OW 110.10</b>	405 x 245 x h:100 mm



### WIRE BASKET WITH LID

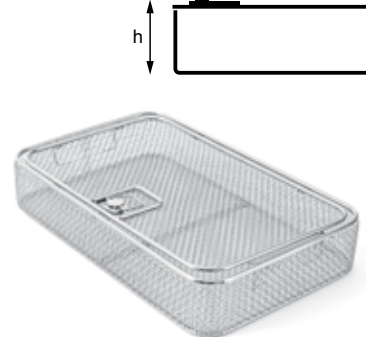

code	outside dimension
<b>OW 111.03</b>	405 x 245 h:35 mm
<b>OW 111.05</b>	405 x 245 h:55 mm
<b>OW 111.07</b>	405 x 245 h:75 mm
<b>OW 111.10</b>	405 x 245 h:105 mm
<b>OW 111</b>	ONLY LID, for baskets



## WIRE BASKET WITH PERFORATED METAL PLATE

### WIRE BASKET



code	outside dimension
<b>OM 110.05</b>	405 x 246 x h:50 mm
<b>OM 110.07</b>	405 x 246 x h:70 mm
<b>OM 110.10</b>	405 x 246 x h:100 mm



### WIRE BASKET WITH LID



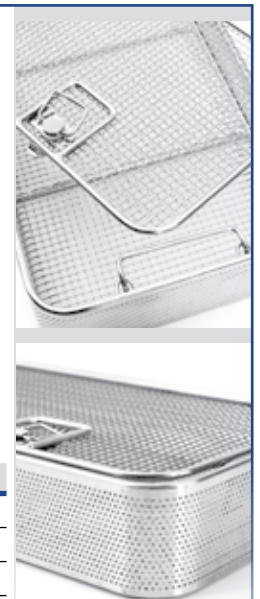

code	outside dimension
<b>OM 111.05</b>	405 x 246 x h:55 mm
<b>OM 111.07</b>	405 x 246 x h:75 mm
<b>OM 111.10</b>	405 x 246 x h:105 mm
<b>OM 111</b>	ONLY LID, for baskets



## BASKET MADE FROM STAINLESS STEEL SHEET

### BASKET

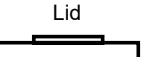

	code	outside dimension
Box and Lid 	<b>OP 111.03</b>	411 x 259 h:34 mm
	<b>OP 111.05</b>	411 x 259 h:54 mm
	<b>OP 111.07</b>	411 x 259 h:74 mm
	<b>OP 111.10</b>	411 x 259 h:104 mm
Box 	<b>OP 110.03</b>	405 x 253 h:40 mm
	<b>OP 110.05</b>	405 x 253 h:50 mm
	<b>OP 110.07</b>	405 x 253 h:70 mm
	<b>OP 110.10</b>	405 x 253 h:100 mm
Lid 	<b>OP 111</b>	ONLY LID, for baskets

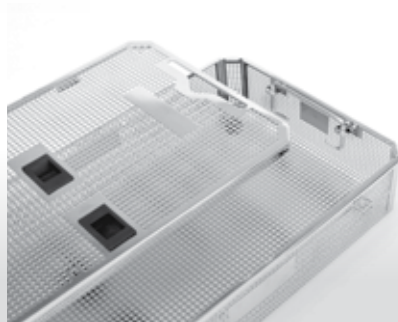

### STAND

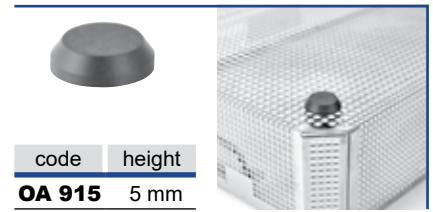

### IDENTIFICATION (aluminium)

#### LABEL HOLDER



#### LABELS



code	color
<b>OA 014</b>	Grey
<b>OA 024</b>	Yellow
<b>OA 034</b>	Red
<b>OA 044</b>	Blue
<b>OA 054</b>	Green
<b>OA 064</b>	Black

Coloured identification labels  
Engraved to your specification



 Grey coloured recommended for use in low temperature sterilization.  
Color fading By effect of Hydrogen Peroxide Gas Plasma on other colors.

**DIVIDERS**



**OA 944.08**  
405 x 250 x 80 mm  
**OA 944.11**  
405 x 250 x 110 mm  
**OA 944.13**  
405 x 250 x 130 mm

**WIRE BASE**



**OA 943.03**  
405 x 255 x 30 mm

**DIVIDERS**

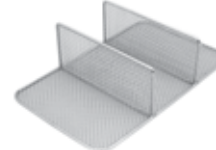

**OA 945.08**  
405 x 250 x 80 mm  
**OA 945.11**  
405 x 250 x 110 mm  
**OA 945.13**  
405 x 250 x 130 mm

(-)

**DRAPE RETAINER**



**OA 965.03**  
405 x 255 x 30 mm

**DRAPE RETAINER**



**OA 965**  
405 x 255 mm

**ALUMINIUM BASKET (with lid)**



**OB 01.05**  
245 x 130 x 55 mm

**ALUMINIUM BASKET (with lid)**



**OB 01.07**  
245 x 130 x 70 mm

**ALUMINIUM BASKET (with lid)**



**OB 01.10**  
245 x 130 x 105 mm

**SILICONE MAT**



**OA 506**  
380 x 230 mm  
**OA 507**  
440 x 230 mm

**SILICONE MESH MAT**

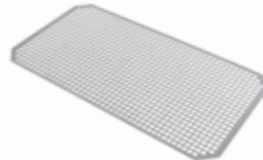

**OA 604**  
395 x 245 mm

**SILICONE HANDLE**



**OA 016**  
**OA 026**  
**OA 036**  
**OA 046**  
**OA 056**  
**OA 066**

**PAPER FILTER**



**OA 201**  
Single use 100 pcs  
with indicator.  
• Diameter: 184 mm

**TEFLON FILTER**



**OA 101**  
Number of sterilization  
cycle > 2000  
• Diameter: 194 mm

**FILTER DISPENSER**

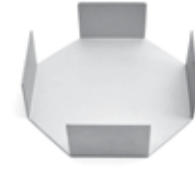

**OA 401**

**IDENTIFICATION LABELS (aluminium)**



**OA 013**  
**OA 023**  
**OA 033**  
**OA 043**  
**OA 053**  
**OA 063**

**LABELS (paper)**

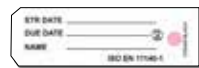

**OA 001**  
100 pcs. With indicator.  
For small size and  
special containers

**LABELS (paper)**

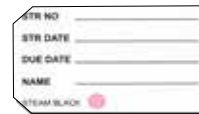

**OA 002**  
100 pcs. With indicator.  
For full and  
Half size containers



**SECURITY SEAL (blue)**

**OA 742**  
100 pcs. with indicator.  
made of plastic



**SECURITY SEAL (blue)**

**OA 741**  
100 pcs. made of plastic



**SECURITY SEAL (red)**

**OA 732**  
100 pcs. with indicator.  
made of plastic



**SECURITY SEAL (red)**

**OA 731**  
100 pcs. made of plastic



**DISPOSAL STAMP**

**OA 008**  
40 x 35 x 9 mm  
Requested number or  
letter must be informed  
during the order.



**AUTO LOCK  
MECHANISM**

**OA 703**  
(2 Pcs)



**LABEL HOLDER**

**OA 007**  
50 x 35 x 13 mm  
Holder for identification  
labels

# ***STERILE CONTAINER SYSTEM BASIC MODEL***











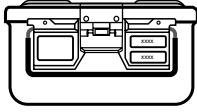

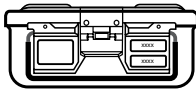























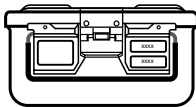























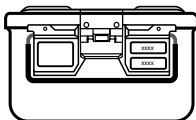























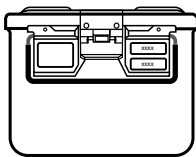























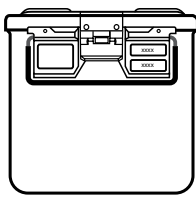













» 1/2 HALF SIZE

# 1/2 HALF SIZE MODEL

W: 280 mm

L: 310 mm



Specifications		Lid (Perforated)	Lid (Perforated)	Safety Lid	Safety Lid
		Box (Non Perforated)	Box (Perforated)	Box (Non Perforated)	Box (Perforated)
Height H:110 mm		OC 210.10 	OC 211.10 	OC 212.10 	OC 213.10 
		OC 220.10 	OC 221.10 	OC 222.10 	OC 223.10 
		OC 230.10 	OC 231.10 	OC 232.10 	OC 233.10 
		OC 240.10 	OC 241.10 	OC 242.10 	OC 243.10 
		OC 250.10 	OC 251.10 	OC 252.10 	OC 253.10 
		OC 260.10 	OC 261.10 	OC 262.10 	OC 263.10 
Height H:130 mm		OC 210.13 	OC 211.13 	OC 212.13 	OC 213.13 
		OC 220.13 	OC 221.13 	OC 222.13 	OC 223.13 
		OC 230.13 	OC 231.13 	OC 232.13 	OC 233.13 
		OC 240.13 	OC 241.13 	OC 242.13 	OC 243.13 
		OC 250.13 	OC 251.13 	OC 252.13 	OC 253.13 
		OC 260.13 	OC 261.13 	OC 262.13 	OC 263.13 
Height H:150 mm		OC 210.15 	OC 211.15 	OC 212.15 	OC 213.15 
		OC 220.15 	OC 221.15 	OC 222.15 	OC 223.15 
		OC 230.15 	OC 231.15 	OC 232.15 	OC 233.15 
		OC 240.15 	OC 241.15 	OC 242.15 	OC 243.15 
		OC 250.15 	OC 251.15 	OC 252.15 	OC 253.15 
		OC 260.15 	OC 261.15 	OC 262.15 	OC 263.15 
Height H:200 mm		OC 210.20 	OC 211.20 	OC 212.20 	OC 213.20 
		OC 220.20 	OC 221.20 	OC 222.20 	OC 223.20 
		OC 230.20 	OC 231.20 	OC 232.20 	OC 233.20 
		OC 240.20 	OC 241.20 	OC 242.20 	OC 243.20 
		OC 250.20 	OC 251.20 	OC 252.20 	OC 253.20 
		OC 260.20 	OC 261.20 	OC 262.20 	OC 263.20 
Height H:250 mm		OC 210.25 	OC 211.25 	OC 212.26 	OC 213.26 
		OC 220.25 	OC 221.25 	OC 222.26 	OC 223.26 
		OC 230.25 	OC 231.25 	OC 232.26 	OC 233.26 
		OC 240.25 	OC 241.25 	OC 242.26 	OC 243.26 
		OC 250.25 	OC 251.25 	OC 252.26 	OC 253.26 
		OC 260.25 	OC 261.25 	OC 262.26 	OC 263.26 

Ps: All container measurements cover the outer size of the lids.

**BOX (perforated)**

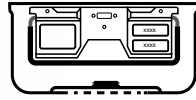
**outside dimension**

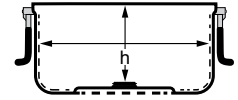
**outside dimension**

**inside dimension**

code	outside dimension	inside dimension	weight
<b>OC 21.10</b>	310 x 272 h:100 mm	253 x 258 h:83 mm	1385 g
<b>OC 21.11</b>	310 x 272 h:116 mm	253 x 258 h:99 mm	1417 g
<b>OC 21.13</b>	310 x 272 h:138 mm	253 x 258 h:121 mm	1590 g
<b>OC 21.19</b>	310 x 272 h:190 mm	253 x 258 h:173 mm	1821 g
<b>OC 21.23</b>	310 x 272 h:235 mm	253 x 258 h:218 mm	1947 g

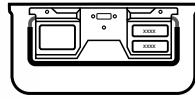

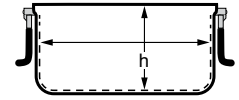



**BOX (non perforated)**

**outside dimension**

**outside dimension**

**inside dimension**







code	outside dimension	inside dimension	weight
<b>OC 20.10</b>	310 x 272 h:100 mm	253 x 258 h:94 mm	1267 g
<b>OC 20.11</b>	310 x 272 h:116 mm	253 x 258 h:110 mm	1315 g
<b>OC 20.13</b>	310 x 272 h:138 mm	253 x 258 h:132 mm	1427 g
<b>OC 20.19</b>	310 x 272 h:190 mm	253 x 258 h:184 mm	1660 g
<b>OC 20.23</b>	310 x 272 h:235 mm	253 x 258 h:229 mm	1940 g

**PERFORATED LIDS**

code	color	weight
<b>OC 211</b>		727 g
<b>OC 221</b>		
<b>OC 231</b>		
<b>OC 241</b>		
<b>OC 251</b>		
<b>OC 261</b>		







Dimension: 312 x 280 mm

**REMOVAL LIDS (non perforated)**

code	color	weight
<b>OC 212</b>		629 g
<b>OC 222</b>		
<b>OC 232</b>		
<b>OC 242</b>		
<b>OC 252</b>		
<b>OC 262</b>		

Dimension: 312 x 280 mm

**SAFETY LIDS**

code	color	weight
<b>OC 213</b>		775 g
<b>OC 223</b>		
<b>OC 233</b>		
<b>OC 243</b>		
<b>OC 253</b>		
<b>OC 263</b>		

Dimension: 317 x 285 mm

## BASKET MADE FROM STAINLESS STEEL WIRE MESH

### WIRE BASKET

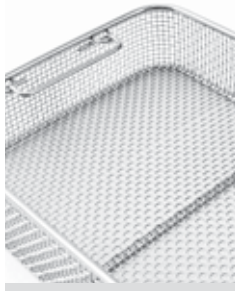
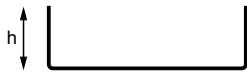

code	outside dimension
<b>OW 210.03</b>	246 x 246 x h:30 mm
<b>OW 210.05</b>	246 x 246 x h:50 mm
<b>OW 210.07</b>	246 x 246 x h:70 mm
<b>OW 210.10</b>	246 x 246 x h:100 mm

### WIRE BASE



code	outside dimension
<b>OW 210</b>	255 x 255 x 30 mm

### WIRE BASKET WITH LID



code	outside dimension
<b>OW 211.03</b>	246 x 246 h:35 mm
<b>OW 211.05</b>	246 x 246 h:55 mm
<b>OW 211.07</b>	246 x 246 h:75 mm
<b>OW 211.10</b>	246 x 246 h:105 mm
<b>OW 211</b>	ONLY LID, for baskets

## WIRE BASKET WITH PERFORATED METAL PLATE

### WIRE BASKET

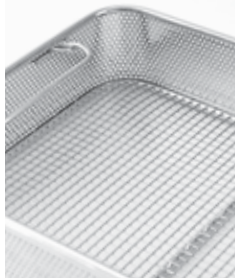

code	outside dimension
<b>OM 210.05</b>	246 x 246 x h:50 mm
<b>OM 210.07</b>	246 x 246 x h:70 mm
<b>OM 210.10</b>	246 x 246 x h:100 mm

### WIRE BASKET WITH LID

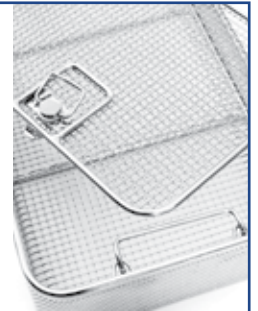

code	outside dimension
<b>OM 211.05</b>	246 x 246 x h:55 mm
<b>OM 211.07</b>	246 x 246 x h:75 mm
<b>OM 211.10</b>	246 x 246 x h:105 mm
<b>OM 211</b>	ONLY LID, for baskets

## BASKET MADE FROM STAINLESS STEEL SHEET

### BASKET

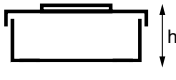
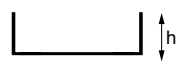
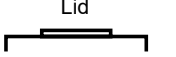

	code	outside dimension
 Box and Lid	<b>OP 211.03</b>	250 x 259 h:34 mm
	<b>OP 211.05</b>	250 x 259 h:54 mm
	<b>OP 211.07</b>	250 x 259 h:74 mm
	<b>OP 211.10</b>	250 x 259 h:104 mm
 Box	<b>OP 210.03</b>	244 x 253 h:30 mm
	<b>OP 210.05</b>	244 x 253 h:50 mm
	<b>OP 210.07</b>	244 x 253 h:70 mm
	<b>OP 210.10</b>	244 x 253 h:100 mm
 Lid	<b>OP 211</b>	ONLY LID, for baskets

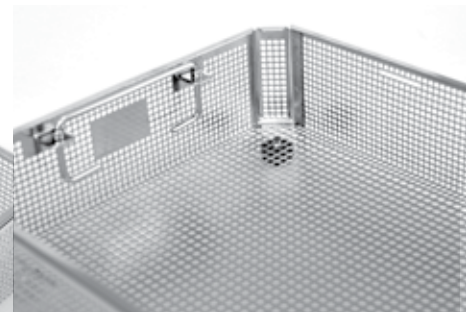
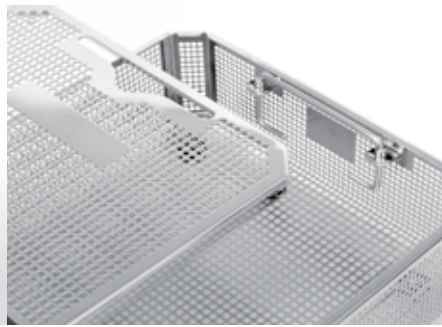

code	height
<b>OA 916</b>	10 mm



### STAND



code	height
<b>OA 915</b>	5 mm

### IDENTIFICATION (aluminium)

#### LABEL HOLDER



code **OA 931**

#### LABELS



code	color
<b>OA 014</b>	Grey
<b>OA 024</b>	Yellow
<b>OA 034</b>	Red
<b>OA 044</b>	Blue
<b>OA 054</b>	Green
<b>OA 064</b>	Black

Coloured identification labels  
Engraved to your specification



 Grey coloured recommended for use in low temperature sterilization.  
Color fading By effect of Hydrogen Peroxide Gas Plasma on other colors.

**DIVIDERS**



**OA 947.13**  
255 x 245 x 130 mm  
**OA 947.18**  
255 x 245 x 180 mm

**WIRE BASE**



**OA 946.03**  
255 x 255 x 30 mm

**RACK (for kerrison)**



**OA 821**  
220 x 250 x 160 mm  
• Holds 10 kerrison punches  
• Fits into a 1/2 and 1/1 size  
• 200 mm deep container  
• Wire basket 1/2 H:50 mm  
• Wire basket 1/1 H:50 mm  
• Container 1/2 H: 200 mm  
• Container 1/1 H:200 mm

**DRAPE RETAINER**



**OA 963.03**  
255 x 255 x 30 mm

**DRAPE RETAINER**



**OA 963**  
255 x 255 mm

**ALUMINIUM BASKET (with lid)**



**OB 01.05**  
245 x 130 x 55 mm

**ALUMINIUM BASKET (with lid)**



**OB 01.07**  
245 x 130 x 70 mm

**ALUMINIUM BASKET (with lid)**



**OB 01.10**  
245 x 130 x 105 mm

**SILICONE MAT**



**OA 503**  
250 x 235 mm



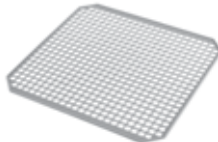



**SILICONE MESH MAT**



**OA 601**  
250 x 240 mm

**SILICONE HANDLE**



**OA 016**   
**OA 026**   
**OA 036**   
**OA 046**   
**OA 056**   
**OA 066** 

**PAPER FILTER**



**OA 201**  
Single use 100 pcs  
with indicator.  
• Diameter: 184 mm

**TEFLON FILTER**



**OA 101**  
Number of sterilization  
cycle > 2000  
• Diameter: 194 mm

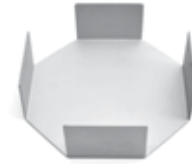

**FILTER DISPENSER**



**OA 401**

**IDENTIFICATION LABELS (aluminium)**

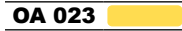
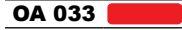
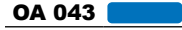
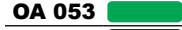

**OA 013**   
**OA 023**   
**OA 033**   
**OA 043**   
**OA 053**   
**OA 063** 

**LABELS (paper)**

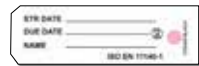

**OA 001**  
100 pcs. With indicator.

For small size and  
special containers

**LABELS (paper)**

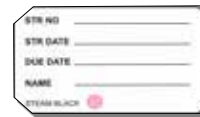

**OA 002**  
100 pcs. With indicator.

For full and  
Half size containers



**SECURITY SEAL (blue)**

**OA 742**  
100 pcs. with indicator.  
made of plastic



**SECURITY SEAL (red)**

**OA 732**  
100 pcs. with indicator.  
made of plastic



**DISPOSAL STAMP**

**OA 008**  
40 x 35 x 9 mm  
Requested number or  
letter must be informed  
during the order.



**AUTO LOCK  
MECHANISM**

**OA 703**  
(2 Pcs)



**SECURITY SEAL (blue)**

**OA 741**  
100 pcs. made of plastic



**SECURITY SEAL (red)**

**OA 731**  
100 pcs. made of plastic



**LABEL HOLDER**

**OA 007**  
50 x 35 x 13 mm  
Holder for identification  
labels

# ***STERILE CONTAINER SYSTEM***

## ***BASIC MODEL***



» LARGE SIZE









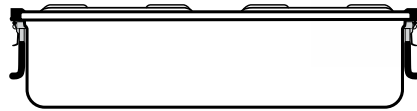
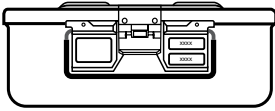



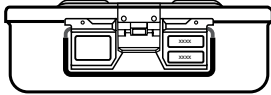





















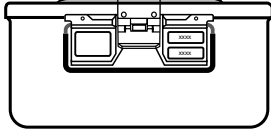













## LARGE SIZE MODEL



W: 372 mm

L: 600 mm



Specifications		Lid (Perforated)	
			
Height		Box (Non Perforated)	Box (Perforated)
	H: 120 mm		<b>OC 310.12</b>  
<b>OC 320.12</b>  			<b>OC 321.12</b>  
<b>OC 330.12</b>  			<b>OC 331.12</b>  
<b>OC 340.12</b>  			<b>OC 341.12</b>  
<b>OC 350.12</b>  			<b>OC 351.12</b>  
<b>OC 360.12</b>  			<b>OC 361.12</b>  
H: 185 mm		<b>OC 310.18</b>  	<b>OC 311.18</b>  
		<b>OC 320.18</b>  	<b>OC 321.18</b>  
		<b>OC 330.18</b>  	<b>OC 331.18</b>  
		<b>OC 340.18</b>  	<b>OC 341.18</b>  
		<b>OC 350.18</b>  	<b>OC 351.18</b>  
		<b>OC 360.18</b>  	<b>OC 361.18</b>  

Ps: All container measurements cover the outer size of the lids.

**BOX (perforated)**

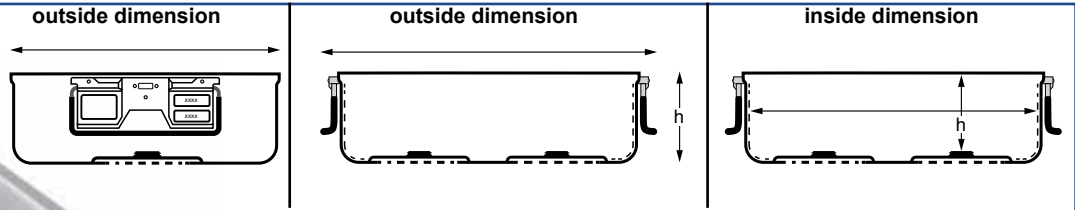

code	outside dimension	inside dimension	weight
<b>OC 31.10</b>	600 x 365 h:105 mm	543 x 350 h:88 mm	2480 g
<b>OC 31.16</b>	600 x 365 h:167 mm	543 x 350 h:150 mm	3122 g

**BOX (non perforated)**

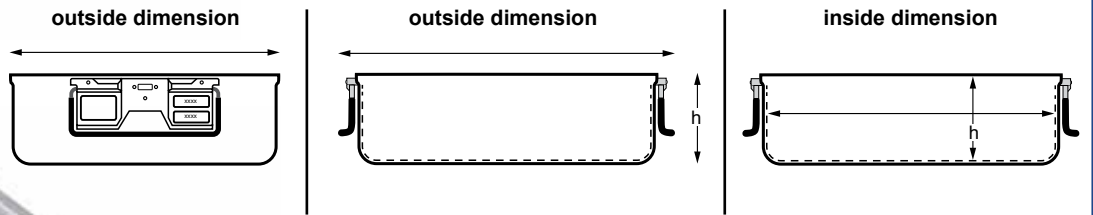







code	outside dimension	inside dimension	weight
<b>OC 30.10</b>	600 x 365 h:105 mm	543 x 350 h:99 mm	2271 g
<b>OC 30.16</b>	600 x 365 h:167 mm	543 x 350 h:161 mm	2856 g

**PERFORATED LIDS**

Dimension: 602 x 370 mm









code	color	weight
<b>OC 311</b>		1076 g
<b>OC 321</b>		
<b>OC 331</b>		
<b>OC 341</b>		
<b>OC 351</b>		
<b>OC 361</b>		

**REMOVAL LIDS (non perforated)**

Dimension: 602 x 370 mm



code	color	weight
<b>OC 312</b>		1405 g
<b>OC 322</b>		
<b>OC 332</b>		
<b>OC 342</b>		
<b>OC 352</b>		
<b>OC 362</b>		

## BASKET MADE FROM STAINLESS STEEL WIRE MESH

### WIRE BASKET



code	outside dimension
<b>OW 310.05</b>	533 x 337 h:50 mm
<b>OW 310.07</b>	533 x 337 h:70 mm
<b>OW 310.10</b>	533 x 337 h:100 mm



### WIRE BASKET WITH LID



code	outside dimension
<b>OW 311.05</b>	533 x 337 h:55 mm
<b>OW 311.07</b>	533 x 337 h:75 mm
<b>OW 311.10</b>	533 x 337 h:105 mm
<b>OW 311</b>	ONLY LID, for baskets

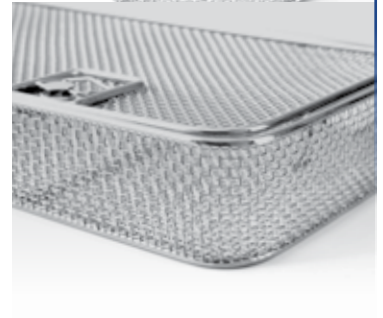

## IDENTIFICATION (aluminium)

### LABEL HOLDER



code **OA 931**

### LABELS



code	color
<b>OA 014</b>	Grey
<b>OA 024</b>	Yellow
<b>OA 034</b>	Red
<b>OA 044</b>	Blue
<b>OA 054</b>	Green
<b>OA 064</b>	Black

Coloured identification labels  
Engraved to your specification





➡ Grey coloured recommended for use in low temperature sterilization.  
Color fading By effect of Hydrogen Peroxide Gas Plasma on other colors.

## BASKET MADE FROM STAINLESS STEEL SHEET

### BASKET

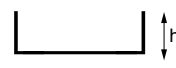

	code	outside dimension
Box and Lid 	<b>OP 311.03</b>	539 x 346 h:34 mm
	<b>OP 311.05</b>	539 x 346 h:54 mm
	<b>OP 311.07</b>	539 x 346 h:74 mm
	<b>OP 311.10</b>	539 x 346 h:104 mm
Box 	<b>OP 310.03</b>	533 x 340 h:30 mm
	<b>OP 310.05</b>	533 x 340 h:50 mm
	<b>OP 310.07</b>	533 x 340 h:70 mm
	<b>OP 310.10</b>	533 x 340 h:100 mm
Lid 	<b>OP 311</b>	ONLY LID, for baskets

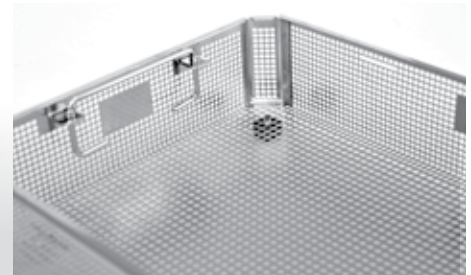
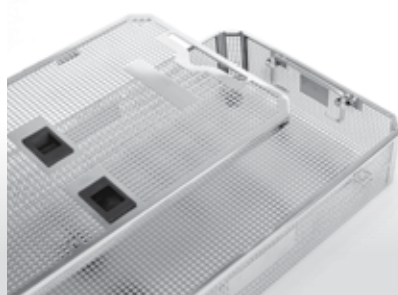

code	height
<b>OA 916</b>	10 mm



### STAND



code	height
<b>OA 915</b>	5 mm



**DIVIDERS**



**OA 948.07**  
533 x 337 x70 mm  
**OA 948.12**  
533 x 337 x 120 mm

**DIVIDERS**



**OA 949.07**  
533 x 337 x70 mm  
**OA 949.12**  
533 x 337 x 120 mm

( - )

**DRAPE RETAINER**



**OA 966.03**  
533 x 337 x 30 mm

**DRAPE RETAINER**



**OA 966**  
533 x 337 mm

( - )



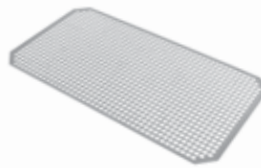



**SILICONE MESH MAT**



**OA 605**  
527 x 335 mm

**SILICONE HANDLE**



**OA 016**   
**OA 026**   
**OA 036**   
**OA 046**   
**OA 056**   
**OA 066** 

**ALUMINIUM BASKET (with lid)**



**OB 01.05**  
245 x 130 x 55 mm

**ALUMINIUM BASKET (with lid)**



**OB 01.07**  
245 x 130 x 70 mm

**ALUMINIUM BASKET (with lid)**



**OB 01.10**  
245 x 130 x 105 mm

**PAPER FILTER**



**OA 201**  
Single use 100 pcs  
with indicator.  
Diameter: 184 mm

**TEFLON FILTER**



**OA 101**  
Number of sterilization  
cycle > 2000  
• Diameter: 194 mm

**FILTER DISPENSER**

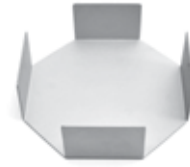

**OA 401**

**IDENTIFICATION LABELS (aluminium)**

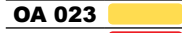
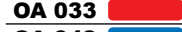
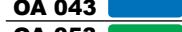
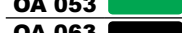
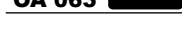

**OA 013**   
**OA 023**   
**OA 033**   
**OA 043**   
**OA 053**   
**OA 063** 

**LABELS (paper)**



**OA 001**  
100 pcs. With indicator.  
For small size and  
special containers

**LABELS (paper)**

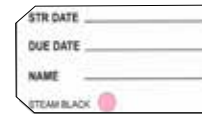

**OA 002**  
100 pcs. With indicator.  
For full and  
Half size containers



**SECURITY SEAL (blue)**

**OA 742**  
100 pcs. with indicator.  
made of plastic



**SECURITY SEAL (blue)**

**OA 741**  
100 pcs. made of plastic



**SECURITY SEAL (red)**

**OA 732**  
100 pcs. with indicator.  
made of plastic



**SECURITY SEAL (red)**

**OA 731**  
100 pcs. made of plastic



**DISPOSAL STAMP**

**OA 008**  
40 x 35 x 9 mm  
Requested number or  
letter must be informed  
during the order.



**AUTO LOCK MECHANISM**

**OA 703**  
(2 Pcs)



**LABEL HOLDER**

**OA 007**  
50 x 35 x 13 mm  
Holder for identification  
labels

# ***STERILE CONTAINER SYSTEM***

## ***BASIC MODEL***



» LONG SIZE









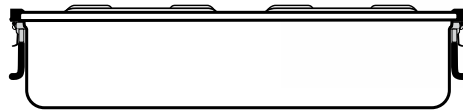
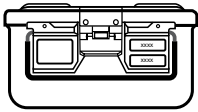

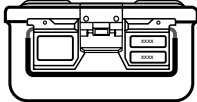









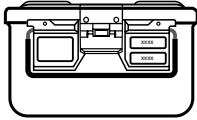

## LONG SIZE MODEL



W: 285 mm

L: 725 mm



Specifications		Lid (Perforated)	
		Box (Non Perforated)	Box (Perforated)
H: 140 mm		<b>OC 410.14</b> 	<b>OC 411.14</b> 
		<b>OC 420.14</b> 	<b>OC 421.14</b> 
		<b>OC 430.14</b> 	<b>OC 431.14</b> 
		<b>OC 440.14</b> 	<b>OC 441.14</b> 
		<b>OC 450.14</b> 	<b>OC 451.14</b> 
		<b>OC 460.14</b> 	<b>OC 461.14</b> 
		H: 205 mm	
<b>OC 420.20</b> 	<b>OC 421.20</b> 		
<b>OC 430.20</b> 	<b>OC 431.20</b> 		
<b>OC 440.20</b> 	<b>OC 441.20</b> 		
<b>OC 450.20</b> 	<b>OC 451.20</b> 		
<b>OC 460.20</b> 	<b>OC 461.20</b> 		

Ps: All container measurements cover the outer size of the lids.

### BOX (perforated)



outside dimension

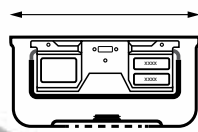

outside dimension



inside dimension



code	outside dimension	inside dimension	weight
<b>OC 41.12</b>	725 x 272 h:127 mm	687 x 258 h:110 mm	2646 g
<b>OC 41.19</b>	725 x 272 h:192 mm	687 x 258 h:175 mm	3136 g

### BOX (non perforated)



outside dimension

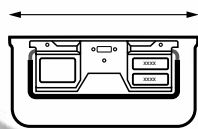

outside dimension

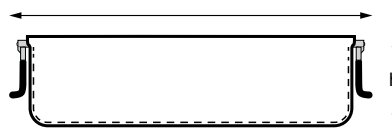

inside dimension

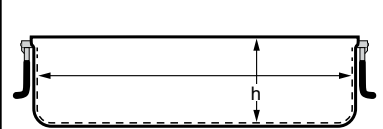







code	outside dimension	inside dimension	weight
<b>OC 40.12</b>	725 x 272 h:127 mm	687 x 258 h:121 mm	2446 g
<b>OC 40.19</b>	725 x 272 h:192 mm	687 x 258 h:186 mm	2974 g

### PERFORATED LIDS

Dimension: 726 x 285 mm









code	color	weight
<b>OC 411</b>		1348 g
<b>OC 421</b>		
<b>OC 431</b>		
<b>OC 441</b>		
<b>OC 451</b>		
<b>OC 461</b>		

### REMOVAL LIDS (non perforated)

Dimension: 726 x 285 mm



code	color	weight
<b>OC 412</b>		1287 g
<b>OC 422</b>		
<b>OC 432</b>		
<b>OC 442</b>		
<b>OC 452</b>		
<b>OC 462</b>		

## BASKET MADE FROM STAINLESS STEEL WIRE MESH

### WIRE BASKET



code	outside dimension
<b>OW 410.05</b>	665 x 250 h:50 mm
<b>OW 410.07</b>	665 x 250 h:70 mm
<b>OW 410.10</b>	665 x 250 h:100 mm

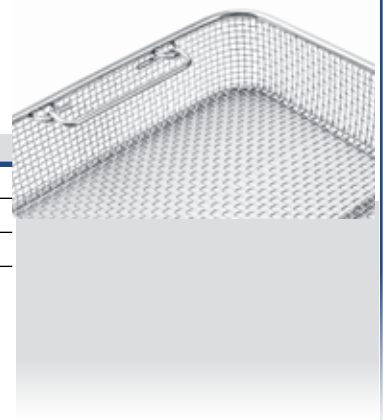

### WIRE BASKET WITH LID



code	outside dimension
<b>OW 411.05</b>	665 x 250 h:55 mm
<b>OW 411.07</b>	665 x 250 h:75 mm
<b>OW 411.10</b>	665 x 250 h:105 mm
<b>OW 411</b>	ONLY LID, for baskets

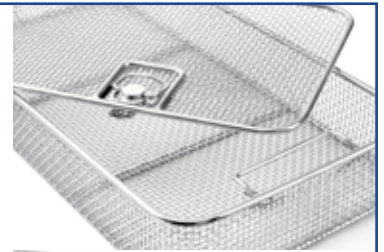

## IDENTIFICATION (aluminium)

### LABEL HOLDER



code **OA 931**

### LABELS



code	color
<b>OA 014</b>	Grey
<b>OA 024</b>	Yellow
<b>OA 034</b>	Red
<b>OA 044</b>	Blue
<b>OA 054</b>	Green
<b>OA 064</b>	Black

Coloured identification labels  
Engraved to your specification





➔ Grey coloured recommended for use in low temperature sterilization.  
Color fading By effect of Hydrogen Peroxide Gas Plasma on other colors.

## BASKET MADE FROM STAINLESS STEEL SHEET

### BASKET

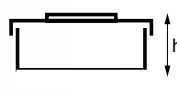

	code	outside dimension
Box and Lid 	<b>OP 411.03</b>	671 x 259 h:34 mm
	<b>OP 411.05</b>	671 x 259 h:54 mm
	<b>OP 411.07</b>	671 x 259 h:74 mm
	<b>OP 411.10</b>	671 x 259 h:104 mm
Box 	<b>OP 410.03</b>	665 x 253 h:30 mm
	<b>OP 410.05</b>	665 x 253 h:50 mm
	<b>OP 410.07</b>	665 x 253 h:70 mm
	<b>OP 410.10</b>	665 x 253 h:100 mm
Lid 	<b>OP 411</b>	ONLY LID, for baskets

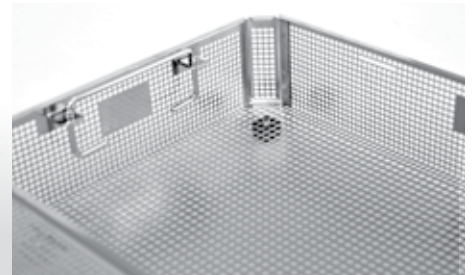
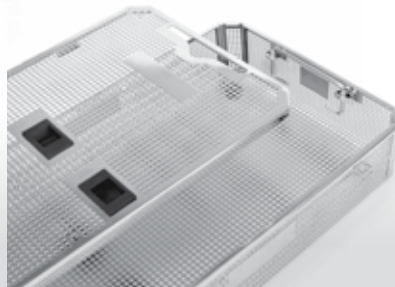

code	height
<b>OA 916</b>	10 mm



### STAND



code	height
<b>OA 915</b>	5 mm

### RACK (for endoscopy)

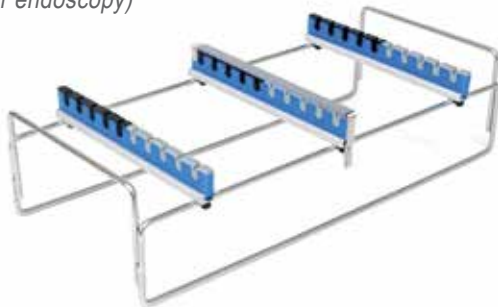

**OA 802**  
550 x 250 x 130 mm

- Holds 10 endoscopic instruments
- Fits into a Long size 18 cm deep container
- Wire basket Long 50 mm
- Container Long 180 mm
- Silicone mat 340x230 (2pcs)

### RACK (for kerrison)



**OA 821**  
220 x 250 x 160 mm

- Holds 10 kerrison punches
- Fits into a 1/2, 1/1 H:200 mm and Long size 18 cm deep container
- Wire basket 1/2 ,H:50 mm
- Wire basket 1/1 ,H:50 mm
- Container 1/2 200 mm
- Container 1/1 200 mm
- Wire basket long ,H 50 mm
- Container Long Size 180 mm

**DIVIDERS**



**OA 941.13**  
540 x 250 x 130 mm  
**OA 941.18**  
540 x 250 x 180 mm

**WIRE BASE**



**OA 940.03**  
545 x 255 x 30 mm

**DIVIDERS**

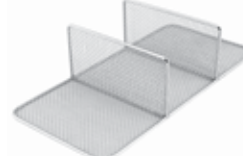

**OA 942.13**  
540 x 250 x 130 mm  
**OA 942.18**  
540 x 250 x 180 mm

**ALUMINIUM BASKET (with lid)**



**OB 01.05**  
245 x 130 x 55 mm

**ALUMINIUM BASKET (with lid)**



**OB 01.07**  
245 x 130 x 70 mm

**ALUMINIUM BASKET (with lid)**



**OB 01.10**  
245 x 130 x 105 mm

**SILICONE MAT**



**OA 504**  
340 x 230 mm  
(2 pcs)



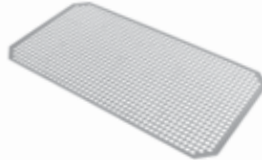



**SILICONE MESH MAT**



**OA 606**  
658 x 247 mm

**SILICONE HANDLE**



**OA 016**   
**OA 026**   
**OA 036**   
**OA 046**   
**OA 056**   
**OA 066** 

**PAPER FILTER**



**OA 201**  
Single use 100 pcs  
with indicator.  
• Diameter: 184 mm

**TEFLON FILTER**



**OA 101**  
Number of sterilization  
cycle > 2000  
• Diameter: 194 mm



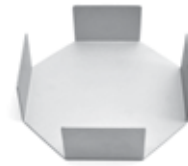

**FILTER DISPENSER**

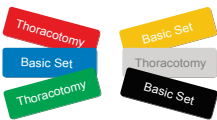

**OA 401**

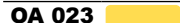
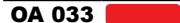
**IDENTIFICATION LABELS (aluminium)**



**OA 013**   
**OA 023**   
**OA 033**   
**OA 043**   
**OA 053**   
**OA 063** 

**LABELS (paper)**

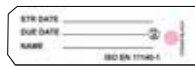

**OA 001**  
100 pcs. With indicator.  
  
For small size and  
special containers

**LABELS (paper)**

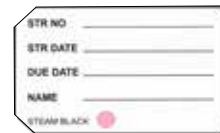

**OA 002**  
100 pcs. With indicator.  
  
For full and  
Half size containers



**SECURITY SEAL (blue)**

**OA 742**  
100 pcs. with indicator.  
made of plastic



**SECURITY SEAL (red)**

**OA 732**  
100 pcs. with indicator.  
made of plastic



**DISPOSAL STAMP**

**OA 008**  
40 x 35 x 9 mm  
Requested number or  
letter must be informed  
during the order.



**AUTO LOCK  
MECHANISM**

**OA 703**  
(2 Pcs)



**SECURITY SEAL (blue)**

**OA 741**  
100 pcs. made of plastic



**SECURITY SEAL (red)**

**OA 731**  
100 pcs. made of plastic



**LABEL HOLDER**

**OA 007**  
50 x 35 x 13 mm  
Holder for identification  
labels

# STERILE CONTAINER SYSTEM

## BIO-BARRIER MODEL



**1/1 FULL SIZE**

**3/4 QUARTER SIZE**



**1/2 HALF SIZE**

**LARGE SIZE**

**LONG SIZE**



**ORSAMTIP Bio-Barrier model sterilization container systems** are designed with mechanical valves which run in a way that they do not need any disposable filter use. The mechanical valve systems runs with atmospheric pressure occurring in the autoclave during sterilization.

**ORSAMTIP Bio-Barrier model sterilization container systems** are manufactured as five different length, width and height and can be supplied with safety lids for effective external protection. These safety lids do not interfere with sterilization and they provides protection to the valve mechanism against liquids and dust as a second lid.



*During sterilization The Barrier Model valves have the three different positions as shown in photos below:*

- 1 Before sterilization cycle the valves of the Bio-Barrier Model Container are closed and in relax position.

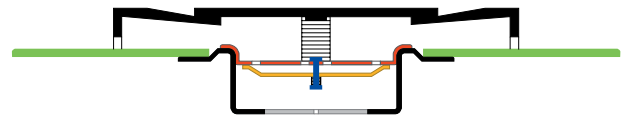

- 2 At the beggining of the sterilization cycle, by the effect of vacuum the valves are opened completely which allowed dry air to goes out of the container.

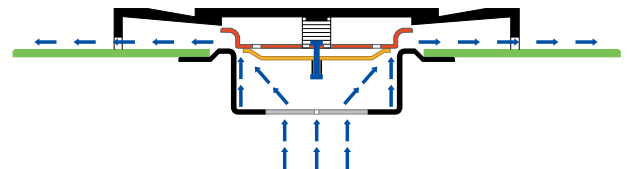

- 3 During the sterilization cycle the valves are opened with effect of pressure in the reverse direction (on the opposite way when it opened by the effect of vacuum.

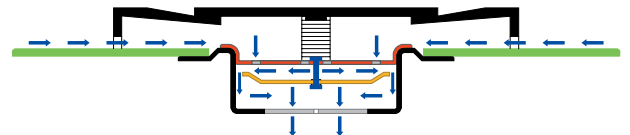

- 4 At the end of the sterilization cycle ;the autoclave equates the pressure level and the valves opened in the direction when it is opened by effect of vacuum.

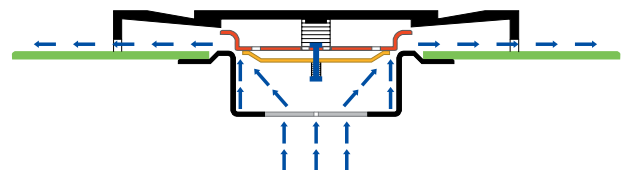

- 5 After sterilization cycle the valves of the Barrier Model Container are closed and in relax position.

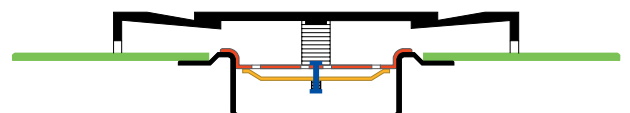

# ***STERILE CONTAINER SYSTEM***

## ***BIO-BARRIER MODEL***











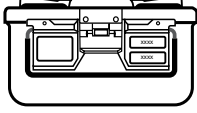

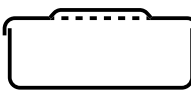



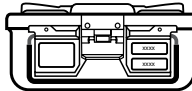























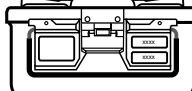























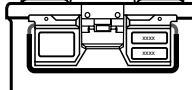























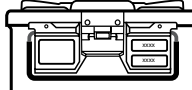























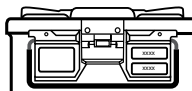













» 1/1 FULL SIZE

# 1/1 FULL SIZE BIO BARRIERE MODEL

W: 285 mm

L: 600 mm



	Lid (with barrier)	Lid (with barrier)	Safety Lid Lid (with barrier)	Safety Lid Lid (with barrier)					
									
	Box (Non Perforated)	Box (with barrier)	Box (Non Perforated)	Box (with barrier)					
	<b>OC 010.12B</b>  <b>OC 020.12B</b>  <b>OC 030.12B</b>  <b>OC 040.12B</b>  <b>OC 050.12B</b>  <b>OC 060.12B</b> 	<b>OC 011.13B</b>  <b>OC 021.13B</b>  <b>OC 031.13B</b>  <b>OC 041.13B</b>  <b>OC 051.13B</b>  <b>OC 061.13B</b> 	<b>OC 012.13B</b>  <b>OC 022.13B</b>  <b>OC 032.13B</b>  <b>OC 042.13B</b>  <b>OC 052.13B</b>  <b>OC 062.13B</b> 	<b>OC 013.14B</b>  <b>OC 023.14B</b>  <b>OC 033.14B</b>  <b>OC 043.14B</b>  <b>OC 053.14B</b>  <b>OC 063.14B</b> 	h:120 mm h:130 mm h:140 mm				
		<b>OC 010.14B</b>  <b>OC 020.14B</b>  <b>OC 030.14B</b>  <b>OC 040.14B</b>  <b>OC 050.14B</b>  <b>OC 060.14B</b> 	<b>OC 011.15B</b>  <b>OC 021.15B</b>  <b>OC 031.15B</b>  <b>OC 041.15B</b>  <b>OC 051.15B</b>  <b>OC 061.15B</b> 	<b>OC 012.15B</b>  <b>OC 022.15B</b>  <b>OC 032.15B</b>  <b>OC 042.15B</b>  <b>OC 052.15B</b>  <b>OC 062.15B</b> 	<b>OC 013.16B</b>  <b>OC 023.16B</b>  <b>OC 033.16B</b>  <b>OC 043.16B</b>  <b>OC 053.16B</b>  <b>OC 063.16B</b> 	h:145 mm h:155 mm h:160 mm			
			<b>OC 010.16B</b>  <b>OC 020.16B</b>  <b>OC 030.16B</b>  <b>OC 040.16B</b>  <b>OC 050.16B</b>  <b>OC 060.16B</b> 	<b>OC 011.17B</b>  <b>OC 021.17B</b>  <b>OC 031.17B</b>  <b>OC 041.17B</b>  <b>OC 051.17B</b>  <b>OC 061.17B</b> 	<b>OC 012.17B</b>  <b>OC 022.17B</b>  <b>OC 032.17B</b>  <b>OC 042.17B</b>  <b>OC 052.17B</b>  <b>OC 062.17B</b> 	<b>OC 013.18B</b>  <b>OC 023.18B</b>  <b>OC 033.18B</b>  <b>OC 043.18B</b>  <b>OC 053.18B</b>  <b>OC 063.18B</b> 	h:165 mm h:175 mm h:180 mm		
				<b>OC 010.21B</b>  <b>OC 020.21B</b>  <b>OC 030.21B</b>  <b>OC 040.21B</b>  <b>OC 050.21B</b>  <b>OC 060.21B</b> 	<b>OC 011.22B</b>  <b>OC 021.22B</b>  <b>OC 031.22B</b>  <b>OC 041.22B</b>  <b>OC 051.22B</b>  <b>OC 061.22B</b> 	<b>OC 012.22B</b>  <b>OC 022.22B</b>  <b>OC 032.22B</b>  <b>OC 042.22B</b>  <b>OC 052.22B</b>  <b>OC 062.22B</b> 	<b>OC 013.23B</b>  <b>OC 023.23B</b>  <b>OC 033.23B</b>  <b>OC 043.23B</b>  <b>OC 053.23B</b>  <b>OC 063.23B</b> 	h:215 mm h:225 mm h:230 mm	
					<b>OC 010.26B</b>  <b>OC 020.26B</b>  <b>OC 030.26B</b>  <b>OC 040.26B</b>  <b>OC 050.26B</b>  <b>OC 060.26B</b> 	<b>OC 011.27B</b>  <b>OC 021.27B</b>  <b>OC 031.27B</b>  <b>OC 041.27B</b>  <b>OC 051.27B</b>  <b>OC 061.27B</b> 	<b>OC 012.27B</b>  <b>OC 022.27B</b>  <b>OC 032.27B</b>  <b>OC 042.27B</b>  <b>OC 052.27B</b>  <b>OC 062.27B</b> 	<b>OC 013.28B</b>  <b>OC 023.28B</b>  <b>OC 033.28B</b>  <b>OC 043.28B</b>  <b>OC 053.28B</b>  <b>OC 063.28B</b> 	h:265 mm h:275 mm h:280 mm

Ps: All container measurements cover the outer size of the lids.

### BOX (with barrier)

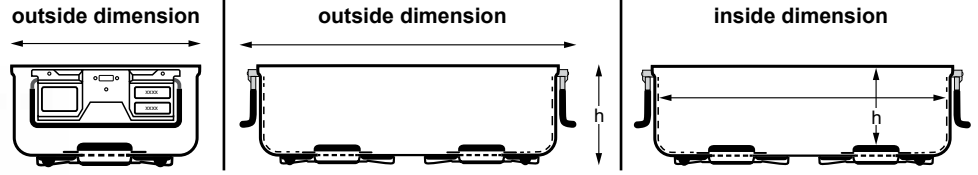

code	outside dimension	inside dimension	weight
<b>OC 01.10B</b>	600 x 272 h:100 mm	543 x 258 h:60 mm	2638 g
<b>OC 01.11B</b>	600 x 272 h:116 mm	543 x 258 h:76 mm	2834 g
<b>OC 01.13B</b>	600 x 272 h:138 mm	543 x 258 h:98 mm	2943 g
<b>OC 01.19B</b>	600 x 272 h:190 mm	543 x 258 h:150 mm	3386 g
<b>OC 01.23B</b>	600 x 272 h:235 mm	543 x 258 h:195 mm	3778 g

### BOX (non perforated)

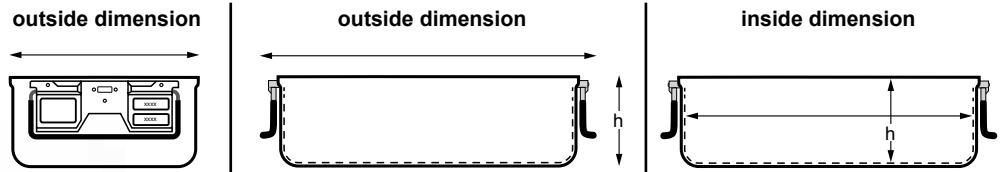

code	outside dimension	inside dimension	weight
<b>OC 00.10</b>	600 x 272 h:100 mm	543 x 258 h:94 mm	1900 g
<b>OC 00.11</b>	600 x 272 h:116 mm	543 x 258 h:110 mm	2096 g
<b>OC 00.13</b>	600 x 272 h:138 mm	543 x 258 h:132 mm	2205 g
<b>OC 00.19</b>	600 x 272 h:190 mm	543 x 258 h:184 mm	2648 g
<b>OC 00.23</b>	600 x 272 h:235 mm	543 x 258 h:229 mm	3040 g

### LID-BARRIER SYSTEM



code	color	weight
<b>OC 014</b>		1830g
<b>OC 024</b>		
<b>OC 034</b>		
<b>OC 044</b>		
<b>OC 054</b>		
<b>OC 064</b>		

Dimension: 602 x 285 mm

### SAFETY LIDS



code	color	weight
<b>OC 015</b>		1164 g
<b>OC 025</b>		
<b>OC 035</b>		
<b>OC 045</b>		
<b>OC 055</b>		
<b>OC 065</b>		

Dimension: 608 x 288 mm

## BASKET MADE FROM STAINLESS STEEL WIRE MESH

### WIRE BASKET



code	outside dimension
<b>OW 010.03</b>	540 x 245 h:30 mm
<b>OW 010.05</b>	540 x 245 h:50 mm
<b>OW 010.07</b>	540 x 245 h:70 mm
<b>OW 010.10</b>	540 x 245 h:100 mm

<b>OW 020.03</b>	480 x 245 h:30 mm
<b>OW 020.05</b>	480 x 245 h:50 mm
<b>OW 020.07</b>	480 x 245 h:70 mm
<b>OW 020.10</b>	480 x 245 h:100 mm

### WIRE BASKET WITH LID



code	outside dimension
<b>OW 011.03</b>	540 x 245 h:35 mm
<b>OW 011.05</b>	540 x 245 h:55 mm
<b>OW 011.07</b>	540 x 245 h:75 mm
<b>OW 011.10</b>	540 x 245 h:105 mm
<b>OW 011</b>	ONLY LID, for baskets

<b>OW 021.03</b>	480 x 245 h:35 mm
<b>OW 021.05</b>	480 x 245 h:55 mm
<b>OW 021.07</b>	480 x 245 h:75 mm
<b>OW 021.10</b>	480 x 245 h:105 mm
<b>OW 021</b>	ONLY LID, for baskets

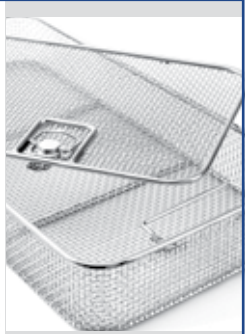

## WIRE BASKET WITH PERFORATED METAL PLATE

### WIRE BASKET



code	outside dimension
<b>OM 010.05</b>	540 x 245 h:50 mm
<b>OM 010.07</b>	540 x 245 h:70 mm
<b>OM 010.10</b>	540 x 245 h:100 mm

<b>OM 020.05</b>	480 x 245 h:50 mm
<b>OM 020.07</b>	480 x 245 h:70 mm
<b>OM 020.10</b>	480 x 245 h:100 mm

### WIRE BASKET WITH LID

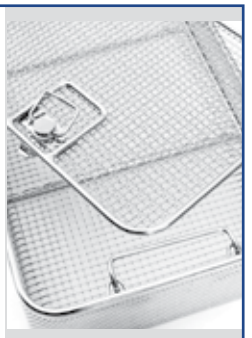



code	outside dimension
<b>OM 011.05</b>	540 x 245 h:55 mm
<b>OM 011.07</b>	540 x 245 h:75 mm
<b>OM 011.10</b>	540 x 245 h:105 mm
<b>OM 011</b>	ONLY LID, for baskets

<b>OM 021.05</b>	480 x 245 h:55 mm
<b>OM 021.07</b>	480 x 245 h:75 mm
<b>OM 021.10</b>	480 x 245 h:105 mm
<b>OM 021</b>	ONLY LID, for baskets

## BASKET MADE FROM STAINLESS STEEL SHEET

### BASKET

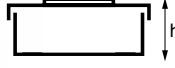
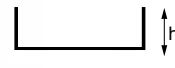

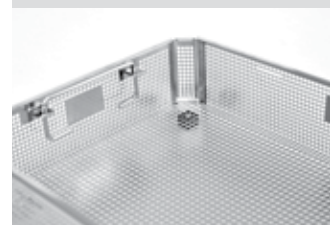
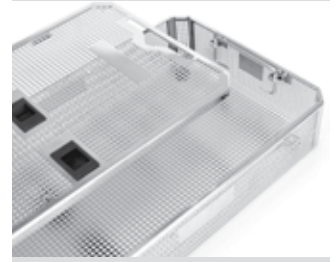

	code	outside dimension
Box and Lid 	<b>OP 011.03</b>	546 x 259 h:34 mm
	<b>OP 011.05</b>	546 x 259 h:54 mm
	<b>OP 011.07</b>	546 x 259 h:74 mm
	<b>OP 011.10</b>	546 x 259 h:104 mm
Box 	<b>OP 010.03</b>	540 x 253 h:30 mm
	<b>OP 010.05</b>	540 x 253 h:50 mm
	<b>OP 010.07</b>	540 x 253 h:70 mm
	<b>OP 010.10</b>	540 x 253 h:100 mm
Lid 	<b>OP 011</b>	ONLY LID, for baskets



### BASKET

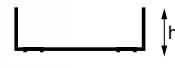

	code	outside dimension
Box and Lid 	<b>OP 021.03</b>	491 x 259 h:34 mm
	<b>OP 021.05</b>	491 x 259 h:54 mm
	<b>OP 021.07</b>	491 x 259 h:74 mm
	<b>OP 021.10</b>	491 x 259 h:104 mm
Box 	<b>OP 020.03</b>	485 x 253 h:30 mm
	<b>OP 020.05</b>	485 x 253 h:50 mm
	<b>OP 020.07</b>	485 x 253 h:70 mm
	<b>OP 020.10</b>	485 x 253 h:100 mm
Lid 	<b>OP 021</b>	ONLY LID, for baskets



code	height
<b>OA 916</b>	10 mm



### STAND



code	height
<b>OA 915</b>	5 mm



## IDENTIFICATION (aluminium)

### LABEL HOLDER



code **OA 931**

### LABELS



code	color
<b>OA 014</b>	Grey
<b>OA 024</b>	Yellow
<b>OA 034</b>	Red
<b>OA 044</b>	Blue
<b>OA 054</b>	Green
<b>OA 064</b>	Black

Coloured identification labels  
Engraved to your specification



 Grey coloured recommended for use in low temperature sterilization.  
Color fading By effect of Hydrogen Peroxide Gas Plasma on other colors.

**DIVIDERS**



**OA 941.13**  
540 x 250 x 130 mm  
**OA 941.18**  
540 x 250 x 180 mm

**WIRE BASE**



**OA 940.03**  
545 x 255 x 30 mm

**DIVIDERS**



**OA 942.13**  
540 x 250 x 130 mm  
**OA 942.18**  
540 x 250 x 180 mm

**RACK (for endoscopy)**

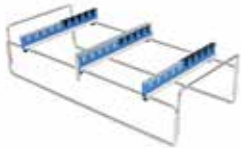

**OA 801**  
505 x 250 x 125 mm  
• Holds 10 endoscopic instruments  
• Fits into a 1/1 size 200 mm deep container  
• Wire basket 1/1 50 mm  
• Silicone mat 520 x 230 mm

**DRAPE RETAINER**



**OA 967.03**  
545 x 255 x 30 mm

**DRAPE RETAINER**



**OA 967**  
545 x 255 mm

**ALUMINIUM BASKET (with lid)**



**OB 01.05**  
245 x 130 x 55 mm

**ALUMINIUM BASKET (with lid)**



**OB 01.07**  
245 x 130 x 70 mm

**ALUMINIUM BASKET (with lid)**



**OB 01.10**  
245 x 130 x 105 mm

**SILICONE MAT**



**OA 508**  
520 x 230 mm  
**OA 5010**  
475 x 230 mm



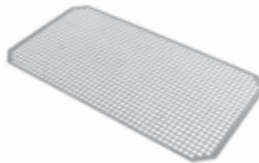



**SILICONE MESH MAT**



**OA 602**  
485 x 250 mm  
**OA 603**  
534 x 247 mm







**SILICONE HANDLE**

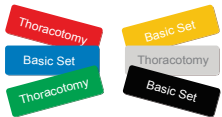

**OA 016**   
**OA 026**   
**OA 036**   
**OA 046**   
**OA 056**   
**OA 066** 

**IDENTIFICATION LABELS (aluminium)**



**OA 013**   
**OA 023**   
**OA 033**   
**OA 043**   
**OA 053**   
**OA 063** 

**LABELS (paper)**

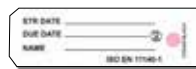

**OA 001**  
100 pcs. With indicator.  
For small size and special containers

**LABELS (paper)**

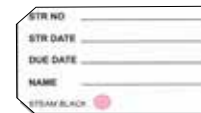

**OA 002**  
100 pcs. With indicator.  
For full and Half size containers



**SECURITY SEAL (blue)**

**OA 742**  
100 pcs. with indicator.  
made of plastic



**SECURITY SEAL (blue)**

**OA 741**  
100 pcs. made of plastic



**SECURITY SEAL (red)**

**OA 732**  
100 pcs. with indicator.  
made of plastic



**SECURITY SEAL (red)**

**OA 731**  
100 pcs. made of plastic



**DISPOSAL STAMP**

**OA 008**  
40 x 35 x 9 mm  
Requested number or letter must be informed during the order.



**AUTO LOCK MECHANISM**

**OA 703**  
(2 Pcs)



**LABEL HOLDER**

**OA 007**  
50 x 35 x 13 mm  
Holder for identification labels

# ***STERILE CONTAINER SYSTEM BIO-BARRIER MODEL***



» 3/4 MEDIUM SIZE





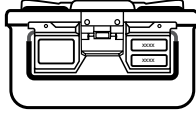









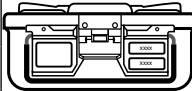























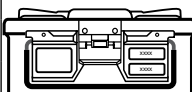























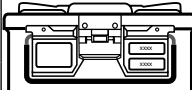













## 3/4 BIO-BARRIER MODEL

W: 285 mm



L: 475 mm



	Lid (with barrier)	Lid (with barrier)	Safety Lid Lid (with barrier)	Safety Lid Lid (with barrier)
				
	Box (Non Perforated)	Box (with barrier)	Box (Non Perforated)	Box (with barrier)
	<b>OC 110.12B</b> 	<b>OC 111.13B</b> 	<b>OC 112.13B</b> 	<b>OC 113.14B</b> 
	<b>OC 120.12B</b> 	<b>OC 121.13B</b> 	<b>OC 122.13B</b> 	<b>OC 123.14B</b> 
	<b>OC 130.12B</b> 	<b>OC 131.13B</b> 	<b>OC 132.13B</b> 	<b>OC 133.14B</b> 
	<b>OC 140.12B</b> 	<b>OC 141.13B</b> 	<b>OC 142.13B</b> 	<b>OC 143.14B</b> 
	<b>OC 150.12B</b> 	<b>OC 151.13B</b> 	<b>OC 152.13B</b> 	<b>OC 153.14B</b> 
	<b>OC 160.12B</b> 	<b>OC 161.13B</b> 	<b>OC 162.13B</b> 	<b>OC 163.14B</b> 
	<b>OC 110.14B</b> 	<b>OC 111.15B</b> 	<b>OC 112.15B</b> 	<b>OC 113.16B</b> 
	<b>OC 120.14B</b> 	<b>OC 121.15B</b> 	<b>OC 122.15B</b> 	<b>OC 123.16B</b> 
	<b>OC 130.14B</b> 	<b>OC 131.15B</b> 	<b>OC 132.15B</b> 	<b>OC 133.16B</b> 
	<b>OC 140.14B</b> 	<b>OC 141.15B</b> 	<b>OC 142.15B</b> 	<b>OC 143.16B</b> 
	<b>OC 150.14B</b> 	<b>OC 151.15B</b> 	<b>OC 152.15B</b> 	<b>OC 153.16B</b> 
	<b>OC 160.14B</b> 	<b>OC 161.15B</b> 	<b>OC 162.15B</b> 	<b>OC 163.16B</b> 
	<b>OC 110.16B</b> 	<b>OC 111.17B</b> 	<b>OC 112.17B</b> 	<b>OC 113.18B</b> 
	<b>OC 120.16B</b> 	<b>OC 121.17B</b> 	<b>OC 122.17B</b> 	<b>OC 123.18B</b> 
	<b>OC 130.16B</b> 	<b>OC 131.17B</b> 	<b>OC 132.17B</b> 	<b>OC 133.18B</b> 
	<b>OC 140.16B</b> 	<b>OC 141.17B</b> 	<b>OC 142.17B</b> 	<b>OC 143.18B</b> 
	<b>OC 150.16B</b> 	<b>OC 151.17B</b> 	<b>OC 152.17B</b> 	<b>OC 153.18B</b> 
	<b>OC 160.16B</b> 	<b>OC 161.17B</b> 	<b>OC 162.17B</b> 	<b>OC 163.18B</b> 

Ps: All container measurements cover the outer size of the lids.

### BOX (with barrier)



outside dimension

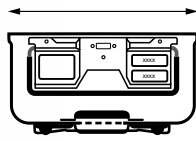

outside dimension

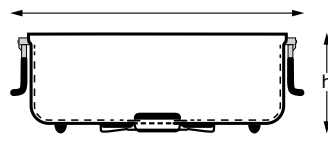

inside dimension

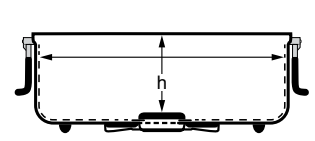

code	outside dimension	inside dimension	weight
<b>OC 11.10B</b>	475 x 272 h:100 mm	422 x 258 h:60 mm	2024 g
<b>OC 11.11B</b>	475 x 272 h:116 mm	422 x 258 h:76 mm	2129 g
<b>OC 11.13B</b>	475 x 272 h:138 mm	422 x 258 h:98 mm	2257 g
<b>OC 11.18B</b>	475 x 272 h:185 mm	422 x 258 h:145 mm	2532 g

### BOX (non perforated)



outside dimension

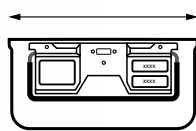

outside dimension

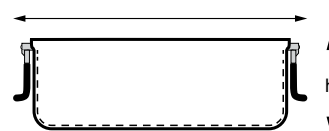



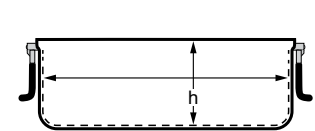



inside dimension



code	outside dimension	inside dimension	weight
<b>OC 10.10</b>	475 x 272 h:100 mm	422 x 258 h:94 mm	1609 g
<b>OC 10.11</b>	475 x 272 h:116 mm	422 x 258 h:110 mm	1714 g
<b>OC 10.13</b>	475 x 272 h:138 mm	422 x 258 h:132 mm	1842 g
<b>OC 10.18</b>	475 x 272 h:185 mm	422 x 258 h:179 mm	2117 g

### LID-BARRIER SYSTEM









code	color	weight
<b>OC 114</b>		1212 g
<b>OC 124</b>		
<b>OC 134</b>		
<b>OC 144</b>		
<b>OC 154</b>		
<b>OC 164</b>		

Dimension: 477 x 285 mm

### SAFETY LIDS



code	color	weight
<b>OC 115</b>		998 g
<b>OC 125</b>		
<b>OC 135</b>		
<b>OC 145</b>		
<b>OC 155</b>		
<b>OC 165</b>		

Dimension: 483 x 290 mm

## BASKET MADE FROM STAINLESS STEEL WIRE MESH

### WIRE BASKET

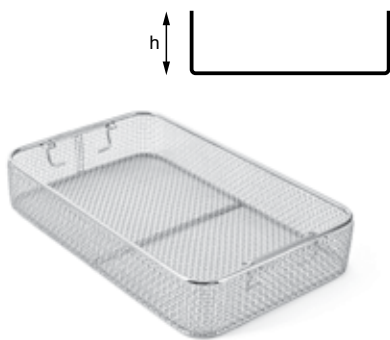

code	outside dimension
<b>OW 110.03</b>	405 x 245 x h:30 mm
<b>OW 110.05</b>	405 x 245 x h:50 mm
<b>OW 110.07</b>	405 x 245 x h:70 mm
<b>OW 110.10</b>	405 x 245 x h:100 mm



### WIRE BASKET WITH LID

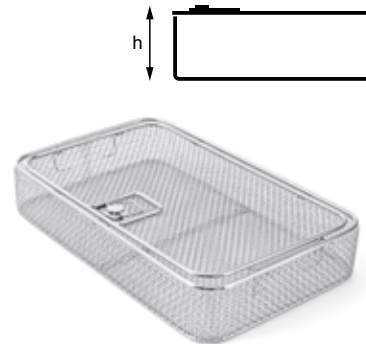

code	outside dimension
<b>OW 111.03</b>	405 x 245 h:35 mm
<b>OW 111.05</b>	405 x 245 h:55 mm
<b>OW 111.07</b>	405 x 245 h:75 mm
<b>OW 111.10</b>	405 x 245 h:105 mm
<b>OW 111</b>	ONLY LID, for baskets



## WIRE BASKET WITH PERFORATED METAL PLATE

### WIRE BASKET

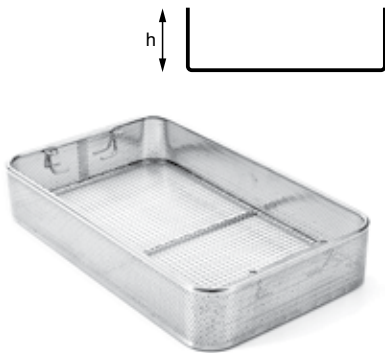

code	outside dimension
<b>OM 110.05</b>	405 x 246 x h:50 mm
<b>OM 110.07</b>	405 x 246 x h:70 mm
<b>OM 110.10</b>	405 x 246 x h:100 mm

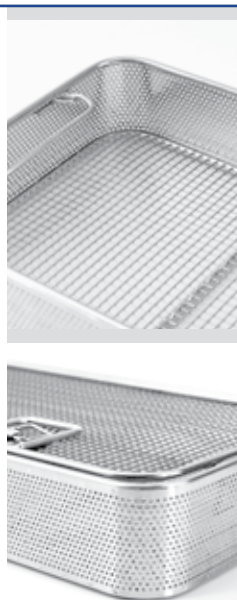

### WIRE BASKET WITH LID



code	outside dimension
<b>OM 111.05</b>	405 x 246 x h:55 mm
<b>OM 111.07</b>	405 x 246 x h:75 mm
<b>OM 111.10</b>	405 x 246 x h:105 mm
<b>OM 111</b>	ONLY LID, for baskets

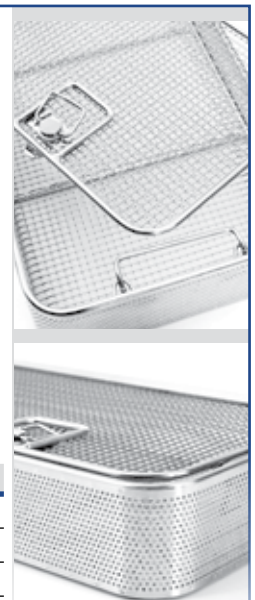

## BASKET MADE FROM STAINLESS STEEL SHEET

### BASKET

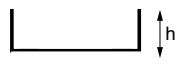
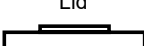

	code	outside dimension
Box and Lid 	<b>OP 111.03</b>	411 x 259 h:34 mm
	<b>OP 111.05</b>	411 x 259 h:54 mm
	<b>OP 111.07</b>	411 x 259 h:74 mm
	<b>OP 111.10</b>	411 x 259 h:104 mm
Box 	<b>OP 110.03</b>	405 x 253 h:30 mm
	<b>OP 110.05</b>	405 x 253 h:50 mm
	<b>OP 110.07</b>	405 x 253 h:70 mm
	<b>OP 110.10</b>	405 x 253 h:100 mm
Lid 	<b>OP 111</b>	ONLY LID, for baskets

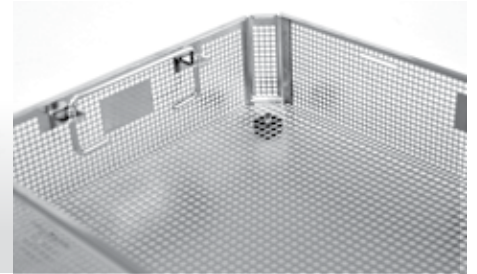
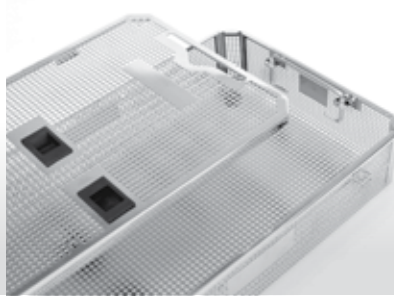

code	height
<b>OA 916</b>	10 mm



code	height
<b>OA 915</b>	5 mm



## IDENTIFICATION (aluminium)

### LABEL HOLDER



code **OA 931**

### LABELS



Coloured identification labels  
Engraved to your specification

code	color
<b>OA 014</b>	Grey
<b>OA 024</b>	Yellow
<b>OA 034</b>	Red
<b>OA 044</b>	Blue
<b>OA 054</b>	Green
<b>OA 064</b>	Black



 Grey coloured recommended for use in low temperature sterilization.  
Color fading By effect of Hydrogen Peroxide Gas Plasma on other colors.

**DIVIDERS**

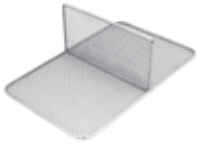

**OA 944.08**  
405 x 250 x 80 mm  
**OA 944.11**  
405 x 250 x 110 mm  
**OA 944.13**  
405 x 250 x 130 mm

**WIRE BASE**



**OA 943.03**  
405 x 255 x 30 mm

**DIVIDERS**

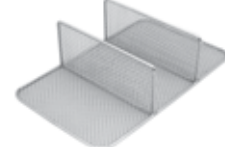

**OA 945.08**  
405 x 250 x 80 mm  
**OA 945.11**  
405 x 250 x 110 mm  
**OA 945.13**  
405 x 250 x 130 mm

( - )

**DRAPE RETAINER**



**OA 965.03**  
405 x 255 x 30 mm

**DRAPE RETAINER**



**OA 965**  
405 x 255 mm

**ALUMINIUM BASKET (with lid)**



**OB 01.05**  
245 x 130 x 55 mm

**ALUMINIUM BASKET (with lid)**



**OB 01.07**  
245 x 130 x 70 mm

**ALUMINIUM BASKET (with lid)**



**OB 01.10**  
245 x 130 x 105 mm

**SILICONE MAT**



**OA 506**  
380 x 230 mm  
**OA 507**  
440 x 230 mm

**SILICONE MESH MAT**

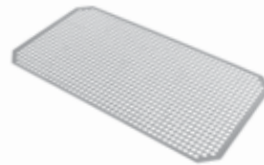

**OA 604**  
395 x 245 mm

**SILICONE HANDLE**



**IDENTIFICATION LABELS (aluminium)**



**OA 013**  
**OA 023**  
**OA 033**  
**OA 043**  
**OA 053**  
**OA 063**

**LABELS (paper)**

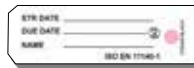

**OA 001**  
100 pcs. With indicator.  
For small size and special containers

**LABELS (paper)**

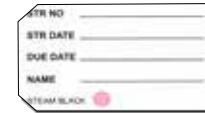

**OA 002**  
100 pcs. With indicator.  
For full and Half size containers



**SECURITY SEAL (blue)**

**OA 742**  
100 pcs. with indicator.  
made of plastic



**SECURITY SEAL (blue)**

**OA 741**  
100 pcs. made of plastic



**SECURITY SEAL (red)**

**OA 732**  
100 pcs. with indicator.  
made of plastic



**SECURITY SEAL (red)**

**OA 731**  
100 pcs. made of plastic



**DISPOSAL STAMP**

**OA 008**  
40 x 35 x 9 mm  
Requested number or letter must be informed during the order.



**AUTO LOCK MECHANISM**

**OA 703**  
(2 Pcs)



**LABEL HOLDER**

**OA 007**  
50 x 35 x 13 mm  
Holder for identification labels

# ***STERILE CONTAINER SYSTEM BIO-BARRIER MODEL***











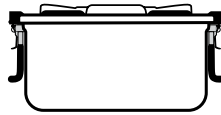
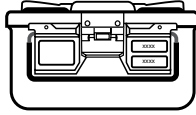









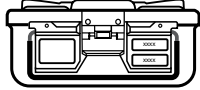























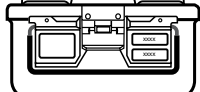























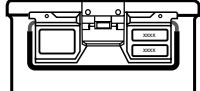







































» 1/2 HALF SIZE

## 1/2 BIO-BARRIER MODEL

W: 280 mm

L: 310 mm



Specifications	Lid (with barrier)	Lid (with barrier)	Safety Lid Lid (with barrier)	Safety Lid Lid (with barrier)
	 Lid (with barrier)	 Lid (with barrier)	 Safety Lid Lid (with barrier)	 Safety Lid Lid (with barrier)
				
	Box (Non Perforated)	Box (with barrier)	Box (Non Perforated)	Box (with barrier)
	<b>OC 210.12B</b> 	<b>OC 211.13B</b> 	<b>OC 212.13B</b> 	<b>OC 213.12B</b> 
	<b>OC 220.12B</b> 	<b>OC 221.13B</b> 	<b>OC 222.13B</b> 	<b>OC 223.12B</b> 
	<b>OC 230.12B</b> 	<b>OC 231.13B</b> 	<b>OC 232.13B</b> 	<b>OC 233.12B</b> 
	<b>OC 240.12B</b> 	<b>OC 241.13B</b> 	<b>OC 242.13B</b> 	<b>OC 243.12B</b> 
	<b>OC 250.12B</b> 	<b>OC 251.13B</b> 	<b>OC 252.13B</b> 	<b>OC 253.12B</b> 
	<b>OC 260.12B</b> 	<b>OC 261.13B</b> 	<b>OC 262.13B</b> 	<b>OC 263.12B</b> 
	h:120 mm	h:130 mm	h:130 mm	h:140 mm
	<b>OC 210.14B</b> 	<b>OC 211.15B</b> 	<b>OC 212.15B</b> 	<b>OC 213.16B</b> 
	<b>OC 220.14B</b> 	<b>OC 221.15B</b> 	<b>OC 222.15B</b> 	<b>OC 223.16B</b> 
	<b>OC 230.14B</b> 	<b>OC 231.15B</b> 	<b>OC 232.15B</b> 	<b>OC 233.16B</b> 
	<b>OC 240.14B</b> 	<b>OC 241.15B</b> 	<b>OC 242.15B</b> 	<b>OC 243.16B</b> 
	<b>OC 250.14B</b> 	<b>OC 251.15B</b> 	<b>OC 252.15B</b> 	<b>OC 253.16B</b> 
	<b>OC 260.14B</b> 	<b>OC 261.15B</b> 	<b>OC 262.15B</b> 	<b>OC 263.16B</b> 
	h:140 mm	h:150 mm	h:150 mm	h:160 mm
	<b>OC 210.16B</b> 	<b>OC 211.17B</b> 	<b>OC 212.17B</b> 	<b>OC 213.18B</b> 
	<b>OC 220.16B</b> 	<b>OC 221.17B</b> 	<b>OC 222.17B</b> 	<b>OC 223.18B</b> 
	<b>OC 230.16B</b> 	<b>OC 231.17B</b> 	<b>OC 232.17B</b> 	<b>OC 233.18B</b> 
	<b>OC 240.16B</b> 	<b>OC 241.17B</b> 	<b>OC 242.17B</b> 	<b>OC 243.18B</b> 
	<b>OC 250.16B</b> 	<b>OC 251.17B</b> 	<b>OC 252.17B</b> 	<b>OC 253.18B</b> 
	<b>OC 260.16B</b> 	<b>OC 261.17B</b> 	<b>OC 262.17B</b> 	<b>OC 263.18B</b> 
	h:160 mm	h:170 mm	h:170 mm	h:180 mm
	<b>OC 210.21B</b> 	<b>OC 211.22B</b> 	<b>OC 212.22B</b> 	<b>OC 213.23B</b> 
	<b>OC 220.21B</b> 	<b>OC 221.22B</b> 	<b>OC 222.22B</b> 	<b>OC 223.23B</b> 
	<b>OC 230.21B</b> 	<b>OC 231.22B</b> 	<b>OC 232.22B</b> 	<b>OC 233.23B</b> 
	<b>OC 240.21B</b> 	<b>OC 241.22B</b> 	<b>OC 242.22B</b> 	<b>OC 243.23B</b> 
	<b>OC 250.21B</b> 	<b>OC 251.22B</b> 	<b>OC 252.22B</b> 	<b>OC 253.23B</b> 
	<b>OC 260.21B</b> 	<b>OC 261.22B</b> 	<b>OC 262.22B</b> 	<b>OC 263.23B</b> 
	h:210 mm	h:220 mm	h:220 mm	h:230 mm

 Ps: All container measurements cover the outer size of the lids.

### BOX (with barrier)



outside dimension

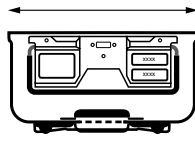

outside dimension

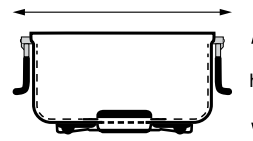

inside dimension

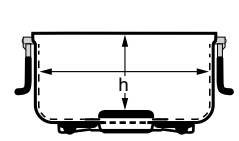

code	outside dimension	inside dimension	weight
<b>OC 21.10B</b>	310 x 272 h:100 mm	253 x 258 h:60 mm	1682 g
<b>OC 21.11B</b>	310 x 272 h:116 mm	253 x 258 h:76 mm	1730 g
<b>OC 21.13B</b>	310 x 272 h:138 mm	253 x 258 h:98 mm	1842 g
<b>OC 21.19B</b>	310 x 272 h:190 mm	253 x 258 h:150 mm	2075 g
<b>OC 21.23B</b>	310 x 272 h:235 mm	253 x 258 h:195 mm	2355 g

### BOX (non perforated)



outside dimension

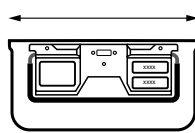

outside dimension

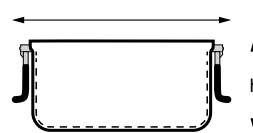

inside dimension

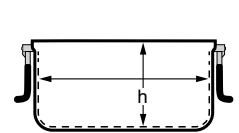







code	outside dimension	inside dimension	weight
<b>OC 20.10</b>	310 x 272 h:100 mm	253 x 258 h:94 mm	1267 g
<b>OC 20.11</b>	310 x 272 h:116 mm	253 x 258 h:110 mm	1315 g
<b>OC 20.13</b>	310 x 272 h:138 mm	253 x 258 h:132 mm	1427 g
<b>OC 20.19</b>	310 x 272 h:190 mm	253 x 258 h:184 mm	1660 g
<b>OC 20.23</b>	310 x 272 h:235 mm	253 x 258 h:229 mm	1940 g

### LID-BARRIER SYSTEM

Dimension: 312 x 280 mm









code	color	weight
<b>OC 214</b>		960 g
<b>OC 224</b>		
<b>OC 234</b>		
<b>OC 244</b>		
<b>OC 254</b>		
<b>OC 264</b>		

### SAFETY LIDS

Dimension: 317 x 286 mm



code	color	weight
<b>OC 215</b>		675 g
<b>OC 225</b>		
<b>OC 235</b>		
<b>OC 245</b>		
<b>OC 255</b>		
<b>OC 265</b>		

## BASKET MADE FROM STAINLESS STEEL WIRE MESH

### WIRE BASKET

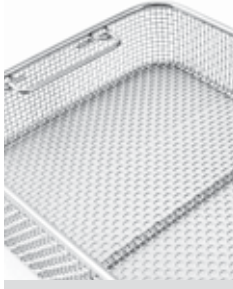
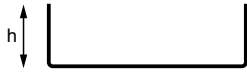

code	outside dimension
<b>OW 210.03</b>	246 x 246 x h:30 mm
<b>OW 210.05</b>	246 x 246 x h:50 mm
<b>OW 210.07</b>	246 x 246 x h:70 mm
<b>OW 210.10</b>	246 x 246 x h:100 mm

### WIRE BASE



code	outside dimension
<b>OW 210</b>	255 x 255 x 30 mm

### WIRE BASKET WITH LID



code	outside dimension
<b>OW 211.03</b>	246 x 246 h:35 mm
<b>OW 211.05</b>	246 x 246 h:55 mm
<b>OW 211.07</b>	246 x 246 h:75 mm
<b>OW 211.10</b>	246 x 246 h:105 mm
<b>OW 211</b>	ONLY LID, for baskets

## WIRE BASKET WITH PERFORATED METAL PLATE

### WIRE BASKET



code	outside dimension
<b>OM 210.05</b>	246 x 246 x h:50 mm
<b>OM 210.07</b>	246 x 246 x h:70 mm
<b>OM 210.10</b>	246 x 246 x h:100 mm

### WIRE BASKET WITH LID



code	outside dimension
<b>OM 211.05</b>	246 x 246 x h:55 mm
<b>OM 211.07</b>	246 x 246 x h:75 mm
<b>OM 211.10</b>	246 x 246 x h:105 mm
<b>OM 211</b>	ONLY LID, for baskets

## BASKET MADE FROM STAINLESS STEEL SHEET

### BASKET

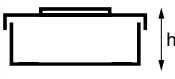
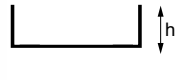
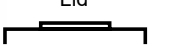

	code	outside dimension
Box and Lid 	<b>OP 211.03</b>	250 x 259 h:34 mm
	<b>OP 211.05</b>	250 x 259 h:54 mm
	<b>OP 211.07</b>	250 x 259 h:74 mm
	<b>OP 211.10</b>	250 x 259 h:104 mm
Box 	<b>OP 210.03</b>	244 x 253 h:30 mm
	<b>OP 210.05</b>	244 x 253 h:50 mm
	<b>OP 210.07</b>	244 x 253 h:70 mm
	<b>OP 210.10</b>	244 x 253 h:100 mm
Lid 	<b>OP 211</b>	ONLY LID, for baskets

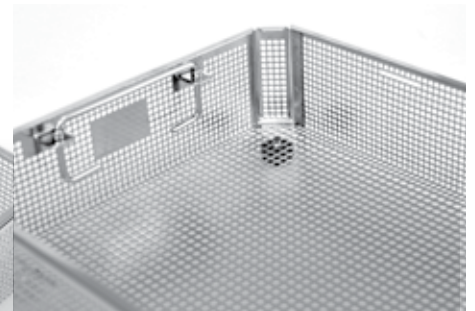
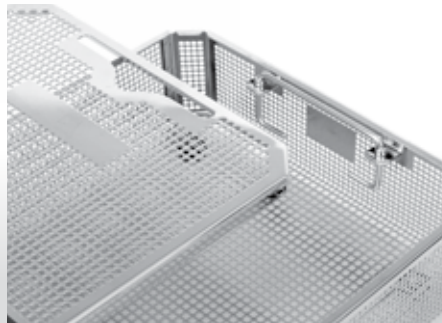

code	height
<b>OA 916</b>	10 mm



### STAND



code	height
<b>OA 915</b>	5 mm

## IDENTIFICATION (aluminium)

### LABEL HOLDER



code **OA 931**

### LABELS



Coloured identification labels  
Engraved to your specification

code	color
<b>OA 014</b>	Grey
<b>OA 024</b>	Yellow
<b>OA 034</b>	Red
<b>OA 044</b>	Blue
<b>OA 054</b>	Green
<b>OA 064</b>	Black



- Grey coloured recommended for use in low temperature sterilization.
- Color fading By effect of Hydrogen Peroxide Gas Plasma on other colors.

**DIVIDERS**



**OA 947.13**  
255 x 245 x 130 mm  
**OA 947.18**  
255 x 245 x 180 mm

**WIRE BASE**



**OA 946.03**  
255 x 255 x 30 mm

(-)

**RACK (for kerrison)**



**OA 821**  
220 x 250 x 160 mm  
• Holds 10 kerrison punches  
• Fits into a 1/2 and 1/1 size  
• 200 mm deep container  
• Wire basket 1/2 H:50 mm  
• Wire basket 1/1 H:50 mm  
• Container 1/2 H: 200 mm  
• Container 1/1 H:200 mm

**DRAPE RETAINER**



**OA 963.03**  
255 x 255 x 30 mm

**DRAPE RETAINER**



**OA 963**  
255 x 255 mm

**ALUMINIUM BASKET (with lid)**



**OB 01.05**  
245 x 130 x 55 mm

**ALUMINIUM BASKET (with lid)**



**OB 01.07**  
245 x 130 x 70 mm

**ALUMINIUM BASKET (with lid)**



**OB 01.10**  
245 x 130 x 105 mm

**SILICONE MAT**



**OA 503**  
250 x 235 mm



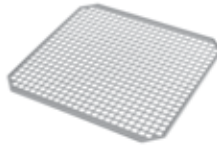



**SILICONE MESH MAT**



**OA 601**  
250 x 240 mm

**SILICONE HANDLE**



**OA 016**   
**OA 026**   
**OA 036**   
**OA 046**   
**OA 056**   
**OA 066** 

**IDENTIFICATION LABELS (aluminium)**

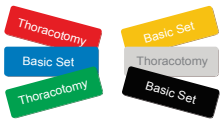

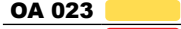
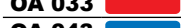
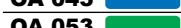
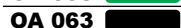
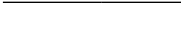
**OA 013**   
**OA 023**   
**OA 033**   
**OA 043**   
**OA 053**   
**OA 063** 

**LABELS (paper)**

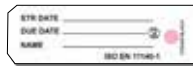

**OA 001**  
100 pcs. With indicator.  
For small size and special containers

**LABELS (paper)**

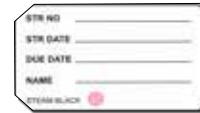

**OA 002**  
100 pcs. With indicator.  
For full and Half size containers



**SECURITY SEAL (blue)**

**OA 742**  
100 pcs. with indicator.  
made of plastic



**SECURITY SEAL (red)**

**OA 732**  
100 pcs. with indicator.  
made of plastic



**SECURITY SEAL (blue)**

**OA 741**  
100 pcs. made of plastic



**SECURITY SEAL (red)**

**OA 731**  
100 pcs. made of plastic



**DISPOSAL STAMP**

**OA 008**  
40 x 35 x 9 mm  
Requested number or letter must be informed during the order.



**AUTO LOCK MECHANISM**

**OA 703**  
(2 Pcs)



**LABEL HOLDER**

**OA 007**  
50 x 35 x 13 mm  
Holder for identification labels

# ***STERILE CONTAINER SYSTEM BIO-BARRIER MODEL***



» LARGE SIZE









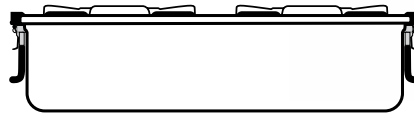
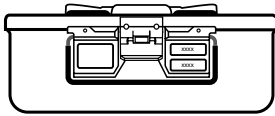



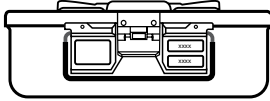











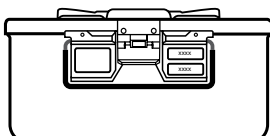

## EXTRA LARGE SIZE



W: 372 mm

L: 600 mm



Specifications 	Lid (with barrier)	Lid (with barrier)
		
	Box (Non Perforated)	Box (with barrier)
	<b>OC 310.13B</b> 	<b>OC 311.14B</b> 
	<b>OC 320.13B</b> 	<b>OC 321.14B</b> 
	<b>OC 330.13B</b> 	<b>OC 331.14B</b> 
	<b>OC 340.13B</b> 	<b>OC 341.14B</b> 
	<b>OC 350.13B</b> 	<b>OC 351.14B</b> 
	<b>OC 360.13B</b> 	<b>OC 361.14B</b> 
	h:130 mm	h:140 mm
	<b>OC 310.19B</b> 	<b>OC 311.20B</b> 
	<b>OC 320.19B</b> 	<b>OC 321.20B</b> 
	<b>OC 330.19B</b> 	<b>OC 331.20B</b> 
	<b>OC 340.19B</b> 	<b>OC 341.20B</b> 
	<b>OC 350.19B</b> 	<b>OC 351.20B</b> 
	<b>OC 360.19B</b> 	<b>OC 361.20B</b> 
	h:195 mm	h:205 mm

 Ps: All container measurements cover the outer size of the lids.

### BOX (with barrier)

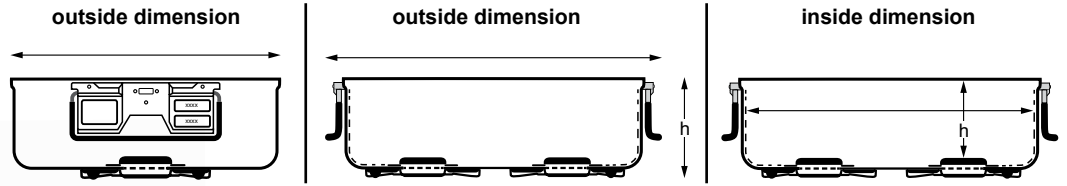

code	outside dimension	inside dimension	weight
<b>OC 31.10B</b>	600 x 365 h:105 mm	543 x 350 h:88 mm	2480 g
<b>OC 31.16B</b>	600 x 365 h:167 mm	543 x 350 h:150 mm	3122 g

### BOX (non perforated)

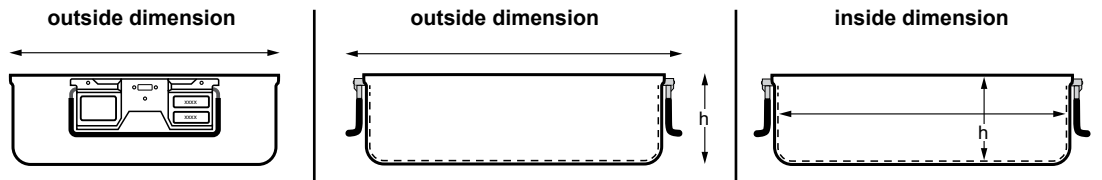







code	outside dimension	inside dimension	weight
<b>OC 30.10</b>	600 x 365 h:105 mm	543 x 350 h:99 mm	2271 g
<b>OC 30.16</b>	600 x 365 h:167 mm	543 x 350 h:161 mm	2856 g

### LID BARRIER SYSTEM



Dimension: 602 x 372 mm

code	color	weight
<b>OC 314</b>		2055 g
<b>OC 324</b>		
<b>OC 334</b>		
<b>OC 344</b>		
<b>OC 354</b>		
<b>OC 364</b>		

## BASKET MADE FROM STAINLESS STEEL WIRE MESH

### WIRE BASKET



code	outside dimension
<b>OW 310.05</b>	533 x 337 h:50 mm
<b>OW 310.07</b>	533 x 337 h:70 mm
<b>OW 310.10</b>	533 x 337 h:100 mm

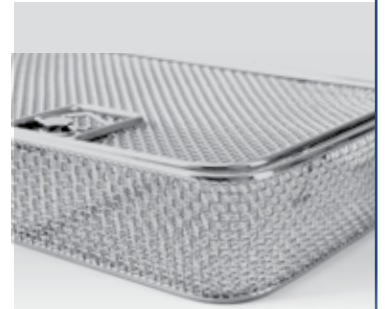

### WIRE BASKET WITH LID



code	outside dimension
<b>OW 311.05</b>	533 x 337 h:55 mm
<b>OW 311.07</b>	533 x 337 h:75 mm
<b>OW 311.10</b>	533 x 337 h:105 mm
<b>OW 311</b>	ONLY LID, for baskets

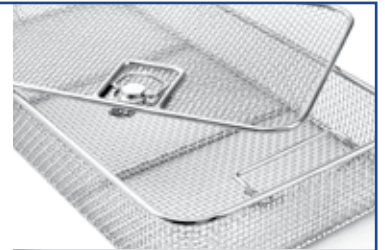

## IDENTIFICATION (aluminium)

### LABEL HOLDER



code **OA 931**

### LABELS



code	color
<b>OA 014</b>	Grey
<b>OA 024</b>	Yellow
<b>OA 034</b>	Red
<b>OA 044</b>	Blue
<b>OA 054</b>	Green
<b>OA 064</b>	Black

Coloured identification labels  
Engraved to your specification



 Grey coloured recommended for use in low temperature sterilization.  
Color fading By effect of Hydrogen Peroxide Gas Plasma on other colors.

## BASKET MADE FROM STAINLESS STEEL SHEET

### BASKET

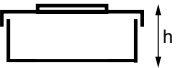
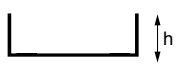
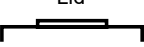

	code	outside dimension
Box and Lid 	<b>OP 311.03</b>	539 x 346 h:34 mm
	<b>OP 311.05</b>	539 x 346 h:54 mm
	<b>OP 311.07</b>	539 x 346 h:74 mm
	<b>OP 311.10</b>	539 x 346 h:104 mm
Box 	<b>OP 310.03</b>	533 x 340 h:30 mm
	<b>OP 310.05</b>	533 x 340 h:50 mm
	<b>OP 310.07</b>	533 x 340 h:70 mm
	<b>OP 310.10</b>	533 x 340 h:100 mm
Lid 	<b>OP 311</b>	ONLY LID, for baskets

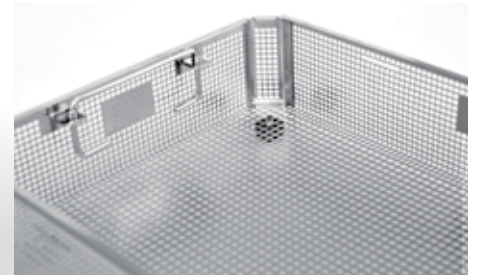
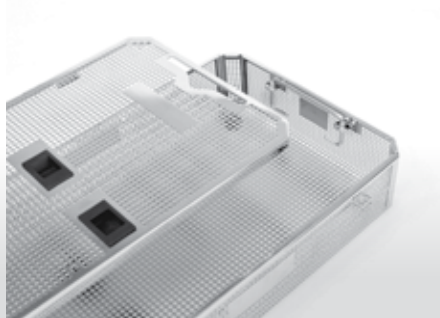

code	height
<b>OA 916</b>	10 mm



### STAND

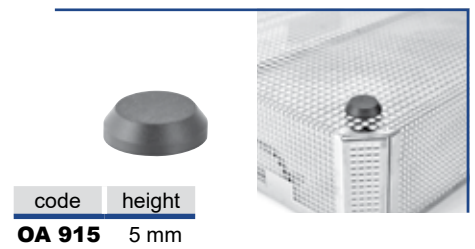

code	height
<b>OA 915</b>	5 mm



**DIVIDERS**



**OA 948.07**  
533 x 337 x70 mm  
**OA 94812**  
533 x 337 x 120 mm

( - )

**DIVIDERS**



**OA 949.07**  
533 x 337 x70 mm  
**OA 949.12**  
533 x 337 x 120 mm

( - )

**DRAPE RETAINER**



**OA 966.03**  
533 x 337 x 30 mm

**DRAPE RETAINER**



**OA 966**  
533 x 337 mm

( - )



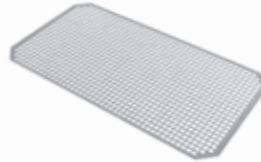



**SILICONE MESH MAT**



**OA 605**  
527 x 335 mm

**SILICONE HANDLE**



**OA 016**   
**OA 026**   
**OA 036**   
**OA 046**   
**OA 056**   
**OA 066** 

**ALUMINIUM BASKET (with lid)**



**OB 01.05**  
245 x 130 x 55 mm

**ALUMINIUM BASKET (with lid)**



**OB 01.07**  
245 x 130 x 70 mm



**ALUMINIUM BASKET (with lid)**



**OB 01.10**  
245 x 130 x 105 mm

**IDENTIFICATION LABELS (aluminium)**

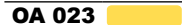
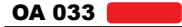
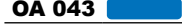
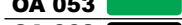

**OA 013**   
**OA 023**   
**OA 033**   
**OA 043**   
**OA 053**   
**OA 063** 

**LABELS (paper)**

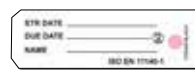

**OA 001**  
100 pcs. With indicator.

For small size and special containers

**LABELS (paper)**

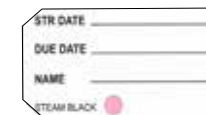

**OA 002**  
100 pcs. With indicator.

For full and Half size containers



**SECURITY SEAL (blue)**

**OA 742**  
100 pcs. with indicator.  
made of plastic



**SECURITY SEAL (red)**

**OA 732**  
100 pcs. with indicator.  
made of plastic



**SECURITY SEAL (blue)**

**OA 741**  
100 pcs. made of plastic



**SECURITY SEAL (red)**

**OA 731**  
100 pcs. made of plastic



**DISPOSAL STAMP**

**OA 008**  
40 x 35 x 9 mm  
Requested number or letter must be informed during the order.



**AUTO LOCK MECHANISM**

**OA 703**  
(2 Pcs)



**LABEL HOLDER**

**OA 007**  
50 x 35 x 13 mm  
Holder for identification labels

# ***STERILE CONTAINER SYSTEM BIO-BARRIER MODEL***



» LONG SIZE









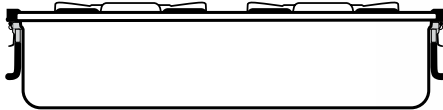
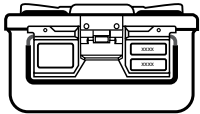



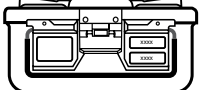











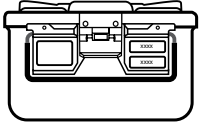

# EXTRA LONG SIZE



W: 285 mm

L: 725 mm



Specifications	Lid (with barrier)		
			
	Box (Non Perforated)	Box (with barrier)	
	<b>OC 410.15B</b> 	<b>OC 411.16B</b> 	
	<b>OC 420.15B</b> 		<b>OC 421.16B</b> 
	<b>OC 430.15B</b> 		<b>OC 431.16B</b> 
	<b>OC 440.15B</b> 		<b>OC 441.16B</b> 
	<b>OC 450.15B</b> 		<b>OC 451.16B</b> 
	<b>OC 460.15B</b> 		<b>OC 461.16B</b> 
	<b>OC 410.20B</b> 	<b>OC 411.22B</b> 	
	<b>OC 420.20B</b> 		<b>OC 421.22B</b> 
	<b>OC 430.20B</b> 		<b>OC 431.22B</b> 
	<b>OC 440.20B</b> 		<b>OC 441.22B</b> 
	<b>OC 450.20B</b> 		<b>OC 451.22B</b> 
	<b>OC 460.20B</b> 		<b>OC 461.22B</b> 
	h:150 mm	h:160 mm	
	h:215 mm	h:225 mm	

Ps: All container measurements cover the outer size of the lids.

**BOX (with barrier)**

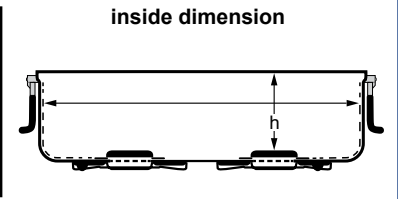
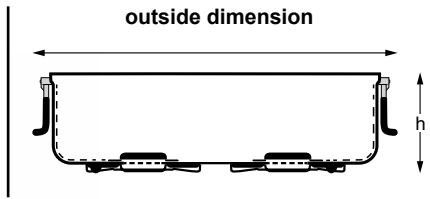
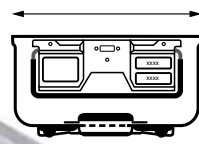

code	outside dimension	inside dimension	weight
<b>OC 41.12B</b>	725 x 272 h:127 mm	687 x 258 h:110 mm	2646 g
<b>OC 41.19B</b>	725 x 272 h:192 mm	687 x 258 h:175 mm	3136 g

**BOX (non perforated)**

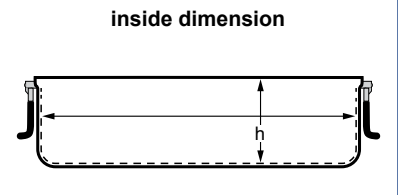
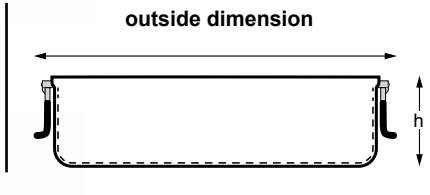
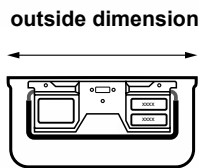







code	outside dimension	inside dimension	weight
<b>OC 40.12</b>	725 x 272 h:127 mm	687 x 258 h:121 mm	2446 g
<b>OC 40.19</b>	725 x 272 h:192 mm	687 x 258 h:186 mm	2974 g

**PERFORATED LIDS**



Dimension: 726 x 285 mm

code	color	weight
<b>OC 414</b>		1937 g
<b>OC 424</b>		
<b>OC 434</b>		
<b>OC 444</b>		
<b>OC 454</b>		
<b>OC 464</b>		

## BASKET MADE FROM STAINLESS STEEL WIRE MESH

### WIRE BASKET



code	outside dimension
<b>OW 410.05</b>	665 x 250 h:50 mm
<b>OW 410.07</b>	665 x 250 h:70 mm
<b>OW 410.10</b>	665 x 250 h:100 mm

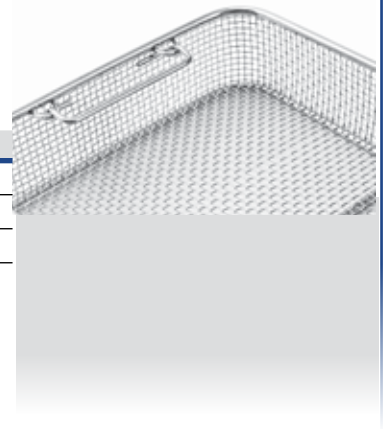

### WIRE BASKET WITH LID



code	outside dimension
<b>OW 411.05</b>	665 x 250 h:55 mm
<b>OW 411.07</b>	665 x 250 h:75 mm
<b>OW 411.10</b>	665 x 250 h:105 mm
<b>OW 411</b>	ONLY LID, for baskets



### IDENTIFICATION (aluminium)

#### LABEL HOLDER



code **OA 931**

#### LABELS



code	color
<b>OA 014</b>	Grey
<b>OA 024</b>	Yellow
<b>OA 034</b>	Red
<b>OA 044</b>	Blue
<b>OA 054</b>	Green
<b>OA 064</b>	Black

Coloured identification labels  
Engraved to your specification



 Grey coloured recommended for use in low temperature sterilization.  
Color fading By effect of Hydrogen Peroxide Gas Plasma on other colors.

## BASKET MADE FROM STAINLESS STEEL SHEET

### BASKET

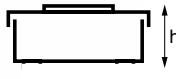
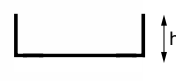
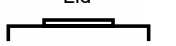

	code	outside dimension
 Box and Lid	<b>OP 411.03</b>	671 x 259 h:34 mm
	<b>OP 411.05</b>	671 x 259 h:54 mm
	<b>OP 411.07</b>	671 x 259 h:74 mm
	<b>OP 411.10</b>	671 x 259 h:104 mm
 Box	<b>OP 410.03</b>	665 x 253 h:30 mm
	<b>OP 410.05</b>	665 x 253 h:50 mm
	<b>OP 410.07</b>	665 x 253 h:70 mm
	<b>OP 410.10</b>	665 x 253 h:100 mm
 Lid	<b>OP 411</b>	ONLY LID, for baskets

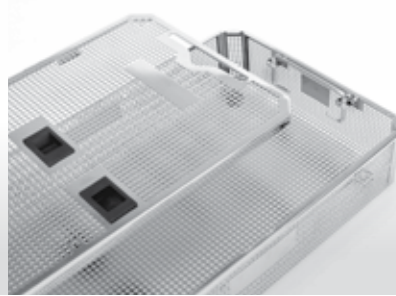

code	height
<b>OA 916</b>	10 mm



### STAND

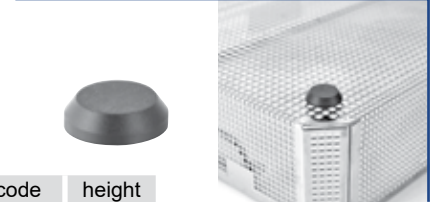

code	height
<b>OA 915</b>	5 mm

### RACK (for endoscopy)

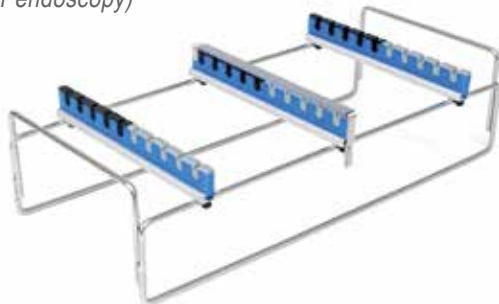

**OA 802**  
550 x 250 x 130 mm

- Holds 10 endoscopic instruments
- Fits into a Long size 18 cm deep container
- Wire basket Long 50 mm
- Container Long 180 mm
- Silicone mat 340x230 (2pcs)

### RACK (for kerrison)



**OA 821**  
220 x 250 x 160 mm

- Holds 10 kerrison punches
- Fits into a 1/2, 1/1 H:200 mm and Long size 18 cm deep container
- Wire basket 1/2 ,H:50 mm
- Wire basket 1/1 ,H:50 mm
- Container 1/2 200 mm
- Container 1/1 200 mm
- Wire basket long ,H 50 mm
- Container Long Size 180 mm

**DIVIDERS**



**OA 941.13**  
540 x 250 x 130 mm  
**OA 941.18**  
540 x 250 x 180 mm

**WIRE BASE**



**OA 940.03**  
545 x 255 x 30 mm

**DIVIDERS**



**OA 942.13**  
540 x 250 x 130 mm  
**OA 942.18**  
540 x 250 x 180 mm

**ALUMINIUM BASKET (with lid)**



**OB 01.05**  
245 x 130 x 55 mm

**ALUMINIUM BASKET (with lid)**



**OB 01.07**  
245 x 130 x 70 mm

**ALUMINIUM BASKET (with lid)**



**OB 01.10**  
245 x 130 x 105 mm

**SILICONE MAT**



**OA 504**  
340 x 230 mm  
(2 pcs)



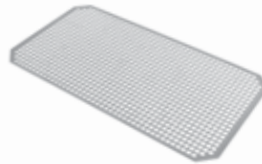



**SILICONE MESH MAT**



**OA 606**  
658 x 247 mm

**SILICONE HANDLE**



**OA 016**   
**OA 026**   
**OA 036**   
**OA 046**   
**OA 056**   
**OA 066** 

**IDENTIFICATION LABELS (aluminium)**

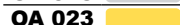
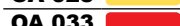
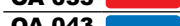
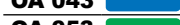
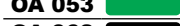

**OA 013**   
**OA 023**   
**OA 033**   
**OA 043**   
**OA 053**   
**OA 063** 

**LABELS (paper)**

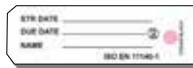

**OA 001**  
100 pcs. With indicator.

For small size and special containers

**LABELS (paper)**

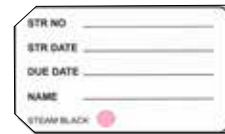

**OA 002**  
100 pcs. With indicator.

For full and Half size containers



**SECURITY SEAL (blue)**

**OA 742**  
100 pcs. with indicator.  
made of plastic



**SECURITY SEAL (blue)**

**OA 741**  
100 pcs. made of plastic



**SECURITY SEAL (red)**

**OA 732**  
100 pcs. with indicator.  
made of plastic



**SECURITY SEAL (red)**

**OA 731**  
100 pcs. made of plastic



**DISPOSAL STAMP**

**OA 008**  
40 x 35 x 9 mm  
Requested number or letter must be informed during the order.



**AUTO LOCK MECHANISM**

**OA 703**  
(2 Pcs)



**LABEL HOLDER**

**OA 007**  
50 x 35 x 13 mm  
Holder for identification labels

## ***STERILE CONTAINER SYSTEM***



**DENTAL ,MINI & SPECIAL SIZE CONTAINER**

## LARGE DENTAL MODEL CONTAINER









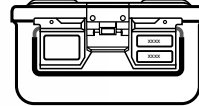

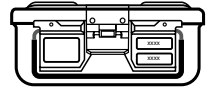
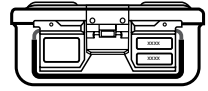





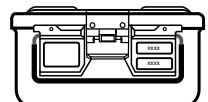

**BOX** (non perforated), **LID** (perforated)

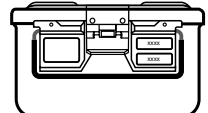

W: 255 mm

L: 380 mm



Specifications		Lid (Perforated)	
			
Height		Box (Non Perforated)	
		h:115 mm	
<b>OA 520.11</b>			
<b>OA 530.11</b>			
<b>OA 540.11</b>			
<b>OA 550.11</b>			
<b>OA 560.11</b>			
h:130 mm		<b>OA 510.13</b>	
		<b>OA 520.13</b>	
		<b>OA 530.13</b>	
		<b>OA 540.13</b>	
		<b>OA 550.13</b>	
		<b>OA 560.13</b>	
h:150 mm		<b>OA 510.15</b>	
		<b>OA 520.15</b>	
		<b>OA 530.15</b>	
		<b>OA 540.15</b>	
		<b>OA 550.15</b>	
		<b>OA 560.15</b>	

**BOX** (non perforated)



outside dimension

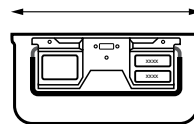

outside dimension

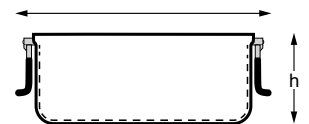







code	outside dimension	inside dimension	weight
<b>OC 50.10</b>	380 x 244 h:100 mm	330 x 234 h:94 mm	1370 g
<b>OC 50.11</b>	380 x 244 h:116 mm	330 x 234 h:112 mm	1465 g
<b>OC 50.13</b>	380 x 244 h:138 mm	330 x 234 h:130 mm	1542 g

**PERFORATED LIDS**









Dimension: 380 x 255 mm

code	color	weight
<b>OC 511</b>		835 g
<b>OC 521</b>		
<b>OC 531</b>		
<b>OC 541</b>		
<b>OC 551</b>		
<b>OC 561</b>		

**LID-BARRIER SYSTEM**



Dimension: 380 x 255 mm

code	color	weight
<b>OC 514</b>		969 g
<b>OC 524</b>		
<b>OC 534</b>		
<b>OC 544</b>		
<b>OC 554</b>		
<b>OC 564</b>		

## BASKET MADE FROM STAINLESS STEEL WIRE MESH

### WIRE BASKET

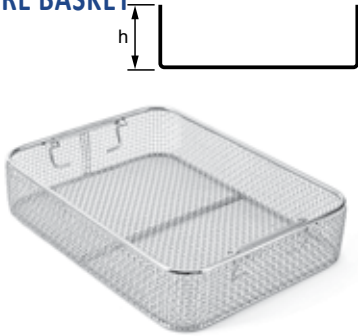

code	outside dimension
<b>OW 510.05</b>	323 x 222 h:50 mm
<b>OW 510.07</b>	323 x 222 h:70 mm
<b>OW 510.10</b>	323 x 222 h:100 mm

### WIRE BASKET WITH LID

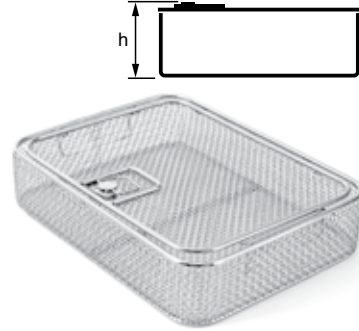

code	outside dimension
<b>OW 511.05</b>	323 x 222 h:55 mm
<b>OW 511.07</b>	323 x 222 h:75 mm
<b>OW 511.10</b>	323 x 222 h:105 mm
<b>OW 511</b>	ONLY LID, for baskets

### PAPER FILTER



**OA 201**  
Single use 100 pcs with indicator.  
• Diameter: 184 mm

### TEFLON FILTER



**OA 101**  
Number of sterilization cycle > 2000  
• Diameter: 194 mm

### FILTER DISPENSER

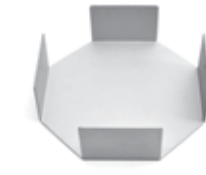

**OA 401**

### IDENTIFICATION LABELS (aluminium)



**OA 013**  
**OA 023**  
**OA 033**  
**OA 043**  
**OA 053**  
**OA 063**

### LABELS (paper)



**OA 001**  
100 pcs. With indicator.  
For small size and special containers

### LABELS (paper)



**OA 002**  
100 pcs. With indicator.  
For full and Half size containers



### SECURITY SEAL (blue)

**OA 742**  
100 pcs. with indicator.  
made of plastic



### SILICONE MAT

**OA 5011**  
260 x 180 mm



### SECURITY SEAL (blue)

**OA 741**  
100 pcs. made of plastic



### SECURITY SEAL (red)

**OA 742**  
100 pcs. with indicator.  
made of plastic



### AUTO LOCK MECHANISM

**OA 703**  
(2 Pcs)



### SECURITY SEAL (red)

**OA 731**  
100 pcs. made of plastic



### DISPOSAL STAMP

**OA 008**  
40 x 35 x 9 mm  
Requested number or letter must be informed during the order.





### LABEL HOLDER

**OA 007**  
50 x 35 x 13 mm  
Holder for identification labels

## BASKET MADE FROM STAINLESS STEEL SHEET

### BASKET

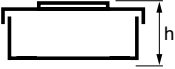
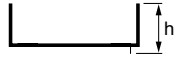

	code	outside dimension
Box and Lid 	<b>OP 511.05</b>	320 x 220 h:53 mm
	<b>OP 511.07</b>	320 x 220 h:73 mm
	<b>OP 511.10</b>	320 x 220 h:103 mm
Box 	<b>OP 510.05</b>	315 x 215 h:50 mm
	<b>OP 510.07</b>	315 x 215 h:70 mm
	<b>KOP 510.10</b>	315 x 215 h:100 mm
Lid 	<b>OP 511</b>	ONLY LID, for baskets

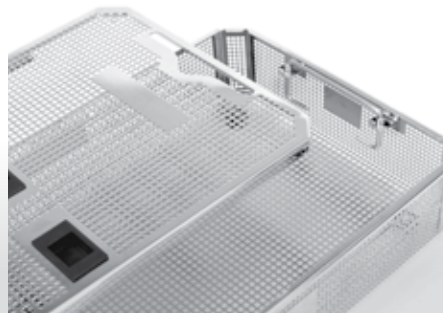

code	height
<b>OA 916</b>	10 mm



### STAND



code	height

## IDENTIFICATION (aluminium)

### LABEL HOLDER



code	color
<b>OA 0141</b>	Red
<b>OA 0241</b>	Blue
<b>OA 0341</b>	Green
<b>OA 0441</b>	Yellow
<b>OA 0541</b>	Orange
<b>OA 0641</b>	Black

### LABELS



code	color
<b>OA 014</b>	Red
<b>OA 024</b>	Blue
<b>OA 034</b>	Green
<b>OA 044</b>	Yellow
<b>OA 054</b>	Orange
<b>OA 064</b>	Black

Coloured identification labels  
Engraved to your specification



## DENTAL MODEL CONTAINER

Specifications	Lid (Perforated)	Lid (Perforated)	Lid (Non Perforated)	Lid (with barrier)	Lid (with barrier)
Sizes	Box (Non Perforated)	Box (Perforated)	Box (Non Perforated)	Box (Non Perforated)	Box (with barrier)
325 X 192 X 55 mm 	<b>OC 610.05</b> <b>OC 620.05</b> <b>OC 630.05</b> <b>OC 640.05</b> <b>OC 650.05</b> <b>OC 660.05</b>	<b>OC 611.05</b> <b>OC 621.05</b> <b>OC 631.05</b> <b>OC 641.05</b> <b>OC 651.05</b> <b>OC 661.05</b>	<b>OC 612.05</b> <b>OC 622.05</b> <b>OC 632.05</b> <b>OC 642.05</b> <b>OC 652.05</b> <b>OC 662.05</b>	<b>OC 613.05</b> <b>OC 623.05</b> <b>OC 633.05</b> <b>OC 643.05</b> <b>OC 653.05</b> <b>OC 663.05</b>	N/A
325 X 190 X 70 mm 	<b>OC 610.07</b> <b>OC 620.07</b> <b>OC 630.07</b> <b>OC 640.07</b> <b>OC 650.07</b> <b>OC 660.07</b>	<b>OC 611.07</b> <b>OC 621.07</b> <b>OC 631.07</b> <b>OC 641.07</b> <b>OC 651.07</b> <b>OC 661.07</b>	<b>OC 612.07</b> <b>OC 622.07</b> <b>OC 632.07</b> <b>OC 642.07</b> <b>OC 652.07</b> <b>OC 662.07</b>	<b>OC 613.07</b> <b>OC 623.07</b> <b>OC 633.07</b> <b>OC 643.07</b> <b>OC 653.07</b> <b>OC 663.07</b>	<b>OC 614.07</b> <b>OC 624.07</b> <b>OC 634.07</b> <b>OC 644.07</b> <b>OC 654.07</b> <b>OC 664.07</b>
325 X 190 X 135 mm 	<b>OC 610.13</b> <b>OC 620.13</b> <b>OC 630.13</b> <b>OC 640.13</b> <b>OC 650.13</b> <b>OC 660.13</b>	<b>OC 611.13</b> <b>OC 621.13</b> <b>OC 631.13</b> <b>OC 641.13</b> <b>OC 651.13</b> <b>OC 661.13</b>	<b>OC 612.13</b> <b>OC 622.13</b> <b>OC 632.13</b> <b>OC 642.13</b> <b>OC 652.13</b> <b>OC 662.13</b>	<b>OC 613.13</b> <b>OC 623.13</b> <b>OC 633.13</b> <b>OC 643.13</b> <b>OC 653.13</b> <b>OC 663.13</b>	<b>OC 614.13</b> <b>OC 624.13</b> <b>OC 634.13</b> <b>OC 644.13</b> <b>OC 654.13</b> <b>OC 664.13</b>

### WIRE BASKET (with lid)

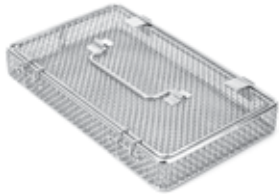

code	outside dimension
<b>OW 611.04</b>	270 x 175 x h:45 mm

### WIRE BASKET



code	outside dimension
<b>OW 610.03</b>	270 x 170 x h:38 mm

### DRAPE RETAINER



code	outside dimension
<b>OC 964</b>	277 x 175 mm

### SILICONE MAT

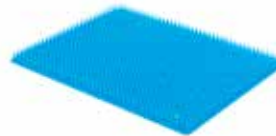

code	outside dimension
<b>OA 5011</b>	260 x 180 mm

### PAPER FILTER

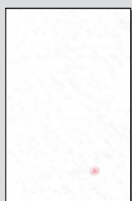

code <b>OA 202</b>
Dimension: 165 x 235 mm
Single use (100 pcs.)
With indicator

### TEFLON FILTER



code <b>OA 201</b>
Dimension: 150 x 233 mm
<b>Teflon Filter</b>
Number of sterilization cycle > 2000

## PERFORATED BOTTOMS

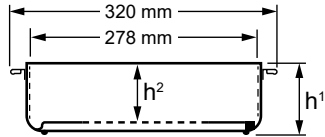
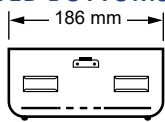

code	<b>OC 61.04</b>
outside dimension	320 x 186 x h <sup>1</sup> :43 mm
inside dimension	278 x 184 x h <sup>2</sup> :28 mm
weight	493 g



code	<b>OC 61.05</b>
outside dimension	320 x 186 x h <sup>1</sup> :58 mm
inside dimension	278 x 184 x h <sup>2</sup> :46 mm
weight	535 g



code	<b>OC 61.10</b>
outside dimension	320 x 186 x h <sup>1</sup> :102 mm
inside dimension	278 x 184 x h <sup>2</sup> :93 mm
weight	658 g



code	<b>OC 61.12</b>
outside dimension	320 x 186 x h <sup>1</sup> :122 mm
inside dimension	278 x 184 x h <sup>2</sup> :110 mm
weight	745 g

## SOLID BOTTOMS

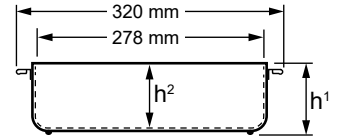
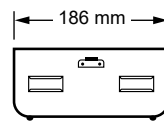

code	<b>OC 60.04</b>
outside dimension	320 x 186 x h <sup>1</sup> :43 mm
inside dimension	278 x 184 x h <sup>2</sup> :38 mm
weight	355 g



code	<b>OC 60.05</b>
outside dimension	320 x 186 x h <sup>1</sup> :59 mm
inside dimension	278 x 184 x h <sup>2</sup> :54 mm
weight	415 g









code	<b>OC 60.10</b>
outside dimension	320 x 186 x h <sup>1</sup> :102 mm
inside dimension	278 x 184 x h <sup>2</sup> :98 mm
weight	560 g



code	<b>OC 60.12</b>
outside dimension	320 x 186 x h <sup>1</sup> :122 mm
inside dimension	278 x 184 x h <sup>2</sup> :118 mm
weight	634 g

## PERFORATED LIDS









code	color	weight
<b>OC 611</b>		638 g
<b>OC 621</b>		
<b>OC 631</b>		
<b>OC 641</b>		
<b>OC 651</b>		
<b>OC 661</b>		

Dimension: 325 x 192 mm

## REMOVAL LIDS









code	color	weight
<b>OC 612</b>		516 g
<b>OC 622</b>		
<b>OC 632</b>		
<b>OC 642</b>		
<b>OC 652</b>		
<b>OC 662</b>		

Dimension: 325 x 192 mm



















































## BIO-BARRIER LIDS



code	color	weight
<b>OC 614</b>		862 g
<b>OC 624</b>		
<b>OC 634</b>		
<b>OC 644</b>		
<b>OC 654</b>		
<b>OC 664</b>		

Dimension: 325 x 192 mm  
www.orsamtıp.com.tr

# 1/2 DENTAL MODEL CONTAINER

Specifications 		Lid (Perforated)	Lid (Perforated)	Lid (Non Perforated)
				
	Sizes	Box (Non Perforated)	Box (Perforated)	Box (Non Perforated)
		232 X 174 X 63 mm		<b>OC 710.06</b>  <b>OC 720.06</b>  <b>OC 730.06</b>  <b>OC 740.06</b>  <b>OC 750.06</b>  <b>OC 760.06</b> 
232 X 174 X 100 mm		<b>OC 710.10</b>  <b>OC 720.10</b>  <b>OC 730.10</b>  <b>OC 740.10</b>  <b>OC 750.10</b>  <b>OC 760.10</b> 	<b>OC 711.10</b>  <b>OC 721.10</b>  <b>OC 731.10</b>  <b>OC 741.10</b>  <b>OC 751.10</b>  <b>OC 761.10</b> 	<b>OC 712.10</b>  <b>OC 722.10</b>  <b>OC 732.10</b>  <b>OC 742.10</b>  <b>OC 752.10</b>  <b>OC 762.10</b> 
232 X 174 X 130 mm		<b>OC 710.13</b>  <b>OC 720.13</b>  <b>OC 730.13</b>  <b>OC 740.13</b>  <b>OC 750.13</b>  <b>OC 760.13</b> 	<b>OC 711.13</b>  <b>OC 721.13</b>  <b>OC 731.13</b>  <b>OC 741.13</b>  <b>OC 751.13</b>  <b>OC 761.13</b> 	<b>OC 712.13</b>  <b>OC 722.13</b>  <b>OC 732.13</b>  <b>OC 742.13</b>  <b>OC 752.13</b>  <b>OC 762.13</b> 

 Ps: All container measurements cover the outer size of the lids.

### WIRE BASKET (with lid)

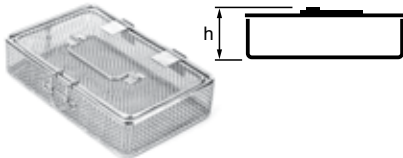

code	outside dimension
<b>OW 711.04</b>	175 x 153 x h:45 mm

### WIRE BASKET



code	outside dimension
<b>OW 710.04</b>	175 x 144 x h:40 mm

### STORAGE FRAME



code	outside dimension
<b>OA 961</b>	170 x 140 mm

### SILICONE MAT



code	outside dimension
<b>OA 501</b>	160 x 135 mm

### PAPER FILTER

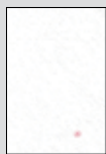

code **OA 204**  
 Dimension: 130 x 130 mm  
 Single use 100 pcs.  
 With indicator.

### TEFLON FILTER



code **OA 104**  
 Dimension: 130 x 130 mm  
 Number of sterilization cycle > 2000

### PERFORATED BOTTOMS

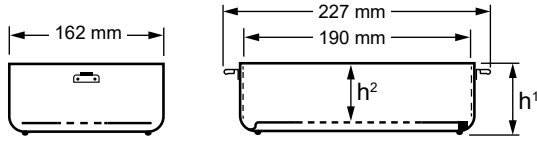

code	<b>OC 71.05</b>
outside dimension	227 x 162 x h <sup>1</sup> :57 mm
inside dimension	190 x 158 x h <sup>2</sup> :40 mm
weight	386 g



code	<b>OC 71.08</b>
outside dimension	227 x 162 x h <sup>1</sup> :88 mm
inside dimension	190 x 158 x h <sup>2</sup> :80 mm
weight	463 g



code	<b>OC 71.12</b>
outside dimension	227 x 162 x h <sup>1</sup> :122 mm
inside dimension	190 x 158 x h <sup>2</sup> :110 mm
weight	525 g

### SOLID BOTTOMS

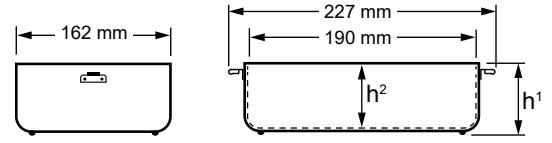

code	<b>OC 70.05</b>
outside dimension	227 x 162 x h <sup>1</sup> :57 mm
inside dimension	190 x 158 x h <sup>2</sup> :48 mm
weight	233 g









code	<b>OC 70.08</b>
outside dimension	227 x 162 x h <sup>1</sup> :88 mm
inside dimension	190 x 158 x h <sup>2</sup> :88 mm
weight	325 g



code	<b>OC 70.12</b>
outside dimension	227 x 162 x h <sup>1</sup> :122 mm
inside dimension	190 x 158 x h <sup>2</sup> :118 mm
weight	382 g







### PERFORATED LIDS

code	color	weight
<b>OC 711</b>		488 g
<b>OC 721</b>		
<b>OC 731</b>		
<b>OC 741</b>		
<b>OC 751</b>		
<b>OC 761</b>		

Dimension: 232 x 174 mm































































































### REMOVAL LIDS (non perforated)

code	color	weight
<b>OC 712</b>		360 g
<b>OC 722</b>		
<b>OC 732</b>		
<b>OC 742</b>		
<b>OC 752</b>		
<b>OC 762</b>		

Dimension: 232 x 174 mm



## MINI MODEL CONTAINER

Specifications	Lid (Perforated)	Lid (Perforated)	Lid (Non Perforated)	Lid (with barrier)	Lid (with barrier)
					
Sizes	Box (Non Perforated)	Box (Perforated)	Box (Non Perforated)	Box (Non Perforated)	Box (with barrier)
315 X 142 X 45 mm 	<b>OC 810.04</b>  <b>OC 820.04</b>  <b>OC 830.04</b>  <b>OC 840.04</b>  <b>OC 850.04</b>  <b>OC 860.04</b> 	<b>OC 811.04</b>  <b>OC 821.04</b>  <b>OC 831.04</b>  <b>OC 841.04</b>  <b>OC 851.04</b>  <b>OC 861.04</b> 	<b>OC 812.04</b>  <b>OC 822.04</b>  <b>OC 832.04</b>  <b>OC 842.04</b>  <b>OC 852.04</b>  <b>OC 862.04</b> 	<b>OC 813.04</b>  <b>OC 823.04</b>  <b>OC 833.04</b>  <b>OC 843.04</b>  <b>OC 853.04</b>  <b>OC 863.04</b> 	N/A
315 X 142 X 70 mm 	<b>OC 810.07</b>  <b>OC 820.07</b>  <b>OC 830.07</b>  <b>OC 840.07</b>  <b>OC 850.07</b>  <b>OC 860.07</b> 	<b>OC 811.07</b>  <b>OC 821.07</b>  <b>OC 831.07</b>  <b>OC 841.07</b>  <b>OC 851.07</b>  <b>OC 861.07</b> 	<b>OC 812.07</b>  <b>OC 822.07</b>  <b>OC 832.07</b>  <b>OC 842.07</b>  <b>OC 852.07</b>  <b>OC 862.07</b> 	<b>OC 813.07</b>  <b>OC 823.07</b>  <b>OC 833.07</b>  <b>OC 843.07</b>  <b>OC 853.07</b>  <b>OC 863.07</b> 	<b>OC 814.07</b>  <b>OC 824.07</b>  <b>OC 834.07</b>  <b>OC 844.07</b>  <b>OC 854.07</b>  <b>OC 864.07</b> 
315 X 142 X 100 mm 	<b>OC 810.10</b>  <b>OC 820.10</b>  <b>OC 830.10</b>  <b>OC 840.10</b>  <b>OC 850.10</b>  <b>OC 860.10</b> 	<b>OC 811.10</b>  <b>OC 821.10</b>  <b>OC 831.10</b>  <b>OC 841.10</b>  <b>OC 851.10</b>  <b>OC 861.10</b> 	<b>OC 812.10</b>  <b>OC 822.10</b>  <b>OC 832.10</b>  <b>OC 842.10</b>  <b>OC 852.10</b>  <b>OC 862.10</b> 	<b>OC 813.10</b>  <b>OC 823.10</b>  <b>OC 833.10</b>  <b>OC 843.10</b>  <b>OC 853.10</b>  <b>OC 863.10</b> 	<b>OC 814.10</b>  <b>OC 824.10</b>  <b>OC 834.10</b>  <b>OC 844.10</b>  <b>OC 854.10</b>  <b>OC 864.10</b> 

Ps: All container measurements cover size of filter based lids.

### WIRE BASKET (with lid)



code	outside dimension
<b>OW 811.04</b>	268 x 127 x h:47 mm

### WIRE BASKET



code	outside dimension
<b>OW 810.04</b>	268 x 117 x h:43 mm

### PORTABLE CARRIER (for small containers)



code	<b>OC 968</b>
Width	325 mm
Height	328 mm
Depth	145 mm

Wire suspenders, adjustable as required.  
Adjusting key of suspender is included.

### SILICONE MAT



code	outside dimension
<b>OC 502</b>	275 x 125 mm

### PAPER FILTER

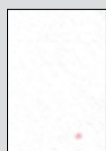

code	<b>OA 203</b>
Dimension:	230 x 120 mm
Single use	100 pcs.
With indicator.	

### TEFLON FILTER



code	<b>OA 103</b>
Dimension:	215 x 100mm
Number of sterilization cycle	> 2000

### PERFORATED BOTTOMS

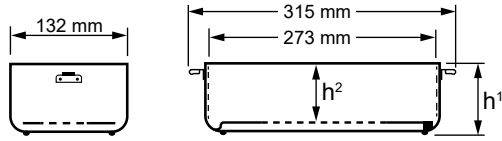

code	<b>OC 81.03</b>
outside dimension	315 x 132 x h¹:32 mm
inside dimension	273 x 128 x h²:18 mm
weight	338 g



code	<b>OC 81.06</b>
outside dimension	315 x 132 x h¹:63 mm
inside dimension	273 x 128 x h²:48 mm
weight	432 g



code	<b>OC 81.09</b>
outside dimension	315 x 132 x h¹:92 mm
inside dimension	273 x 128 x h²:78 mm
weight	523 g

### SOLID BOTTOMS

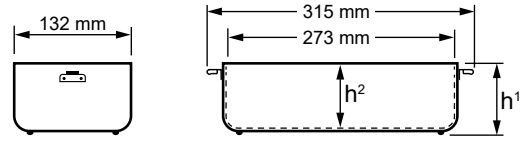

code	<b>OC 80.03</b>
outside dimension	315 x 132 x h¹:32 mm
inside dimension	273 x 128 x h²:30 mm
weight	232 g



code	<b>OC 80.06</b>
outside dimension	315 x 132 x h¹:63 mm
inside dimension	273 x 128 x h²:58 mm
weight	315 g



code	<b>OC 80.09</b>
outside dimension	315 x 132 x h¹:92 mm
inside dimension	273 x 128 x h²:90 mm
weight	419 g

### PERFORATED LIDS



code	color	weight
<b>OC 811</b>		513 g
<b>OC 821</b>		
<b>OC 831</b>		
<b>OC 841</b>		
<b>OC 851</b>		
<b>OC 861</b>		

### REMOVAL LIDS































































code	color	weight
<b>OC 812</b>		412 g
<b>OC 822</b>		
<b>OC 832</b>		
<b>OC 842</b>		
<b>OC 852</b>		
<b>OC 862</b>		

### BIO-BARRIER LIDS



code	color	weight
<b>OC 814</b>		686 g
<b>OC 824</b>		
<b>OC 834</b>		
<b>OC 844</b>		
<b>OC 854</b>		
<b>OC 864W</b>		

## FLAT MODEL CONTAINER

Specifications	Lid (Perforated)	Lid (Perforated)	Lid (Non Perforated)	Lid (with barrier)	Lid (with barrier)
					
Sizes	Box (Non Perforated)	Box (Perforated)	Box (Non Perforated)	Box (Non Perforated)	Box (with barrier)
297 X 280 X 75 mm 	<b>OC 910.07</b>  <b>OC 920.07</b>  <b>OC 930.07</b>  <b>OC 940.07</b>  <b>OC 950.07</b>  <b>OC 960.07</b> 	<b>OC 911.07</b>  <b>OC 921.07</b>  <b>OC 931.07</b>  <b>OC 941.07</b>  <b>OC 951.07</b>  <b>OC 961.07</b> 	<b>OC 912.07</b>  <b>OC 922.07</b>  <b>OC 932.07</b>  <b>OC 942.07</b>  <b>OC 952.07</b>  <b>OC 962.07</b> 	<b>OC 913.07</b>  <b>OC 923.07</b>  <b>OC 933.07</b>  <b>OC 943.07</b>  <b>OC 953.07</b>  <b>OC 963.07</b> 	N/A
297 X 280 X 90 mm 	<b>OC 910.09</b>  <b>OC 920.09</b>  <b>OC 930.09</b>  <b>OC 940.09</b>  <b>OC 950.09</b>  <b>OC 960.09</b> 	<b>OC 911.09</b>  <b>OC 921.09</b>  <b>OC 931.09</b>  <b>OC 941.09</b>  <b>OC 951.09</b>  <b>OC 961.09</b> 	<b>OC 912.09</b>  <b>OC 922.09</b>  <b>OC 932.09</b>  <b>OC 942.09</b>  <b>OC 952.09</b>  <b>OC 962.09</b> 	<b>OC 913.09</b>  <b>OC 923.09</b>  <b>OC 933.09</b>  <b>OC 943.09</b>  <b>OC 953.09</b>  <b>OC 963.09</b> 	<b>OC 914.09</b>  <b>OC 924.09</b>  <b>OC 934.09</b>  <b>OC 944.09</b>  <b>OC 954.09</b>  <b>OC 964.09</b> 

Ps: All container measurements cover the outer size of the lids.

### WIRE BASKET



code	outside dimension
<b>OW 210.03</b>	246 x 246 x h:30 mm
<b>OW 210.05</b>	246 x 246 x h:50 mm

### SILICONE MAT



code	outside dimension
<b>OA 503</b>	250 x 235 mm

### WIRE BASE



code	outside dimension
<b>OW 210</b>	255 x 255 x 30 mm

### PAPER FILTER

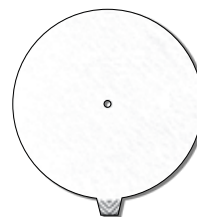

code	<b>OA 201</b>
Diameter	184 mm

Single use 100 pcs with indicator.

### DRAPE RETAINER



code	outside dimension
<b>OA 963</b>	255 x 255 mm

### TEFLON FILTER

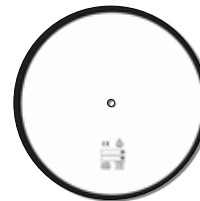

code	<b>OA 101</b>
Diameter	194 mm

Number of sterilization cycle > 2000

### PERFORATED BOTTOMS

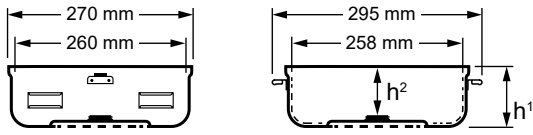

code	<b>OC 91.06</b>
outside dimension	295 x 270 x h <sup>1</sup> :60 mm
inside dimension	258 x 260 x h <sup>2</sup> :40 mm
weight	771 g



code	<b>OC 91.07</b>
outside dimension	295 x 270 x h <sup>1</sup> :72 mm
inside dimension	258 x 260 x h <sup>2</sup> :52 mm
weight	789 g

### SOLID BOTTOMS

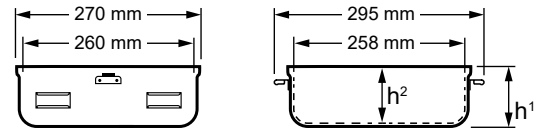

code	<b>OC 90.06</b>
outside dimension	295 x 270 x h <sup>1</sup> :60 mm
inside dimension	258 x 260 x h <sup>2</sup> :56 mm
weight	614 g



code	<b>OC 90.07</b>
outside dimension	295 x 270 x h <sup>1</sup> :72 mm
inside dimension	258 x 260 x h <sup>2</sup> :66 mm
weight	697 g

### PERFORATED LIDS



code	color	weight
<b>OC 911</b>		720 g
<b>OC 921</b>		
<b>OC 931</b>		
<b>OC 981</b>		
<b>OC 951</b>		
<b>OC 961</b>		

Dimension: 292 x 280 mm

### REMOVAL LIDS (non perforated)



code	color	weight
<b>OC 912</b>		617 g
<b>OC 922</b>		
<b>OC 932</b>		
<b>OC 982</b>		
<b>OC 952</b>		
<b>OC 962</b>		

Dimension: 292 x 280 mm

### BIO-BARRIER LIDS



code	color	weight
<b>OC 913</b>		965 g
<b>OC 923</b>		
<b>OC 933</b>		
<b>OC 983</b>		
<b>OC 953</b>		
<b>OC 963</b>		

Dimension: 292 x 280 mm

### SAFETY LIDS



code	color	weight
<b>OC 913</b>		630 g
<b>OC 923</b>		
<b>OC 933</b>		
<b>OC 933</b>		
<b>OC 933</b>		
<b>OC 933</b>		









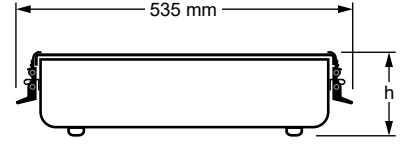
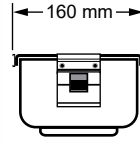



















### BIO-BARRIER SAFETY LID



code	color	weight
<b>OC 915</b>		670 g
<b>OC 925</b>		
<b>OC 935</b>		
<b>OC 945</b>		
<b>OC 955</b>		
<b>OC 915</b>		

## ENDOSCOPY MODEL CONTAINER



		Lid (Perforated)	Lid (Perforated)
			
		Box (Non Perforated)	Box (Perforated)
535 x 160 h:75 mm		<b>OC 1010.07</b> 	<b>OC 1011.07</b> 
		<b>OC 1020.07</b> 	<b>OC 1021.07</b> 
		<b>OC 1030.07</b> 	<b>OC 1031.07</b> 
		<b>OC 1040.07</b> 	<b>OC 1041.07</b> 
		<b>OC 1050.07</b> 	<b>OC 1051.07</b> 
		<b>OC 1060.07</b> 	<b>OC 1061.07</b> 
535 x 160 h:100 mm		<b>OC 1010.10</b> 	<b>OC 1011.10</b> 
		<b>OC 1020.10</b> 	<b>OC 1021.10</b> 
		<b>OC 1030.10</b> 	<b>OC 1031.10</b> 
		<b>OC 1040.10</b> 	<b>OC 1041.10</b> 
		<b>OC 1050.10</b> 	<b>OC 1051.10</b> 
		<b>OC 1060.10</b> 	<b>OC 1061.10</b> 

### PAPER FILTER

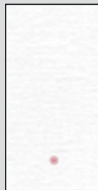

code **OC 205**

Dimension: 230 x 120 mm  
Single use 100 pcs.  
With indicator,

### TEFLON FILTER



code **OC 105**

Dimension: 215 x 100 mm  
Number of sterilization  
cycle > 2000

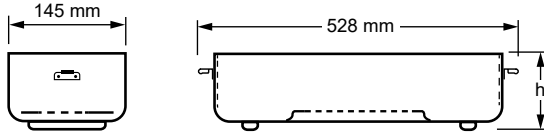

### PERFORATED BOTTOMS



### NON PERFORATED BOTTOMS



code	outside dimension	weight
<b>OC 1011.06</b>	528 x 145 h:64 mm	676 g
<b>OC 1011.08</b>	528 x 145 h:88 mm	786 g

code	outside dimension	weight
<b>OC 1010.06</b>	528 x 145 h:64 mm	668 g
<b>OC 1010.0</b>	528 x 145 h:88 mm	778 g

### LABELS (paper)



**OA 001**  
100 pcs. With indicator.

### LABELS (paper)

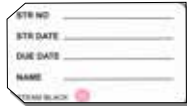

**OA 002**  
100 pcs. With indicator.

### IDENTIFICATION LABELS (aluminium)



<b>OA 013</b>	Grey
<b>OA 023</b>	Yellow
<b>OA 033</b>	Red
<b>OA 043</b>	Blue
<b>OA 053</b>	Green
<b>OA 063</b>	Black

### BASKET









code	outside dimension
<b>OP 1011.05</b>	492 x 134 x 55 mm
<b>OP 1011.06</b>	492 x 134 x 65 mm







































### PERFORATED LIDS



Dimension: 532 x 160 mm





































code	color	weight
<b>OC 1011</b>		795 g
<b>OC 1021</b>		
<b>OC 1031</b>		
<b>OC 1041</b>		
<b>OC 1051</b>		
<b>OC 1061</b>		

## IMPLANT MODEL CONTAINERS (NO FILTER )

Specifications 		Lid (Perforated)	Lid (Perforated)	Lid (Non Perforated)
				
Sizes 		Box (Non Perforated)	Box (Perforated)	Box (Non Perforated)
		300 X 150 X 75 mm	<b>OC 1110.7</b>  <b>OC 1120.7</b>  <b>OC 1130.7</b>  <b>OC 1140.7</b>  <b>OC 1150.7</b>  <b>OC 1160.7</b> 	<b>OC 1111.7</b>  <b>OC 1121.7</b>  <b>OC 1131.7</b>  <b>OC 1141.7</b>  <b>OC 1151.7</b>  <b>OC 1161.7</b> 
500 X 170 X 75 mm	<b>OC 1210.7</b>  <b>OC 1220.7</b>  <b>OC 1230.7</b>  <b>OC 1240.7</b>  <b>OC 1250.7</b>  <b>OC 1260.7</b> 	<b>OC 1211.7</b>  <b>OC 1221.7</b>  <b>OC 1231.7</b>  <b>OC 1241.7</b>  <b>OC 1251.7</b>  <b>OC 1261.7</b> 	<b>OC 1212.7</b>  <b>OC 1222.7</b>  <b>OC 1232.7</b>  <b>OC 1242.7</b>  <b>OC 1252.7</b>  <b>OC 1262.7</b> 	



























 Ps: All container measurements cover the outer size of the lids.

## MINI IMPLANT MODEL CONTAINERS (NO FILTER )

Specifications 		Lid (Perforated)	Lid (Perforated)	Lid (Non Perforated)
				
Sizes 		Box (Non Perforated)	Box (Perforated)	Box (Non Perforated)
		160 X 72 X 57 mm	<b>OC 1310.5</b>  <b>OC 1320.5</b>  <b>OC 1330.5</b>  <b>OC 1340.5</b>  <b>OC 1350.5</b>  <b>OC 1360.5</b> 	<b>OC 1311.5</b>  <b>OC 1321.5</b>  <b>OC 1331.5</b>  <b>OC 1341.5</b>  <b>OC 1351.5</b>  <b>OC 1361.5</b> 
200 X 147 X 57 mm	<b>OC 1410.5</b>  <b>OC 1420.5</b>  <b>OC 1430.5</b>  <b>OC 1440.5</b>  <b>OC 1450.5</b>  <b>OC 1460.5</b> 	<b>OC 1411.5</b>  <b>OC 1421.5</b>  <b>OC 1431.5</b>  <b>OC 1441.5</b>  <b>OC 1451.5</b>  <b>OC 1461.5</b> 	<b>OC 1412.5</b>  <b>OC 1422.5</b>  <b>OC 1432.5</b>  <b>OC 1442.5</b>  <b>OC 1452.5</b>  <b>OC 1462.5</b> 	

 Ps: All container measurements cover the outer size of the lids.



























## SCOPY MODEL CONTAINERS (NO FILTER )

Specifications ↻		Lid (Perforated)	Lid (Perforated)
			
Sizes ↻		Box (Non Perforated)	Box (Perforated)
		260 X 70 X 60 mm 	<b>OC 1510.6</b> 
<b>OC 1520.6</b> 	<b>OC 1521.6</b> 		
<b>OC 1530.6</b> 	<b>OC 1531.6</b> 		
<b>OC 1540.6</b> 	<b>OC 1541.6</b> 		
<b>OC 1550.6</b> 	<b>OC 1551.6</b> 		
<b>OC 1560.6</b> 	<b>OC 1561.6</b> 		
455 X 80 X 70 mm 	<b>OC 1610.7</b> 	<b>OC 1611.7</b> 	
	<b>OC 1620.7</b> 	<b>OC 1621.7</b> 	
	<b>OC 1630.7</b> 	<b>OC 1631.7</b> 	
	<b>OC 1640.7</b> 	<b>OC 1641.7</b> 	
	<b>OC 1650.7</b> 	<b>OC 1651.7</b> 	
	<b>OC 1660.7</b> 	<b>OC 1661.7</b> 	



Ps: All container measurements cover the outer size of the lids.

## SCOPY MODEL CONTAINERS (NO FILTER WITH SILICON)

Specifications ↻		Lid (Perforated)	Lid (Perforated)
			
Sizes ↻		Box (Non Perforated)	Box (Perforated)
		275 X 70 X 65 mm 	<b>OC 1710.6</b> 
<b>OC 1720.6</b> 	<b>OC 1721.6</b> 		
<b>OC 1730.6</b> 	<b>OC 1731.6</b> 		
<b>OC 1740.6</b> 	<b>OC 1741.6</b> 		
<b>OC 1750.6</b> 	<b>OC 1751.6</b> 		
<b>OC 1760.6</b> 	<b>OC 1761.6</b> 		
470 X 82 X 74 mm 	<b>OC 1810.7</b> 	<b>OC 1811.7</b> 	
	<b>OC 1820.7</b> 	<b>OC 1821.7</b> 	
	<b>OC 1830.7</b> 	<b>OC 1831.7</b> 	
	<b>OC 1840.7</b> 	<b>OC 1841.7</b> 	
	<b>OC 1850.7</b> 	<b>OC 1851.7</b> 	
	<b>OC 1860.7</b> 	<b>OC 1861.7</b> 	



Ps: All container measurements cover the outer size of the lids.



**BASKETS , ACCESSORIES & STAINLESS STEEL EQUIPMENTS**

## 1-BASKET MADE FROM STAINLESS STEEL WIRE

### *Mesh grid*

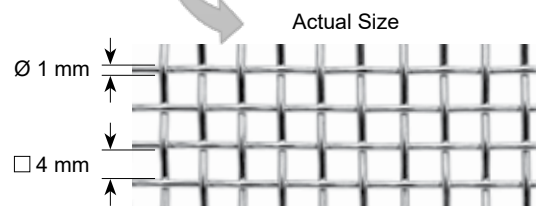
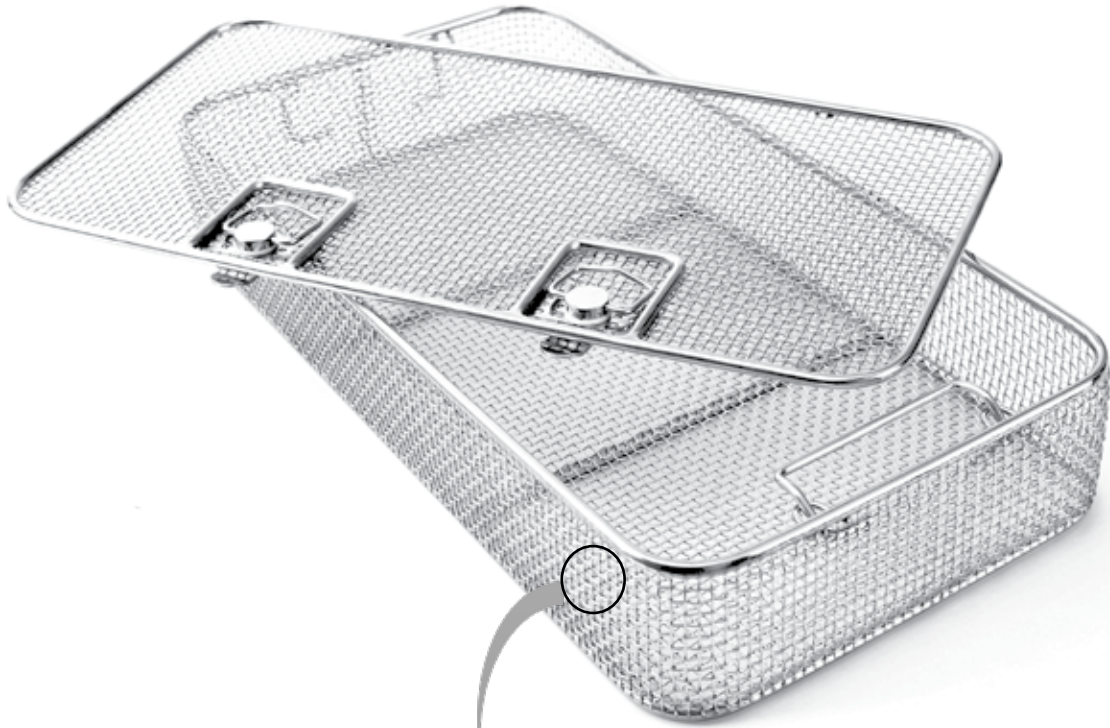

**WIRE BASKET WITH LID**



code	outside dimension
<b>OW 011.03</b>	540 x 245 h:35 mm
<b>OW 011.05</b>	540 x 245 h:55 mm
<b>OW 011.07</b>	540 x 245 h:75 mm
<b>OW 011.10</b>	540 x 245 h:105 mm
<b>OW 011</b>	ONLY LID, for baskets

code	outside dimension
<b>OW 021.03</b>	480 x 245 h:35 mm
<b>OW 021.05</b>	480 x 245 h:55 mm
<b>OW 021.07</b>	480 x 245 h:75 mm
<b>OW 021.10</b>	480 x 245 h:105 mm
<b>OW 021</b>	ONLY LID, for baskets



code	outside dimension
<b>OW 111.03</b>	405 x 245 h:35 mm
<b>OW 111.05</b>	405 x 245 h:55 mm
<b>OW 111.07</b>	405 x 245 h:75 mm
<b>OW 111.10</b>	405 x 245 h:105 mm
<b>OW 111</b>	ONLY LID, for baskets

code	outside dimension
<b>OW 211.03</b>	246 x 246 h:35 mm
<b>OW 211.05</b>	246 x 246 h:55 mm
<b>OW 211.07</b>	246 x 246 h:75 mm
<b>OW 211.10</b>	246 x 246 h:105 mm
<b>OW 211</b>	ONLY LID, for baskets

code	outside dimension
<b>OW 511.05</b>	323 x 222 h:55 mm
<b>OW 511.07</b>	323 x 222 h:75 mm
<b>OW 511.10</b>	323 x 222 h:105 mm
<b>OW 511</b>	ONLY LID, for baskets



code	outside dimension
<b>OW 311.05</b>	533 x 337 h:55 mm
<b>OW 311.07</b>	533 x 337 h:75 mm
<b>OW 311.10</b>	533 x 337 h:105 mm
<b>OW 311</b>	ONLY LID, for baskets

code	outside dimension
<b>OW 411.05</b>	665 x 250 h:55 mm
<b>OW 411.07</b>	665 x 250 h:75 mm
<b>OW 411.10</b>	665 x 250 h:105 mm
<b>OW 411</b>	ONLY LID, for baskets

## WIRE BASKETS WITHOUT LID



code	outside dimension
<b>OW 010.03</b>	540 x 245 h:30 mm
<b>OW 010.05</b>	540 x 245 h:50 mm
<b>OW 010.07</b>	540 x 245 h:70 mm
<b>OW 010.10</b>	540 x 245 h:100 mm

code	outside dimension
<b>OW 020.03</b>	480 x 245 h:30 mm
<b>OW 020.05</b>	480 x 245 h:50 mm
<b>OW 020.07</b>	480 x 245 h:70 mm
<b>OW 020.10</b>	480 x 245 h:100 mm



code	outside dimension
<b>OW 110.03</b>	405 x 245 x h:30 mm
<b>OW 110.05</b>	405 x 245 x h:50 mm
<b>OW 110.07</b>	405 x 245 x h:70 mm
<b>OW 110.10</b>	405 x 245 x h:100 mm



code	outside dimension
<b>OW 210.03</b>	246 x 246 x h:30 mm
<b>OW 210.05</b>	246 x 246 x h:50 mm
<b>OW 210.07</b>	246 x 246 x h:70 mm
<b>OW 210.10</b>	246 x 246 x h:100 mm



code	outside dimension
<b>OW 510.05</b>	323 x 222 h:50 mm
<b>OW 510.07</b>	323 x 222 h:70 mm
<b>OW 510.10</b>	323 x 222 h:100 mm



code	outside dimension
<b>OW 310.05</b>	533 x 337 h:50 mm
<b>OW 310.07</b>	533 x 337 h:70 mm
<b>OW 310.10</b>	533 x 337 h:100 mm



code	outside dimension
<b>OW 410.05</b>	665 x 250 h:50 mm
<b>OW 410.07</b>	665 x 250 h:70 mm
<b>OW 410.10</b>	665 x 250 h:100 mm

WIRE BASKETS

Mesh grid

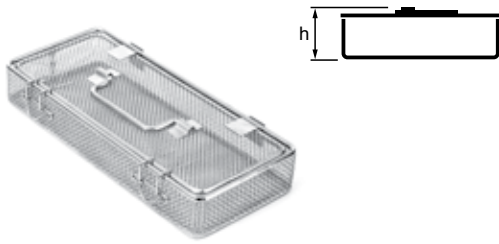
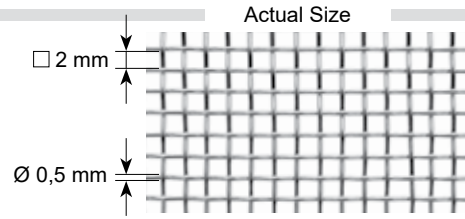

code	outside dimension
<b>OW 811.04</b>	268 x 127 x h:47 mm

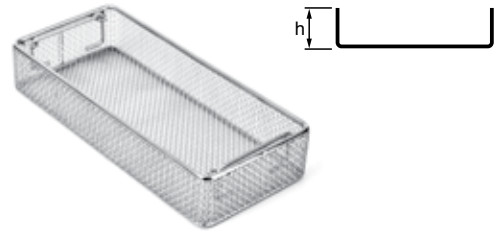

code	outside dimension
<b>OW 810.04</b>	268 x 117 x h:43 mm

WIRE BASKETS

Mesh grid

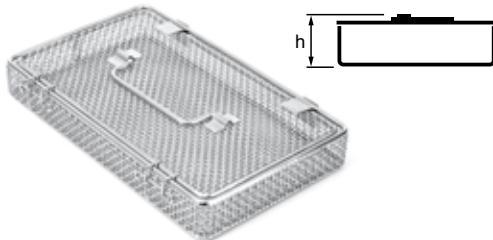
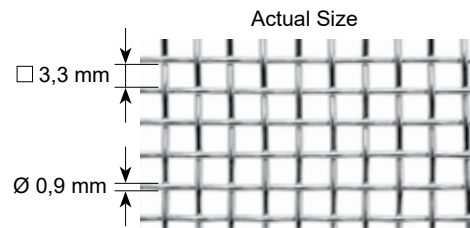

code	outside dimension
<b>OW 611.04</b>	270 x 175 x h:45 mm

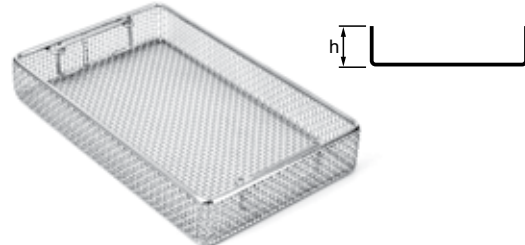

code	outside dimension
<b>OW 610.03</b>	270 x 170 x h:38 mm

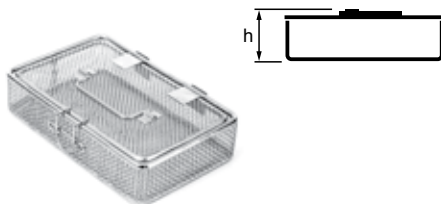

code	outside dimension
<b>OW 711.04</b>	175 x 153 x h:45 mm

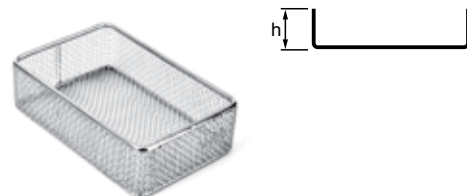

code	outside dimension
<b>OW 710.04</b>	175 x 144 x h:40 mm

## SMALL WIRE BASKETS WITH LID

### *Mesh grid*

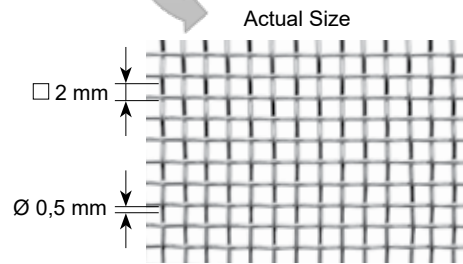
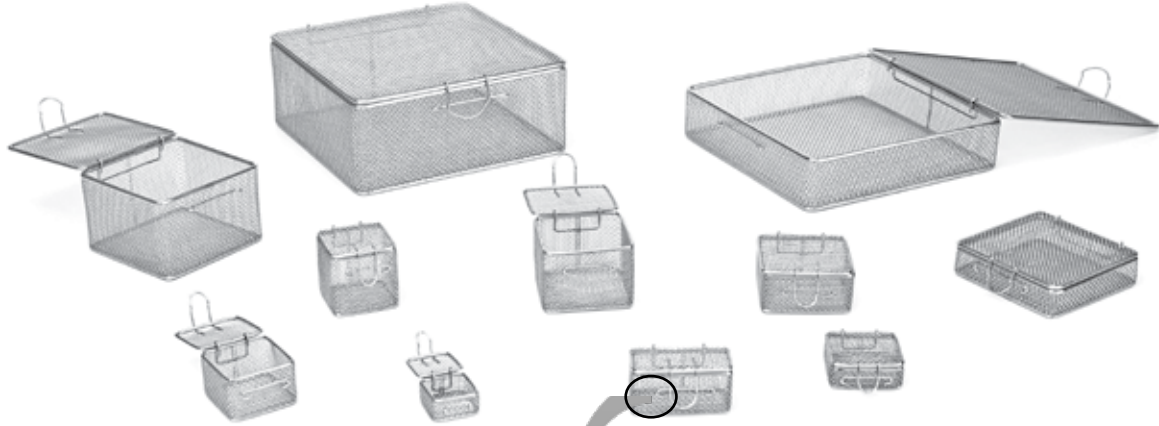

code	outside dimension
<b>OW 191.03</b>	30 x 30 x 30 mm
<b>OW 192.02</b>	40 x 40 x 20 mm
<b>OW 192.04</b>	40 x 40 x 40 mm
<b>OW 193.02</b>	60 x 60 x 20 mm
<b>OW 193.04</b>	60 x 60 x 40 mm
<b>OW 193.06</b>	60 x 60 x 60 mm
<b>OW 194.04</b>	80 x 40 x 40 mm
<b>OW 195.02</b>	80 x 80 x 20 mm
<b>OW 195.04</b>	80 x 80 x 40 mm
<b>OW 195.06</b>	80 x 80 x 60 mm
<b>OW 195.08</b>	80 x 80 x 80 mm
<b>OW 196.10</b>	100 x 100 x 10 mm
<b>OW 197.03</b>	120 x 120 x 30 mm
<b>OW 197.06</b>	120 x 120 x 60 mm
<b>OW 197.08</b>	120 x 120 x 80 mm
<b>OW 198.03</b>	240 x 240 x 30 mm
<b>OW 198.06</b>	240 x 240 x 60 mm
<b>OW 198.08</b>	240 x 240 x 80 mm
<b>OW 198.10</b>	240 x 240 x 100 mm

## 2-WIRE BASKET WITH PERFORATED METAL PLATE

*Mesh grid*

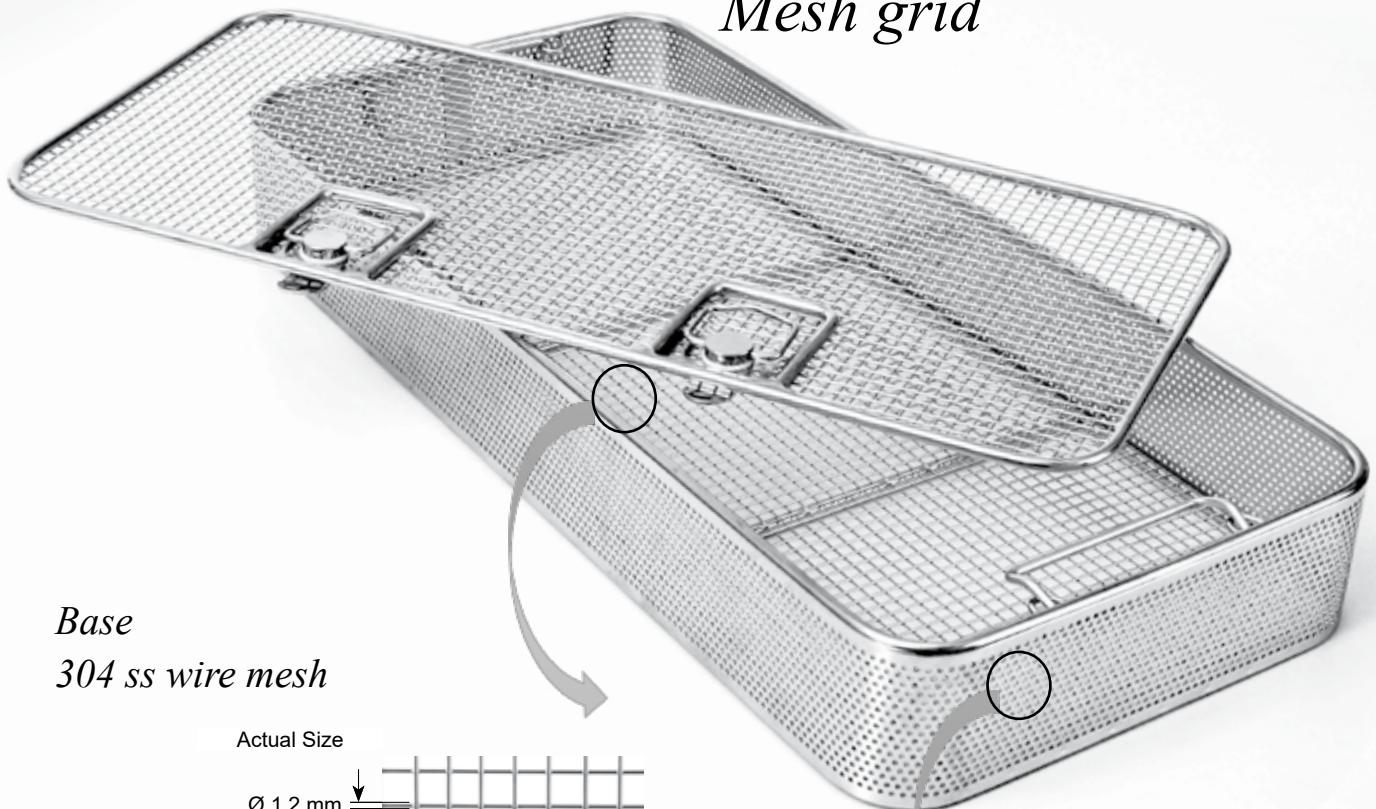

*Base*  
*304 ss wire mesh*

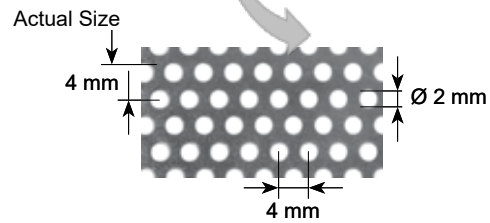
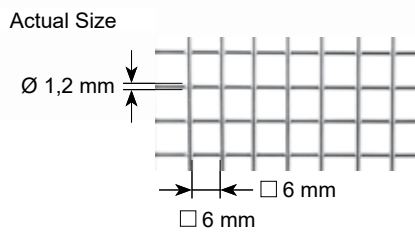

*Side Plate*  
*304 ss sheet*

## WIRE BASKETS



code	outside dimension
<b>OM 010.05</b>	540 x 245 h:50 mm
<b>OM 010.07</b>	540 x 245 h:70 mm
<b>OM 010.10</b>	540 x 245 h:100 mm



code	outside dimension
<b>OM 020.05</b>	480 x 245 h:50 mm
<b>OM 020.07</b>	480 x 245 h:70 mm
<b>OM 020.10</b>	480 x 245 h:100 mm



code	outside dimension
<b>OM 110.05</b>	405 x 246 x h:50 mm
<b>OM 110.07</b>	405 x 246 x h:70 mm
<b>OM 110.10</b>	405 x 246 x h:100 mm



code	outside dimension
<b>OM 210.05</b>	246 x 246 x h:50 mm
<b>OM 210.07</b>	246 x 246 x h:70 mm
<b>OM 210.10</b>	246 x 246 x h:100 mm

## WIRE BASKET WITH LID

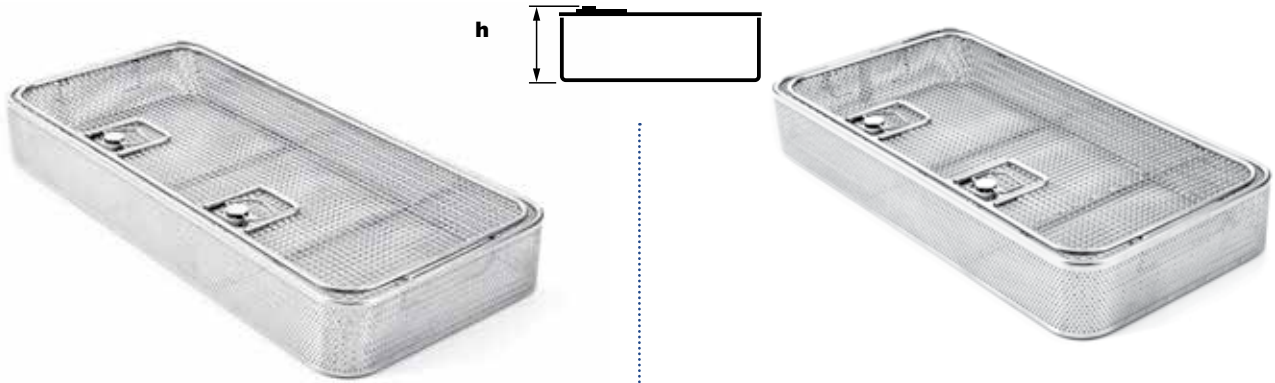

code	outside dimension
<b>OM 011.05</b>	540 x 245 h:55 mm
<b>OM 011.07</b>	540 x 245 h:75 mm
<b>OM 011.10</b>	540 x 245 h:105 mm
<b>OM 011</b>	ONLY LID, for baskets

code	outside dimension
<b>OM 021.05</b>	480 x 245 h:55 mm
<b>OM 021.07</b>	480 x 245 h:75 mm
<b>OM 021.10</b>	480 x 245 h:105 mm
<b>OM 021</b>	ONLY LID, for baskets





code	outside dimension
<b>OM 111.05</b>	405 x 246 x h:55 mm
<b>OM 111.07</b>	405 x 246 x h:75 mm
<b>OM 111.10</b>	405 x 246 x h:105 mm
<b>OM 111</b>	ONLY LID, for baskets



code	outside dimension
<b>OM 211.05</b>	246 x 246 x h:55 mm
<b>OM 211.07</b>	246 x 246 x h:75 mm
<b>OM 211.10</b>	246 x 246 x h:105 mm
<b>OM 211</b>	ONLY LID, for baskets

### 3-BASKET MADE FROM STAINLESS STEEL SHEET

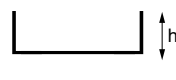

	code	outside dimension
Box and Lid 	<b>OP 311.03</b>	539 x 346 h:34 mm
	<b>OP 311.05</b>	539 x 346 h:54 mm
	<b>OP 311.07</b>	539 x 346 h:74 mm
	<b>OP 311.10</b>	539 x 346 h:104 mm
Box 	<b>OP 310.03</b>	533 x 340 h:30 mm
	<b>OP 310.05</b>	533 x 340 h:50 mm
	<b>OP 310.07</b>	533 x 340 h:70 mm
	<b>OP 310.10</b>	533 x 340 h:100 mm
Lid 	<b>OP 311</b>	ONLY LID, for baskets



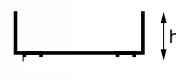
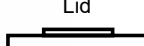

	code	outside dimension
Box and Lid 	<b>OP 411.03</b>	671 x 259 h:34 mm
	<b>OP 411.05</b>	671 x 259 h:54 mm
	<b>OP 411.07</b>	671 x 259 h:74 mm
	<b>OP 411.10</b>	671 x 259 h:104 mm
Box 	<b>OP 410.03</b>	665 x 253 h:30 mm
	<b>OP 410.05</b>	665 x 253 h:50 mm
	<b>OP 410.07</b>	665 x 253 h:70 mm
	<b>OP 410.10</b>	665 x 253 h:100 mm
Lid 	<b>OP 411</b>	ONLY LID, for baskets

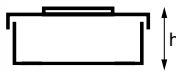
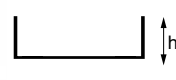
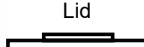

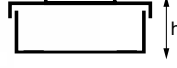
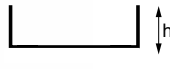

	code	outside dimension
Box and Lid 	<b>OP 011.03</b>	546 x 259 h:34 mm
	<b>OP 011.05</b>	546 x 259 h:54 mm
	<b>OP 011.07</b>	546 x 259 h:74 mm
	<b>OP 011.10</b>	546 x 259 h:104 mm
Box 	<b>OP 010.03</b>	540 x 253 h:30 mm
	<b>OP 010.05</b>	540 x 253 h:50 mm
	<b>OP 010.07</b>	540 x 253 h:70 mm
	<b>OP 010.10</b>	540 x 253 h:100 mm
Lid 	<b>OP 011</b>	ONLY LID, for baskets





	code	outside dimension
Box and Lid 	<b>OP 021.03</b>	491 x 259 h:34 mm
	<b>OP 021.05</b>	491 x 259 h:54 mm
	<b>OP 021.07</b>	491 x 259 h:74 mm
	<b>OP 021.10</b>	491 x 259 h:104 mm
Box 	<b>OP 020.03</b>	485 x 253 h:30 mm
	<b>OP 020.05</b>	485 x 253 h:50 mm
	<b>OP 020.07</b>	485 x 253 h:70 mm
	<b>OP 020.10</b>	485 x 253 h:100 mm
Lid 	<b>OP 021</b>	ONLY LID, for baskets

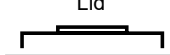

	code	outside dimension
Box and Lid 	<b>OP 111.03</b>	411 x 259 h:34 mm
	<b>OP 111.05</b>	411 x 259 h:54 mm
	<b>OP 111.07</b>	411 x 259 h:74 mm
	<b>OP 111.10</b>	411 x 259 h:104 mm
	<b>OP 110.05</b>	405 x 253 h:50 mm
	<b>OP 110.07</b>	405 x 253 h:70 mm
	<b>OP 110.10</b>	405 x 253 h:100 mm
Lid 	<b>OP 111</b>	ONLY LID, for baskets

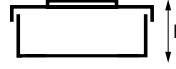

	code	outside dimension
Box and Lid 	<b>OP 211.03</b>	250 x 259 h:34 mm
	<b>OP 211.05</b>	250 x 259 h:54 mm
	<b>OP 211.07</b>	250 x 259 h:74 mm
	<b>OP 211.10</b>	250 x 259 h:104 mm
Box 	<b>OP 210.03</b>	244 x 253 h:30 mm
	<b>OP 210.05</b>	244 x 253 h:50 mm
	<b>OP 210.07</b>	244 x 253 h:70 mm
	<b>OP 210.10</b>	244 x 253 h:100 mm
Lid 	<b>OP 211</b>	ONLY LID, for baskets

## DENTAL BASKETS



code	outside dimension
<b>OP 1901.03</b>	274 x 180 x 32 mm
<b>OP 1901.04</b>	274 x 180 x 42 mm
<b>OP 1901.06</b>	274 x 180 x 62 mm



code	outside dimension
<b>OP 1902.03</b>	191 x 130 x 34 mm



code	outside dimension
<b>OP 1903.04</b>	138 x 124 x 48 mm



code	outside dimension
<b>OP 1904.03</b>	188 x 86 x 32 mm

Basket with blue silicone mat



code	outside dimension
<b>OP 1905.03</b>	240 x 76 x 30 mm

Basket with blue silicone mat



code	outside dimension
<b>OP 1906.02</b>	146 x 46 x 28 mm



code	outside dimension
<b>OP 1907.02</b>	86 x 46 x 28 mm

Bottom 2 mm, lid 4 mm perforation

### Pssibility to add a silicone fixation system as per your requirement



## ENDOSCOPE BASKETS

*304 ss wire mesh*

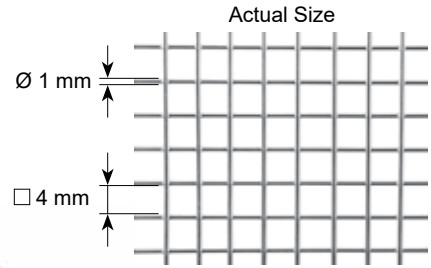

code	outside dimension
<b>OW 1901.05</b>	460 x 80 x 52 mm



code	outside dimension
<b>OW 1902.05</b>	670 x 80 x 52 mm



code	outside dimension
<b>OW 1903.05</b>	290 x 80 x 52 mm



code	outside dimension
<b>OW 1904.07</b>	640 x 150 x 77 mm

## SPRI BASKETS

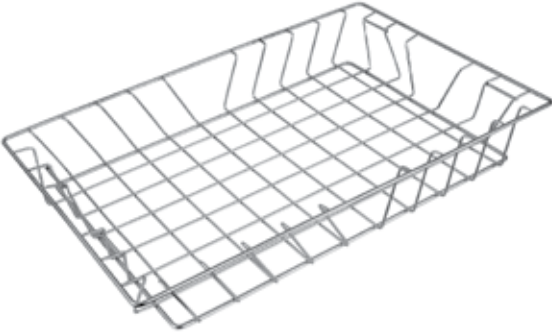

code	outside dimension
<b>OW 1906.05</b>	600 x 300 x 50 mm
<b>OW 1906.10</b>	600 x 300 x 100 mm
<b>OW 1906.15</b>	600 x 300 x 150 mm
<b>OW 1906.20</b>	600 x 300 x 200 mm
<b>OW 1907.10</b>	600 x 400 x 100 mm
<b>OW 1907.15</b>	600 x 400 x 150 mm
<b>OW 1907.20</b>	600 x 400 x 200 mm

## LAUNDRY BASKETS



code	outside dimension
<b>OW 1905.15</b>	600 x 400 x 150 mm
<b>OW 1905.30</b>	600 x 400 x 300 mm

## STE BASKETS

Standard

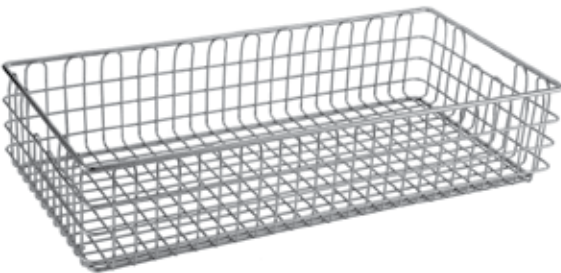

code	outside dimension
<b>OW 1908.13</b>	575 x 280 x 135 mm
<b>OW 1908.26</b>	575 x 280 x 265 mm

Front access



code	outside dimension
<b>OW 1909.26</b>	575 x 280 x 265 mm



## DRAPE



**OA 932**  
Fixation clamp



code	sizes	Container model
<b>OA 990</b>	130 x 60 cm	for 1/1 Model
<b>OA 991</b>	140 x 100 cm	
<b>OA 992</b>	185 x 45 cm	
<b>OA 993</b>	180 x 60 cm	
<b>OA 994</b>	140 x 100 cm	for 3/4 Model
<b>OA 995</b>	90 x 60 cm	for 1/2 Model
<b>OA 996</b>	90 x 80 cm	
<b>OA 997</b>	130 x 45 cm	
<b>OA 998</b>	130 x 60 cm	
<b>OA 9910</b>	90 x 60 cm	for Flat Model
<b>OA 9911</b>	90 x 80 cm	for Dental Model
<b>OA 9912</b>	60 x 40 cm	
<b>OA 9913</b>	60 x 40 cm	
<b>OA 9914</b>	65 x 65 cm	
<b>OA 9915</b>	85 x 85 cm	

## DRAPE RETAINER

code	model	size
<b>OA 961</b>	1/2 Dental flat drape retainer	170x140 mm
<b>OA 962</b>	Mini flat drape retainer	270x150 mm
<b>OA 963</b>	1/2 flat drape retainer	255x255 mm
<b>OA 964</b>	Dental flat drape retainer	277x175 mm
<b>OA 965</b>	3/4 flat drape retainer	404x255 mm
<b>OA 966</b>	Large flat drape retainer	533x337 mm
<b>OA 967</b>	1/1 flat drape retainer	545x255 mm
<b>OA 963.03</b>	1/2 drape retainer	255X255x30 mm
<b>OA 965.03</b>	3/4 drape retainer	404x255x30 mm
<b>OA 966.03</b>	Large drape retainer	533x337x30 mm
<b>OA 967.03</b>	1/1 drape retainer	545x255x30 mm



## ALUMINIUM BASKET, WITH LID



code	outside dimension
<b>OB 01.05</b>	245 x 130 x 55 mm



code	outside dimension
<b>OB 01.07</b>	245 x 130 x 70 mm



code	outside dimension
<b>OB 01.10</b>	245 x 130 x 105 mm



## TRAYS



code	outside dimension
<b>OA 9101.02</b>	186 x 72 x 24 mm



code	outside dimension
<b>OA 9103.02</b>	186 x 99 x 24 mm



code	outside dimension
<b>OA 9102.02</b>	186 x 137 x 24 mm



code	outside dimension
<b>OA 9104.03</b>	286 x 192 x 34 mm

**LABELS** (paper)

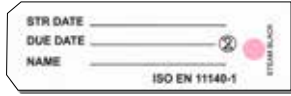

OA 001  
100 pcs. With indicator.

For small size and special containers

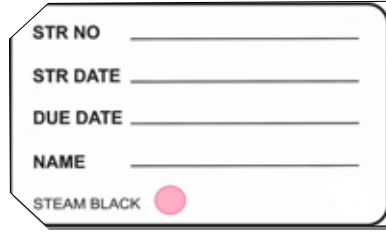

OA 002  
100 pcs. With indicator.

For full and Half size containers



**IDENTIFICATION LABELS** (aluminium)

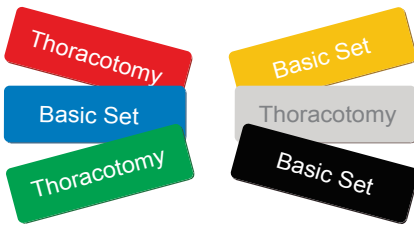

code	color
<b>OA 013</b>	Grey
<b>OA 023</b>	Yellow
<b>OA 033</b>	Red
<b>OA 043</b>	Blue
<b>OA 053</b>	Green
<b>OA 063</b>	Black

Coloured identification labels  
Engraved to your specifications  
Maximum 16 letters



**IDENTIFICATION** (aluminium)



code	color
<b>OA 0141</b>	Grey
<b>OA 0241</b>	Yellow
<b>OA 0341</b>	Red
<b>OA 0441</b>	Blue
<b>OA 0541</b>	Green
<b>OA 0641</b>	Black



**LABELS (ONLY)**

code	color
<b>OA 014</b>	Grey
<b>OA 024</b>	Yellow
<b>OA 034</b>	Red
<b>OA 044</b>	Blue
<b>OA 054</b>	Green
<b>OA 064</b>	Black



**LABEL DISPENSER**

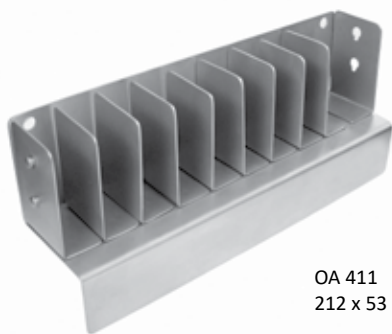

OA 411  
212 x 53 x 92 mm



OA 412  
108 x 53 x 92 mm

### LABEL HOLDER



OA 007  
50 x 35 x 13 mm  
Holder for identification labels



### DISPOSAL STAMP



OA 008  
40 x 35 x 9 mm  
Requested number or letter must be informed during the order.



### STORAGE STAND



OA 413  
390 x 85 x 153 mm

### SILICONE MATS

code	dimension
<b>OA 501</b>	160 x 135 mm
<b>OA 502</b>	275 x 125 mm
<b>OA 503</b>	250 x 235 mm
<b>OA 504</b>	340 x 230 mm (2 pcs)
<b>OA 505</b>	300 x 300 mm
<b>OA 506</b>	380 x 230 mm
<b>OA 507</b>	440 x 230 mm
<b>OA 508</b>	520 x 230 mm
<b>OA 509</b>	230 x 220 mm
<b>OA 5010</b>	475 x 230 mm
<b>OA 5011</b>	260 x 180 mm



### SILICONE MATS MESH

code	dimension
<b>OA 601</b>	250 x 240 mm
<b>OA 602</b>	485 x 250 mm
<b>OA 603</b>	534 x 247 mm
<b>OA 604</b>	395 x 245 mm
<b>OA 605</b>	527 x 335 mm
<b>OA 606</b>	658 x 247 mm

Silicone Mesh Mat,  
Enables surgical instruments to be stored without slip and dry well.

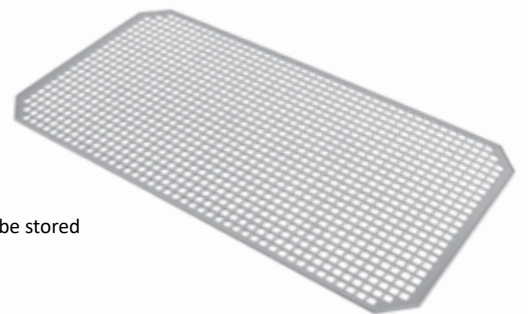

## SILICONE HANDLE & SILICONE HOSE



code	color
<b>OA 015</b>	White
<b>OA 025</b>	Yellow
<b>OA 035</b>	Red
<b>OA 045</b>	Blue
<b>OA 055</b>	Green
<b>OA 065</b>	Black



code	color
<b>OA 016</b>	White
<b>OA 026</b>	Yellow
<b>OA 036</b>	Red
<b>OA 046</b>	Blue
<b>OA 056</b>	Green
<b>OA 066</b>	Black



## SILICONE GASKETS FOR LIDS

code	model	size
<b>OA 511</b>	1/2 Dental silicone gasket	72 cm
<b>OA 512</b>	Mini silicone gasket	77 cm
<b>OA 513</b>	Dental silicone gasket	89 cm
<b>OA 514</b>	Flat silicone gasket	101 cm
<b>OA 515</b>	1/2 silicone gasket	101 cm
<b>OA 516</b>	Large Dental silicone gasket	118 cm
<b>OA 517</b>	Endo silicone gasket	130 cm
<b>OA 518</b>	3/4 silicone gasket	136 cm
<b>OA 519</b>	1/1 silicone gasket	158 cm
<b>OA 5110</b>	Large silicone gasket	180 cm
<b>OA 5111</b>	Long silicone gasket	185 cm



## FILTER DISPENSER

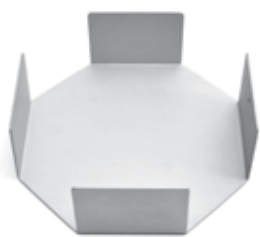

code **OA 401**

Dim 200 x 200 x 64 mm



code **OA 402**

Dim 250 x 177 x 40 mm















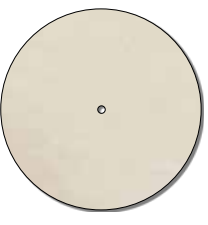
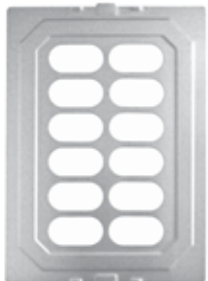

code **OA 403**

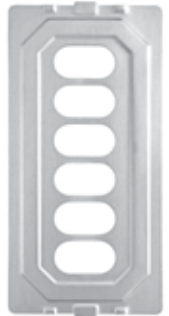
Dim 250 x 120 x 35 mm



code **OA 404**

Dim 169 x 151 x 53 mm

	<b>FILTER RETAINER</b>	<b>PAPER FILTER</b> Single use 100 pcs with indicator	<b>TEFLON FILTER</b> Number of sterilization cycle > 2000	<b>TEXTIL FILTER</b> Number of sterilization cycle > 50
<b>1/1 SIZE ,3/4 SIZE, 1/2 SIZE,LARGE SIZE ,LONG SIZE CONTAINER &amp; LARGE DENTAL MODEL</b>	 <p>code <b>OA 301</b> Diameter 186 mm</p>	 <p>code <b>OA 201</b> Diameter 185 mm</p>	 <p>code <b>OA 101</b> Diameter 194 mm</p>	 <p>code <b>OA 10</b> Diameter 194 mm</p>
<b>DENTAL MODEL</b>	 <p>code <b>OA 302</b> Dim 247 x 172 mm</p>	 <p>code <b>OA 202</b> Dim 165 x 235 mm</p>	 <p>code <b>OA 102</b> Dim 150 x 233 mm</p>	 <p>code <b>OA 12</b> Dim 150 x 233 mm</p>
<b>MINI MODEL</b>	 <p>code <b>OA 303</b> Dim 243 x 120 mm</p>	 <p>code <b>OA 203</b> Dim 230 x 120 mm</p>	 <p>code <b>OA 103</b> Dim 215 x 100 mm</p>	 <p>code <b>OA 13</b> Dim 215 x 100 mm</p>
<b>1/2 DENTAL MODEL</b>	 <p>code <b>OA 304</b> Dim 162 x 144 mm</p>	 <p>code <b>OA 204</b> Dim 130 x 130 mm</p>	 <p>code <b>OA 104</b> Dim 130 x 130 mm</p>	 <p>code <b>OA 14</b> Dim 130 x 130 mm</p>

## SECURITY SEAL



**OA 742**  
100 pcs. with indicator.  
made of plastic



**OA 741**  
100 pcs. made of plastic



**OA 732**  
100 pcs. with indicator.  
made of plastic



**OA 731**  
100 pcs. made of plastic



## AUTO LOCK MECHANISM



**OA 703**  
(2 Pcs)



### What is Auto Lock Mechanism?

Auto lock mechanism is a heat-sensitive automatic locking system developed in order to ease sterilization control by R&D department.

Modular auto lock system designed to be usable with different container systems which are belongs to different brands like shown below.

This system has been developed in accordance with the requirements of sterilization to be used in a steam autoclave for our container systems. Auto lock is a system designed in reusable property instead of disposable plastic products that are used as security locks in containers. The system has been tested in our own facilities 5000 cycles and has successfully passed all tests. Minimum expected life of the system is 5000 sterilizations. During this time system is usable without the need for any maintenance or service.

## SILICONE FIXATION SYSTEM

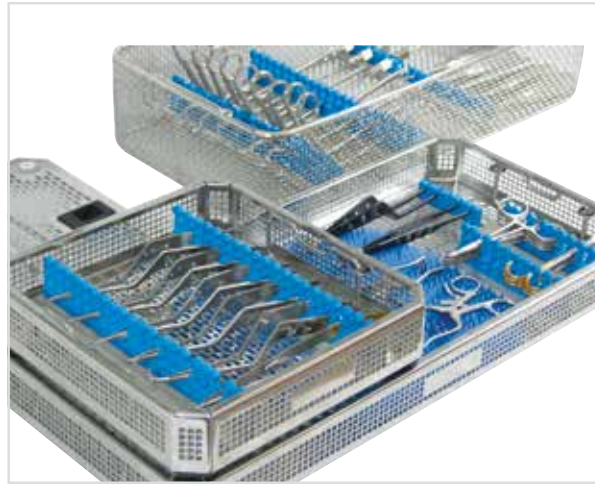



Can be manufactured in any size required

### RAIL



code	length
<b>OA 901</b>	250 x 9 mm
<b>OA 902</b>	158 x 9 mm
<b>OA 903</b>	123 x 9 mm
<b>OA 904</b>	97 x 9 mm
<b>OA 905</b>	73 x 9 mm
<b>OA 906</b>	23,5 x 9 mm

code	
<b>OA 911</b> (1 piece)	 Kep nut
<b>OA 912</b> (1 piece)	 Screw

### Silicone With rail, screw and nut



code	length	height
<b>OA 521</b>	250 mm	45 mm
<b>OA 522</b>	152 mm	45 mm
<b>OA 523</b>	125 mm	45 mm
<b>OA 524</b>	97 mm	45 mm



code	length	height
<b>OA 525</b>	238 mm	45 mm
<b>OA 526</b>	158 mm	45 mm
<b>OA 527</b>	112 mm	45 mm
<b>OA 528</b>	77 mm	45 mm

### Silicone With rail, screw and nut



code	length	height
<b>OA 529</b>	238 mm	45 mm
<b>OA 5210</b>	150 mm	45 mm
<b>OA 5211</b>	119 mm	45 mm
<b>OA 5212</b>	87 mm	45 mm



code	length	height
<b>OA 5213</b>	240 mm	45 mm
<b>OA 5214</b>	150 mm	45 mm
<b>OA 5215</b>	120 mm	45 mm
<b>OA 5216</b>	90 mm	45 mm



**Instruments holder Ø from 3 to 8 mm  
With rail, screw and nut**



code	length	height
<b>OA 5217</b>	178 mm	24 mm

**Instruments holder Ø 5 mm  
With rail, screw and nut**



code	length	height
<b>OA 5218</b>	73 mm	24 mm

**Instruments holder Ø 3 mm  
With rail, screw and nut**



code	length	height
<b>OA 5219</b>	73 mm	24 mm

**Instruments holder Ø from 3 to 15 mm  
With rail, screw and nut**



code	length	height
<b>OA 5220</b>	178 mm	34 mm

**Silicone With rail, screw and nut**



code	length	height
<b>OA 5221</b>	121 mm	22 mm

**Silicone With rail, screw and nut**



code	length	height
<b>OA 5222</b>	123 mm	22 mm

**Instruments holder Ø 3 mm  
With rail, screw and nut**



code	length	height
<b>OA 5223</b>	178 mm	24 mm

**Instruments holder Ø 5 mm  
With rail, screw and nut**



code	length	height
<b>OA 5224</b>	178 mm	24 mm



Silicone With rail,  
screw and nut

code	length	height
<b>OA 5225</b>	40 mm	25 mm



Ø 10,5 mm With rail,  
screw and nut

code	length	height
<b>OA 5226</b>	23.5 mm	25 mm



Ø 8 mm With rail,  
screw and nut

code	length	height
<b>OA 5227</b>	23.5 mm	25 mm



Ø 13 mm With rail,  
screw and nut

code	length	height
<b>OA 5228</b>	23.5 mm	25 mm



Ø 5 mm With rail,  
screw and nut

code	length	height
<b>OA 5229</b>	23.5 mm	25 mm

Endoscope holder: closed side from Ø 3-15 mm

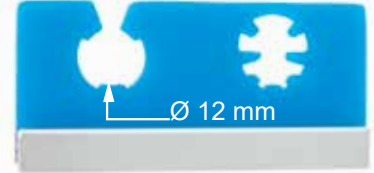

code	length	height
<b>OA 5330</b>	72 mm	34 mm

Endoscope holder,  
closed side from Ø 3 to Ø 8 mm



code	length	height
<b>OA 5231</b>	72 mm	34 mm

Instruments holder  
from Ø 3 to Ø 15 mm



code	length	height
<b>OA 5232</b>	72 mm	34 mm

Instruments holder,  
from Ø 3 to Ø 8 mm



code	length	height
<b>OA 5233</b>	72 mm	24 mm

Endoscope holder, double  
one side from Ø 3 to Ø 8 mm



code	length	height
<b>OA 5234</b>	38 mm	24 mm

Endoscope holder,  
open side from Ø 3 to Ø 15 mm



code	length	height
<b>OA 5235</b>	28 mm	34 mm

Endoscope holder,  
Ø 4 mm closed



code	length	height
<b>OA 5236</b>	38 mm	33 mm

Endoscope holder, Ø 6 mm closed



code	length	height
<b>OA 5237</b>	38 mm	33 mm

Endoscope holder, Ø 8 mm closed



code	length	height
<b>OA 5238</b>	38 mm	33 mm

Endoscope holder, Ø 12 mm closed



code	length	height
<b>OA 5239</b>	38 mm	33 mm

Endoscope holder, Ø 12 mm open



code	length	height
<b>OA 5240</b>	38 mm	33 mm

Endoscope holder, Ø 15 mm open



code	length	height
<b>OA 5241</b>	38 mm	33 mm

Sliding rails with securing screws

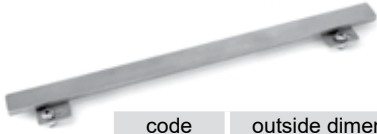

code	outside dimension
<b>OA 907</b>	230 x 26 mm
<b>OA 908</b>	470 x 26 mm

Limiting bar, with security screws



code	outside dimension
<b>OA 909</b>	230 x 26 mm
<b>OA 9010</b>	470 x 26 mm

Spiral holding device



code	outside dimension
<b>OA 9011</b>	233 x 30 mm

Spiral holding

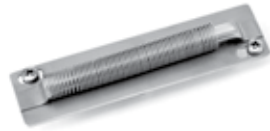

code	outside dimension
<b>OA 9012</b>	116 x 30 mm

Limiting bar



code	outside dimension
<b>OA 9013</b>	112 x 18 mm
<b>OA 9014</b>	172 x 18 mm
<b>OA 9015</b>	232 x 18 mm
<b>OA 9016</b>	472 x 18 mm

Spiral holding

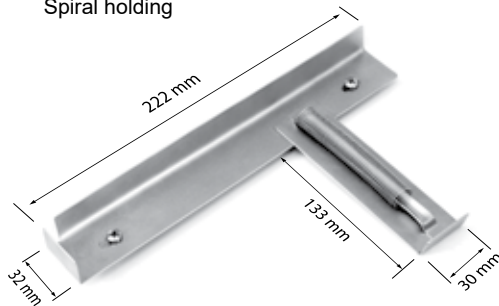

**OA 9017**

Spiral holding



code	outside dimension
<b>OA 9018</b>	223 x 30 mm

Spiral holding

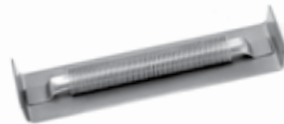

code	outside dimension
<b>OA 9019</b>	126 x 30 mm

DIVIDER (use with OA 906 and OA 907)



code	outside dimension
<b>OA 928</b>	40 x 5 x 18 mm

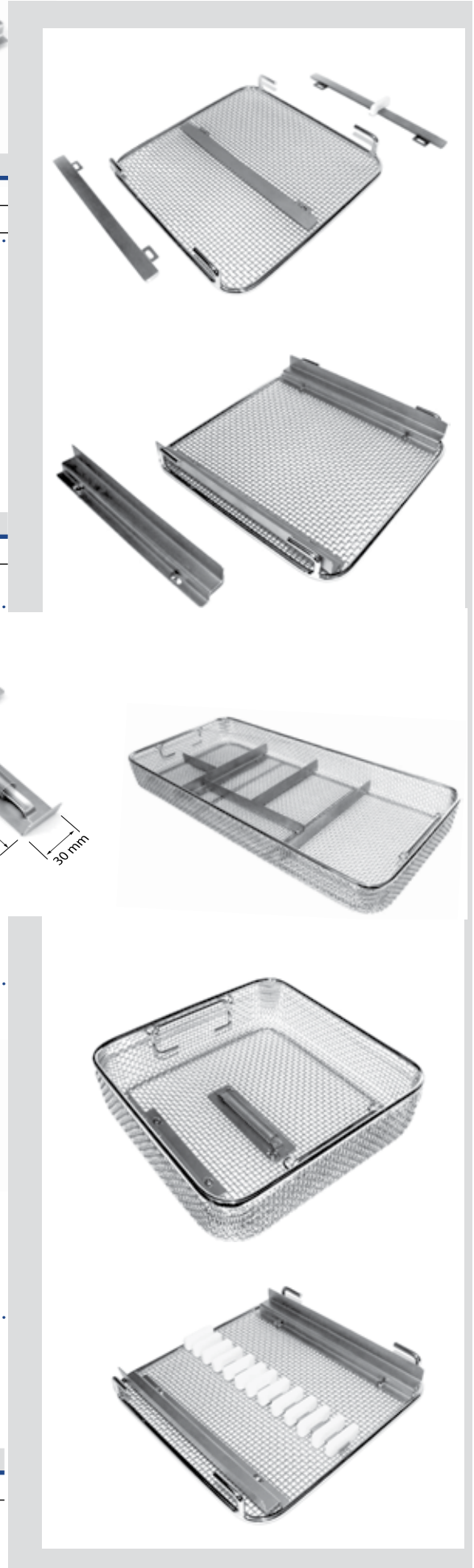



**OA 913**  
Holding pin for divider



**OA 914**  
Holding pin for instruments



**OA 921**  
DIVIDER  
50 x 20 mm

**OA 922**  
DIVIDER  
130 x 20 mm

**OA 923**  
DIVIDER  
225 x 20 mm

**OA 924**  
DIVIDER  
460 x 20 mm

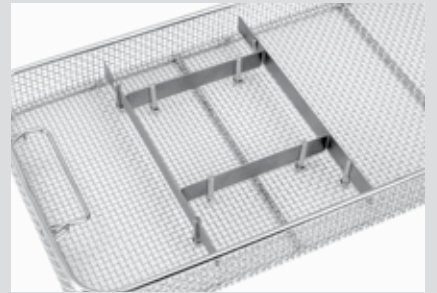
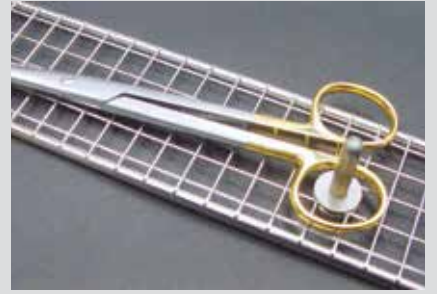

## FIXATION CLAMP



**OA 933**  
Ø 7 - 12 mm



**OA 934**  
Ø 12 - 16 mm



**OA 935**  
Ø 16 - 26 mm



**OA 936**  
Ø 26 - 36 mm



**OA 937**  
Ø 36 - 45 mm





**RACK FOR ENDOSCOPY**

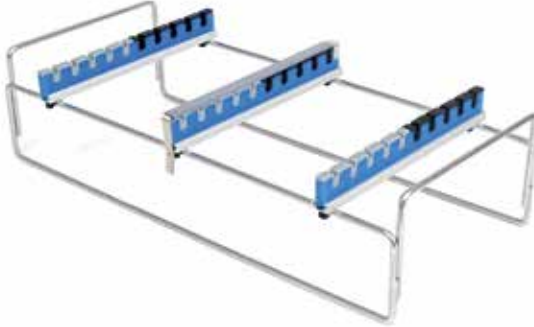

code	outside dimension
<b>OA 801</b>	505 x 250 x 125 mm

- Holds 10 endoscopic instruments
- Fits into a 1/1 size container, H= 200 mm

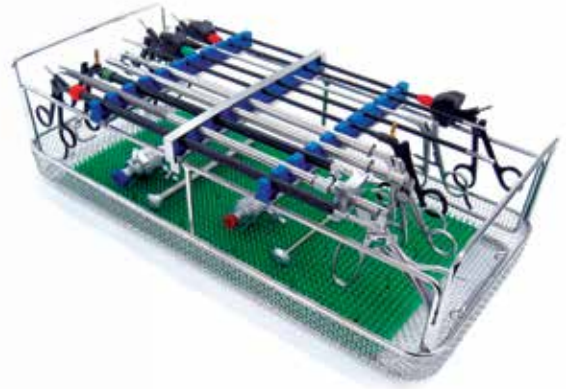

code	outside dimension
<b>OA 802</b>	550 x 250 x 130 mm

- Holds 10 endoscopic instruments
- Fits into a Long size container ,H =180 mm

**RACK FOR ARTROSCOPY**



code	outside dimension
<b>OA 811</b>	515 x 250 x 165 mm

- Holds 20 arthroscopy punches
- Fits into a 1/1 size container ,H=200 mm

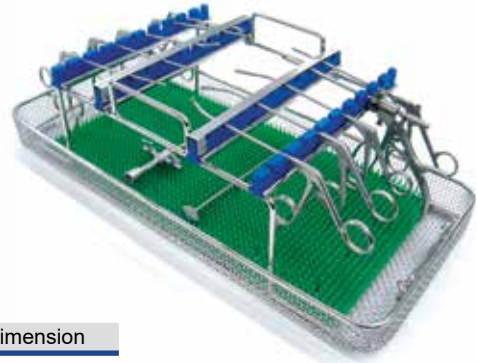

**RACK FOR KERRISON**



code	outside dimension
<b>OA 821</b>	220 x 250 x 160 mm

- Holds 10 kerrison punches
- Fits into : a 1/2 size container, 1/1 container H=200 mm and a Long size container H=180 mm



## STAINLESS STEEL EQUIPMENTS

code	outside dimension
<b>OAS 980</b>	110 x 63 x147 cm

The trolley is made from 304 quality stainless steel. There are fences surrounding the top except for the operator side to prevent the material from falling down.

Has four swivel casters, two of them with brake system. Different models are deigned and manufactured upon customer request.



code	outside dimension
<b>OAS 981</b>	115X69X154 cm

This trolley is used to carry containers & materials between contaminated and clean rooms in sterilization centers. Made from 304 quality stainless steel. Has four swivel casters, two of them with brake system. There is optional number of shelves.

Different models are designed & manufactured upon customer request.



code	outside dimension
<b>OAS 982</b>	88X55X90 cm

The trolley is Made from 304 quality stainless steel. There are fences surrounding the top except for the operator side to prevent the material from falling. There are six drawers and one cupboard section. The drawers are removable with telescopic rails for easy cleaning. Has four swivel casters, two of them with brake system. Different models are designed and manufactured upon customer request.



code	outside dimension
<b>OAS 983</b>	88X55X90 cm

Designed for medical dressing procedures. The trolley is made from 304 quality stainless steel. There are serum bottle holders on the upper part. The dressing cart has 3 drawers and 2 cabinet. The drawer can be opened, removed and cleaned by the telescopic rail system used in the drawer system. There is 12 lt removable waste bin. When the cuvette next to the cart is not used, it can be removed to reduce the volume of the cart. .Different models are designed and manufactured upon customer request.



code	outside dimension
<b>OAS 984</b>	88X55X90 cm

It is designed for use in the operating rooms and all hygienic rooms. The trolley is made from 304 quality stainless steel. There are fences surrounding the top except for the operator side to prevent the material from falling down. There is one drawer. The drawer is removable with telescopic rails for easy cleaning. . Different models are designed and manufactured upon customer request.



code	outside dimension
<b>OAS 985</b>	88X55X90 cm

The trolley is made from 304 quality stainless steel. There are fences surrounding the top except for the operator side to prevent the material from falling down. Has four swivel casters, two of them with brake system. Different models are designed and manufactured upon customer request.



code	outside dimension
<b>OAS 986</b>	46X91X90 cm

The trolley is made from 304 quality stainless steel. There are 3 wire baskets. Has four swivel casters, two of them with brake system. Different models are designed and manufactured upon customer request.



code	outside dimension
<b>OAS 987</b>	99X55X110 cm

This trolley is designed to carry containers and wire baskets at sterilization units. The trolley is made from 304 quality stainless steel. It can carry 15 containers (3+6+6). Has four swivel casters, two of them with brake system. Different models are designed and manufactured upon customer request.



code	outside dimension
<b>OAS 988</b>	126X61X126 cm

It is designed to carry containers and materials between contaminated and clean rooms in sterilization centers. The trolley is made from 304 quality stainless steel. Secured transfer of sterilized materials to store room. Has four swivel casters, two of them with brake system. There is optional number of shelves. Different models are designed and manufactured upon customer request.



code	outside dimension
<b>OAS 989</b>	60X60X155 cm

The trolley is designed to carry clogs. The trolley is made from 304 quality stainless steel. Has four swivel casters, two of them with brake system. Different models are designed and manufactured upon customer request



code	outside dimension
<b>OAS 990</b>	90X43X180 cm

The cabinet is made from 304 quality stainless steel. The upper part has a glass cover and locks. There are two drawers and one lockable cupboard at the bottom. The drawer can be removed from its place to be completely cleaned by the telescopic rail system used in the drawer system. There are 4 feet that adjust the height and level of the cabinet. Different models are designed and manufactured upon customer request.



code	outside dimension
<b>OAS 991</b>	90X43X180 cm

The cabinet is made from 304 quality stainless steel. In the cabinet there are 4 stacking areas divided by 3 shelves. There are key locking systems on the doors of the cabinet. The doors are completely made of glass so that the materials in the cabinet can be seen. Different models are designed and manufactured upon customer request



code	outside dimension
<b>OAS 992</b>	60X30X120 cm

The cabinet is made from 304 Quality stainless steel. There are 3 compartments to put the overshoes, bonnet and mask separately. Different models are designed and manufactured upon customer request.



code	outside dimension
<b>OAS 993</b>	150X67X120 cm

The sink is designed for operating rooms and for the units in where passing through to the sterilized area. The table is made from 304 quality stainless steel. Available with single, double, triple or more sinks. Separate controls for the water and the soap. Infrared sensor control. It can be produced either as bench type or Wall-mounted. Different models are designed and manufactured upon customer request.



code	outside dimension
<b>OAS 994</b>	180X60X85 cm

It is designed for sterilization units, Washing / Disinfection units and all types of washing units. The table is made from 304 quality stainless steel. Available with single, double, triple or more sinks according to capacity of the sterilization center. Different models are designed and produced upon customer request.





code	outside dimension
<b>OAS 995</b>	180X60X85 cm

The table is made from 304 quality stainless steel. It has 4 removable drawers with telescopic rail system for easy cleaning, the cupboard has sliding door that can easily open and close and shelf on the middle. T.Different models are designed and manufactured upon customer request.



code	outside dimension
<b>OAS 996</b>	130X60X85 cm

It is designed for use in sterilization units, packing department and in hygienical environment. The table is made from 304 quality stainless steel. There are 4 swivel casters, two of them with brakes system to fix the table when requested. As an optional, An optional drawer and power socket can be added. Different models are designed and manufactured upon customer request.



code	outside dimension
<b>OAS 997</b>	55X88X90 cm

The table is made from 304 quality stainless steel. There are fences surrounding the top except for the operator side to prevent the material from falling down. There are 4 swivel casters, two of them with brakes system to fix the table when requested. Different models are designed and manufactured upon customer request.



code	outside dimension
<b>OAS 998</b>	137X70X85 cm

It is designed to be used for controlling and packing textile materials. The table is made from 304 quality stainless steel. The upper tray is made of transparent plexi-glass material. The upper tray is illuminated by the lamps located inside the table. There are 4 swival casters, two of them with brakes system to fix the table when requested. Different models are designed and manufactured upon customer request.



code	outside dimension
<b>OAS 999</b>	175X45X90 cm

The table is designed for operating and intervention rooms. It is made from 304 quality stainless steel. The dimensions of this table can be designed and manufactured upon customer request.



code	outside dimension
<b>OAS 1000</b>	137X70X85 cm

The table is designed to isolate sensitive devices from vibration. All the kinds of vibration are eliminated by heavy granite table and stainless steel frame. Vertical and horizontal vibration isolation is provided in the body.



code	outside dimension
<b>OAS 1001</b>	122X46X183 cm

The rack is designed for operating theater, sterile warehouse and other units. Made from 304 quality stainless steel. It is portable and can be installed in three, four or five-shelf. There are 4 swivel casters, two of them with brakes system to fix the rack when requested



---

code	outside dimension
<b>OAS 1002</b>	122X46X183 cm

The rack is designed for operating theater, sterile warehouse and other units. Made from 304 quality stainless steel. It is portable and can be installed in three, four or five-shelf. There are 4 swivel casters, two of them with brakes system to fix the rack when requested





**ORSAMTIP**

*Sterilization Solutions*

**Possibility to manufacture all our stainless steel products as per your required size & model**



**Please contact for detailed information :**



+90 362 275 11 68



[www.orsamtip.com.tr](http://www.orsamtip.com.tr)



+90 553 311 73 07



[info@orsamtip.com.tr](mailto:info@orsamtip.com.tr)  
[sales@orsamtip.com.tr](mailto:sales@orsamtip.com.tr)