

**THE NETHERLANDS
(N E D E R L A N D)****COMMUNICATION**

Concerning ⁽¹⁾:

- ~~approval granted~~
- ~~approval extended~~
- ~~approval refused~~
- ~~approval withdrawn~~
- ~~production definitely discontinued~~

of a type of tyre for motor vehicles pursuant to Regulation number 30.

Approval number: E4*30R02/20*109488*04

1. Manufacturer's name and address : ZODO TIRE Co., LIMITED
The South of Yalujiang Road, Wenzhuang
Village Qinghe Agency of Cao County Heze
City, Shandong Province 274400 China(PRC)
2. Tyre type designation ⁽²⁾ :
- 2.1. Brand-name(s)/trademark(s) : GRENLANDER; ARIVO; CONSTANCY;
ILINK; LUXXAN; RHINO; CRYSTAL;
T TYRE; ROCKBLADE; FRONWAY;
SAILWIN; XBRI; ROADMARCH; KANGS;
ZMAX



- 2.2. Trade description(s)/Commercial name(s) : MAHO 77; POWERCITY 77; TOPOWER 87 H/T; ROADPOWER H/T; ROADKING H/T; TERRANO ARV H/T; FORZA H/T 2; INSPIRER F4; ROCK 717 H/T; TWENTY TWO; Maxim; PRIMEMARCH H/T 77; MAGA A/T ONE; FORZA A/T; TERRAMAX LSR1 A/T; TERRA XPLOER C1 A/T; GLADIATAX A/T I; ROCKBLADE A/T I; TERRAMAX ARV A/T; INSPIRER A/T I; TOUGH TRAC A/T I; ROCK 727 A/T; PRIMEMAX A/T I; COLO H01; L-GRIP66; LY168; ECOGREEN 66; VENUSATR 66; Energize; PREMIO ARZ1; ECOLOGY; INSPIRER C4; THREE; ROCK 515; PRIMESTAR 66; GREENWING A/S; MULTIMATCH A/S; FRONWING A/S; FREIMATCH A/S; Carlorful A/S; PRIME A/S; ROCK A/S ONE; FORTY ONE; INSPIRER A/S 1; MAGA A/T TWO; FORZA A/T 2; TERRAMAX LSR2 A/T; TERRA XPLOER C2 A/T; GLADIATAX A/T II; ROCKBLADE A/T II; TERRAMAX ARV PRO A/T; INSPIRER A/T II; TOUGH TRAC A/T II; ROCK 737 A/T; PRIMEMAX A/T II; Winter GL868; Winter IL868; LY868; ICEPOWER 868; ICEWINNER 868; WINMASTER ARW2; ROCK 868S; THIRTY TWO; SNOWROVER 868; LY788; L-FINDER78; FORZA H/T; GP1000; HIGHROAD H/T 78; SPEEDROAD H/T 78; INSPIRER F2; Rapid; ROCK 788; LY969; L-SNOW99; WINTERCROSS ARW7; INSPIRER W8; ICEPOWER 99; ICEWINNER 99; ROCK 919S; COMMANDER W7; CAPACITY; MAHO 79; POWERCITY 79; ROADPOWER H/T 79; SAILKING H/T 79; TRAVERSO ARV H/T; INSPIRER F6; ROCK 719 H/T; PRIMEMARCH H/T 79; GALLOPRO H/T; Winter GL888; Winter IL888; LY888; ICEPOWER 888; ICEWINNER 888; WINTERCROSS ARW8; ROCK 888S
3. If applicable, name and address of the manufacturer's representative : Not applicable
4. Summarised description :
- 4.1. Tyre size designation : 245/70R16
- 4.2. Category of use : ~~normal~~/snow/special use/temporary use⁽¹⁾

Approval number: E4*30R02/20*109488*04

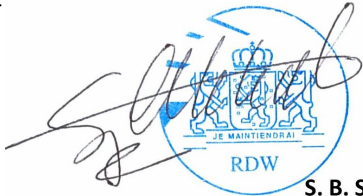
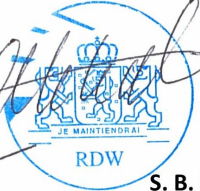
- 4.3. Structure : ~~diagonal/bias-belted~~/radial/~~run-flat tyre~~⁽¹⁾
- 4.4. Speed category symbol : H
- 4.5. Load-capacity index : 111
5. Technical service and, where applicable, test laboratory approved for purposes of approval or of verification of conformity : IDIADA Automotive Technology, S.A.
L'Albornar, P.O. Box 20
43710 Santa Oliva (Tarragona)
Spain
6. Date of report issued by that service : January 11, 2019
June 21, 2019
January 14, 2020
7. Number of report issued by that service : 0004\ISP\OMLS\19_2
0124\ISP\OMLS\19_82
CN20010254
8. Reason(s) of extension (if applicable) : Addition of brand name and trade description;
Modification of manufacturer's name;
The technical service is changed into IDIADA
9. Any remarks : ---
10. Place : Zoetermeer
11. Date : 24 February 2020
12. Signature : 

S. B. S. Akkal
13. The list of documents in the approval file which are deposited at the administrative service having delivered the approval and which can be obtained upon request.
- Application form relating to ECE approval for a pneumatic tyre pursuant to Regulation number 30.
 - The drawing of the tyre's sidewalls, tread and dimensioned cross-section.
 - The test report as mentioned in item 7.

⁽¹⁾ Strike out what does not apply.

⁽²⁾ A list of Brand name(s)/trademark(s) or Trade description(s)/ Commercial name(s) may be annexed to this communication

TECHNICAL DOCUMENTATION



APPLICATION FOR APPROVAL EXTENSION OF A TYPE OF PNEUMATIC TYRE ACCORDING
TO ECE REGULATION No. 30, 02 SERIES OF AMENDMENTS

- | | | |
|------|--|---|
| 1. | Manufacturer's name or trade mark(s) on the tyre type ⁽²⁾ | : GRENLANDER;CONSTANCY;ILINK;LUXXAN; ARIVO;RHINO;CRYSTAL;T TYRE; ROCKBLADE; FRONWAY; SAILWIN; XBRI;ROADMARCH; <u>KANGS;ZMAX</u> |
| 2. | Tyre type designation by the manufacturer ⁽²⁾ | : MAHO 77;POWERCITY 77;TOPOWER 87 H/T; ROADPOWER H/T;ROADKING H/T;TERRANO ARV H/T;FORZA H/T 2;INSPIRER F4;ROCK 717 H/T; TWENTY TWO;Maxim;PRIMEMARCH H/T 77; MAGA A/T ONE;FORZA A/T;TERRAMAX LSR1 A/T; TERRA XPLORER C1 A/T;GLADIATAX A/T I; ROCKBLADE A/T I;TERRAMAX ARV A/T; INSPIRER A/T I;TOUGH TRAC A/T I;ROCK 727 A/T; PRIMEMAX A/T I; COLO H01;L-GRIP66;LY168; ECOGREEN 66;VENUSATR 66;Energize;PREMIO ARZ1;ECOLOGY;INSPIRER C4;THREE;ROCK 515; PRIMESTAR 66; GREENWING A/S;MULTIMATCH A/S;FRONWING A/S;FREIMATCH A/S;Carlorful A/S; PRIME A/S;ROCK A/S ONE;FORTY ONE;INSPIRER A/S 1; MAGA A/T TWO;FORZA A/T 2;TERRAMAX LSR2 A/T;TERRA XPLORER C2 A/T;GLADIATAX A/T II;ROCKBLADE A/T II;TERRAMAX ARV PRO A/T; INSPIRER A/T II;TOUGH TRAC A/T II;ROCK 737 A/T; PRIMEMAX A/T II; Winter GL868;Winter IL868;LY868;ICEPOWER 868;ICEWINNER 868; WINMASTER ARW2;ROCK 868S;THIRTY TWO; SNOWROVER 868;LY788;L-FINDER78;FORZA H/T; GP1000;HIGHROAD H/T 78;SPEEDROAD H/T 78; INSPIRER F2;Rapid;ROCK 788;LY969;L-SNOW99; WINTERCROSS ARW7;INSPIRER W8;ICEPOWER 99; ICEWINNER 99;ROCK 919S; <u>COMMANDER W7; CAPACITY;MAHO 79;POWERCITY 79; ROADPOWER H/T 79;SAILKING H/T 79; TRAVERSO ARV H/T;INSPIRER F6;ROCK 719 H/T; PRIMEMARCH H/T 79;GALLOPRO H/T; Winter GL888; Winter IL888;LY888;ICEPOWER 888;ICEWINNER 888; WINTERCROSS ARW8;ROCK 888S;</u> |
| 3. | Manufacturer's name and address | : <u>ZODO TIRE Co., LIMITED</u>
The South of Yalujiang Road, Wenzhuang Village Qinghe Agency of Cao County Heze City, Shandong Province 274400 China(PROC) |
| 4. | If applicable, name and address of the manufacturer's representative | : N.A. |
| 5. | Summarized description | |
| 5.1. | Tyre size designation | : 245/70R16 |
| 5.2. | Category of use | : normal /snow/ special use / temporary use ⁽¹⁾ |
| 5.3. | Structure | : diagonal / bias belted /radial/ run flat tyre ⁽¹⁾ |
| 5.4. | Speed category symbol | H |
| 5.5. | Load-capacity index | 111 |
| 6. | Overall dimensions | : |
| | overall section width | : 248 |
| | outer diameter | : 750 |
| 7. | Factor 'x' | : 0.7 |
| 8. | Rims on which the tyre can be mounted | : 7J |
| 9. | Measuring rim and test rim | : See attached test report |

(1) Strike out what does not apply.

(2) Modified points are underlined for extension.



10. State whether the tyre is : Tubeless / ~~tube type~~⁽¹⁾
11. State whether the tyre is : ~~Standard~~ / reinforced⁽¹⁾
12. State if special use tyre : N.A.
- Professional Off-Road : ~~Yes~~/ no⁽¹⁾
- Tread depth : N.A.
- Void to fill ratio : N.A.
13. Submitted for approval on (date) : December 11, 2019

We herewith declare that we have not applied and will not apply for approval with another Contracting Party of the ECE for the same type of product.

MANUFACTURER'S STAMP



Signature :

Ren Hailang

.....
Name:

THIS APPLICATION IS ACCOMPANIED BY:

- A drawing of the tyre's side wall, tread and dimensioned cross section.
- The test report.



(1) Strike out what does not apply.
(2) Modified points are underlined for extension.

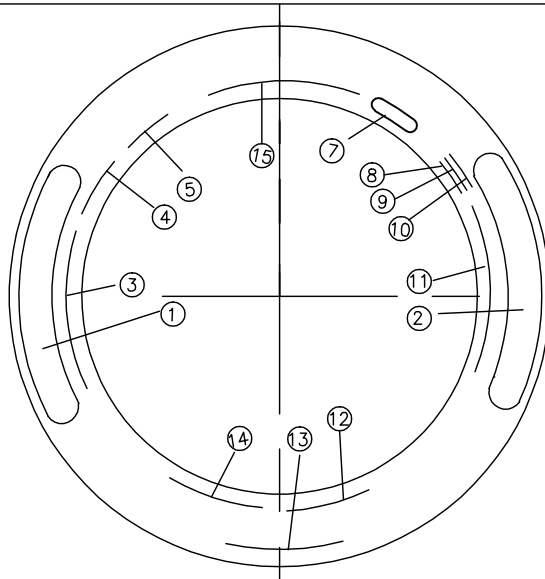
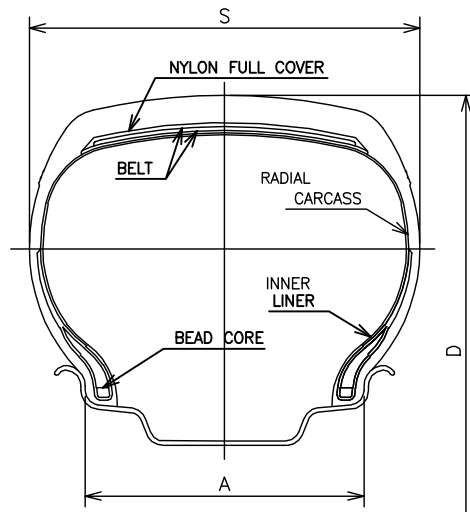

UPPER

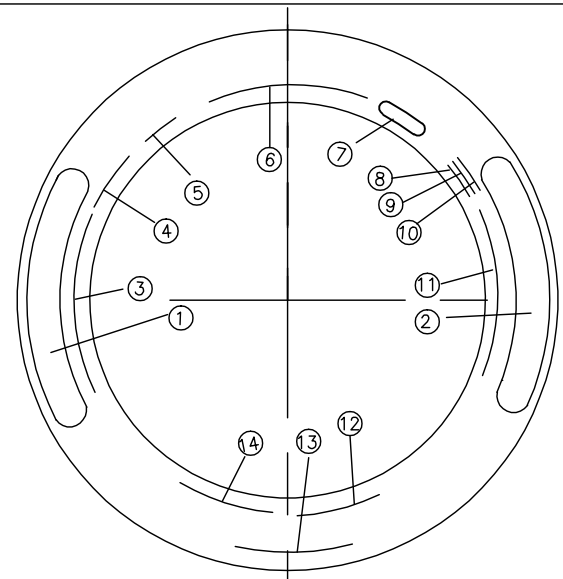

LOWER

TREAD PATTERNS
REFER TO ATTACHMENT 20191210

1	CONSTANCY; I LINK; LUXXAN; RHINO; ARIVO; GRENLANDER; T TYRE; CRYSTAL; ROCKBLADE; FRONWAY; SAILWIN; XBRI; ROADMARCH; KANGS; ZMAX;	9	MOLD No.
2	Tread pattern : please refer to attachment 20191210 in figure 1	10	RIM: 7J
3	245/70R16 111H	11	SAFETY WARNING
4	RADIAL TUBELESS	12	PLIES:TREAD 2POLYESTER 2STEEL 2 or 1NYLON SIDEWALL 2POLYESTER
5	M+S	13	TREADWEAR 460 TRACTION A TEMPERATURE A
6	DOT 17B MMEKPAXXXX (DATE CODE)	14	EXTRA LOAD MAX. LOAD 1090kg (2403 LBS) AT 340 kPa (50 PSI) COLD
7	ECE APPROVAL MARK	15	DOT 17B MMEKPA
8	MADE IN CHINA	16	

TIRE SIZE	D(mm)	S(mm)	A(mm)	LOAD INDEX SPEED CODE	REMARK
245/70R16	750	248	178	111H	EXTRA LOAD

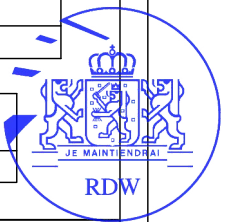

SCALE : FREE	DATE : 2019.12.11	DESIGNED BY	CHECKED BY	APPROVED BY	DRAWING NO.
ZODO TIRE CO.,LIMITED	Xu Huili	Xie Baoshan	Shen Maoqiao	TITLE	245/70R16 111H

iDiADA CN20010254

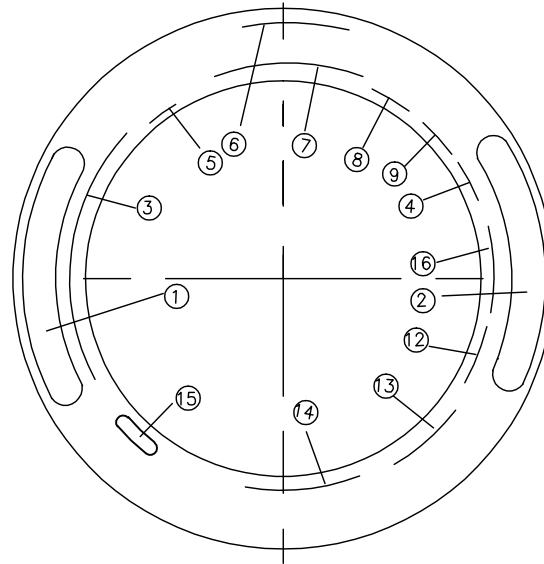
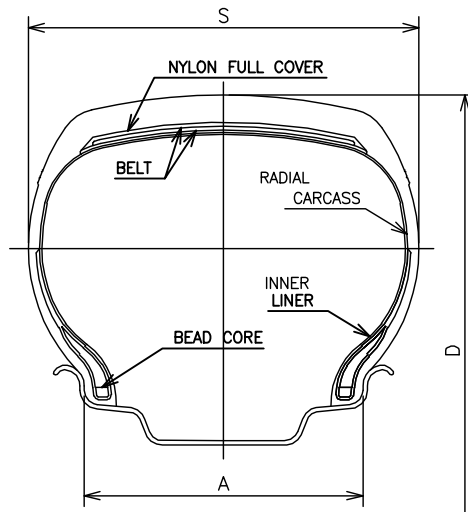

UPPER

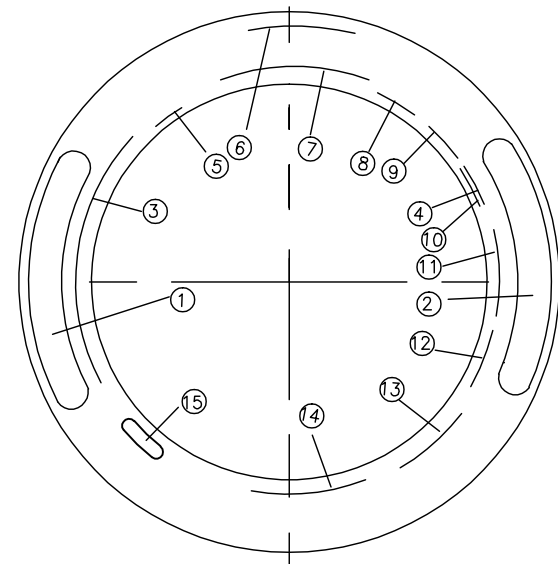

LOWER

TREAD PATTERNS
REFER TO ATTACHMENT 20191210

1	CONSTANCY; ILINK; LUXXAN; RHINO; ARIVO; GRENLANDER; T TYRE; CRYSTAL; ROCKBLADE; FRONWAY; SAILWIN; XBRI; ROADMARCH; KANGS; ZMAX;	9	TUBELESS
2	Tread pattern : please refer to attachment 20191210 in figure 2	10	MADE IN CHINA
3	SAFETY WARNING	11	DOT 17B MMECPA XXXX (DATE CODE)
4	MOLD No.	12	STEEL BELTED RADIAL
5	RIM: NOM. WIDTH 7J	13	PLIES:TREAD 2POLYESTER 2STEEL 1NYLON SIDEWALL 2POLYESTER
6	TREADWEAR 460 TRACTION A TEMPERATURE A	14	EXTRA LOAD MAX. LOAD 1090kg (2403 LBS) MAX. PRESSURE 340 kPa(50 PSI)
7	245/70R16 111H	15	ECE APPROVAL MARK
8	M+S	16	DOT 17B MMECPA

TIRE SIZE	D(mm)	S(mm)	A(mm)	LOAD INDEX SPEED CODE	REMARK
245/70R16	750	248	178	111H	EXTRA LOAD

SCALE : FREE	DATE : 2019.12.11	DESIGNED BY	CHECKED BY	APPROVED BY	DRAWING NO.	
ZODO TIRE CO.,LIMITED		Xu Huili	Xie Baoshan	Shen Maoqiao	TITLE	245/70R16 111H

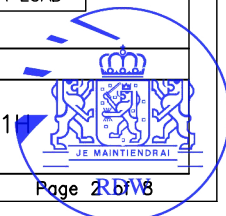

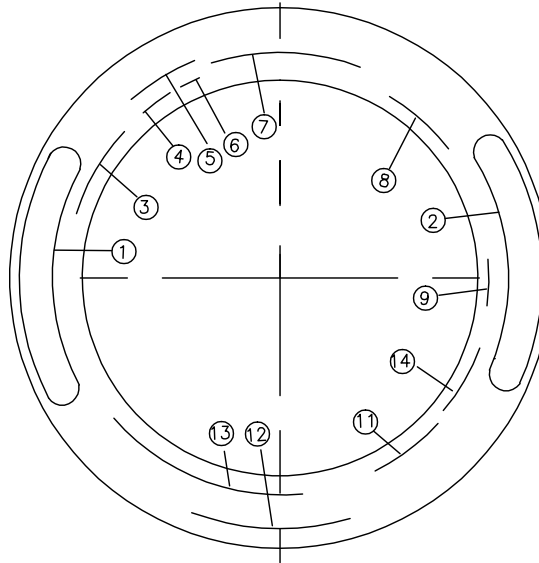
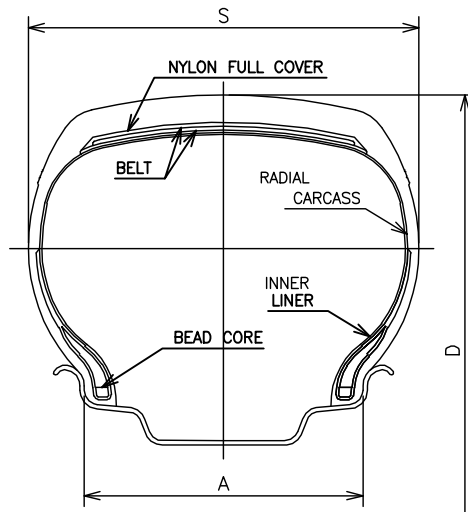

UPPER

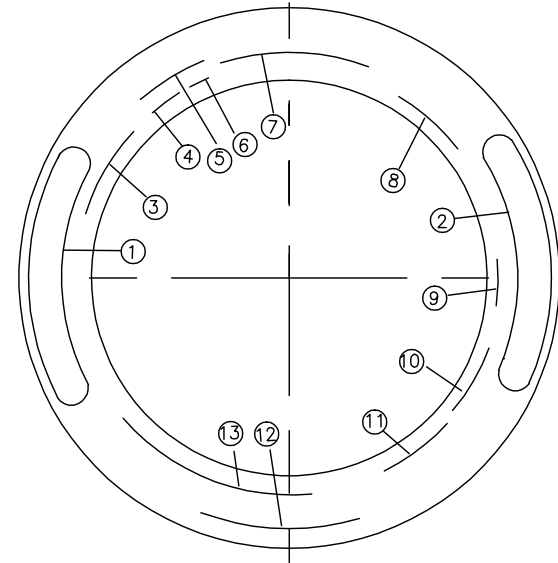

LOWER

TREAD PATTERNS
REFER TO ATTACHMENT 20191210

1	CONSTANCY; ILINK; LUXXAN; RHINO; ARIVO; GRENLANDER; T TYRE; CRYSTAL; ROCKBLADE; FRONWAY; SAILWIN; XBRI; ROADMARCH; KANGS; ZMAX;	8	MAX. LOAD 1090kg (2403 LBS) MAX. PRESSURE 340 kPa(50 PSI) EXTRA LOAD
2	Tread pattern : please refer to attachment 20191210 in figure 3 and figure 6 and figure 7	9	MADE IN CHINA
3	PLIES:TREAD 2POLYESTER+2STEEL+1NYLON SIDEWALL 2POLYESTER	10	DOT 17B XXXXXX XXXX (DATE CODE)
4	RIM:7J	11	ECE APPROVAL MARK
5	RADIAL TUBELESS	12	TREADWEAR XXX TRACTION X TEMPERATURE X
6	MOLD No.	13	SAFETY WARNING
7	245/70R16 111HXL M+S	14	DOT 17B XXXXXX

TIRE SIZE	D(mm)	S(mm)	A(mm)	LOAD INDEX SPEED CODE	REMARK
245/70R16	750	248	178	111H	EXTRA LOAD

SCALE : FREE	DATE : 2019.12.11	DESIGNED BY	CHECKED BY	APPROVED BY	DRAWING NO.	
ZODO TIRE CO.,LIMITED		Xu Huili	Xie Baoshan	Shen Maoqiao	TITLE	245/70R16 111H

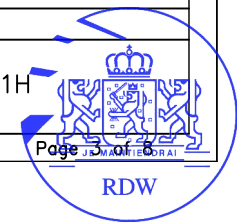

iDiADA CN20010254

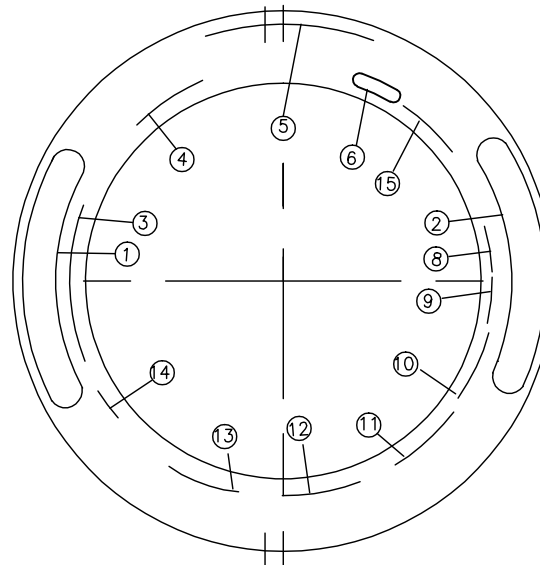
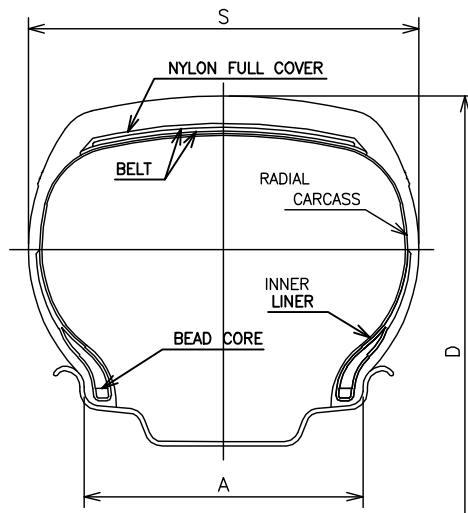

UPPER

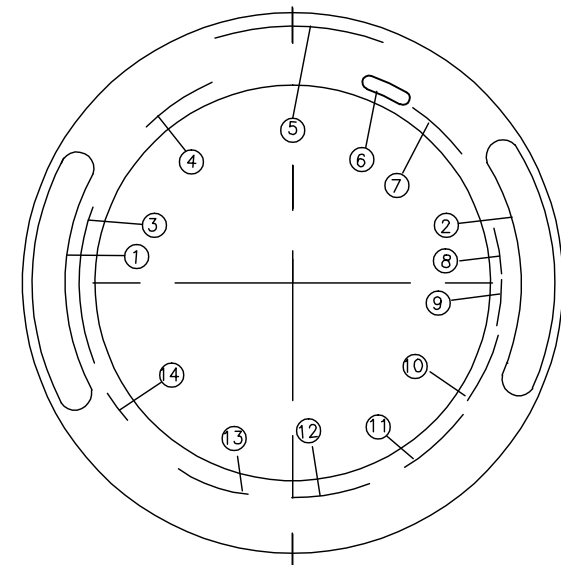

LOWER

TREAD PATTERNS
REFER TO ATTACHMENT 20191210

1	CONSTANCY; ILINK; LUXXAN; RHINO; ARIVO; GRENLANDER; T TYRE; CRYSTAL; ROCKBLADE; FRONWAY; SAILWIN; XBRI; ROADMARCH; KANGS; ZMAX;	9	MOLD No.
2	Tread pattern : please refer to attachment 20191210 in figure 4	10	STEEL BELTED TUBELESS RADIAL
3	245/70R16 111HEXTRA LOAD	11	MADE IN CHINA
4	SAFETY WARNING	12	PLIES:SIDEWALL 2POLYESTER TREAD: 2POLYESTER+2STEEL+1NYLON
5	TREADWEAR 420 TRACTION A TEMPERATURE A	13	MAX. LOAD 1090kg (2403 LBS) MAX. PRESSURE 340 kPa(50 PSI)
6	ECE APPROVAL MARK	14	M+S
7	DOT 7BDK BF5 XXXX (DATE CODE)	15	DOT 7BDK BF5
8	STANDARD RIM 7J		

TIRE SIZE	D(mm)	S(mm)	A(mm)	LOAD INDEX SPEED CODE	REMARK
245/70R16	750	248	178	111H	EXTRA LOAD

SCALE : FREE	DATE : 2019.12.11	DESIGNED BY	CHECKED BY	APPROVED BY	DRAWING NO.
ZODO TIRE CO.,LIMITED		Xu Huili	Xie Baoshan	Shen Maoqiao	TITLE
					245/70R16 111H

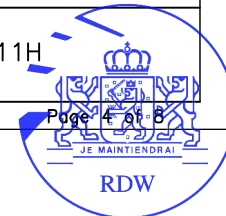

iDiADA CN20010254

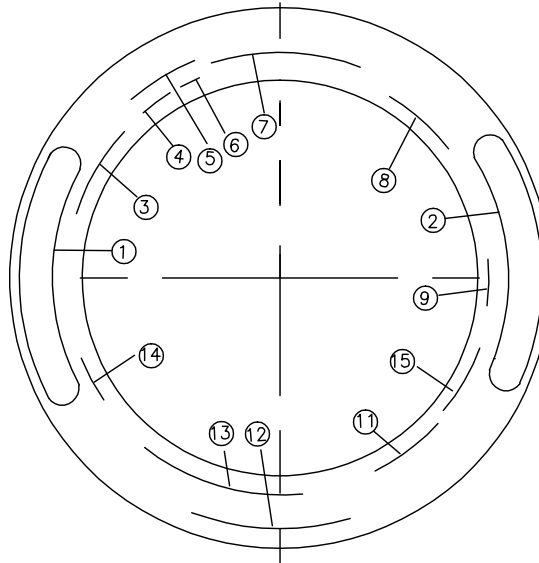
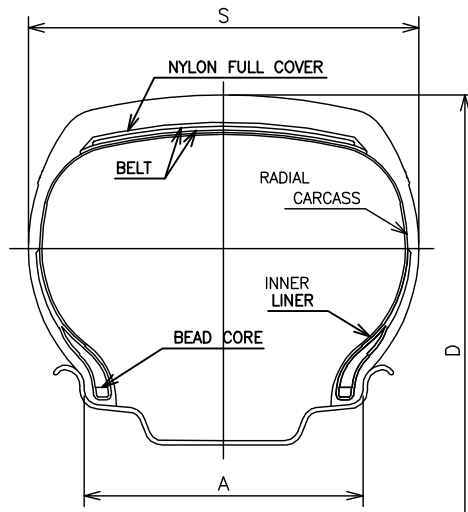

UPPER

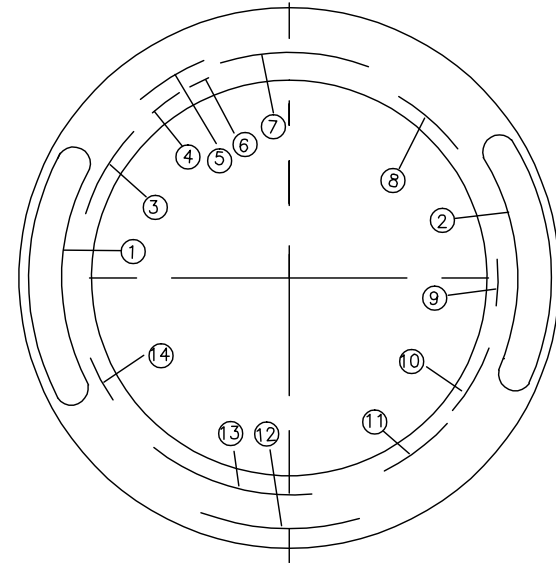

LOWER

TREAD PATTERNS
REFER TO ATTACHMENT 20191210

1	CONSTANCY; ILINK; LUXXAN; RHINO; ARIVO; GRENLANDER; T TYRE; CRYSTAL; ROCKBLADE; FRONWAY; SAILWIN; XBRI; ROADMARCH; KANGS; ZMAX;	8	MAX. LOAD 1090kg (2403 LBS) MAX. PRESSURE 340 kPa(50 PSI) EXTRA LOAD
2	Tread pattern : please refer to attachment 20191210 in figure 5 and figure 10	9	MADE IN CHINA
3	PLIES:TREAD 2POLYESTER+2STEEL+1NYLON SIDEWALL 2POLYESTER	10	DOT 17B XXXXXX XXXX (DATE CODE)
4	RIM:7J	11	ECE APPROVAL MARK
5	RADIAL TUBELESS	12	ROTATION
6	MOLD No.	13	SAFETY WARNING
7	245/70R16 111H XL M+S	14	
		15	DOT 17B XXXXXX

TIRE SIZE	D(mm)	S(mm)	A(mm)	LOAD INDEX SPEED CODE	REMARK
245/70R16	750	248	178	111H	EXTRA LOAD

SCALE : FREE	DATE : 2019.12.11	DESIGNED BY	CHECKED BY	APPROVED BY	DRAWING NO.	
ZODO TIRE CO.,LIMITED		Xu Huili	Xie Baoshan	Shen Maoqiao	TITLE	245/70R16 111H

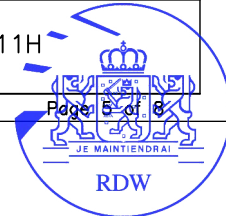

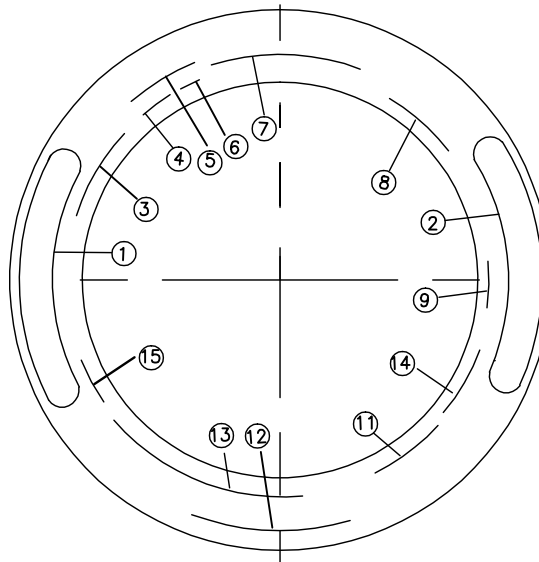
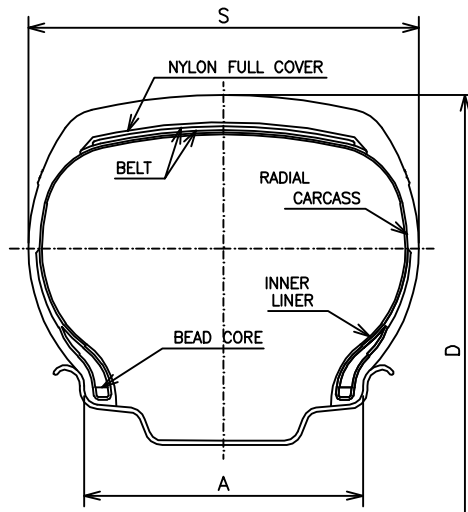

UPPER

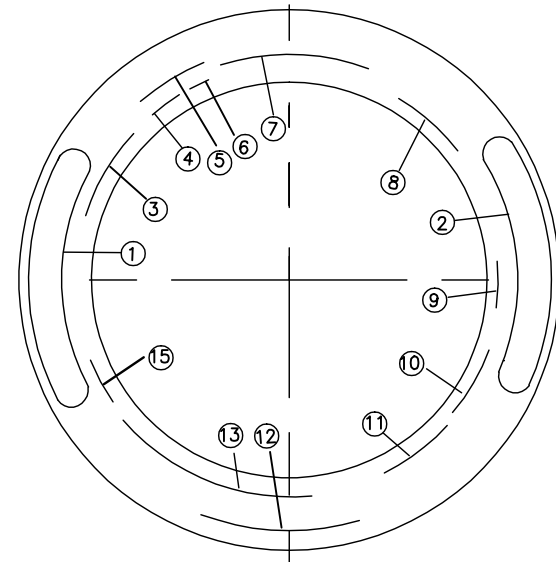

LOWER

TREAD PATTERNS
REFER TO ATTACHMENT 20191210

1	CONSTANCY; ILINK; LUXKAN; RHINO; ARIVO; GRENLANDER; T TYRE; CRYSTAL; ROCKBLADE; FRONWAY; SAILWIN; XBRI; ROADMARCH; KANGS; ZMAX;	8	MAX. LOAD 1090kg (2403 LBS) MAX. PRESSURE 340 kPa(50 PSI) EXTRA LOAD
2	Tread pattern : please refer to attachment 20191210 in figure 8	9	MADE IN CHINA
3	PLIES:TREAD 2POLYESTER+2STEEL+1NYLON SIDEWALL 2POLYESTER	10	DOT 17B XXXXXXXXXX (DATE CODE)
4	RIM: 7J	11	ECE APPROVAL MARK
5	RADIAL TUBELESS	12	OUTSIDE(LOWER)/INSIDE(UPPER)
6	MOLD No.	13	SAFETY WARNING
7	245/70R16 111H XL M+S	14	DOT 17B XXXXXX
		15	

TIRE SIZE	D(mm)	S(mm)	A(mm)	LOAD INDEX SPEED CODE	REMARK
245/70R16	750	248	178	111H	EXTRA LOAD

SCALE : FREE	DATE : 2019.12.11	DESIGNED BY	CHECKED BY	APPROVED BY	DRAWING NO.	
ZODO TIRE CO.,LIMITED		Xu Huili	Xie Baoshan	Shen Maoqiao	TITLE	245/70R16 111H

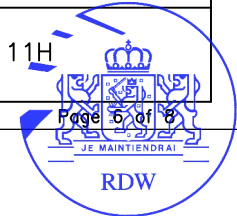

iDiADA CN20010254

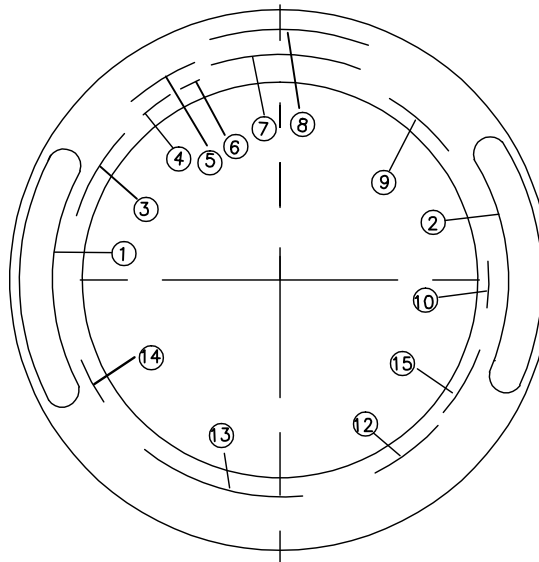
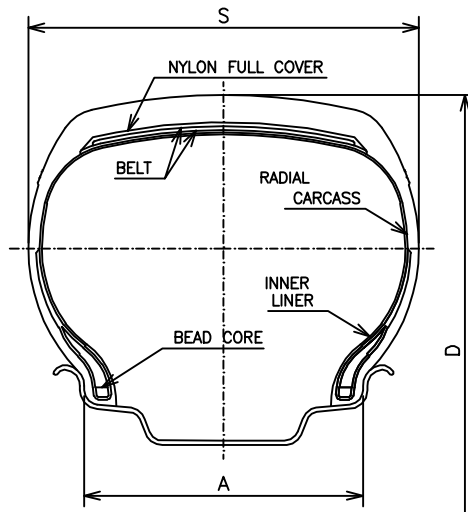

UPPER

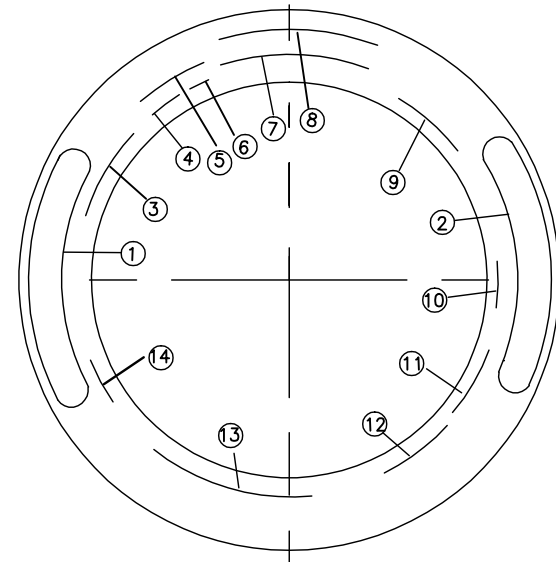

LOWER

TREAD PATTERNS
REFER TO ATTACHMENT 20191210

1	CONSTANCY; ILINK; LUXXAN; RHINO; ARIVO; GRENLANDER; T TYRE; CRYSTAL; ROCKBLADE; FRONWAY; SAILWIN; XBRI; ROADMARCH; KANGS; ZMAX;	8	ROTATION
2	Tread pattern : please refer to attachment 20191210 in figure 9	9	MAX. LOAD 1090kg (2403 LBS) MAX. PRESSURE 340 kPa(50 PSI) EXTRA LOAD
3	PLIES:TREAD 2POLYESTER+2STEEL+1NYLON SIDEWALL 2POLYESTER	10	MADE IN CHINA
4	RIM: 7J	11	DOT 17B XXXXXX XXXX (DATE CODE)
5	RADIAL TUBELESS	12	ECE APPROVAL MARK
6	MOLD No.	13	SAFETY WARNING
7	245/70R16 111H XL M+S	14	ALL SEASONS
		15	DOT 17B XXXXXX

TIRE SIZE	D(mm)	S(mm)	A(mm)	LOAD INDEX SPEED CODE	REMARK
245/70R16	750	248	178	111H	EXTRA LOAD

SCALE : FREE	DATE : 2019.12.11	DESIGNED BY	CHECKED BY	APPROVED BY	DRAWING NO.	
ZODO TIRE CO.,LIMITED		Xu Huili	Xie Baoshan	Shen Maoqiao	TITLE	245/70R16 111H

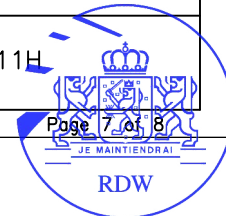

iDiADA CN20010254

TIRE SIZE 245/70R16 111H

ATTACHMENT 20191210

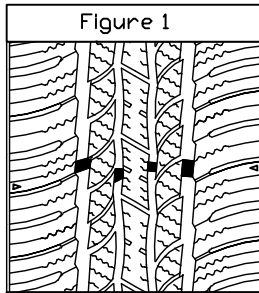

Figure 1

MAHO 77;POWERCITY 77;
 TOPOWER 87 H/T;ROADPOWER H/T;
 ROADKING H/T;TERRANO ARV H/T;
 FORZA H/T 2;INSPIRER F4;
 ROCK 717 H/T;TWENTY TWO;
 Maxirm;PRIMEMARCH H/T 77;

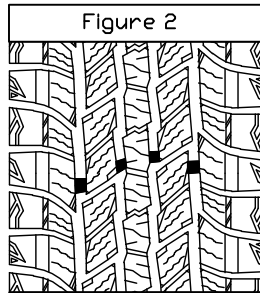

Figure 2

MAGA A/T ONE;FORZA A/T;
 TERRAMAX LSR1 A/T;
 TERRA XPLOER C1 A/T;
 GLADIATAX A/T I;
 ROCKBLADE A/T I;
 TERRAMAX ARV A/T;
 INSPIRER A/T I;
 TOUGH TRAC A/T I;
 ROCK 727 A/T;
 PRIMEMAX A/T I

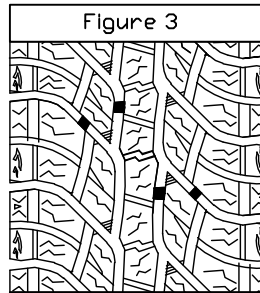

Figure 3

MAGA A/T TWO;
 FORZA A/T 2;
 TERRAMAX LSR2 A/T;
 TERRA XPLOER C2 A/T;
 GLADIATAX A/T II;
 ROCKBLADE A/T II;
 TERRAMAX ARV PRO A/T;
 INSPIRER A/T II;
 TOUGH TRAC A/T II;
 ROCK 737 A/T;
 PRIMEMAX A/T II;CAPACITY.

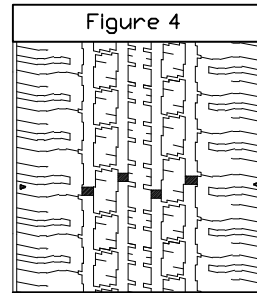

Figure 4

LY788;L-FINDER78;
 FORZA H/T ;GP1000;
 HIGHROAD H/T 78;
 SPEEDROAD H/T 78;
 INSPIRER F2;Rapld;
 ROCK 788

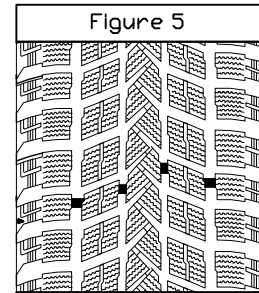

Figure 5

LY969;L-SNOW99;
 WINTERCROSS ARW7;
 INSPIRER W6;
 ICEPOWER 99;
 ICEWINNER 99;ROCK 919S

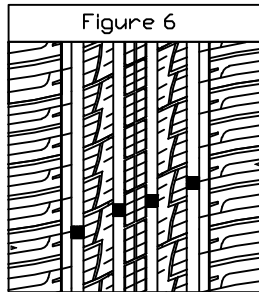

Figure 6

MAHO 79;POWERCITY 79;
 ROADPOWER H/T 79;
 SAILKING H/T 79;
 TRAVERSO ARV H/T;
 INSPIRER F6;
 ROCK 719 H/T;
 PRIMEMARCH H/T 79;
 GALLOPRO H/T;

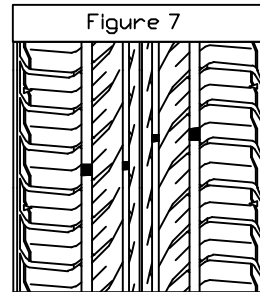

Figure 7

COLO H01;L-GRIP66;LY168;
 ECOGREEN 66;VENUSATR 66;
 Energize;PREMIO ARZ1;ECOLOGY;
 INSPIRER C4;THREE;ROCK 515;
 PRIMESTAR 66;

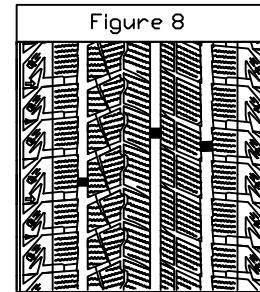

Figure 8

Winter GL868;Winter IL868;
 LY868;ICEPOWER 868;
 ICEWINNER 868;WINMASTER ARW2;
 ROCK 868;THIRTY TWO;
 SNOWROVER 868;COMMANDER WZ

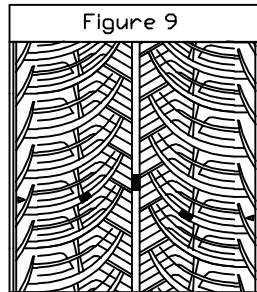

Figure 9

GREENWING A/S;
 MULTIMATCH A/S;
 FRONWING A/S;FREIMATCH A/S;
 Carlorful A/S;PRIME A/S;
 ROCK A/S ONE;FORTY ONE;
 INSPIRER A/S 1;

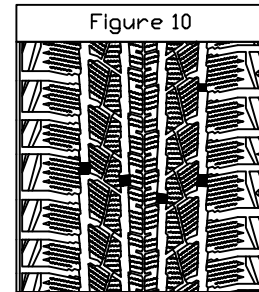
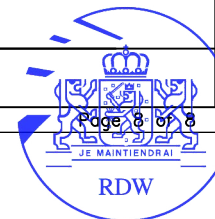

Figure 10

Winter GL888;Winter IL888;
 LY888;
 ICEPOWER 888;
 ICEWINNER 888;
 WINTERCROSS ARWB;ROCK 888S;

6 TREAD WEAR INDICATORS EQUALLY SPACED

DRAWN BY	Xu Huili	CHECKED BY	Xie Baoshan	APPROVED BY	Shen Maoqiao	ZODO TIRE CO.,LIMITED
----------	----------	------------	-------------	-------------	--------------	-----------------------



iDiADA CN20010254

REPORT No. CN20010254

REGARDING PNEUMATIC TYRES FOR MOTOR VEHICLES AND THEIR TRAILERS ACCORDING TO
REGULATION 30

Approval number : E4*30R02/20*109488*04

Manufacturer : ZODO TIRE Co., LIMITED
The South of Yalujiang Road, Wenzhuang Village Qinghe
Agency of Cao County Heze City, Shandong Province 274400
China(PRC)Brand-name(s)/trademark(s) : GRENLANDER; ARIVO; CONSTANCY; ILINK; LUXXAN;
RHINO; CRYSTAL; T TYRE; ROCKBLADE; FRONWAY;
SAILWIN; XBRI; ROADMARCH; KANGS; ZMAXTrade description(s)/Commercial name(s) : MAHO 77; POWERCITY 77; TOPOWER 87 H/T;
ROADPOWER H/T; ROADKING H/T; TERRANO ARV H/T; FORZA H/T 2; INSPIRER F4; ROCK 717 H/T;
TWENTY TWO; Maxim; PRIMEMARCH H/T 77; MAGA A/T ONE; FORZA A/T; TERRAMAX LSR1 A/T;
TERRA XPLOER C1 A/T; GLADIATAX A/T I; ROCKBLADE A/T I; TERRAMAX ARV A/T;
INSPIRER A/T I; TOUGH TRAC A/T I; ROCK 727 A/T; PRIMEMAX A/T I; COLO H01; L-GRIP66;
LY168; ECOGREEN 66; VENUSATR 66; Energize; PREMIO ARZ1; ECOLOGY; INSPIRER C4; THREE;
ROCK 515; PRIMESTAR 66; GREENWING A/S; MULTIMATCH A/S; FRONWING A/S; FREIMATCH A/S;
Carlorful A/S; PRIME A/S; ROCK A/S ONE; FORTY ONE; INSPIRER A/S 1; MAGA A/T TWO;
FORZA A/T 2; TERRAMAX LSR2 A/T; TERRA XPLOER C2 A/T; GLADIATAX A/T II;
ROCKBLADE A/T II; TERRAMAX ARV PRO A/T; INSPIRER A/T II; TOUGH TRAC A/T II;
ROCK 737 A/T; PRIMEMAX A/T II; Winter GL868; Winter IL868; LY868; ICEPOWER 868;
ICEWINNER 868; WINMASTER ARW2; ROCK 868S; THIRTY TWO; SNOWROVER 868; LY788;
L-FINDER78; FORZA H/T; GP1000; HIGHROAD H/T 78; SPEEDROAD H/T 78; INSPIRER F2; Rapid;
ROCK 788; LY969; L-SNOW99; WINTERCROSS ARW7; INSPIRER W8; ICEPOWER 99; ICEWINNER 99;
ROCK 919S; COMMANDER W7; CAPACITY; MAHO 79; POWERCITY 79; ROADPOWER H/T 79;
SAILKING H/T 79; TRAVERSO ARV H/T; INSPIRER F6; ROCK 719 H/T; PRIMEMARCH H/T 79;
GALLOPRO H/T; Winter GL888; Winter IL888; LY888; ICEPOWER 888; ICEWINNER 888;
WINTERCROSS ARW8; ROCK 888S

Tyre size designation : 245/70R16

Place and date of test report issue : L'Albornar, Santa Oliva (Tarragona)
14/01/2020

CONCLUSIONS: Modification introduced to the tyre, as detailed in the annex to this report, grant grounds for approval extension with respect to formerly certified tyre-type, and FULFILS the specifications relating to the approval of pneumatic tyres for motor vehicles and their trailers according to Regulation 30.

Performed by:

Zhaocai (Frank) Yu
TEST ENGINEER

Revised by:

Lluís Sans Gomis
DEPARTMENT MANAGER

ANNEX TO THE REPORT

Reason(s) for extension:

- Addition of brand name: KANGS; ZMAX
- Addition of trade description: COMMANDER W7; CAPACITY; MAHO 79; POWERCITY 79; ROADPOWER H/T 79; SAILKING H/T 79; TRAVERSO ARV H/T; INSPIRER F6; ROCK 719 H/T; PRIMEMARCH H/T 79; GALLOPRO H/T; Winter GL888; Winter IL888; LY888; ICEPOWER 888; ICEWINNER 888; WINTERCROSS ARW8; ROCK 888S
- Modification of manufacturer's name
- The technical service is changed from CSI S.p.A.Viale Lombardia 2020021 Bollate (MI) Italy into IDIADA
- The test report No. 0004\ISP\OMLS\19_2 issued on the date of January 11, 2019 by CSI S.p.A.Viale Lombardia 2020021 Bollate (MI) Italy is valid and unnecessary to perform re-testing

Test Place : L'Albornar, Santa Oliva (Tarragona)

Test Date : 14/01/2020



Zhaocai (Frank) Yu
TEST ENGINEER