

HICURA

5 mm Grasping Forceps

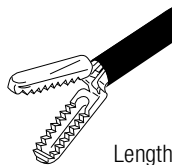

- Atraumatic forceps:
multipurpose grasping forceps for
all aparoscopic applications
- Claw type forceps:
for example, for recovery of gall bladder, myoma, etc.
- Flat forceps:
multipurpose fenestrated grasping forceps
for all laparoscopic applications
- Forceps with big lumen:
atraumatic grasping forceps for delicate
tissue (e.g. bowel, tubes)

Atraumatic Forceps

Length of jaws: 16 mm

Components

WA69336M	Jaws insert "HICURA", 5 x 330, atraumatic, monopolar
WA69336S	Jaws insert "HICURA", 5 x 250, atraumatic, monopolar
WA69336L	Jaws insert "HICURA", 5 x 430, atraumatic, monopolar
WA69300M	Shaft "HICURA", 5 x 330, monopolar
WA69300S	Shaft "HICURA", 5 x 250, monopolar
WA69300L	Shaft "HICURA", 5 x 430, monopolar
WA69000M	Handle "HICURA", size M, deactivatable ratchet
WA69000L	Handle "HICURA", size L, deactivatable ratchet
WA69003M	Handle "HICURA", size M, ratchet
WA69003L	Handle "HICURA", size L, ratchet

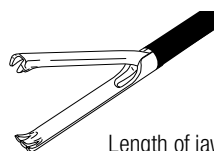
Claw Type Forceps

Length of jaws: 28 mm

Components

WA69344M	Jaws insert "HICURA", 5 x 330, claw type, monopolar
WA69344S	Jaws insert "HICURA", 5 x 250, claw type, monopolar
WA69344L	Jaws insert "HICURA", 5 x 430, claw type, monopolar
WA69300M	Shaft "HICURA", 5 x 330, monopolar
WA69300S	Shaft "HICURA", 5 x 250, monopolar
WA69300L	Shaft "HICURA", 5 x 430, monopolar
WA69000M	Handle "HICURA", size M, deactivatable ratchet
WA69000L	Handle "HICURA", size L, deactivatable ratchet
WA69003M	Handle "HICURA", size M, ratchet
WA69003L	Handle "HICURA", size L, ratchet

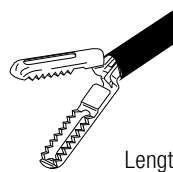
Flat Forceps

Length of jaws: 19 mm

Components

WA69338M	Jaws insert "HICURA", 5 x 330, flat, monopolar
WA69338S	Jaws insert "HICURA", 5 x 250, flat, monopolar
WA69338L	Jaws insert "HICURA", 5 x 430, flat, monopolar
WA69300M	Shaft "HICURA", 5 x 330, monopolar
WA69300S	Shaft "HICURA", 5 x 250, monopolar
WA69300L	Shaft "HICURA", 5 x 430, monopolar
WA69000M	Handle "HICURA", size M, deactivatable ratchet
WA69000L	Handle "HICURA", size L, deactivatable ratchet
WA69003M	Handle "HICURA", size M, ratchet
WA69003L	Handle "HICURA", size L, ratchet

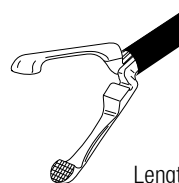
Forceps with Big Lumen

Length of jaws: 21 mm

Components

WA69340M	Jaws insert "HICURA", 5 x 330, with big lumen, monopolar
WA69340S	Jaws insert "HICURA", 5 x 250, with big lumen, monopolar
WA69340L	Jaws insert "HICURA", 5 x 430, with big lumen, monopolar
WA69300M	Shaft "HICURA", 5 x 330, monopolar
WA69300S	Shaft "HICURA", 5 x 250, monopolar
WA69300L	Shaft "HICURA", 5 x 430, monopolar
WA69000M	Handle "HICURA", size M, deactivatable ratchet
WA69000L	Handle "HICURA", size L, deactivatable ratchet
WA69003M	Handle "HICURA", size M, ratchet
WA69003L	Handle "HICURA", size L, ratchet

HICURA

5 mm Grasping Forceps (cont.)

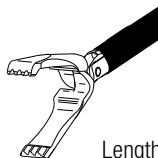

- Manhes forceps:
precise fixation and manipulation of fragile tissue
- Crocodile type forceps:
for strong and tight fixation of tissue
(e.g. stomach, gall bladder)
- Wave type forceps:
dedicated grasping forceps for bowel and fragile tissue
- Johann forceps:
atraumatic fenestrated multipurpose grasping
forceps with large jaws and good visibility

Manhes Forceps

Length of jaws: 18 mm

Components

WA69342M	Jaws insert "HICURA", 5 x 330, Manhes, monopolar
WA69342S	Jaws insert "HICURA", 5 x 250, Manhes, monopolar
WA69342L	Jaws insert "HICURA", 5 x 430, Manhes, monopolar
WA69300M	Shaft "HICURA", 5 x 330, monopolar
WA69300S	Shaft "HICURA", 5 x 250, monopolar
WA69300L	Shaft "HICURA", 5 x 430, monopolar
WA69000M	Handle "HICURA", size M, deactivatable ratchet
WA69000L	Handle "HICURA", size L, deactivatable ratchet
WA69003M	Handle "HICURA", size M, ratchet
WA69003L	Handle "HICURA", size L, ratchet

Wave Type Grasping Forceps

Length of jaws: 30 mm

Components

WA69334M	Jaws insert "HICURA", 5 x 330, wave type, monopolar
WA69334S	Jaws insert "HICURA", 5 x 250, wave type, monopolar
WA69334L	Jaws insert "HICURA", 5 x 430, wave type, monopolar
WA69300M	Shaft "HICURA", 5 x 330, monopolar
WA69300S	Shaft "HICURA", 5 x 250, monopolar
WA69300L	Shaft "HICURA", 5 x 430, monopolar
WA69000M	Handle "HICURA", size M, deactivatable ratchet
WA69000L	Handle "HICURA", size L, deactivatable ratchet
WA69003M	Handle "HICURA", size M, ratchet
WA69003L	Handle "HICURA", size L, ratchet

Crocodile Type Forceps

Length of jaws: 18 mm

Components

WA69346M	Jaws insert "HICURA", 5 x 330, crocodile type, monopolar
WA69346S	Jaws insert "HICURA", 5 x 250, crocodile type, monopolar
WA69346L	Jaws insert "HICURA", 5 x 430, crocodile type, monopolar
WA69300M	Shaft "HICURA", 5 x 330, monopolar
WA69300S	Shaft "HICURA", 5 x 250, monopolar
WA69300L	Shaft "HICURA", 5 x 430, monopolar
WA69000M	Handle "HICURA", size M, deactivatable ratchet
WA69000L	Handle "HICURA", size L, deactivatable ratchet
WA69003M	Handle "HICURA", size M, ratchet
WA69003L	Handle "HICURA", size L, ratchet

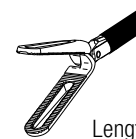
Johann Forceps

Length of jaws: 24 mm

Components

WA69310M	Jaws insert "HICURA", 5 x 330, Johann, monopolar
WA69310S	Jaws insert "HICURA", 5 x 250, Johann, monopolar
WA69310L	Jaws insert "HICURA", 5 x 430, Johann, monopolar
WA69300M	Shaft "HICURA", 5 x 330, monopolar
WA69300S	Shaft "HICURA", 5 x 250, monopolar
WA69300L	Shaft "HICURA", 5 x 430, monopolar
WA69000M	Handle "HICURA", size M, deactivatable ratchet
WA69000L	Handle "HICURA", size L, deactivatable ratchet
WA69001M	Handle "HICURA", size M, monopolar
WA69001L	Handle "HICURA", size L, monopolar
WA69003M	Handle "HICURA", size M, ratchet
WA69003L	Handle "HICURA", size L, ratchet

HICURA

5 mm Grasping Forceps (cont.)



- Babcock forceps:
widest inner lumen of all the 5 mm HICURA hand instruments; “paddle” design for maximum grasping performance without damage to soft tissue (e.g. colon)



- Long Johann forceps:
longest jaws in the 5 mm line of HICURA hand instruments for atraumatic grasping of larger organs (e.g. colon)

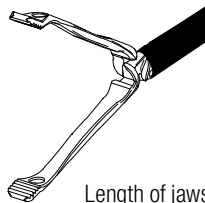

- Johann single-action forceps:
The single-action mechanism offers improved handling in restricted operation areas and enables atraumatic and firm grasping of soft tissue (e.g. colon).

Babcock Forceps

Length of jaws: 31 mm

Components

WA69316M	Jaws insert "HICURA", 5 x 330, Babcock, monopolar
WA69316S	Jaws insert "HICURA", 5 x 250, Babcock, monopolar
WA69316L	Jaws insert "HICURA", 5 x 430, Babcock, monopolar
WA69300M	Shaft "HICURA", 5 x 330, monopolar
WA69300S	Shaft "HICURA", 5 x 250, monopolar
WA69300L	Shaft "HICURA", 5 x 430, monopolar
WA69000M	Handle "HICURA", size M, deactivatable ratchet
WA69000L	Handle "HICURA", size L, deactivatable ratchet
WA69003M	Handle "HICURA", size M, ratchet
WA69003L	Handle "HICURA", size L, ratchet

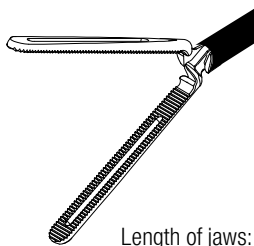
Long Johann Forceps

Length of jaws: 40 mm

Components

WA69314M	Jaws insert "HICURA", 5 x 330, Johann long, monopolar
WA69314S	Jaws insert "HICURA", 5 x 250, Johann long, monopolar
WA69314L	Jaws insert "HICURA", 5 x 430, Johann long, monopolar
WA69300M	Shaft "HICURA", 5 x 330, monopolar
WA69300S	Shaft "HICURA", 5 x 250, monopolar
WA69300L	Shaft "HICURA", 5 x 430, monopolar
WA69000M	Handle "HICURA", size M, deactivatable ratchet
WA69000L	Handle "HICURA", size L, deactivatable ratchet
WA69001M	Handle "HICURA", size M, monopolar
WA69001L	Handle "HICURA", size L, monopolar
WA69003M	Handle "HICURA", size M, ratchet
WA69003L	Handle "HICURA", size L, ratchet

Johann Single-Action Forceps

Length of jaws: 24 mm

Components

WA69312M	Jaws insert "HICURA", 5 x 330, Johann, single action, monopolar
WA69312S	Jaws insert "HICURA", 5 x 250, Johann, single action, monopolar
WA69312L	Jaws insert "HICURA", 5 x 430, Johann, single action, monopolar
WA69300M	Shaft "HICURA", 5 x 330, monopolar
WA69300S	Shaft "HICURA", 5 x 250, monopolar
WA69300L	Shaft "HICURA", 5 x 430, monopolar
WA69000M	Handle "HICURA", size M, deactivatable ratchet
WA69000L	Handle "HICURA", size L, deactivatable ratchet
WA69001M	Handle "HICURA", size M, monopolar
WA69001L	Handle "HICURA", size L, monopolar
WA69003M	Handle "HICURA", size M, ratchet
WA69003L	Handle "HICURA", size L, ratchet

HICURA

5 mm Grasping Forceps (cont.)



- CroceOlmi forceps:
Special jaws design allows grasping and refixation of tissue from the hernia sac, together with bowel manipulation.



- DeBakey forceps:
Fine-toothed jaws design and long jaws allow atraumatic grasping of the bowel and other delicate tissue.



- Forceps with lumen:
Good atraumatic grip due to inner lumen and short length. The lumen creates a tweezer effect. Useful in endometriosis treatment.



- Clinching forceps:
Special jaws design allows atraumatic firm grasping of the gall bladder and other slippery tissue. Mandatory for cholecystectomy.

CroceOlmi Forceps

Length of jaws: 29 mm

Components

WA69320M	Jaws insert "HICURA", 5 x 330, CroceOlmi, monopolar
WA69320S	Jaws insert "HICURA", 5 x 250, CroceOlmi, monopolar
WA69320L	Jaws insert "HICURA", 5 x 430, CroceOlmi, monopolar
WA69300M	Shaft "HICURA", 5 x 330, monopolar
WA69300S	Shaft "HICURA", 5 x 250, monopolar
WA69300L	Shaft "HICURA", 5 x 430, monopolar
WA69000M	Handle "HICURA", size M, deactivatable ratchet
WA69000L	Handle "HICURA", size L, deactivatable ratchet
WA69003M	Handle "HICURA", size M, ratchet
WA69003L	Handle "HICURA", size L, ratchet

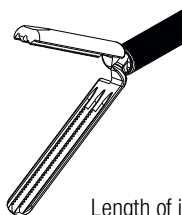
DeBakey Forceps

Length of jaws: 31 mm

Components

WA69318M	Jaws insert "HICURA", 5 x 330, DeBakey, monopolar
WA69318S	Jaws insert "HICURA", 5 x 250, DeBakey, monopolar
WA69318L	Jaws insert "HICURA", 5 x 430, DeBakey, monopolar
WA69300M	Shaft "HICURA", 5 x 330, monopolar
WA69300S	Shaft "HICURA", 5 x 250, monopolar
WA69300L	Shaft "HICURA", 5 x 430, monopolar
WA69000M	Handle "HICURA", size M, deactivatable ratchet
WA69000L	Handle "HICURA", size L, deactivatable ratchet
WA69003M	Handle "HICURA", size M, ratchet
WA69003L	Handle "HICURA", size L, ratchet

Forceps with Lumen

Length of jaws: 16 mm

Components

WA69330M	Jaws insert "HICURA", 5 x 330, with lumen, monopolar
WA69330S	Jaws insert "HICURA", 5 x 250, with lumen, monopolar
WA69330L	Jaws insert "HICURA", 5 x 430, with lumen, monopolar
WA69300M	Shaft "HICURA", 5 x 330, monopolar
WA69300S	Shaft "HICURA", 5 x 250, monopolar
WA69300L	Shaft "HICURA", 5 x 430, monopolar
WA69000M	Handle "HICURA", size M, deactivatable ratchet
WA69000L	Handle "HICURA", size L, deactivatable ratchet
WA69003M	Handle "HICURA", size M, ratchet
WA69003L	Handle "HICURA", size L, ratchet

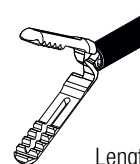
Clinching Forceps

Length of jaws: 26 mm

Components

WA69332M	Jaws insert "HICURA", 5 x 330, Clinching, monopolar
WA69332S	Jaws insert "HICURA", 5 x 250, Clinching, monopolar
WA69332L	Jaws insert "HICURA", 5 x 430, Clinching, monopolar
WA69300M	Shaft "HICURA", 5 x 330, monopolar
WA69300S	Shaft "HICURA", 5 x 250, monopolar
WA69300L	Shaft "HICURA", 5 x 430, monopolar
WA69000M	Handle "HICURA", size M, deactivatable ratchet
WA69000L	Handle "HICURA", size L, deactivatable ratchet
WA69003M	Handle "HICURA", size M, ratchet
WA69003L	Handle "HICURA", size L, ratchet

HICURA

5 mm Grasping Forceps (cont.)

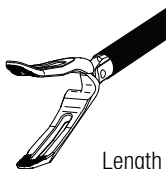

- Precision forceps:
grasping forceps for very precise grasping performance
- Long Precision forceps:
Longer branch lengths improve overview and handling.
- Flat forceps for thoracic surgery:
for atraumatic manipulation of tissue
- Forceps for thoracic surgery:
for atraumatic manipulation of tissue

Precision Forceps

Length of jaws: 24 mm

Components

WA69322M	Jaws insert "HICURA", 5 x 330, Precision, monopolar
WA69300M	Shaft "HICURA", 5 x 330, monopolar
WA69000M	Handle "HICURA", size M, deactivatable ratchet
WA69000L	Handle "HICURA", size L, deactivatable ratchet
WA69001M	Handle "HICURA", size M, monopolar
WA69001L	Handle "HICURA", size L, monopolar
WA69003M	Handle "HICURA", size M, ratchet
WA69003L	Handle "HICURA", size L, ratchet

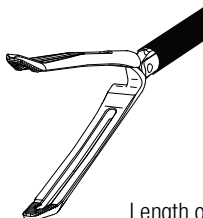
Long Precision Forceps

Length of jaws: 36 mm

Components

WA69324M	Jaws insert "HICURA", 5 x 330, long Precision, monopolar
WA69300M	Shaft "HICURA", 5 x 330, monopolar
WA69000M	Handle "HICURA", size M, deactivatable ratchet
WA69000L	Handle "HICURA", size L, deactivatable ratchet
WA69001M	Handle "HICURA", size M, monopolar
WA69001L	Handle "HICURA", size L, monopolar
WA69003M	Handle "HICURA", size M, ratchet
WA69003L	Handle "HICURA", size L, ratchet

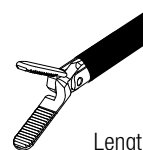
Flat Forceps for Thoracic Surgery

Length of jaws: 14 mm

Components

WA69326S	Jaws insert "HICURA", 5 x 250, flat, for thoracic surgery, monopolar
WA69300S	Shaft "HICURA", 5 x 250, monopolar
WA69000M	Handle "HICURA", size M, deactivatable ratchet
WA69000L	Handle "HICURA", size L, deactivatable ratchet
WA69001M	Handle "HICURA", size M, monopolar
WA69001L	Handle "HICURA", size L, monopolar
WA69003M	Handle "HICURA", size M, ratchet
WA69003L	Handle "HICURA", size L, ratchet

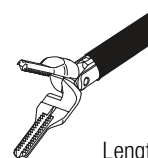
Forceps for Thoracic Surgery

Length of jaws: 16 mm

Components

WA69328S	Jaws insert "HICURA", 5 x 250, for thoracic surgery, monopolar
WA69300S	Shaft "HICURA", 5 x 250, monopolar
WA69000M	Handle "HICURA", size M, deactivatable ratchet
WA69000L	Handle "HICURA", size L, deactivatable ratchet
WA69001M	Handle "HICURA", size M, monopolar
WA69001L	Handle "HICURA", size L, monopolar
WA69003M	Handle "HICURA", size M, ratchet
WA69003L	Handle "HICURA", size L, ratchet

HICURA

5 mm Dissection Forceps

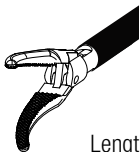

- Maryland forceps:
multipurpose curved dissection forceps
with cross-cut surface for strong grasping
and all laparoscopic applications
- Maryland long forceps:
Longer branch length improves overview and handling.
- Precision forceps:
for very precise dissection

Maryland Forceps

Length of jaws: 17 mm

Components

WA69350M	Jaws insert "HICURA", 5 x 330, Maryland, monopolar
WA69350S	Jaws insert "HICURA", 5 x 250, Maryland, monopolar
WA69350L	Jaws insert "HICURA", 5 x 430, Maryland, monopolar
WA69300M	Shaft "HICURA", 5 x 330, monopolar
WA69300S	Shaft "HICURA", 5 x 250, monopolar
WA69300L	Shaft "HICURA", 5 x 430, monopolar
WA69001M	Handle "HICURA", size M, monopolar
WA69001L	Handle "HICURA", size L, monopolar

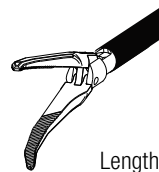
Precision Forceps

Length of jaws: 25 mm

Components

WA69354M	Jaws insert "HICURA", 5 x 330, Precision, monopolar
WA69300M	Shaft "HICURA", 5 x 330, monopolar
WA69001M	Handle "HICURA", size M, monopolar
WA69001L	Handle "HICURA", size L, monopolar

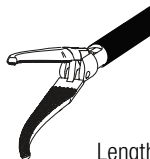
Maryland Long Forceps

Length of jaws: 21 mm

Components

WA69352M	Jaws insert "HICURA", 5 x 330, Maryland long, monopolar
WA69352S	Jaws insert "HICURA", 5 x 250, Maryland long, monopolar
WA69352L	Jaws insert "HICURA", 5 x 430, Maryland long, monopolar
WA69300M	Shaft "HICURA", 5 x 330, monopolar
WA69300S	Shaft "HICURA", 5 x 250, monopolar
WA69300L	Shaft "HICURA", 5 x 430, monopolar
WA69001M	Handle "HICURA", size M, monopolar
WA69001L	Handle "HICURA", size L, monopolar

HICURA

5 mm Dissection Forceps (cont.)



- Maryland straight forceps:
for delicate dissection and needle holder assistance

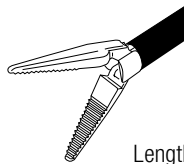

- Maryland 90° angled forceps:
for blood vessel dissection

Maryland Straight Forceps

Length of jaws: 15 mm

Components

WA69356M	Jaws insert "HICURA", 5 x 330, Maryland straight, monopolar
WA69356S	Jaws insert "HICURA", 5 x 250, Maryland straight, monopolar
WA69356L	Jaws insert "HICURA", 5 x 430, Maryland straight, monopolar
WA69300M	Shaft "HICURA", 5 x 330, monopolar
WA69300S	Shaft "HICURA", 5 x 250, monopolar
WA69300L	Shaft "HICURA", 5 x 430, monopolar
WA69001M	Handle "HICURA", size M, monopolar
WA69001L	Handle "HICURA", size L, monopolar

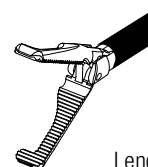
Maryland 90° Angled Forceps

Length of jaws: 18 mm

Components

WA69358M	Jaws insert "HICURA", 5 x 330, Maryland 90° angled, monopolar
WA69358S	Jaws insert "HICURA", 5 x 250, Maryland 90° angled, monopolar
WA69358L	Jaws insert "HICURA", 5 x 430, Maryland 90° angled, monopolar
WA69300M	Shaft "HICURA", 5 x 330, monopolar
WA69300S	Shaft "HICURA", 5 x 250, monopolar
WA69300L	Shaft "HICURA", 5 x 430, monopolar
WA69001M	Handle "HICURA", size M, monopolar
WA69001L	Handle "HICURA", size L, monopolar

HICURA

5 mm Biopsy Forceps



- Biopsy forceps with spikes

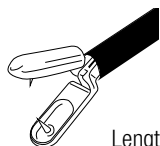

- Severing biopsy forceps

Biopsy Forceps with Spikes

Length of jaws: 14 mm

Components

WA69390M	Jaws insert "HICURA", 5 x 330, with spike, monopolar
WA69390L	Jaws insert "HICURA", 5 x 430, with spike, monopolar
WA69300M	Shaft "HICURA", 5 x 330, monopolar
WA69300L	Shaft "HICURA", 5 x 430, monopolar
WA69000M	Handle "HICURA", size M, deactivatable ratchet
WA69000L	Handle "HICURA", size L, deactivatable ratchet
WA69001M	Handle "HICURA", size M, monopolar
WA69001L	Handle "HICURA", size L, monopolar
WA69003M	Handle "HICURA", size M, ratchet
WA69003L	Handle "HICURA", size L, ratchet

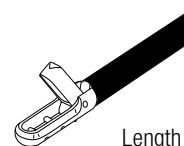
Severing Biopsy Forceps

Length of jaws: 12 mm

Components

WA69392M	Jaws insert "HICURA", 5 x 330, severing, monopolar
WA69392L	Jaws insert "HICURA", 5 x 430, severing, monopolar
WA69300M	Shaft "HICURA", 5 x 330, monopolar
WA69300L	Shaft "HICURA", 5 x 430, monopolar
WA69000M	Handle "HICURA", size M, deactivatable ratchet
WA69000L	Handle "HICURA", size L, deactivatable ratchet
WA69001M	Handle "HICURA", size M, monopolar
WA69001L	Handle "HICURA", size L, monopolar
WA69003M	Handle "HICURA", size M, ratchet
WA69003L	Handle "HICURA", size L, ratchet

HICURA

5 mm Monopolar Scissors



- Metzenbaum scissors:
multipurpose scissors for all
laparoscopic applications



- Mini-Metzenbaum scissors:
for precise cutting and preparation



- Hook scissors:
for cutting of sutures

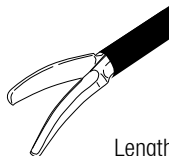

- Straight scissors

Metzenbaum Scissors

Length of jaws: 19 mm

Components

WA69370M	Jaws insert "HICURA", 5 x 330, Metzenbaum, monopolar
WA69370S	Jaws insert "HICURA", 5 x 250, Metzenbaum, monopolar
WA69370L	Jaws insert "HICURA", 5 x 430, Metzenbaum, monopolar
WA69300M	Shaft "HICURA", 5 x 330, monopolar
WA69300S	Shaft "HICURA", 5 x 250, monopolar
WA69300L	Shaft "HICURA", 5 x 430, monopolar
WA69001M	Handle "HICURA", size M, monopolar
WA69001L	Handle "HICURA", size L, monopolar

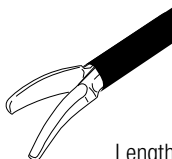
Mini-Metzenbaum Scissors

Length of jaws: 16 mm

Components

WA69372M	Jaws insert "HICURA", 5 x 330, Metzenbaum mini, monopolar
WA69372S	Jaws insert "HICURA", 5 x 250, Metzenbaum mini, monopolar
WA69372L	Jaws insert "HICURA", 5 x 430, Metzenbaum mini, monopolar
WA69300M	Shaft "HICURA", 5 x 330, monopolar
WA69300S	Shaft "HICURA", 5 x 250, monopolar
WA69300L	Shaft "HICURA", 5 x 430, monopolar
WA69001M	Handle "HICURA", size M, monopolar
WA69001L	Handle "HICURA", size L, monopolar

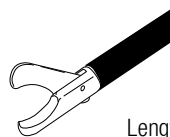
Hook Scissors

Length of jaws: 12 mm

Components

WA69376M	Jaws insert "HICURA", 5 x 330, hook, monopolar
WA69376S	Jaws insert "HICURA", 5 x 250, hook, monopolar
WA69376L	Jaws insert "HICURA", 5 x 430, hook, monopolar
WA69300M	Shaft "HICURA", 5 x 330, monopolar
WA69300S	Shaft "HICURA", 5 x 250, monopolar
WA69300L	Shaft "HICURA", 5 x 430, monopolar
WA69001M	Handle "HICURA", size M, monopolar
WA69001L	Handle "HICURA", size L, monopolar

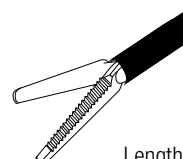
Straight Scissors

Length of jaws: 19 mm

Components

WA69374M	Jaws insert "HICURA", 5 x 330, straight, monopolar
WA69374S	Jaws insert "HICURA", 5 x 250, straight, monopolar
WA69374L	Jaws insert "HICURA", 5 x 430, straight, monopolar
WA69300M	Shaft "HICURA", 5 x 330, monopolar
WA69300S	Shaft "HICURA", 5 x 250, monopolar
WA69300L	Shaft "HICURA", 5 x 430, monopolar
WA69001M	Handle "HICURA", size M, monopolar
WA69001L	Handle "HICURA", size L, monopolar

HICURA

Standard and Monopolar,
Accessories and Spare Parts

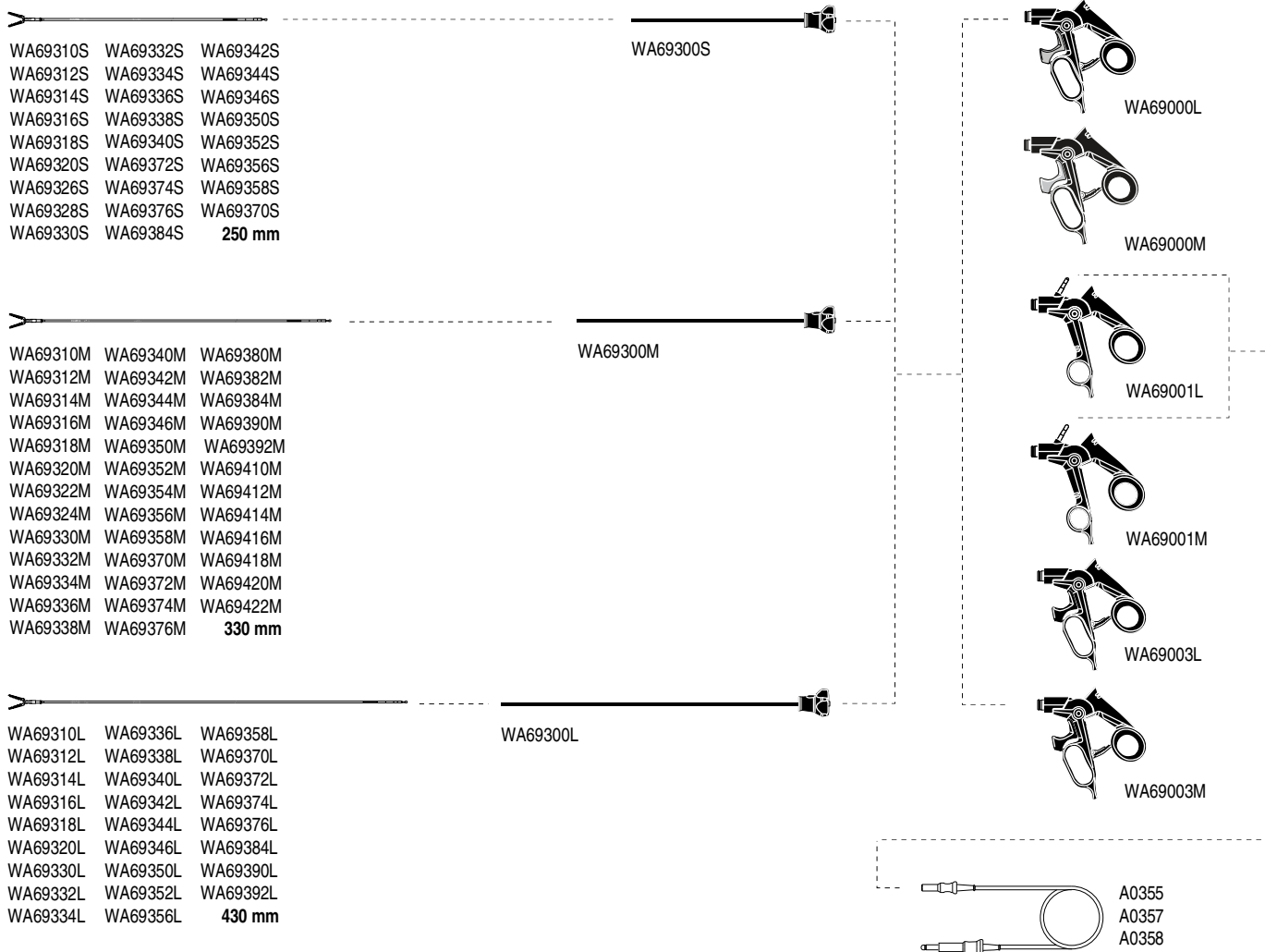

Surgery

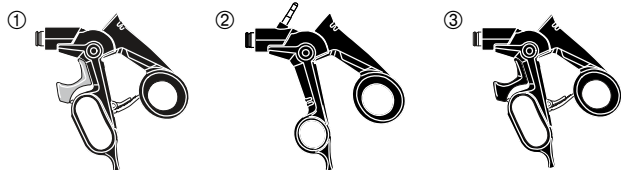
HICURA Handles

① **WA69000M** Handle "HICURA",
deactivatable ratchet,
size M

WA69000L Handle "HICURA",
deactivatable ratchet,
size L

② **WA69001M** Handle "HICURA",
monopolar,
size M

WA69001L Handle "HICURA",
monopolar,
size L

③ **WA69003M** Handle "HICURA",
ratchet,
size M

WA69003L Handle "HICURA",
ratchet,
size L

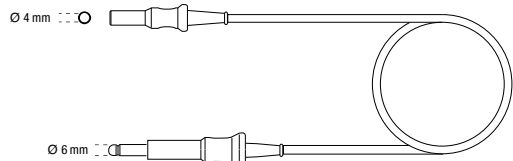
HF Cables

A0358 HF cable, monopolar,
3.5 m length,
for UES-40/-30,
Erbe International and Valleylab (new)

A0355 HF cable, monopolar,
3.5 m length,
for UES-10/-20 and Valleylab (old)

A0357 HF cable, monopolar,
3.5 m length,
for Erbe T series, Martin, and Berchtold

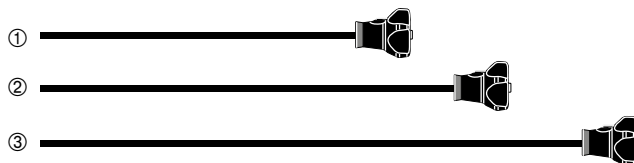
HICURA Shafts

① **WA69300S** Shaft "HICURA",
5 x 250,
monopolar

② **WA69300M** Shaft "HICURA",
5 x 330,
monopolar

③ **WA69300L** Shaft "HICURA",
5 x 430,
monopolar

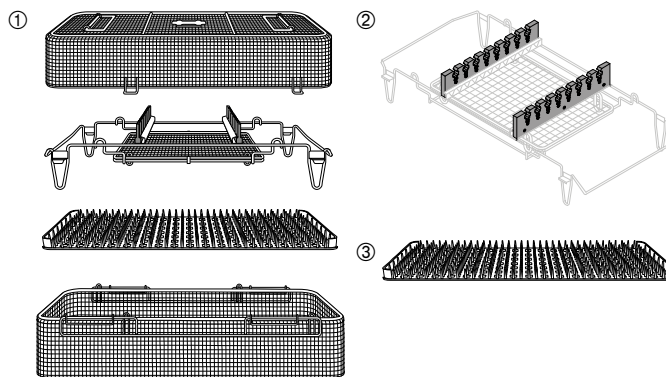
Instrument Basket System

① **WA05956A** Instrument basket system,
for HiQ+, HICURA

② **WA05957A** Spare retainer,
silicone, set, 2 pcs.,
for WA05956A

③ **WA05958A** Spare mat,
nubby, silicone,
for WA05956A

HiQ+

5 mm Grasping Forceps

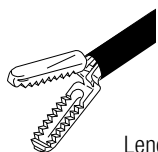

- Atraumatic grasping forceps: multipurpose grasping forceps for all laparoscopic applications
- Claw forceps: for recoverage of gall bladder, myoma, etc.
- Flat grasping forceps: multipurpose fenestrated grasping forceps for all laparoscopic applications
- Grasping forceps with lumen: atraumatic grasping forceps for delicate tissue (e.g. bowel, tubes)

Atraumatic Grasping Forceps

Length of jaws: 16 mm

A63010S	Grasping forceps "HiQ+", 5 x 250 mm, Ergo
A63010A	Grasping forceps "HiQ+", 5 x 330 mm, Ergo
A63010L	Grasping forceps "HiQ+", 5 x 430 mm, Ergo
WA63012A	Grasping forceps "HiQ+", 5 x 330 mm, atraumatic, Ergo, deactivatable ratchet
A63013S	Grasping forceps "HiQ+", 5 x 250 mm, Ergo S
A63013A	Grasping forceps "HiQ+", 5 x 330 mm, Ergo S
A63013L	Grasping forceps "HiQ+", 5 x 430 mm, Ergo S
WA63014A	Grasping forceps "HiQ+", 5 x 330 mm, atraumatic, Ergo S, deactivatable ratchet

Components

A64010S	Jaws "HiQ+", 5 x 250 mm, grasping forceps
A64010A	Jaws "HiQ+", 5 x 330 mm, grasping forceps
A64010L	Jaws "HiQ+", 5 x 430 mm, grasping forceps
A60800S	Shaft "HiQ+", 5 x 250 mm
A60800A	Shaft "HiQ+", 5 x 330 mm
A60800L	Shaft "HiQ+", 5 x 430 mm
A60100A	Handle "HiQ+", Ergo, ratchet
WA60115A	Handle "HiQ+", Ergo, deactivatable ratchet
A60200A	Handle "HiQ+", Ergo S, ratchet
WA60205A	Handle "HiQ+", Ergo S, deactivatable ratchet

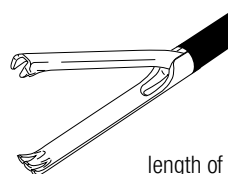
Claw Forceps

length of jaws: 28 mm

A63020A	Grasping forceps "HiQ+", 5 x 330 mm, claw type, Ergo
WA63022A	Grasping forceps "HiQ+", 5 x 330 mm, claw type, Ergo, deactivatable ratchet
A63023A	Grasping forceps "HiQ+", 5 x 330 mm, claw type, Ergo S
WA63024A	Grasping forceps "HiQ+", 5 x 330 mm, claw type, Ergo S, deactivatable ratchet

Components

WA64020S	Jaws "HiQ+", 5 x 250 mm, grasping forceps, claw type
A64020A	Jaws "HiQ+", 5 x 330 mm, claw type
WA64020L	Jaws "HiQ+", 5 x 430 mm, grasping forceps, claw type
A60800S	Shaft "HiQ+", 5 x 250 mm
A60800A	Shaft "HiQ+", 5 x 330 mm
A60800L	Shaft "HiQ+", 5 x 430 mm
A60100A	Handle "HiQ+", Ergo, ratchet
WA60115A	Handle "HiQ+", Ergo, deactivatable ratchet
A60200A	Handle "HiQ+", Ergo S, ratchet
WA60205A	Handle "HiQ+", Ergo S, deactivatable ratchet

Flat Grasping Forceps

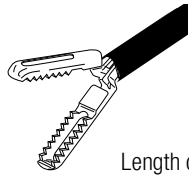

Length of jaws: 19 mm

A63030A	Grasping forceps "HiQ+", 5 x 330 mm, Ergo
WA63032A	Grasping forceps "HiQ+", 5 x 330 mm, flat, Ergo, deactivatable ratchet
A63033A	Grasping forceps "HiQ+", 5 x 330 mm, Ergo S
WA63034A	Grasping forceps "HiQ+", 5 x 330 mm, flat, Ergo S, deactivatable ratchet

Components

WA64030S	Jaws "HiQ+", 5 x 250 mm, Grasping forceps, flat
A64030A	Jaws "HiQ+", 5 x 330 mm, Grasping forceps
WA64030L	Jaws "HiQ+", 5 x 430 mm, grasping forceps, flat
A60800S	Shaft "HiQ+", 5 x 250 mm
A60800A	Shaft "HiQ+", 5 x 330 mm
A60800L	Shaft "HiQ+", 5 x 430 mm
A60100A	Handle "HiQ+", Ergo, ratchet
WA60115A	Handle "HiQ+", Ergo, deactivatable ratchet
A60200A	Handle "HiQ+", Ergo S, ratchet
WA60205A	Handle "HiQ+", Ergo S, deactivatable ratchet

Grasping Forceps with Lumen

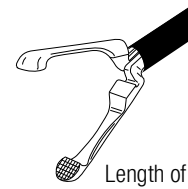

Length of jaws: 21 mm

A63040A	Grasping forceps "HiQ+", 5 x 330 mm, lumen, Ergo
WA63042A	Grasping forceps "HiQ+", 5 x 330 mm, lumen, Ergo, deactivatable ratchet
A63043A	Grasping forceps "HiQ+", 5 x 330 mm, lumen, Ergo S
WA63044A	Grasping forceps "HiQ+", 5 x 330 mm, lumen, Ergo S, deactivatable ratchet

Components

WA64040S	Jaws "HiQ+", 5 x 250 mm, grasping forceps, lumen
A64040A	Jaws "HiQ+", 5 x 330 mm, lumen
WA64040L	Jaws "HiQ+", 5 x 430 mm, grasping forceps, lumen
A60800S	Shaft "HiQ+", 5 x 250 mm
A60800A	Shaft "HiQ+", 5 x 330 mm
A60800L	Shaft "HiQ+", 5 x 430 mm
A60100A	Handle "HiQ+", Ergo, ratchet
WA60115A	Handle "HiQ+", Ergo, deactivatable ratchet
A60200A	Handle "HiQ+", Ergo S, ratchet
WA60205A	Handle "HiQ+", Ergo S, deactivatable ratchet



HiQ+

5 mm Grasping Forceps (cont.)

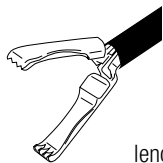

- Manhes forceps:
precise fixation and manipulation of fragile tissue
- Crocodile forceps:
for strong and tight fixation of tissue
(e.g. stomach, gall bladder)
- Atraumatic wave type forceps:
dedicated grasping forceps for bowel and fragile tissue
- Johann forceps:
atraumatic fenestrated multipurpose grasping
forceps with large jaws and good visibility

Manhes Forceps

length of jaws: 18 mm

A63050A	Grasping forceps "HiQ+", 5 x 330 mm, Manhes, Ergo
WA63052A	Grasping forceps "HiQ+", 5 x 330 mm, Manhes, Ergo, deactivatable ratchet
A63053A	Grasping forceps "HiQ+", 5 x 330 mm, Manhes, Ergo S
WA63054A	Grasping forceps "HiQ+", 5 x 330 mm, Manhes, Ergo S, deactivatable ratchet

Components

A64050A	Jaws "HiQ+", 5 x 330 mm, Manhes
WA64050L	Jaws "HiQ+", 5 x 430 mm, grasping forceps, Manhes
A60800A	Shaft "HiQ+", 5 x 330 mm
A60800L	Shaft "HiQ+", 5 x 430 mm
A60100A	Handle "HiQ+", Ergo, ratchet
WA60115A	Handle "HiQ+", Ergo, deactivatable ratchet
A60200A	Handle "HiQ+", Ergo S, ratchet
WA60205A	Handle "HiQ+", Ergo S, deactivatable ratchet

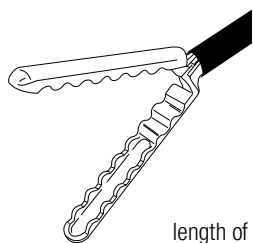
Manhes Forceps

length of jaws: 30 mm

A63080A	Grasping forceps "HiQ+", 5 x 330 mm, wave type, Ergo
WA63082A	Grasping forceps "HiQ+", 5 x 330 mm, wave type, Ergo, deactivatable ratchet
A63083A	Grasping forceps "HiQ+", 5 x 330 mm, wave type, Ergo S
WA63084A	Grasping forceps "HiQ+", 5 x 330 mm, wave type, Ergo S, deactivatable ratchet

Components

A64080A	Jaws "HiQ+", 5 x 330 mm, wave type
WA64080L	Jaws "HiQ+", 5 x 430 mm, grasping forceps, wave type
A60800A	Shaft "HiQ+", 5 x 330 mm
A60800L	Shaft "HiQ+", 5 x 430 mm
A60100A	Handle "HiQ+", Ergo, ratchet
WA60115A	Handle "HiQ+", Ergo, deactivatable ratchet
A60200A	Handle "HiQ+", Ergo S, ratchet
WA60205A	Handle "HiQ+", Ergo S, deactivatable ratchet

Crocodile Forceps

length of jaws: 18 mm

A63070A	Grasping forceps "HiQ+", 5 x 330 mm, atraumatic, alligator type, Ergo
WA63072A	Grasping forceps "HiQ+", 5 x 330 mm, alligator type, Ergo, deactivatable ratchet
A63073A	Grasping forceps "HiQ+", 5 x 330 mm, alligator type, atraumatic, Ergo S
WA63074A	Grasping forceps "HiQ+", 5 x 330 mm, alligator type, Ergo S, deactivatable ratchet

Components

A64070A	Jaws "HiQ+", 5 x 330 mm, alligator type
WA64070L	Jaws "HiQ+", 5 x 430 mm, grasping forceps, alligator type
A60800A	Shaft "HiQ+", 5 x 330 mm
A60800L	Shaft "HiQ+", 5 x 430 mm
A60100A	Handle "HiQ+", Ergo, ratchet
WA60115A	Handle "HiQ+", Ergo, deactivatable ratchet
A60200A	Handle "HiQ+", Ergo S, ratchet
WA60205A	Handle "HiQ+", Ergo S, deactivatable ratchet

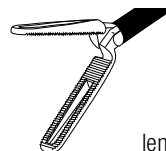
Johann Forceps

length of jaws: 24 mm

A63120S	Grasping forceps "HiQ+", 5 x 250 mm, fine tooth, fenestrated, Ergo
A63120A	Grasping forceps "HiQ+", 5 x 330 mm, fine tooth, fenestrated, Ergo
WA63120L	Grasping forceps "HiQ+", 5 x 430 mm, Johann, Ergo
WA63122A	Grasping forceps "HiQ+", 5 x 330 mm, Johann, Ergo, deactivatable ratchet
A63123S	Grasping forceps "HiQ+", 5 x 250 mm, fine tooth, fenestrated, Ergo S
A63123A	Grasping forceps "HiQ+", 5 x 330 mm, fine tooth, fenestrated, Ergo S
WA63123L	Grasping forceps "HiQ+", 5 x 430 mm, Johann, Ergo S
WA63124A	Grasping forceps "HiQ+", 5 x 330 mm, Johann, Ergo S, deactivatable ratchet

Components

A64120S	Jaws "HiQ+", 5 x 250 mm, fine tooth, fenestrated
A64120A	Jaws "HiQ+", 5 x 330 mm, fine tooth, fenestrated
WA64120L	Jaws "HiQ+", 5 x 430 mm, Johann
A60800S	Shaft "HiQ+", 5 x 250 mm
A60800A	Shaft "HiQ+", 5 x 330 mm
A60800L	Shaft "HiQ+", 5 x 430 mm
A60100A	Handle "HiQ+", Ergo, ratchet
WA60115A	Handle "HiQ+", Ergo, deactivatable ratchet
A60200A	Handle "HiQ+", Ergo S, ratchet
WA60205A	Handle "HiQ+", Ergo S, deactivatable ratchet

HiQ+

5 mm Grasping Forceps (cont.)

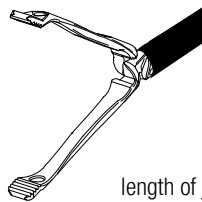

- Babcock forceps:
widest inner lumen of all 5 mm HiQ+ hand instruments, “paddle” design for maximum grasping performance without damage of soft tissue (e.g. colon)
- Long Johann forceps:
longest jaws in the 5 mm line of HiQ+ hand instruments for atraumatic grasping of larger organs (e.g. colon)
- Johann single-action forceps:
The single-action mechanism offers improved handling in limited operation areas and allows an atraumatic and firm grasping of soft tissue (e.g. colon).

Babcock Forceps

length of jaws: 31 mm

WA63140A	Grasping forceps "HiQ+", 5 x 330 mm, Babcock, Ergo
WA63142A	Grasping forceps "HiQ+", 5 x 330 mm, Babcock, Ergo, deactivatable ratchet
WA63143A	Grasping forceps "HiQ+", 5 x 330 mm, Babcock, Ergo S
WA63144A	Grasping forceps "HiQ+", 5 x 330 mm, Babcock, Ergo S, deactivatable ratchet

Components

WA64140A	Jaws "HiQ+", 5 x 330 mm, Babcock
WA64140L	Jaws "HiQ+", 5 x 430 mm, grasping forceps, Babcock
A60800A	Shaft "HiQ+", 5 x 330 mm
A60800L	Shaft "HiQ+", 5 x 430 mm
A60100A	Handle "HiQ+", Ergo, ratchet
WA60115A	Handle "HiQ+", Ergo, deactivatable ratchet
A60200A	Handle "HiQ+", Ergo S, ratchet
WA60205A	Handle "HiQ+", Ergo S, deactivatable ratchet

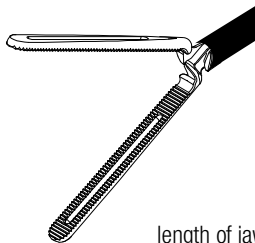
Long Johann Forceps

length of jaws: 40 mm

WA63130A	Grasping forceps "HiQ+", 5 x 330 mm, Johann long, Ergo
WA63132A	Grasping forceps "HiQ+", 5 x 330 mm, Johann long, Ergo, deactivatable ratchet
WA63133A	Grasping forceps "HiQ+", 5 x 330 mm, Johann long, Ergo S
WA63134A	Grasping forceps "HiQ+", 5 x 330 mm, Johann long, Ergo S, deactivatable ratchet

Components

WA64130A	Jaws "HiQ+", 5 x 330 mm, Johann long
WA64130L	Jaws "HiQ+", 5 x 430 mm, grasping forceps, Johann long
A60800A	Shaft "HiQ+", 5 x 330 mm
A60800L	Shaft "HiQ+", 5 x 430 mm
A60100A	Handle "HiQ+", Ergo, ratchet
WA60115A	Handle "HiQ+", Ergo, deactivatable ratchet
A60200A	Handle "HiQ+", Ergo S, ratchet
WA60205A	Handle "HiQ+", Ergo S, deactivatable ratchet

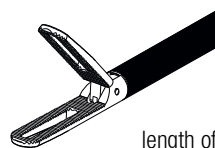
Johann Single-Action Forceps

length of jaws: 24 mm

WA63190A	Grasping forceps "HiQ+", 5 x 330 mm, Johann, single action, Ergo
WA63190L	Grasping forceps "HiQ+", 5 x 430 mm, Johann, single action, Ergo
WA63192A	Grasping forceps "HiQ+", 5 x 330 mm, Johann single-action, Ergo, deactivatable ratchet
WA63193A	Grasping forceps "HiQ+", 5 x 330 mm, Johann, single action, Ergo S
WA63193L	Grasping forceps "HiQ+", 5 x 430 mm, Johann, single action, Ergo S
WA63194A	Grasping forceps "HiQ+", 5 x 330 mm, Johann single-action, Ergo S, deactivatable ratchet

Components

WA64190A	Jaws "HiQ+", 5 x 330 mm, grasping forceps, Johann, single action
WA64190L	Jaws "HiQ+", 5 x 430 mm, Grasping forceps, Johann, single action
A60800A	Shaft "HiQ+", 5 x 330 mm
A60800L	Shaft "HiQ+", 5 x 430 mm
A60100A	Handle "HiQ+", Ergo, ratchet
WA60115A	Handle "HiQ+", Ergo, deactivatable ratchet
A60200A	Handle "HiQ+", Ergo S, ratchet
WA60205A	Handle "HiQ+", Ergo S, deactivatable ratchet

HiQ+

5 mm Grasping Forceps (cont.)



- CroceOlmi forceps:
Allows through a special jaws design the grasping and refixation of the tissue out of the hernia sac and bowel manipulation.



- DeBakey forceps:
Fine toothed jaws design and long jaws allow atraumatic grasping of the bowel and other delicate tissue.



- Atraumatic forceps with lumen:
Due to inner lumen and short overall length the jaws provide a good atraumatic grip. The lumen creates a tweezer effect. Both the atraumatic grip and the tweezer effect are perfect for perpendicular grasping as needed in the endometriosis treatment.

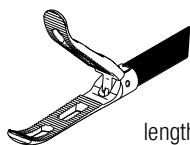

- Clinching forceps:
Allows atraumatic, firm grasping of the gall bladder and other slippery tissue through its special tooth design. Mandatory jaws for cholecystectomy.

CroceOImi Grasping Forceps

length of jaws: 29 mm

WA63150A	Grasping forceps "HiQ+", 5 x 330 mm, CroceOImi, Ergo
WA63150L	Grasping forceps "HiQ+", 5 x 430 mm, CroceOImi, Ergo
WA63152A	Grasping forceps "HiQ+", 5 x 330 mm, CroceOImi, Ergo, deactivatable ratchet
WA63153A	Grasping forceps "HiQ+", 5 x 330 mm, CroceOImi, Ergo S
WA63153L	Grasping forceps "HiQ+", 5 x 430 mm, CroceOImi, Ergo S
WA63154A	Grasping forceps "HiQ+", 5 x 330 mm, CroceOImi, Ergo S, deactivatable ratchet

Components

WA64150A	Jaws "HiQ+", 5 x 330 mm, grasping forceps, CroceOImi
WA64150L	Jaws "HiQ+", 5 x 430 mm, grasping forceps, CroceOImi
A60800A	Shaft "HiQ+", 5 x 330 mm
A60800L	Shaft "HiQ+", 5 x 430 mm
A60100A	Handle "HiQ+", Ergo, ratchet
A60101A	Handle "HiQ+", Ergo, unipolar
WA60115A	Handle "HiQ+", Ergo, deactivatable ratchet
A60200A	Handle "HiQ+", Ergo S, ratchet
A60201A	Handle "HiQ+", Ergo S, unipolar
WA60205A	Handle "HiQ+", Ergo S, deactivatable ratchet

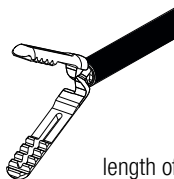
Clinching Forceps

length of jaws: 26 mm

WA63180A	Grasping forceps "HiQ+", 5 x 330 mm, Clinching, Ergo
WA63182A	Grasping forceps "HiQ+", 5 x 330 mm, clinching, Ergo, deactivatable ratchet
WA63183A	Grasping forceps "HiQ+", 5 x 330 mm, Clinching, Ergo S
WA63184A	Grasping forceps "HiQ+", 5 x 330 mm, clinching, Ergo S, deactivatable ratchet

Components

WA64180A	Jaws "HiQ+", 5 x 330 mm, grasping forceps, Clinching
A60800A	Shaft "HiQ+", 5 x 330 mm
A60100A	Handle "HiQ+", Ergo, ratchet
WA60115A	Handle "HiQ+", Ergo, deactivatable ratchet
A60200A	Handle "HiQ+", Ergo S, ratchet
WA60205A	Handle "HiQ+", Ergo S, deactivatable ratchet

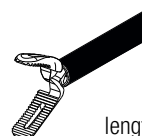
Atraumatic Forceps with Lumen

length of jaws: 16 mm

WA63170A	Grasping forceps "HiQ+", 5 x 330 mm, atraumatic, lumen, Ergo
WA63172A	Grasping forceps "HiQ+", 5 x 330 mm, atraumatic, with lumen, Ergo, deactivatable ratchet
WA63173A	Grasping forceps "HiQ+", 5 x 330 mm, atraumatic, lumen, Ergo S
WA63174A	Grasping forceps "HiQ+", 5 x 330 mm, atraumatic, with lumen, Ergo S, deactivatable ratchet

Components

WA64170A	Jaws "HiQ+", 5 x 330 mm, grasping forceps, atraumatic, lumen
A60800A	Shaft "HiQ+", 5 x 330 mm
A60101A	Handle "HiQ+", Ergo, unipolar
WA60115A	Handle "HiQ+", Ergo, deactivatable ratchet
A60200A	Handle "HiQ+", Ergo S, ratchet
WA60205A	Handle "HiQ+", Ergo S, deactivatable ratchet

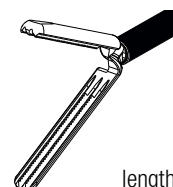
DeBakey Grasping Forceps

length of jaws: 29 mm

WA63160A	Grasping forceps "HiQ+", 5 x 330 mm, DeBakey, Ergo
WA63160L	Grasping forceps "HiQ+", 5 x 430 mm, DeBakey, Ergo
WA63162A	Grasping forceps "HiQ+", 5 x 330 mm, DeBakey, Ergo, deactivatable ratchet
WA63163A	Grasping forceps "HiQ+", 5 x 330 mm, DeBakey, Ergo S
WA63163L	Grasping forceps "HiQ+", 5 x 430 mm, DeBakey, Ergo S
WA63164A	Grasping forceps "HiQ+", 5 x 330 mm, DeBakey, Ergo S, deactivatable ratchet

Components

WA64160A	Jaws "HiQ+", 5 x 330 mm, grasping forceps, DeBakey
WA64160L	Jaws "HiQ+", 5 x 430 mm, grasping forceps, DeBakey
A60800A	Shaft "HiQ+", 5 x 330 mm
A60800L	Shaft "HiQ+", 5 x 430 mm
A60100A	Handle "HiQ+", Ergo, ratchet
A60101A	Handle "HiQ+", Ergo, unipolar
A60102A	Handle "HiQ+", Ergo, ratchet, unipolar
WA60115A	Handle "HiQ+", Ergo, deactivatable ratchet
A60200A	Handle "HiQ+", Ergo S, ratchet
A60201A	Handle "HiQ+", Ergo S, unipolar
WA60205A	Handle "HiQ+", Ergo S, deactivatable ratchet

HiQ+

5 mm Dissection Forceps



- Maryland forceps:
multipurpose curved dissection forceps
for all laparoscopic applications

- Short Maryland forceps:
for precise dissection and needle holder assistance

- Maryland cross tooth:
The cross tooth surface design allows
stronger grasping performance.

- Fine Maryland cross tooth:
Longer branch length improves the overview
and handling. The cross tooth surface allows
stronger grasping performance.

Maryland Forceps

length of jaws: 21 mm

A63320S	Dissection forceps "HiQ+", 5 x 250 mm, Maryland, Ergo
A63320A	Dissection forceps "HiQ+", 5 x 330 mm, Maryland, Ergo
A63320L	Dissection forceps "HiQ+", 5 x 430 mm, Maryland, Ergo
WA63322A	Dissection forceps "HiQ+", 5 x 330 mm, Maryland, Ergo, deactivatable ratchet
A63323S	Dissection forceps "HiQ+", 5 x 250 mm, Maryland, Ergo S
A63323A	Dissection forceps "HiQ+", 5 x 330 mm, Maryland, Ergo S
A63323L	Dissection forceps "HiQ+", 5 x 430 mm, Maryland, Ergo S
WA63324A	Dissection forceps "HiQ+", 5 x 330 mm, Maryland, Ergo S, deactivatable ratchet

Components

A64320S	Jaws "HiQ+", 5 x 250 mm, dissection forceps, Maryland
A64320A	Jaws "HiQ+", 5 x 330 mm, dissection forceps, Maryland
A64320L	Jaws "HiQ+", 5 x 430 mm, dissection forceps, Maryland
A60800S	Shaft "HiQ+", 5 x 250 mm
A60800A	Shaft "HiQ+", 5 x 330 mm
A60800L	Shaft "HiQ+", 5 x 430 mm
A60101A	Handle "HiQ+", Ergo, unipolar
WA60115A	Handle "HiQ+", Ergo, deactivatable ratchet
A60201A	Handle "HiQ+", Ergo S, unipolar
WA60205A	Handle "HiQ+", Ergo S, deactivatable ratchet

Short Maryland Forceps

length of jaws: 17 mm

A63340A	Dissection forceps "HiQ+", 5 x 330 mm, Maryland, short, Ergo
WA63342A	Dissection forceps "HiQ+", 5 x 330 mm, Maryland, short, Ergo, deactivatable ratchet
A63343A	Dissection forceps "HiQ+", 5 x 330 mm, Maryland, short, Ergo S
WA63344A	Dissection forceps "HiQ+", 5 x 330 mm, Maryland, short, Ergo S, deactivatable ratchet

Components

WA64340S	Jaws "HiQ+", 5 x 250 mm, dissection forceps, Maryland, short
A64340A	Jaws "HiQ+", 5 x 330 mm, dissection forceps, Maryland, short
WA64340L	Jaws "HiQ+", 5 x 430 mm, dissection forceps, Maryland, short
A60800S	Jaws "HiQ+", 5 x 430 mm, dissection forceps, Maryland, short
A60800A	Shaft "HiQ+", 5 x 330 mm
A60800L	Shaft "HiQ+", 5 x 430 mm
A60101A	Handle "HiQ+", Ergo, unipolar
WA60115A	Handle "HiQ+", Ergo, deactivatable ratchet
A60201A	Handle "HiQ+", Ergo S, unipolar
WA60205A	Handle "HiQ+", Ergo S, unipolar
WA60205A	Handle "HiQ+", Ergo S, deactivatable ratchet

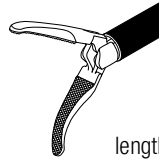
Maryland Forceps with Cross Tooth Pattern

length of jaws: 17 mm

WA63350A	Dissection forceps "HiQ+", 5 x 330 mm, Maryland, cross tooth pattern, Ergo
WA63352A	Dissection forceps "HiQ+", 5 x 330 mm, Maryland, cross tooth pattern, Ergo, deactivatable ratchet
WA63353A	Dissection forceps "HiQ+", 5 x 330 mm, Maryland, cross tooth pattern, Ergo S
WA63354A	Dissection forceps "HiQ+", 5 x 330 mm, Maryland, cross tooth pattern, Ergo S, deactivatable ratchet

Components

WA64350S	Jaws "HiQ+", 5 x 250 mm, dissection forceps, Maryland, cross tooth pattern
WA64350A	Jaws "HiQ+", 5 x 330 mm, Dissection forceps, Maryland, cross tooth pattern
WA64350L	Jaws "HiQ+", 5 x 430 mm, dissection forceps, Maryland, cross tooth pattern
A60800S	Shaft "HiQ+", 5 x 250 mm
A60800A	Shaft "HiQ+", 5 x 330 mm
A60800L	Shaft "HiQ+", 5 x 430 mm
A60101A	Handle "HiQ+", Ergo, unipolar
WA60115A	Handle "HiQ+", Ergo, deactivatable ratchet
A60201A	Handle "HiQ+", Ergo S, unipolar
WA60205A	Handle "HiQ+", Ergo S, unipolar

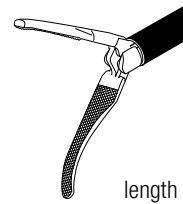
Fine Maryland Forceps with Cross Tooth Pattern

length of jaws: 19 mm

WA63370A	Dissection forceps "HiQ+", 5 x 330 mm, Maryland fine, cross tooth pattern, Ergo
WA63372A	Dissection forceps "HiQ+", 5 x 330 mm, Maryland fine, cross tooth pattern, Ergo, deactivatable ratchet
WA63373A	Dissection forceps "HiQ+", 5 x 330 mm, Maryland fine, cross tooth pattern, Ergo S
WA63374A	Dissection forceps "HiQ+", 5 x 330 mm, Maryland fine, cross tooth pattern, Ergo S, deactivatable ratchet

Components

WA64370S	Jaws "HiQ+", 5 x 250 mm, dissection forceps, Maryland fine, cross tooth pattern
WA64370A	Jaws "HiQ+", 5 x 330 mm, dissection forceps, Maryland fine, cross tooth pattern
WA64370L	Jaws "HiQ+", 5 x 430 mm, dissection forceps, Maryland fine, cross tooth pattern
A60800S	Shaft "HiQ+", 5 x 250 mm
A60800A	Shaft "HiQ+", 5 x 330 mm
A60800L	Shaft "HiQ+", 5 x 430 mm
A60101A	Handle "HiQ+", Ergo, unipolar
WA60115A	Handle "HiQ+", Ergo, deactivatable ratchet
A60201A	Handle "HiQ+", Ergo S, unipolar
WA60205A	Handle "HiQ+", Ergo S, deactivatable ratchet



HiQ+

5 mm Dissection Forceps (cont.)



- Straight dissection forceps:
for delicate dissection and needle holder assistance

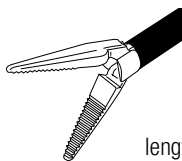

- Right angle dissector:
for blood vessel dissection

Dissection Forceps

length of jaws: 15 mm

A63310S	Dissection forceps "HiQ+", 5 x 250 mm, straight, Ergo
A63310A	Dissection forceps "HiQ+", 5 x 330 mm, straight, Ergo
WA63312A	Dissection forceps "HiQ+", 5 x 330 mm, straight, Ergo, deactivatable ratchet
A63313S	Dissection forceps "HiQ+", 5 x 250 mm, straight, Ergo S
A63313A	Dissection forceps "HiQ+", 5 x 330 mm, straight, Ergo S
WA63314A	Dissection forceps "HiQ+", 5 x 330 mm, straight, Ergo S, deactivatable ratchet

Components

A64310S	Jaws "HiQ+", 5 x 250 mm, dissection forceps, straight
A64310A	Jaws "HiQ+", 5 x 330 mm, dissection forceps, straight
WA64310L	Jaws "HiQ+", 5 x 430 mm, dissection forceps, straight
A60800S	Shaft "HiQ+", 5 x 250 mm
A60800A	Shaft "HiQ+", 5 x 330 mm
A60800L	Shaft "HiQ+", 5 x 430 mm
A60101A	Handle "HiQ+", Ergo, unipolar
WA60115A	Handle "HiQ+", Ergo, deactivatable ratchet
A60201A	Handle "HiQ+", Ergo S, unipolar
WA60205A	Handle "HiQ+", Ergo S, deactivatable ratchet

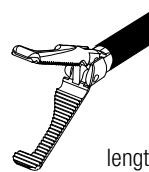
Right Angle Dissection Forceps

length of jaws: 18 mm

WA63330A	Dissection forceps, "HiQ+", 5 x 330 mm, 90° angled, Ergo
WA63332A	Dissection forceps "HiQ+", 5 x 330 mm, 90° angled, Ergo, deactivatable ratchet
WA63333A	Dissection forceps "HiQ+", 5 x 330 mm, 90° angled, Ergo S
WA63334A	Dissection forceps "HiQ+", 5 x 330 mm, 90° angled, Ergo S, deactivatable ratchet

Components

WA64330S	Jaws "HiQ+", 5 x 250 mm, dissection forceps, 90° angled
WA64330A	Jaws "HiQ+", 5 x 330 mm, 90° angled
WA64330L	Jaws "HiQ+", 5 x 430 mm, dissection forceps, 90° angled
A60800S	Shaft "HiQ+", 5 x 250 mm
A60800A	Shaft "HiQ+", 5 x 330 mm
A60800L	Shaft "HiQ+", 5 x 430 mm
A60101A	Handle "HiQ+", Ergo, unipolar
WA60115A	Handle "HiQ+", Ergo, deactivatable ratchet
A60201A	Handle "HiQ+", Ergo S, unipolar
WA60205A	Handle "HiQ+", Ergo S, deactivatable ratchet

HiQ+

5 mm Biopsy Forceps



- Biopsy forceps with spike



- Severing biopsy forceps

Biopsy Forceps

length of jaws: 14 mm

A63610S	Biopsy forceps "HiQ+", 5 x 250 mm, with spike, Ergo
A63610A	Biopsy forceps "HiQ+", 5 x 330 mm, with spike, Ergo
A63610L	Biopsy forceps "HiQ+", 5 x 430 mm, with spike, Ergo
A63613S	Biopsy forceps "HiQ+", 5 x 250 mm, with spike, Ergo S
A63613A	Biopsy forceps "HiQ+", 5 x 330 mm, with spike, Ergo S
A63613L	Biopsy forceps "HiQ+", 5 x 430 mm, with spike, Ergo S

Components

A64610S	Jaws "HiQ+", 5 x 250 mm, biopsy forceps, with spike
A64610A	Jaws "HiQ+", 5 x 330 mm, with spike, biopsy forceps
A64610L	Jaws "HiQ+", 5 x 430 mm, biopsy forceps, with spike
A60800S	Shaft "HiQ+", 5 x 250 mm
A60800A	Shaft "HiQ+", 5 x 330 mm
A60800L	Shaft "HiQ+", 5 x 430 mm
A60101A	Handle "HiQ+", Ergo, unipolar
A60201A	Handle "HiQ+", Ergo S, unipolar

Biopsy Forceps

length of jaws: 12 mm

A63620A	Biopsy forceps "HiQ+", 5 x 330 mm, severing, Ergo
A63623A	Biopsy forceps "HiQ+", 5 x 330 mm, severing, Ergo S

Components

A64620A	Jaws "HiQ+", 5 x 330 mm, biopsy forceps, severing
WA64620L	Jaws "HiQ+", 5 x 430 mm, biopsy forceps, severing
A60800A	Shaft "HiQ+", 5 x 330 mm
A60800L	Shaft "HiQ+", 5 x 430 mm
A60101A	Handle "HiQ+", Ergo, unipolar
A60201A	Handle "HiQ+", Ergo S, unipolar

HiQ+

5 mm Monopolar Scissors



- Metzenbaum:
Multipurpose scissors for all laparoscopic applications



- Mini-Metzenbaum:
for precise cutting and preparation



- Hook scissors:
for cutting of sutures

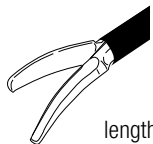

- Straight scissors

**Metzenbaum Scissors**

length of jaws: 19 mm

A63810S	Scissors "HiQ+", 5 x 250 mm, Metzenbaum, Ergo
A63810A	Scissors "HiQ+", 5 x 330 mm, Metzenbaum, Ergo
A63810L	Scissors "HiQ+", 5 x 430 mm, Metzenbaum, Ergo
A63813S	Scissors "HiQ+", 5 x 250 mm, Metzenbaum, Ergo S
A63813A	Scissors "HiQ+", 5 x 330 mm, Metzenbaum, Ergo S
A63813L	Scissors "HiQ+", 5 x 430 mm, Metzenbaum, Ergo S

Components

A64810S	Jaws "HiQ+", 5 x 250 mm, scissors, Metzenbaum
A64810A	Jaws "HiQ+", 5 x 330 mm, scissors, Metzenbaum
A64810L	Jaws "HiQ+", 5 x 430 mm, scissors, Metzenbaum
A60800S	Shaft "HiQ+", 5 x 250 mm
A60800A	Shaft "HiQ+", 5 x 330 mm
A60800L	Shaft "HiQ+", 5 x 430 mm
A60101A	Handle "HiQ+", Ergo, unipolar
A60201A	Handle "HiQ+", Ergo S, unipolar

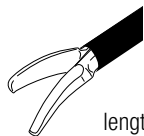
Mini-Metzenbaum Scissors

length of jaws: 16 mm

A63840A	Scissors "HiQ+", 5 x 330 mm, Mini-Metzenbaum, Ergo
A63843A	Scissors "HiQ+", 5 x 330 mm, Mini-Metzenbaum, Ergo S

Components

WA64840S	Jaws "HiQ+", 5 x 250 mm, scissors, Mini-Metzenbaum
A64840A	Jaws "HiQ+", 5 x 330 mm, scissors, Mini-Metzenbaum
WA64840L	Jaws "HiQ+", 5 x 430 mm, scissors, Mini-Metzenbaum
A60800S	Shaft "HiQ+", 5 x 250 mm
A60800A	Shaft "HiQ+", 5 x 330 mm
A60800L	Shaft "HiQ+", 5 x 430 mm
A60101A	Handle "HiQ+", Ergo, unipolar
A60201A	Handle "HiQ+", Ergo S, unipolar

Hook Scissors

length of jaws: 12 mm

A63820S	Hook scissors "HiQ+", 5 x 250 mm, Ergo
A63820A	Hook scissors "HiQ+", 5 x 330 mm, Ergo
A63820L	Hook scissors "HiQ+", 5 x 430 mm, Ergo
A63823S	Hook scissors "HiQ+", 5 x 250 mm, Ergo S
A63823A	Hook scissors "HiQ+", 5 x 330 mm, Ergo S
A63823L	Hook scissors "HiQ+", 5 x 430 mm, Ergo S

Components

A64820S	Jaws "HiQ+", 5 x 250 mm, hook scissors
A64820A	Jaws "HiQ+", 5 x 330 mm, hook scissors
A64820L	Jaws "HiQ+", 5 x 430 mm, hook scissors
A60800S	Shaft "HiQ+", 5 x 250 mm
A60800A	Shaft "HiQ+", 5 x 330 mm
A60800L	Shaft "HiQ+", 5 x 430 mm
A60101A	Handle "HiQ+", Ergo, unipolar
A60201A	Handle "HiQ+", Ergo S, unipolar

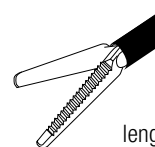
Straight Scissors

length of jaws: 19 mm

A63830A	Scissors "HiQ+", 5 x 330 mm, straight, Ergo
A63833A	Scissors "HiQ+", 5 x 330 mm, straight, Ergo S

Components

WA64830S	Jaws "HiQ+", 5 x 250 mm, scissors, straight
A64830A	Jaws "HiQ+", 5 x 330 mm, scissors, straight
WA64830L	Jaws "HiQ+", 5 x 430 mm, scissors, straight
A60800S	Shaft "HiQ+", 5 x 250 mm
A60800A	Shaft "HiQ+", 5 x 330 mm
A60800L	Shaft "HiQ+", 5 x 430 mm
A60101A	Handle "HiQ+", Ergo, unipolar
A60201A	Handle "HiQ+", Ergo S, unipolar

HiQ+

10 mm Hand Instruments



- CBD forceps:
soft-layered grasping forceps dedicated for manipulation of fragile tissue and flexible telescopes

- Claw forceps:
for recovery of gall bladder, myoma, etc.

- Babcock forceps:
for manipulation of large fragile tissue (e.g. bowel, stomach)

- Babcock-Atrauma forceps:
widest inner lumen of all 10 mm HiQ+ hand instruments; "paddle" design for maximum grasping performance with no damage of soft tissue (e.g. colon)

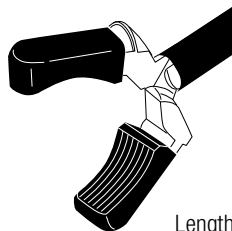
CBD Grasping Forceps

Length of jaws: 16 mm

A65070A	Grasping forceps "HiQ+", 10 x 330 mm, CBD, Ergo
A65073A	Grasping forceps "HiQ+", 10 x 330 mm, CBD, Ergo S

Components

A66070A	Jaws "HiQ+", 10 x 330 mm grasping forceps, CBD
A60901A	Shaft "HiQ+", 10 x 330 mm, insulated, tapered
A60100A	Handle "HiQ+", Ergo, ratchet
A60200A	Handle "HiQ+", Ergo S, ratchet

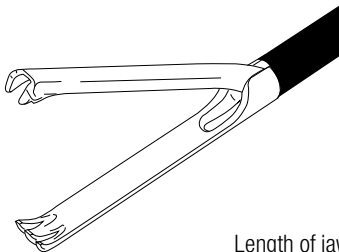
Claw Forceps

Length of jaws: 45 mm

A65020A	Grasping forceps "HiQ+", 10 x 330 mm, claw type, Ergo
A65023A	Grasping forceps "HiQ+", 10 x 330 mm, claw type, Ergo S

Components

A66020A	Jaws "HiQ+", 10 x 330 mm grasping forceps, claw type
A60900A	Shaft "HiQ+", 10 x 330 mm, insulated
A60100A	Handle "HiQ+", Ergo, ratchet
A60200A	Handle "HiQ+", Ergo S, ratchet

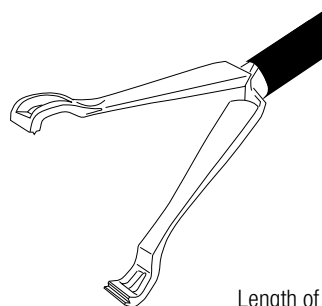
Babcock Forceps

Length of jaws: 47 mm

A65050A	Grasping forceps "HiQ+", 10 x 330 mm, Babcock, Ergo
A65053A	Grasping forceps "HiQ+", 10 x 330 mm, Babcock, Ergo S

Components

A66050A	Jaws "HiQ+", 10 x 330 mm grasping forceps, Babcock
A60900A	Shaft "HiQ+", 10 x 330 mm, insulated
A60100A	Handle "HiQ+", Ergo, ratchet
A60200A	Handle "HiQ+", Ergo S, ratchet

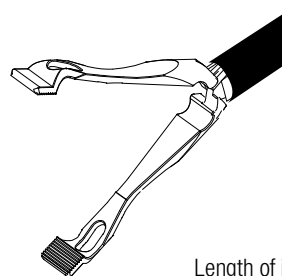
Babcock-Atrauma Forceps

Length of jaws: 53 mm

WA65040A	Grasping forceps "HiQ+", 10 x 330 mm, Babcock-Atrauma, Ergo
WA65043A	Grasping forceps "HiQ+", 10 x 330 mm, Babcock-Atrauma, Ergo S

Components

WA66040A	Jaws "HiQ+", 10 x 330 mm grasping forceps, Babcock-Atrauma
A60900A	Shaft "HiQ+", 10 x 330 mm, insulated
A60100A	Handle "HiQ+", Ergo, ratchet
A60200A	Handle "HiQ+", Ergo S, ratchet

HiQ+

10 mm Hand Instruments (cont.)



- Atraumatic wave type forceps:
dedicated grasping forceps for bowel and fragile tissue



- Maryland forceps:
multipurpose curved dissection forceps
for all laparoscopic applications

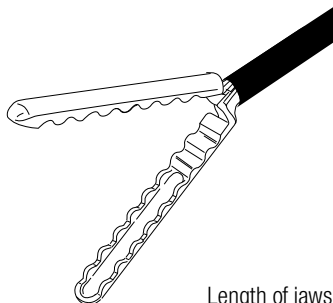

- Short Maryland forceps:
for precise dissection and needle holder assistance

Atraumatic Grasping Forceps

Length of jaws: 42 mm

A65060A Grasping forceps "HiQ+",
10 x 330 mm, wave type, Ergo

A65063A Grasping forceps "HiQ+",
10 x 330 mm, wave type, Ergo S

Components

A66060A Jaws "HiQ+", 10 x 330 mm grasping forceps, wave type

A60900A Shaft "HiQ+", 10 x 330 mm, insulated

A60100A Handle "HiQ+", Ergo, ratchet

A60200A Handle "HiQ+", Ergo S, ratchet

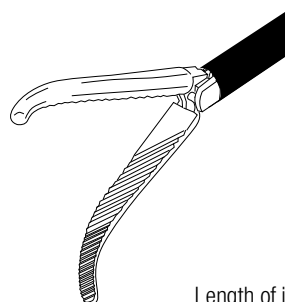
Maryland Forceps

Length of jaws: 30 mm

A65310A Dissection forceps "HiQ+",
10 x 330 mm, Maryland, Ergo

A65313A Dissection forceps "HiQ+",
10 x 330 mm, Maryland, Ergo S

Components

A66310A Jaws "HiQ+", 10 x 330 mm dissection forceps, Maryland

A60901A Shaft "HiQ+", 10 x 330 mm, insulated, tapered

A60101A Handle "HiQ+", Ergo, monopolar

A60201A Handle "HiQ+", Ergo S, monopolar

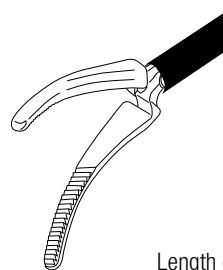
Short Maryland Forceps

Length of jaws: 24 mm

A65320A Dissection forceps "HiQ+",
10 x 330 mm, Maryland, short, Ergo

A65323A Dissection forceps "HiQ+",
10 x 330 mm, Maryland, short, Ergo S

Components

A66320A Jaws "HiQ+", 10 x 330 mm dissection forceps,
Maryland, short

A60901A Shaft "HiQ+", 10 x 330 mm, insulated, tapered

A60100A Handle "HiQ+", Ergo, ratchet

A60200A Handle "HiQ+", Ergo S, ratchet

HiQ+

Accessories and Spare Parts

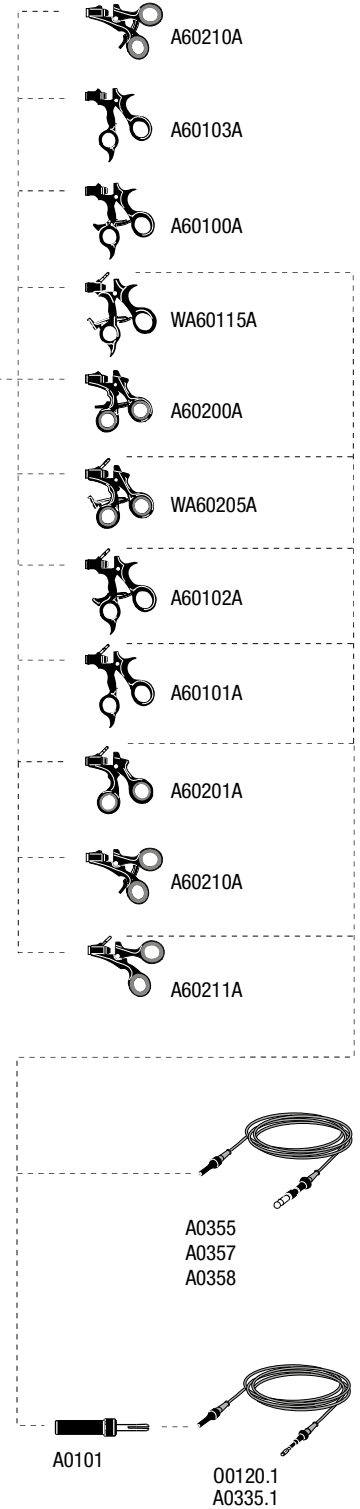
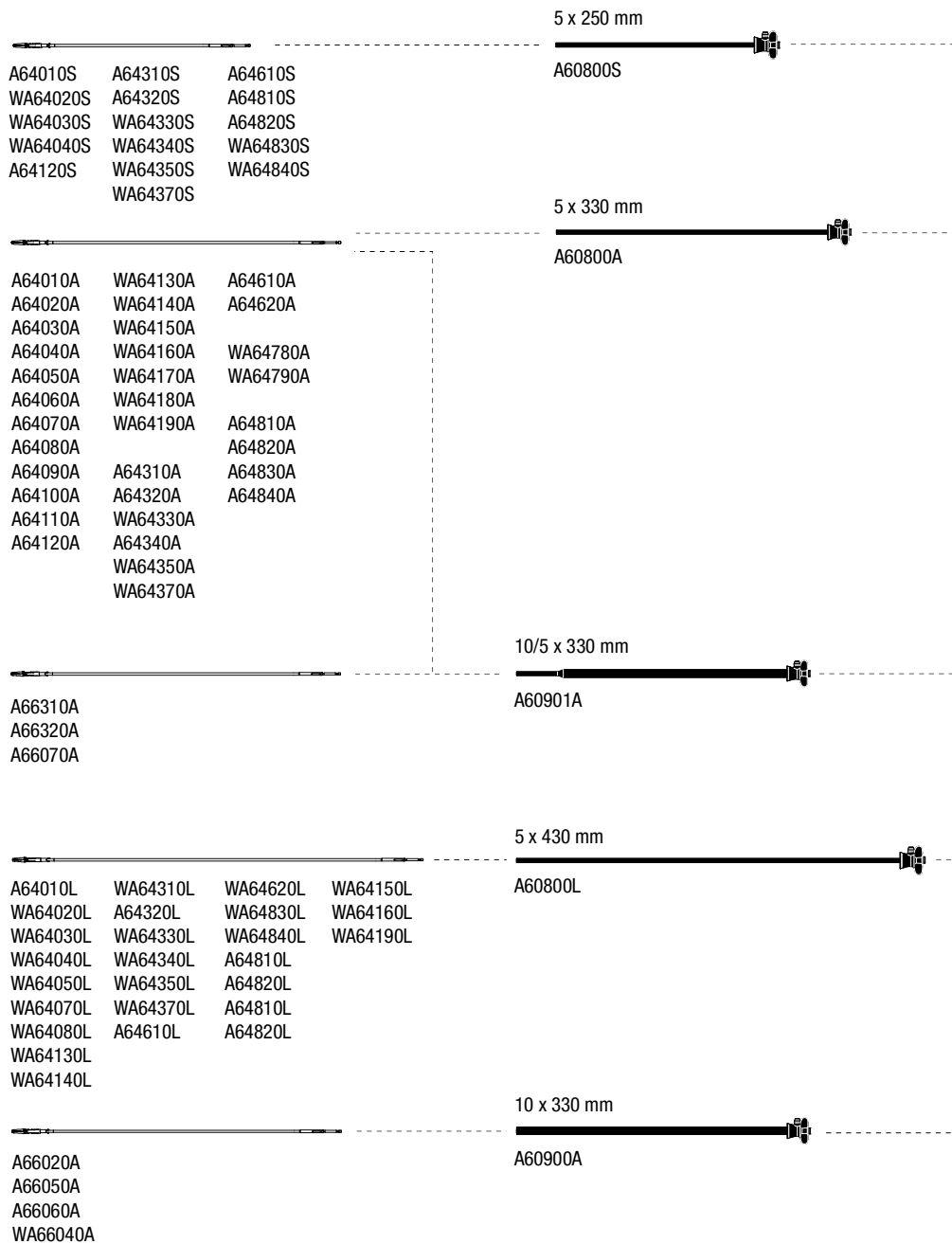

Surgery

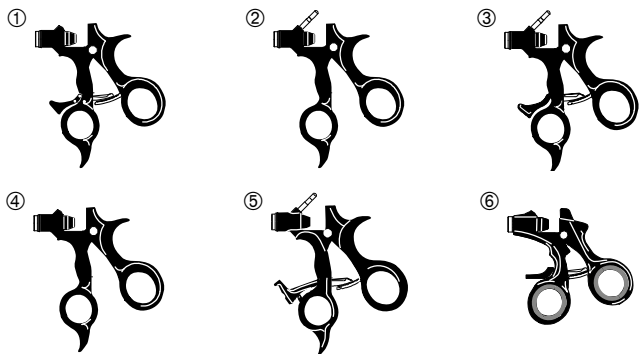
HiQ+ Ergo Handles

- | | |
|-------------------|--|
| ① A60100A | Handle "HiQ+", Ergo, ratchet |
| ② A60101A | Handle "HiQ+", Ergo, monopolar |
| ③ A60102A | Handle "HiQ+", Ergo, ratchet, monopolar |
| ④ WA60103A | Handle "HiQ+", Ergo |
| ⑤ WA60115A | Handle "HiQ+", Ergo, deactivatable ratchet |
| ⑥ A60200A | Handle "HiQ+", Ergo S, ratchet |

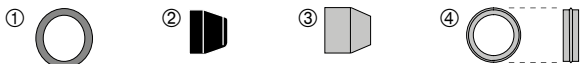
Spare Parts

- | | |
|------------------|---|
| ① A0389 | Finger ring, silicone, for HiQ+ |
| ② A03440A | Sealing cap, 2.2 mm, 10 pcs. |
| ③ A03441A | Spare button, for shaft, 10 pcs. |
| ④ A03442A | Spare sealing ring "HiQ+", for shaft, 20 pcs. |

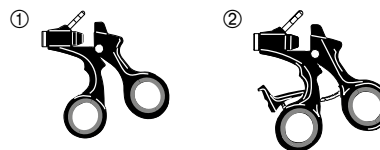
HiQ+ Ergo S Handles

With silicone finger ring

- | | |
|-------------------|--|
| ① A60201A | Handle "HiQ+", Ergo S, monopolar |
| ② WA60205A | Handle "HiQ+", Ergo S, deactivatable ratchet monopolar |

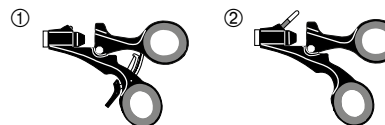
HiQ+ Semi-Inline S Handles

With silicone finger ring

- | | |
|------------------|--|
| ① A60210A | Handle "HiQ+", semi-inline S, with ratchet |
| ② A60211A | Handle "HiQ+", semi-inline S, monopolar |

HiQ+ Shafts

- | | |
|------------------|---|
| ① A60900A | Shaft "HiQ+", 10 x 330 mm, insulated |
| ② A60901A | Shaft "HiQ+", 10 x 330 mm, insulated, tapered |

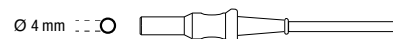
HF Cables

- | | |
|--------------|---|
| A0358 | HF cable, monopolar, 3.5 m length, for UES-40/-30, Erbe International and Valleylab (new) |
| A0355 | HF cable, monopolar, 3.5 m length, for UES-10/-20 and Valleylab (old) |
| A0357 | HF cable, monopolar, 3.5 m length, for Erbe T series, Martin, and Berchtold |

HICURA

Bipolar Hand Instruments



Surgery



reddot award 2014
winner



- Color coding for clear instrument identification
HICURA bipolar hand instruments are color-coded on the handle and the rotation wheel. The inserts also have a white insulation, so this allows rapid identification of all the bipolar components.



- Excellent jaws insulation
The bipolar jaws are PFA insulated, thus reducing the risk of coagulation failures.
The design of HICURA bipolar instruments allows strong grasping and effective coagulation, thereby combining monopolar mechanical strengths with bipolar coagulation.

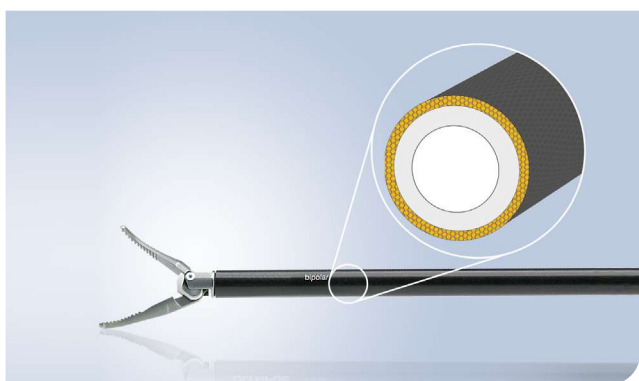

- Safety first!
HICURA shafts are PEEK insulated in order to provide optimized stability, durability and electrical insulation.

HICURA

Bipolar Grasping Forceps



- Johann forceps:
multipurpose grasping forceps for strong grasping and atraumatic dissection and all laparoscopic procedures



- Hirsch forceps:
for precise and atraumatic grasping



- Manhes forceps:
grasping forceps for myomectomy and cystectomy

Johann Forceps

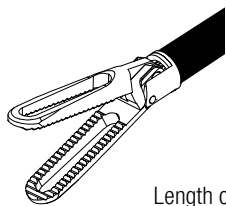

Length of jaws: 17 mm

Components

WA69410M Jaws insert "HICURA", 5 x 330, Johann, bipolar

WA69400M Shaft "HICURA", 5 x 330, bipolar

WA69002M Handle "HICURA", size M, bipolar

WA69002L Handle "HICURA", size L, bipolar

Hirsch Forceps

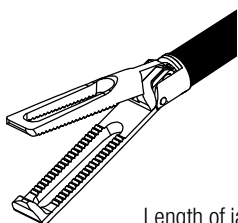

Length of jaws: 20 mm

Components

WA69412M Jaws insert "HICURA", 5 x 330, Hirsch, bipolar

WA69400M Shaft "HICURA", 5 x 330, bipolar

WA69002M Handle "HICURA", size M, bipolar

WA69002L Handle "HICURA", size L, bipolar

Manhes Forceps

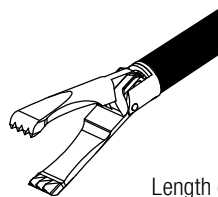

Length of jaws: 14 mm

Components

WA69414M Jaws insert "HICURA", 5 x 330, Manhes, bipolar

WA69400M Shaft "HICURA", 5 x 330, bipolar

WA69002M Handle "HICURA", size M, bipolar

WA69002L Handle "HICURA", size L, bipolar

HICURA

Bipolar Dissection Forceps



- Maryland forceps:
multipurpose curved dissection forceps
for all laparoscopic procedures



- Fine Maryland forceps:
improved overview and handling
due to increased branch length

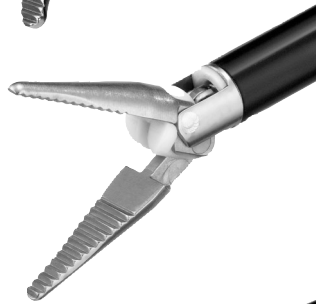

- Straight forceps:
multipurpose straight dissection forceps
for all laparoscopic procedures

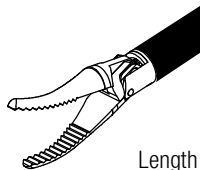

- Tweezers forceps:
for very delicate dissection and coagulation

Maryland Forceps

Length of jaws: 15 mm

Components

WA69416M	Jaws insert "HICURA", 5 x 330, Maryland, bipolar
WA69400M	Shaft "HICURA", 5 x 330, bipolar
WA69002M	Handle "HICURA", size M, bipolar
WA69002L	Handle "HICURA", size L, bipolar

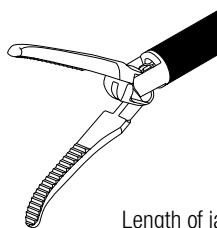
Fine Maryland Forceps

Length of jaws: 19 mm

Components

WA69418M	Jaws insert "HICURA", 5 x 330, Maryland fine, bipolar
WA69400M	Shaft "HICURA", 5 x 330, bipolar
WA69002M	Handle "HICURA", size M, bipolar
WA69002L	Handle "HICURA", size L, bipolar

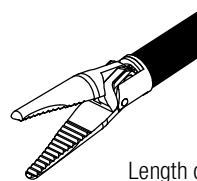
Straight Forceps

Length of jaws: 13 mm

Components

WA69420M	Jaws insert "HICURA", 5 x 330, straight, bipolar
WA69400M	Shaft "HICURA", 5 x 330, bipolar
WA69002M	Handle "HICURA", size M, bipolar
WA69002L	Handle "HICURA", size L, bipolar

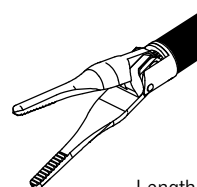
Tweezers Forceps

Length of jaws: 17 mm

Components

WA69422M	Jaws insert "HICURA", 5 x 330, tweezers, bipolar
WA69400M	Shaft "HICURA", 5 x 330, bipolar
WA69002M	Handle "HICURA", size M, bipolar
WA69002L	Handle "HICURA", size L, bipolar

HICURA

Bipolar Accessories and Spare Parts

HICURA Bipolar Handle



WA69002M Handle "HICURA", bipolar, size M

WA69002L Handle "HICURA", bipolar, size L

HICURA Bipolar Shaft



WA69400M Shaft "HICURA", 5 x 330, bipolar

Bipolar HF Cable

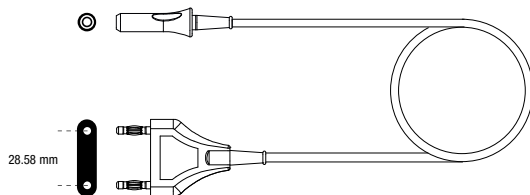

A60003C HF cable, bipolar, 3.5 m length, for UES-20/-30/-40, Erbe VIO¹ and Valleylab HF units

A60001C HF cable, bipolar, 3.5 m length, for Erbe International HF units

A60002C HF cable, bipolar, 3.5 m length, for Martin and Berchtold HF units

A60000C HF cable, bipolar, 3.5 m length, for HF-300, Erbe T series, and Erbe ACC/ICC/VIO¹ HF units

¹ Depending on individual connector configuration

Instrument Basket System

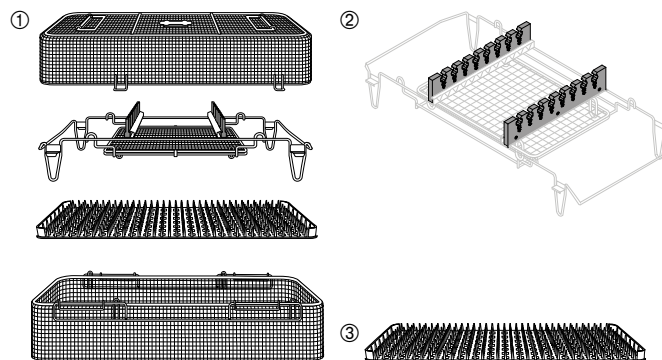

① **WA05956A** Instrument basket system, for HiQ+, HICURA

② **WA05957A** Spare retainer, silicone, set, 2 pcs., for WA05956A

③ **WA05958A** Spare mat, nubby, silicone, for WA05956A

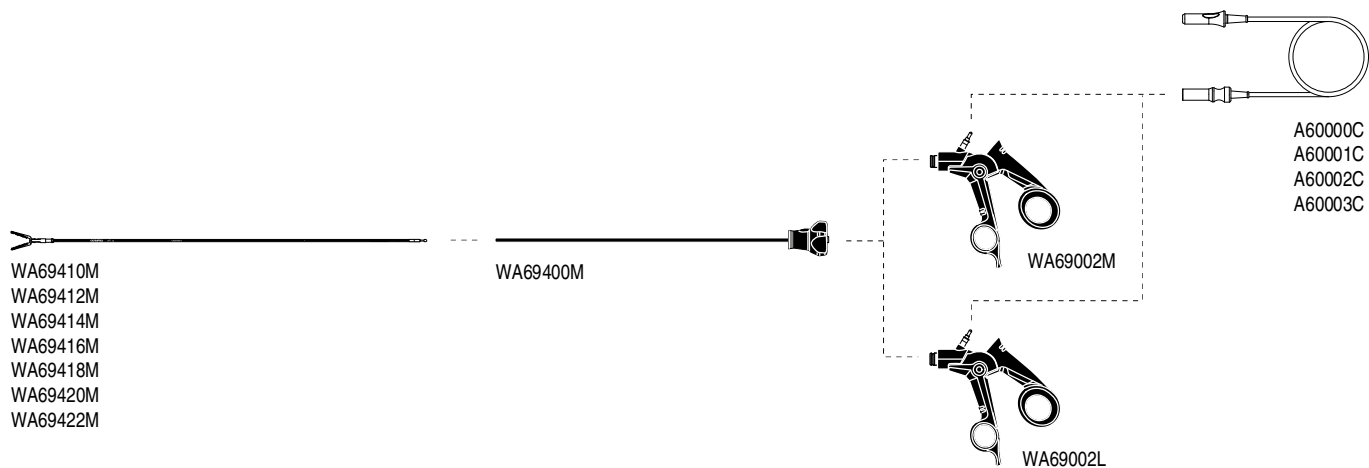

HiQ+ Bipolar

Bipolar Hand Instruments



Design
Award
Winner
2009

The Olympus HiQ+ Bipolar series combines the safety benefits of bipolar technology with the precision and tactility of monopolar hand instruments. HiQ+ Bipolar hand instruments are designed for safe and reliable coagulation with the ability of strong grasping and dissecting.

The HiQ+ Bipolar series – a new standard for:

- Gynecology
- General Surgery
- Urology



- **Reliable coagulation:**
HiQ+ Bipolar is designed for reliable coagulation even in challenging situations. Coagulation of small vessels or stopping of sudden bleedings where joints may become covered with blood can be performed smoothly and reliably thanks to the unique joint insulation.

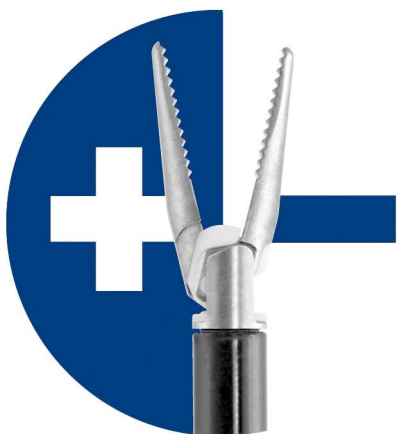

- **Bipolar safety:**
Bipolar instruments are known to be safer than monopolar devices as the electrical current flows directly between the instrument jaws, thus eliminating the need for a patient plate. Better control through focussed current flow within the surgeon's direct field of view. Reduces the risk of unpredictable current flow through the patient's body. Eliminates risk of injuries through malpositioning of the patient plate.



- **Strong grasping and dissection:**
Just as their monopolar counterparts, HiQ+ Bipolar instruments are designed for high performance during grasping and dissecting – but with bipolar safety. HiQ+ Bipolar replaces monopolar instruments even in procedures where strong grasping is required.



- **Easy reprocessing:**
The modular three part design and the "easy click" mechanism of HiQ+ Bipolar instruments allow easy assembly and disassembly. HiQ+ Bipolar instruments are autoclavable to meet high demands regarding sterilisation and disinfection.

HiQ+ Bipolar Grasping Forceps



- Johann forceps:
multipurpose forceps for strong grasping and atraumatic dissection for all laparoscopic procedures



- Hirsch forceps:
for tubal sterilization and endometriosis treatment

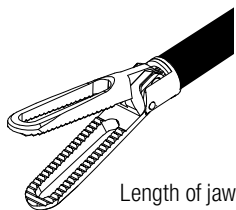

- Manhes forceps:
grasping forceps for myomectomy and cystectomy

Johann Forceps

Length of jaws: 16.5 mm

WA63120C	Grasping forceps "HiQ+", bipolar, 5 x 330 mm, fenestrated, Ergo
WA63121C	Grasping forceps "HiQ+", bipolar, 5 x 430 mm, fenestrated, Ergo, long

Components

WA64120C	Jaws "HiQ+", bipolar, 5 x 330 mm, grasping forceps, fenestrated
WA64121C	Jaws "HiQ+", bipolar, 5 x 430 mm, grasping forceps, fenestrated, long
WA60800C	Shaft "HiQ+", bipolar, 5 x 330 mm, isolated
WA60801C	Shaft "HiQ+", bipolar, 5 x 430 mm, insulated, long
WA60101C	Handle "HiQ+", Ergo, bipolar

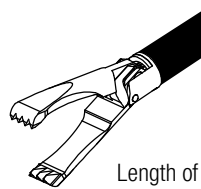
Manhes Forceps

Length of jaws: 14 mm

WA63050C	Grasping forceps "HiQ+", bipolar, 5 x 330 mm, Manhes, Ergo
WA63051C	Grasping forceps "HiQ+", bipolar, 5 x 430 mm, Manhes, Ergo, long

Components

WA64050C	Jaws "HiQ+", bipolar, 5 x 330 mm, grasping forceps, Manhes
WA64051C	Jaws "HiQ+", bipolar, 5 x 430 mm, grasping forceps, Manhes, long
WA60800C	Shaft "HiQ+", bipolar, 5 x 330 mm, isolated
WA60801C	Shaft "HiQ+", bipolar, 5 x 430 mm, insulated, long
WA60101C	Handle "HiQ+", Ergo, bipolar

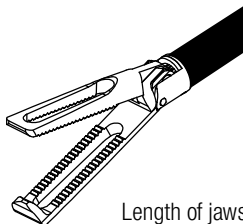
Hirsch Forceps

Length of jaws: 19.7 mm

WA63200C	Grasping forceps "HiQ+", bipolar, 5 x 330 mm, Hirsch, Ergo
WA63201C	Grasping forceps "HiQ+", bipolar, 5 x 430 mm, Hirsch, Ergo, long

Components

WA64200C	Jaws "HiQ+", bipolar, 5 x 330 mm, grasping forceps, Hirsch
WA64201C	Jaws "HiQ+", bipolar, 5 x 430 mm, grasping forceps, Hirsch, long
WA60800C	Shaft "HiQ+", bipolar, 5 x 330 mm, isolated
WA60801C	Shaft "HiQ+", bipolar, 5 x 430 mm, insulated, long
WA60101C	Handle "HiQ+", Ergo, bipolar

HiQ+ Bipolar Dissection Forceps



- Maryland forceps:
multipurpose curved dissection forceps for all laparoscopic procedures



- Fine Maryland forceps:
Due to increased branch length the jaws allow improved overview and handling. Suitable for kidney resection and adrenalectomy.



- Straight forceps:
multipurpose straight dissection forceps for all laparoscopic procedures

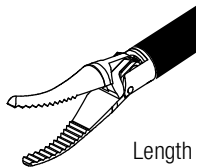

- Tweezers:
for very delicate dissection and coagulation

Maryland Forceps

Length of jaws: 14.7 mm

WA63320C	Preparation forceps "HiQ+", bipolar, 5 x 330 mm, Maryland, short, Ergo
WA63321C	Dissection forceps "HiQ+", bipolar, 5 x 430 mm, Maryland, Ergo, long

Components

WA64320C	Jaws "HiQ+", bipolar, 5 x 330 mm, preparation forceps, Maryland, short
WA64321C	Jaws "HiQ+", bipolar, 5 x 430 mm, dissection forceps, Maryland, long
WA60800C	Shaft "HiQ+", bipolar, 5 x 330 mm, isolated
WA60801C	Shaft "HiQ+", bipolar, 5 x 430 mm, insulated, long
WA60101C	Handle "HiQ+", Ergo, bipolar

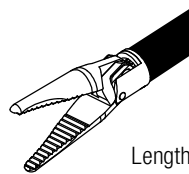
Straight Forceps

Length of jaws: 12.7 mm

WA63310C	Preparation forceps "HiQ+", bipolar, 5 x 330 mm, straight, Ergo
WA63311C	Dissection forceps "HiQ+", bipolar, 5 x 430 mm, straight, Ergo, long

Components

WA64310C	Jaws "HiQ+", bipolar, 5 x 330 mm, preparation forceps, straight
WA64311C	Jaws "HiQ+", bipolar, 5 x 430 mm, dissection forceps, straight, long
WA60800C	Shaft "HiQ+", bipolar, 5 x 330 mm, isolated
WA60801C	Shaft "HiQ+", bipolar, 5 x 430 mm, insulated, long
WA60101C	Handle "HiQ+", Ergo, bipolar

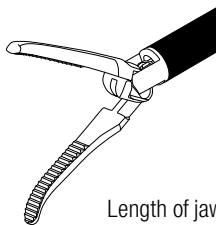
Fine Maryland Forceps

Length of jaws: 19 mm

WA63360C	Dissection forceps "HiQ+", bipolar, 5 x 330 mm, Maryland, Ergo
WA63361C	Dissection forceps "HiQ+", bipolar, 5 x 430 mm, Maryland, Ergo

Components

WA64360C	Jaws "HiQ+", bipolar, 5 x 330 mm, dissection forceps, Maryland
WA64361C	Jaws "HiQ+", bipolar, 5 x 430 mm, dissection forceps, Maryland
WA60800C	Shaft "HiQ+", bipolar, 5 x 330 mm, isolated
WA60801C	Shaft "HiQ+", bipolar, 5 x 430 mm, insulated, long
WA60101C	Handle "HiQ+", Ergo, bipolar

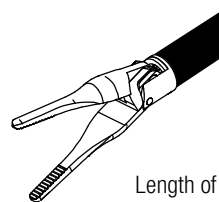
Tweezers

Length of jaws: 17.2 mm

WA63210C	Grasping forceps "HiQ+", bipolar, 5 x 330 mm, tweezers, Ergo
WA63211C	Grasping forceps "HiQ+", bipolar, 5 x 430 mm, tweezers, Ergo, long

Components

WA64210C	Jaws "HiQ+", bipolar, 5 x 330 mm, grasping forceps, tweezers
WA64211C	Jaws "HiQ+", bipolar, 5 x 430 mm, grasping forceps, tweezers, long
WA60800C	Shaft "HiQ+", bipolar, 5 x 330 mm, isolated
WA60801C	Shaft "HiQ+", bipolar, 5 x 430 mm, insulated, long
WA60101C	Handle "HiQ+", Ergo, bipolar

HiQ+ Bipolar

Accessories and Spare Parts

HiQ+ Bipolar Ergo Handle



WA60101C Handle "HiQ+", Ergo, bipolar

HiQ+ Bipolar Shaft

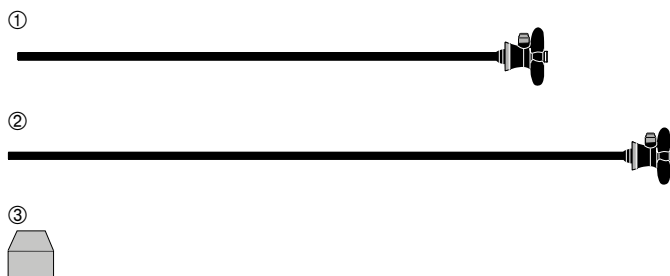

- ① **WA60800C** Shaft "HiQ+", bipolar, 5 x 330 mm, isolated
- ② **WA60801C** Shaft "HiQ+", bipolar, 5 x 430 mm, insulated, long
- ③ **A03441A** Spare-button "HiQ+", for shaft, 10 pcs.

Bipolar HF Cable



- A60003C** HF-cable "HiQ+", bipolar, 3.5 m, for Valleylab HF units
- A60001C** HF-cable "HiQ+", bipolar, 3.5 m, for Olympus UES HF unit
- A60002C** HF-cable "HiQ+", bipolar, 3.5 m, for Martin, Berchthold HF unit
- A60000C** HF-cable "HiQ+", bipolar, 3.5 m, for Erbe HF unit

Surgery

System Chart

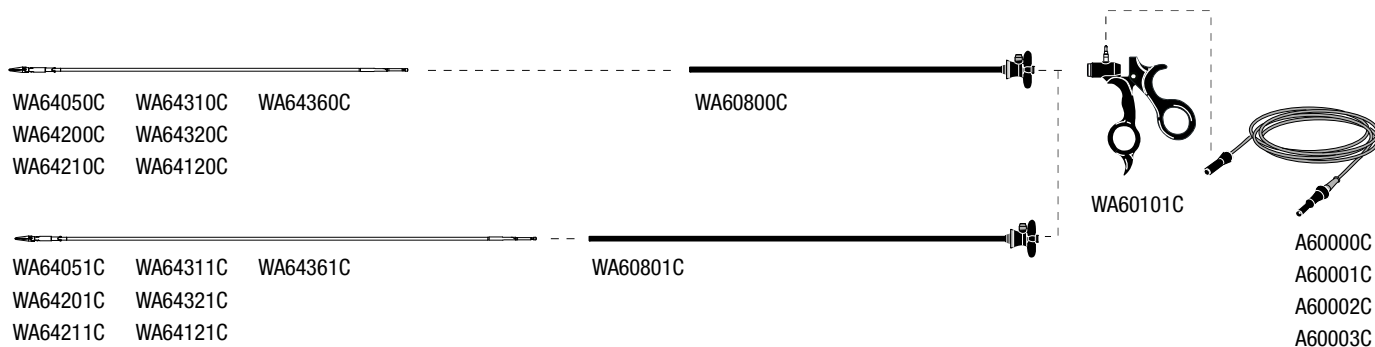



HiQ+

Needle Holders



Surgery

Baden-Württemberg
International Design Award 2004



GOOD DESIGN
AWARD 2005



Design
Award
Winner
2006



red dot design award
winner 2006



HiQ+ needle holders and knot pushers are a series of instruments designed to satisfy the most exacting requirements when it comes to functionality, ergonomics and up-to-date reprocessing. HiQ+ needle holders are engineered for:

- High grasping strength
- High accuracy to ensure precise and reliable control of the needle
- High durability with hard-metal inlays in the jaws



Exchangeable jaws inserts: The HiQ+ needle holder is available with three interchangeable jaws. The modular design allows for easy assembly, disassembly, and cleaning. All parts are autoclavable.

- Straight needle holder
- Curved needle holder
- Self-alignment needle holder



- The handle of the HiQ+ needle holder has been optimized from an ergonomic perspective. Olympus engineers have worked closely with ergonomics experts to design a handle that will be "an extension of the surgeon's hand".



- HiQ+ design knot pusher (see page [417](#))

HiQ+

Needle Holders

(cont.)

Straight Needle Holders

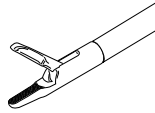

WA63708A	Grasping forceps "HiQ+", 5 x 330 mm, needle holder, straight, inline A
WA63708L	Grasping forceps "HiQ+", 5 x 430 mm, needle holder, straight

Components

WA64700A	Jaws "HiQ+", 5 x 330 mm, needle holder, straight
WA64700L	Jaws "HiQ+", 5 x 430 mm, needle holder, straight
WA60120A	Handle "HiQ+", inline A, asymmetric, ratchet
WA60120L	Handle "HiQ+", inline A, long, asymmetric, ratchet

Right-Curved Needle Holders

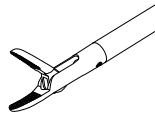

WA63748A	Grasping forceps "HiQ+", 5 x 330 mm, needle holder, right curved
WA63748L	Grasping forceps "HiQ+", 5 x 430 mm, needle holder, right curved

Components

WA64740A	Jaws "HiQ+", 5 x 330 mm, needle holder, right curved
WA64740L	Jaws "HiQ+", 5 x 430 mm, needle holder, right curved
WA60120A	Handle "HiQ+", inline A, asymmetric, ratchet
WA60120L	Handle "HiQ+", inline A, long, asymmetric, ratchet

Dolphin Type Needle Holder

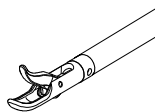

WA63738A	Grasping forceps "HiQ+", 5 x 330 mm, needle holder, dolphin type, inline A
-----------------	--

Components

WA64730A	Jaws "HiQ+", 5 x 330 mm, needle holder, dolphin type
WA60120A	Handle "HiQ+", inline A, asymmetric, ratchet

Left-Curved Needle Holders

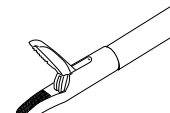

WA63718A	Grasping forceps "HiQ+", 5 x 330 mm, needle holder, curved, inline A
WA63718L	Grasping forceps "HiQ+", 5 x 430 mm, needle holder, curved left

Components

WA64710A	Jaws "HiQ+", 5 x 330 mm, needle holder, curved
WA64710L	Jaws "HiQ+", 5 x 430 mm, needle holder, curved left
WA60120A	Handle "HiQ+", inline A, asymmetric, ratchet
WA60120L	Handle "HiQ+", inline A, long, asymmetric, ratchet

Self-Alignment Needle Holders

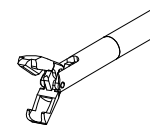

WA63728A	Grasping forceps "HiQ+", 5 x 330 mm, needle holder, self-aligning, inline A
-----------------	---

Components

WA64720A	Jaws "HiQ+", 5 x 330 mm, needle holder, self-aligning
WA60120A	Handle "HiQ+", inline A, asymmetric, ratchet

Assistant Needle Holders

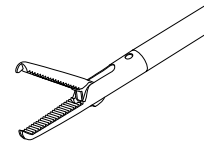

WA63758A	Grasping forceps "HiQ+", 5 x 330 mm, assistant needle holder, Inline A
-----------------	--

Components

WA64750A	Jaws "HiQ+", 5 x 330 mm, assistant needle holder
WA60120A	Handle "HiQ+", inline A, asymmetric, ratchet

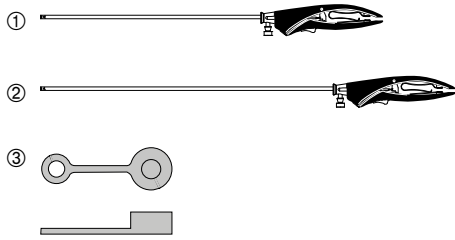
HiQ+ Inline A Handles

- ① **WA60120A** Handle, with sheath, 330 mm, ratchet
- ② **WA60120L** Handle, with sheath, 430 mm, ratchet
- ③ **A0400** Sealing cap, blue, for Luer-lock, 6 pcs.

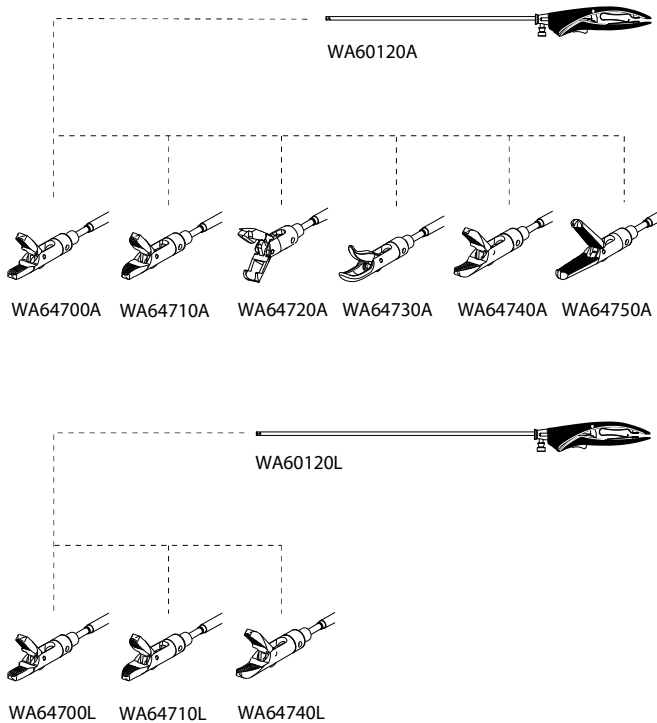
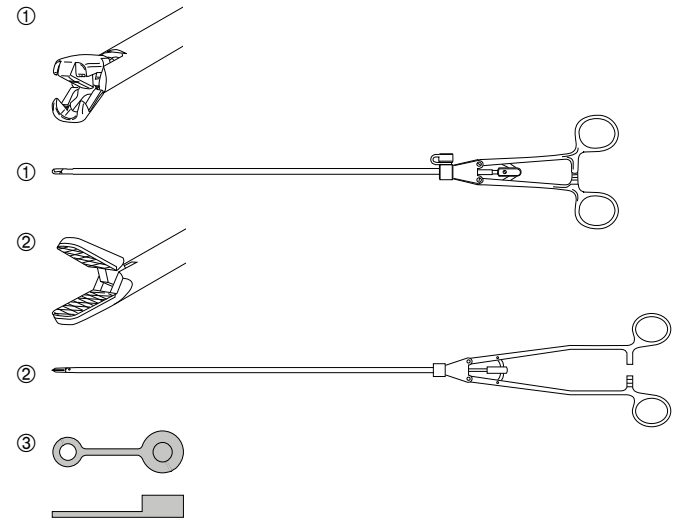
System Chart HiQ+ Needle Holders

Standard Needle Holders

- ① **WA56900A** Grasping forceps, needle holder, with self-alignment, 5 x 330 mm, straight
- ② **A5690** Grasping forceps, needle holder, 5 x 300 mm, inline handle
- A5698** Grasping forceps, needle holder, 5 x 300 mm, curved, inline
- WA56090L** Grasping forceps, needle holder, 5 x 390 mm, inline handle
- WA56098L** Grasping forceps, needle holder, 5 x 390 mm, curved, inline
- ③ **A0400** Sealing cap, blue, for Luer-lock, 6 pcs.

HICURA

Suture, Clip Application

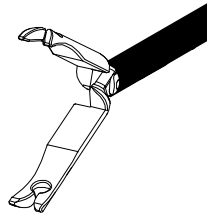
HICURA Knot Pusher



Components

WA69380M	Jaws insert "HICURA", 5 x 330, knot pusher
WA69300M	Shaft "HICURA", 5 x 330, monopolar
WA69000M	Handle "HICURA", size M, deactivatable ratchet
WA69000L	Handle "HICURA", size L, deactivatable ratchet
WA69001M	Handle "HICURA", size M, monopolar
WA69001L	Handle "HICURA", size L, monopolar
WA69003M	Handle "HICURA", size M, ratchet
WA69003L	Handle "HICURA", size L, ratchet

HICURA Roeder Knot Pusher

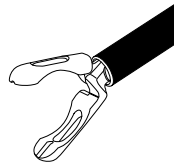

Components

WA69382M	Jaws insert "HICURA", 5 x 330, Roeder
WA69300M	Shaft "HICURA", 5 x 330, monopolar
WA69000M	Handle "HICURA", size M, deactivatable ratchet
WA69000L	Handle "HICURA", size L, deactivatable ratchet
WA69001M	Handle "HICURA", size M, monopolar
WA69001L	Handle "HICURA", size L, monopolar
WA69003M	Handle "HICURA", size M, ratchet
WA69003L	Handle "HICURA", size L, ratchet

HICURA Assistant Needle Holder

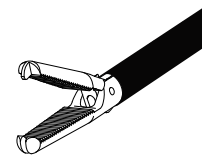

Components

WA69384M	Jaws insert "HICURA", 5 x 330, assistant needle holder
WA69384S	Jaws insert "HICURA", 5 x 250, assistant needle holder
WA69384L	Jaws insert "HICURA", 5 x 430, assistant needle holder
WA69300M	Shaft "HICURA", 5 x 330, monopolar
WA69300S	Shaft "HICURA", 5 x 250, monopolar
WA69300L	Shaft "HICURA", 5 x 430, monopolar
WA69000M	Handle "HICURA", size M, deactivatable ratchet
WA69000L	Handle "HICURA", size L, deactivatable ratchet
WA69001M	Handle "HICURA", size M, monopolar
WA69001L	Handle "HICURA", size L, monopolar
WA69003M	Handle "HICURA", size M, ratchet
WA69003L	Handle "HICURA", size L, ratchet

Standard Knot Pusher

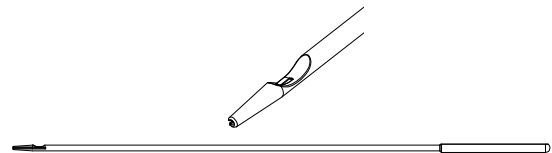

WA56903A	Knot pusher, 5 x 330 mm
-----------------	----------------------------

For accessories and spare parts of HICURA hand instruments, see page 369.

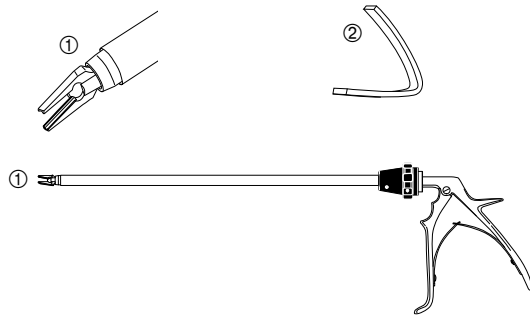
Application of Titanium Clips

- ① **A56790A** Clip applicator, 10 x 330 mm, for clips medium/large A5635
- Curved
 - Rotatable jaws
 - Can be disassembled for reprocessing.
- ② **A5635** Clip, titanium, medium/large, 18 x 6 pcs.

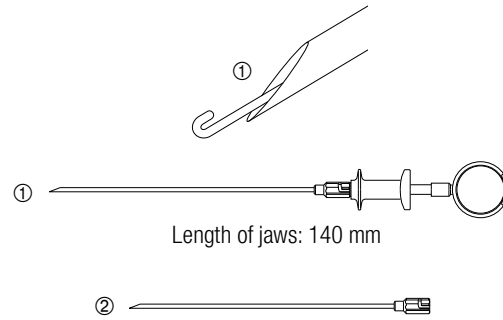
Fascial Closure

- ① **WA51203A** Needle, for fascial closure
- ② **WA51205A** Spare cannula, for WA51203A

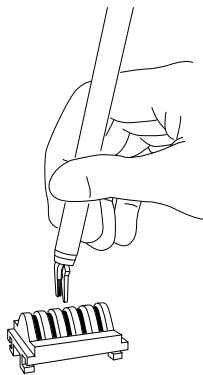
Use

Remove clip from the magazine.

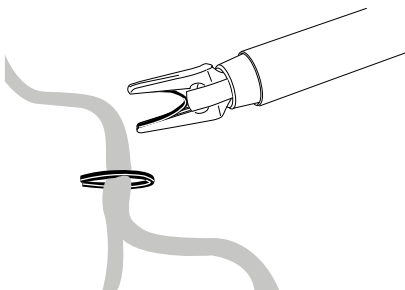

Apply clip.

HiQ+

Suction and Irrigation



Surgery

The HiQ+ suction/irrigation system is optimized for streamlined flow throughout every component, from inflow to outflow, thus enabling better passage of immersed blood clots or stones.

The modular system with its range of suction/irrigation tubes offers tailored solutions for a variety of laparoscopic procedures and anatomies.

The HiQ suction/irrigation system combines excellent performance with surgeon-oriented ergonomics and high-end quality.

Customizable system: Olympus offers a wide range of suction/irrigation tubes for its HiQ+ system:

- Diameters of 3, 5 and 10 mm
- Working lengths of 360 and 450 mm
- Multiple tip designs, e.g. for harvesting lost gall bladder stones or aspirating hydrops



Optimized ergonomics – choice of two ergonomically designed handles for differing irrigation needs:

- Active handle with lever-controlled suction/irrigation at your finger tips
- Passive handle for foot switch control in combination with pumps



- Simple reprocessing: The HiQ+ suction/irrigation system has been designed to simplify assembly/disassembly and cleaning. Every component is easily detachable and autoclavable.



HiQ+

Suction and Irrigation (cont.)

Standard Suction/Irrigation System

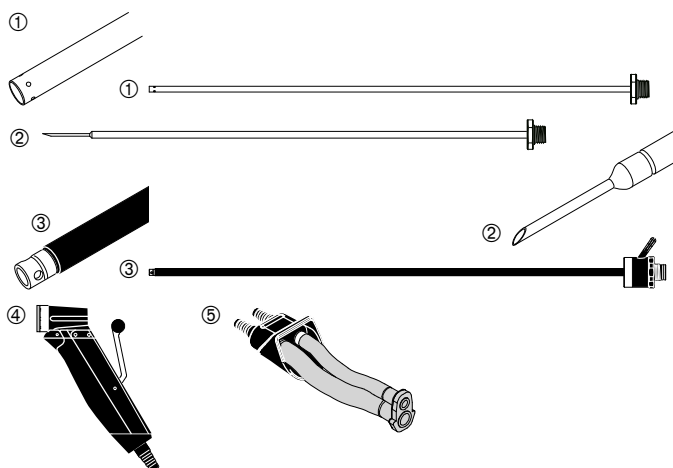

- ① **WA51111A** Suction/irrigation tube , 3 x 360 mm, distal holes, for HiQ+ handle
- WA51131A** Suction/irrigation tube, 5 x 360 mm, distal holes, for HiQ+ handle
- WA51131L** Suction/irrigation tube, 5 x 450 mm, distal holes, for HiQ+ handle
- ② **WA51132A** Suction/irrigation tube, 5 x 360 mm, for aspiration, for HiQ+ handle
- ③ **WA51138A** Suction/irrigation tube, 5 x 360 mm, button, unipolar, for HiQ+ handle
- ④ **WA51172S** Handle "HiQ+", for suction/irrigation tube, valve, suction channel 5 mm
Delivery includes: WA51172A and WA51181S.
To be used with pressure controlled roller pumps.
- WA51172A** Handle "HiQ+" (spare, not shown), for suction/irrigation tube, valve
- ⑤ **WA51181S** Valve tubing (spare), for HiQ+ handle, suction channel 5 mm, 1 pc.

Large Diameter Suction/Irrigation System

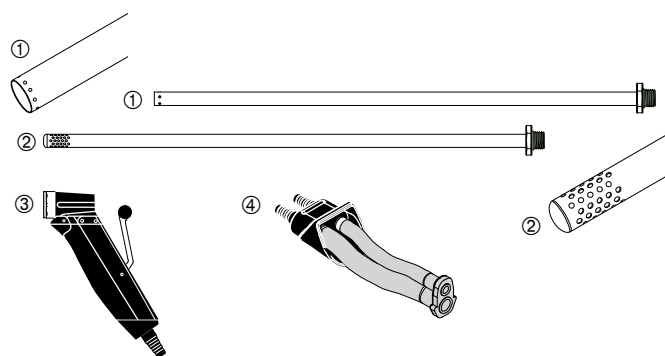

- ① **WA51151A** Suction/irrigation tube, distal holes, for HiQ+ handle, 10 x 360 mm
- WA51151L** Suction/irrigation tube, distal holes, for HiQ+ handle, 10 x 450 mm
- ② **WA51152A** Suction/irrigation tube, 10 x 360 mm, safety basket, for HiQ+ handle
- ③ **WA51172L** Handle "HiQ+", for suction/irrigation tube, valve, suction channel 8 mm
Delivery includes: WA51172A and WA51181L.
To be used with pressure controlled roller pumps.
- WA51172A** Handle "HiQ+" (spare, not shown), for suction/irrigation tube, valve
- ④ **WA51181L** Valve tubing (spare), for HiQ+ handle, suction channel 8 mm, 1 pc.

System Chart

WA51111A

WA51131A

WA51131L

WA51132A

 A0355
A0357
A0358

WA51138A

WA51151A

WA51151L

WA51152A

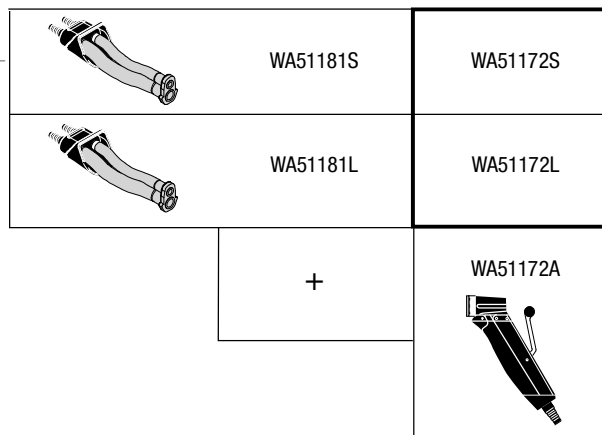
 Pressure
controlled
roller pump

Surgery

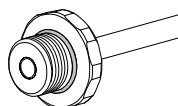
Spare Parts

WA51187A Sealing ring, for HiQ+ suction/irrigation tube,
10 pcs., small

WA51188A Sealing ring, for HiQ+ suction/irrigation tube,
10 pcs., large

Lavage

Instruments for Lavage

Modular Suction/Irrigation Instrument

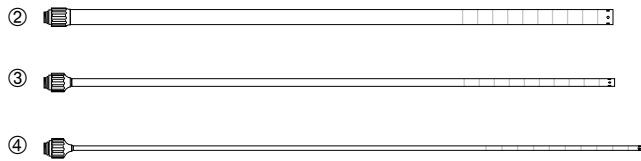

- | | | |
|---|--------------|--|
| ① | A5796 | Handle,
for suction/irrigation tube |
| ② | A5797 | Suction/irrigation tube,
10 mm, for A5796 |
| ③ | A5798 | Suction/irrigation tube,
5 mm, for A5796 |
| ④ | A5799 | Suction/irrigation tube,
3 mm, for A5796 |

Tubings

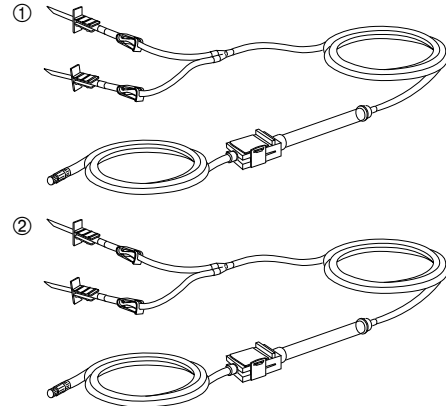

- | | | |
|---|--------------|---|
| ① | A4054 | Tubing, set, for 2 bags, for single use, 10 pcs.
▪ Sterile |
| ② | A4055 | Tubing, set, for 2 bags, 1 pc.
▪ Non-sterile, reusable |



HiQ+

HF Electrodes

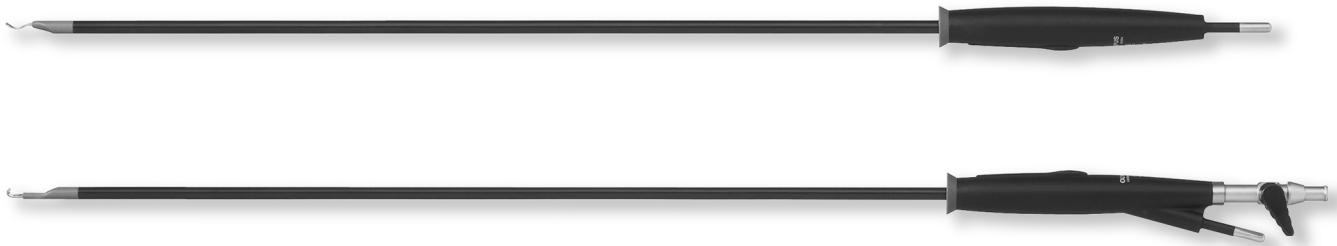

Surgery

**Baden-Württemberg
International Design Award 2004**



reddot design award
winner 2000



Design
Award
Winner
2000

- Ceramic tip
- With or without inline suction channel
- Ergonomic design
- Cost effective thanks to high durability
- UHI-4/UHI-3 addition for automatic suction

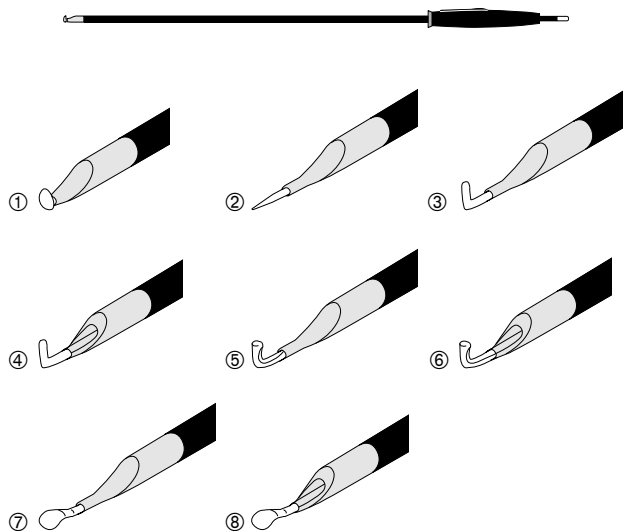
HiQ+ HF Electrodes

- | | | |
|---|--------------|---|
| ① | A6280 | HF electrode, button, 5 x 330 mm |
| ② | A6281 | HF electrode, needle, 5 x 330 mm |
| ③ | A6282 | HF electrode, hook, 5 x 330 mm |
| ④ | A6292 | HF electrode, hook, with suction channel, 5 x 330 mm |
| ⑤ | A6283 | HF electrode, hook long, 5 x 330 mm |
| | A6289 | HF electrode, hook long, 5 x 400 mm |
| ⑥ | A6293 | HF electrode, hook long, with suction channel, 5 x 330 mm |
| | A6299 | HF electrode, hook long, with suction channel, 5 x 400 mm |
| ⑦ | A6284 | HF electrode, spoon, 5 x 330 mm |
| ⑧ | A6294 | HF electrode, spoon, with suction channel, 5 x 330 mm |

With 4 mm HF pin.

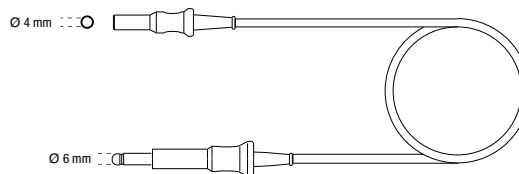
HF Cables

- | | |
|--------------|---|
| A0358 | HF cable, monopolar, 3.5 m length, for UES-40/-30, Erbe International and Valleylab (new) |
| A0355 | HF cable, monopolar, 3.5 m length, for UES-10/-20 and Valleylab (old) |
| A0357 | HF cable, monopolar, 3.5 m length, for Erbe T series, Martin, and Berchtold |