

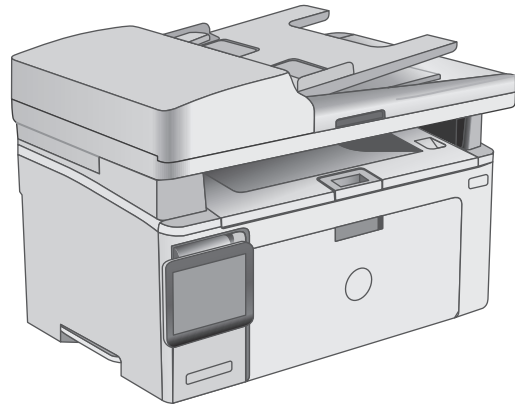

LaserJet Pro MFP M129-M132, LaserJet Ultra MFP M133-M134

User Guide

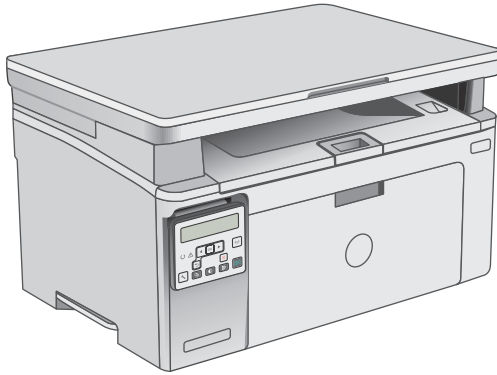

M129-M134



www.hp.com/support/ljM129MFP



HP LaserJet Pro MFP M129-M132, LaserJet Ultra MFP M133-M134

User Guide

Copyright and License

© Copyright 2016 HP Development Company, L.P.

Reproduction, adaptation, or translation without prior written permission is prohibited, except as allowed under the copyright laws.

The information contained herein is subject to change without notice.

The only warranties for HP products and services are set forth in the express warranty statements accompanying such products and services. Nothing herein should be construed as constituting an additional warranty. HP shall not be liable for technical or editorial errors or omissions contained herein.

Edition 2, 01/2019

Trademark Credits

Adobe®, Adobe Photoshop®, Acrobat®, and PostScript® are trademarks of Adobe Systems Incorporated.

Apple and the Apple logo are trademarks of Apple Inc., registered in the U.S. and other countries.

OS X is a trademark of Apple Inc., registered in the U.S. and other countries.

AirPrint is a trademark of Apple Inc., registered in the U.S. and other countries.

Microsoft®, Windows®, Windows® XP, and Windows Vista® are U.S. registered trademarks of Microsoft Corporation.

Table of contents

1 Printer overview	1
Printer views	2
Printer front view	2
Printer back view	3
Interface ports	3
LED control-panel view (M130a, M132a, M133a, M134a models)	4
2-line LCD control-panel view (M130nw, M132nw, M132snw models)	5
2-line LCD control-panel view (M130fn, M132fn, M132fp, M133fn, M134fn models)	6
Touchscreen control panel view (M130fw, M132fw models)	8
Home screen layout	9
How to use the touchscreen control panel	10
Printer specifications	11
Technical specifications	11
Supported operating systems	12
Mobile printing solutions	13
Printer dimensions	14
Power consumption, electrical specifications, and acoustic emissions	15
Operating-environment range	15
Printer hardware setup and software installation	16
2 Paper trays	17
Load the input tray	18
Introduction	18
Load paper into the input tray	18
Load and print envelopes	21
Introduction	21
Print envelopes	21
Envelope orientation	21
3 Supplies, accessories, and parts	23
Order supplies, accessories, and parts	24

Ordering	24
Supplies and accessories	24
Customer self-repair parts	24
Configure the HP toner-cartridge-protection supply settings	26
Introduction	26
Enable or disable the Cartridge Policy feature	26
Enable the feature on 2-line and touchscreen control panel models	26
Disable the feature on 2-line and touchscreen control panel models	26
Use the HP Embedded Web Server (EWS) to enable the Cartridge Policy feature	27
Use the HP Embedded Web Server (EWS) to disable the Cartridge Policy feature	27
Troubleshoot Cartridge Policy control panel or EWS error messages	28
Enable or disable the Cartridge Protection feature	28
Enable the feature on 2-line and touchscreen control panel models	28
Disable the feature on 2-line and touchscreen control panel models	29
Use the HP Embedded Web Server (EWS) to enable the Cartridge Protection feature	29
Use the HP Embedded Web Server (EWS) to disable the Cartridge Protection feature	30
Troubleshoot Cartridge Protection control panel or EWS error messages	31
Replace the toner cartridge	32
Introduction	32
Toner-cartridge and imaging-drum information	32
Replace the toner cartridge (M129-M132 models)	33
Replace the toner cartridge (M133-M134 models)	35
Replace the imaging drum (M129-M132 models)	38
Replace the imaging drum (M133-M134 models)	41
4 Print	45
Print tasks (Windows)	46
How to print (Windows)	46
Manually print on both sides (Windows)	47
Print multiple pages per sheet (Windows)	47
Select the paper type (Windows)	48
Additional print tasks	49
Print tasks (OS X)	50
How to print (OS X)	50
Manually print on both sides (OS X)	50
Print multiple pages per sheet (OS X)	50
Select the paper type (OS X)	51
Additional print tasks	52
Mobile printing	53

Introduction	53
Wi-Fi Direct (wireless models only)	53
Enable or disable Wi-Fi Direct	55
Change the printer Wi-Fi Direct name	56
HP ePrint via email	57
HP ePrint software	58
AirPrint	59
Android embedded printing	59

5 Copy 61

Make a copy	62
Copy on both sides (duplex)	64
Copy on both sides manually	64
Additional copy tasks	65

6 Scan 67

Scan by using the HP Scan software (Windows)	68
Scan by using the HP Easy Scan software (OS X)	69
Set up the Scan to E-mail feature (touchscreen models only)	70
Introduction	70
Before you begin	70
Method one: Use the Scan to Email Wizard (Windows)	70
Method two: Set up the Scan to Email feature via the HP Embedded Web Server (Windows)	72
Step one: Access the HP Embedded Web Server (EWS)	72
Step two: Configure the Scan to E-mail feature	72
Step three: Add contacts to the E-mail Address Book	74
Step four: Configure the default E-mail Options	74
Set up the Scan to E-mail feature on a Mac	75
Step one: Access the HP Embedded Web Server (EWS)	75
Method one: Use a web browser to open the HP Embedded Web Server (EWS)	75
Method two: Use the HP Utility to open the HP Embedded Web Server (EWS)	75
Step two: Configure the Scan to E-mail feature	75
Step three: Add contacts to the E-mail Address Book	77
Step four: Configure the default E-mail Options	77
Set up the Scan to Network Folder feature (touchscreen models only)	79
Introduction	79
Before you begin	79
Method one: Use the Scan to Network Folder Wizard (Windows)	79

Method two: Set up the Scan to Network Folder feature via the HP Embedded Web Server (Windows)	81
Step one: Access the HP Embedded Web Server (EWS)	81
Step two: Configure the Scan to Network Folder feature	82
Set up the Scan to Network Folder feature on a Mac	83
Step one: Access the HP Embedded Web Server (EWS)	83
Method one: Use a web browser to open the HP Embedded Web Server (EWS)	83
Method two: Use the HP Utility to open the HP Embedded Web Server (EWS)	83
Step two: Configure the Scan to Network Folder feature	83
Scan to email (touchscreen models only)	85
Scan to a network folder (touchscreen models only)	86
Additional scan tasks	87

7 Fax **89**

Set up to send and receive faxes	90
Before starting	90
Step 1: Identify the phone connection type	90
Step 2: Set up the fax	91
Dedicated phone line	91
Shared voice/fax line	92
Shared voice/fax line with an answering machine	93
Step 3: Configure the fax time, date, and header	94
HP Fax Setup Wizard	94
Printer control panel	95
HP Embedded Web Server (EWS) and HP Device Toolbox (Windows)	95
Step 4: Run a fax test	96
Send a fax	97
Fax from the flatbed scanner	97
Fax from the document feeder (document feeder models only)	98
Use speed dials and group-dial entries	98
Send a fax from the software	99
Send a fax from a third-party software program, such as Microsoft Word	99
Additional fax tasks	100

8 Manage the printer **101**

Use HP Web Services applications (touchscreen models only)	102
Change the printer connection type (Windows)	103
Advanced configuration with HP Embedded Web Server (EWS) and HP Device Toolbox (Windows)	104
Advanced configuration with HP Utility for OS X	108

Open HP Utility	108
HP Utility features	108
Configure IP network settings	110
Introduction	110
Printer sharing disclaimer	110
View or change network settings	110
Rename the printer on a network	111
Manually configure IPv4 TCP/IP parameters from the control panel	112
Link speed setting	113
Printer security features	115
Introduction	115
Assign or change the system password using the Embedded Web Server	115
Lock the formatter	116
Energy-conservation settings	117
Introduction	117
Print with EconoMode	117
Set the Sleep/Auto Off After Inactivity setting	118
Set the Shut Down After Inactivity delay and configure the printer to use 1 watt or less of power	119
Set the Delay Shut Down setting	120
Update the firmware	122
Method one: Update the firmware using the 2-line or touchscreen control panel	122
Method two: Update the firmware using the Firmware Update Utility	123

9 Solve problems 125

Customer support	126
Interpret control-panel light patterns (LED control panels only)	127
Control panel help system (touchscreen models only)	130
Restore the factory-set defaults	131
A “Cartridge is low” or “Cartridge is very low” message displays on the printer control panel or EWS	133
Change the “Very Low” settings	133
For printers with fax capability	134
Order supplies	135
Product does not pick up paper or misfeeds	136
Introduction	136
The printer does not pick up paper	136
The printer picks up multiple sheets of paper	137
The document feeder jams, skews, or picks up multiple sheets of paper	138
Clean the pickup rollers and separation pad in the document feeder	139
Clear paper jams	141
Introduction	141

Paper jam locations	141
Experiencing frequent or recurring paper jams?	141
Clear paper jams in the input tray	144
Clear paper jams in the toner-cartridge area	146
Clear paper jams in the output bin	149
Clear paper jams in the document feeder (document feeder models only)	152
Clean the ADF replaceable film assembly	155
Improve print quality	157
Introduction	157
Print from a different software program	157
Check the paper-type setting for the print job	157
Check the paper type setting (Windows)	157
Check the paper type setting (OS X)	157
Check toner-cartridge status	157
Clean the printer	159
Print a cleaning page	159
Visually inspect the toner cartridge and imaging drum	160
Check paper and the printing environment	160
Step one: Use paper that meets HP specifications	160
Step two: Check the environment	160
Check the EconoMode settings	161
Adjust print density	161
Improve copy and scan image quality	163
Introduction	163
Check the scanner glass for dirt and smudges	163
Check the paper settings	163
Optimize for text or pictures	165
Edge-to-edge copying	166
Clean the pickup rollers and separation pad in the document feeder	166
Improve fax image quality	168
Introduction	168
Check the scanner glass for dirt and smudges	168
Check the send-fax resolution settings	168
Check the error-correction settings	169
Check the fit-to-page setting	170
Clean the pickup rollers and separation pad in the document feeder	171
Send to a different fax machine	172
Check the sender's fax machine	172
Solve wired network problems	173
Introduction	173
Poor physical connection	173

The computer is using the incorrect IP address for the printer	173
The computer is unable to communicate with the printer	173
The printer is using incorrect link speed settings for the network	174
New software programs might be causing compatibility problems	174
The computer or workstation might be set up incorrectly	174
The printer is disabled, or other network settings are incorrect	174
Solve wireless network problems	175
Introduction	175
Wireless connectivity checklist	175
The printer does not print after the wireless configuration completes	176
The printer does not print, and the computer has a third-party firewall installed	176
The wireless connection does not work after moving the wireless router or printer	176
Cannot connect more computers to the wireless printer	176
The wireless printer loses communication when connected to a VPN	177
The network does not appear in the wireless networks list	177
The wireless network is not functioning	177
Perform a wireless network diagnostic test	177
Reduce interference on a wireless network	178
Solve fax problems	179
Introduction	179
Fax troubleshooting checklist	179
Solve general fax problems	180
Faxes are sending slowly	181
Fax quality is poor	182
Fax cuts off or prints on two pages	183

Index	185
--------------------	------------

1 Printer overview

- [Printer views](#)
- [Printer specifications](#)
- [Printer hardware setup and software installation](#)

For more information:

The following information is correct at the time of publication. For current information, see www.hp.com/support/ljM129MFP.

HP's all-inclusive help for the printer includes the following information:

- Install and configure
- Learn and use
- Solve problems
- Download software and firmware updates
- Join support forums
- Find warranty and regulatory information

Printer views

Printer front view

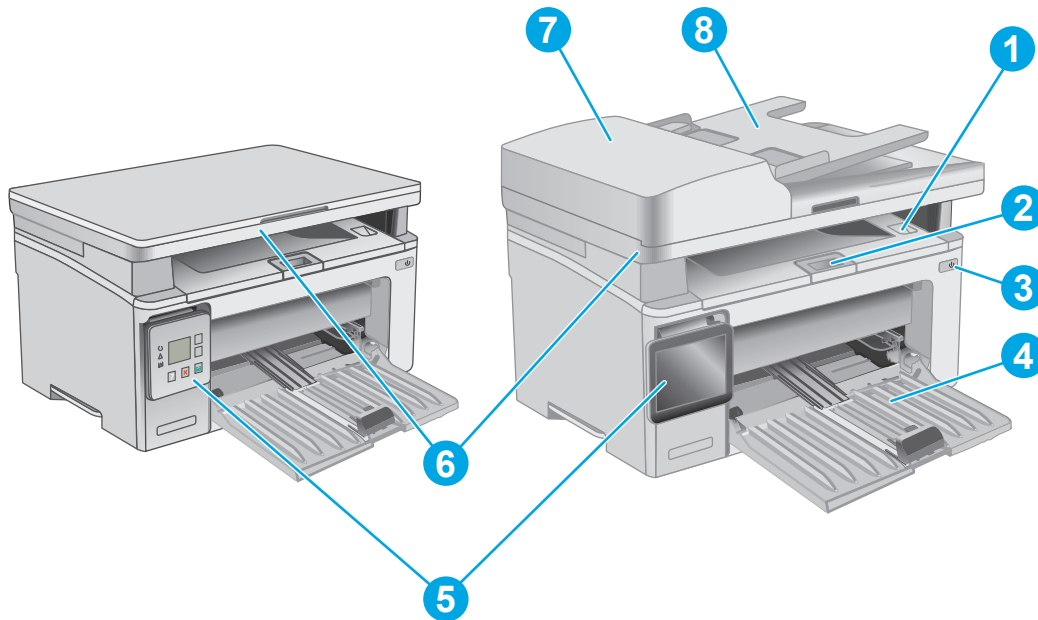

1	Output bin and top cover (toner cartridge access)
2	Output bin extension
3	Power on/off button
4	Input tray
5	Control panel (tilts up for easier viewing and type varies by model)
6	Scanner
7	Document feeder
8	Document feeder input tray

Printer back view

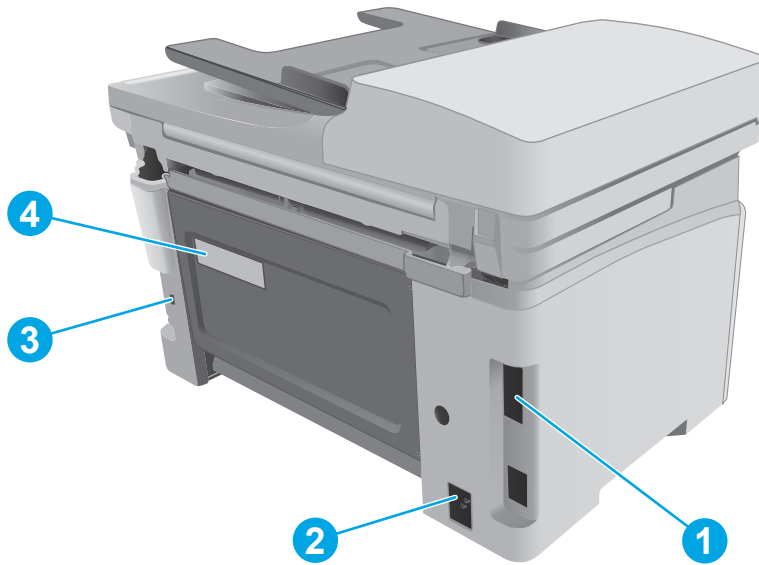

1	I/O ports
2	Power cable connector
3	Slot for cable-type security lock
4	Serial number and printer number label

Interface ports

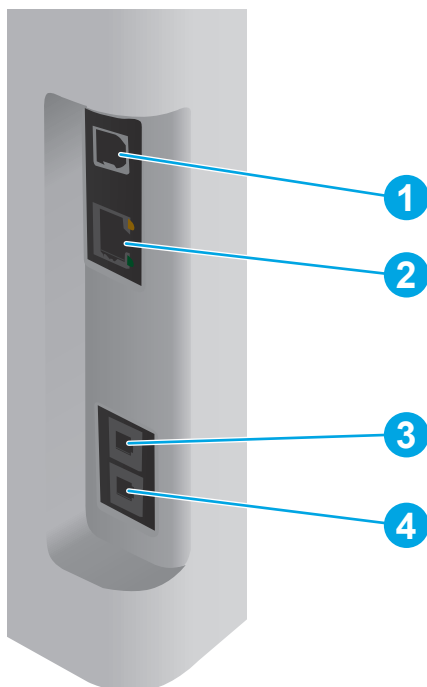





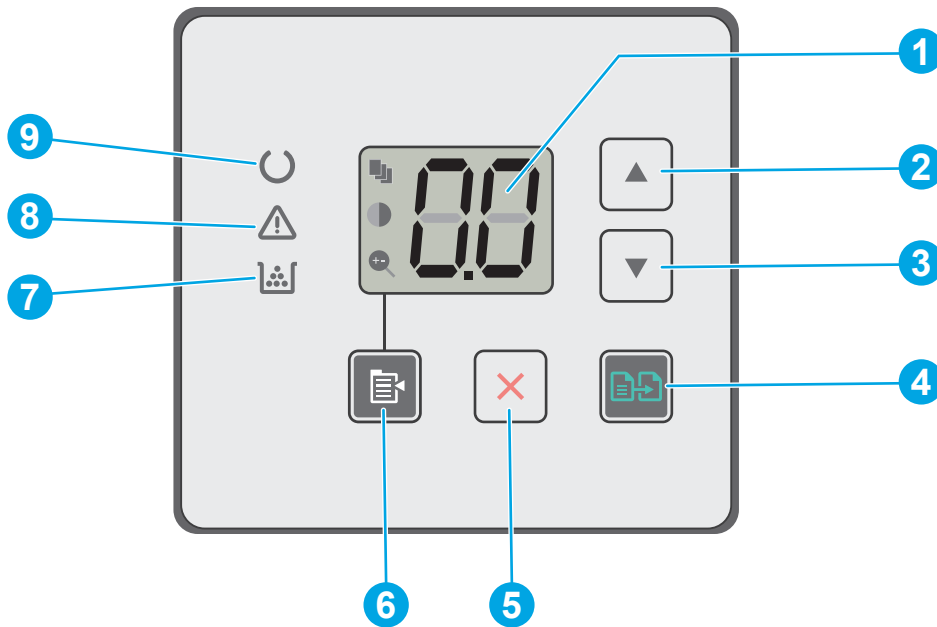

1	USB interface port
---	--------------------

2	Ethernet port (network models only)
3	Fax "line in" port for attaching the fax phone line to the product (fax models only)
4	Telephone "line out" port for attaching an extension phone, answering machine, or other device (fax models only)





LED control-panel view (M130a, M132a, M133a, M134a models)

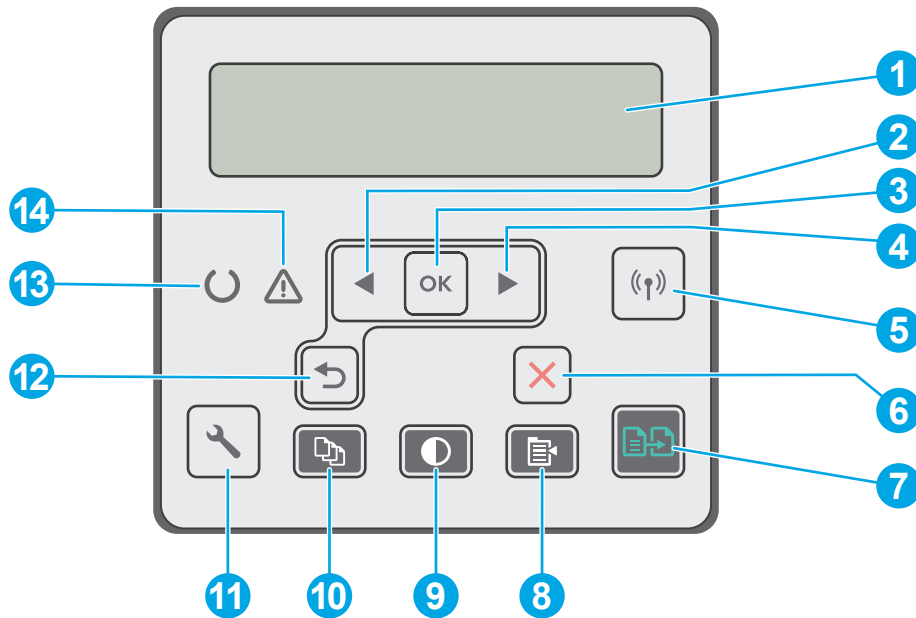

1	Control panel LED display	This screen displays numerical information for copy jobs.
2	Up arrow ▲ button	Use this button to increase the value that appears on the display.
3	Down arrow ▼ button	Use this button to decrease the value that appears on the display.
4	Start Copy  button	Press this button to start a copy job.
5	Cancel  button	Press this button to perform the following actions: <ul style="list-style-type: none"> • Cancel a print job when the printer is printing. • Reset the current copy settings to the default values when the printer is idle. • Exit Copy Default Setting mode without saving the value when the printer is in Copy Default Setting mode.
6	Copy Setup  button	Use this button to navigate through the Number of Copies, Lighter/Darker, and Reduce/Enlarge options. The default option is Number of Copies.
7	Supplies  LED	The Supplies light blinks when a supply error occurs, and it glows without blinking when the supply is very low and replacement is required.
8	Attention  LED	The Attention light blinks when the printer requires user attention, such as when the printer runs out of paper or a toner cartridge needs to be changed. If the light glows without blinking, the printer has experienced an error.
9	Ready  LED	The Ready light glows without blinking when the printer is ready to print. It blinks when the printer is receiving print data or canceling a print job.

2-line LCD control-panel view (M130nw, M132nw, M132snw models)









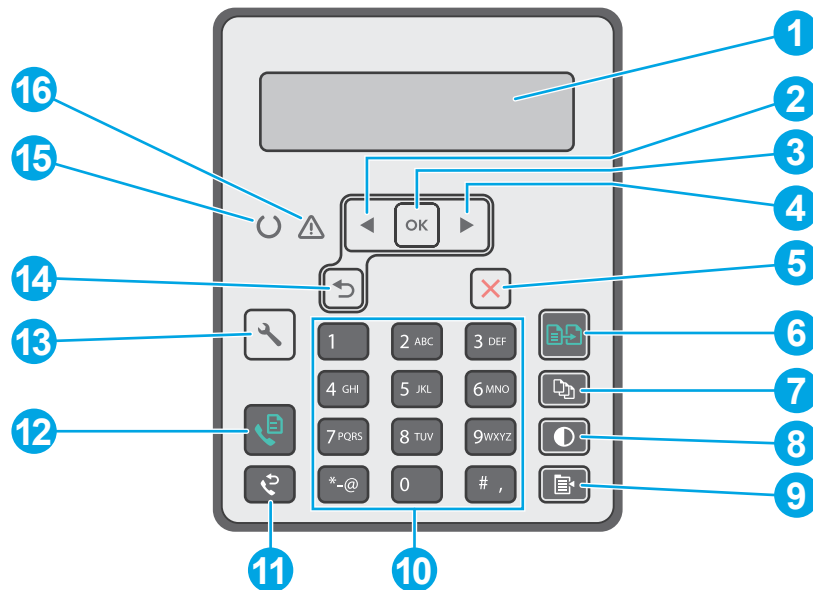





1	2-line control panel display	This screen displays menus and printer information.
2	Left arrow ◀ button	Use this button to navigate through the menus or to decrease a value that appears on the display.
3	OK button	Use the OK button for the following actions: <ul style="list-style-type: none"> • Open the control-panel menus. • Open a submenu displayed on the control-panel display. • Select a menu item. • Clear some errors. • Begin a print job in response to a control-panel prompt (for example, when the message Press [OK] to continue appears on the control-panel display).
4	Right arrow ▶ button	Use this button to navigate through the menus or to increase a value that appears on the display.
5	Wireless (⌘) button (wireless models only)	Use this button to navigate the open the Wireless menu and wireless status information.
6	Cancel ✕ button	Use this button to cancel a print job or to exit the control panel menus.
7	Start Copy  button	Use this button to start a copy job.
8	Copy Menu  button	Use this button to open the Copy menu.
9	Lighter/Darker  button	Use this button to lighten or darken copies.
10	Number of Copies  button	Use this button to set the number of copies to be produced.

11	Setup button	Use this button to open the Setup menu.
12	Back arrow button	Use this button for the following actions: <ul style="list-style-type: none"> • Exit the control-panel menus. • Scroll back to a previous menu in a submenu list. • Scroll back to a previous menu item in a submenu list (without saving changes to the menu item).
13	Ready LED	The Ready light glows without blinking when the printer is ready to print. It blinks when the printer is receiving print data or canceling a print job.
14	Attention LED	The Attention light blinks when the printer requires user attention, such as when the printer runs out of paper or a toner cartridge needs to be changed. If the light glows without blinking, the printer has experienced an error.

2-line LCD control-panel view (M130fn, M132fn, M132fp, M133fn, M134fn models)



1	2-line control panel display	This screen displays menus and printer information.
2	Left arrow button	Use this button to navigate through the menus or to decrease a value that appears on the display.
3	OK button	Use the OK button for the following actions: <ul style="list-style-type: none"> • Open the control-panel menus. • Open a submenu displayed on the control-panel display. • Select a menu item. • Clear some errors. • Begin a print job in response to a control-panel prompt (for example, when the message Press [OK] to continue appears on the control-panel display).

4	Right arrow  button	Use this button to navigate through the menus or to increase a value that appears on the display.
5	Cancel  button	Use this button to cancel a print job or to exit the control panel menus.
6	Start Copy  button	Use this button to start a copy job.
7	Number of Copies  button	Use this button to set the number of copies to be produced.
8	Lighter/Darker  button	Use this button to adjust the darkness setting for the current copy job.
9	Copy Menu  button	Use this button to open the Copy menu.
10	Alphanumeric keypad	Use the keypad to provide fax numbers.
11	Fax Redial  button	Use this button to recall the fax number used for the previous fax job.
12	Start Fax  button	Use this button to start a fax job.
13	Setup  button	Use this button to open the Setup menu.
14	Back arrow  button	Use this button for the following actions: <ul style="list-style-type: none"> • Exit the control-panel menus. • Scroll back to a previous menu in a submenu list. • Scroll back to a previous menu item in a submenu list (without saving changes to the menu item).
15	Ready  LED	The Ready light glows without blinking when the printer is ready to print. It blinks when the printer is receiving print data or canceling a print job.
16	Attention  LED	The Attention light blinks when the printer requires user attention, such as when the printer runs out of paper or a toner cartridge needs to be changed. If the light glows without blinking, the printer has experienced an error.

Touchscreen control panel view (M130fw, M132fw models)









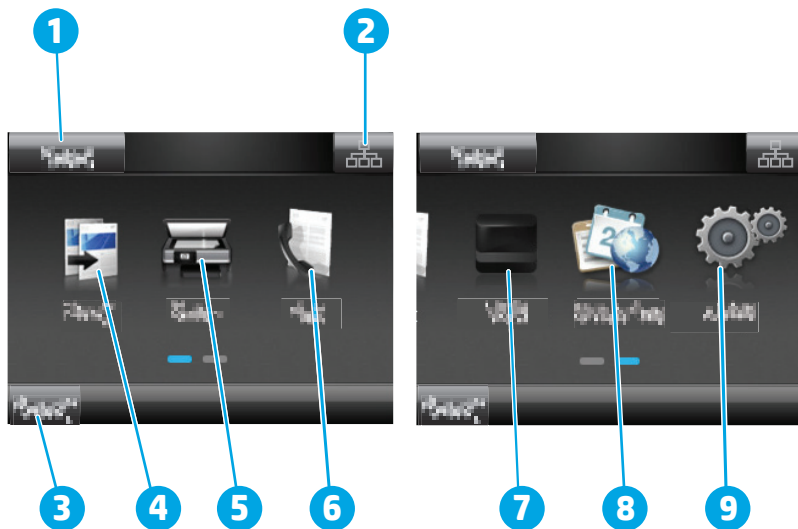

1	Back button	Returns to the previous screen
2	Home button	Provides access to the Home screen
3	Help button	Provides access to the control-panel help system
4	Color touchscreen	Provides access to menus, help animations, and printer information.
5	Home page screen indicator	The display indicates which Home screen the control panel is currently displaying.

 **NOTE:** While the control panel does not have a standard **Cancel** button, during many printer processes a **Cancel** button appears on the touchscreen. This permits users to cancel a process before the printer completes it.





Home screen layout

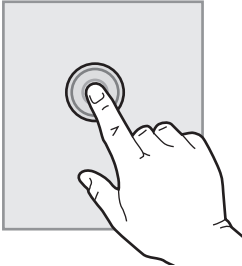

1	Reset button	Touch this button to reset any temporary job settings to the default printer settings.
2	Connection Information button	Touch this button to open the Connection Information menu, which provides network information. The button appears as either a wired network icon  or a wireless network icon  , depending on the type of network to which the printer is connected.
3	Printer status	This screen area provides information about the overall printer status.
4	Copy 	Touch this button to open the copy menu.
5	Scan 	Touch this button to open the scan menus: <ul style="list-style-type: none"> • Scan to Network Folder • Scan to E-mail
6	Fax 	Touch this button to open the fax menus.
7	Supplies 	Touch this button to view information about supplies status.
8	Apps 	Touch this button to open the Apps menu to print directly from select Web applications.
9	Setup 	Touch this button to open the Setup menu.

How to use the touchscreen control panel

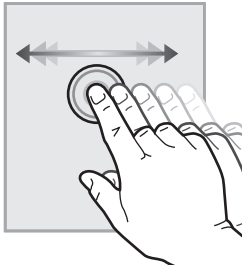
Use the following actions to use the printer touchscreen control panel.

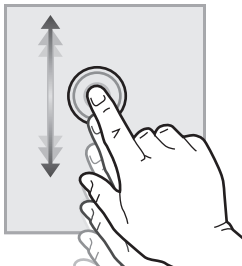
Action	Description	Example
Touch 	Touch an item on the screen to select that item or open that menu. Also, when scrolling through menus, briefly touch the screen to stop the scrolling.	Touch Setup  to open the Setup menu.
Swipe 	Touch the screen and then move the finger horizontally to scroll the screen sideways.	Swipe the Home screen to access Setup  .
Scroll 	Touch the screen, and then, without lifting the finger, move the finger vertically to move the screen.	Scroll through the Setup menu.

Printer specifications



IMPORTANT: The following specifications are correct at the time of publication, but they are subject to change. For current information, see www.hp.com/support/ljM129MFP.

- [Technical specifications](#)
- [Supported operating systems](#)
- [Mobile printing solutions](#)
- [Printer dimensions](#)
- [Power consumption, electrical specifications, and acoustic emissions](#)
- [Operating-environment range](#)

Technical specifications

See www.hp.com/support/ljM129MFP for current information.

Supported operating systems

The following information applies to the printer-specific Windows PCLmS and OS X print drivers.

Windows: The HP Software Installer installs the PCLm.S, PCLmS, or PCLm-S driver depending on the Windows operating system along with optional software when using the full software installer. See the software installation notes for more information.

OS X: Mac computers are supported with this printer. Download HP Easy Start either from the printer installation CD or from 123.hp.com, and then use HP Easy Start to install the HP print driver and utility. See the software installation notes for more information.

1. Go to 123.hp.com.
2. Follow the steps provided to download the printer software.

Linux: For information and print drivers for Linux, go to hplipopensource.com/hplip-web/index.html.

Operating system	Print driver installed	Notes
Windows® XP SP3 or later, 32-bit	The HP PCLm.S printer-specific print driver is installed for this operating system as part of the basic software installation. The basic installer installs the driver only.	Microsoft retired mainstream support for Windows XP in April 2009. HP will continue to provide best-effort support for the discontinued XP operating system.
Windows Vista®, 32-bit	The HP PCLm.S printer-specific print driver is installed for this operating system as part of the basic software installation. The basic installer installs the driver only.	
Windows Server 2003, SP2 or later, 32-bit	The HP PCLm.S printer-specific print driver is installed for this operating system as part of the basic software installation. The basic installer installs the driver only.	Microsoft retired mainstream support for Windows Server 2003 in July 2010. HP will continue to provide best-effort support for the discontinued Server 2003 operating system.
Windows Server 2003, R2, 32-bit	The HP PCLm.S printer-specific print driver is installed for this operating system as part of the basic software installation. The basic installer installs the driver only.	Microsoft retired mainstream support for Windows Server 2003 in July 2010. HP will continue to provide best-effort support for the discontinued Server 2003 operating system.
Windows 7, 32-bit and 64-bit	The HP PCLmS printer-specific print driver is installed for this operating system as part of the full software installation.	
Windows 8, 32-bit and 64-bit	The HP PCLmS printer-specific print driver is installed for this operating system as part of the basic software installation.	Windows 8 RT support is provided through Microsoft IN OS Version 4, 32-bit driver.
Windows 8.1, 32-bit and 64-bit	The HP PCLm-S printer-specific print driver is installed for this operating system as part of the basic software installation.	Windows 8.1 RT support is provided through Microsoft IN OS Version 4, 32-bit driver.
Windows 10, 32-bit and 64-bit	The HP PCLm-S printer-specific print driver is installed for this operating system as part of the basic software installation.	

Operating system	Print driver installed	Notes
Windows Server 2008, 32-bit and 64-bit	The HP PCLm.S printer-specific print driver is installed for this operating system as part of the basic software installation.	
Windows Server 2008, R2, 64-bit	The HP PCLmS printer-specific print driver is installed for this operating system as part of the basic software installation.	
Windows Server 2012, 64-bit	The HP PCLmS printer-specific print driver is installed for this operating system as part of the basic software installation.	
Windows Server 2012 R2, 64-bit	The HP PCLm-S printer-specific print driver is installed for this operating system as part of the basic software installation.	
OS X 10.9 Mavericks, OS X 10.10 Yosemite, and OS X 10.11 El Capitan	The OS X print driver and print utility are available for download from either the installation CD or 123.hp.com .	<p>Download HP Easy Start either from the printer installation CD or from 123.hp.com, and then use HP Easy Start to install the HP print driver and utility.</p> <ol style="list-style-type: none"> 1. Go to 123.hp.com. 2. Follow the steps provided to download the printer software.

 **NOTE:** For a current list of supported operating systems, go to www.hp.com/support/ljM129MFP for HP's all-inclusive help for the printer.

Mobile printing solutions

HP offers multiple mobile and ePrint solutions to enable easy printing to an HP printer from a laptop, tablet, smartphone, or other mobile device. To see the full list and to determine the best choice, go to www.hp.com/go/LaserJetMobilePrinting.

 **NOTE:** Update the printer firmware to ensure all mobile printing and ePrint capabilities are supported.

- Wi-Fi Direct (wireless models only)
- HP ePrint via email (Requires HP Web Services to be enabled and the printer to be registered with HP Connected)
- HP ePrint software
- Android Printing
- AirPrint

Printer dimensions

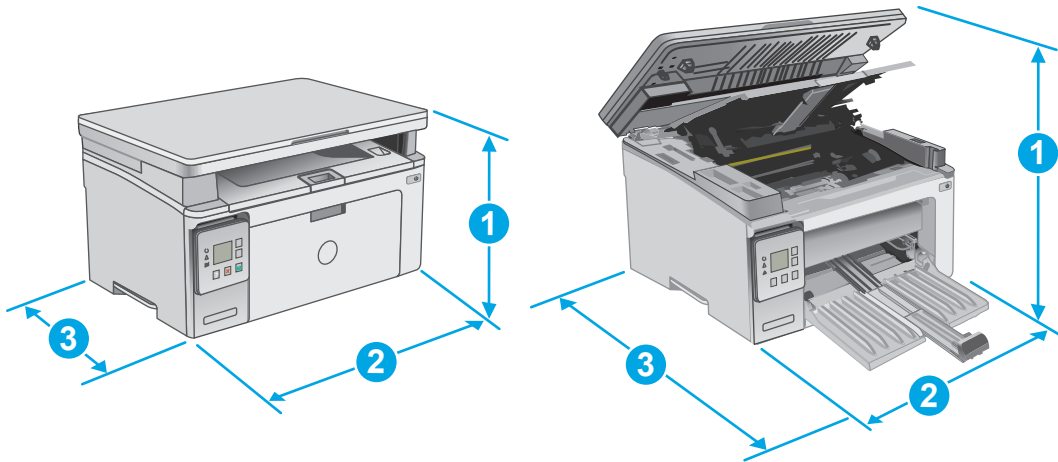

	Printer fully closed	Printer fully open
1. Height	231 mm (9.1 in)	388 mm (15.3 in)
2. Width	398 mm (15.7 in)	398 mm (15.7 in)
3. Depth	288 mm (11.3 in)	482 mm (19 in)
Weight (with cartridges)	9.1 kg (20 lb) to 9.33 kg (20.5 lb)	

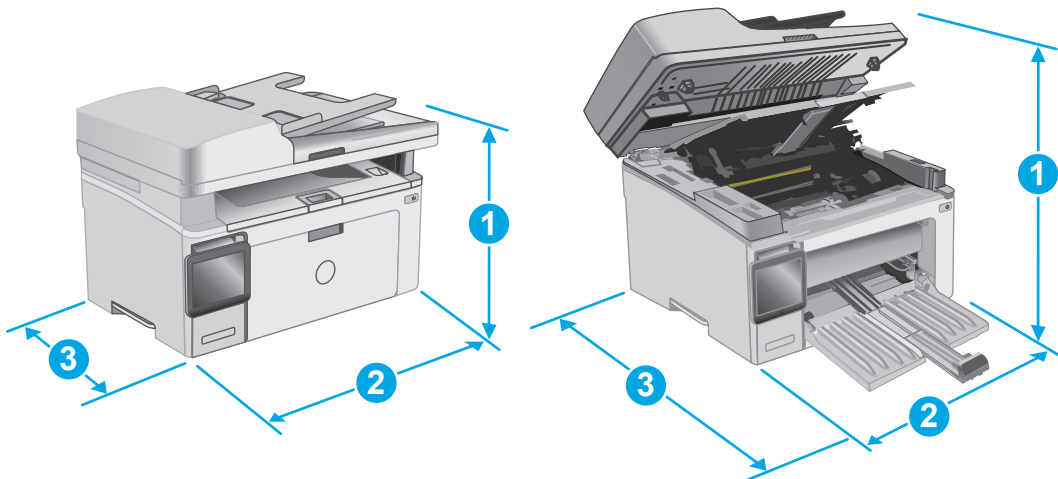

	Printer fully closed	Printer fully open
1. Height	279.5 mm (11 in)	423.7 mm (16.7 in)
2. Width	423 mm (16.6 in)	423 mm (16.6 in)
3. Depth	288.6 mm (11.4 in)	511 mm (20.1 in)
Weight (with cartridges)	10.2 kg (22.5 lb) to 10.6 kg (23.4 lb)	

Power consumption, electrical specifications, and acoustic emissions

See www.hp.com/support/ljM129MFP for current information.

 **CAUTION:** Power requirements are based on the country/region where the printer is sold. Do not convert operating voltages. This will damage the printer and void the printer warranty.

Operating-environment range

Environment	Recommended	Allowed
Temperature	15° to 27°C (59° to 80.6°F)	15° to 30°C (59° to 86°F)
Relative humidity	20% to 70% relative humidity (RH), non-condensing	10% to 80% (RH), non-condensing

Printer hardware setup and software installation

For basic setup instructions, see the Setup Poster and Getting Started Guide that came with the printer. For additional instructions, go to HP support on the Web.

Go to www.hp.com/support/ljM129MFP for HP's all-inclusive help for the printer. Find the following support:

- Install and configure
- Learn and use
- Solve problems
- Download software and firmware updates
- Join support forums
- Find warranty and regulatory information

2 Paper trays

- [Load the input tray](#)
- [Load and print envelopes](#)

For more information:

The following information is correct at the time of publication. For current information, see www.hp.com/support/ljM129MFP.

HP's all-inclusive help for the printer includes the following information:

- Install and configure
- Learn and use
- Solve problems
- Download software and firmware updates
- Join support forums
- Find warranty and regulatory information

Load the input tray

Introduction

The following information describes how to load paper in the input tray. This tray holds up to 150 sheets of 75 g/m² (20 lb) paper.

Load paper into the input tray

 **NOTE:** When you add new paper, make sure that you remove all of the paper from the input tray and straighten the stack. Do not fan the paper. This reduces jams by preventing multiple sheets of paper from feeding through the product at one time.

1. If it is not already open, open the input tray.

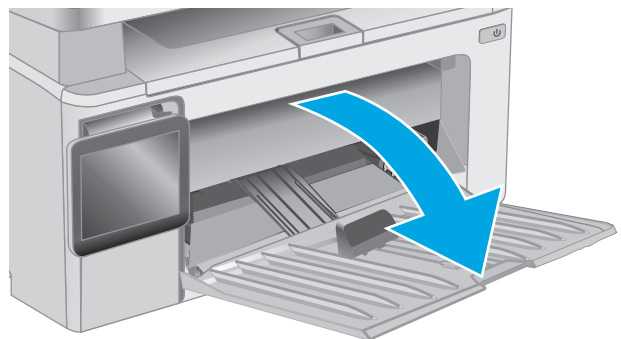

2. Adjust the paper width and length guides outward.

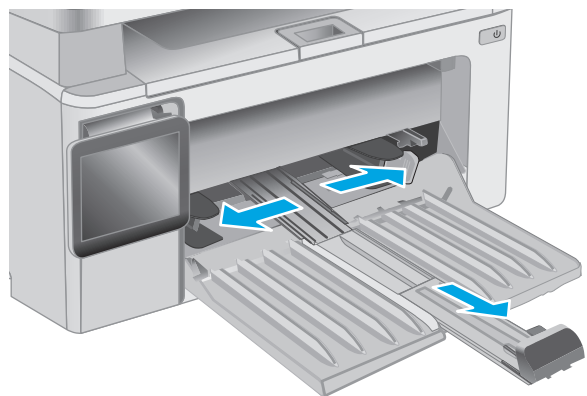

3. Load the paper face-up with the top forward in the input tray.

The orientation of the paper in the tray varies depending on the type of print job. For additional information, see the table below.

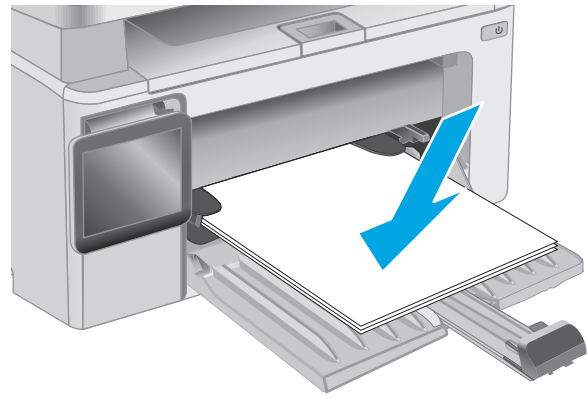

4. Adjust the paper guides inward until they are snug against the paper.

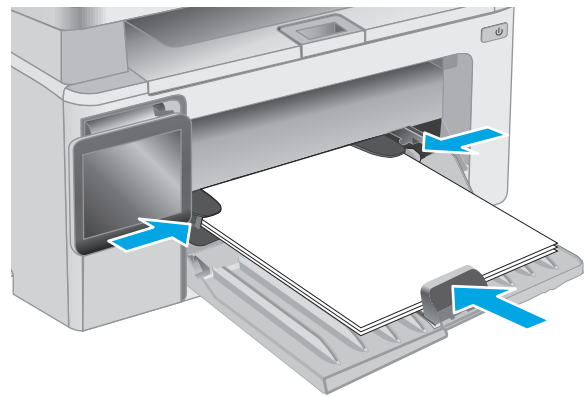

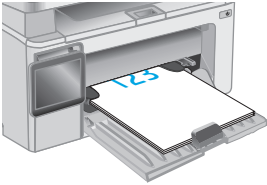
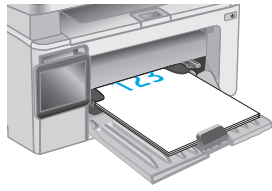
Paper type	Duplex mode	How to load paper
Preprinted or letterhead	1-sided printing or 2-sided printing	Face-up Top edge leading into the product 
Prepunched	1-sided printing or 2-sided printing	Face-up Holes toward the left side of the product 

Load and print envelopes

Introduction

The following information describes how to print and load envelopes. For the best performance, only 5 mm (.2 in) of envelopes (4 to 6 envelopes) should be loaded into the priority feed tray, and only 10 envelopes should be loaded into the input tray.

To print envelopes, follow these steps to select the correct settings in the print driver.

Print envelopes

1. From the software program, select the **Print** option.
2. Select the printer from the list of printers, and then click or tap the **Properties** or **Preferences** button to open the print driver.

 **NOTE:** The name of the button varies for different software programs.

 **NOTE:** To access these features from a Windows 8 or 8.1 Start screen, select **Devices**, select **Print**, and then select the printer.

3. Click or tap the **Paper/Quality** tab.
4. In the **Paper source** drop-down list, select the tray to be used.
5. In the **Media** drop-down list, select **Envelope**.
6. Click the **OK** button to close the **Document Properties** dialog box.
7. In the **Print** dialog box, click the **OK** button to print the job.

Envelope orientation

Load envelopes in the input tray face up, with the short, return address end leading into the printer.

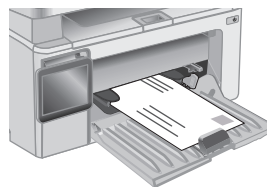

3 Supplies, accessories, and parts

- [Order supplies, accessories, and parts](#)
- [Configure the HP toner-cartridge-protection supply settings](#)
- [Replace the toner cartridge](#)

For more information:

The following information is correct at the time of publication. For current information, see www.hp.com/support/ljM129MFP.

HP's all-inclusive help for the printer includes the following information:

- Install and configure
- Learn and use
- Solve problems
- Download software and firmware updates
- Join support forums
- Find warranty and regulatory information

Order supplies, accessories, and parts

Ordering

Order supplies and paper	www.hp.com/go/suresupply
Order genuine HP parts or accessories	www.hp.com/buy/parts
Order through service or support providers	Contact an HP-authorized service or support provider.
Order using the HP Embedded Web Server (EWS)	To access, in a supported Web browser on the computer, enter the printer IP address or host name in the address/URL field. The EWS contains a link to the HP SureSupply Web site, which provides options for purchasing Original HP supplies.

Supplies and accessories

Item	Description	Cartridge number	Part number
Supplies			
HP 17A Black Original LaserJet Toner Cartridge	Replacement black toner cartridge for M129-M130 models	17A	CF217A
HP 18A Black Original LaserJet Toner Cartridge	Replacement black toner cartridge for M132-M133 models	18A	CF218A
HP 19A Original LaserJet Imaging Drum	Replacement imaging drum for M129-M132 models	19A	CF219A
HP 33A Black Original LaserJet Toner Cartridge	Replacement black toner cartridge for M133-M134 models	33A	CF233A
HP 34A Original LaserJet Imaging Drum	Replacement imaging drum for M133-M134 models	34A	CF234A

Customer self-repair parts

Customer Self-Repair (CSR) parts are available for many HP LaserJet printers to reduce repair time. More information about the CSR program and benefits can be found at www.hp.com/go/csr-support and www.hp.com/go/csr-faq.

Genuine HP replacement parts can be ordered at www.hp.com/buy/parts or by contacting an HP-authorized service or support provider. When ordering, one of the following will be needed: part number, serial number (found on back of printer), product number, or printer name.

- Parts listed as **Mandatory** self-replacement are to be installed by customers, unless you are willing to pay HP service personnel to perform the repair. For these parts, on-site or return-to-depot support is not provided under the HP product warranty.
- Parts listed as **Optional** self-replacement can be installed by HP service personnel at your request for no additional charge during the printer warranty period.

Item	Description	Self-replacement options	Part number
Pickup roller	Replacement pickup roller for input tray	Mandatory	RL1-2593-000CN

Item	Description	Self-replacement options	Part number
Telephone handset	Telephone handset assembly for China	Mandatory	G3Q59-60131CN
ADF replaceable film assembly	Replacement film for ADF scan window	Mandatory	RM2-1185-000CN

Configure the HP toner-cartridge-protection supply settings

- [Introduction](#)
- [Enable or disable the Cartridge Policy feature](#)
- [Enable or disable the Cartridge Protection feature](#)

Introduction

Use HP Cartridge Policy and Cartridge Protection to control which cartridges are installed in the printer and protect the cartridges that are installed from theft.

- **Cartridge Policy:** This feature protects the printer from counterfeit toner cartridges by allowing only genuine HP cartridges to be used with the printer. Using genuine HP cartridges ensures the best possible print quality. When someone installs a cartridge that is not a genuine HP cartridge, the printer control panel displays a message that the cartridge is unauthorized and it provides information explaining how to proceed.
- **Cartridge Protection:** This feature permanently associates toner cartridges with a specific printer, or fleet of printers, so they cannot be used in other printers. Protecting cartridges protects your investment. When this feature is enabled, if someone attempts to transfer a protected cartridge from the original printer into an unauthorized printer, that printer will not print with the protected cartridge. The printer control panel displays a message that the cartridge is protected, and it provides information explaining how to proceed.

 **CAUTION:** After enabling cartridge protection for the printer, all subsequent toner cartridges installed in the printer are automatically and *permanently* protected. To avoid protecting a new cartridge, disable the feature *before* installing the new cartridge.

Turning the feature off does not turn off protection for cartridges that are currently installed.

Both features are off by default. Follow these procedures to enable or disable them.

Enable or disable the Cartridge Policy feature

Enable the feature on 2-line and touchscreen control panel models

1. On the printer control panel, open the [Setup](#) menu.
2. Open the following menus:
 - [System Setup](#)
 - [Supply Settings](#)
 - [Cartridge Policy](#)
3. Select [Authorized HP](#).

Disable the feature on 2-line and touchscreen control panel models

1. On the printer control panel, open the [Setup](#) menu.
2. Open the following menus:

- [System Setup](#)
 - [Supply Settings](#)
 - [Cartridge Policy](#)
3. Select **Off**.

Use the HP Embedded Web Server (EWS) to enable the Cartridge Policy feature

1. Open the HP EWS.
 - a. **LED control panels:** Open the HP Printer Assistant.
 - **Windows 8.1:** Click the down arrow in lower left corner of the **Start** screen, and then select the printer name.
 - **Windows 8:** Right-click an empty area on the **Start** screen, click **All Apps** on the app bar, and then select the printer name.
 - **Windows 7, Windows Vista, and Windows XP:** From the computer desktop, click **Start**, select **All Programs**, click **HP**, click the folder for the printer, select the icon with the printer's name, and then open **HP Printer Assistant**.

In the HP Printer Assistant, select **Print**, and then select **HP Device Toolbox**.

2-line control panels: View the control-panel display to see the IP address.

Touchscreen control panels: From the Home screen on the printer control panel, touch the Network  button to display the IP address or host name.

- b. Open a web browser, and in the address line, type the IP address or host name exactly as it displays on the printer control panel. Press the **Enter** key on the computer keyboard. The EWS opens.

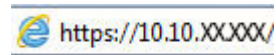

 **NOTE:** If the web browser displays a message indicating that accessing the website might not be safe, select the option to continue to the website. Accessing this website will not harm the computer.

2. In the HP EWS, click the **System** tab.
3. From the left navigation pane, select **Supply Settings**.
4. From the **Cartridge Policy** drop-down list, select **Authorized HP**.
5. Click the **Apply** button.

Use the HP Embedded Web Server (EWS) to disable the Cartridge Policy feature

1. Open the HP EWS.
 - a. **LED control panels:** Open the HP Printer Assistant.

- **Windows 8.1:** Click the down arrow in lower left corner of the **Start** screen, and then select the printer name.
- **Windows 8:** Right-click an empty area on the **Start** screen, click **All Apps** on the app bar, and then select the printer name.
- **Windows 7, Windows Vista, and Windows XP:** From the computer desktop, click **Start**, select **All Programs**, click **HP**, click the folder for the printer, select the icon with the printer's name, and then open **HP Printer Assistant**.

In the HP Printer Assistant, select **Print**, and then select **HP Device Toolbox**.

2-line control panels: View the control-panel display to see the IP address.

Touchscreen control panels: From the Home screen on the printer control panel, touch the Network  button to display the IP address or host name.

- Open a web browser, and in the address line, type the IP address or host name exactly as it displays on the printer control panel. Press the **Enter** key on the computer keyboard. The EWS opens.

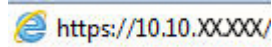

 **NOTE:** If the web browser displays a message indicating that accessing the website might not be safe, select the option to continue to the website. Accessing this website will not harm the computer.

- Click the **System** tab.
- From the left navigation pane, select **Supply Settings**.
- From the **Cartridge Policy** drop-down menu, select **Off**.
- Click the **Apply** button.

Troubleshoot Cartridge Policy control panel or EWS error messages

Error message	Description	Recommended action
10.30.0X Unauthorized <Color> Cartridge	The administrator has configured this printer to use only genuine HP supplies that are still under warranty. The cartridge must be replaced to continue printing.	Replace the cartridge with a genuine HP toner cartridge. If you believe you purchased a genuine HP supply, visit www.hp.com/go/anticounterfeit to determine if the toner cartridge is a genuine HP cartridge, and learn what to do if it is not a genuine HP cartridge.

Enable or disable the Cartridge Protection feature

Enable the feature on 2-line and touchscreen control panel models

- On the printer control panel, open the **Setup** menu.
- Open the following menus:

- [System Setup](#)
 - [Supply Settings](#)
 - [Cartridge Protection](#)
3. Select [Protect Cartridges](#).
 4. When the printer prompts to confirm, select [Continue](#) to enable the feature.

 **CAUTION:** After enabling cartridge protection for the printer, all subsequent toner cartridges installed in the printer are automatically and *permanently* protected. To avoid protecting a new cartridge, disable the Cartridge Protection feature *before* installing the new cartridge.

Turning the feature off does not turn off protection for cartridges that are currently installed.

Disable the feature on 2-line and touchscreen control panel models

1. On the printer control panel, open the [Setup](#) menu.
2. Open the following menus:
 - [System Setup](#)
 - [Supply Settings](#)
 - [Cartridge Protection](#)
3. Select [Off](#).

Use the HP Embedded Web Server (EWS) to enable the Cartridge Protection feature

1. Open the HP EWS.
 - a. **LED control panels:** Open the HP Printer Assistant.
 - **Windows 8.1:** Click the down arrow in lower left corner of the **Start** screen, and then select the printer name.
 - **Windows 8:** Right-click an empty area on the **Start** screen, click **All Apps** on the app bar, and then select the printer name.
 - **Windows 7, Windows Vista, and Windows XP:** From the computer desktop, click **Start**, select **All Programs**, click **HP**, click the folder for the printer, select the icon with the printer's name, and then open **HP Printer Assistant**.

In the HP Printer Assistant, select **Print**, and then select **HP Device Toolbox**.

2-line control panels: View the control-panel display to see the IP address.

Touchscreen control panels: From the Home screen on the printer control panel, touch the Network  button to display the IP address or host name.

- b. Open a web browser, and in the address line, type the IP address or host name exactly as it displays on the printer control panel. Press the **Enter** key on the computer keyboard. The EWS opens.

 https://10.10.XX.XXX/

 **NOTE:** If the web browser displays a message indicating that accessing the website might not be safe, select the option to continue to the website. Accessing this website will not harm the computer.

2. Click the **System** tab.
3. From the left navigation pane, select **Supply Settings**.
4. From the **Cartridge Protection** drop-down list, select **Protect Cartridges**.
5. Click the **Apply** button.

 **CAUTION:** After enabling cartridge protection for the printer, all subsequent toner cartridges installed in the printer are automatically and *permanently* protected. To avoid protecting a new cartridge, disable the Cartridge Protection feature *before* installing the new cartridge.

Turning the feature off does not turn off protection for cartridges that are currently installed.

Use the HP Embedded Web Server (EWS) to disable the Cartridge Protection feature

1. Open the HP EWS.
 - a. **LED control panels:** Open the HP Printer Assistant.
 - **Windows 8.1:** Click the down arrow in lower left corner of the **Start** screen, and then select the printer name.
 - **Windows 8:** Right-click an empty area on the **Start** screen, click **All Apps** on the app bar, and then select the printer name.
 - **Windows 7, Windows Vista, and Windows XP:** From the computer desktop, click **Start**, select **All Programs**, click **HP**, click the folder for the printer, select the icon with the printer's name, and then open **HP Printer Assistant**.

In the HP Printer Assistant, select **Print**, and then select **HP Device Toolbox**.

2-line control panels: View the control-panel display to see the IP address.

Touchscreen control panels: From the Home screen on the printer control panel, touch the Network  button to display the IP address or host name.

- b. Open a web browser, and in the address line, type the IP address or host name exactly as it displays on the printer control panel. Press the **Enter** key on the computer keyboard. The EWS opens.

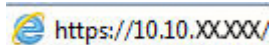

 **NOTE:** If the web browser displays a message indicating that accessing the website might not be safe, select the option to continue to the website. Accessing this website will not harm the computer.

2. Click the **System** tab.
3. From the left navigation pane, select **Supply Settings**.
4. From the **Cartridge Protection** drop-down list, select **Off**.
5. Click the **Apply** button.

Troubleshoot Cartridge Protection control panel or EWS error messages

Error message	Description	Recommended action
10.57.0X Protected <Color> Cartridge	<p>The cartridge can only be used in the printer or fleet of printers that initially protected it using HP Cartridge Protection.</p> <p>The Cartridge Protection feature allows an administrator to restrict cartridges to work in only one printer or fleet of printers. The cartridge must be replaced to continue printing.</p>	Replace the cartridge with a new toner cartridge.

Replace the toner cartridge

- [Introduction](#)
- [Toner-cartridge and imaging-drum information](#)
- [Replace the toner cartridge \(M129-M132 models\)](#)
- [Replace the toner cartridge \(M133-M134 models\)](#)
- [Replace the imaging drum \(M129-M132 models\)](#)
- [Replace the imaging drum \(M133-M134 models\)](#)

Introduction

The following information provides details about the toner cartridge and imaging drum for the printer, and it includes instructions to replace them.

Toner-cartridge and imaging-drum information

This printer indicates when the toner cartridge level is low and very low. The actual toner cartridge life remaining can vary. Consider having a replacement cartridge available to install when print quality is no longer acceptable.

To purchase cartridges or check cartridge compatibility for the printer, go to HP SureSupply at www.hp.com/go/suresupply. Scroll to the bottom of the page and verify that the country/region is correct.

Item	Description	Cartridge number	Part number
HP 17A Black Original LaserJet Toner Cartridge	Replacement black toner cartridge for M129-M130 models	17A	CF217A
HP 18A Black Original LaserJet Toner Cartridge	Replacement black toner cartridge for M132-M133 models	18A	CF218A
HP 19A Original LaserJet Imaging Drum	Replacement imaging drum for M129-M132 models	19A	CF219A
HP 33A Black Original LaserJet Toner Cartridge	Replacement black toner cartridge for M133-M134 models	33A	CF233A
HP 34A Original LaserJet Imaging Drum	Replacement imaging drum for M133-M134 models	34A	CF234A

 **NOTE:** High-yield toner cartridges contain more toner than standard cartridges for increased page yield. For more information, go to www.hp.com/go/learnaboutsupplies.

Do not remove the toner cartridge from its package until it is time to replace it.

 **CAUTION:** To prevent damage to the toner cartridge, do not expose it to light for more than a few minutes. Cover the green imaging drum if the toner cartridge must be removed from the printer for an extended period of time.

The following illustration shows the toner-cartridge and imaging-drum components.

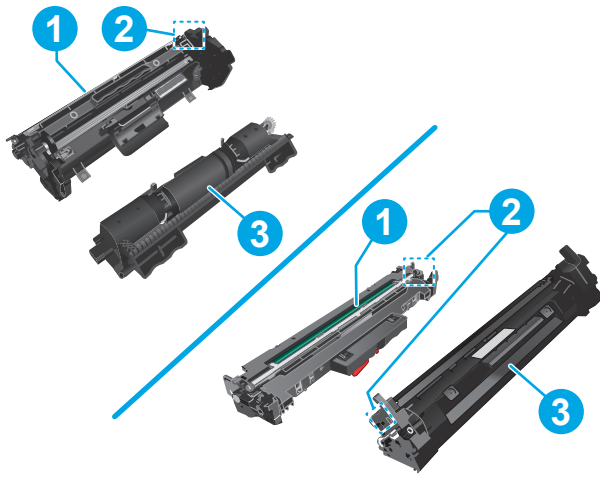

1 Imaging drum

CAUTION: Do not touch the imaging drum. Fingerprints can cause print-quality problems.

2 Memory chip

3 Toner cartridge

CAUTION: If toner gets on clothing, wipe it off by using a dry cloth and wash the clothes in cold water. Hot water sets toner into fabric.

NOTE: Information about recycling used toner cartridges is in the toner-cartridge box.

Replace the toner cartridge (M129-M132 models)

1. Lift the scanner assembly, and then open the top cover.

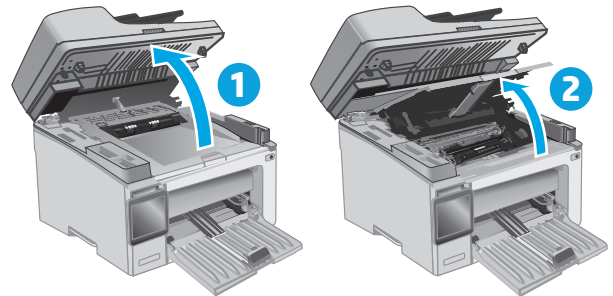

2. Remove the used toner cartridge from the printer.

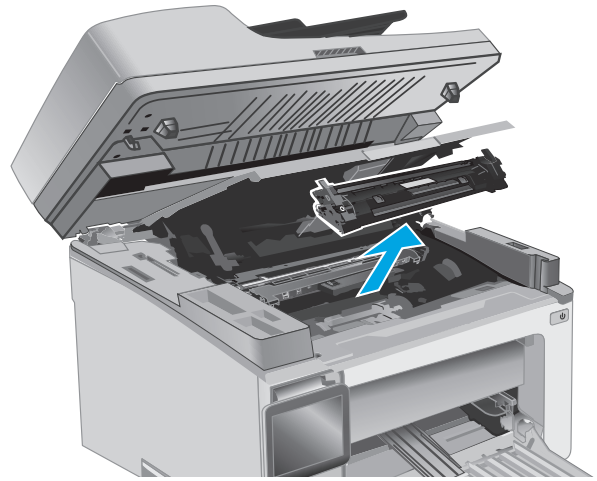

3. Remove the new toner cartridge package from the box, and then pull the release tab on the packaging.

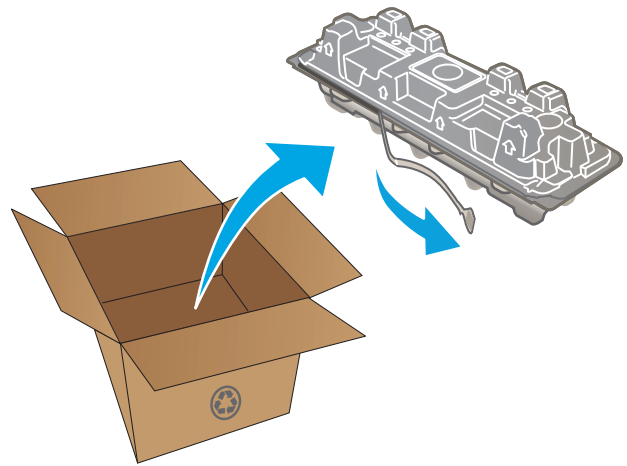

4. Remove the new toner cartridge from the opened packaging shell. Place the used toner cartridge in the shell for recycling.

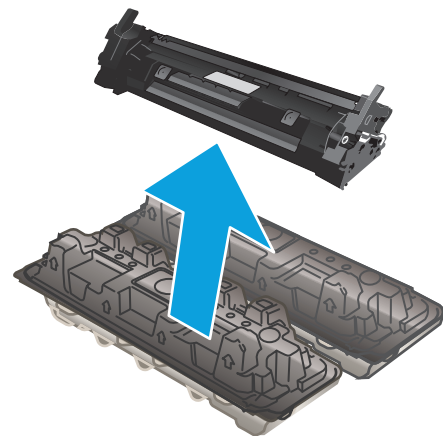

5. Align the new toner cartridge with the tracks inside the printer, and install the new toner cartridge until it is firmly seated.

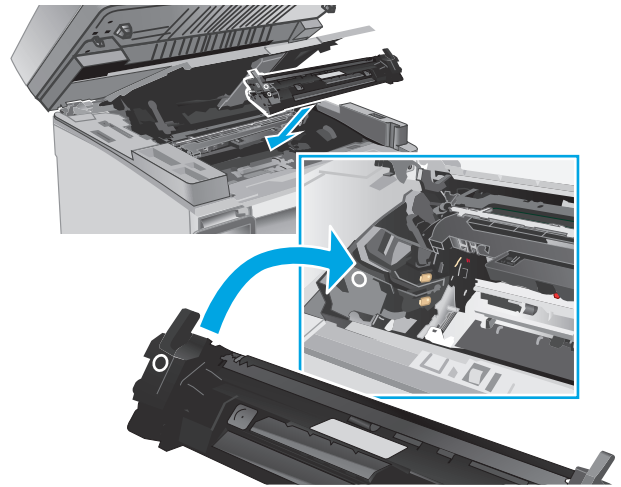

6. Close the top cover, and then lower the scanner assembly.

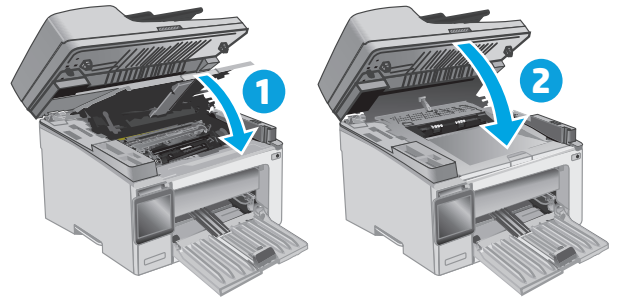

Replace the toner cartridge (M133-M134 models)

1. Lift the scanner assembly, and then open the top cover.

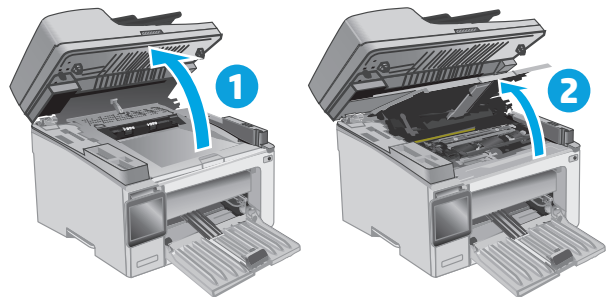

2. Rotate the used toner cartridge to the unlock position.

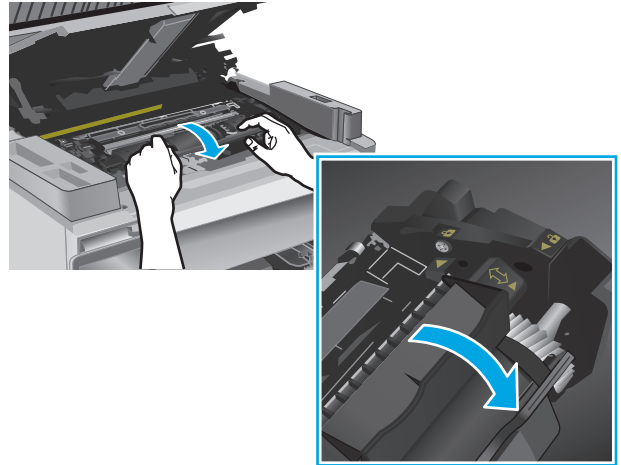

3. Remove the used toner cartridge from the printer.

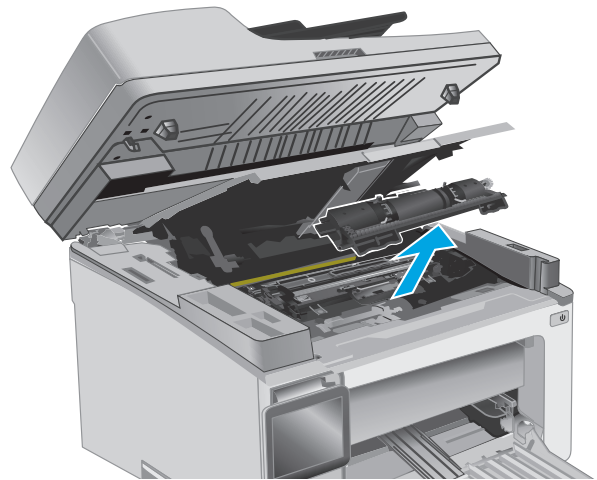

4. Remove the new imaging drum and cartridge package from the box, and then release the packaging.

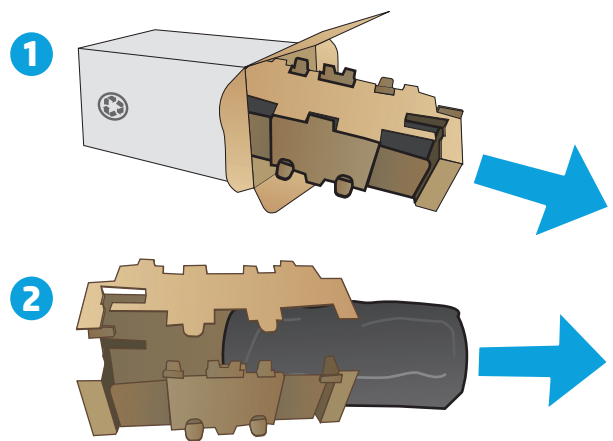

5. Remove the cartridge from the protective bag.

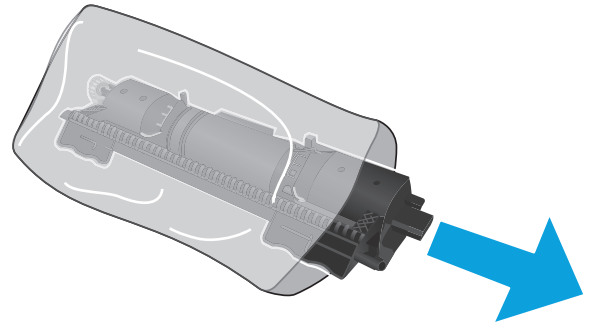

6. Align the arrow on the new toner cartridge with the unlock icon on the imaging drum, and then put in the new toner cartridge.

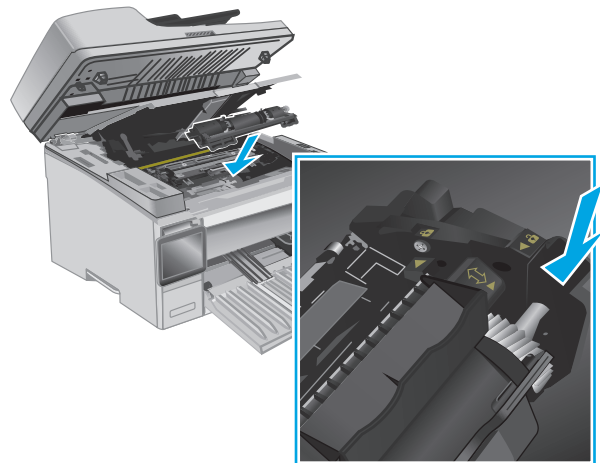

7. Rotate the new toner cartridge to the lock position.

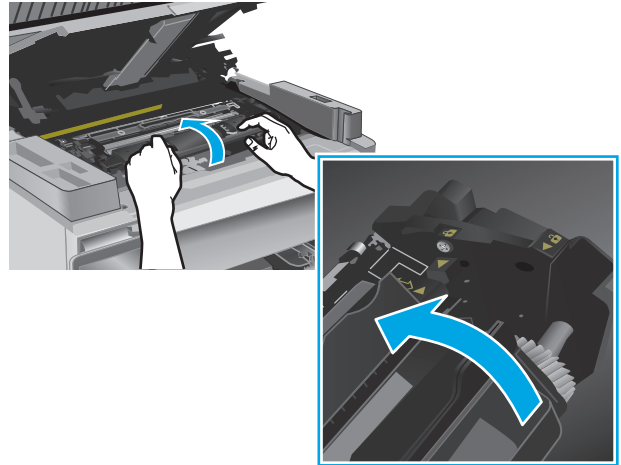

8. Close the top cover, and then lower the scanner assembly.

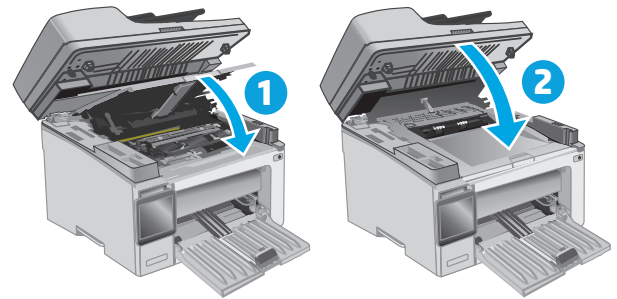

Replace the imaging drum (M129-M132 models)

1. Lift the scanner assembly, and then open the top cover.

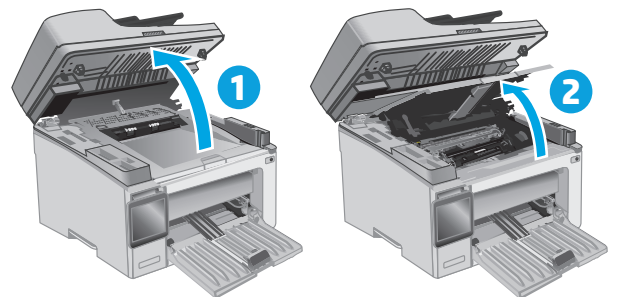

2. Temporarily remove the toner cartridge from the printer.

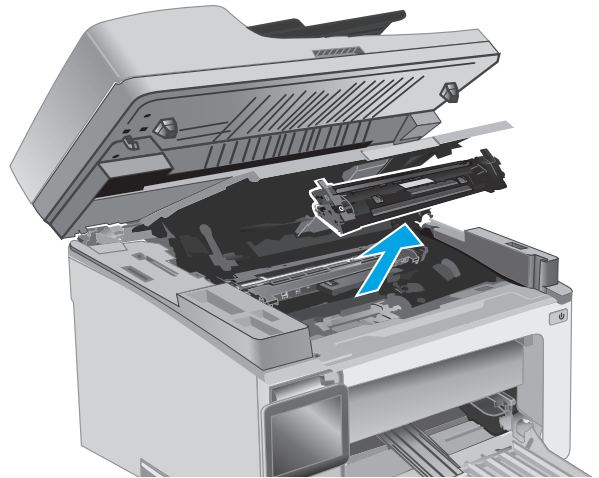

3. Remove the used imaging drum from the printer.

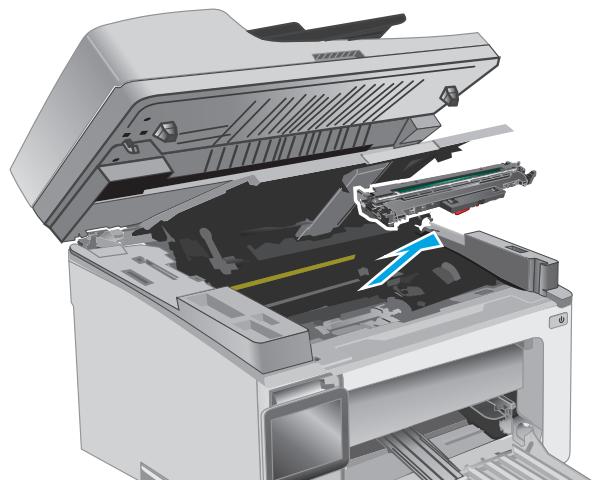

4. Remove the new imaging-drum package from the box, and then release the packaging.

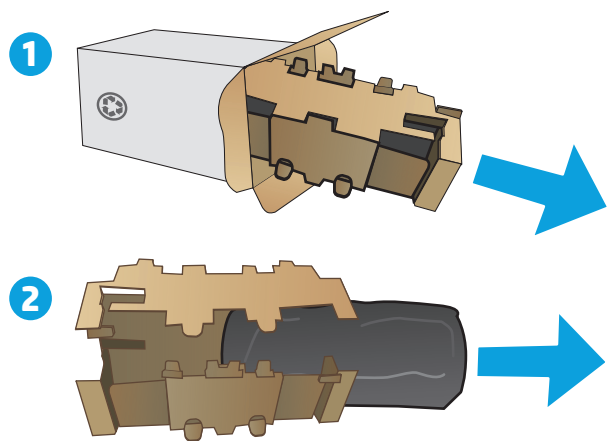

5. Remove the drum from the protective bag.

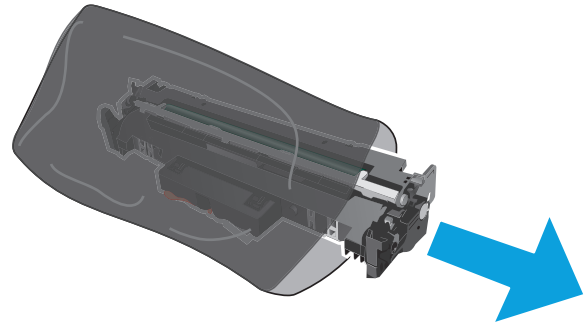

6. Align the new imaging drum with the tracks inside the printer, and install the new imaging drum until it is firmly seated.

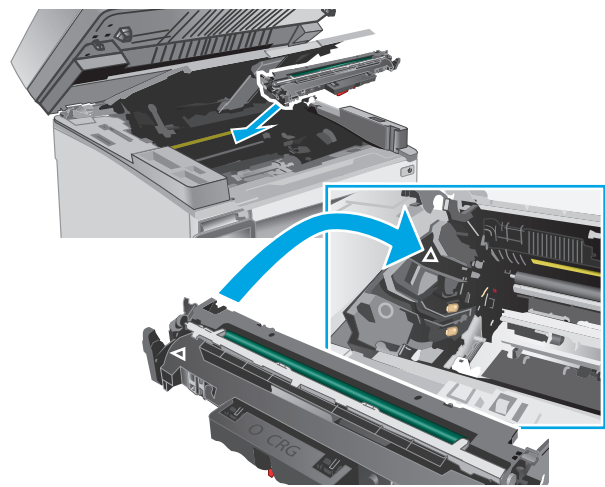

7. Reinstall the temporarily removed toner cartridge.

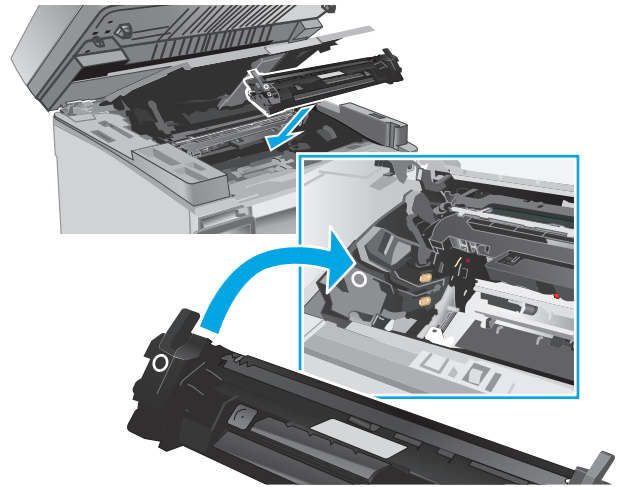

8. Close the top cover, and then lower the scanner assembly.

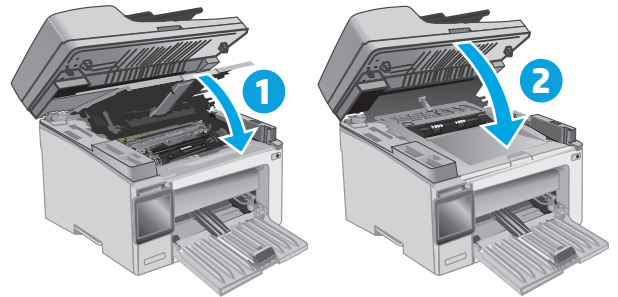

Replace the imaging drum (M133-M134 models)

1. Lift the scanner assembly, and then open the top cover.

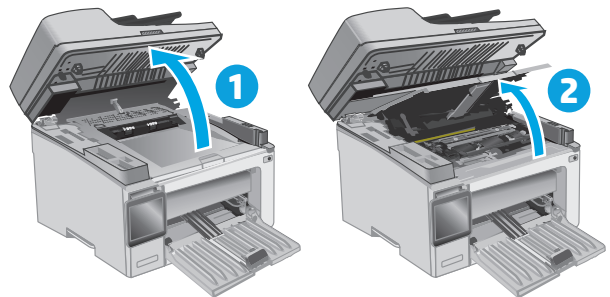

2. Remove the used imaging drum (including the used toner cartridge) from the printer.

NOTE: The toner cartridge is also "very low", and it should be replaced at this time.

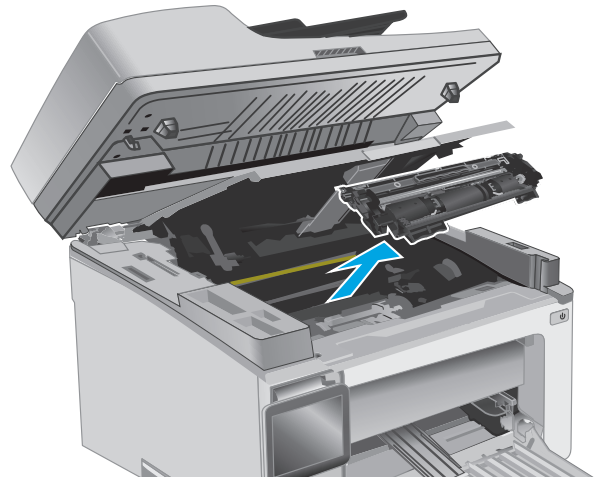

3. Remove the new imaging drum and cartridge package from the box, and then release the packaging.

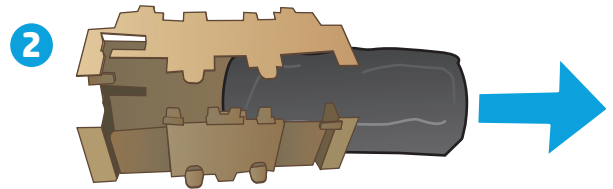
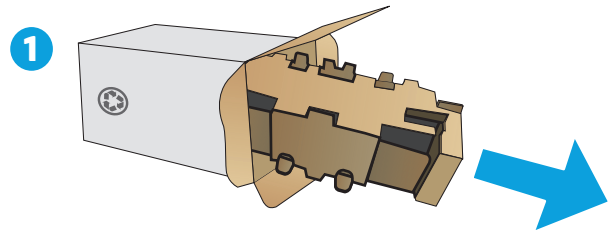

4. Remove the new imaging drum and cartridge from the protective bag.

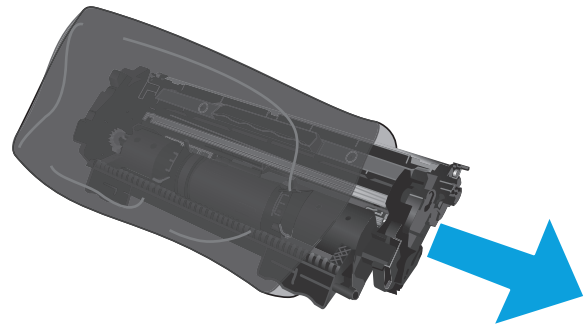

5. Align the new imaging drum and cartridge with the tracks inside the printer, and install the new supply until it is firmly seated.

NOTE: A new toner cartridge, ready for use, is attached to the new imaging drum.

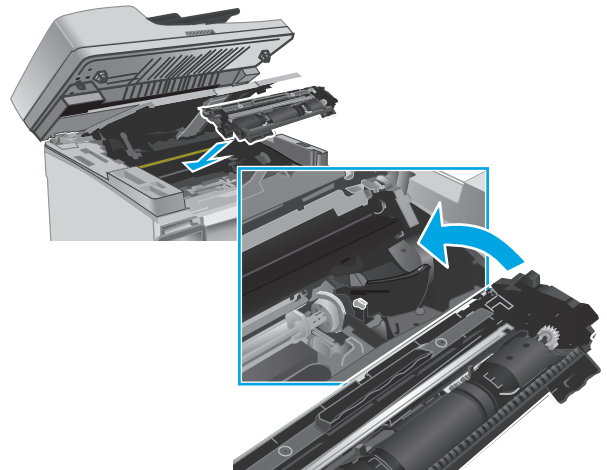

6. Close the top cover, and then lower the scanner assembly.

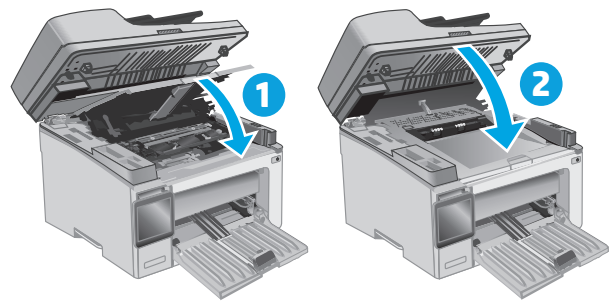

4 Print

- [Print tasks \(Windows\)](#)
- [Print tasks \(OS X\)](#)
- [Mobile printing](#)

For more information:

The following information is correct at the time of publication. For current information, see www.hp.com/support/ljM129MFP.

HP's all-inclusive help for the printer includes the following information:

- Install and configure
- Learn and use
- Solve problems
- Download software and firmware updates
- Join support forums
- Find warranty and regulatory information

Print tasks (Windows)

How to print (Windows)

The following procedure describes the basic printing process for Windows.

1. From the software program, select the **Print** option.
2. Select the printer from the list of printers. To change settings, click or tap the **Properties** or **Preferences** button to open the print driver.

 **NOTE:** The name of the button varies for different software programs.

 **NOTE:** To access these features from a Windows 8 or 8.1 Start screen app, select **Devices**, select **Print**, and then select the printer.

 **NOTE:** For more information, click the Help (?) button in the print driver.

 **NOTE:** The print driver might look different than what is shown here, but the steps are the same.

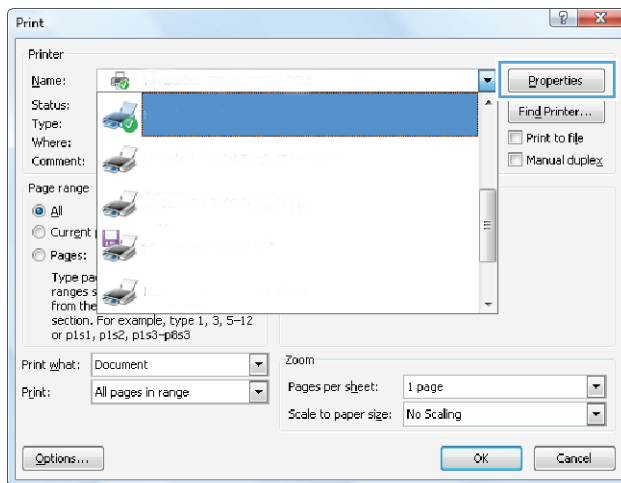

3. Click or tap the tabs in the print driver to configure the available options.
4. Click or tap the **OK** button to return to the **Print** dialog box. Select the number of copies to print from this screen.
5. Click or tap the **OK** button to print the job.

Manually print on both sides (Windows)

Use this procedure for printers that do not have an automatic duplexer installed or to print on paper that the duplexer does not support.

1. From the software program, select the **Print** option.
2. Select the printer from the list of printers, and then click or tap the **Properties** or **Preferences** button to open the print driver.

 **NOTE:** The name of the button varies for different software programs.

 **NOTE:** To access these features from a Windows 8 or 8.1 Start screen app, select **Devices**, select **Print**, and then select the printer.

3. Click the **Layout** tab.
4. Select the appropriate duplex option from the **Print on Both Sides Manually** drop-down list, and then click the **OK** button.
5. In the **Print** dialog box, click the **OK** button to print the job. The printer will print the first side of all the pages in the document first.
6. Retrieve the printed stack from the output bin, and place it with the printed-side facing down, top edge first in the input tray.

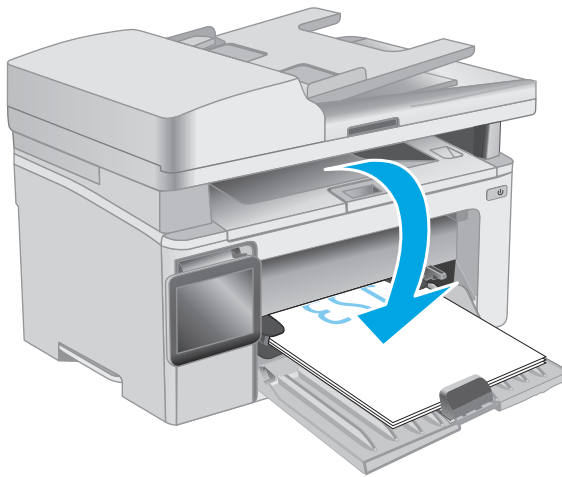

7. At the computer, click the **OK** button to print the second side of the job.
8. If prompted, select the appropriate option to continue.

Print multiple pages per sheet (Windows)

1. From the software program, select the **Print** option.
2. Select the printer from the list of printers, and then click or tap the **Properties** or **Preferences** button to open the print driver.

 **NOTE:** The name of the button varies for different software programs.

 **NOTE:** To access these features from a Windows 8 or 8.1 Start screen app, select **Devices**, select **Print**, and then select the printer.

3. Click or tap the **Layout** tab.
4. Select the correct **Orientation** option from the drop-down list.
5. Select the correct number of pages per sheet from the **Pages per sheet** drop-down list, and then click or tap the **Advanced** button.
6. Select the correct **Pages per Sheet Layout** option from the drop-down list.
7. Select the correct **Page Borders** option from the drop-down list, click or tap the **OK** button to close the **Advanced Options** dialog box, and then click or tap the **OK** button to close the **Properties** or **Preferences** dialog box.
8. In the **Print** dialog box, click the **OK** button to print the job.

Select the paper type (Windows)

1. From the software program, select the **Print** option.
2. Select the printer from the list of printers, and then click or tap the **Properties** or **Preferences** button to open the print driver.



NOTE: The name of the button varies for different software programs.



NOTE: To access these features from a Windows 8 or 8.1 Start screen app, select **Devices**, select **Print**, and then select the printer.

3. Click or tap the **Printing Shortcuts** tab.
4. From the **Paper Type** drop-down list, select the correct paper type, and then click or tap the **OK** button to close the **Properties** or **Preferences** dialog box.
5. In the **Print** dialog box, click the **OK** button to print the job.

Additional print tasks

Go to www.hp.com/support/ljM129MFP.

Instructions are available for performing specific print tasks, such as the following:

- Select the paper size
- Select the page orientation
- Create a booklet
- Select the quality settings

Print tasks (OS X)

How to print (OS X)

The following procedure describes the basic printing process for OS X.

1. Click the **File** menu, and then click the **Print** option.
2. Select the printer.
3. Click **Show Details** or **Copies & Pages**, and then select other menus to adjust the print settings.

 **NOTE:** The name of the item varies for different software programs.

4. Click the **Print** button.

Manually print on both sides (OS X)

 **NOTE:** This feature is available if you install the HP print driver. It might not be available if you are using AirPrint.

1. Click the **File** menu, and then click the **Print** option.
2. Select the printer.
3. Click **Show Details** or **Copies & Pages**, and then click the **Manual Duplex** menu.

 **NOTE:** The name of the item varies for different software programs.

4. Click the **Manual Duplex** box, and select a binding option.
5. Click the **Print** button.
6. Go to the printer, and remove any blank paper that is in Tray 1.
7. Retrieve the printed stack from the output bin and place it with the printed-side facing down in the input tray.
8. At the computer, click the **Continue** button to print the second side of the job.

Print multiple pages per sheet (OS X)

1. Click the **File** menu, and then click the **Print** option.
2. Select the printer.
3. Click **Show Details** or **Copies & Pages**, and then click the **Layout** menu.

 **NOTE:** The name of the item varies for different software programs.

4. From the **Pages per Sheet** drop-down list, select the number of pages that you want to print on each sheet.
5. In the **Layout Direction** area, select the order and placement of the pages on the sheet.
6. From the **Borders** menu, select the type of border to print around each page on the sheet.
7. Click the **Print** button.

Select the paper type (OS X)

1. Click the **File** menu, and then click the **Print** option.
2. Select the printer.
3. Open the menus drop-down list or click **Show Details**, and then click the **Finishing** menu.



NOTE: The name of the item varies for different software programs.

4. Select a type from the **Media-type** drop-down list.
5. Click the **Print** button.

Additional print tasks

Go to www.hp.com/support/ljM129MFP.

Instructions are available for performing specific print tasks, such as the following:

- Select the paper size
- Select the page orientation
- Create a booklet
- Select the quality settings

Mobile printing

Introduction

HP offers multiple mobile and ePrint solutions to enable easy printing to an HP printer from a laptop, tablet, smartphone, or other mobile device. To see the full list and to determine the best choice, go to www.hp.com/go/LaserJetMobilePrinting.

 **NOTE:** Update the printer firmware to ensure all mobile printing and ePrint capabilities are supported.

- [Wi-Fi Direct \(wireless models only\)](#)
- [HP ePrint via email](#)
- [HP ePrint software](#)
- [AirPrint](#)
- [Android embedded printing](#)

Wi-Fi Direct (wireless models only)

Wi-Fi Direct enables printing from a wireless mobile device without requiring a connection to a network or the Internet.

 **NOTE:** Not all mobile operating systems are currently supported by Wi-Fi Direct.

 **NOTE:** For non-Wi-Fi Direct capable mobile devices, the Wi-Fi Direct connection only enables printing. After using Wi-Fi Direct to print, you must reconnect to a local network in order to access the Internet.

To access the printer Wi-Fi Direct connection, complete the following steps:

 **NOTE:** The steps vary according to the type of control panel.

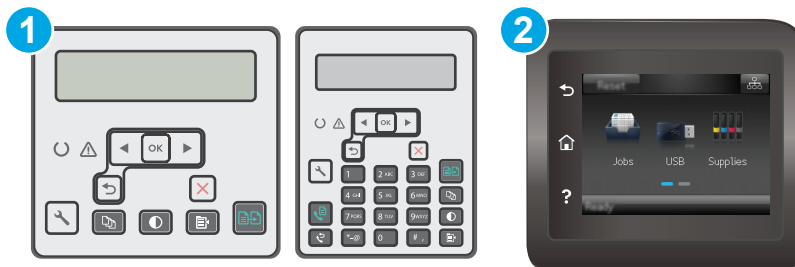

1 2-line control panel

2 Touchscreen control panel

2-line control panels:

1. On the printer control panel, press the Setup  button.
2. Open the following menus:

- Network Setup
 - Wireless Menu
 - Wi-Fi Direct
3. Choose one of the following connection methods:
 - **Automatic:** Choosing this option sets the password to 12345678.
 - **Manual:** Choosing this option generates a secure, randomly generated password.
 4. On the mobile device, open the **Wi-Fi** or **Wi-Fi Direct** menu.
 5. From the list of available networks, select the printer name.

 **NOTE:** If the printer name does not display, you might be out of range of the Wi-Fi Direct signal. Move the device closer to the printer.

6. If prompted, enter the Wi-Fi Direct password, or select **OK** on the printer control panel.

 **NOTE:** For Android devices that support Wi-Fi Direct, if the connection method is set to **Automatic**, the connection will occur automatically, without a password prompt. If the connection method is set to **Manual**, you will need to either press the **OK** button, or provide a personal identification number (PIN) — displayed on the printer control panel — as a password on the mobile device.

7. Open the document, and then select the **Print** option.

 **NOTE:** If the mobile device does not support printing, install the HP ePrint mobile app.

8. Select the printer from the list of available printers, and then select **Print**.
9. After the print job is complete, some mobile devices need to be reconnected to the local network.



Touchscreen control panels:

1. From the Home screen on the printer control panel, touch the Connection Information  button.
2. Open the following menus:
 - **Wi-Fi Direct**
 - **Connection Method**
3. Choose one of the following connection methods:
 - **Automatic:** Choosing this option sets the password to 12345678.
 - **Manual:** Choosing this option generates a secure, randomly generated password.
4. On the mobile device, open the **Wi-Fi** or **Wi-Fi Direct** menu.
5. From the list of available networks, select the printer name.

 **NOTE:** If the printer name does not display, you might be out of range of the Wi-Fi Direct signal. Move the device closer to the printer.

6. If prompted, enter the Wi-Fi Direct password, or select **OK** on the printer control panel.

 **NOTE:** For Android devices that support Wi-Fi Direct, if the connection method is set to **Automatic**, the connection will occur automatically, without a password prompt. If the connection method is set to **Manual**, you will need to either press the **OK** button, or provide a personal identification number (PIN) — displayed on the printer control panel — as a password on the mobile device.

 **NOTE:** To access the Wi-Fi Direct password, from the Home screen on the printer control panel, touch the Connection Information  button.

7. Open the document, and then select the **Print** option.

 **NOTE:** If the mobile device does not support printing, install the HP ePrint mobile app.

8. Select the printer from the list of available printers, and then select **Print**.

9. After the print job is complete, some mobile devices need to be reconnected to the local network.

The following devices and computer operating systems support **Wi-Fi Direct**:

- Android 4.0 and later tablets and phones with the HP Print Service or Mopria mobile printing plugin installed
- Most Windows 8.1 computers, tablets, and laptops that have the HP print driver installed

The following devices and computer operating systems do not support **Wi-Fi Direct**, but can print to a printer that does:

- Apple iPhone and iPad
- Mac computers running OS X

For more information on Wi-Fi Direct printing, go to www.hp.com/go/wirelessprinting.

Wi-Fi Direct capabilities can be enabled or disabled from the printer control panel.

Enable or disable Wi-Fi Direct

Wi-Fi Direct capabilities must be enabled first from the printer EWS.



 **NOTE:** The steps vary according to the type of control panel.





1 2-line control panel

2 Touchscreen control panel

1. **2-line control panels:** On the printer control panel, press the Setup  button, and then open the **Network Setup** menu.

Touchscreen control panels: From the Home screen on the printer control panel, select the Connection Information  /  button.

2. Open the following menus:
 - **Wi-Fi Direct**
 - **Settings** (touchscreen control panels only)
 - **On/Off**
3. Touch the **On** menu item. Touching the **Off** button disables Wi-Fi Direct printing.

 **NOTE:** In environments where more than one model of the same printer is installed, it might be helpful to provide each printer a unique Wi-Fi Direct name for easier printer identification for Wi-Fi Direct printing. On touchscreen control panels, the Wi-Fi Direct Name is also available by touching the Connection Information  /  icon from the Home screen on the printer control panel, and then touching the Wi-Fi Direct icon.

Change the printer Wi-Fi Direct name

Follow this procedure to change the printer Wi-Fi Direct name using the HP Embedded Web Server (EWS):



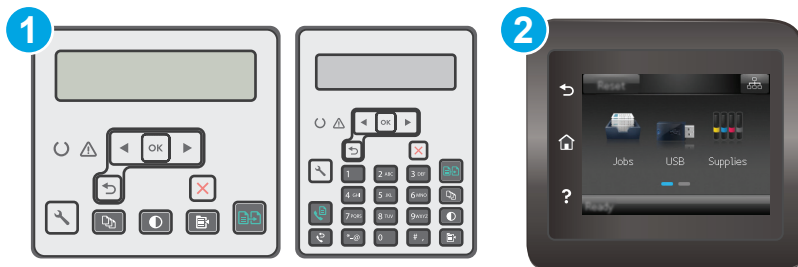

Step one: Open the HP Embedded Web Server

 **NOTE:** The steps vary according to the type of control panel.





- | | |
|---|---------------------------|
| 1 | 2-line control panel |
| 2 | Touchscreen control panel |

1. **2-line control panels:** On the printer control panel, press the Setup  button. Open the **Network Setup** menu, and then select **Show IP Address** to display the IP address or host name.

Touchscreen control panels: From the Home screen on the printer control panel, touch the Connection Information  /  button, and then touch the **Network Connected**  button or the **Network Wi-Fi ON**  button to display the IP address or host name.

2. Open a web browser, and in the address line, type the IP address or host name exactly as it displays on the printer control panel. Press the **Enter** key on the computer keyboard. The EWS opens.

 <https://10.10.XX.XXX/>

 **NOTE:** If the web browser displays a message indicating that accessing the website might not be safe, select the option to continue to the website. Accessing this website will not harm the computer.

Step two: Change the Wi-Fi Direct name

1. Click the **Networking** tab.
2. On the left navigation pane, click the **Wi-Fi Direct Setup** link.
3. In the **Wi-Fi Direct Name** field, enter the new name.
4. Click **Apply**.

HP ePrint via email

Use HP ePrint to print documents by sending them as an email attachment to the printer's email address from any email-enabled device.

To use HP ePrint, the printer must meet these requirements:

- The printer must be connected to a wired or wireless network and have Internet access.
- HP Web Services must be enabled on the printer, and the printer must be registered with HP Connected.

Follow this procedure to enable HP Web Services and register with HP Connected:

 **NOTE:** The steps vary according to the type of control panel.

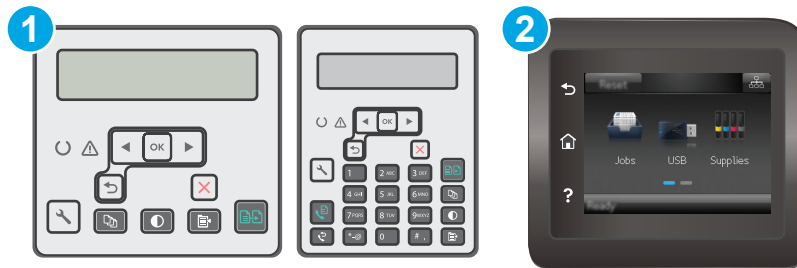

1 2-line control panel

2 Touchscreen control panel

2-line control panels

1. On the printer control panel, press the Setup  button. Open the **Network Setup** menu, and then select **Show IP Address** to display the IP address or host name.

2. Open a web browser, and in the address line, type the IP address or host name exactly as it displays on the printer control panel. Press the **Enter** key on the computer keyboard. The EWS opens.





 **NOTE:** If the web browser displays a message indicating that accessing the website might not be safe, select the option to continue to the website. Accessing this website will not harm the computer.

3. Click the **HP Web Services** tab, and then click **Enable**. The printer enables Web Services, and then prints an information page.

The information page contains the printer code necessary to register the HP printer at HP Connected.

4. Go to www.hpconnected.com to create an HP ePrint account and complete the setup process.

Touchscreen control panels:

1. From the Home screen on the printer control panel, touch the Connection Information  /  button.
2. Open the following menus:
 - [HP ePrint](#)
 - [Settings](#)
 - [Enable Web Services](#)
3. Touch the [Print](#) button to read the terms of use agreement. Touch the [OK](#) button to accept the terms of use and enable HP Web Services

The printer enables Web Services, and then prints an information page. The information page contains the printer code that necessary to register the HP printer at HP Connected.
4. Go to www.hpconnected.com to create an HP ePrint account and complete the setup process.

HP ePrint software

The HP ePrint software makes it easy to print from a Windows or Mac desktop or laptop computer to any HP ePrint-capable printer. This software makes it easy to find HP ePrint-enabled printers that are registered to your HP Connected account. The target HP printer can be located in the office or at locations across the globe.

- **Windows:** After installing the software, open the **Print** option from within your application, and then select **HP ePrint** from the installed printers list. Click the **Properties** button to configure print options.
- **OS X:** After installing the software, select **File, Print**, and then select the arrow next to **PDF** (in the bottom left of the driver screen). Select **HP ePrint**.

For Windows, the HP ePrint software supports TCP/IP printing to local network printers on the network (LAN or WAN) to products that support UPD PostScript®.

Windows and OS X both support IPP printing to LAN or WAN network-connected products that support ePCL.

Windows and OS X also both support printing PDF documents to public print locations and printing using HP ePrint via email through the cloud.

Go to www.hp.com/go/eprintsoftware for drivers and information.

 **NOTE:** For Windows, the name of the HP ePrint Software print driver is HP ePrint + JetAdvantage.

 **NOTE:** The HP ePrint software is a PDF workflow utility for OS X, and is not technically a print driver.

 **NOTE:** HP ePrint Software does not support USB printing.

AirPrint

Direct printing using Apple's AirPrint is supported for iOS and from Mac computers running OS X 10.7 Lion and newer. Use AirPrint to print directly to the printer from an iPad, iPhone (3GS or later), or iPod touch (third generation or later) in the following mobile applications:

- Mail
- Photos
- Safari
- iBooks
- Select third-party applications

To use AirPrint, the printer must be connected to the same network (sub-net) as the Apple device. For more information about using AirPrint and about which HP printers are compatible with AirPrint, go to www.hp.com/go/LaserJetMobilePrinting.

 **NOTE:** Before using AirPrint with a USB connection, verify the version number. AirPrint versions 1.3 and earlier do not support USB connections.

Android embedded printing

HP's built-in print solution for Android and Kindle enables mobile devices to automatically find and print to HP printers that are either on a network or within wireless range for Wi-Fi Direct printing.

The printer must be connected to the same network (sub-net) as the Android device.

The print solution is built into the many versions of the operating system.

 **NOTE:** If printing is not available on your device, go to the [Google Play > Android apps](https://play.google.com/store/apps/details?id=com.hp.printservice.plugin) and install the HP Print Service Plugin.

For more information on how to use Android embedded printing and which Android devices are supported, go to www.hp.com/go/LaserJetMobilePrinting.

5 Copy

- [Make a copy](#)
- [Copy on both sides \(duplex\)](#)
- [Additional copy tasks](#)

For more information:

The following information is correct at the time of publication. For current information, see www.hp.com/support/ljM129MFP.

HP's all-inclusive help for the printer includes the following information:

- Install and configure
- Learn and use
- Solve problems
- Download software and firmware updates
- Join support forums
- Find warranty and regulatory information

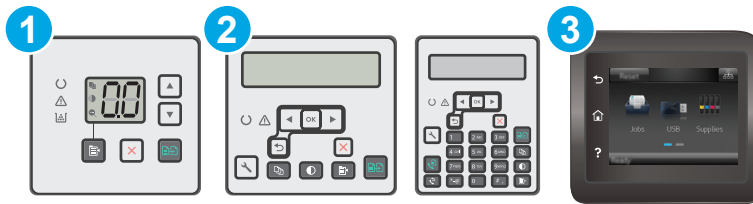

Make a copy

 **NOTE:** The steps vary according to the type of control panel.





- | | |
|---|---------------------------|
| 1 | LED control panel |
| 2 | 2-line control panel |
| 3 | Touchscreen control panel |

LED control panels:

1. Load the document on the scanner glass according to the indicators on the printer.
2. Press the Copy Menu  button to choose any of the following copy settings.
 - Select the Number of Copies setting, and then use the arrow keys to adjust the number of copies.
 - Select the Lighter/Darker setting, and then use the arrow keys to adjust the darkness setting for the current copy job.
 - Select the Enlarge/Reduce setting, and then use the arrow keys to adjust the size percentage of the copy job.
3. Press the Start Copy  button to start copying.

2-line control panels:

1. Load the document on the scanner glass according to the indicators on the printer.
2. Press the Copy Menu  button.
3. To optimize copy quality for different types of documents, use the arrow keys to select the **Optimize** menu, and then press the **OK** button. The following copy-quality settings are available:
 - **Auto Select:** Use this setting when you are not concerned about the quality of the copy. This is the default setting.
 - **Mixed:** Use this setting for documents that contain a mixture of text and graphics.
 - **Text:** Use this setting for documents that contain mostly text.
 - **Picture:** Use this setting for documents that contain mostly graphics.



4. Press the Number of Copies  button, and then use the arrow keys to adjust the number of copies. Press the **OK** button.
5. Press the Start Copy  button to start copying.

Touchscreen control panels:

1. Load the document on the scanner glass according to the indicators on the printer.
2. From the Home screen on the printer control panel, touch the **Copy**  icon.
3. To optimize copy quality for different types of documents, touch the **Settings** button, and then scroll to and touch the **Optimize** button. Swipe the control panel screen to scroll through the options, and then touch an option to select it. The following copy-quality settings are available:
 - **Auto Select:** Use this setting when you are not concerned about the quality of the copy. This is the default setting.
 - **Mixed:** Use this setting for documents that contain a mixture of text and graphics.
 - **Text:** Use this setting for documents that contain mostly text.
 - **Picture:** Use this setting for documents that contain mostly graphics.
4. Touch **Number of Copies**, and then use the touchscreen keypad to adjust the number of copies.
5. Touch the **Start Copy** button to start copying.

Copy on both sides (duplex)

Copy on both sides manually

1. Place the document face-down on the scanner glass with the upper-left corner of the page in the upper-left corner of the glass. Close the scanner.
2. Press the Start Copy  button to start copying.
3. Retrieve the printed page from the output bin, and place it with the printed-side facing down, top edge first in the input tray.
4. Flip the original document on the scanner glass to copy the second side.
5. Press the Start Copy  button to start copying.
6. Repeat this process until you have copied all of the pages.

Additional copy tasks

Go to www.hp.com/support/ljM129MFP.

Instructions are available for performing specific copy tasks, such as the following:

- Copy or scan pages from books or other bound documents
- Copy or scan both sides of an identification card
- Optimize copy quality

6 Scan

- [Scan by using the HP Scan software \(Windows\)](#)
- [Scan by using the HP Easy Scan software \(OS X\)](#)
- [Set up the Scan to E-mail feature \(touchscreen models only\)](#)
- [Set up the Scan to Network Folder feature \(touchscreen models only\)](#)
- [Scan to email \(touchscreen models only\)](#)
- [Scan to a network folder \(touchscreen models only\)](#)
- [Additional scan tasks](#)

For more information:

The following information is correct at the time of publication. For current information, see www.hp.com/support/ljM129MFP.

HP's all-inclusive help for the printer includes the following information:

- Install and configure
- Learn and use
- Solve problems
- Download software and firmware updates
- Join support forums
- Find warranty and regulatory information

Scan by using the HP Scan software (Windows)

Use the HP Scan software to initiate scanning from software on your computer. You can save the scanned image as a file or send it to another software application.

1. Open the HP Printer Assistant.
 - **Windows 8.1:** Click the down arrow in lower left corner of the **Start** screen, and then select the printer name.
 - **Windows 8:** Right-click an empty area on the **Start** screen, click **All Apps** on the app bar, and then select the printer name.
 - **Windows 7, Windows Vista, and Windows XP:** From the computer desktop, click **Start**, select **All Programs**, click **HP**, click the folder for the printer, select the icon with the printer's name, and then open **HP Printer Assistant**.
2. In the HP Printer Assistant, select **Scan**, and then select **Scan a Document or Photo**.
3. Adjust the settings if necessary.
4. Click **Scan**.

Scan by using the HP Easy Scan software (OS X)

Use the HP Easy Scan software to initiate scanning from software on your computer.

1. Load the document in the document feeder or on the scanner glass according to the indicators on the printer.
2. From the computer, open **HP Easy Scan**, which is located in the **Applications** folder.
3. Follow the on-screen instructions to scan the document.
4. When you have scanned all the pages, click **File** and then **Save** to save them to a file.

Set up the Scan to E-mail feature (touchscreen models only)

- [Introduction](#)
- [Before you begin](#)
- [Method one: Use the Scan to Email Wizard \(Windows\)](#)
- [Method two: Set up the Scan to Email feature via the HP Embedded Web Server \(Windows\)](#)
- [Set up the Scan to E-mail feature on a Mac](#)

Introduction

The printer has a feature that enables it to scan a document and send it to one or more email addresses. To use this scan feature, the printer must be connected to a network; however, the feature is not available until it has been configured. There are two methods for configuring Scan to Email, the Scan to Email Setup Wizard (Windows), which is installed in the HP program group for the printer as part of the full software installation in Windows 7, and the Scan to Email Setup through the HP Embedded Web Server (EWS). Use the following information to set up the Scan to Email feature.

Before you begin

To set up the Scan to Email feature, the printer must have an active network connection to the same network as the computer that will run the setup process.

Administrators need the following information before beginning the configuration process.

- Administrative access to the printer
- SMTP server (e.g., smtp.mycompany.com)

 **NOTE:** If you do not know the SMTP server name, SMTP port number, or authentication information, contact the email/Internet service provider or system administrator for the information. SMTP server names and port names are typically easy to find by doing an Internet search. For example, use terms like "gmail smtp server name" or "yahoo smtp server name" to search.

- SMTP port number
- SMTP server authentication requirements for outgoing email messages, including the user name and password used for authentication, if applicable.

 **NOTE:** Consult your email service provider's documentation for information on digital sending limits for your email account. Some providers may temporarily lock your account if you exceed your sending limit.

Method one: Use the Scan to Email Wizard (Windows)

Some HP printers include driver installation from a software CD. At the end of this installation is an option to **Setup Scan to Folder and Email**. The setup wizards include the options for basic configuration.

 **NOTE:** Some operating systems do not support the Scan to Email Wizard.

1. Open the HP Printer Assistant.

- **Windows 8.1:** Click the down arrow in lower left corner of the **Start** screen, and then select the printer name.
 - **Windows 8:** Right-click an empty area on the **Start** screen, click **All Apps** on the app bar, and then select the printer name.
 - **Windows 7, Windows Vista, and Windows XP:** From the computer desktop, click **Start**, select **All Programs**, click **HP**, click the folder for the printer, select the icon with the printer's name, and then open **HP Printer Assistant**.
2. In the HP Printer Assistant, select **Scan**, and then select **Scan to E-mail Wizard**.

 **NOTE:** If the **Scan to E-mail Wizard** option is not available, use [Method two: Set up the Scan to Email feature via the HP Embedded Web Server \(Windows\) on page 72](#)

3. In the **Outgoing Email Profiles** dialog, click the **New** button. The **Scan to Email Setup** dialog opens.
4. On the **1. Start** page, enter the sender's email address in the **Email Address** field.
5. In the **Display Name** field, enter the sender's name. This is the name that will display on the printer control panel.
6. To require a PIN to be entered on the printer control panel before the printer can send an email, enter a 4-digit PIN in the **Security PIN** field, and then re-enter the PIN in the **Confirm Security PIN** field, and then click **Next**.

 **NOTE:** HP recommends creating a PIN to secure the email profile.

 **NOTE:** When a PIN is created, it must be entered on the printer control panel each time the profile is used to send a scan to email.

7. On the **2. Authenticate** page, enter the **SMTP Server** name and **SMTP Port** number.

 **NOTE:** In most cases, the default port number does not need to be changed.

 **NOTE:** If you are using a hosted SMTP service such as Gmail, verify the SMTP address, port number, and SSL settings from the service provider's website or other sources. Typically, for Gmail, the SMTP address is smtp.gmail.com, port number 465, and the SSL should be enabled.

Please refer to online sources to confirm these server settings are current and valid at the time of configuration.

8. If you are using Google™ Gmail for email service, select the **Always use secure connection (SSL/TLS)** check box.
9. Select the **Maximum Size of Email** from the drop-down menu.

 **NOTE:** HP recommends using the default file size of **Automatic** for the maximum size.



10. If the SMTP server requires authentication to send an email, select the **Email Log-in Authentication** check box, enter the **User ID** and **Password**, and then click **Next**.
11. On the **3. Configure** page, to automatically copy the sender on email messages sent from the profile, select **Include sender in all email messages sent out successfully from the printer**, and then click **Next**.

12. On the **4. Finish** page, review the information and verify all the settings are correct. If there is an error, click the **Back** button to correct the error. If the settings are correct, click the **Save and Test** button to test the configuration.
13. When the **Congratulations** message displays, click **Finish** to complete the configuration.
14. The **Outgoing Email Profiles** dialog now shows the newly added sender email profile. Click **Close** to exit the wizard.

Method two: Set up the Scan to Email feature via the HP Embedded Web Server (Windows)

- [Step one: Access the HP Embedded Web Server \(EWS\)](#)
- [Step two: Configure the Scan to E-mail feature](#)
- [Step three: Add contacts to the E-mail Address Book](#)
- [Step four: Configure the default E-mail Options](#)

Step one: Access the HP Embedded Web Server (EWS)





1. From the Home screen on the printer control panel, touch the Network  button or the Wireless  button to display the IP address or host name.
2. Open a web browser, and in the address line, type the IP address or host name exactly as it displays on the printer control panel. Press the **Enter** key on the computer keyboard. The EWS opens.

 <https://10.10.XX.XXX/>

 **NOTE:** If the web browser displays a message indicating that accessing the website might not be safe, select the option to continue to the website. Accessing this website will not harm the computer.

Step two: Configure the Scan to E-mail feature

1. In the HP EWS, click the **System** tab.
2. On the left navigation pane, click the **Administration** link.
3. In the Enabled Features area, set the **Scan to Email** option to **On**.
4. Click the **Scan** tab.
5. On the left navigation pane, click the **Outgoing E-mail Profiles** link.
6. On the **Outgoing E-mail Profiles** page, click the **New** button.
7. In the **E-mail Address** area, complete the following fields:
 - a. In the **Your E-mail Address** field, enter the sender's email address for the new outgoing email profile.
 - b. In the **Display Name** field, enter the sender's name. This is the name that will display on the printer control panel.
8. In the **SMTP Server Settings** area, complete the following fields:

- a. In the **SMTP Server** field, enter the address of the SMTP server.
 - b. In the **SMTP Port** field, enter the SMTP port number.
-
-  **NOTE:** In most cases, the default port number does not need to be changed.
-  **NOTE:** If you are using a hosted SMTP service such as Gmail, verify the SMTP address, port number, and SSL settings from the service provider's website or other sources. Typically, for Gmail, the SMTP address is smtp.gmail.com, port number 465, and the SSL should be enabled.
- Please refer to online sources to confirm these server settings are current and valid at the time of configuration.
-
- c. If you are using Google™ Gmail for email service, select the **Always use secure connection (SSL/TLS)** check box.
- 9.** If the SMTP server requires authentication to send an email, complete the following fields in the **SMTP Authentication** area:
- a. Select the **SMTP server requires authentication for outgoing e-mail messages** check box.
 - b. In the **SMTP User ID** field, enter the user ID for the SMTP server.
 - c. In the **SMTP Password** field, enter the password for the SMTP server.
- 10.** To require a PIN to be entered on the printer control panel before an email is sent using the email address, complete the following fields in the **Optional PIN** area:
- a. In the **PIN (Optional)** field, enter a four digit PIN.
 - b. In the **Confirm PIN** field, re-enter the four digit PIN.
-
-  **NOTE:** HP recommends creating a PIN to secure the email profile.
-  **NOTE:** When a PIN is created, it must be entered on the printer control panel each time the profile is used to send a scan to email.
-
- 11.** To configure optional email preferences, complete the following fields in the **E-mail Message Preferences** area:
- a. From the **Maximum Size for E-mail Message Attachments** drop-down, select the maximum size for email message attachments.
-
-  **NOTE:** HP recommends using the default file size of **Automatic** for the maximum size.
-
- b. To automatically copy the sender on email messages sent from the profile, select the **Auto CC** check box.
- 12.** Review all the information, and then click one of the following options:
- **Save and Test:** Select this option to save the information and test the connection.
 - **Save Only:** Select this option to save the information without testing the connection.
 - **Cancel:** Select this option to quit the configuration without saving.

Step three: Add contacts to the E-mail Address Book

- ▲ In the left navigation pane, click **E-mail Address Book** to add email addresses to the address book accessible from the printer.

To enter an individual email address complete the following task:

- In the **Contact Name** field, enter the name of the new email contact.
- In the **Contact E-mail Address**, enter the email address of the new email contact.
- Click **Add/Edit**.

To create an email group, complete the following task:

- Click **New Group**.
- In the **Enter the group name** field, enter a name for the new group.
- Click a name in the **All Individuals** area, and then click the arrow button to move it to the **Individuals in Group** area.



NOTE: Select multiple names at one time by pressing **Ctrl** and then clicking a name.

- Click **Save**.

Step four: Configure the default E-mail Options

- ▲ In the left navigation pane, click **E-mail options** to configure the default email options.
 - In the **Default Subject and Body Text** area, complete the following fields:
 - In the **E-mail Subject** field, enter a default subject line for the email messages.
 - In the **Body Text** field, enter a custom default message for the email messages.
 - Select **Show body text** to enable the default body text to display in emails.
 - Select **Hide body text** to suppress the default body text for an email.
 - In the **Scan Settings** area, complete the following fields:
 - From the **Scan File Type** drop-down, select the default file format for scanned files.
 - From the **Scan Paper Size** drop-down, select the default paper size for scanned files.
 - From the **Scan Resolution** drop-down, select the default resolution for scanned files.



NOTE: Higher resolution images have more dots per inch (dpi), so they show more detail. Lower resolution images have fewer dots per inch and show less detail, but the file size is smaller.

- From the **Output Color** drop-down, select **Black & White** or **Color**.
 - In the **File Name Prefix** field, enter a file name prefix (e.g., MyScan).
- Click **Apply**.



Set up the Scan to E-mail feature on a Mac

- [Step one: Access the HP Embedded Web Server \(EWS\)](#)
- [Step two: Configure the Scan to E-mail feature](#)
- [Step three: Add contacts to the E-mail Address Book](#)
- [Step four: Configure the default E-mail Options](#)

Step one: Access the HP Embedded Web Server (EWS)

Use one of the following methods to open the Embedded Web Server (EWS) interface.

Method one: Use a web browser to open the HP Embedded Web Server (EWS)

1. From the Home screen on the printer control panel, touch the Network  button or the Wireless  button to display the IP address or host name.
2. Open a web browser, and in the address line, type the IP address or host name exactly as it displays on the printer control panel. Press the **Enter** key on the computer keyboard. The EWS opens.

`https://10.10.XX.XXX/`

 **NOTE:** If the web browser displays a message indicating that accessing the website might not be safe, select the option to continue to the website. Accessing this website will not harm the computer.

Method two: Use the HP Utility to open the HP Embedded Web Server (EWS)

1. Open the **Applications** folder, select **HP**, and then select **HP Utility**. The main HP Utility screen displays.
2. In the main HP Utility screen, access the HP Embedded Web Server (EWS) in one of the following ways:
 - In the **Printer Settings** area, click **Additional Settings**, and then click **Open Embedded Web Server**.
 - In the **Scan Settings** area, click **Scan to Email**, and then click **Begin Scan to E-mail Setup....**

The HP Embedded Web Server (EWS) opens.

Step two: Configure the Scan to E-mail feature

1. In the HP EWS, click the **System** tab.
2. On the left navigation pane, click the **Administration** link.
3. In the Enabled Features area, set the **Scan to Email** option to **On**.
4. Click the **Scan** tab.
5. On the left navigation pane, click the **Outgoing E-mail Profiles** link.
6. On the **Outgoing E-mail Profiles** page, click the **New** button.
7. In the **E-mail Address** area, complete the following fields:

- a. In the **Your E-mail Address** field, enter the sender's email address for the new outgoing email profile.
 - b. In the **Display Name** field, enter the sender's name. This is the name that will display on the printer control panel.
8. In the **SMTP Server Settings** area, complete the following fields:
- a. In the **SMTP Server** field, enter the address of the SMTP server.
 - b. In the **SMTP Port** field, enter the SMTP port number.

 **NOTE:** In most cases, the default port number does not need to be changed.

 **NOTE:** If you are using a hosted SMTP service such as gmail, verify the SMTP address, port number, and SSL settings from the service provider's website or other sources. Typically, for gmail, the SMTP address is smtp.gmail.com, port number 465, and the SSL should be enabled.

Please refer to online sources to confirm these server settings are current and valid at the time of configuration.

- c. If you are using Google™ Gmail for email service, select the **Always use secure connection (SSL/TLS)** check box.
9. If the SMTP server requires authentication to send an email, complete the following fields in the **SMTP Authentication** area:
- a. Select the **SMTP server requires authentication for outgoing e-mail messages** check box.
 - b. In the **SMTP User ID** field, enter the user ID for the SMTP server.
 - c. In the **SMTP Password** field, enter the password for the SMTP server.
10. To require a PIN to be entered on the printer control panel before an email is sent using the email address, complete the following fields in the **Optional PIN** area:
- a. In the **PIN (Optional)** field, enter a four digit PIN.
 - b. In the **Confirm PIN** field, re-enter the four digit PIN.

 **NOTE:** HP recommends creating a PIN to secure the email profile.

 **NOTE:** When a PIN is created, it must be entered on the printer control panel each time the profile is used to send a scan to email.

11. To configure optional email preferences, complete the following fields in the **E-mail Message Preferences** area:
- a. From the **Maximum Size for E-mail Message Attachments** drop-down, select the maximum size for email message attachments.

 **NOTE:** HP recommends using the default file size of **Automatic** for the maximum size.

- b. To automatically copy the sender on email messages sent from the profile, select the **Auto CC** check box.
12. Review all the information, and then click one of the following options:

- **Save and Test:** Select this option to save the information and test the connection.
- **Save Only:** Select this option to save the information without testing the connection.
- **Cancel:** Select this option to quit the configuration without saving.

Step three: Add contacts to the E-mail Address Book

- ▲ In the left navigation pane, click **E-mail Address Book** to add email addresses to the address book accessible from the printer.

To enter an individual email address complete the following task:

- In the **Contact Name** field, enter the name of the new email contact.
- In the **Contact E-mail Address**, enter the email address of the new email contact.
- Click **Add/Edit**.

To create an email group, complete the following task:

- Click **New Group**.
- In the **Enter the group name** field, enter a name for the new group.
- Click a name in the **All Individuals** area, and then click the arrow button to move it to the **Individuals in Group** area.

 **NOTE:** Select multiple names at one time by pressing **Ctrl** and then clicking a name.

- Click **Save**.

Step four: Configure the default E-mail Options

- ▲ In the left navigation pane, click **E-mail options** to configure the default email options.

- In the **Default Subject and Body Text** area, complete the following fields:
 - In the **E-mail Subject** field, enter a default subject line for the email messages.
 - In the **Body Text** field, enter a custom default message for the email messages.
 - Select **Show body text** to enable the default body text to display in emails.
 - Select **Hide body text** to suppress the default body text for an email.
- In the **Scan Settings** area, complete the following fields:
 - From the **Scan File Type** drop-down, select the default file format for scanned files.
 - From the **Scan Paper Size** drop-down, select the default paper size for scanned files.
 - From the **Scan Resolution** drop-down, select the default resolution for scanned files.

 **NOTE:** Higher resolution images have more dots per inch (dpi), so they show more detail. Lower resolution images have fewer dots per inch and show less detail, but the file size is smaller.

- iv. From the **Output Color** drop-down, select **Black & White** or **Color**.
 - v. In the **File Name Prefix** field, enter a file name prefix (e.g., MyScan).
- c. Click **Apply**.

Set up the Scan to Network Folder feature (touchscreen models only)

- [Introduction](#)
- [Before you begin](#)
- [Method one: Use the Scan to Network Folder Wizard \(Windows\)](#)
- [Method two: Set up the Scan to Network Folder feature via the HP Embedded Web Server \(Windows\)](#)
- [Set up the Scan to Network Folder feature on a Mac](#)

Introduction

The printer has a feature that enables it to scan a document and save it to a network folder. To use this scan feature, the printer must be connected to a network; however, the feature is not available until it has been configured. There are two methods for configuring Scan to network folder, the Scan to Network Folder Wizard (Windows), which is installed in the HP program group for the printer as part of the full software installation in Windows 7, and the Network Folder Setup through the HP Embedded Web Server (EWS). Use the following information to set up the Scan to Network Folder feature.

Before you begin

To set up the Scan to Network Folder feature, the printer must have an active network connection to the same network as the computer that will run the setup process.

Administrators need the following information before beginning the configuration process.

- Administrative access to the printer
- The network path of the destination folder (e.g., \\servername.us.companyname.net\scans)



NOTE: The network folder must be set up as a shared folder for the Scan to Network Folder feature to work.

Method one: Use the Scan to Network Folder Wizard (Windows)

Some HP printers include driver installation from a software CD. At the end of this installation is an option to **Setup Scan to Folder and Email**. The setup wizards include the options for basic configuration.



NOTE: Some operating systems do not support the Scan to Network Folder Wizard.

1. Open the HP Printer Assistant.

- **Windows 8.1:** Click the down arrow in lower left corner of the **Start** screen, and then select the printer name.
 - **Windows 8:** Right-click an empty area on the **Start** screen, click **All Apps** on the app bar, and then select the printer name.
 - **Windows 7, Windows Vista, and Windows XP:** From the computer desktop, click **Start**, select **All Programs**, click **HP**, click the folder for the printer, select the icon with the printer's name, and then open **HP Printer Assistant**.
2. In the HP Printer Assistant, select **Scan**, and then select **Scan to Network Folder Wizard**.



NOTE: If the **Scan to Network Folder Wizard** option is not available, use [Method two: Set up the Scan to Network Folder feature via the HP Embedded Web Server \(Windows\) on page 81](#)

3. In the **Network Folder Profiles** dialog, click the **New** button. The **Scan to Network Folder Setup** dialog opens.
4. On the **1. Start** page, enter the folder name in the **Display Name** field. This is the name that will display on the printer control panel.
5. Complete the **Destination Folder** field in one of the following ways:
- a. Enter the file path manually.
 - b. Click the **Browse** button and navigate to the folder location.
 - c. Complete the following task to create a shared folder:
 - i. Click **Share Path**.
 - ii. In the **Manage Network Shares** dialog, click **New**.
 - iii. In the **Share Name** field, enter the name to display for the shared folder.
 - iv. To complete the Folder Path field, click the **Browse** button, and then select one of the following options. Click **OK** when done.
 - Navigate to an existing folder on the computer.
 - Click **Make New Folder** to create a new folder.
 - v. If the shared path needs a description, enter a description in the **Description** field.
 - vi. In the **Share Type** field, select one of the following options, and then click **Apply**.
 - **Public**
 - **Private**
-  **NOTE:** For security considerations, HP recommends selecting **Private** as the share type.
- vii. When a **The share was successfully created** message displays, click **OK**.
 - viii. Select the check box for the destination folder, and then click **OK**.
6. To create a shortcut to the network folder on the computer desktop, select the **Create a Desktop shortcut to the network folder** check box

7. To require a PIN to be entered on the printer control panel before the printer can send a scanned document to a network folder, enter a 4-digit PIN in the **Security PIN** field, and then re-enter the PIN in the **Confirm Security PIN** field. Click **Next**.

 **NOTE:** HP recommends creating a PIN to secure the destination folder.

 **NOTE:** When a PIN is created, it must be entered on the printer control panel each time a scan is sent to the network folder.

8. On the **2. Authenticate** page, enter the Windows **User Name** and Windows **Password** used to log in to the computer, and then click **Next**.

9. On the **3. Configure** page, select the default scan settings by completing the following task, and then click **Next**.

- a. From the **Document Type** drop-down, select the default file format for scanned files.
- b. From the **Color Preference** drop-down, select Black & White or Color.
- c. From the **Paper Size** drop-down, select the default paper size for scanned files.
- d. From the **Quality Settings** drop-down, select the default resolution for scanned files.



 **NOTE:** Higher resolution images have more dots per inch (dpi), so they show more detail. Lower resolution images have fewer dots per inch and show less detail, but the file size is smaller.

- e. In the **Filename Prefix** field, enter a file name prefix (e.g., MyScan).
10. On the **4. Finish** page, review the information and verify all the settings are correct. If there is an error, click the **Back** button to correct the error. If the settings are correct, click the **Save and Test** button to test the configuration.
 11. When the **Congratulations** message displays, click **Finish** to complete the configuration.
 12. The **Network Folder Profiles** dialog now shows the newly added sender email profile. Click **Close** to exit the wizard.

Method two: Set up the Scan to Network Folder feature via the HP Embedded Web Server (Windows)

- [Step one: Access the HP Embedded Web Server \(EWS\)](#)
- [Step two: Configure the Scan to Network Folder feature](#)

Step one: Access the HP Embedded Web Server (EWS)

1. From the Home screen on the printer control panel, touch the Network  button or the Wireless  button to display the IP address or host name.
2. Open a web browser, and in the address line, type the IP address or host name exactly as it displays on the printer control panel. Press the **Enter** key on the computer keyboard. The EWS opens.

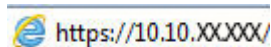

 **NOTE:** If the web browser displays a message indicating that accessing the website might not be safe, select the option to continue to the website. Accessing this website will not harm the computer.

Step two: Configure the Scan to Network Folder feature

1. In the HP EWS, click the **System** tab.
2. On the left navigation pane, click the **Administration** link.
3. In the Enabled Features area, set the **Scan to Network Folder** option to **On**.
4. Click the **Scan** tab.
5. On the left navigation pane, make sure that the **Network Folder Setup** link is highlighted. The **Scan to Network Folder** page should be displayed.
6. On the **Network Folder Configuration** page, click the **New** button.
7. In the **Network Folder Information** area, complete the following fields:
 - a. In the **Display Name** field, enter the name to display for the folder.
 - b. In the **Network Path** field, enter the network path to the folder.
 - c. In the **Username** field, enter the user name needed to access the folder on the network.
 - d. In the **Password** field, enter the password needed to access the folder on the network.
8. To require a PIN to be entered on the printer control panel before the printer can send a file to a network folder, complete the following fields in the **Secure the Folder Access with a PIN** area:
 - a. In the **PIN (Optional)** field, enter a four digit PIN.
 - b. In the **Confirm PIN** field, re-enter the four digit PIN.

 **NOTE:** HP recommends creating a PIN to secure the destination folder.

 **NOTE:** When a PIN is created, it must be entered on the printer control panel each time a scan is sent to the network folder.

9. In the **Scan Settings** area, complete the following fields:
 - a. From the **Scan File Type** drop-down, select the default file format scanned files.
 - b. From the **Scan Paper Size** drop-down, select the default paper size for scanned files.
 - c. From the **Scan Resolution** drop-down, select the default scan resolution for scanned files.

 **NOTE:** Higher resolution images have more dots per inch (dpi), so they show more detail. Lower resolution images have fewer dots per inch and show less detail, but the file size is smaller.

- d. In the **Output Color** drop-down, select whether scanned files will be in black and white or in color.
 - e. In the **File Name Prefix** field, enter a file name prefix (e.g., MyScan).
10. Review all the information, and then click one of the following options:
 - **Save and Test:** Select this option to save the information and test the connection.
 - **Save Only:** Select this option to save the information without testing the connection.
 - **Cancel:** Select this option to quit the configuration without saving.



Set up the Scan to Network Folder feature on a Mac

- [Step one: Access the HP Embedded Web Server \(EWS\)](#)
- [Step two: Configure the Scan to Network Folder feature](#)

Step one: Access the HP Embedded Web Server (EWS)

Use one of the following methods to open the Embedded Web Server (EWS) interface.

Method one: Use a web browser to open the HP Embedded Web Server (EWS)

1. From the Home screen on the printer control panel, touch the Network  button or the Wireless  button to display the IP address or host name.
2. Open a web browser, and in the address line, type the IP address or host name exactly as it displays on the printer control panel. Press the **Enter** key on the computer keyboard. The EWS opens.

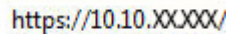

 **NOTE:** If the web browser displays a message indicating that accessing the website might not be safe, select the option to continue to the website. Accessing this website will not harm the computer.

Method two: Use the HP Utility to open the HP Embedded Web Server (EWS)

1. Open the **Applications** folder, select **HP**, and then select **HP Utility**. The main HP Utility screen displays.
2. In the main HP Utility screen, access the HP Embedded Web Server (EWS) in one of the following ways:
 - In the **Printer Settings** area, click Additional Settings and then click **Open Embedded Web Server**.
 - In the **Scan Settings** area, click **Scan to Network Folder**, and then click **Register My Shared Folder....**

 **NOTE:** If you do not have a shared network folder available, click **Help Me Do This** to view information about creating the folder.

The HP Embedded Web Server (EWS) opens.

Step two: Configure the Scan to Network Folder feature

1. In the HP EWS, click the **System** tab.
2. On the left navigation pane, click the **Administration** link.
3. In the Enabled Features area, set the **Scan to Network Folder** option to **On**.
4. Click the **Scan** tab.
5. On the left navigation pane, make sure that the **Network Folder Setup** link is highlighted. The **Scan to Network Folder** page should be displayed.
6. On the **Network Folder Configuration** page, click the **New** button.
7. In the **Network Folder Information** area, complete the following fields:

- a. In the **Display Name** field, enter the name to display for the folder.
 - b. In the **Network Path** field, enter the network path to the folder.
 - c. In the **Username** field, enter the user name needed to access the folder on the network.
 - d. In the **Password** field, enter the password needed to access the folder on the network.
8. To require a PIN to be entered on the printer control panel before the printer can send a file to a network folder, complete the following fields in the **Secure the Folder Access with a PIN** area:
- a. In the **PIN (Optional)** field, enter a four digit PIN.
 - b. In the **Confirm PIN** field, re-enter the four digit PIN.

 **NOTE:** HP recommends creating a PIN to secure the destination folder.

 **NOTE:** When a PIN is created, it must be entered on the printer control panel each time a scan is sent to the network folder.

9. In the **Scan Settings** area, complete the following fields:
- a. From the **Scan File Type** drop-down, select the default file format scanned files.
 - b. From the **Scan Paper Size** drop-down, select the default paper size for scanned files.
 - c. From the **Scan Resolution** drop-down, select the default scan resolution for scanned files.

 **NOTE:** Higher resolution images have more dots per inch (dpi), so they show more detail. Lower resolution images have fewer dots per inch and show less detail, but the file size is smaller.

- d. In the **Output Color** drop-down, select whether scanned files will be in black and white or in color.
 - e. In the **File Name Prefix** field, enter a file name prefix (e.g., MyScan).
10. Review all the information, and then click one of the following options:
- **Save and Test:** Select this option to save the information and test the connection.
 - **Save Only:** Select this option to save the information without testing the connection.
 - **Cancel:** Select this option to quit the configuration without saving.

Scan to email (touchscreen models only)

Use the printer control panel to scan a file directly to an email address. The scanned file is sent to the address as an email message attachment.

 **NOTE:** In order to use this feature, the printer must be connected to a network and the Scan to Email feature must be configured by using the Scan to Email Setup Wizard (Windows) or the HP Embedded Web Server.

1. Load the document on the scanner glass according to the indicators on the printer.
2. From the Home screen on the printer control panel, touch the **Scan**  icon.
3. Touch **Scan to E-mail**.
4. Select the **From** address that you want to use. This is also known as an “outgoing email profile.”

 **NOTE:** If the printer is configured with only one outgoing email profile, then this option will not be available.

 **NOTE:** If the PIN feature has been set up, enter the PIN and touch the **OK** button. However, a PIN is not required to use this feature.

5. Touch the **To** button and pick the address or group to which you want to send the file. Touch the **Done** button when finished.
 - To send the message to a different address, touch the **New** button again and then enter the email address.
6. Touch the **Subject** button if you would like to add a subject line
7. To view the scan settings, touch **Settings**.
To change a scan setting, touch **Edit** and then change the setting.
8. Touch the **Scan** button to start the scan job.

Scan to a network folder (touchscreen models only)

Use the printer control panel to scan a document and save it to a folder on the network.



NOTE: In order to use this feature, the printer must be connected to a network and the Scan to Network Folder feature must be configured by using the Scan to Network Folder Setup Wizard (Windows) or the HP Embedded Web Server.

1. Load the document on the scanner glass according to the indicators on the printer.
2. From the Home screen on the printer control panel, touch the **Scan**  icon.
3. Touch the **Scan to Network Folder** item.
4. In the list of network folders, select the folder to which you want to save the document.
5. The control panel screen displays the scan settings.
 - If you want to change any of the settings, touch the **Settings** button, and then change the settings.
 - If the settings are correct, go to the next step.
6. Touch the **Scan** button to start the scan job.

Additional scan tasks

Go to www.hp.com/support/ljM129MFP.

Instructions are available for performing specific scan tasks, such as the following:

- How to scan a general photo or document
- How to scan as editable text (OCR)
- How to scan multiple pages into a single file

7 Fax

- [Set up to send and receive faxes](#)
- [Send a fax](#)
- [Additional fax tasks](#)

For more information:

The following information is correct at the time of publication. For current information, see www.hp.com/support/ljM129MFP.

HP's all-inclusive help for the printer includes the following information:

- Install and configure
- Learn and use
- Solve problems
- Download software and firmware updates
- Join support forums
- Find warranty and regulatory information

Set up to send and receive faxes

- [Before starting](#)
- [Step 1: Identify the phone connection type](#)
- [Step 2: Set up the fax](#)
- [Step 3: Configure the fax time, date, and header](#)
- [Step 4: Run a fax test](#)

Before starting

Make sure that the printer was fully set up before connecting the fax service.



NOTE: Use the telephone cable and any adapters that shipped with the printer to connect the printer to the telephone jack.



NOTE: In countries/regions that use serial telephone systems, an adapter is shipped with the printer. Use the adapter to connect other telecom devices to the same telephone jack the printer is connected to.

Complete the instructions in each of the following four steps:

[Step 1: Identify the phone connection type on page 90.](#)

[Step 2: Set up the fax on page 91.](#)

[Step 3: Configure the fax time, date, and header on page 94.](#)

[Step 4: Run a fax test on page 96.](#)

Step 1: Identify the phone connection type

Review the following equipment and service types to determine which setup method to use. The method used depends on the equipment and services already installed on the phone system.



NOTE: The printer is an analog device. HP recommends using the printer on a dedicated analog telephone line.

- **Dedicated phone line:** The printer is the only piece of equipment or service connected to the phone line
- **Voice calls:** Voice and fax calls use the same phone line
- **Answering machine:** An answering machine answers voice calls on the same phone line used for fax calls
- **Voice mail:** A voice-mail subscription service uses the same phone line as the fax
- **Distinctive ring service:** A service from the telephone company that allows several phone numbers to be associated with one phone line, and each number has a different ring pattern; the printer detects the ring pattern assigned to it and answers the call
- **Computer dial-up modem:** A computer uses the phone line to connect to the Internet through a dial-up connection
- **DSL line:** A digital subscriber line (DSL) service from the telephone company; this service might be called ADSL in some countries/regions

- **PBX or ISDN phone system:** A private branch exchange (PBX) phone system or an integrated services digital network (ISDN) system
- **VoIP phone system:** Voice over Internet protocol (VoIP) through an Internet provider

Step 2: Set up the fax

Click the link below that best describes the environment in which the printer will be sending and receiving faxes, and follow the setup instructions.

- [Dedicated phone line on page 91](#)
- [Shared voice/fax line on page 92](#)
- [Shared voice/fax line with an answering machine on page 93](#)

Instructions for only three of the connection types are included here. For more information about connecting the printer with other connection types, go to the support website www.hp.com/support/ljM129MFP.

 **NOTE:** This printer is an analog fax device. HP recommends using the printer on a dedicated analog telephone line. For a digital environment, such as DSL, PBX, ISDN, or VoIP, make sure to use the correct filters and configure the digital settings correctly. For more information, contact the digital service provider.

 **NOTE:** Do not connect more than three devices to the telephone line.

 **NOTE:** Voice mail is not supported with this printer.

Dedicated phone line

Follow these steps to set up the printer on a dedicated phone line with no additional services.

1. Connect the telephone cable to the fax port on the printer and to the telephone jack on the wall.

 **NOTE:** Some countries/regions might require an adapter for the telephone cable that came with the printer.

 **NOTE:** On some printers, the fax port might be above the phone port. Refer to the icons on the printer.

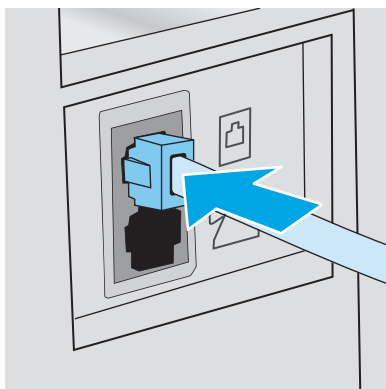

2. Set the printer to answer fax calls automatically.
 - a. Turn the printer on.
 - b. From the control panel, open the **Setup** menu.
 - c. Select the **Fax Setup** menu.

- d. Select the **Basic Setup** menu.
 - e. Select the **Answer Mode** setting.
 - f. Select the **Automatic** option.
3. Continue to [Step 3: Configure the fax time, date, and header on page 94](#).

Shared voice/fax line

Follow these steps to set up the printer on a shared voice/fax line.

1. Disconnect any devices that are connected to the telephone jack.
2. Connect the telephone cable to the fax port on the printer and to the telephone jack on the wall.

 **NOTE:** Some countries/regions might require an adapter to the telephone cable that came with the printer.

 **NOTE:** On some printers, the fax port might be above the phone port. Refer to the icons on the printer.

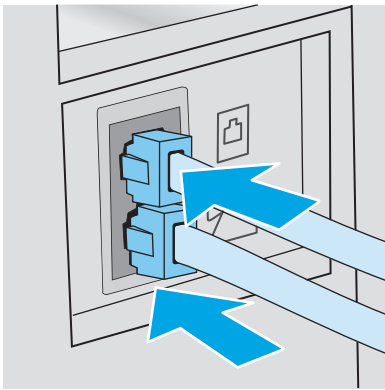

3. Remove the plug from the telephone line out port on the rear of the printer, and then connect a phone to this port.
4. Set the printer to answer fax calls automatically.
 - a. Turn the printer on.
 - b. From the control panel, open the **Setup** menu.
 - c. Select the **Fax Setup** menu.
 - d. Select the **Basic Setup** menu.
 - e. Select the **Answer Mode** setting, and then select the **Automatic** option.
5. Set the printer to check for a dial tone before sending a fax.

 **NOTE:** This prevents the printer from sending a fax while someone is on the telephone.

- a. From the control panel, open the **Setup** menu.
- b. Select the **Fax Setup** menu.

- c. Select the [Advanced Setup](#) menu.
 - d. Select the [Detect Dial Tone](#) setting, and then select [On](#).
6. Continue to [Step 3: Configure the fax time, date, and header on page 94](#).

Shared voice/fax line with an answering machine

Follow these steps to set up the printer on a shared voice/fax line with an answering machine.

1. Disconnect any devices that are connected to the telephone jack.
2. Remove the plug from the telephone line out port on the rear of the printer.
3. Connect the telephone cable to the fax port on the printer and to the telephone jack on the wall.

 **NOTE:** Some countries/regions might require an adapter for the telephone cable that came with the printer.

 **NOTE:** On some printers, the fax port might be above the phone port. Refer to the icons on the printer.

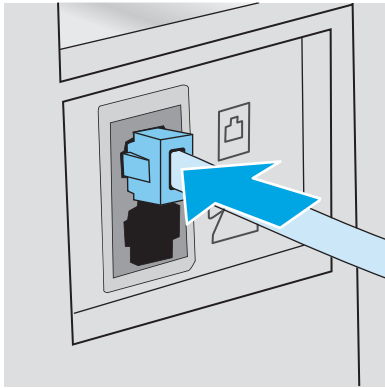

4. Connect the answering machine telephone cable to the telephone line out port on the rear of the printer.

 **NOTE:** Connect the answering machine directly to the printer, or the answering machine might record fax tones from a sending fax machine and the printer might not receive faxes.

 **NOTE:** If the answering machine does not have a built-in telephone, connect a telephone to the **OUT** port on the answering machine for convenience.

 **NOTE:** On some printers, the fax port might be above the phone port. Refer to the icons on the printer.

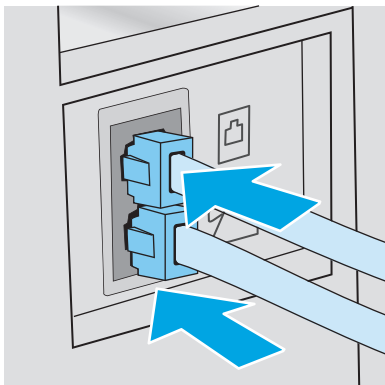

5. Configure the rings to answer setting on the printer.
 - a. Turn the printer on.
 - b. From the control panel, open the [Setup](#) menu.
 - c. Select the [Fax Setup](#) menu.
 - d. Select the [Basic Setup](#) menu.
 - e. Select the [Rings to Answer](#) option.
 - f. Use the numeric keypad on the printer control panel to set the number of rings to 5 or more, and then select [OK](#).
6. Set the printer to answer fax calls automatically.
 - a. From the control panel, open the [Setup](#) menu.
 - b. Select the [Fax Setup](#) menu.
 - c. Select the [Basic Setup](#) menu.
 - d. Select the [Answer Mode](#) setting, and then select the [Automatic](#) option.
7. Set the printer to check for a dial tone before sending a fax.



NOTE: This prevents the printer from sending a fax while someone is on the telephone.

- a. From the control panel, open the [Setup](#) menu.
 - b. Select the [Fax Setup](#) menu.
 - c. Select the [Advanced Setup](#) menu.
 - d. Select the [Detect Dial Tone](#) setting, and then select the **On** button.
8. Continue to [Step 3: Configure the fax time, date, and header on page 94](#).

Step 3: Configure the fax time, date, and header

Configure the printer fax settings using one of the following methods:

- [HP Fax Setup Wizard on page 94](#) (recommended method)
- [Printer control panel on page 95](#)
- [HP Embedded Web Server \(EWS\) and HP Device Toolbox \(Windows\) on page 95](#) (if the software is installed)



NOTE: In the United States and many other countries/regions, setting the time, date, and other fax header information is a legal requirement.

HP Fax Setup Wizard

Access the Fax Setup Wizard after *initial* setup and software installation by following these steps.



NOTE: Some operating systems do not support the Fax Setup Wizard.

1. Open the HP Printer Assistant.

- **Windows 8.1:** Click the down arrow in lower left corner of the **Start** screen, and then select the printer name.
 - **Windows 8:** Right-click an empty area on the **Start** screen, click **All Apps** on the app bar, and then select the printer name.
 - **Windows 7, Windows Vista, and Windows XP:** From the computer desktop, click **Start**, select **All Programs**, click **HP**, click the folder for the printer, select the icon with the printer's name, and then open **HP Printer Assistant**.
2. In the HP Printer Assistant, select **Fax**, and then select **Fax Setup Wizard**.
 3. Follow the on-screen instructions in the HP Fax Setup Wizard to configure the fax settings.
 4. Continue to [Step 4: Run a fax test on page 96](#).

Printer control panel

To use the control panel to set the date, time, and header, complete the following steps.

1. From the control panel, open the [Setup](#) menu.
2. Select the [Fax Setup](#) menu.
3. Select the [Basic Setup](#) menu.
4. Select the [Time/Date](#) option.
5. Select [12-hour clock](#) or [24-hour clock](#).
6. Use the keypad to enter the current time, and then select **OK**.



NOTE: Touchscreen control panels: Select the [123](#) button to open a keypad that contains special characters, if needed.

7. Select the date format.
8. Use the keypad to enter the current date, and then select **OK**.
9. Select the [Fax Header](#) menu.
10. Use the keypad to enter the fax number, and then select **OK**.



NOTE: The maximum number of characters for the fax number is 20.

11. Use the keypad to enter the company name or header, and then select **OK**.



NOTE: The maximum number of characters for the fax header is 25.

12. Continue to [Step 4: Run a fax test on page 96](#).

HP Embedded Web Server (EWS) and HP Device Toolbox (Windows)

1. Start the HP EWS either from the **Start** menu or a web browser.





Start menu

- a. Open the HP Printer Assistant.

- **Windows 8.1:** Click the down arrow in lower left corner of the **Start** screen, and then select the printer name.
 - **Windows 8:** Right-click an empty area on the **Start** screen, click **All Apps** on the app bar, and then select the printer name.
 - **Windows 7, Windows Vista, and Windows XP:** From the computer desktop, click **Start**, select **All Programs**, click **HP**, click the folder for the printer, select the icon with the printer's name, and then open **HP Printer Assistant**.
- b. In the HP Printer Assistant, select **Print**, and then select **HP Device Toolbox**.

Web browser

- a. **2-line control panels:** From the control panel, press the Setup  button. Open the **Network Setup** menu, and then select **Show IP Address** to display the IP address or host name.

Touchscreen control panels: From the control panel, touch the Connection Information  /  button, and then touch the **Network Connected**  button or the **Network Wi-Fi ON**  button to display the IP address or host name.

- b. Open a web browser, and in the address line, type the IP address or host name exactly as it displays on the printer control panel. Press the **Enter** key on the computer keyboard. The EWS opens.

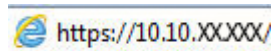

 **NOTE:** If the web browser displays a message indicating that accessing the website might not be safe, select the option to continue to the website. Accessing this website will not harm the computer.

2. Click the **Fax** tab.
3. Follow the on-screen instructions to configure the fax settings.
4. Continue to [Step 4: Run a fax test on page 96](#).

Step 4: Run a fax test

Run a fax test to make sure that the fax is set up correctly.

1. From the control panel, open the **Setup** menu.
2. Select the **Service** menu.
3. Select the **Fax Service** menu.
4. Select the **Run Fax Test** option. The printer prints a test report.
5. Review the report.
 - If the report indicates the printer **passed the test**, the printer is ready to send and receive faxes.
 - If the report indicates the printer **failed the test**, review the report for more information about fixing the problem. The fax troubleshooting checklist has more information on resolving fax problems.

Send a fax

- [Fax from the flatbed scanner](#)
- [Fax from the document feeder \(document feeder models only\)](#)
- [Use speed dials and group-dial entries](#)
- [Send a fax from the software](#)
- [Send a fax from a third-party software program, such as Microsoft Word](#)

Fax from the flatbed scanner

1. Place the document face-down on the scanner glass.



2. From the Home screen on the printer control panel, touch the **Fax**  icon.
3. Use the keypad to enter the fax number.
4. Touch the **Start Fax** button.
5. The printer prompts you to confirm that you are sending from the scanner glass. Touch the **Yes** button.
6. The printer prompts you to load the first page. Touch the **OK** button.
7. The printer scans the first page and then prompts you to load another page. If the document has multiple pages, touch the **Yes** button. Continue this process until you have scanned all the pages.
8. When you have scanned the last page, touch the **No** button at the prompt. The printer sends the fax.

Fax from the document feeder (document feeder models only)

1. Insert the originals into the document feeder face-up.

CAUTION: To prevent damage to the printer, do not use an original that contains correction tape, correction fluid, paper clips, or staples. Also, do not load photographs, small originals, or fragile originals into the document feeder.

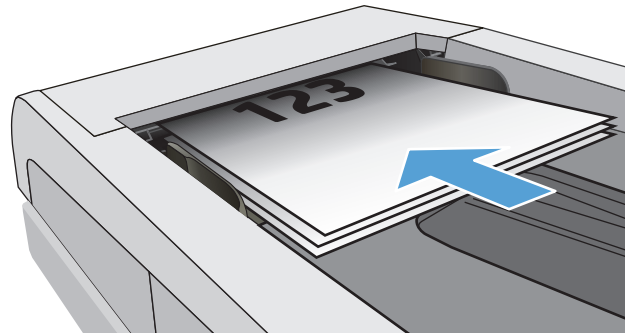

2. Adjust the paper guides until they are snug against the paper.

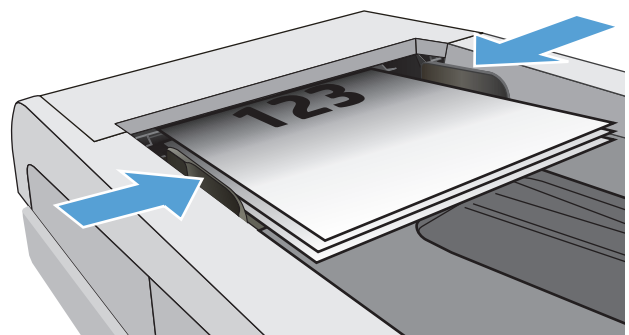

3. From the Home screen on the printer control panel, touch the **Fax**  icon.
4. Use the keypad to enter the fax number.
5. Touch the **Start Fax** button.

Use speed dials and group-dial entries



NOTE: Phone book entries must be set up using the **Fax Menu** prior to using the phone book to send faxes.

1. Load the document onto the scanner glass or into the document feeder.

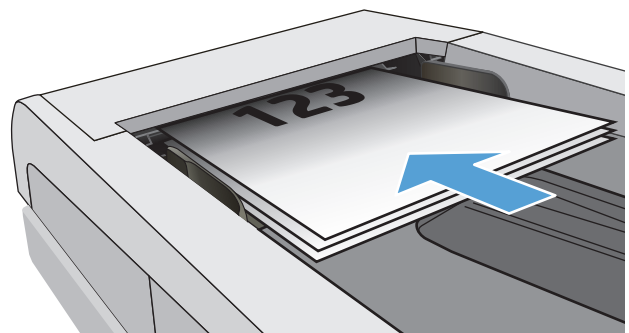

2. From the Home screen on the printer control panel, touch the **Fax**  icon.
3. On the keypad, touch the fax phone book icon.
4. Touch the name of the individual or group entry that you want to use.
5. Touch the **Start Fax** button.

Send a fax from the software

The procedure to send a fax varies according to your specifications. The most typical steps follow.

1. Open the HP Printer Assistant.
 - **Windows 8.1:** Click the down arrow in lower left corner of the **Start** screen, and then select the printer name.
 - **Windows 8:** Right-click an empty area on the **Start** screen, click **All Apps** on the app bar, and then select the printer name.
 - **Windows 7, Windows Vista, and Windows XP:** From the computer desktop, click **Start**, select **All Programs**, click **HP**, click the folder for the printer, select the icon with the printer's name, and then open **HP Printer Assistant**.
2. In the HP Printer Assistant, select **Fax**, and then select **Send Fax**. The fax software opens.
3. Enter the fax number of one or more recipients.
4. Load the document on the scanner glass or in the document feeder.
5. Click **Send Now**.

Send a fax from a third-party software program, such as Microsoft Word

1. Open a document in a third-party program.
2. Click the **File** menu, and then click **Print**.
3. Select the fax print driver from the print driver drop-down list. The fax software opens.
4. Enter the fax number of one or more recipients.
5. Include any pages loaded at the printer. This step is optional.
6. Click **Send Now**.

Additional fax tasks

Go to www.hp.com/support/ljM129MFP.

Instructions are available for performing specific fax tasks, such as the following:

- Create and manage fax speed dial lists
- Configure fax billing codes
- Use a fax printing schedule
- Block incoming faxes
- Fax archiving and forwarding

8 Manage the printer

- [Use HP Web Services applications \(touchscreen models only\)](#)
- [Change the printer connection type \(Windows\)](#)
- [Advanced configuration with HP Embedded Web Server \(EWS\) and HP Device Toolbox \(Windows\)](#)
- [Advanced configuration with HP Utility for OS X](#)
- [Configure IP network settings](#)
- [Printer security features](#)
- [Energy-conservation settings](#)
- [Update the firmware](#)

For more information:

The following information is correct at the time of publication. For current information, see www.hp.com/support/ljM129MFP.

HP's all-inclusive help for the printer includes the following information:

- Install and configure
- Learn and use
- Solve problems
- Download software and firmware updates
- Join support forums
- Find warranty and regulatory information

Use HP Web Services applications (touchscreen models only)

HP Web Services applications provide useful content that can be automatically downloaded from the Internet to the printer. Choose from a variety of applications including news, calendars, forms, and cloud-based document storage.

To activate these applications and schedule the downloads, go to the HP Connected website at www.hpconnected.com



NOTE: To use this feature, the printer must be connected to a wired or wireless network and have internet access. HP Web Services must be enabled on the printer.

Enable Web Services

This process enables both HP Web Services and the **Apps** button.

1. From the Home screen on the printer control panel, swipe until the **Setup** menu displays. Touch the **Setup** icon to open the menu.
2. Touch **HP Web Services**.
3. Touch **Enable Web Services**.
4. To print the HP Web Services Terms of Use, touch **Print**.
5. Touch **OK** to complete the procedure.

After you download an application from the HP Connected website, it is available in the **Apps** menu on the printer control panel.

Change the printer connection type (Windows)

If you are already using the printer and you wish to change the way it is connected, use the **Device Setup & Software** shortcut on your computer desktop to change the connection. For example, connect the new printer to the computer using a USB or network connection, or change the connection from a USB to a wireless connection.

Advanced configuration with HP Embedded Web Server (EWS) and HP Device Toolbox (Windows)

Use the HP Embedded Web Server to manage printing functions from a computer instead of the printer control panel.

- View printer status information
- Determine the remaining life for all supplies and order new ones
- View and change tray configurations
- View and change the printer control-panel menu configuration
- View and print internal pages
- Receive notification of printer and supplies events
- View and change network configuration

The HP Embedded Web Server works when the printer is connected to an IP-based network. The HP Embedded Web Server does not support IPX-based printer connections. Internet access is not needed to open and use the HP Embedded Web Server.

When the printer is connected to the network, the HP Embedded Web Server is automatically available.

 **NOTE:** HP Device Toolbox is software used to connect to the HP Embedded Web Server when the printer is connected to a computer via USB. It is available only if a full installation was performed when the printer was installed on a computer. Depending on how the printer is connected, some features might not be available.

 **NOTE:** The HP Embedded Web Server is not accessible beyond the network firewall.

Method one: Open the HP Embedded Web Server (EWS) from the Start menu

1. Open the HP Printer Assistant.
 - **Windows 8.1:** Click the down arrow in lower left corner of the **Start** screen, and then select the printer name.
 - **Windows 8:** Right-click an empty area on the **Start** screen, click **All Apps** on the app bar, and then select the printer name.
 - **Windows 7, Windows Vista, and Windows XP:** From the computer desktop, click **Start**, select **All Programs**, click **HP**, click the folder for the printer, select the icon with the printer's name, and then open **HP Printer Assistant**.
2. In the HP Printer Assistant, select **Print**, and then select **HP Device Toolbox**.

Method two: Open the HP Embedded Web Server (EWS) from a browser

 **NOTE:** The steps vary according to the type of control panel.

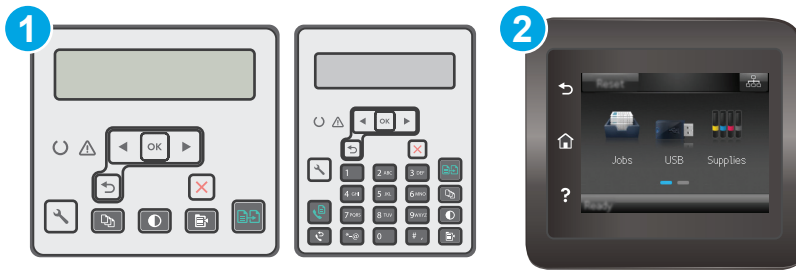

- 1 2-line control panel
- 2 Touchscreen control panel

1. 2-line control panels: On the printer control panel, press the Setup button. Open the **Network Setup** menu, and then select **Show IP Address** to display the IP address or host name.

Touchscreen control panels: From the Home screen on the printer control panel, touch the Connection Information / button, and then touch the **Network Connected** button or the **Network Wi-Fi ON** button to display the IP address or host name.

2. Open a web browser, and in the address line, type the IP address or host name exactly as it displays on the printer control panel. Press the **Enter** key on the computer keyboard. The EWS opens.

<https://10.10.XX.XX/>

NOTE: If the web browser displays a message indicating that accessing the website might not be safe, select the option to continue to the website. Accessing this website will not harm the computer.

Tab or section	Description
Home tab Provides printer, status, and configuration information.	<ul style="list-style-type: none"> • Device Status: Shows the printer status and shows the approximate percent life remaining of HP supplies. • Supplies Status: Shows the approximate percent life remaining of HP supplies. Actual supply life remaining can vary. Consider having a replacement supply available to install when print quality is no longer acceptable. The supply does not need to be replaced unless the print quality is no longer acceptable. • Device Configuration: Shows the information found on the printer configuration page. • Network Summary: Shows the information found on the printer network configuration page. • Reports: Print the configuration and supplies status pages that the printer generates. • Event Log: Shows a list of all printer events and errors.

Tab or section	Description
<p>System tab</p> <p>Provides the ability to configure the printer from your computer.</p>	<ul style="list-style-type: none"> • Device Information: Provides basic printer and company information. • Paper Setup: Change the default paper-handling settings for the printer. • Print Quality: Change the default print-quality settings for the printer. • Energy Settings: Change the default times for entering Sleep/Auto Off mode or automatic shut down. • Paper Types: Configure print modes that correspond to the paper types that the printer accepts. • System Setup: Change the system defaults for the printer. • Supply Settings: Change the settings for Cartridge is low alerts and other supplies information. • Service: Perform the cleaning procedure on the printer. • Save and Restore: Save the current settings for the printer to a file on the computer. Use this file to load the same settings onto another printer or to restore these settings to this printer at a later time. • Administration: Set or change the printer password. Enable or disable printer features. <p>NOTE: The System tab can be password-protected. If this printer is on a network, always consult with the administrator before changing settings on this tab.</p>
<p>Print tab</p> <p>Provides the ability to change default print settings from your computer.</p>	<ul style="list-style-type: none"> • Printing: Change the default printer print settings, such as number of copies and paper orientation. These are the same options that are available on the printer control panel.
<p>Fax tab</p> <p>(Fax printers only)</p>	<ul style="list-style-type: none"> • Receive Options: Configure how the printer handles incoming faxes. • Phone Book: Add or delete entries in the fax phone book. • Junk Fax List: Set fax numbers to block from sending faxes to the printer. • Fax Activity Log: Review recent fax activity for the printer.
<p>Scan tab</p> <p>(MFP models only)</p>	<p>Configure the Scan to Network Folder and Scan to E-mail features.</p> <ul style="list-style-type: none"> • Network Folder Setup: Configure folders on the network to which the printer can save a scanned file. • Scan to E-mail Setup: Begin the process to set up the Scan to E-mail feature. • Outgoing E-mail Profiles: Set an email address that will appear as the “from” address for all emails sent from the printer. • E-mail Address Book: Add or delete entries in the email address book. • E-mail Options: Configure a default subject line and body text. Configure default scan settings for emails.
<p>Copy tab</p>	<p>Use this tab to set up the default copy settings.</p>

Tab or section	Description
Networking tab (Network-connected printers only) Provides the ability to change network settings from your computer.	Network administrators can use this tab to control network-related settings for the printer when it is connected to an IP-based network. It also allows the network administrator to set up Wi-Fi Direct functionality. This tab does not appear if the printer is directly connected to a computer.
HP Web Services tab	Use this tab to set up and use various web tools with the printer.

Advanced configuration with HP Utility for OS X

Use the HP Utility to check printer status or to view or change printer settings from a computer.

You can use the HP Utility when the printer is connected with a USB cable or is connected to a TCP/IP-based network.

Open HP Utility

1. At the computer, open the **Applications** folder.
2. Select **HP**, and then select **HP Utility**.

HP Utility features

The HP Utility toolbar includes these items:

- **Devices:** Click this button to show or hide Mac products found by the HP Utility.
- **All Settings:** Click this button to return to the HP Utility main view.
- **HP Support:** Click this button to open a browser and go to the HP support website.
- **Supplies:** Click this button to open the HP SureSupply website.
- **Registration:** Click this button to open the HP registration website.
- **Recycling:** Click this button to open the HP Planet Partners Recycling Program website.

HP Utility consists of pages that you open by clicking in the **All Settings** list. The following table describes the tasks that you can perform with HP Utility.

Item	Description
Supplies Status	Show the printer supplies status and provides links for ordering supplies online.
Device Information	Show information about the currently selected printer, including the printer Service ID (if assigned), the firmware version (FW Version), the Serial Number, and the IP address.
Commands	Send special characters or print commands to the printer after the print job. NOTE: This option is available only after you open the View menu and select the Show Advanced Options item.
File Upload	Transfer files from the computer to the printer. You can upload the following types of files: <ul style="list-style-type: none">◦ HP LaserJet printer command language (.PRN)◦ Portable document format (.PDF)◦ Postscript (.PS)◦ Text (.TXT)
Power Management	Configure the printer economy settings.
Update Firmware	Transfer a firmware update file to the printer. NOTE: This option is available only after you open the View menu and select the Show Advanced Options item.

Item	Description
HP Connected	Access the HP Connected website.
Message Center	Display error events that have occurred with the printer.
Duplex Mode (Duplex printers only)	Turn on the automatic two-sided printing mode.
Network Settings (Network-connected printers only)	Configure the network settings, such as the IPv4 settings, IPv6 settings, Bonjour settings, and other settings.
Supplies Management	Configure how the printer should behave when supplies are nearing the end of their estimated life.
Trays Configuration	Change paper size and type for each of the trays.
Additional Settings	Open the HP Embedded Web Server (EWS) for the printer. NOTE: USB connections are not supported.
Proxy Server Settings	Configure a proxy server for the printer.
Basic Fax Settings (MFP fax models only)	Set up the fields in the fax header and configure how the printer answers incoming calls.
Fax Forwarding (MFP fax models only)	Set up the printer to send the incoming faxes to a different number.
Fax Logs (MFP fax models only)	View the logs of all faxes.
Fax Speed Dials (MFP fax models only)	Add fax numbers to the speed dial list.
Junk Fax Blocking (MFP fax models only)	Store the fax numbers you want to block.
Scan to E-mail (MFP printers only)	Open the HP Embedded Web Server (EWS) page for configuring settings for scanning to email.
Scan to Network Folder (MFP printers only)	Open the HP Embedded Web Server (EWS) page for configuring settings for scanning to a network folder.

Configure IP network settings

- [Introduction](#)
- [Printer sharing disclaimer](#)
- [View or change network settings](#)
- [Rename the printer on a network](#)
- [Manually configure IPv4 TCP/IP parameters from the control panel](#)
- [Link speed setting](#)

Introduction

Use the following sections to configure the printer network settings.

Printer sharing disclaimer

HP does not support peer-to-peer networking, as the feature is a function of Microsoft operating systems and not of the HP print drivers. Go to Microsoft at www.microsoft.com.

View or change network settings

Use the HP Embedded Web Server to view or change IP configuration settings.

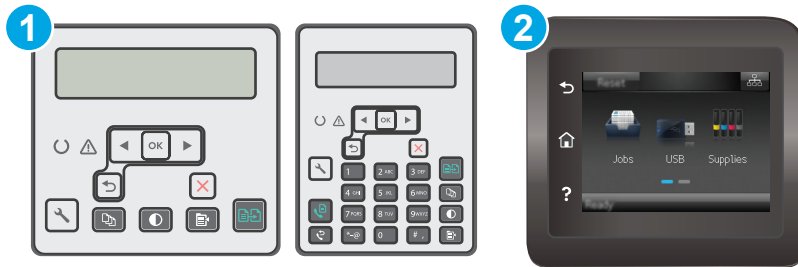

 **NOTE:** The steps vary according to the type of control panel.



- | | |
|---|---------------------------|
| 1 | 2-line control panel |
| 2 | Touchscreen control panel |

1. Open the HP Embedded Web Server (EWS):

- 2-line control panels:** On the printer control panel, press the Setup  button. Open the **Network Setup** menu, and then select **Show IP Address** to display the IP address or host name.

Touchscreen control panels: From the Home screen on the printer control panel, touch the Connection Information  button, and then touch the **Network Connected**  button or the **Network Wi-Fi ON**  button to display the IP address or host name.

- b. Open a web browser, and in the address line, type the IP address or host name exactly as it displays on the printer control panel. Press the **Enter** key on the computer keyboard. The EWS opens.



 **NOTE:** If the web browser displays a message indicating that accessing the website might not be safe, select the option to continue to the website. Accessing this website will not harm the computer.

- 2. Click the **Networking** tab to obtain network information. Change settings as needed.

Rename the printer on a network

To rename the printer on a network so that it can be uniquely identified, use the HP Embedded Web Server.



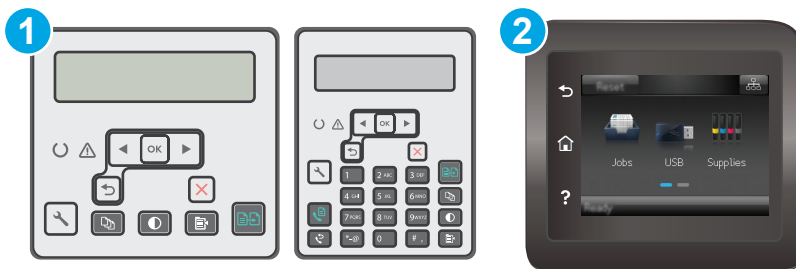

 **NOTE:** The steps vary according to the type of control panel.



- 1 2-line control panel
- 2 Touchscreen control panel

- 1. Open the HP Embedded Web Server (EWS):

- a. **2-line control panels:** On the printer control panel, press the Setup  button. Open the **Network Setup** menu, and then select **Show IP Address** to display the IP address or host name.

Touchscreen control panels: From the Home screen on the printer control panel, touch the Connection Information  /  button, and then touch the **Network Connected**  button or the **Network Wi-Fi ON**  button to display the IP address or host name.

- b. Open a web browser, and in the address line, type the IP address or host name exactly as it displays on the printer control panel. Press the **Enter** key on the computer keyboard. The EWS opens.

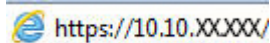

 **NOTE:** If the web browser displays a message indicating that accessing the website might not be safe, select the option to continue to the website. Accessing this website will not harm the computer.

- 2. Open the **System** tab.

3. On the **Device Information** page, the default printer name is in the **Device Description** field. You can change this name to uniquely identify this printer.

 **NOTE:** Completing the other fields on this page is optional.

4. Click the **Apply** button to save the changes.

Manually configure IPv4 TCP/IP parameters from the control panel

Use the control-panel menus to manually set an IPv4 address, subnet mask, and default gateway.

 **NOTE:** The steps vary according to the type of control panel.

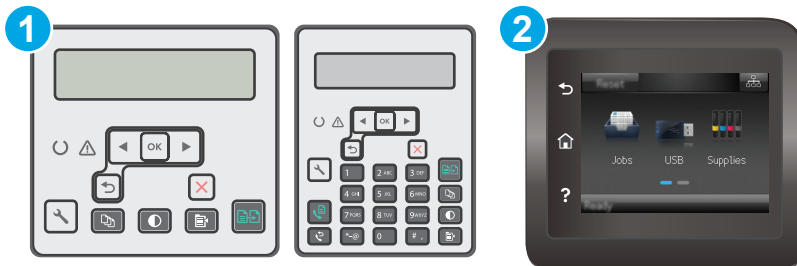

-
- | | |
|---|---------------------------|
| 1 | 2-line control panel |
| 2 | Touchscreen control panel |
-

2-line control panels

1. On the printer control panel, press the Setup  button.
2. Open the following menus:
 - **Network Setup**
 - **IPv4 Config Method**
 - **Manual**
3. Use the arrow keys and the **OK** button to enter the IP address, subnet mask, and default gateway, and then touch the **OK** button to save the changes.

Touchscreen control panels

1. From the Home screen on the printer control panel, touch the **Setup**  button.
2. Scroll to and touch the **Network Setup** menu.
3. Touch the **IPv4 Config Method** menu, and then touch the **Manual** button.
4. Use the keypad on the touchscreen to enter the IP address, and touch the **OK** button. Touch the **Yes** button to confirm.

5. Use the keypad on the touchscreen to enter the subnet mask, and touch the **OK** button. Touch the **Yes** button to confirm.
6. Use the keypad on the touchscreen to enter the default gateway, and touch the **OK** button. Touch the **Yes** button to confirm.

Link speed setting

 **NOTE:** This information applies only to Ethernet networks. It does not apply to wireless networks.

The link speed of the print server must match the network hub. For most situations, leave the printer in automatic mode. Incorrect changes to the link speed setting might prevent the printer from communicating with other network devices. To make changes, use the printer control panel.

 **NOTE:** The printer setting must match the setting for the network device (a network hub, switch, gateway, router, or computer).

 **NOTE:** Making changes to these settings causes the printer to turn off and then on. Make changes only when the printer is idle.

 **NOTE:** The steps vary according to the type of control panel.

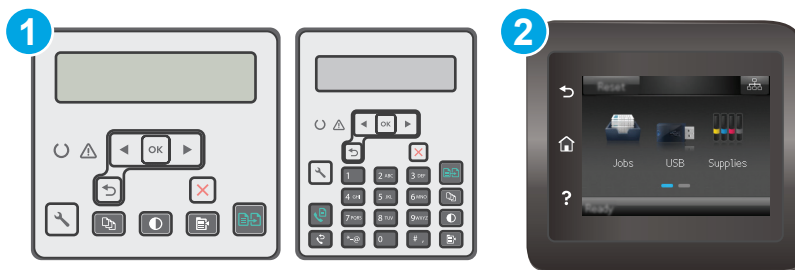

- | | |
|---|---------------------------|
| 1 | 2-line control panel |
| 2 | Touchscreen control panel |

1. **2-line control panels:** On the printer control panel, press the Setup  button.

Touchscreen control panels: From the Home screen on the printer control panel, swipe until the **Setup** menu displays. Touch the **Setup**  icon to open the menu.

2. Open the following menus:

- [Network Setup](#)
- [Link Speed](#)

3. Select one of the following options:

- **Automatic:** The print server automatically configures itself for the highest link speed and communication mode allowed on the network.
- **10T Full:** 10 megabytes per second (Mbps), full-duplex operation
- **10T Half:** 10 Mbps, half-duplex operation

- **100TX Full:** 100 Mbps, full-duplex operation
 - **100TX Half:** 100 Mbps, half-duplex operation
 - **1000T Full:** 1000 Mbps, full-duplex operation
4. Touch the **Save** button, or press the **OK** button. The printer turns off and then on.

Printer security features

Introduction

The printer includes several security features to restrict who has access to configuration settings, to secure data, and to prevent access to valuable hardware components.

- [Assign or change the system password using the Embedded Web Server](#)
- [Lock the formatter](#)

Assign or change the system password using the Embedded Web Server

Assign an administrator password for access to the printer and the HP Embedded Web Server so that unauthorized users cannot change the printer settings.

 **NOTE:** The steps vary according to the type of control panel.

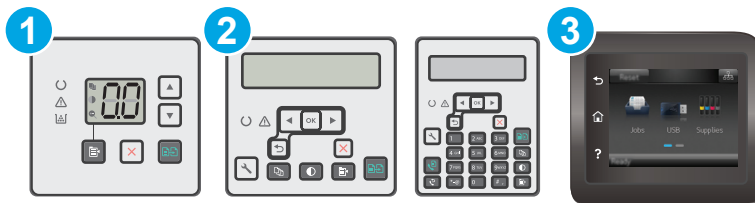

- | | |
|---|---------------------------|
| 1 | LED control panel |
| 2 | 2-line control panel |
| 3 | Touchscreen control panel |





1. Open the HP Embedded Web Server (EWS):

LED control panels

- a. Open the HP Printer Assistant.
 - **Windows 8.1:** Click the down arrow in lower left corner of the **Start** screen, and then select the printer name.
 - **Windows 8:** Right-click an empty area on the **Start** screen, click **All Apps** on the app bar, and then select the printer name.
 - **Windows 7, Windows Vista, and Windows XP:** From the computer desktop, click **Start**, select **All Programs**, click **HP**, click the folder for the printer, select the icon with the printer's name, and then open **HP Printer Assistant**.
- b. In the HP Printer Assistant, select **Print**, and then select **HP Device Toolbox**.

2-line and touchscreen control panels:

- a. **2-line control panels:** On the printer control panel, press the Setup  button. Open the **Network Setup** menu, and then select **Show IP Address** to display the IP address or host name.

Touchscreen control panels: From the Home screen on the printer control panel, touch the Connection Information  /  button, and then touch the **Network Connected**  button or the **Network Wi-Fi ON**  button to display the IP address or host name.

- b. Open a web browser, and in the address line, type the IP address or host name exactly as it displays on the printer control panel. Press the **Enter** key on the computer keyboard. The EWS opens.



 **NOTE:** If the web browser displays a message indicating that accessing the website might not be safe, select the option to continue to the website. Accessing this website will not harm the computer.

2. On the **System** tab, click the **Administration** link in the left navigation pane.
3. In the area labeled **Product Security**, enter the password in the **Password** field.
4. Re-enter the password in the **Confirm Password** field.
5. Click the **Apply** button.

 **NOTE:** Make note of the password and store it in a safe place.

Lock the formatter

The formatter has a slot that you can use to attach a security cable. Locking the formatter prevents someone from removing valuable components from it.

Energy-conservation settings

- [Introduction](#)
- [Print with EconoMode](#)
- [Set the Sleep/Auto Off After Inactivity setting](#)
- [Set the Shut Down After Inactivity delay and configure the printer to use 1 watt or less of power](#)
- [Set the Delay Shut Down setting](#)

Introduction

The printer includes several economy features to conserve energy and supplies.

Print with EconoMode

This printer has an EconoMode option for printing drafts of documents. Using EconoMode can use less toner. However, using EconoMode can also reduce print quality.

HP does not recommend the full-time use of EconoMode. If EconoMode is used full-time, the toner supply might outlast the mechanical parts in the toner cartridge. If print quality begins to degrade and is no longer acceptable, consider replacing the toner cartridge.



NOTE: If this option is not available in your print driver, you can set it using the HP Embedded Web Server.

1. From the software program, select the **Print** option.
2. Select the printer, and then click the **Properties** or **Preferences** button.
3. Click the **Paper/Quality** tab.
4. Click the **EconoMode** option.

Set the Sleep/Auto Off After Inactivity setting

Use the control panel menus to set the amount of idle time before the printer enters sleep mode.

Complete the following procedure to change the Sleep/Auto Off After setting:

 **NOTE:** The steps vary according to the type of control panel.

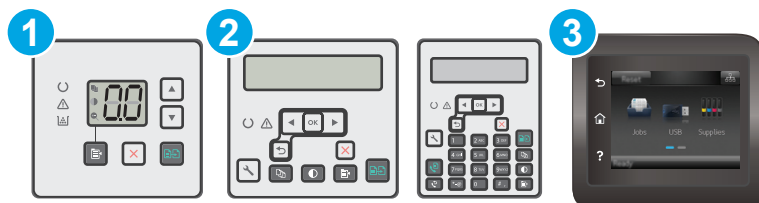

- | | |
|---|---------------------------|
| 1 | LED control panel |
| 2 | 2-line control panel |
| 3 | Touchscreen control panel |

LED control panels:

1. Open the HP Embedded Web Server (EWS):
 - a. Open the HP Printer Assistant.
 - **Windows 8.1:** Click the down arrow in lower left corner of the **Start** screen, and then select the printer name.
 - **Windows 8:** Right-click an empty area on the **Start** screen, click **All Apps** on the app bar, and then select the printer name.
 - **Windows 7, Windows Vista, and Windows XP:** From the computer desktop, click **Start**, select **All Programs**, click **HP**, click the folder for the printer, select the icon with the printer's name, and then open **HP Printer Assistant**.
 - b. In the HP Printer Assistant, select **Print**, and then select **HP Device Toolbox**.
2. Click the **System** tab, select the **System Setup** page, and then select the **Energy Settings** page.
3. Select the time for the Sleep/Auto Off delay, and then click the **Apply** button.

2-line and touchscreen control panels:

1. On the printer control panel, open the [Setup](#) menu.
2. Open the following menus:

- [System Setup](#)
 - [Energy Settings](#)
 - [Sleep/Auto Off After](#)
3. Use the arrow keys to select the time for the Sleep/Auto Off delay, and then press the **OK** button.
Select the time for the Sleep/Auto Off After delay.

Set the Shut Down After Inactivity delay and configure the printer to use 1 watt or less of power

Use the control panel menus to set the amount of time before the printer shuts down.

 **NOTE:** After the printer shuts down, the power consumption is 1 watt or less.

Complete the following procedure to change the Shut Down After Delay setting:

 **NOTE:** The steps vary according to the type of control panel.

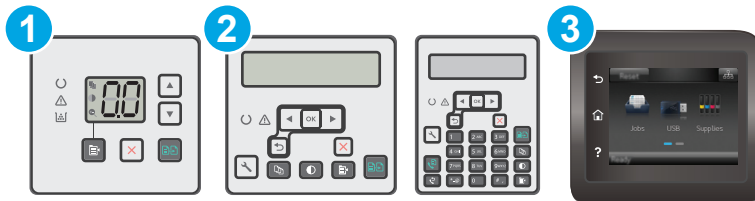

- | | |
|---|---------------------------|
| 1 | LED control panel |
| 2 | 2-line control panel |
| 3 | Touchscreen control panel |

LED control panels:

1. Open the HP Embedded Web Server (EWS):
 - a. Open the HP Printer Assistant.
 - **Windows 8.1:** Click the down arrow in lower left corner of the **Start** screen, and then select the printer name.
 - **Windows 8:** Right-click an empty area on the **Start** screen, click **All Apps** on the app bar, and then select the printer name.
 - **Windows 7, Windows Vista, and Windows XP:** From the computer desktop, click **Start**, select **All Programs**, click **HP**, click the folder for the printer, select the icon with the printer's name, and then open **HP Printer Assistant**.
 - b. In the HP Printer Assistant, select **Print**, and then select **HP Device Toolbox**.
2. Click the **System** tab, select the **System Setup** page, and then select the **Energy Settings** page.
3. In the **Shut Down After** area, select the time for the delay.

 **NOTE:** The default value is **4 hours**.

2-line and touchscreen control panels:

1. On the printer control panel, open the **Setup** menu.
2. Open the following menus:
 - **System Setup**
 - **Energy Settings**
 - **Shut Down After**
3. Select the time for the Shut Down After delay.

 **NOTE:** The default value is **4 hours**.

Set the Delay Shut Down setting

Use the control panel menus to select whether or not the printer delays shutting down after the power button is pressed.

Complete the following procedure to change the Delay Shut Down setting:

 **NOTE:** The steps vary according to the type of control panel.

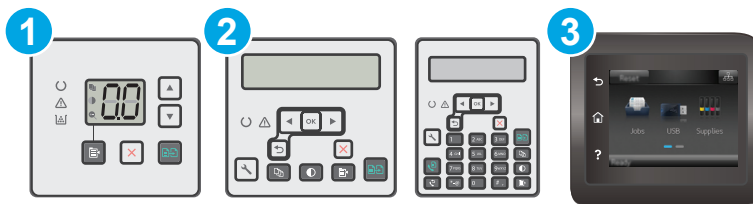

-
- | | |
|---|---------------------------|
| 1 | LED control panel |
| 2 | 2-line control panel |
| 3 | Touchscreen control panel |
-

LED control panels:

1. Open the HP Embedded Web Server (EWS):
 - a. Open the HP Printer Assistant.

- **Windows 8.1:** Click the down arrow in lower left corner of the **Start** screen, and then select the printer name.
 - **Windows 8:** Right-click an empty area on the **Start** screen, click **All Apps** on the app bar, and then select the printer name.
 - **Windows 7, Windows Vista, and Windows XP:** From the computer desktop, click **Start**, select **All Programs**, click **HP**, click the folder for the printer, select the icon with the printer's name, and then open **HP Printer Assistant**.
- b. In the HP Printer Assistant, select **Print**, and then select **HP Device Toolbox**.
2. Click the **System** tab, select the **System Setup** page, and then select the **Energy Settings** page.
 3. In the **Delay Shut Down** area, select one of the delay options:
 - **No Delay:** The printer shuts down after a period of inactivity determined by the Shut Down After setting.
 - **When Ports Are Active:** When this option is selected the printer will not shut down unless all ports are inactive. An active network link or fax connection will prevent the printer from shutting down.

2-line and touchscreen control panels:

1. On the printer control panel, open the [Setup](#) menu.
2. Open the following menus:
 - [System Setup](#)
 - [Energy Settings](#)
 - [Delay Shut Down](#)
3. Select one of the delay options:
 - **No Delay:** The printer shuts down after a period of inactivity determined by the Shut Down After setting.
 - **When Ports Are Active:** When this option is selected the printer will not shut down unless all ports are inactive. An active network link or fax connection will prevent the printer from shutting down.

Update the firmware

HP offers periodic printer updates, new Web Services apps, and new features to existing Web Services apps. Follow these steps to update the printer firmware for a single printer. When you update the firmware, Web Service apps will update automatically.

There are two supported methods to perform a firmware update on this printer. Use only one of the following methods to update the printer firmware.

Method one: Update the firmware using the 2-line or touchscreen control panel

Use these steps to load the firmware from the control panel (for network-connected printers only), and/or set the printer to automatically load future firmware updates. For USB-connected printers, skip to method two.

 **NOTE:** The steps vary according to the type of control panel.

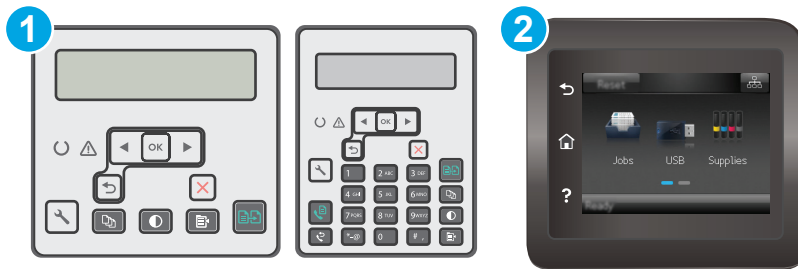



- | | |
|---|---------------------------|
| 1 | 2-line control panel |
| 2 | Touchscreen control panel |

2-line control panels:

1. Make sure the printer is connected to a wired (Ethernet) or wireless network with an active Internet connection.

 **NOTE:** The printer must be connected to the internet to update the firmware via a network connection.

2. On the printer control panel, press the Setup  button.
3. Open the **Service** menu, and then open the **LaserJet Update** menu.

 **NOTE:** If the **LaserJet Update** option is not listed, use method two.

4. Select **Check for Update** to check for updates.

 **NOTE:** The printer automatically checks for an update, and if a newer version is detected, the update process automatically starts.

5. Set the printer to automatically update the firmware when updates become available.

On the printer control panel, press the Setup  button.

Open the **Service** menu, open the **LaserJet Update** menu, and then select the **Manage Updates** menu.

Set the **Allow Updates** option to **YES**, and then set the **Automatic Check** option to **ON**.

Touchscreen control panels:

1. Make sure the printer is connected to a wired (Ethernet) or wireless network with an active Internet connection.

 **NOTE:** The printer must be connected to the internet to update the firmware via a network connection.

2. From the Home screen on the printer control panel, touch the **Setup**  button.
3. Scroll to and open the **Service** menu, and then open the **LaserJet Update** menu.

 **NOTE:** If the **LaserJet Update** option is not listed, use method two.

4. Touch **Check for Updates Now** to check for updates.

 **NOTE:** The printer automatically checks for an update, and if a newer version is detected, the update process automatically starts.

5. Set the printer to automatically update the firmware when updates become available.

From the Home screen on the printer control panel, touch the **Setup**  button.

Open the **Service** menu, open the **LaserJet Update** menu, and then select the **Manage Updates** menu.

Set the **Allow Updates** option to **YES**, and then set the **Check automatically** option to **ON**.

Method two: Update the firmware using the Firmware Update Utility

Use these steps to manually download and install the Firmware Update Utility from HP.com.

 **NOTE:** This method is the only firmware update option available for printers connected to the computer via a USB cable. It also works for printers connected to a network.

 **NOTE:** You must have a print driver installed in order to use this method.

1. Go to www.hp.com/support, select your country/region language, click **Get software and drivers** link, type the printer name in the search field, press the **Enter** button, and then select the printer from the list of search results.
2. Select the operating system.
3. Under the **Firmware** section, locate the **Firmware Update Utility**.
4. Click **Download**, click **Run**, and then click **Run** again.
5. When the utility launches, select the printer from the drop-down list, and then click **Send Firmware**.

 **NOTE:** To print a configuration page to verify the installed firmware version before or after the update process, click **Print Config**.

6. Follow the on-screen instructions to complete the installation, and then click the **Exit** button to close the utility.

9 Solve problems

- [Customer support](#)
- [Interpret control-panel light patterns \(LED control panels only\)](#)
- [Control panel help system \(touchscreen models only\)](#)
- [Restore the factory-set defaults](#)
- [A “Cartridge is low” or “Cartridge is very low” message displays on the printer control panel or EWS](#)
- [Product does not pick up paper or misfeeds](#)
- [Clear paper jams](#)
- [Clean the ADF replaceable film assembly](#)
- [Improve print quality](#)
- [Improve copy and scan image quality](#)
- [Improve fax image quality](#)
- [Solve wired network problems](#)
- [Solve wireless network problems](#)
- [Solve fax problems](#)

For more information:

The following information is correct at the time of publication. For current information, see www.hp.com/support/ljM129MFP.

HP's all-inclusive help for the printer includes the following information:

- Install and configure
- Learn and use
- Solve problems
- Download software and firmware updates
- Join support forums
- Find warranty and regulatory information

Customer support

Get telephone support for your country/region	Country/region phone numbers are on the flyer that was in the box with the printer or at www.hp.com/support/ .
Have the printer name, serial number, date of purchase, and problem description ready	
Get 24-hour Internet support, and download software utilities and drivers	www.hp.com/support/ljM129MFP
Order additional HP service or maintenance agreements	www.hp.com/go/carepack
Register the printer	www.register.hp.com

Interpret control-panel light patterns (LED control panels only)

If the printer requires user confirmation, the LED control panel alternates between **Go** and a two-digit status code. If the printer requires attention, the LED control panel alternates between **Er** and a two-digit error code. Use the table below to determine any issues with the printer.

Table 9-1 Status-light legend



	Symbol for "light off"
	Symbol for "light on"
	Symbol for "light blinking"

Table 9-2 Control-panel light patterns







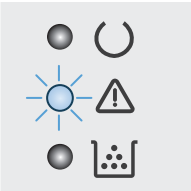

Light status	Error code	State of the printer	Action
The Attention light is blinking.	Go/01	The printer is in manual-feed mode.	Load the correct paper type and size into the input tray. Press the Start Copy  button to continue.
	Go/02	The printer is processing a manual duplex job.	Load the pages into the input tray to print the second sides. Press the Start Copy  button to continue.
	Go/03	Print job is different from the user's settings.	Load plain paper or press the Start Copy  button to continue with the paper currently loaded.
	Er/01	The input tray is empty.	Load the tray.
	Er/02	A door is open.	Verify that the top cover is fully closed.
	Er/03	The printer failed to pick a sheet of paper to print.	Press Start Copy  to continue.
	Er/04	Paper is jammed in the input tray.	Clear the jam.
	Er/05	Paper is jammed in the toner cartridge area.	Clear the jam.
	Er/06	Paper is jammed in the output bin area.	Clear the jam.
	Er/25	The loaded paper is not the size needed for the print job.	Replace the paper, or press Start Copy  to continue with the size currently loaded.
	Er/26	The printer has experienced a general engine error.	Press Start Copy  to continue. If the error repeats, turn off the printer. Wait 30 seconds, and then turn on the printer.
	Er/81	Incorrect firmware has been loaded.	Press Start Copy  to continue. Load the correct firmware.
	Er/82	The printer has experienced a bad code signature.	Press Start Copy  to accept the signature, or press Cancel  to stop the upgrade.

Table 9-2 Control-panel light patterns (continued)





Light status	Error code	State of the printer	Action
	Er/83	The printer has canceled a bad code signature upgrade.	Press Start Copy  to continue.
	Er/90	The printer has experienced an engine cable error.	Press Start Copy  to continue. If the error persists, contact HP customer support.
	Er/91	The printer has experienced a scanner cable error.	Press Start Copy  to continue. If the error persists, contact HP customer support.
	Er/92	The printer has experienced a control-panel cable error.	Press Start Copy  to continue. If the error persists, contact HP customer support.
The Attention light is blinking and the Toner light is on.	Er/08	The toner cartridge is very low.	Replace the toner cartridge.
	Er/09	The imaging drum is very low.	Replace the imaging drum.
	Er/10	Multiple supplies are low.	Replace the supplies.
 The Attention and Toner lights are blinking.	Er/07	The toner cartridge or imaging drum is missing or incorrectly installed.	Install or reinstall the toner cartridge and imaging drum.
	Er/11	The toner cartridge is incompatible with the printer, possibly due to a missing or damaged memory chip.	Replace the toner cartridge.
	Er/12	The imaging drum is incompatible with the printer, possibly due to a missing or damaged memory chip.	Replace the imaging drum.
	Er/13	Multiple supplies are incompatible with the printer, possibly due to a missing or damaged memory chip.	Replace the supplies.
	Er/14	The toner cartridge has been protected on another printer.	Replace the toner cartridge.
	Er/15	The imaging drum has been protected on another printer.	Replace the imaging drum.
	Er/16	Multiple supplies have been protected on another printer.	Replace the supplies.
	Er/17	An unauthorized toner cartridge is installed.	Replace the toner cartridge.
	Er/18	An unauthorized imaging drum is installed.	Replace the imaging drum.
	Er/19	Unauthorized supplies are installed.	Replace the supplies.

Table 9-2 Control-panel light patterns (continued)

Light status	Error code	State of the printer	Action
	Er/20	The cartridge sensor has experienced an error.	Replace the toner cartridge.
The Attention and Ready lights are on.	Er/30	The printer has experienced a fatal error from which it cannot recover.	<ol style="list-style-type: none"> 1. Turn off the printer or disconnect the power cord from the printer. 2. Wait 30 seconds, and then turn on the printer or reconnect the power cord to the printer. 3. Wait for the printer to initialize. <p>If the error persists, contact HP customer support.</p>
	Er/49		
	Er/50		
	Er/51		
	Er/52		
	Er/53		
	Er/54		
	Er/55		
	Er/56		
	Er/57		
Er/58			
Er/59			
Er/60			
Er/79			

Control panel help system (touchscreen models only)

The printer has a built-in Help system that explains how to use each screen. To open the Help system, touch the Help **?** button in the upper-right corner of the screen.

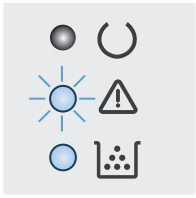
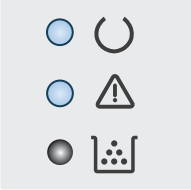

For some screens, the Help opens to a global menu where you can search for specific topics. You can browse through the menu structure by touching the buttons in the menu.

Some Help screens include animations that guide you through procedures, such as clearing jams.

For screens that contain settings for individual jobs, the Help opens to a topic that explains the options for that screen.

If the printer alerts you of an error or warning, touch the Help **?** button to open a message that describes the problem. The message also contains instructions to help solve the problem.

Restore the factory-set defaults

Restoring the factory-set defaults returns all of the printer and network settings to the factory defaults. It will not reset the page count, or tray size. To restore the printer to the factory-default settings, follow these steps.

CAUTION: Restoring the factory-set defaults returns all of the settings to the factory defaults, and it also deletes any pages that are stored in the memory.

NOTE: The steps vary according to the type of control panel.

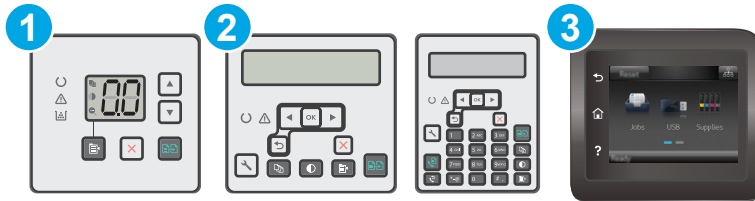

1	LED control panel
2	2-line control panel
3	Touchscreen control panel

LED control panels:

1. Open the HP Embedded Web Server (EWS):
 - a. Open the HP Printer Assistant.
 - **Windows 8.1:** Click the down arrow in lower left corner of the **Start** screen, and then select the printer name.
 - **Windows 8:** Right-click an empty area on the **Start** screen, click **All Apps** on the app bar, and then select the printer name.
 - **Windows 7, Windows Vista, and Windows XP:** From the computer desktop, click **Start**, select **All Programs**, click **HP**, click the folder for the printer, select the icon with the printer's name, and then open **HP Printer Assistant**.
 - b. In the HP Printer Assistant, select **Print**, and then select **HP Device Toolbox**.
2. Click the **System** tab, and then click the **Save and Restore** page.
3. Select **Restore Defaults**.

The printer automatically restarts.

2-line and touchscreen control panels:

1. On the printer control panel, open the [Setup](#) menu.
2. Open the [Service](#) menu.
3. Select [Restore Defaults](#).

The printer automatically restarts.

A “Cartridge is low” or “Cartridge is very low” message displays on the printer control panel or EWS

Cartridge is low: The printer indicates when a cartridge level is low. Actual cartridge life remaining may vary. Consider having a replacement available to install when print quality is no longer acceptable. The cartridge does not need to be replaced now.

Cartridge is very low: The printer indicates when the cartridge level is very low. Actual cartridge life remaining may vary. Consider having a replacement available to install when print quality is no longer acceptable. The cartridge does not need to be replaced now unless the print quality is no longer acceptable.

Once an HP cartridge has reached **Very Low**, HP’s Premium Protection Warranty on that cartridge has ended.

 **NOTE:** The cartridge must be replaced when the printer indicates that the cartridge is very low for HP 33A Black Original LaserJet Toner Cartridge and HP 34A Original LaserJet Imaging Drum.

Change the “Very Low” settings

You can change the way the printer reacts when supplies reach the Very Low state. You do not have to re-establish these settings when you install a new cartridge.

 **NOTE:** The “Very Low” setting cannot be changed for HP 33A Black Original LaserJet Toner Cartridge and HP 34A Original LaserJet Imaging Drum.

 **NOTE:** The steps vary according to the type of control panel.

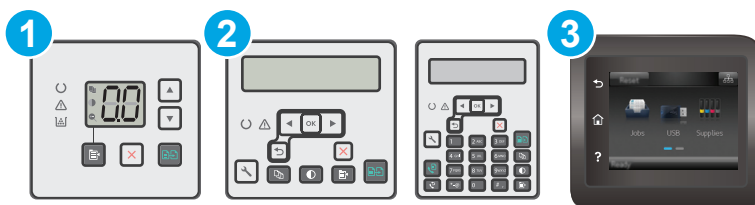

- | | |
|---|---------------------------|
| 1 | LED control panel |
| 2 | 2-line control panel |
| 3 | Touchscreen control panel |

LED control panels:

1. Open the HP Embedded Web Server (EWS):
 - a. Open the HP Printer Assistant.

- **Windows 8.1:** Click the down arrow in lower left corner of the **Start** screen, and then select the printer name.
 - **Windows 8:** Right-click an empty area on the **Start** screen, click **All Apps** on the app bar, and then select the printer name.
 - **Windows 7, Windows Vista, and Windows XP:** From the computer desktop, click **Start**, select **All Programs**, click **HP**, click the folder for the printer, select the icon with the printer's name, and then open **HP Printer Assistant**.
- b. In the HP Printer Assistant, select **Print**, and then select **HP Device Toolbox**.
2. Click the **System** tab, and then click the **Supply Settings** tab.
 3. In the **Paper Setup** area, select the correct low-cartridge settings.
 - Select the **Continue** option to set the printer to alert you that the cartridge is very low, but to continue printing.
 - Select the **Stop** option to set the printer to stop printing until you replace the cartridge.
 - Select the **Prompt** option to set the printer to stop printing and prompt you to replace the cartridge. You can acknowledge the prompt and continue printing. A customer configurable option on this printer is "Prompt to Remind Me in 100 pages, 200 pages, 300 pages, 400 pages, or never." This option is provided as a customer convenience and is not an indication these pages will have acceptable print quality.

2-line and touchscreen control panels:

1. On the printer control panel, open the **Setup** menu.
2. Open the following menus:
 - **System Setup**
 - **Supply Settings**
 - **Black Cartridge** or **Color Cartridges**
 - **Very Low Setting**
3. Select one of the following options:
 - Select the **Continue** option to set the printer to alert you that the cartridge is very low, but to continue printing.
 - Select the **Stop** option to set the printer to stop printing until you replace the cartridge.
 - Select the **Prompt** option to set the printer to stop printing and prompt you to replace the cartridge. You can acknowledge the prompt and continue printing. A customer configurable option on this printer is "Prompt to Remind Me in 100 pages, 200 pages, 300 pages, 400 pages, or never." This option is provided as a customer convenience and is not an indication these pages will have acceptable print quality.

For printers with fax capability

When the printer is set to the **Stop** or **Prompt** option, there is some risk that faxes will not print when the printer resumes printing. This can occur if the printer has received more faxes than the memory can hold while the printer is waiting.

The printer can print faxes without interruption when it passes the Very Low threshold if you select the [Continue](#) option for the cartridge, but print quality might degrade.

Order supplies

Order supplies and paper	www.hp.com/go/suresupply
Order through service or support providers	Contact an HP-authorized service or support provider.
Order using the HP Embedded Web Server (EWS)	To access, in a supported web browser on your computer, enter the printer IP address or host name in the address/URL field. The EWS contains a link to the HP SureSupply website, which provides options for purchasing Original HP supplies.

Product does not pick up paper or misfeeds

Introduction

The following solutions can help solve problems if the printer is not picking up paper from the tray or is picking up multiple sheets of paper at one time. Either of these situations can result in paper jams.

- [The printer does not pick up paper](#)
- [The printer picks up multiple sheets of paper](#)
- [The document feeder jams, skews, or picks up multiple sheets of paper](#)
- [Clean the pickup rollers and separation pad in the document feeder](#)

The printer does not pick up paper

If the printer does not pick up paper from the tray, try these solutions.

1. Open the printer and remove any jammed sheets of paper. Verify that no torn remnants of paper remain inside the printer.
2. Load the tray with the correct size of paper for the job.
3. Make sure the paper size and type are set correctly on the printer control panel.
4. Make sure the paper guides in the tray are adjusted correctly for the size of paper. Adjust the guides to the appropriate indentation in the tray. The arrow on the tray guide should line up exactly with the marking on the tray.



NOTE: Do not adjust the paper guides tightly against the paper stack. Adjust them to the indentations or markings in the tray.

5. Verify that the humidity in the room is within specifications for this printer and that paper is being stored in unopened packages. Most reams of paper are sold in moisture-proof wrapping to keep paper dry.

In high-humidity environments, paper at the top of the stack in the tray can absorb moisture, and it might have a wavy or uneven appearance. If this happens, remove the top 5 to 10 sheets of paper from the stack.

In low-humidity environments, excess static electricity can cause sheets of paper to stick together. If this happens, remove the paper from the tray, and flex the stack by holding it at each end and bringing the ends up to form a U shape. Then, rotate the ends down to reverse the U shape. Next, hold each side of the stack of paper, and repeat this process. This process releases individual sheets without introducing static electricity. Straighten the paper stack against a table before returning it to the tray.

Figure 9-1 Technique for flexing the paper stack

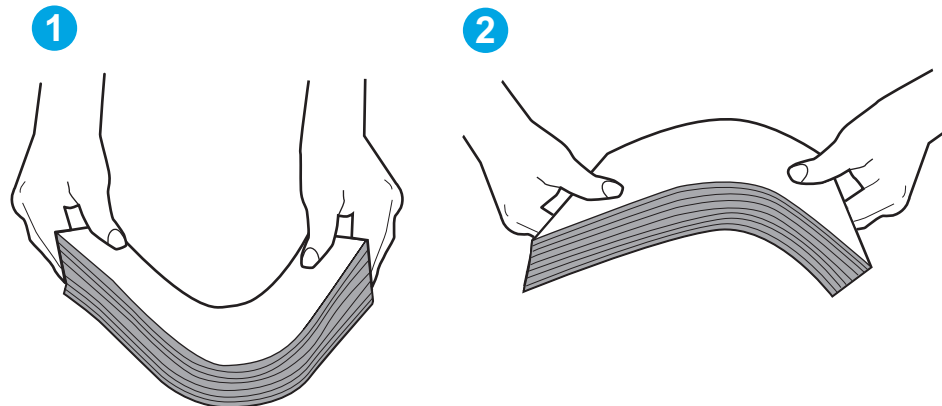

6. Check the printer control panel to see if it is displaying a prompt to feed the paper manually. Load paper, and continue.
7. The rollers above the tray might be contaminated. Clean the rollers with a lint-free cloth dampened with warm water. Use distilled water, if it is available.

CAUTION: Do not spray water directly on to the printer. Instead, spray water on the cloth or dab the cloth in water and wring it out before cleaning the rollers.

The printer picks up multiple sheets of paper

If the printer picks up multiple sheets of paper from the tray, try these solutions.

1. Remove the stack of paper from the tray and flex it, rotate it 180 degrees, and flip it over. *Do not fan the paper.* Return the stack of paper to the tray.

NOTE: Fanning the paper introduces static electricity. Instead of fanning the paper, flex the stack by holding it at each end and bringing the ends up to form a U shape. Then, rotate the ends down to reverse the U shape. Next, hold each side of the stack of paper, and repeat this process. This process releases individual sheets without introducing static electricity. Straighten the paper stack against a table before returning it to the tray.

Figure 9-2 Technique for flexing the paper stack

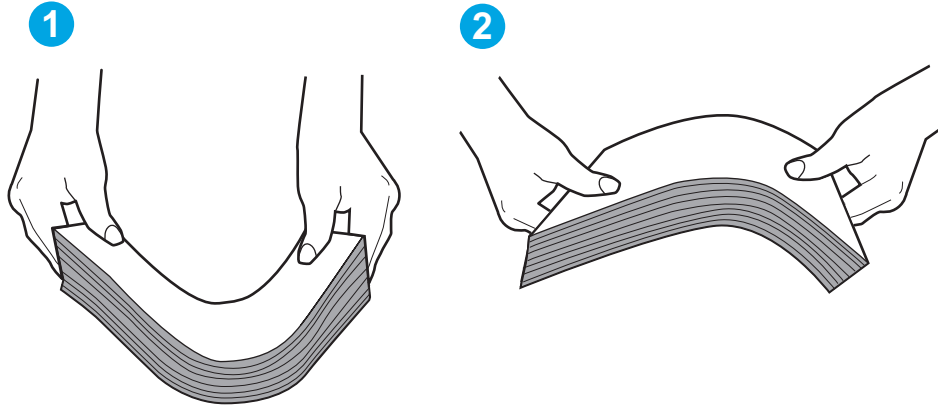

2. Use only paper that meets HP specifications for this printer.
3. Verify that the humidity in the room is within specifications for this printer, and that paper is being stored in unopened packages. Most reams of paper are sold in moisture-proof wrapping to keep paper dry.

In high-humidity environments, paper at the top of the stack in the tray can absorb moisture, and it might have a wavy or uneven appearance. If this happens, remove the top 5 to 10 sheets of paper from the stack.

In low-humidity environments, excess static electricity can cause sheets of paper to stick together. If this happens, remove the paper from the tray, and flex the stack as described above.

4. Use paper that is not wrinkled, folded, or damaged. If necessary, use paper from a different package.
5. Make sure the tray is not overfilled by checking the stack-height markings inside the tray. If it is overfilled, remove the entire stack of paper from the tray, straighten the stack, and then return some of the paper to the tray.
6. Make sure the paper guides in the tray are adjusted correctly for the size of paper. Adjust the guides to the appropriate indentation in the tray. The arrow on the tray guide should line up exactly with the marking on the tray.

 **NOTE:** Do not adjust the paper guides tightly against the paper stack. Adjust them to the indentations or markings in the tray.

7. Make sure the printing environment is within recommended specifications.

The document feeder jams, skews, or picks up multiple sheets of paper

 **NOTE:** This information applies to MFP printers only.

- The original might have something on it, such as staples or self-adhesive notes, that must be removed.
- Check that all rollers are in place and that the roller-access cover inside the document feeder is closed.
- Make sure that the top document-feeder cover is closed.
- The pages might not be placed correctly. Straighten the pages and adjust the paper guides to center the stack.

- The paper guides must be touching the sides of the paper stack to work correctly. Make sure that the paper stack is straight and the guides are against the paper stack.
- The document feeder input tray or output bin might contain more than the maximum number of pages. Make sure the paper stack fits below the guides in the input tray, and remove pages from the output bin.
- Verify that there are no pieces of paper, staples, paper clips, or other debris in the paper path.
- Clean the document-feeder rollers and the separation pad. Use compressed air or a clean, lint-free cloth moistened with warm water. If misfeeds still occur, replace the rollers.
- From the Home screen on the printer control panel, scroll to and touch the [Supplies](#) button. Check the status of the document-feeder kit, and replace it if necessary.

Clean the pickup rollers and separation pad in the document feeder

If the document feeder experiences paper-handling problems, such as jams or multiple-page feeds, clean the document-feeder rollers and separation pad.

1. Open the document-feeder access cover.

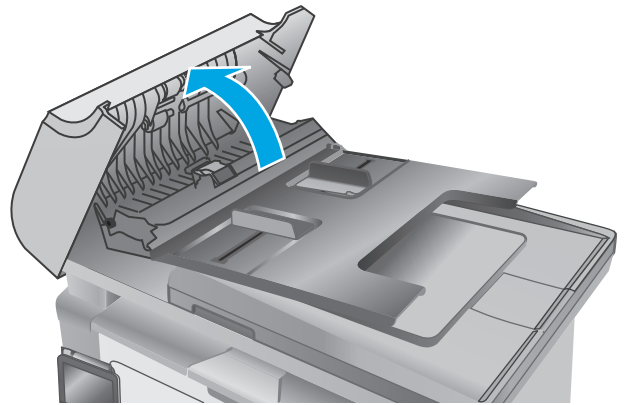

2. Use a moist, lint-free cloth to wipe both pickup rollers and the separation pad to remove dirt.

CAUTION: Do not use abrasives, acetone, benzene, ammonia, ethyl alcohol, or carbon tetrachloride on any part of the printer; these can damage the printer. Do not place liquids directly on the glass or platen. They might seep and damage the printer.

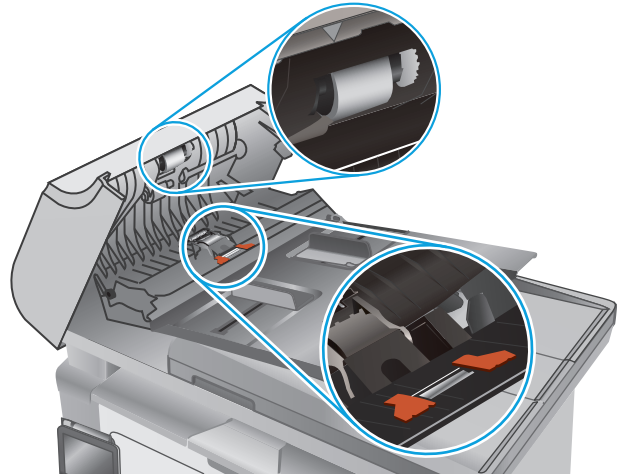

3. Close the document feeder access cover.

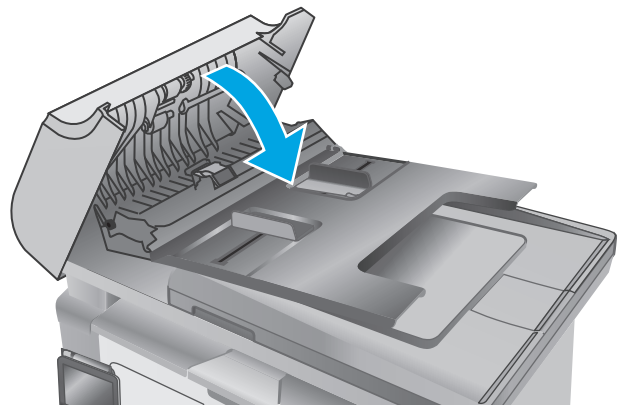

Clear paper jams

Introduction

The following information includes instructions for clearing paper jams from the product.

- [Paper jam locations](#)
- [Experiencing frequent or recurring paper jams?](#)
- [Clear paper jams in the input tray](#)
- [Clear paper jams in the toner-cartridge area](#)
- [Clear paper jams in the output bin](#)
- [Clear paper jams in the document feeder \(document feeder models only\)](#)

Paper jam locations

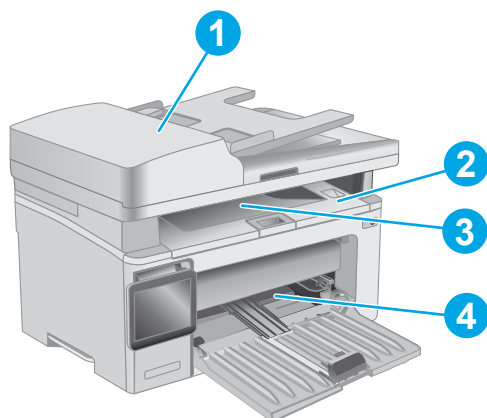

1	Document feeder
2	Print cartridge area
3	Output bin
4	Input tray

Experiencing frequent or recurring paper jams?

Follow these steps to solve problems with frequent paper jams. If the first step does not resolve the problem continue with the next step until you have resolved the problem.



NOTE: The steps vary according to the type of control panel.

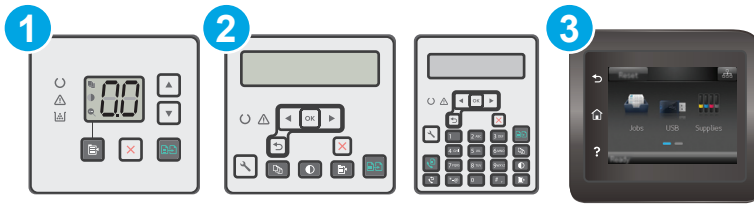

- | | |
|---|---------------------------|
| 1 | LED control panel |
| 2 | 2-line control panel |
| 3 | Touchscreen control panel |

1. If paper has jammed in the printer, clear the jam and then print a configuration page to test the printer.
2. Check that the tray is configured for the correct paper size and type on the printer control panel. Adjust paper settings if necessary.

LED control panels:

- a. Open the HP Embedded Web Server (EWS):
 - i. Open the HP Printer Assistant.
 - **Windows 8.1:** Click the down arrow in lower left corner of the **Start** screen, and then select the printer name.
 - **Windows 8:** Right-click an empty area on the **Start** screen, click **All Apps** on the app bar, and then select the printer name.
 - **Windows 7, Windows Vista, and Windows XP:** From the computer desktop, click **Start**, select **All Programs**, click **HP**, click the folder for the printer, select the icon with the printer's name, and then open **HP Printer Assistant**.
 - ii. In the HP Printer Assistant, select **Print**, and then select **HP Device Toolbox**.
- b. Click the **System** tab, and then click the **Paper Setup** page.
- c. Select the tray from the list.
- d. Select **Paper Type** and then select the type of paper that is in the tray.
- e. Select **Paper Size** and then select the size of paper that is in the tray.
- f. Click **Apply** to save the changes.

2-line and touchscreen control panels:

- a. On the printer control panel, open the **Setup** menu.
- b. Open the following menus:
 - **System Setup**
 - **Paper setup**

- c. Select the tray from the list.
 - d. Select [Paper Type](#) and then select the type of paper that is in the tray.
 - e. Select [Paper Size](#) and then select the size of paper that is in the tray.
3. Turn the printer off, wait 30 seconds, and then turn it on again.
 4. Print a cleaning page to remove excess toner from inside the printer.



LED control panels:

- a. Open the HP Printer Assistant.
 - **Windows 8.1:** Click the down arrow in lower left corner of the **Start** screen, and then select the printer name.
 - **Windows 8:** Right-click an empty area on the **Start** screen, click **All Apps** on the app bar, and then select the printer name.
 - **Windows 7, Windows Vista, and Windows XP:** From the computer desktop, click **Start**, select **All Programs**, click **HP**, click the folder for the printer, select the icon with the printer's name, and then open **HP Printer Assistant**.
- b. In the HP Printer Assistant, select **Print**, and then select **HP Device Toolbox**.
- c. On the **Systems** tab, click **Service**.
- d. In the **Cleaning Mode** area, click **Start** to begin the cleaning process.

2-line and touchscreen control panels:

- a. On the printer control panel, open the [Setup](#) menu.
 - b. Open the [Service](#) menu.
 - c. Select [Cleaning Page](#).
 - d. Load plain letter or A4 paper when you are prompted.
Wait until the process is complete. Discard the page that prints.
5. Print a configuration page to test the printer.

LED control panels:

- ▲ Press and hold the Start Copy  button until the Ready  light begins blinking, and then release the button.

2-line and touchscreen control panels:

- a. On the printer control panel, open the [Setup](#) menu.
- b. Open the [Reports](#) menu.
- c. Select [Configuration Report](#).

If none of these steps resolves the problem, the printer might need service. Contact HP customer support.

Clear paper jams in the input tray

When a jam occurs, the Attention  light blinks repeatedly on LED control panels, and a jam message displays on 2-line and touchscreen control panels.

1. Remove any loose paper from the input tray.

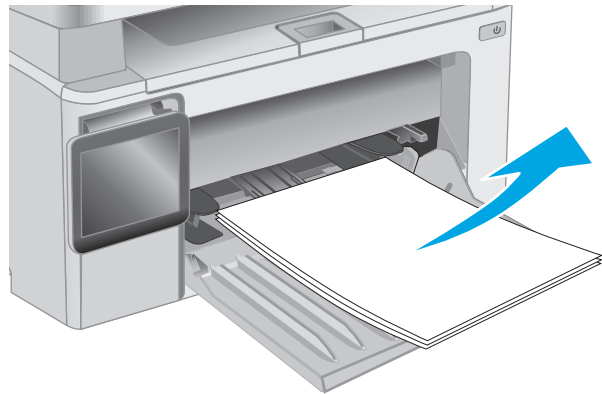

2. Lift the scanner assembly, and then open the top cover.

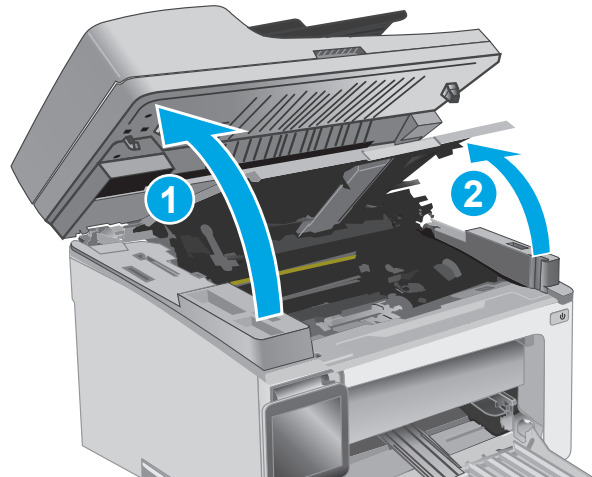

3. Remove the toner cartridge.

NOTE: **M133-M134 models:** Remove the imaging drum and toner cartridge as one unit.

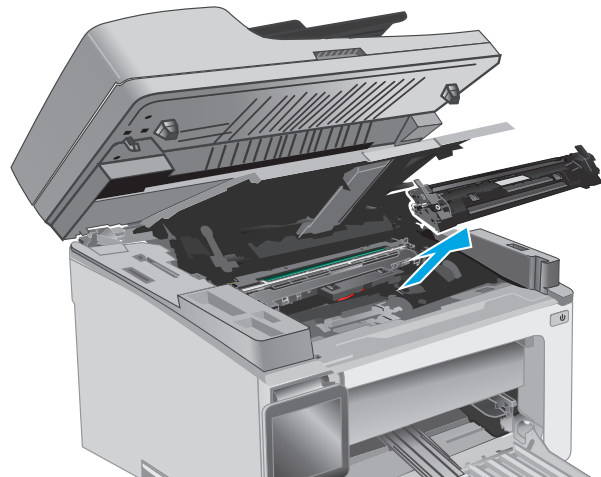

4. Remove the imaging drum.

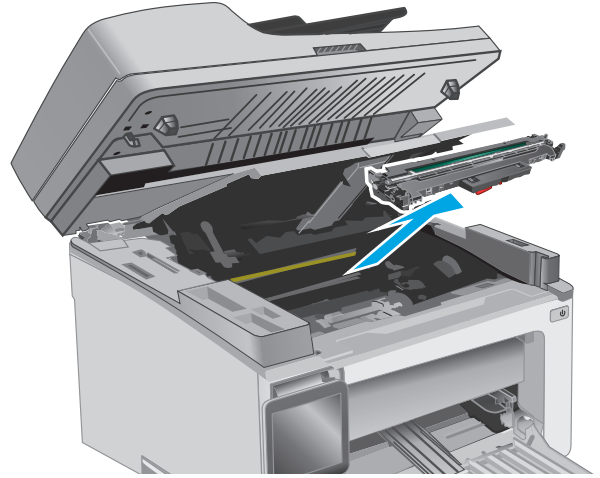

5. Remove any visible jammed paper in the input tray area. Use both hands to remove jammed paper to avoid tearing the paper.

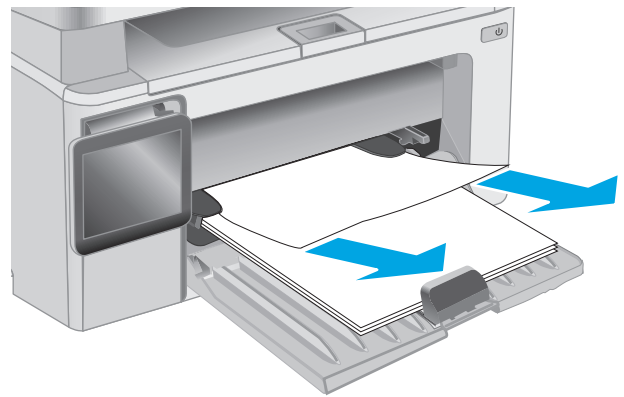

6. Remove any jammed paper from the toner-cartridge area. Use both hands to remove jammed paper to avoid tearing the paper.

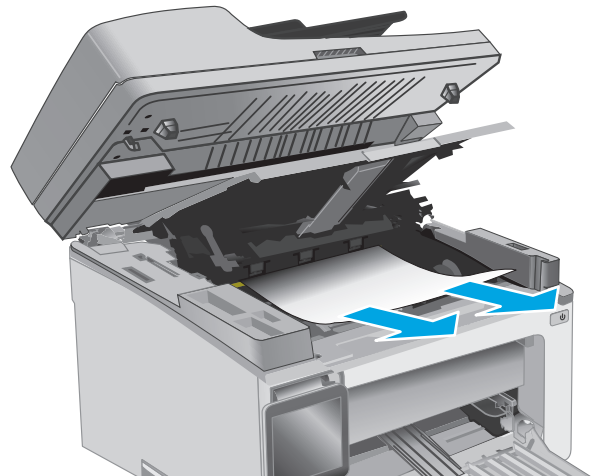

7. Insert the imaging drum into the printer.

NOTE: M133-M134 models: Install the imaging drum and toner cartridge as one unit.

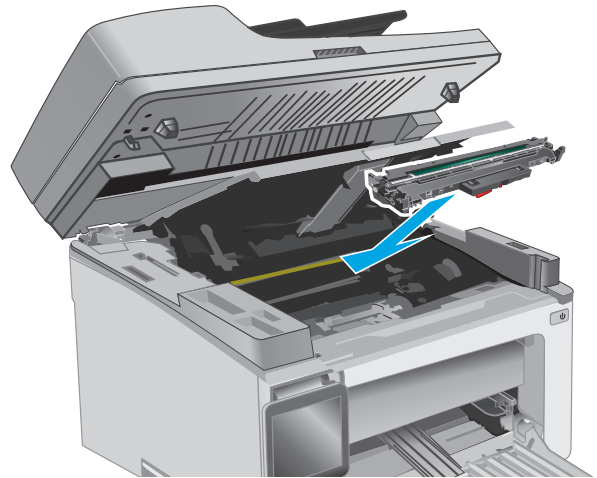

8. Insert the toner cartridge.

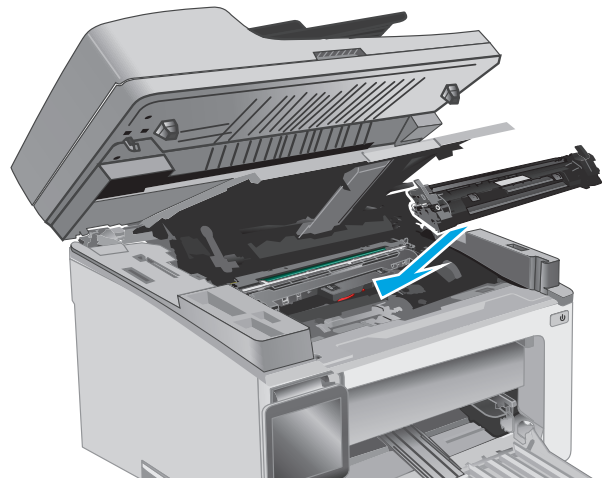

9. Close the top cover, and then lower the scanner assembly.

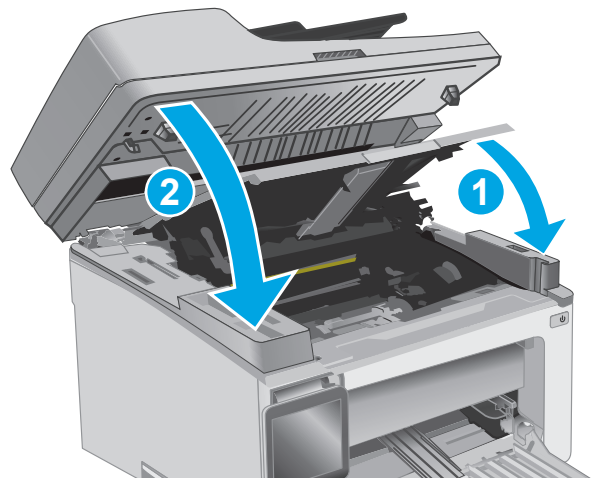

Clear paper jams in the toner-cartridge area

When a jam occurs, the Attention  light blinks repeatedly on LED control panels, and a jam message displays on 2-line and touchscreen control panels.

1. Lift the scanner assembly, and then open the top cover.

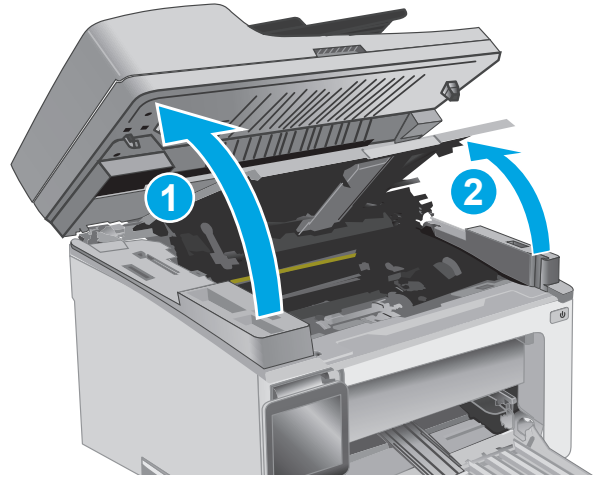

2. Remove the toner cartridge.

NOTE: M133-M134 models: Remove the imaging drum and toner cartridge as one unit.

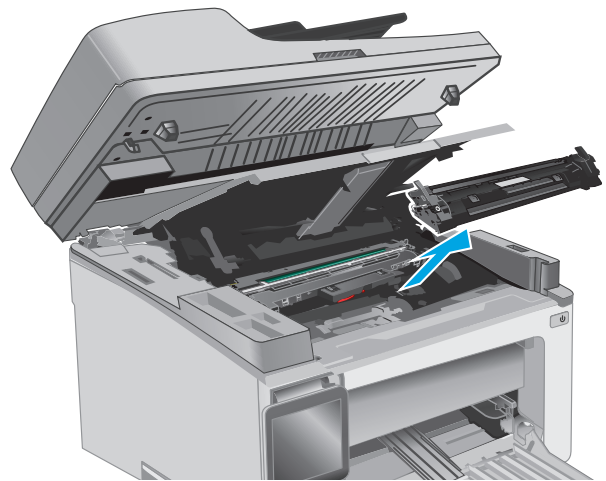

3. Remove the imaging drum.

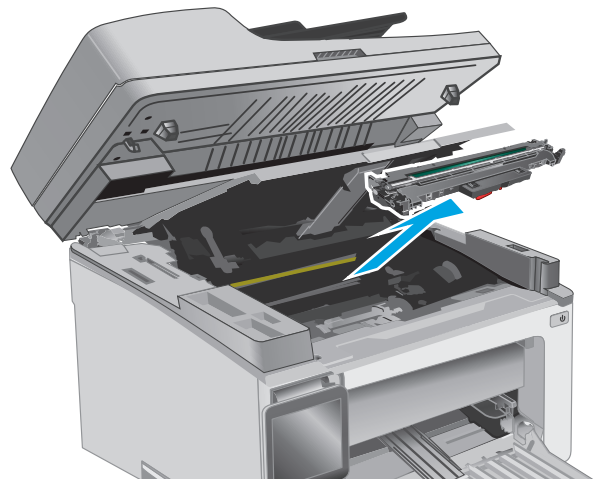

4. Remove any jammed paper from the toner-cartridge area. Use both hands to remove jammed paper to avoid tearing the paper.

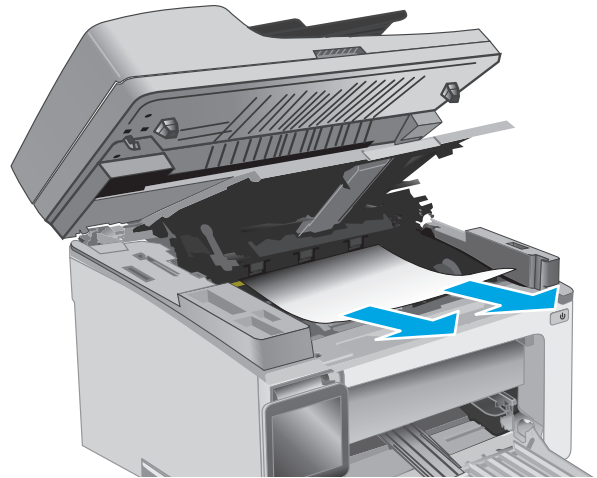

5. Insert the imaging drum into the printer.

NOTE: M133-M134 models: Install the imaging drum and toner cartridge as one unit.

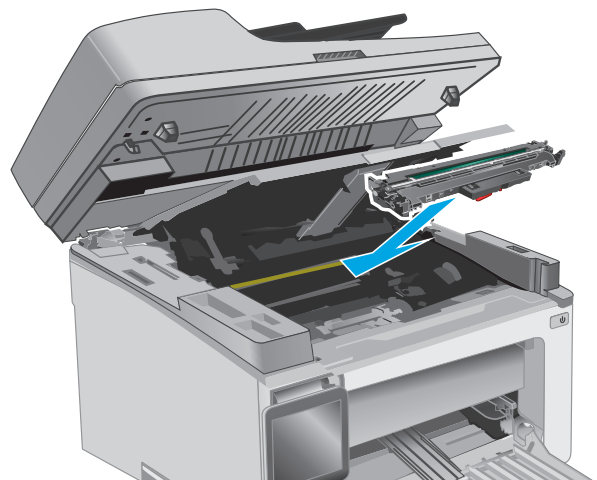

6. Insert the toner cartridge.

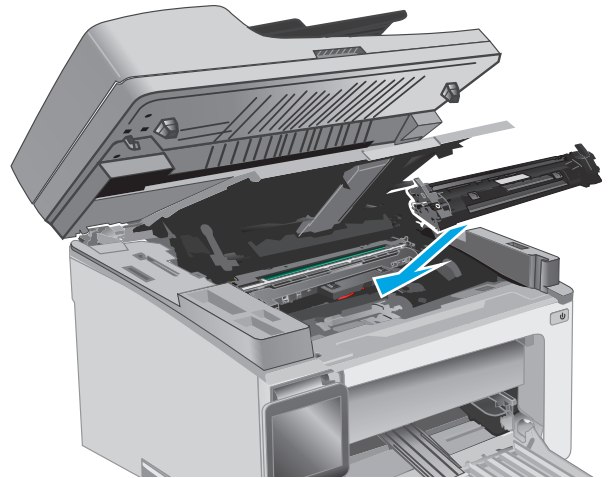

7. Close the top cover, and then lower the scanner assembly.

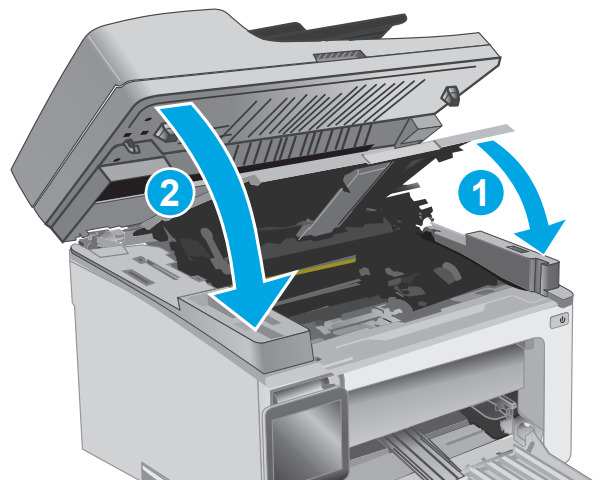

Clear paper jams in the output bin

When a jam occurs, the Attention  light blinks repeatedly on LED control panels, and a jam message displays on 2-line and touchscreen control panels.

1. Remove any visible jammed paper from the output bin area. Use both hands to remove jammed paper to avoid tearing the paper.

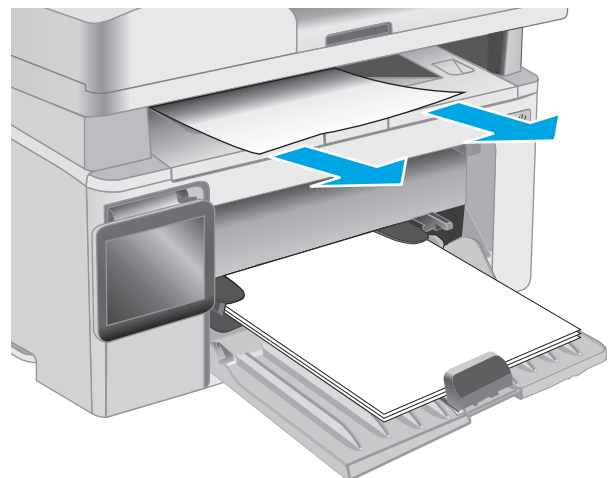

2. Lift the scanner assembly, and then open the top cover.

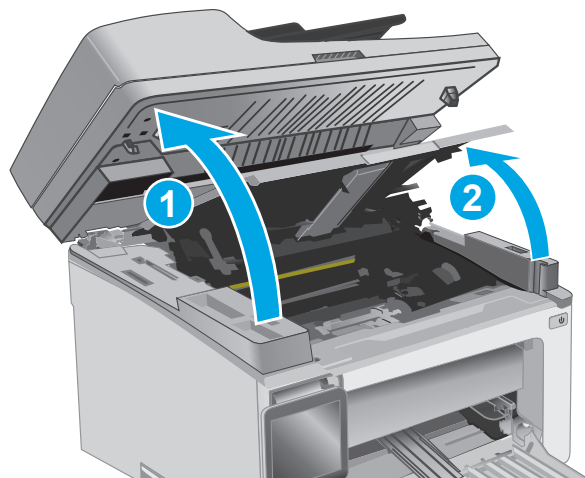

3. Remove the toner cartridge.

NOTE: M133-M134 models: Remove the imaging drum and toner cartridge as one unit.

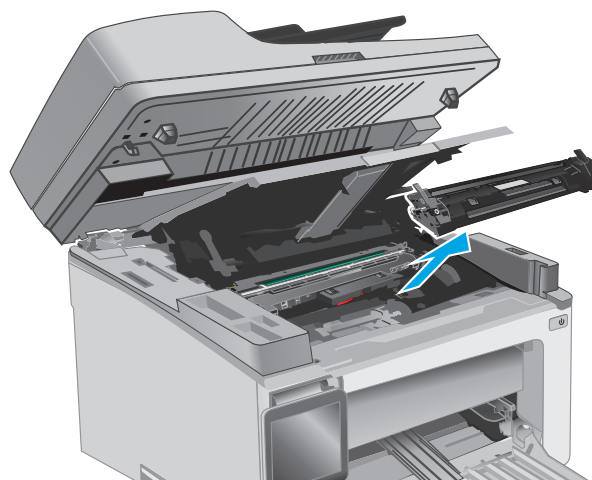

4. Remove the imaging drum.

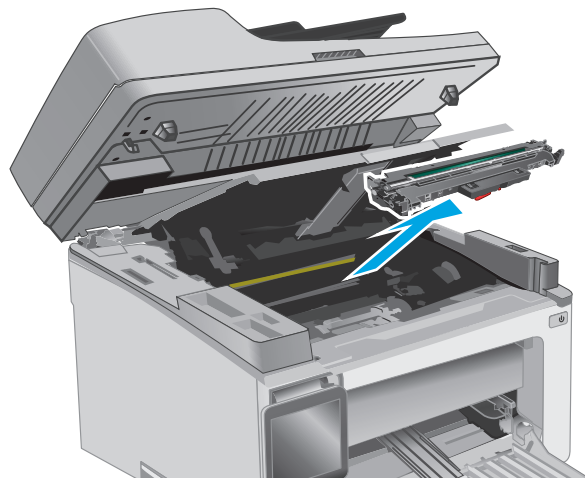

5. Remove any jammed paper from the toner-cartridge area.

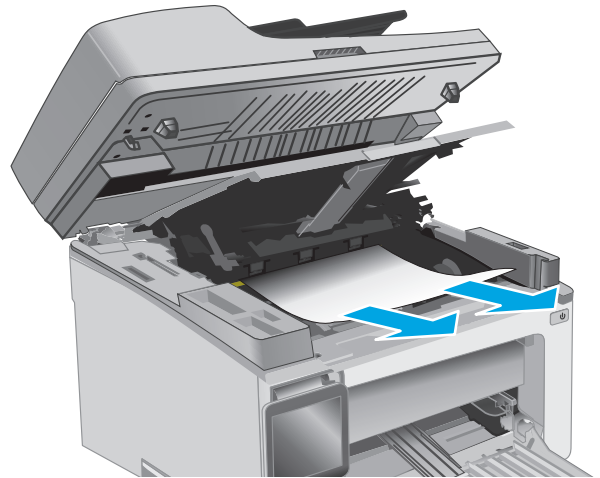

6. Insert the imaging drum into the printer.

NOTE: M133-M134 models: Install the imaging drum and toner cartridge as one unit.

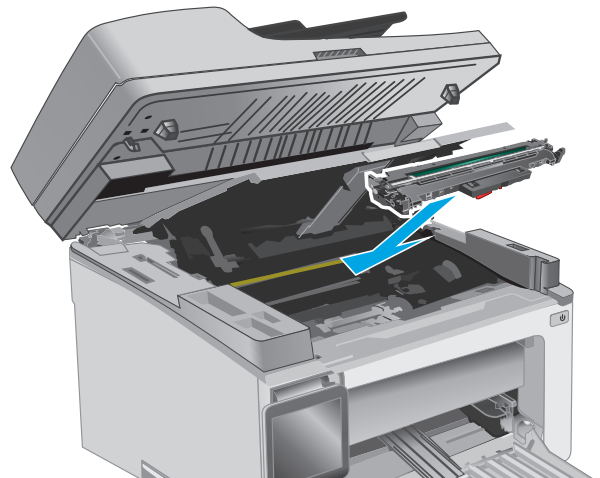

7. Insert the toner cartridge.

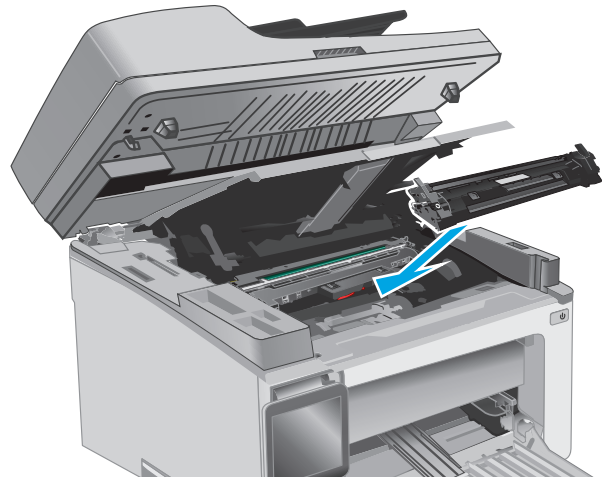

8. Close the top cover, and then lower the scanner assembly.

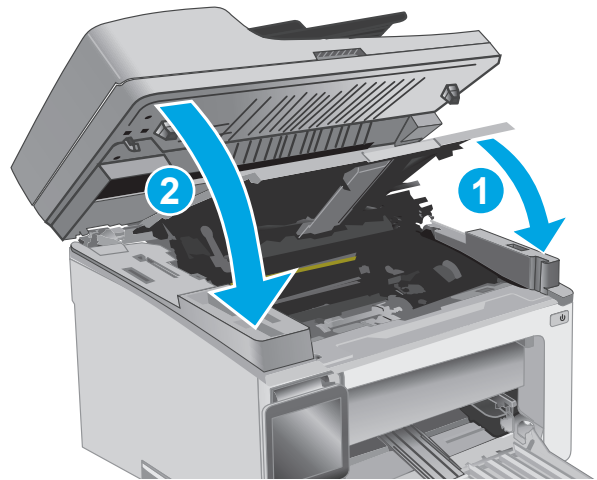

Clear paper jams in the document feeder (document feeder models only)

When a jam occurs, a jam message displays on the printer control panel.

1. Remove any loose paper from the input tray of the document feeder.

2. Remove any jammed paper visible in the input tray area. Use both hands to remove jammed paper to avoid tearing the paper.

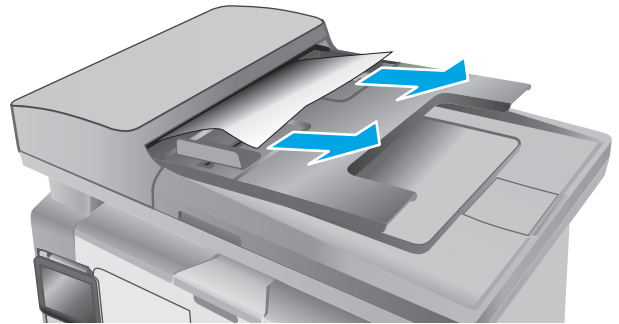

3. Lift the jam-access cover in the document feeder.

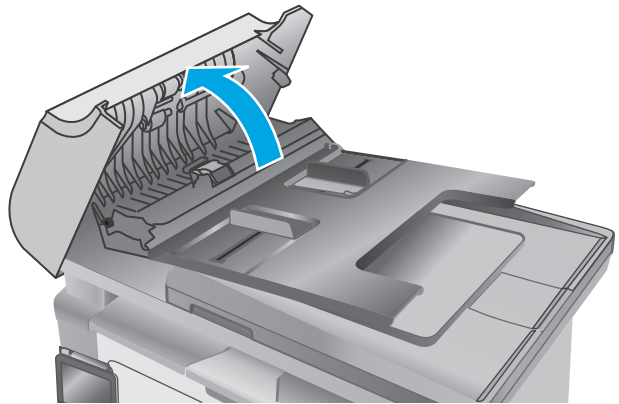

4. Remove any jammed paper.

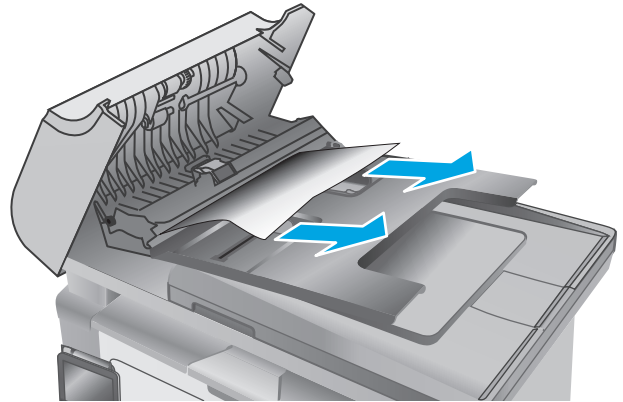

5. Close the jam-access cover.

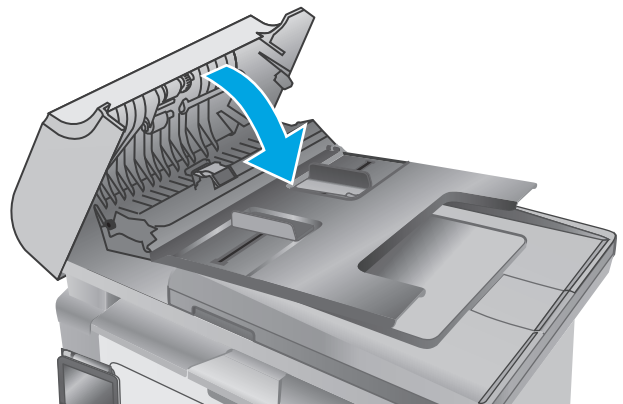

Clean the ADF replaceable film assembly

Over time, specks of debris might collect on the automatic document feeder (ADF) glass strip and replaceable film assembly, which can affect performance. Use the following procedure to clean the glass and film assembly.

1. Open the scanner lid, and then locate the ADF replaceable film assembly.

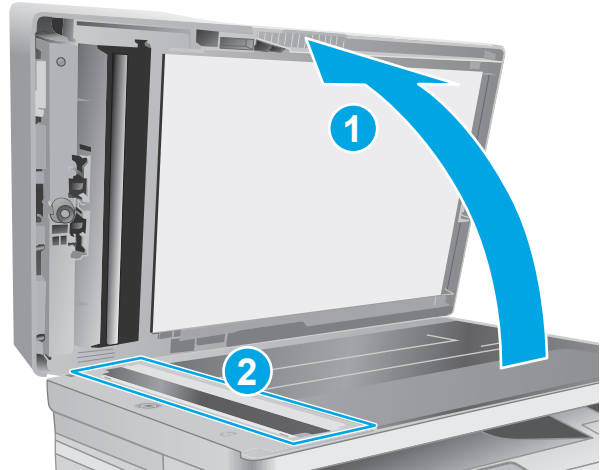

2. Use two slots to pry the film assembly away from the scanner body.

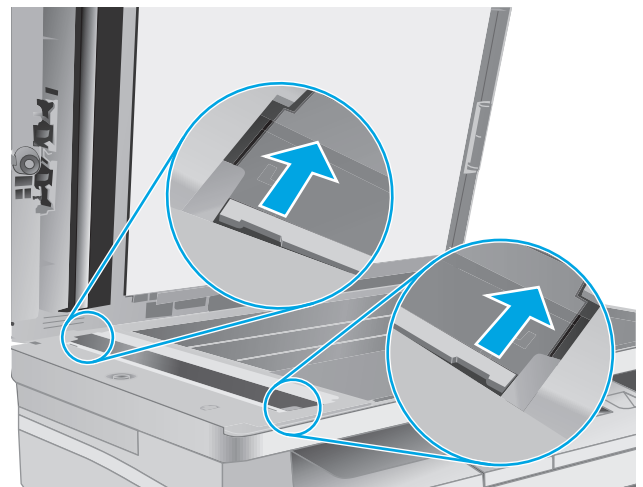

3. Slide the assembly in the direction indicated to remove it.

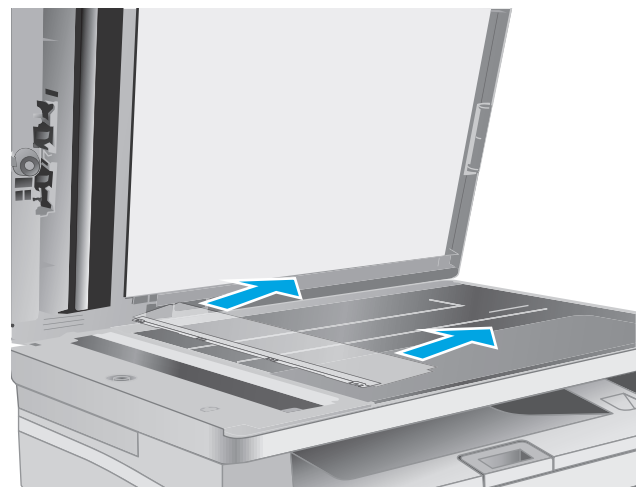

4. Clean the glass strip and the film assembly with a lint-free cloth.

CAUTION: Do not use abrasives, acetone, benzene, ammonia, ethyl alcohol, or carbon tetrachloride on any part of the printer; these can damage the printer. Do not place liquids directly on the glass or platen. They might seep and damage the printer.

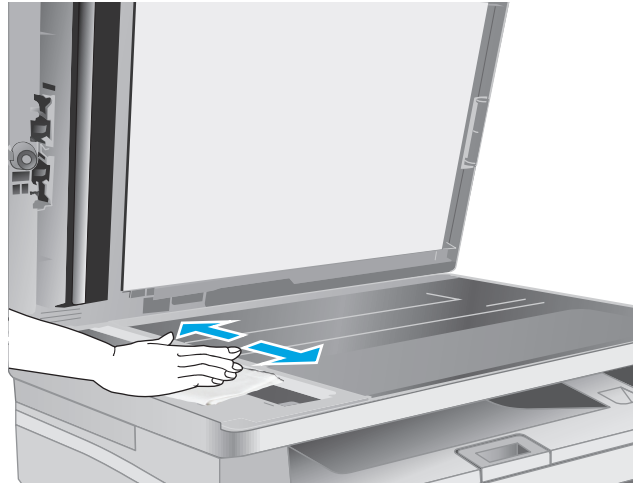

5. Reinstall the film assembly. Make sure that the film slides underneath the tabs on each end of the scanner body.

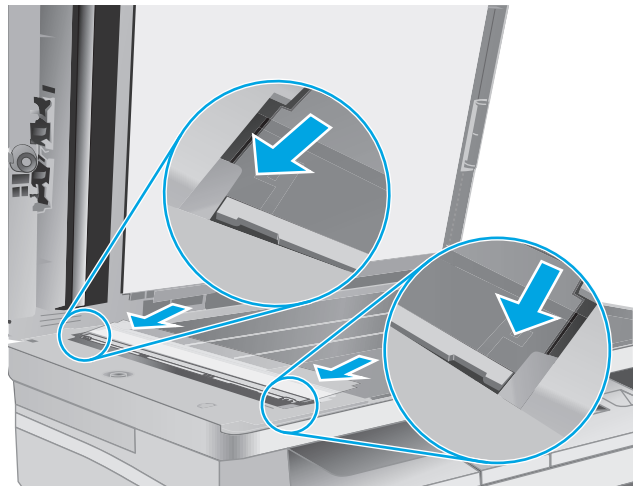

6. Close the scanner lid.



Improve print quality

Introduction

If the printer is having print-quality problems, try the following solutions in the order presented to resolve the issue.

Print from a different software program

Try printing from a different software program. If the page prints correctly, the problem is with the software program from which you were printing.

Check the paper-type setting for the print job

Check the paper type setting when printing from a software program and the printed pages have smears, fuzzy or dark print, curled paper, scattered dots of toner, loose toner, or small areas of missing toner.

Check the paper type setting (Windows)

1. From the software program, select the **Print** option.
2. Select the printer, and then click the **Properties** or **Preferences** button.
3. Click the **Paper/Quality** tab.
4. From the **Media:** drop-down list, select the correct paper type.
5. Click the **OK** button to close the **Document Properties** dialog box. In the **Print** dialog, click the **OK** button to print the job.

Check the paper type setting (OS X)

1. Click the **File** menu, and then click the **Print** option.
2. In the **Printer** menu, select the printer.
3. By default, the print driver displays the **Copies & Pages** menu. Open the menus drop-down list, and then click the **Finishing** menu.
4. Select a type from the **Media-type** drop-down list.
5. Click the **Print** button.

Check toner-cartridge status

Follow these steps to check the estimated life remaining in the toner cartridges and if applicable, the status of other replaceable maintenance parts.



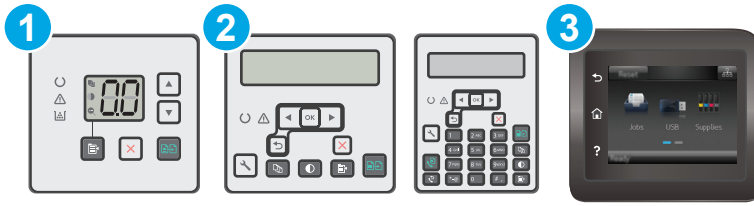

NOTE: The steps vary according to the type of control panel.



1	LED control panel
2	2-line control panel
3	Touchscreen control panel

Step one: Print the supplies status page (LED control panels)

1. Press and hold the Start Copy  button until the Ready  light begins blinking.
2. Release the Start Copy  button.

The supplies status page prints with the printer configuration page.

Step one: Print the supplies status page (2-line and touchscreen control panels)

1. On the printer control panel, open the [Setup](#) menu.
2. Open the [Reports](#) menu.
3. **2-line control panels:** Open the **Supplies Status** menu, press the **OK** button, select **Print Supplies status page** item, and then press the **OK** button.

Touchscreen control panels: Touch [Supplies Status](#).

Step two: Check supplies status

1. Look at the supplies status report to check the percent of life remaining for the toner cartridges and if applicable, the status of other replaceable maintenance parts.

Print quality problems can occur when using a toner cartridge that is at its estimated end of life. The supplies status page indicates when a supply level is very low. After an HP supply has reached the very low threshold, HP's premium protection warranty on that supply has ended.

The toner cartridge does not need to be replaced now unless the print quality is no longer acceptable. Consider having a replacement available to install when print quality is no longer acceptable.

If you determine that you need to replace a toner cartridge or other replaceable maintenance parts, the supplies status page lists the genuine HP part numbers.

2. Check to see if you are using a genuine HP cartridge.

A genuine HP toner cartridge has "HP" on it, or has the HP logo on it. For more information on identifying HP cartridges go to www.hp.com/go/learnaboutsupplies.

Clean the printer

Print a cleaning page

During the printing process paper, toner, and dust particles can accumulate inside the printer and can cause print-quality issues such as toner specks or spatter, smears, streaks, lines, or repeating marks.

Use the following procedure to print a cleaning page.

 **NOTE:** The steps vary according to the type of control panel.

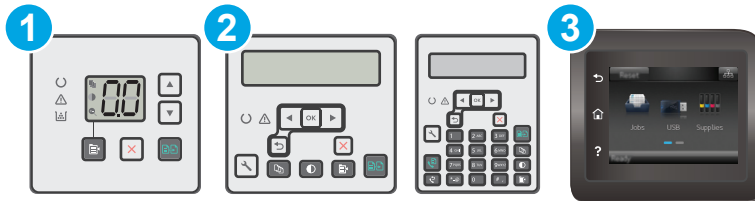

1	LED control panel
2	2-line control panel
3	Touchscreen control panel

LED control panels:

1. Open the HP Embedded Web Server (EWS):
 - a. Open the HP Printer Assistant.
 - **Windows 8.1:** Click the down arrow in lower left corner of the **Start** screen, and then select the printer name.
 - **Windows 8:** Right-click an empty area on the **Start** screen, click **All Apps** on the app bar, and then select the printer name.
 - **Windows 7, Windows Vista, and Windows XP:** From the computer desktop, click **Start**, select **All Programs**, click **HP**, click the folder for the printer, select the icon with the printer's name, and then open **HP Printer Assistant**.
 - b. In the HP Printer Assistant, select **Print**, and then select **HP Device Toolbox**.
2. Click the **System** tab, and then select the **Service** page.
3. In the **Cleaning Mode** area, click **Start** to begin the cleaning process.

2-line and touchscreen control panels

1. On the printer control panel, open the **Setup** menu.
2. Open the following menus:

- [Service](#)
 - [Cleaning Page](#)
3. Load plain letter or A4 paper when you are prompted, and then press the **OK** button.

A **Cleaning** message displays on the printer control panel. Wait until the process is complete. Discard the page that prints.

Visually inspect the toner cartridge and imaging drum

Follow these steps to inspect each toner cartridge and imaging drum.

1. Remove the toner cartridge and imaging drum from the printer.
2. Check the memory chip for damage.
3. Examine the surface of the green imaging drum.

 **CAUTION:** Do not touch the imaging drum. Fingerprints on the imaging drum can cause print-quality problems.

4. If you see any scratches, fingerprints, or other damage on the imaging drum, replace the toner cartridge and imaging drum.
5. Reinstall the toner cartridge and imaging drum, and print a few pages to see if the problem has resolved.

Check paper and the printing environment

Step one: Use paper that meets HP specifications

Some print-quality problems arise from using paper that does not meet HP specifications.

- Always use a paper type and weight that this printer supports.
- Use paper that is of good quality and free of cuts, nicks, tears, spots, loose particles, dust, wrinkles, voids, staples, and curled or bent edges.
- Use paper that has not been previously printed on.
- Use paper that does not contain metallic material, such as glitter.
- Use paper that is designed for use in laser printers. Do not use paper that is designed only for use in Inkjet printers.
- Use paper that is not too rough. Using smoother paper generally results in better print quality.

Step two: Check the environment

The environment can directly affect print quality and is a common cause for print-quality or paper-feeding issues. Try the following solutions:

- Move the printer away from drafty locations, such as open windows or doors, or air-conditioning vents.
- Make sure the printer is not exposed to temperatures or humidity outside of printer specifications.
- Do not place the printer in a confined space, such as a cabinet.

- Place the printer on a sturdy, level surface.
- Remove anything that is blocking the vents on the printer. The printer requires good air flow on all sides, including the top.
- Protect the printer from airborne debris, dust, steam, grease, or other elements that can leave residue inside the printer.

Check the EconoMode settings

HP does not recommend the full-time use of EconoMode. If EconoMode is used full-time, the toner supply might outlast the mechanical parts in the toner cartridge. If print quality begins to degrade and is no longer acceptable, consider replacing the toner cartridge.

 **NOTE:** This feature is available with the PCL 6 print driver for Windows. If you are not using that driver, you can enable the feature by using the HP Embedded Web Server.

Follow these steps if the entire page is too dark or too light.

1. From the software program, select the **Print** option.
2. Select the printer, and then click the **Properties** or **Preferences** button.
3. Click the **Paper/Quality** tab, and then locate the **Quality Settings** area.
 - If the entire page is too dark, select the **EconoMode** setting.
 - If the entire page is too light, select the **FastRes 1200** setting.
4. Click the **OK** button to close the **Document Properties** dialog box. In the **Print** dialog, click the **OK** button to print the job.

Adjust print density

Complete the following steps to adjust the print density.

 **NOTE:** The steps vary according to the type of control panel.

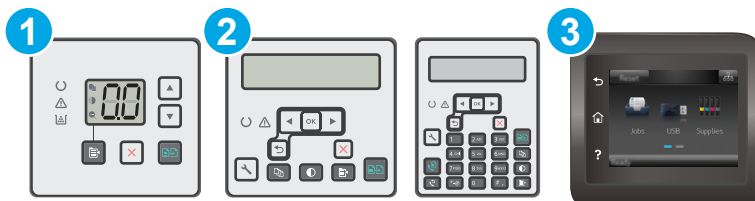

- | | |
|---|---------------------------|
| 1 | LED control panel |
| 2 | 2-line control panel |
| 3 | Touchscreen control panel |

LED control panels:

1. Open the HP Embedded Web Server (EWS):
 - a. Open the HP Printer Assistant.

- **Windows 8.1:** Click the down arrow in lower left corner of the **Start** screen, and then select the printer name.
 - **Windows 8:** Right-click an empty area on the **Start** screen, click **All Apps** on the app bar, and then select the printer name.
 - **Windows 7, Windows Vista, and Windows XP:** From the computer desktop, click **Start**, select **All Programs**, click **HP**, click the folder for the printer, select the icon with the printer's name, and then open **HP Printer Assistant**.
- b. In the HP Printer Assistant, select **Print**, and then select **HP Device Toolbox**.
2. Click the **System** tab, select the **Print Quality** page, and then select the **Print Density** option.
 3. Select the correct density setting.
 - 1: lightest
 - 2: lighter
 - 3: default
 - 4: darker
 - 5: darkest
 4. Click **Apply**.

2-line and touchscreen control panels:

1. On the printer control panel, open the **Setup** menu.
2. Open the following menus:
 - **System Setup**
 - **Print Density**
3. Select the correct print density setting.
 - 1: lightest
 - 2: lighter
 - 3: default
 - 4: darker
 - 5: darkest

Improve copy and scan image quality

Introduction

If the printer is having image quality problems, try the following solutions in the order presented to resolve the issue.

- [Check the scanner glass for dirt and smudges](#)
- [Check the paper settings](#)
- [Optimize for text or pictures](#)
- [Edge-to-edge copying](#)
- [Clean the pickup rollers and separation pad in the document feeder](#)

Try these few simple steps first:

- Use the flatbed scanner rather than the document feeder.
- Use high-quality originals.
- When using the document feeder, load the original document into the feeder correctly, using the paper guides, to avoid unclear or skewed images.

If the problem still exists, try these additional solutions. If they do not fix the problem, see “Improve print quality” for further solutions.

Check the scanner glass for dirt and smudges

Over time, specks of debris might collect on the scanner glass and white plastic backing, which can affect performance. Use the following procedure to clean the scanner.

1. Press the power button to turn the printer off, and then disconnect the power cable from the electrical outlet.
2. Open the scanner lid.
3. Clean the scanner glass and the white plastic backing underneath the scanner lid with a soft cloth or sponge that has been moistened with nonabrasive glass cleaner.

 **CAUTION:** Do not use abrasives, acetone, benzene, ammonia, ethyl alcohol, or carbon tetrachloride on any part of the printer; these can damage the printer. Do not place liquids directly on the glass or platen. They might seep and damage the printer.

4. Dry the glass and white plastic parts with a chamois or a cellulose sponge to prevent spotting.
5. Connect the power cable to an outlet, and then press the power button to turn the printer on.

Check the paper settings



NOTE: The steps vary according to the type of control panel.

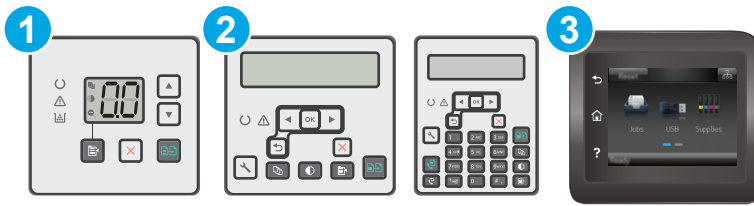

1	LED control panel
2	2-line control panel
3	Touchscreen control panel

LED control panels

1. Open the HP Embedded Web Server (EWS):
 - a. Open the HP Printer Assistant.
 - **Windows 8.1:** Click the down arrow in lower left corner of the **Start** screen, and then select the printer name.
 - **Windows 8:** Right-click an empty area on the **Start** screen, click **All Apps** on the app bar, and then select the printer name.
 - **Windows 7, Windows Vista, and Windows XP:** From the computer desktop, click **Start**, select **All Programs**, click **HP**, click the folder for the printer, select the icon with the printer's name, and then open **HP Printer Assistant**.
 - b. In the HP Printer Assistant, select **Print**, and then select **HP Device Toolbox**.
2. On the **Systems** tab, click **Paper Setup**.
3. Change the necessary settings, and then click **Apply**.

LCD control panels

1. On the printer control panel, press the Setup  button.
2. Open the following menus:
 - **System Setup**
 - **Paper Setup**
3. Select **Def. paper size**.
4. Select the name of the paper size that is in the input tray, and then press the **OK** button.
5. Select **Def. paper type**.
6. Select the name of the paper type that is in the input tray, and then press the **OK** button.

Touchscreen control panels

1. From the Home screen on the product control panel, touch the Setup  button.
2. Open the following menus:
 - System Setup
 - Paper Setup
3. Select the Paper Size option, and then touch the name of the paper size that is in the input tray.
4. Select the Paper Type option, and then touch the name of the paper type that is in the input tray.

Optimize for text or pictures



NOTE: The steps vary according to the type of control panel.

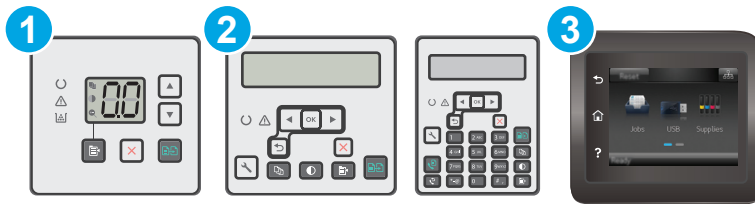

- | | |
|---|---------------------------|
| 1 | LED control panel |
| 2 | 2-line control panel |
| 3 | Touchscreen control panel |

LED control panels

1. Open the HP Embedded Web Server (EWS):
 - a. Open the HP Printer Assistant.
 - **Windows 8.1:** Click the down arrow in lower left corner of the **Start** screen, and then select the printer name.
 - **Windows 8:** Right-click an empty area on the **Start** screen, click **All Apps** on the app bar, and then select the printer name.
 - **Windows 7, Windows Vista, and Windows XP:** From the computer desktop, click **Start**, select **All Programs**, click **HP**, click the folder for the printer, select the icon with the printer's name, and then open **HP Printer Assistant**.
 - b. In the HP Printer Assistant, select **Print**, and then select **HP Device Toolbox**.
2. On the **Copy** tab, select the **Optimize** drop-down list.
3. Select the setting you want to use.
 - **Auto Select:** Use this setting when you are not concerned about the quality of the copy. This is the default setting.
 - **Mixed:** Use this setting for documents that contain a mixture of text and graphics.

- **Text:** Use this setting for documents that contain mostly text.
 - **Picture:** Use this setting for documents that contain mostly graphics.
4. Change the necessary settings, and then click **Apply**.

2-line control panels

1. On the printer control panel, press the **Copy Menu**  button.
2. To optimize copy quality for different types of documents, use the arrow keys to select the **Optimize** menu, and then press the **OK** button. The following copy-quality settings are available:
 - **Auto Select:** Use this setting when you are not concerned about the quality of the copy. This is the default setting.
 - **Mixed:** Use this setting for documents that contain a mixture of text and graphics.
 - **Text:** Use this setting for documents that contain mostly text.
 - **Picture:** Use this setting for documents that contain mostly graphics.

Touchscreen control panels

1. From the Home screen on the printer control panel, touch the **Copy**  icon.
2. Touch the **Settings** button, and then scroll to and touch the **Optimize** button.
3. Touch the name of the setting you want to adjust.
 - **Auto Select:** Use this setting when you are not concerned about the quality of the copy. This is the default setting.
 - **Mixed:** Use this setting for documents that contain a mixture of text and graphics.
 - **Text:** Use this setting for documents that contain mostly text.
 - **Picture:** Use this setting for documents that contain mostly graphics.

Edge-to-edge copying

The printer cannot print fully edge-to-edge. There is a 4 mm (1/6 inch) unprintable border around the page.

Considerations for printing or scanning documents with cropped edges:

- When the original is smaller than the output size, move the original 4 mm (1/6 inch) away from the corner indicated by the icon on the scanner. Recopy or scan in this position.
- When the original is the size of the printed output that you want, use the **Reduce/Enlarge** feature to reduce the image so the copy is not cropped.

Clean the pickup rollers and separation pad in the document feeder

If the document feeder experiences paper-handling problems, such as jams or multiple-page feeds, clean the document-feeder rollers and separation pad.

1. Open the document-feeder access cover.

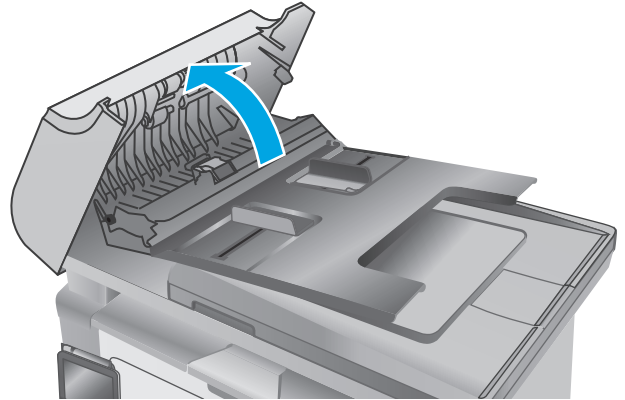

2. Use a moist, lint-free cloth to wipe both pickup rollers and the separation pad to remove dirt.

CAUTION: Do not use abrasives, acetone, benzene, ammonia, ethyl alcohol, or carbon tetrachloride on any part of the printer; these can damage the printer. Do not place liquids directly on the glass or platen. They might seep and damage the printer.

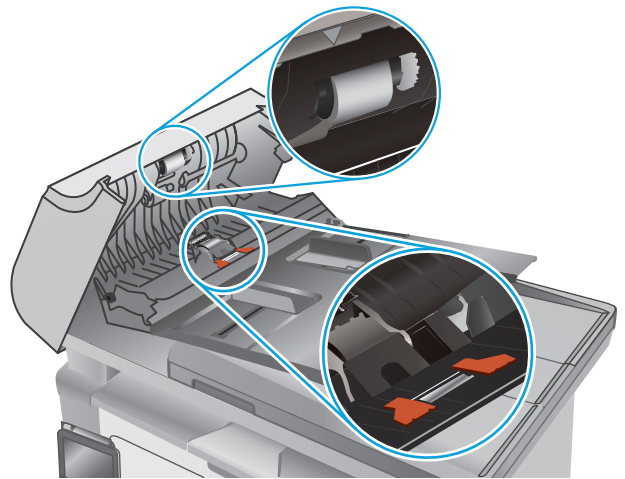

3. Close the document feeder access cover.

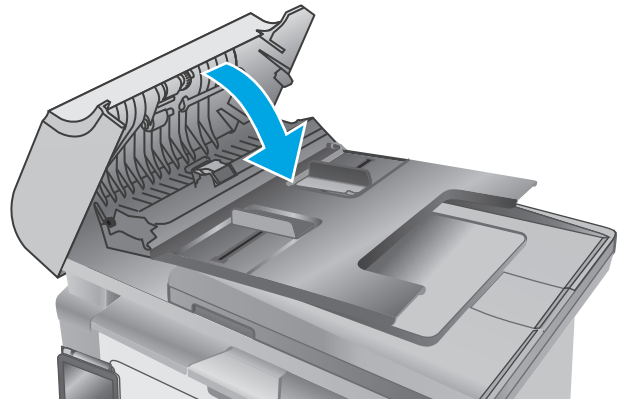

Improve fax image quality

Introduction

If the printer is having image quality problems, try the following solutions in the order presented to resolve the issue.

- [Check the scanner glass for dirt and smudges](#)
- [Check the send-fax resolution settings](#)
- [Check the error-correction settings](#)
- [Check the fit-to-page setting](#)
- [Clean the pickup rollers and separation pad in the document feeder](#)
- [Send to a different fax machine](#)
- [Check the sender's fax machine](#)

Try these few simple steps first:

- Use the flatbed scanner rather than the document feeder.
- Use high-quality originals.
- When using the document feeder, load the original document into the feeder correctly, using the paper guides, to avoid unclear or skewed images.

If the problem still exists, try these additional solutions. If they do not fix the problem, see “Improve print quality” for further solutions.

Check the scanner glass for dirt and smudges

Over time, specks of debris might collect on the scanner glass and white plastic backing, which can affect performance. Use the following procedure to clean the scanner.

1. Press the power button to turn the printer off, and then disconnect the power cable from the electrical outlet.
2. Open the scanner lid.
3. Clean the scanner glass and the white plastic backing underneath the scanner lid with a soft cloth or sponge that has been moistened with nonabrasive glass cleaner.

 **CAUTION:** Do not use abrasives, acetone, benzene, ammonia, ethyl alcohol, or carbon tetrachloride on any part of the printer; these can damage the printer. Do not place liquids directly on the glass or platen. They might seep and damage the printer.

4. Dry the glass and white plastic parts with a chamois or a cellulose sponge to prevent spotting.
5. Connect the power cable to an outlet, and then press the power button to turn the printer on.

Check the send-fax resolution settings

 **NOTE:** The steps vary according to the type of control panel.

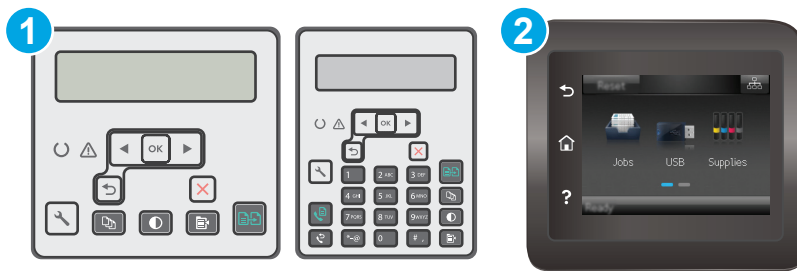

- | | |
|---|---------------------------|
| 1 | 2-line control panel |
| 2 | Touchscreen control panel |

2-line control panels

1. On the printer control panel, press the Setup  button.
2. Select **Fax Setup**.
3. Select **Send Fax Setup**, and then select **Def. Resolution**.
4. Select the desired resolution setting, and then press **OK**.

Touchscreen control panels

1. From the Home screen on the printer control panel, touch the Setup  button.
2. Select **Fax Setup**.
3. Select **Advanced Setup**, and then select **Fax Resolution**.
4. Select the desired resolution setting, and then touch **OK**.

Check the error-correction settings

Usually, the printer monitors the signals on the telephone line while it is sending or receiving a fax. If the printer detects an error during the transmission and the error-correction setting is **On**, the printer can request that the portion of the fax be resent. The factory-set default for error correction is **On**.

You should turn off error correction only if you are having trouble sending or receiving a fax, and you are willing to accept the errors in the transmission. Turning off the setting might be useful when you are trying to send a fax overseas or receive one from overseas, or if you are using a satellite telephone connection.

 **NOTE:** The steps vary according to the type of control panel.



1	2-line control panel
2	Touchscreen control panel

2-line control panels

1. On the printer control panel, press the Setup  button.
2. Select **Fax Setup**, and then select **All Faxes**.
3. Select **Error Correction**, and then select **On**.

Touchscreen control panels

1. From the Home screen on the printer control panel, touch the Setup  button.
2. Select **Service**, and then select **Fax Service**.
3. Select **Error Correction**, and then select **On**.

Check the fit-to-page setting

If the printer printed a fax job off the page, turn on the fit-to-page feature from the printer control panel.

 **NOTE:** Make sure that the default paper size setting matches the size of the paper in the tray.

 **NOTE:** The steps vary according to the type of control panel.

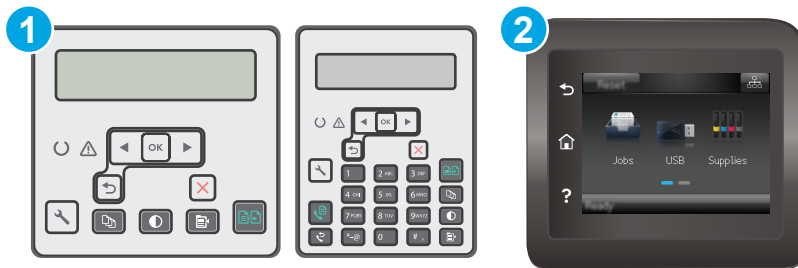

1	2-line control panel
2	Touchscreen control panel

2-line control panels

1. On the printer control panel, press the Setup  button.
2. Select **Fax Setup**, and then select **Recv. Fax Setup**.
3. Select **Fit to Page**, and then select **On**.

Touchscreen control panels

1. From the Home screen on the printer control panel, touch the Setup  button.
2. Select **Fax Setup**, and then select **Advanced Setup**.
3. Select **Fit to Page**, and then select **On**.

Clean the pickup rollers and separation pad in the document feeder

If the document feeder experiences paper-handling problems, such as jams or multiple-page feeds, clean the document-feeder rollers and separation pad.

1. Open the document-feeder access cover.

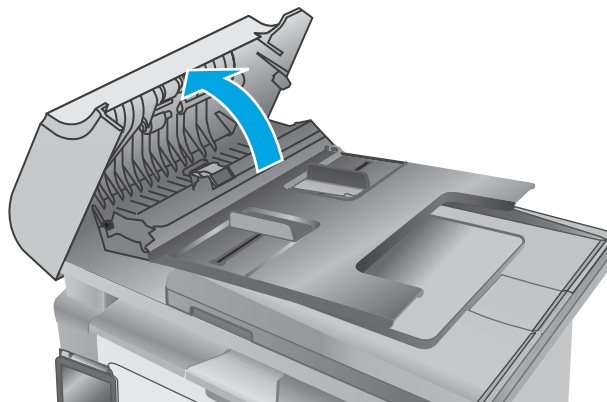

2. Use a moist, lint-free cloth to wipe both pickup rollers and the separation pad to remove dirt.

CAUTION: Do not use abrasives, acetone, benzene, ammonia, ethyl alcohol, or carbon tetrachloride on any part of the printer; these can damage the printer. Do not place liquids directly on the glass or platen. They might seep and damage the printer.

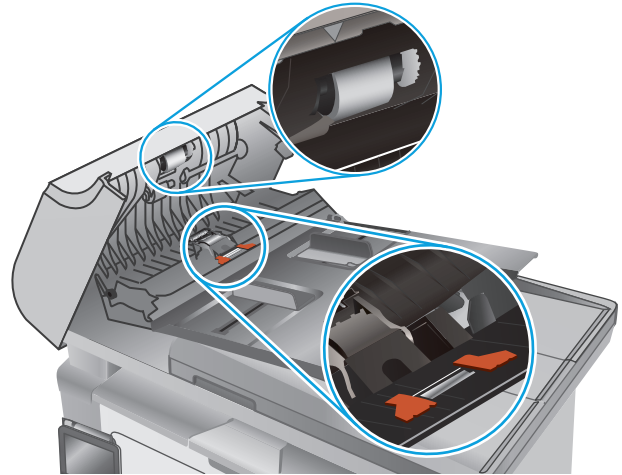

3. Close the document feeder access cover.

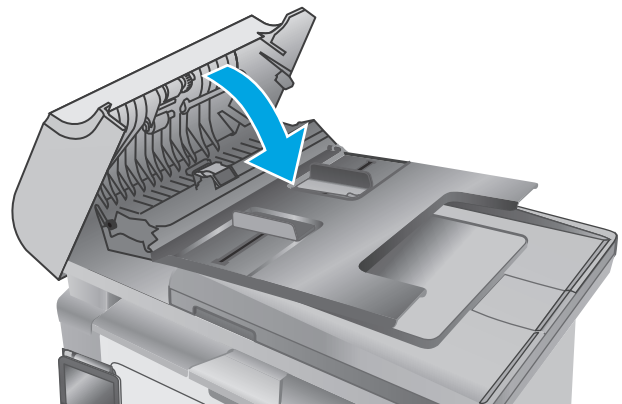

Send to a different fax machine

Try sending the fax to a different fax machine. If the fax quality is better, the problem is related to the initial recipient's fax machine settings or supplies status.

Check the sender's fax machine

Ask the sender to try sending from a different fax machine. If the fax quality is better, the problem is with the sender's fax machine. If a different fax machine is unavailable, ask the sender to consider making the following changes:

- Make sure the original document is on white (not colored) paper.
- Increase the fax resolution, quality level, or contrast settings.
- If possible, send the fax from a computer software program.

Solve wired network problems

Introduction

Check the following items to verify that the printer is communicating with the network. Before beginning, print a configuration page from the printer control panel and locate the printer IP address that is listed on this page.

- [Poor physical connection](#)
- [The computer is using the incorrect IP address for the printer](#)
- [The computer is unable to communicate with the printer](#)
- [The printer is using incorrect link speed settings for the network](#)
- [New software programs might be causing compatibility problems](#)
- [The computer or workstation might be set up incorrectly](#)
- [The printer is disabled, or other network settings are incorrect](#)



NOTE: HP does not support peer-to-peer networking, as the feature is a function of Microsoft operating systems and not of the HP print drivers. For more information, go to Microsoft at www.microsoft.com.

Poor physical connection

1. Verify that the printer is attached to the correct network port using a cable of the correct length.
2. Verify that cable connections are secure.
3. Look at the network port connection on the back of the printer, and verify that the amber activity light and the green link-status light are lit.
4. If the problem continues, try a different cable or port on the hub.

The computer is using the incorrect IP address for the printer

1. Open the printer properties and click the **Ports** tab. Verify that the current IP address for the printer is selected. The printer IP address is listed on the printer configuration page.
2. If you installed the printer using the HP standard TCP/IP port, select the box labeled **Always print to this printer, even if its IP address changes**.
3. If you installed the printer using a Microsoft standard TCP/IP port, use the hostname instead of the IP address.
4. If the IP address is correct, delete the printer and then add it again.

The computer is unable to communicate with the printer

1. Test network communication by pinging the network.
 - a. Open a command-line prompt on your computer.

- For Windows, click **Start**, click **Run**, type `cmd`, and then press **Enter**.
 - For OS X, go to **Applications**, then **Utilities**, and open **Terminal**.
- b. Type `ping` followed by the IP address for your printer.
 - c. If the window displays round-trip times, the network is working.
2. If the ping command failed, verify that the network hubs are on, and then verify that the network settings, the printer, and the computer are all configured for the same network.

The printer is using incorrect link speed settings for the network

HP recommends leaving these settings in automatic mode (the default setting). If you change these settings, you must also change them for your network.

New software programs might be causing compatibility problems

Verify that any new software programs are correctly installed and that they use the correct print driver.

The computer or workstation might be set up incorrectly

1. Check the network drivers, print drivers, and the network redirection settings.
2. Verify that the operating system is configured correctly.

The printer is disabled, or other network settings are incorrect

1. Review the configuration page to check the status of the network protocol. Enable it if necessary.
2. Reconfigure the network settings if necessary.

Solve wireless network problems

- [Introduction](#)
- [Wireless connectivity checklist](#)
- [The printer does not print after the wireless configuration completes](#)
- [The printer does not print, and the computer has a third-party firewall installed](#)
- [The wireless connection does not work after moving the wireless router or printer](#)
- [Cannot connect more computers to the wireless printer](#)
- [The wireless printer loses communication when connected to a VPN](#)
- [The network does not appear in the wireless networks list](#)
- [The wireless network is not functioning](#)
- [Perform a wireless network diagnostic test](#)
- [Reduce interference on a wireless network](#)

Introduction

Use the troubleshooting information to help resolve issues.



NOTE: To determine if Wi-Fi Direct printing is enabled on the printer, print a configuration page.

Wireless connectivity checklist

- Verify that the network cable is not connected.
- Verify that the printer and the wireless router are turned on and have power. Also make sure that the wireless radio in the printer is turned on.
- Verify that the service set identifier (SSID) is correct. Print a configuration page to determine the SSID. If you are not sure the SSID is correct, run the wireless setup again.
- With secured networks, verify that the security information is correct. If the security information is incorrect, run the wireless setup again.
- If the wireless network is working correctly, try accessing other computers on the wireless network. If the network has Internet access, try connecting to the Internet over a wireless connection.
- Verify that the encryption method (AES or TKIP) is the same for the printer as it is for the wireless access point (on networks using WPA security).
- Verify that the printer is within the range of the wireless network. For most networks, the printer must be within 30 m (100 ft) of the wireless access point (wireless router).
- Verify that obstacles do not block the wireless signal. Remove any large metal objects between the access point and the printer. Make sure poles, walls, or support columns containing metal or concrete do not separate the printer and wireless access point.
- Verify that the printer is located away from electronic devices that might interfere with the wireless signal. Many devices can interfere with the wireless signal including motors, cordless phones, security system cameras, other wireless networks, and some Bluetooth devices.

- Verify that the print driver is installed on the computer.
- Verify that you have selected the correct printer port.
- Verify that the computer and printer connect to the same wireless network.
- For OS X, verify that the wireless router supports Bonjour.

The printer does not print after the wireless configuration completes

1. Make sure that the printer is turned on and in the ready state.
2. Turn off any third-party firewalls on your computer.
3. Make sure that the wireless network is working correctly.
4. Make sure that your computer is working correctly. If necessary, restart the computer.
5. Verify that you can open the printer HP Embedded Web Server from a computer on the network.

The printer does not print, and the computer has a third-party firewall installed

1. Update the firewall with the most recent update available from the manufacturer.
2. If programs request firewall access when you install the printer or try to print, make sure you allow the programs to run.
3. Temporarily turn off the firewall, and then install the wireless printer on the computer. Enable the firewall when you have completed the wireless installation.

The wireless connection does not work after moving the wireless router or printer

1. Make sure that the router or printer connects to the same network that your computer connects to.
2. Print a configuration page.
3. Compare the service set identifier (SSID) on the configuration page to the SSID in the printer configuration for the computer.
4. If the numbers are not the same, the devices are not connecting to the same network. Reconfigure the wireless setup for the printer.

Cannot connect more computers to the wireless printer

1. Make sure that the other computers are within the wireless range and that no obstacles block the signal. For most networks, the wireless range is within 30 m (100 ft) of the wireless access point.
2. Make sure that the printer is turned on and in the ready state.
3. Make sure there are not more than 5 concurrent Wi-Fi Direct users.
4. Turn off any third-party firewalls on your computer.
5. Make sure that the wireless network is working correctly.
6. Make sure that your computer is working correctly. If necessary, restart the computer.

The wireless printer loses communication when connected to a VPN

- Typically, you cannot connect to a VPN and other networks at the same time.

The network does not appear in the wireless networks list

- Make sure the wireless router is turned on and has power.
- The network might be hidden. However, you can still connect to a hidden network.

The wireless network is not functioning

1. Make sure that the network cable is not connected.
2. To verify if the network has lost communication, try connecting other devices to the network.
3. Test network communication by pinging the network.
 - a. Open a command-line prompt on your computer.
 - For Windows, click **Start**, click **Run**, type `cmd`, and then press **Enter**.
 - For OS X, go to **Applications**, then **Utilities**, and open **Terminal**.
 - b. Type `ping` followed by the router IP address.
 - c. If the window displays round-trip times, the network is working.
4. Make sure that the router or printer connects to the same network that the computer connects to.
 - a. Print a configuration page.
 - b. Compare the service set identifier (SSID) on the configuration report to the SSID in the printer configuration for the computer.
 - c. If the numbers are not the same, the devices are not connecting to the same network. Reconfigure the wireless setup for the printer.

Perform a wireless network diagnostic test

From the printer control panel, you can run a diagnostic test that provides information about the wireless network settings.

 **NOTE:** The steps vary according to the type of control panel.



1	2-line control panel
2	Touchscreen control panel

2-line control panels

1. On the printer control panel, press the Setup  button.
2. Open the following menus:
 - **Self Diagnostics**
 - **Run Wireless Test**
3. Press the **OK** button to start the test. The printer prints a test page that shows test results.

Touchscreen control panels

1. From the Home screen on the printer control panel, swipe until the **Setup** menu displays. Touch the **Setup**  icon to open the menu.
2. Scroll to and select **Self Diagnostics**.
3. Select **Run Wireless Test** to start the test. The printer prints a test page that shows test results.

Reduce interference on a wireless network

The following tips can reduce interference in a wireless network:

- Keep the wireless devices away from large metal objects, such as filing cabinets, and other electromagnetic devices, such as microwaves and cordless telephones. These objects can disrupt radio signals.
- Keep the wireless devices away from large masonry structures and other building structures. These objects can absorb radio waves and lower signal strength.
- Position the wireless router in a central location in line of sight with the wireless printers on the network.

Solve fax problems

Introduction

Use the fax troubleshooting information to help resolve issues.

- [Fax troubleshooting checklist](#)
- [Solve general fax problems](#)

Fax troubleshooting checklist

- Several possible fixes are available. After each recommended action, retry faxing to see if the problem is resolved.
 - For best results during fax problem solving, make sure the line from the printer is connected directly to the wall phone port. Disconnect all other devices that are connected to the printer.
1. Verify that the telephone cord is connected to the correct port on the back of the printer.
 2. Check the phone line by using the fax test:

2-line control panels

- a. On the product control panel, press the Setup  button.
- b. Select **Service**, and then select **Run Fax Test**. The product prints a fax test report.

Touchscreen control panels

- a. From the Home screen on the product control panel, touch the Setup  button.
- b. Open the following menus:
 - [Service](#)
 - [Fax Service](#)
- c. Select the [Run Fax Test](#) option. The printer prints a fax test report.

The report contains the following possible results:

- **Pass:** The report contains all of the current fax settings for review.
 - **Fail:** The report indicates the nature of the error and contains suggestions for how to resolve the issue.
3. Verify that the printer firmware is current:
 - a. Print a configuration page from the control panel [Reports](#) menu to obtain the current firmware date code.
 - b. Go to www.hp.com/support, select your country/region language, click **Get software and drivers** link, type the printer name in the search field, press the **ENTER** button, and then select the printer from the list of search results.
 - c. Select the operating system.
 - d. Under the **Firmware** section, locate the **Firmware Update Utility**.

 **NOTE:** Make sure to use the firmware update utility that is specific to the printer model.

- e. Click **Download**, click **Run**, and then click **Run** again.
- f. When the utility launches, select the printer from the drop-down list, and then click **Send Firmware**.

 **NOTE:** To print a configuration page to verify the installed firmware version before or after the update process, click **Print Config**.

- g. Follow the on-screen instructions to complete the installation, and then click the **Exit** button to close the utility.
4. Verify that the fax was set up when the printer software was installed.

From the computer, in the HP program folder, run the Fax Setup Utility.

5. Verify that the telephone service supports analog fax.
 - If using ISDN or digital PBX, contact your service provider for information about configuring to an analog fax line.
 - If using a VoIP service, change the **Fax Speed** setting to **Slow (V.29)** from the control panel. Ask if your service provider supports fax and for the recommended fax modem speed. Some companies might require an adapter.
 - If you are using a DSL service, make sure that a filter is included on the phone-line connection to the printer. Contact the DSL service provider, or purchase a DSL filter if you do not have one. If a DSL filter is installed, try another filter because filters can be defective.

Solve general fax problems

- [Faxes are sending slowly](#)
- [Fax quality is poor](#)
- [Fax cuts off or prints on two pages](#)

 **NOTE:** The steps vary according to the type of control panel.



-
- | | |
|---|---------------------------|
| 1 | 2-line control panel |
| 2 | Touchscreen control panel |
-

Faxes are sending slowly

The printer is experiencing poor phone line quality.

- Retry sending the fax when the line conditions have improved.
- Check with the phone service provider that the line supports fax.
- Turn off the [Error Correction](#) setting.

2-line control panels

- a. On the printer control panel, press the Setup  button.
- b. Select **Fax Setup**, and then select **All Faxes**.
- c. Select **Error Correction**, and then select **Off**.

Touchscreen control panels

- a. From the Home screen on the printer control panel, touch the Setup  button.
- b. Select [Service](#), and then select [Fax Service](#).
- c. Select [Error Correction](#), and then select [Off](#).



NOTE: This can reduce image quality.

- Use white paper for the original. Do not use colors such as gray, yellow, or pink.
- Increase the [Fax Speed](#) setting.

2-line control panels

- a. On the printer control panel, press the Setup  button.
- b. Select **Fax Setup**, and then select **All Faxes**.
- c. Select **Fax Speed**, and then select the correct setting.

Touchscreen control panels

- a. From the Home screen on the printer control panel, touch the Setup  button.
 - b. Select [Fax Setup](#).
 - c. Select [Advanced Setup](#), and then select [Fax Speed](#).
 - d. Select the correct setting.
- Divide large fax jobs into smaller sections, and then fax them individually.
 - Change the fax settings on the control panel to a lower resolution.

2-line control panels

- a. On the printer control panel, press the Setup  button.
- b. Select **Fax Setup**.

- c. Select **Send Fax Setup**, and then select **Def. Resolution**.
- d. Select the desired resolution setting, and then press **OK**.

Touchscreen control panels

- a. From the Home screen on the printer control panel, touch the Setup  button.
- b. Select **Fax Setup**.
- c. Select **Advanced Setup**, and then select **Fax Resolution**.
- d. Select the desired resolution setting, and then touch **OK**.

Fax quality is poor

Fax is blurry or light.

- Increase fax resolution when sending faxes. Resolution does not affect received faxes.

2-line control panels

- a. On the printer control panel, press the Setup  button.
- b. Select **Fax Setup**.
- c. Select **Send Fax Setup**, and then select **Def. Resolution**.
- d. Select the desired resolution setting, and then press **OK**.

Touchscreen control panels

- a. From the Home screen on the printer control panel, touch the Setup  button.
- b. Select **Fax Setup**.
- c. Select **Advanced Setup**, and then select **Fax Resolution**.
- d. Select the desired resolution setting, and then touch **OK**.



NOTE: Increasing resolution slows transmission speed.

- Turn on the **Error Correction** setting from the control panel.

2-line control panels

- a. On the printer control panel, press the Setup  button.
- b. Select **Fax Setup**, and then select **All Faxes**.
- c. Select **Error Correction**, and then select **On**.

Touchscreen control panels

- a. From the Home screen on the printer control panel, touch the Setup  button.
- b. Select **Service**, and then select **Fax Service**.
- c. Select **Error Correction**, and then select **On**.

- Check the toner cartridges and replace if necessary.
- Ask the sender to darken the contrast setting on the sending fax machine, and then resend the fax.

Fax cuts off or prints on two pages

- Set the [Default Paper Size](#) setting. Faxes print on a single size of paper based on the [Default Paper Size](#) settings.

2-line control panels

- On the printer control panel, press the Setup  button.
- Select **System Setup**, and then select **Paper Setup**.
- Select **Def. Paper Size**, and then select the correct setting.

Touchscreen control panels

- From the Home screen on the printer control panel, touch the Setup  button.
 - Select [System Setup](#), and then select [Paper Setup](#).
 - Select [Paper Size](#), and then select the correct setting.
- Set the paper type and size for the tray used for faxes.
 - Turn on the [Fit to Page](#) setting to print longer length faxes on letter or A4 size paper.

2-line control panels

- On the printer control panel, press the Setup  button.
- Select **Fax Setup**, and then select **Recv. Fax Setup**.
- Select **Fit to Page**, and then select **On**.

Touchscreen control panels

- From the Home screen on the printer control panel, touch the Setup  button.
- Select [Fax Setup](#), and then select [Advanced Setup](#).
- Select [Fit to Page](#), and then select **On**.



NOTE: If the [Fit to Page](#) setting is off and the [Default Paper Size](#) setting is set to letter, a legal size original prints on two pages.

Index

A

- accessories
 - ordering 24
 - part numbers 24
- acoustic specifications 15
- AirPrint 59
- Android devices
 - printing from 59
- applications
 - downloading 102
- Apps menu 102

B

- bin, output
 - clear jams 149
- browser requirements
 - HP Embedded Web Server 104

C

- cartridge
 - replacing 32, 35
- cartridge policy 26
- checklist
 - fax troubleshooting 179
 - wireless connectivity 175
- cleaning
 - document feeder glass 155
 - glass 163, 168
 - paper path 159
- control panel
 - help 130
 - LED 4
 - LED light patterns 127
 - locating 2
- copying
 - edges of documents 166
 - multiple copies 62
 - optimizing for text or pictures 165

- quality, adjusting 65
 - setting paper size and type 163
 - single copies 62
 - two-sided documents 64
- customer support
 - online 126

D

- defaults, restoring 131
- dimensions, printer 14
- document feeder 64
 - copying two-sided documents 64
 - faxing from 98
 - locating 2
 - paper-feeding problems 138
- double-sided copying 64
- double-sided printing
 - Mac 50
 - Windows 47
- drivers, supported 12
- duplex 64
- duplex printing
 - Mac 50
- duplex printing (double-sided)
 - Windows 47
- duplexing
 - manually (Mac) 50
 - manually (Windows) 47

E

- EconoMode setting 117, 161
- economy settings 117
- electrical specifications 15
- electronic faxes
 - sending 99
- Embedded Web Server
 - assigning passwords 115
 - features 104

- envelopes, loading 21
- Ethernet port
 - locating 3
- Explorer, versions supported
 - HP Embedded Web Server 104

F

- factory-set defaults, restoring 131
- fax
 - ports 3
 - sending from software 99
 - solve general problems 180
 - solve page-space issues 183
 - solve poor quality 182
 - solve slow speed 181
 - speed dials 98
- fax ports 3
 - locating 3
- fax troubleshooting
 - checklist 179
- faxing
 - from a computer (Windows) 99
 - from the document feeder 98
 - from the flatbed scanner 97

G

- genuine HP cartridges 26
- glass, cleaning 163, 168
- glass, cleaning document feeder 155

H

- help, control panel 130
- HP Customer Care 126
- HP Device Toolbox, using 104
- HP Easy Scan software (OS X) 69
- HP Embedded Web Server
 - features 104
- HP ePrint 57

- HP ePrint software 58
- HP EWS, using 104
- HP Scan software (Windows) 68
- HP Utility 108
- HP Utility for Mac
 - Bonjour 108
 - features 108
- HP Utility, Mac 108
- HP Web Services
 - applications 102
 - enabling 102

I

- image quality
 - check toner-cartridge status 157
- imaging drum
 - components 38
 - replacing 38, 41
- input tray
 - loading 18
 - loading envelopes 21
 - locating 2
- interface ports
 - locating 3
- Internet Explorer, versions supported
 - HP Embedded Web Server 104

J

- jams
 - locations 141
 - output bin 149

L

- LED control panel
 - controls 4
- lock
 - formatter 116
- lock slot
 - locating 3

M

- Macintosh
 - HP Utility 108
- maintenance kits
 - part numbers 24
- manual duplex
 - Mac 50
 - Windows 47
- memory
 - included 11

- memory chip (toner)
 - locating 32
- Microsoft Word, faxing from 99
- mobile printing
 - Android devices 59
- mobile printing solutions 11
- mobile printing, software
 - supported 13
- multiple pages per sheet
 - printing (Mac) 50
 - printing (Windows) 47

N

- Netscape Navigator, versions supported
 - HP Embedded Web Server 104
- network installation 103
- network link speed setting,
 - changing 113
- network port
 - locating 3
- networks
 - installing the printer 103
 - supported 11
- number of copies, changing 62

O

- on/off button, locating 2
- online help, control panel 130
- online support 126
- operating systems (OS)
 - supported 11
- operating systems, supported 12
- ordering
 - supplies and accessories 24
- OS (operating system)
 - supported 11
- output bin
 - clear jams 149
 - locating 2

P

- pages per minute 11
- pages per sheet
 - selecting (Mac) 50
 - selecting (Windows) 47
- paper
 - selecting 160
- paper jams
 - locations 141
 - output bin 149

- paper pickup problems
 - solving 136, 137
- paper type
 - selecting (Windows) 48
- paper types
 - selecting (Mac) 51
- paper, ordering 24
- part numbers
 - accessories 24
 - replacement parts 24
 - staple cartridges 24
 - supplies 24
 - toner cartridge 24
 - toner cartridges 24
- phone book, fax
 - adding entries 98
- ports
 - fax 3
 - locating 3
 - network 3
 - USB 3
- power
 - consumption 15
- power connection
 - locating 3
- power switch, locating 2
- print drivers, supported 12
- print on both sides
 - Mac 50
 - manually, Windows 47
 - Windows 47
- priority feed tray
 - loading envelopes 21

R

- replacement parts
 - part numbers 24
- replacing
 - imaging drum 38, 41
 - toner cartridge 32, 35
- restoring factory-set defaults 131

S

- scanner
 - document feeder glass cleaning 155
 - faxing from 97
 - glass cleaning 163, 168
 - locating 2

- scanning
 - from HP Easy Scan software (OS X) 69
 - from HP Scan software (Windows) 68
- sending faxes
 - from software 99
- settings
 - factory-set defaults, restoring 131
- shut down after delay
 - setting 119
- sleep delay
 - setting 118
- software
 - HP Utility 108
 - sending faxes 99
- solve problems
 - fax 180
- specifications
 - electrical and acoustic 15
- speed dials
 - programming 98
- staple cartridges
 - part numbers 24
- status
 - control panel lights 127
 - HP Utility, Mac 108
- supplies
 - low threshold settings 133
 - ordering 24
 - part numbers 24
 - replacing imaging drum 38, 41
 - replacing toner cartridge 32, 35
 - status, viewing with HP Utility for Mac 108
 - using when low 133
- support
 - online 126
- system requirements
 - HP Embedded Web Server 104

T

- technical support
 - online 126
- toner cartridge
 - components 32, 35
 - low threshold settings 133
 - part numbers 24
 - replacing 32, 35
 - using when low 133
- toner cartridges
 - part numbers 24
- trays
 - capacity 11
 - included 11
- troubleshooting
 - check toner-cartridge status 157
 - faxes 179
 - LED, errors 127
 - LED, light patterns 127
 - network problems 173
 - paper feed problems 136
 - wired network 173
 - wireless network 175
- two-sided copying 64

U

- USB port
 - locating 3

W

- web browser requirements
 - HP Embedded Web Server 104
- Web Services
 - applications 102
 - enabling 102
- Web sites
 - customer support 126
- weight, printer 14
- Wi-Fi Direct printing 13, 53
- Windows
 - faxing from 99
- wireless network
 - troubleshooting 175
- wireless network interference 178
- Word, faxing from 99

