



EC-CERTIFICATE

(Full quality assurance system)



This is to certify that the company

FEHLING INSTRUMENTS GmbH & Co. KG

Hanauer Landstraße 7A
63791 Karlstein
Germany

has implemented and maintains a full quality assurance system which applies to the products at every stage from design to final controls.

Through an audit, documented in a report, performed by DQS Medizinprodukte GmbH, it was verified that the management system fulfills the requirements of

Annex II – excluding Section 4 of Council Directive 93/42/EEC concerning medical devices

with respect to the following medical devices:

Sterile and non-sterile, non-active cervical spine implants, sterile and non-sterile, non-active surgical instruments according to annex.

The manufacturer is subject to surveillance according to Annex II, Section 5. The CE marking with the Notified Body Identification Number (0297) may be affixed on the devices listed in the certificate. An EC Design Examination Certificate according to Annex II, Section 4 is required for class III devices covered by this certificate. The certificate is in the case of class I(s) devices (I(s) = class I products placed on the market in sterile conditions) limited to the aspects of manufacture concerned with securing and maintaining sterile conditions. The certificate is in the case of class I(m) devices (I(m) = class I devices with a measuring function) limited to the aspects of manufacture concerned with the conformity of the products with the metrological requirements.

Certificate registration no.	099980 MR2
Certificate unique ID	170734114
Effective date	2019-03-29
Expiry date	2021-07-24
Frankfurt am Main	2019-03-29

DQS Medizinprodukte GmbH

Sigrid Uhlemann
Managing Director

Dr. Thomas Feldmann
Head of Certification Body

August-Schanz-Straße 21, 60433 Frankfurt am Main,
Tel. +49 (0) 69 95427-300, medical.devices@dqs-med.de

DQS Medizinprodukte GmbH is a Notified Body according to Council Directive 93/42/EEC concerning medical devices with the Identification Number 0297.



Annex to certificate
Certificate registration No.: 099980 MR2
Certificate unique ID: 170734114
Effective date: 2019-03-29

FEHLING INSTRUMENTS GmbH & Co. KG

Hanauer Landstraße 7A
63791 Karlstein
Germany

Device family	Device	Class
Cervical spine implants	FENESTRA – Cervicale Cages, unsterile FENESTRA – Cervicale Cages, sterile FORMAR – Cervicale Cages, unsterile FORMAR – Cervicale Cages, sterile	IIb
Single use sterile instruments	Single use biopsy forceps in different lengths and widths. Single use osteobioptomes in different widths VERTECT – Jack device MANNHEIM – Galea-hook	IIa
Instruments	CALAFIORE sternal retractor Retractors/Retainers/Spreaders (fixed/self-retaining)	IIa IIa



CERTIFICATE



This is to certify that the company

FEHLING INSTRUMENTS GmbH & Co. KG

Hanauer Landstraße 7A
63791 Karlstein
Germany

with the organizational units/sites as listed in the annex

has implemented and maintains a **Quality Management System**.

Scope:

Design, manufacturing and distribution of sterile and non-sterile, non-active surgical instruments and sterile and non-sterile, non-active orthopaedic implants.

Through an audit, documented in a report, performed by DQS Medizinprodukte GmbH, it was verified that the management system fulfills the requirements of the following standard:

EN ISO 13485 : 2016

Certificate registration no.	099980 MP2016
Certificate unique ID	170707852
Effective date	2018-06-19
Expiry date	2021-06-18
Frankfurt am Main	2018-06-19



DQS Medizinprodukte GmbH

Sigrid Uhlemann
Managing Director

Dr. Thomas Feldmann
Head of Certification Body



Annex to certificate
Certificate registration No.: 099980 MP2016
Certificate unique ID: 170707852
Effective date: 2018-06-19

FEHLING INSTRUMENTS GmbH & Co. KG

Hanauer Landstraße 7A
63791 Karlstein
Germany

Location

Scope

FEHLING INSTRUMENTS GmbH & Co. KG
Hanauer Landstraße 7A
63791 Karlstein
Germany

Design and manufacturing of sterile and non-sterile, non-active surgical instruments and sterile and non-sterile, non-active orthopaedic implants.

FEHLING INSTRUMENTS GmbH & Co. KG
Uhlandstraße 2
63791 Karlstein
Germany

Distribution of sterile and non-sterile, non-active surgical instruments and sterile and non-sterile, non-active orthopaedic implants.

**MVR RETRACTOR ACCESSORIES
MKR SPREIZER ZUBEHÖR**



**BLADE GUIDE (Ø4)
HAKENFÜHRUNG (Ø4)
220 mm**

MRN-3

**RETRACTION OF THE AORTIC ROOF
RETRAKTION DES VORHOFDACHS**

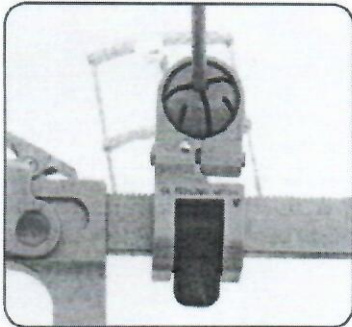

*exemplary configuration
Konfigurationsbeispiel*



**BALL ADAPTER (Ø4)
KUGELADAPTER (Ø4)**

MRO-0V*

* with wing screw: MRO-0
* mit Flügelschraube: MRO-0

Inside screw prevents jammed sutures and is space saving; cardan screwdriver LMT-4 required for tightening.

Innenliegende Schraube verhindert Einklemmen von Fäden und spart Platz; Kardan Schraubendreher LMT-4 zum Anziehen erforderlich.

For adapters with wing screw no screwdriver required.

Für Adapter mit Flügelschraube kein Schraubendreher erforderlich.

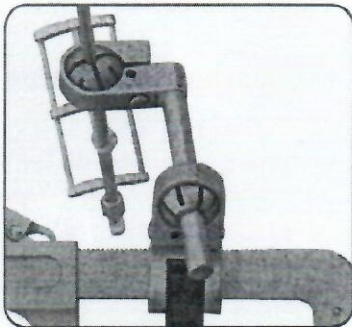

*exemplary configuration
Konfigurationsbeispiel*



**BALL ADAPTER (Ø8) FOR MRR-2V/L
KUGELADAPTER (Ø8) FÜR MRR-2V/L**

MRR-1V*

* with wing screw: MRR-1
* mit Flügelschraube: MRR-1

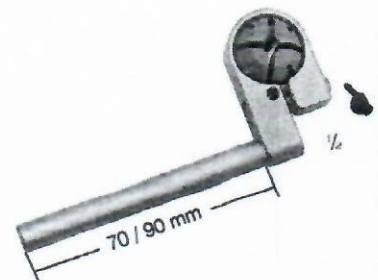

**BALL ADAPTER (Ø4)
WITH DISTANCE ELEVATOR
KUGELADAPTER (Ø4)
MIT DISTANZHEBEL**

70 mm	90 mm
MRR-2V*	MRR-2L

* with wing screw: MRR-2
* mit Flügelschraube: MRR-2

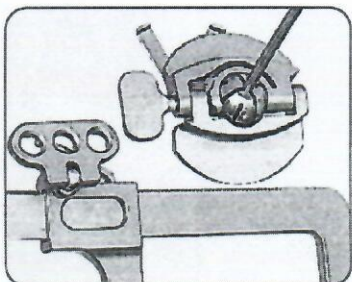

*exemplary configuration
Konfigurationsbeispiel*



**FIXATION DEVICE FOR MRN-3 (Ø4)
(FOR EXTERNAL STAB INCISION)
FIXIERVORRICHTUNG FÜR MRN-3 (Ø4)
(FÜR SEPARATE STICHINZISION)**

MRO-9*

*with inside screw MRO-9V
*mit innenliegender Schraube MRO-9V

MICS

RETRACTION OF THE AORTIC ROOF
RETRAKTION DES VORHOFDACHS

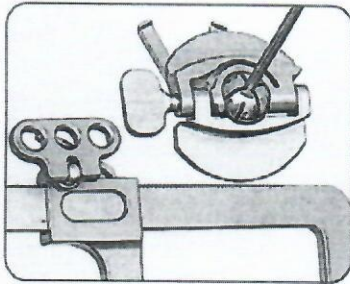

exemplary configuration
Konfigurationsbeispiel



FIXATION DEVICE FOR MRN-3
(FOR EXTERNAL STAB INCISION)
FIXIERVORRICHTUNG FÜR MRN-3
(FÜR SEPARATE STICHINZISION)

MRO-9



ATRIAL BLADE
VORHOFBLATT

BLADE SIZE BLATTGRÖSSE a x b	
30 x 8 mm	MRN-4
40 x 8 mm	MRN-5
50 x 8 mm	MRN-6



ATRIAL HOOK
VORHOFGABEL

DEPTH TIEFE a	
30 mm	MRO-2
40 mm	MRO-3
50 mm	MRO-4
60 mm	MRO-5
70 mm	MRO-6

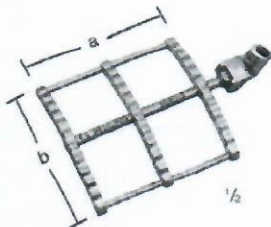

DEPTH x WIDTH TIEFE x BREITE a x b	
45 x 30 mm	MRU-1
60 x 30 mm	MRU-2
45 x 45 mm	MRU-3
60 x 45 mm	MRU-4

**MVR RETRACTOR ACCESSORIES
MKR SPREIZER ZUBEHÖR**

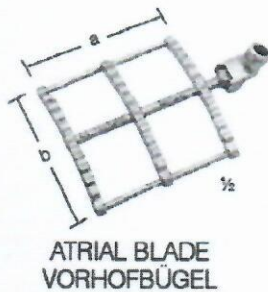

a x b	
30 x 30 mm	MRX-2
30 x 45 mm	MRX-3
45 x 30 mm	MRU-1
60 x 30 mm	MRU-2
45 x 45 mm	MRU-3
60 x 45 mm	MRU-4



a x b	
35 x 25 mm	MSN-2
55 x 30 mm	MSN-3

*cardan screw driver LMT-4 required
Kardanschraubendreher LMT-4 erforderlich

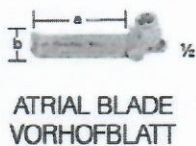

a x b	
30 x 8 mm	MRN-4
40 x 8 mm	MRN-5
50 x 8 mm	MRN-6



- a -	
30 mm	MRO-2
40 mm	MRO-3
50 mm	MRO-4
60 mm	MRO-5
70 mm	MRO-6

**GUIDING CLAMPS FOR THE INSERTION OF ATRIAL BLADES / SEPTUM HOLDERS
FÜHRUNGSZANGEN ZUM EINSpanNEN VON VORHOFBLÄTTERN / SEPTUMNIEDERHALTERN**



GUIDING FORCEPS
FÜHRUNGSZANGE
260 mm
MRN-7

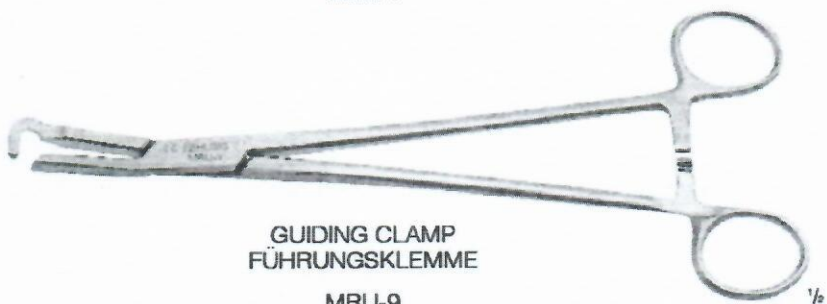

GUIDING CLAMP
FÜHRUNGSKLEMME
MRU-9

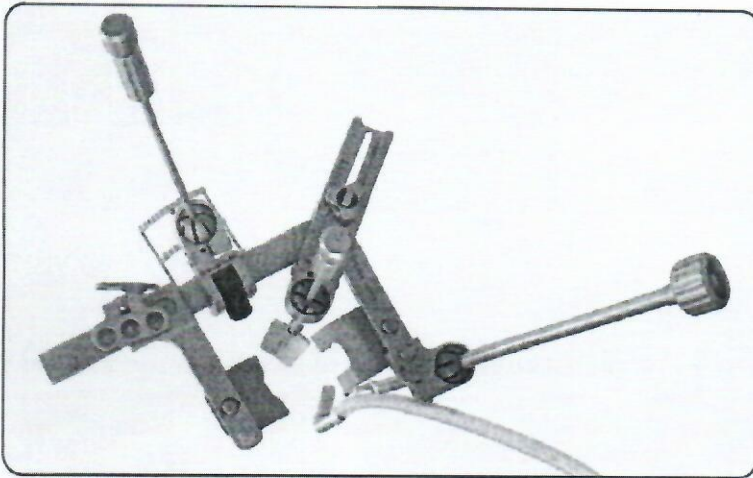

exemplary configuration
Konfigurationsbeispiel

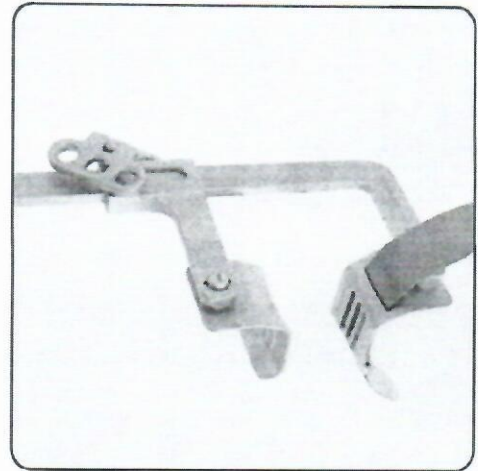

exemplary configuration
Konfigurationsbeispiel

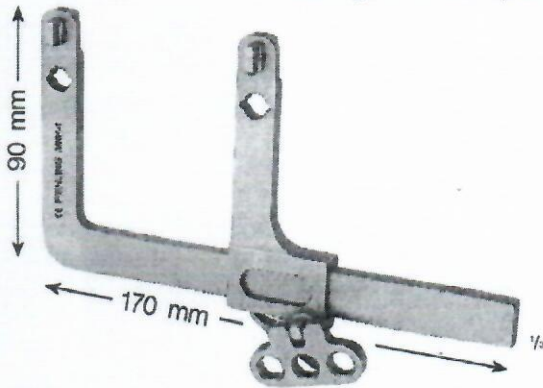

INTERCOSTAL RETRACTOR
INTERCOSTALSPREIZER

MRP-1

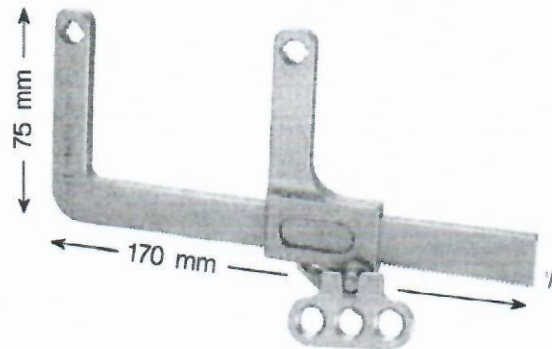

INTERCOSTAL RETRACTOR SHORT ARM
INTERCOSTALSPREIZER KURZARM

MRP-1F

RETRACTING BLADES (PAIR)
HALTEBLÄTTER (PAAR)

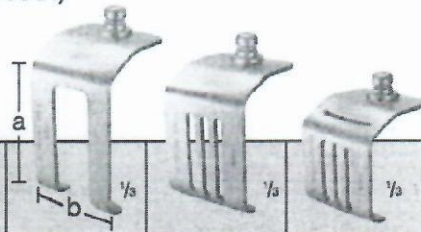

BLADE SIZE BLATTGRÖSSE a x b			
40 x 35 mm	MRP-2	MRP-2V	MRP-2F
50 x 35 mm	MRP-3	MRP-3V	MRP-3F
60 x 35 mm	MRP-4	MRP-4V	MRP-4F
70 x 35 mm	MRO-7	MRO-7V	
80 x 35 mm		MRQ-7	
90 x 35 mm		MRQ-8	
100 x 35 mm		MRQ-9	



CERAMO® SUPERPLAST
SPATULA
SPATEL
24 x 250 mm
EOJ-7



YANKAUER SUCTION TUBE
YANKAUER SAUGROHR
285 mm
HAA-4

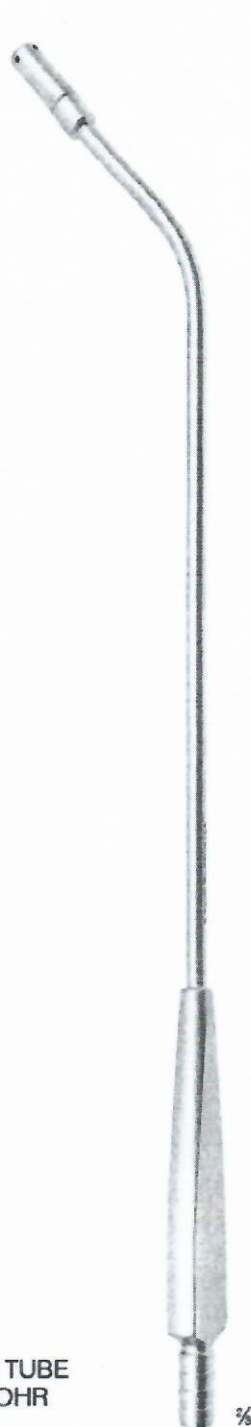

VALVULAR SUCTION TUBE
SAUGER FÜR KLAPPENCHIRURGIE



CERAMO®
SUCTION CANNULA FOR
VALVE DECALCIFICATION
ENTKALKUNGSSAUGER
240 mm
MNF-5



HLM-ASPIRATOR
HLM-SAUGER
280 mm
MEL-7

300 mm	350 mm*
MNO-0	MNO-8

* particularly for MICS MVR
speziell für MICS MKR/MKE

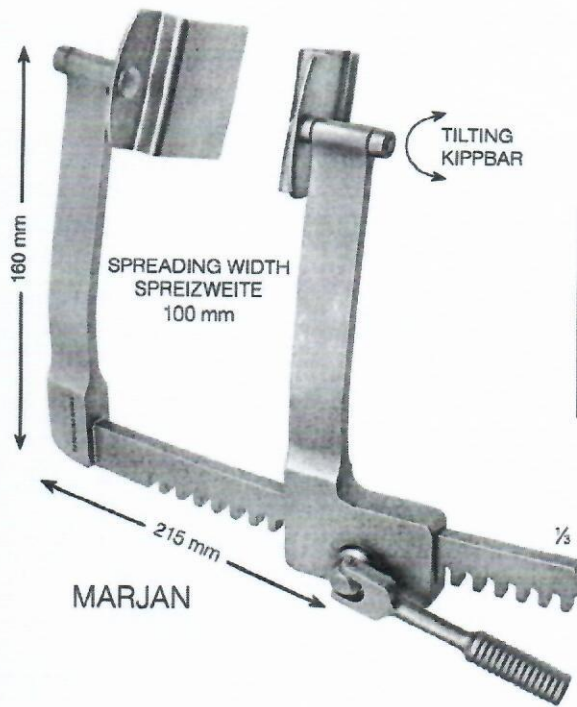

FOR PARTIAL STERNOTOMY
FÜR PARTIELLE STERNOTOMIE

BLADE SIZE BLATTGRÖSSE a x b	
35 x 50 mm	MRM-5
45 x 50 mm	MRM-6



**SUPERFLEX
SOFT TISSUE RETRACTOR
WEICHGEBEBERETRAKTOR**
200 x 25 mm

MTI-0

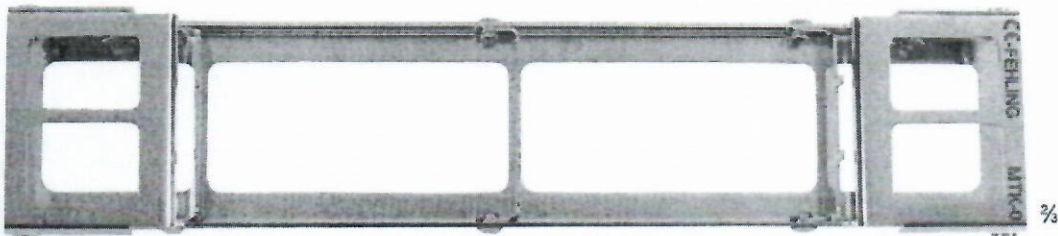

**STERILISATION AND STORAGE TRAY FOR MTI-0
STERILISIER- UND LAGERSIEB FÜR MTI-0**
220 x 51,2 x 19,5 mm

MTK-0

CERAMO® HCR





5 x 30 mm

NON-TRAUMATIC GRASPING FORCEPS ATRAUMATISCHE ORGANFASSZANGE
--

370 mm

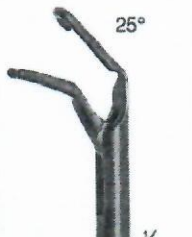
MRL-8 MRL-8L ¹⁾

25°

KNOT PUSHER KNOTENSCHIEBER

280 mm	340 mm
--------	--------

MRQ-2	MRB-6 MRB-6B ¹⁾
-------	-------------------------------

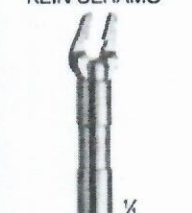
NO CERAMO® KEIN CERAMO®

CLIP APPLIER® CLIPANLEGEZANGE

370 mm	370 mm
--------	--------

SMALL	MEDIUM
-------	--------

MRG-3T	MRG-4T
--------	--------



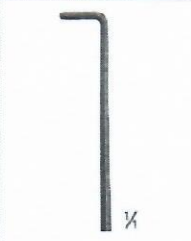

1 x 7 mm

NERV HOOK NERVHAKEN

280 mm	340 mm
--------	--------

MRQ-1	MRB-4
-------	-------

10 mm

VALVE INSPECTOR KLAPPENPRÜFINSTR.

350 mm

MRL-2

350 mm

SCALPEL HANDLE® SKALPELLGRIFF

350 mm

MRL-4

PEEK
340 mm

KNOT PUSHER KNOTENSCHIEBER

340 mm

MRK-9P

350 mm

MAGNETIC FINDER MAGNETSTAB

350 mm

MRL-5



360 mm

MIRROR SPIEGEL

360 mm

MRQ-6

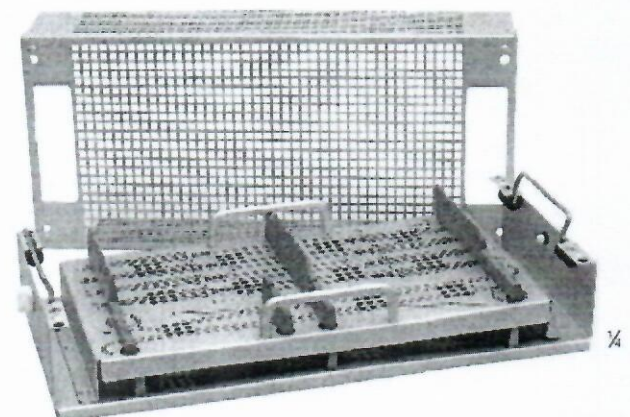
3) FOR BEAVER BLADES
FÜR BEAVER MESSER



TRAY FOR HCR INSTRUMENTS
CONTAINER FÜR HCR-INSTRUMENTE
550 x 250 x 100 mm

MRC-9

1) WITH LOCK
MIT SPERRE
2) FOR / FÜR
ETHICON + HORIZON CLIPS

NON-TRAUMATIC FORCEPS
ATRAUMATISCHE KLEMMEN

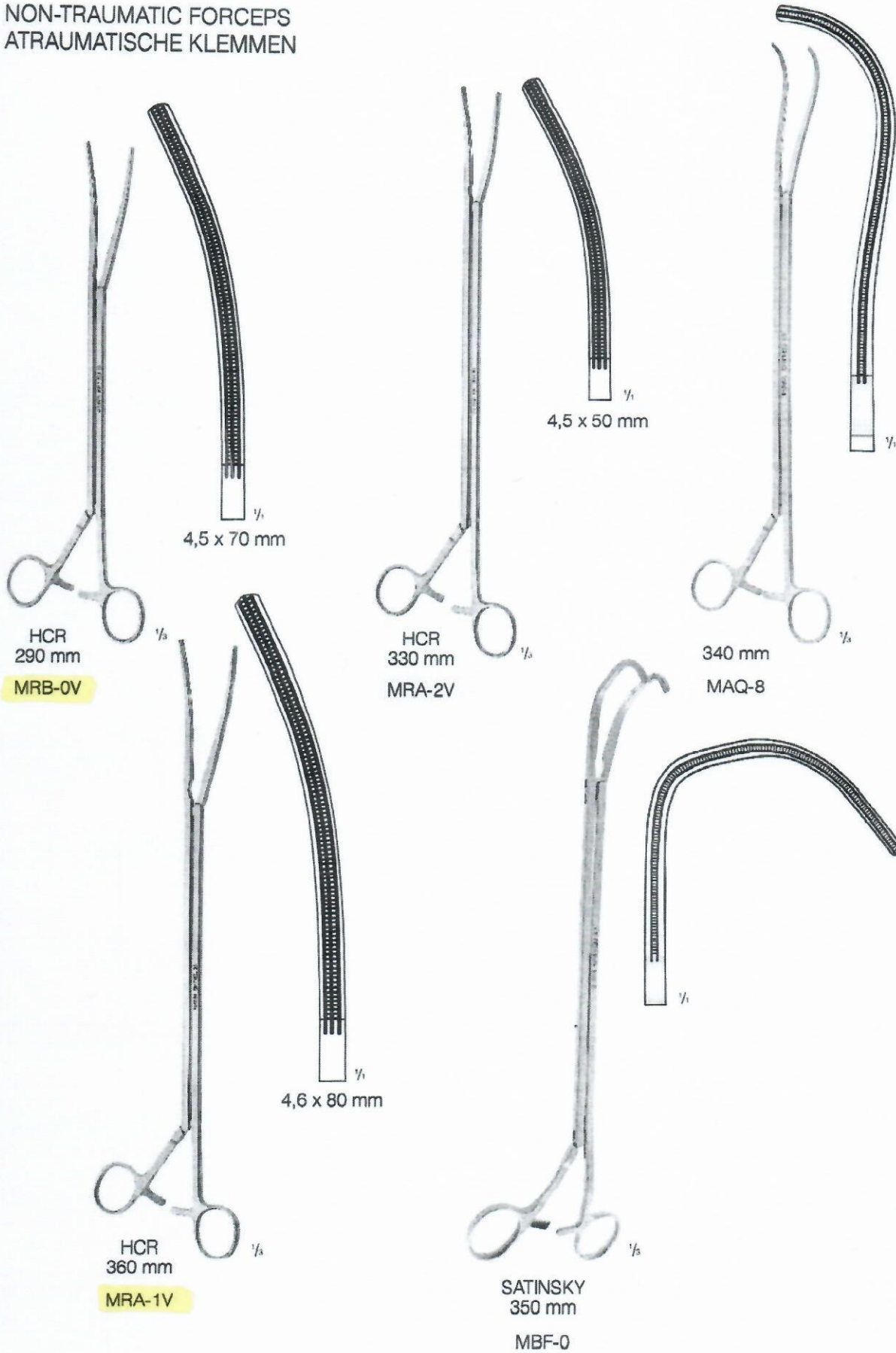

**CONCEPT MICS ENDOSCOPE HOLDING SYSTEM
MICS ENDOSKOPHALTESYSTEM**

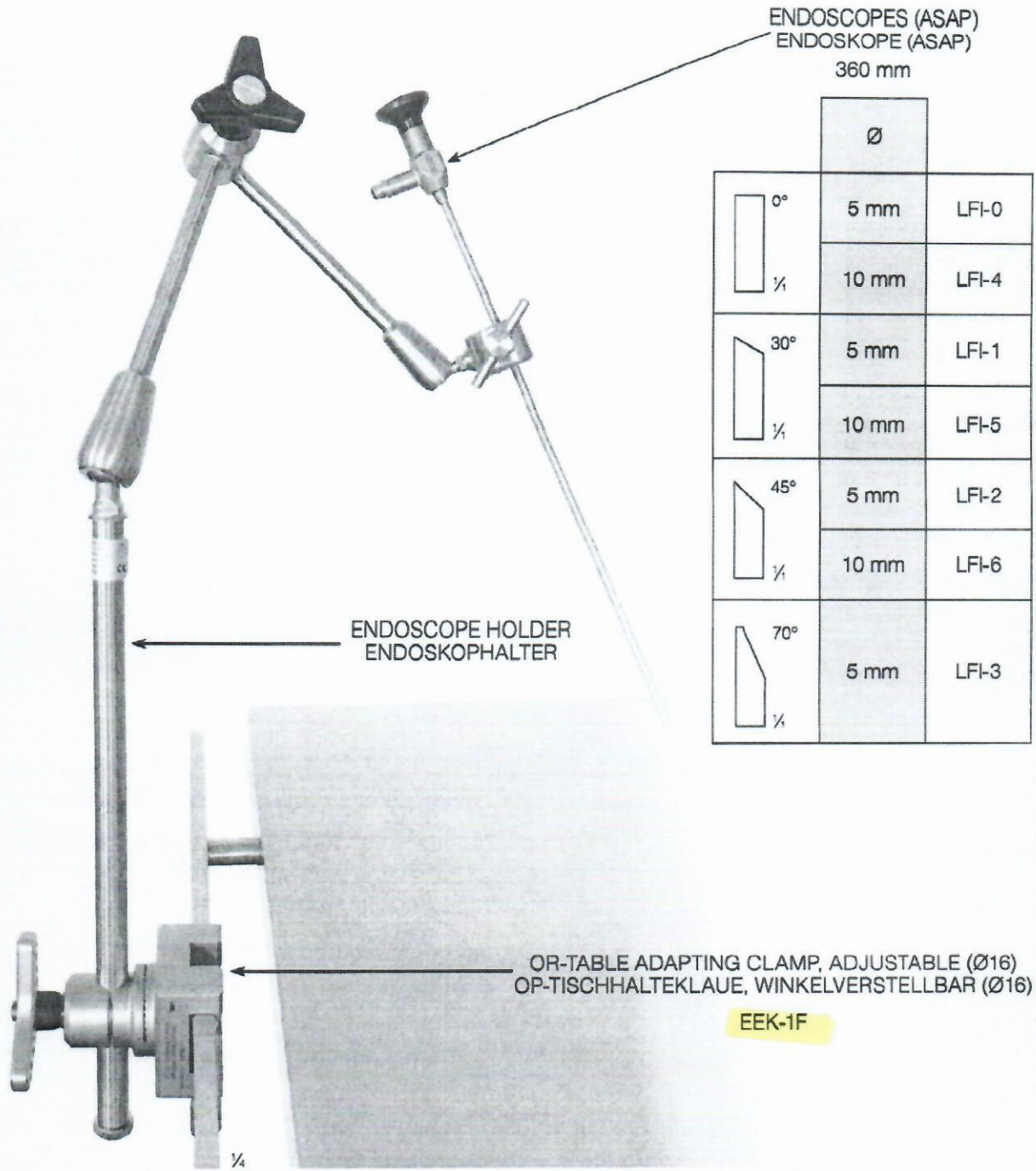

ENDOSCOPES (ASAP)
ENDOSKOPE (ASAP)
360 mm

		Ø	
	0°	5 mm	LFI-0
	1/4"	10 mm	LFI-4
	30°	5 mm	LFI-1
	1/4"	10 mm	LFI-5
	45°	5 mm	LFI-2
	1/4"	10 mm	LFI-6
	70°	5 mm	LFI-3

ENDOSCOPE HOLDER
ENDOSKOPHALTER

OR-TABLE ADAPTING CLAMP, ADJUSTABLE (Ø16)
OP-TISCHHALTEKLAUE, WINKELVERSTELLBAR (Ø16)

EEK-1F







INSTRUMENT ATTACHMENT
INSTRUMENTEN-HALTERUNG
WITHOUT SOCKET/OHNE SOCKEL
843 mm

EEP-7

appropriate for instruments with round profile
geeignet für Instrumente mit rundem Profil
(Ø 4 - 18 mm)





CERAMO® HCR

FORCEPS / PINZETTEN

 1 x 10 mm	 3 x 15 mm	 1,5 x 11 mm	 1,5 x 11 mm 45°	 2,8 x 15 mm	 2,8 x 15 mm 45°	 350 mm		
SUTURE NAHT	VALVE KLAPPE	NON-TRAUMATIC ATRAUMATISCH					RUSSIAN RUSSISCH	
345 mm	350 mm	280 mm	350 mm	350 mm	280 mm	350 mm	350 mm	
MRA-5	MRA-0 MRQ-3 ¹⁾	MSO-6	MRG-6	MRG-7	MRN-0 MRN-OB ¹⁾	MRA-3 MRA-3B ¹⁾	MRA-4	MRQ-5













1) WITH LOCK
MIT SPERRE

NEEDLE HOLDERS / NADELHALTER (WITH LOCK / MIT SPERRE)

 2 x 10 mm max. 5x0	 3 x 10 mm max. 3x0	 3 x 10 mm max. 2x0	 3 x 10 mm max. 2x0	 1,5 mm max. 5x0			
TCM		TC		TC RYDER			
340 mm	280 mm	340 mm	280 mm	340 mm	280 mm	350 mm	350 mm
MRB-2	MRG-6	MRB-1	MRT-6	MRG-9	MSO-5	MRG-2	MSO-1

max. needle size
max. Nadelgröße

SCISSORS / SCHEREN

								
VALVE KLAPPE								
350 mm	350 mm	350 mm	280 mm	350 mm	450 mm	350 mm		
MRA-7	MRT-2	MRT-3	MSO-3	MRD-7	MRD-7L	MSO-4	MRT-5	MSO-8
 45°	 45°	 90°						
BLUNT/STUMPF			DISSECTING PRÄPARATION					
VASCULAR GEFÄSS								
345 mm	345 mm	335 mm	280 mm	350 mm				
MRA-8B	MRA-8	MRA-9	MRQ-0	MRA-6				

SHAFT DIAMETER = 5.0 mm
SCHAFTDURCHMESSER = 5,0 mm



CERAMO®

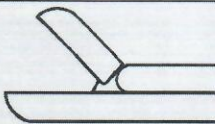
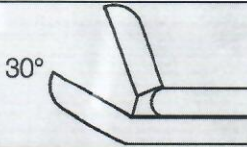

JAW WIDTH MAULBREITE mm	LENGTH LÄNGE mm				
		FERRIS-SMITH	FERRIS-SMITH X	FERRIS-SMITH	FERRIS-SMITH X
2,0	180	TOC-0	TOC-0X	TOF-0	TOF-0X
	200	TOG-0	TOG-0X	TOH-0	TOH-0X
	250	TOI-0	TOI-0X	TOJ-0	TOJ-0X
	300	TOK-0	TOK-0X	TON-0	TON-0X
2,5	200	TOG-7	TOG-7X	-	-
3,0	180	TOC-1	TOC-1X	TOF-1	TOF-1X
	200	TOG-1	TOG-1X	TOH-1	TOH-1X
	250	TOI-1	TOI-1X	TOJ-1	TOJ-1X
	300	TOK-1	TOK-1X	TON-1	TON-1X
	400	TOO-3	TOO-3X	TOO-8	TOO-8X
3,5	200	TOG-8	TOG-8X	-	-
4,0	180	TOC-2	TOC-2X	TOF-2	TOF-2X
	200	TOG-2	TOG-2X	TOH-2	TOH-2X
	250	TOI-2	TOI-2X	TOJ-2	TOJ-2X
	300	TOK-2	TOK-2X	TON-2	TON-2X
	400	TOO-4	TOO-4X	TOO-9	TOO-9X
5,0	180	TOC-3	TOC-3X	TOF-3	TOF-3X
	200	TOG-3	TOG-3X	TOH-3	TOH-3X
	250	TOI-3	TOI-3X	TOJ-3	TOJ-3X
	300	TOK-3	TOK-3X	TON-3	TON-3X
	400	TOO-5	TOO-5X	-	-
6,0	180	TOC-4	TOC-4X	TOF-4	TOF-4X
	200	TOG-4	TOG-4X	TOH-4	TOH-4X
	250	TOI-4	TOI-4X	TOJ-4	TOJ-4X
	300	TOK-4	TOK-4X	TON-4	TON-4X
7,0	180	TOC-5	TOC-5X	TOF-5	TOF-5X
	200	TOG-5	TOG-5X	TOH-5	TOH-5X
	250	TOI-5	TOI-5X	TOJ-5	TOJ-5X
	300	TOK-5	TOK-5X	TON-5	TON-5X
8,0	180	TOC-6	TOC-6X	TOF-6	TOF-6X
	200	TOG-6	TOG-6X	TOH-6	TOH-6X
	250	TOI-6	TOI-6X	TOJ-6	TOJ-6X
	300	TOK-6	TOK-6X	TON-6	TON-6X

**Către IMSP Spitalul Clinic Republican
„Timofei Moşneaga”**

În atenția Grupului de lucru
al procedurii COP nr.ocds-b3wdp1-MD-1572265588218;
ID: 21013777 din 12.11.2019

Declarație privind disponibilitatea prezentării mostrelor

Prin prezenta, declarăm că vom prezenta mostre în decurs de 5 zile de la solicitarea autorității contractante pentru produsele oferite: ***Instrumente cardiochirurgicale pentru operații minim invazive*** conform documentației de atribuire a procedurii COP nr.ocds-b3wdp1-MD-1572265588218 din 12.11.2019.

Cu respect,
Director

11.11.19



Vladimir Roibu

REPUBLICA



MOLDOVA

CERTIFICAT DE ÎNREGISTRARE

FIRMA "AST-MEDICAL" S.R.L.
ESTE ÎNREGISTRATĂ LA CAMERA ÎNREGISTRĂRII DE STAT

Numărul de indentificare de stat - codul fiscal
1003600132970

Data înregistrării

01.03.1999

Data eliberării

12.02.2005

Bobeica Ion, registrator de stat

Funcția, numele, prenumele persoanei
care a eliberat certificatul

[Signature]

semnătura



MD 0022782

L.Ș.



I.P. "AGENȚIA SERVICII PUBLICE"

Departamentul înregistrare și licențiere a unităților de drept

EXTRAS

din Registrul de stat al persoanelor juridice

nr. 1967 din 01.02.2019

Denumirea completă: **FIRMA «AST-MEDICAL» S.R.L. .**

Denumirea prescurtată: **«AST-MEDICAL» S.R.L. .**

Forma juridică de organizare: **Societate cu Răspundere Limitată.**

Numărul de identificare de stat și codul fiscal: **1003600132970.**

Data înregistrării de stat: **01.03.1999.**

Sediul: **MD-2044, str. Alecu Russo, 59/4, ap.(of.) 86, mun.Chișinău, Republica Moldova.**

Obiectul principal de activitate:

- 1 Comerțul cu ridicata al produselor farmaceutice;**
- 2 Comerțul cu amănuntul al produselor farmaceutice;**
- 3 Practica medicală;**
- 4 Importul și (sau) depozitarea, comercializarea produselor de uz fitosanitar și (sau) a fertilizanților;**
- 5 Activitatea farmaceutică veterinară și (sau) asistența veterinară (cu excepția activității desfășurate de serviciul veterinar de stat);**
- 6 Comerț cu ridicata al mașinilor agricole, echipamentelor și furniturilor;**
- 7 Comerț cu ridicata al altor mașini și echipamente;**
- 8 Importul și (sau) fabricarea, depozitarea, comercializarea angro a substanțelor și materialelor chimice, toxice, articolelor și produselor chimice de menaj.**

Capitalul social: **5400 lei.**

Administrator: ROIBU VLADIMIR,

Asociați:

- 1. ROIBU VLADIMIR 100 %.**

Prezentul extras este eliberat în temeiul art. 34 al Legii nr. 220-XVI din 19 octombrie 2007 privind înregistrarea de stat a persoanelor juridice și a întreprinzătorilor individuali și confirmă datele din Registrul de stat la data de: 01.02.2019.

Specialist coordonator
tel. 022-20-7838



Clichici Elena



EB 0257483



EXIMBANK
GRUPPO VENETO BANCA



12 APR. 2013

CERTIFICAT

Prin prezentul se confirmă faptul deţinerii de către "AST-MEDICAL" SRL, IDNO1003600132970, a următoarelor conturi curente deschise la B.C. "EXIMBANK - Gruppo Veneto Banca" S.A. Sucursala Nr 19, codul băncii EXMMMD22476:

- IBAN: MD92EX0000000222400758MD in MDL
- IBAN: MD81EX1900000225150721US in Dolari SUA
- IBAN MD31EX1900002251400758EU in EUR

Certificatul este eliberat pentru a fi prezentat la cerere.

Turcanu Nicolae
Director Sucursala nr. 19



Ex. Costin C.
Tel. 022 27 02 94