

Copyright

Shenzhen Comen Medical Instruments Co., Ltd.

Version: B00

Product Name: Defibrillator Monitor

Product Model: S5/S3

No.:046-00000012-01

Statement

All rights reserved by Shenzhen Comen Medical Instruments Co., Ltd.

This instruction manual contains confidential information. It is only intended for users as a reference for operation, maintenance and repair of Comen products. No one shall disclose the contents hereof to any other person.

No part of this manual may be reproduced, transmitted, transcribed or stored in a retrieval system in any form or by any means, electronic or mechanical, including photocopying and recording, or translated into any other language, without written permission of Comen.

Comen shall assume no liability for any errors contained herein or any incidental or indirect damages arising from provision, actual performance or use of this manual. This User Manual does not imply the transfer of any proprietary right under patent law to any third party. Comen shall not be liable for any legal consequences arising out of breach of the patent law or infringement of any third-party rights.

The contents in this manual are subject to change without prior notice.

Warranty

Comen will be responsible for the safety, reliability and performance of the product within the limited warranty period: if all of the following conditions are satisfied:

- The product is used in accordance with this *Manual*.
- The product is installed, maintained or upgraded by persons accepted or authorized by Comen.
- The storage, operating and electrical environments for the product comply with the product specifications.
- The serial number label or manufacturing mark of the product is clearly legible.
- The damage is not caused by human factors.

The product will be repaired or replaced free of charge within the limited warranty period. After the limited warranty period, Comen will charge for the service and replacement parts. If the products need to be returned to Comen for maintenance, the freight charges (including the customs duty) should be on the customer's account.

Return

If the products need to be returned to Comen, please contact the After-sales Service Department of Comen to get the right to return the goods. You must provide the serial number of the product, which can be found on

the product's nameplate. If the serial number is illegible, your return request will be rejected. Please also present the production date and briefly describe the reason for return.

After-sales Service Unit

Name: After-sales Service Department of Shenzhen Comen Medical Instruments Co., Ltd

Address: Floor 10 of Building 1A, FIYTA Timepiece Building, Nanhuan Avenue, Matian Sub-district, Guangming District, Shenzhen, Guangdong, 518106, P.R. China

Tel.: 0086-755-26431236, 0086-755-86545386, 0086-755-26074134

Fax: 0086-755-26431232

Customer Service Hotline: 4007009488

Preface

This manual provides details on the performance, operations and safety instructions of User Manual for S5/S3 defibrillator monitor (hereinafter referred to as the “monitor”). It is the best starting point for new users of the monitor.

Intended Readers

This user manual is only intended to trained professionals who are expected to have working knowledge of medical procedures, practices and terminology as required for monitoring patients.

Illustrations

All illustrations provided herein are for reference only. The menus, options, values and functions shown in the illustrations may be not exactly identical to what you see on the monitor.

Basic Performance

What is claimed to be determined as basic performance is:

- 1 Defibrillation energy release accuracy of defibrillation monitor;
- 2 Pacing frequency accuracy;
- 3 Pacing current accuracy;
- 4 HR detection accuracy;
- 5 RESP measurement accuracy;
- 6 NIBP measurement accuracy;
- 7 SpO₂ measurement accuracy;
- 8 PR measurement accuracy.
- 9 CO₂ measurement accuracy;

Conventions:

- —>: Indicates operating steps.
- [Character]: Indicates user interface text.

Bold italic: Used to indicate the quoted chapter

Blank Page

Contents

Chapter 1 Safety	1-1
1.1 Safety Information	1-1
1.2 Symbols	1-4
Chapter 2 Overview	2-1
2.1 Intended Use	2-1
2.2 Components	2-1
2.3 Monitor Views	2-2
2.3.1 Front View	2-2
2.3.1.1 Area 1	2-2
2.3.1.2 Area 2	2-3
2.3.1.3 Area 3	2-4
2.3.2 Right View	2-5
2.3.3 Left View	2-6
2.3.4 Rear View	2-6
2.3.5 External Defibrillation Electrode Paddle	2-8
2.4 OSD (On-screen Display)	2-8
2.5 Operating Mode	2-10
2.5.1 Manual Defibrillation Mode	2-11
2.5.2 Monitor Mode	2-11
2.5.3 Pacer Mode	2-11
2.5.4 AED Mode	2-11
Chapter 3 Installation	3-1
3.1 Unpacking and Checking	3-1
3.2 Connection of AC Power Cord	3-2
3.3 Start-up	3-2
3.4 Shutdown	3-3
3.5 Connecting the Sensor or Patient Cable	3-3
3.6 Install the monitor on the ambulance	3-3
Chapter 4 Patient Safety	4-1
4.1 Safety Instructions	4-1
4.2 Environmental Requirements	4-1
4.3 Protective Grounding	4-1
4.4 Equipotential Grounding	4-1
4.5 Condensation	4-2
Chapter 5 Basic Operations	5-1
5.1 Enter Main Menu	5-1
5.2 Enter User Maintain Menu	5-1
5.3 View Monitor Info	5-2

5.4 Enter Parameter Setup Window	5-2
5.5 General Setup	5-2
5.5.1 Time Setup	5-2
5.5.2 Language Setup	5-2
5.5.3 Measurement Unit Setup	5-2
5.5.4 Brightness Setup	5-3
5.5.5 Keys Backlight Setup	5-3
5.5.6 Screen Setup	5-3
5.5.7 Volume Setup	5-4
5.5.8 Waveform Freeze	5-4
5.5.9 Event Setup	5-5
5.5.10 Module Switch Setup	5-5
5.5.11 User Password Setting	5-5
5.5.12 High Contrast Display	5-6
5.6 Demo	5-6
Chapter 6 Patient Management	6-1
6.1 Admit	6-1
6.2 Quick Admit	6-2
6.3 Discharge	6-2
6.4 Document Manage	6-3
6.4.1 Save Tactics	6-4
Chapter 7 Configuration Management	7-1
7.1 Overview	7-1
7.2 Department	7-1
7.3 Manual Defibrillation Settings	7-2
7.4 AED Settings	7-2
7.5 Pacer Settings	7-3
7.6 Save as User Config	7-3
7.7 Delete Config	7-4
7.8 Load Config	7-4
7.9 Import Config from USB	7-4
7.10 Export Config to USB	7-4
7.11 Startup Configuration	7-4
7.12 Record Settings	7-4
7.13 Test Settings	7-5
7.14 Network Settings	7-5
Chapter 8 Monitor Screen	8-1
8.1 Standard	8-1
8.2 Set Screen Style in Monitoring Mode	8-1

8.2.1 Set Wave Sweep Speed	8-1
8.2.2 Set Wave Style	8-2
8.2.3 Set Module Color	8-2
8.2.4 Set Wave Draw.....	8-2
8.2.5 Set Wave Fill	8-2
8.2.6 Change Screen Layout.....	8-2
Chapter 9 Alarm	9-1
9.1 Alarm Type.....	9-1
9.2 Alarm Level.....	9-1
9.3 Alarm Mode	9-2
9.3.1 Alarm Lamp.....	9-2
9.3.2 Audible Alarm	9-3
9.3.3 Alarm Message.....	9-3
9.3.4 Alarm Parameter Flashing	9-3
9.4 Set Alarm Volume	9-4
9.4.1 Set Minimum Alarm Volume	9-4
9.4.2 Set Alarm Volume	9-4
9.4.3 Set Alarm Reminder	9-5
9.5 Set Parameter Alarm.....	9-5
9.5.1 Set Alarm Limit.....	9-5
9.5.2 Set Auto Alarm Limit	9-6
9.6 Set Alarm Delay	9-6
9.7 Set Alarm Recording	9-7
9.8 Alarm Pause	9-7
9.9 Alarm OFF	9-8
9.10 Alarm System Off.....	9-8
9.11 Alarm Reset.....	9-8
9.12 Alarm System Test	9-9
Chapter 10 PR Setup	10-1
10.1 Overview	10-1
10.2 PR Source	10-1
10.3 Alarm Limit Setup.....	10-1
Chapter 11 ECG Monitoring	11-1
11.1 Definition of ECG Monitoring	11-1
11.2 Precautions for ECG Monitoring.....	11-1
11.3 ECG Display.....	11-2
11.4 Monitoring Steps	11-3
11.4.1 Prepare Skin.....	11-3
11.4.2 Install ECG electrodes	11-4

11.4.2.1 Place 3-lead Electrodes.....	11-4
11.4.2.2 Place 5-lead Monitoring Electrodes.....	11-5
11.4.2.3 Recommended ECG Lead Connection for Surgical Patient	11-6
11.4.3 Placement of Pads or External Paddles	11-6
11.4.3.1 Operating Steps.....	11-6
11.4.3.2 Anterior-Lateral Placement.....	11-7
11.5 ECG Setup.....	11-7
11.5.1 Checking the Pacing Status	11-7
11.5.2 Set Lead Type.....	11-8
11.5.3 Smart Lead Off.....	11-8
11.5.4 Set Alarm Level for Lead Off.....	11-8
11.5.5 Set Lead Name for Monitoring.....	11-9
11.5.6 Set Wave Gain.....	11-9
11.5.7 Set Filter Mode.....	11-9
11.5.8 Set Computation Lead	11-10
11.5.9 Set Notch Filter.....	11-10
11.5.10 Set Pacer Rejection.....	11-11
11.5.11 HR Source	11-11
11.5.12 Multiple Lead Analysis	11-12
11.5.13 Cascade.....	11-12
11.6 ST Segment Analysis	11-12
11.6.1 About ST Segment Analysis.....	11-12
11.6.2 Influence Factors on ST Segment.....	11-12
11.6.3 ST Analysis On/Off.....	11-13
11.6.4 Adjust ST Point	11-13
11.6.5 ST Analysis Review	11-14
11.6.6 ST Alarm	11-15
11.7 Arrhythmia Analysis	11-15
11.7.1 Arrhythmia Analysis On/Off.....	11-15
11.7.2 Arrhythmia Alarm Setup	11-15
11.7.3 Arrhythmia Threshold Setup	11-16
11.7.4 Arrhythmia Review	11-16
11.7.5 ARR Relearn	11-17
11.8 ECG Relearn.....	11-17
Chapter 12 Manual Defibrillation and Synchronized Cardioversion	12-1
12.1 Overview	12-1
12.2 Safety Information.....	12-1
12.3 Manual Defibrillation Interface.....	12-2
12.4 Steps of Manual Defibrillation	12-3

12.4.1 Using Child External Paddles.....	12-4
12.5 Synchronized Cardioversion	12-4
12.5.1 Steps of Synchronized Cardioversion.....	12-5
12.5.2 Giving Another Shock.....	12-5
12.5.3 Exit Synchronized Cardioversion Mode.....	12-6
12.6 Remote Synchronized Cardioversion	12-6
12.7 Contact Impedance Indicator.....	12-7
Chapter 13 Noninvasive Pacing	13-1
13.1 Overview	13-1
13.2 Safety Information.....	13-1
13.3 Pacing Interface.....	13-2
13.4 Pacing Mode.....	13-2
13.5 Preparation for Noninvasive Pacing	13-3
13.5.1 Steps of Demand Pacing	13-3
13.5.2 Steps of Fixed Pacing	13-4
Chapter 14 AED.....	14-1
14.1 Overview	14-1
14.2 Safety Information.....	14-1
14.3 AED Interface.....	14-2
14.4 AED Procedure.....	14-2
14.5 Shock Advised.....	14-3
14.6 No Shock Advised.....	14-4
14.7 CPR	14-4
14.7.1 Using CPR Metronome	14-5
14.8 AED Audio Recording	14-5
Chapter 15 Resp Monitoring	15-1
15.1 Resp Measurement	15-1
15.2 Resp Display.....	15-1
15.3 Placement of Electrodes	15-1
15.3.1 Optimization of Lead Position.....	15-1
15.4 Resp Calculation Mode	15-2
15.5 Resp Setup.....	15-3
15.5.1 Gain	15-3
15.5.2 Resp Lead.....	15-3
15.5.3 No Breath Alarm Delay	15-4
15.5.4 Enhance Filter.....	15-4
Chapter 16 SpO ₂ Monitoring.....	16-1
16.1 Overview	16-1
16.1.1 Identification of SpO ₂ Sensor Type	16-1

16.2 SpO ₂ Display	16-2
16.3 Safety Instructions	16-2
16.3.1 Masimo SpO ₂ Specific Information	16-5
16.4 SpO ₂ Accuracy Test.....	16-6
16.5 Monitoring Steps	16-6
16.6 Measurement Restrictions	16-8
16.7 SpO ₂ Setup	16-9
16.7.1 Set Off Level	16-9
16.7.2 Smart Alarm	16-9
16.7.3 Smart Pulse Tone.....	16-10
16.7.4 NIBP Same Side	16-10
16.7.5 Set Signal IQ.....	16-10
16.7.6 Average Time	16-11
16.7.7 Fast Sat	16-11
16.7.8 Sensitivity	16-11
16.8 Masimo Information.....	16-12
Chapter 17 NIBP Monitoring	17-1
17.1 Overview	17-1
17.2 NIBP Display	17-1
17.3 Safety Instructions.....	17-2
17.4 NIBP Measurement	17-3
17.4.1 Preparations for Measurement.....	17-3
17.4.2 Measurement Restrictions	17-4
17.4.3 Start the Measurement.....	17-5
17.4.3.1 Start the Manual Measurement.....	17-5
17.4.3.2 Start the Whole Point Measurement.....	17-5
17.4.3.3 Start the Interval Measurement.....	17-5
17.4.3.4 Start the Continual Measurement	17-5
17.4.4 Stop the Measurement	17-6
17.5 NIBP Setup.....	17-6
17.5.1 Patient Type.....	17-6
17.5.2 Initial Pressure.....	17-6
17.6 NIBP Reset	17-7
17.7 Assistance in Venipuncture	17-7
Chapter 18 CO ₂ Monitoring	18-1
18.1 Overview	18-1
18.2 Measurement Principle and Working Process.....	18-2
18.3 Adverse Effects on Performance	18-2
18.4 CO ₂ Measure	18-3

18.4.1 Preparations for Mainstream CO ₂ Sensor Connection	18-4
18.4.2 Preparations for Respironics Sidestream CO ₂ Sensor.....	18-5
18.4.3 Preparations for Masimo Sidestream CO ₂ Sensor	18-6
18.4.3.1 Pre-use Checks	18-6
18.4.4 Preparations for Comen Sidestream CO ₂ Sensor.....	18-7
18.5 Zero CO ₂ Sensor	18-8
18.5.1 Zero Masimo CO ₂ Sensor.....	18-8
18.5.2 Zero Respironics & Comen Mainstream CO ₂ Sensors.....	18-8
18.5.3 Zero Respironics & Comen Sidestream CO ₂ Sensors	18-9
18.6 CO ₂ Setup	18-9
18.6.1 Work Mode.....	18-9
18.6.2 Pressure Unit	18-9
18.6.3 Gas Compensation.....	18-9
18.6.4 No Breath Alarm Delay.....	18-10
18.6.5 Altitude.....	18-10
18.6.6 Balance Gas	18-12
18.6.7 Waveform Scale	18-12
18.7 Masimo Sidestream Module Related Information.....	18-12
18.7.1 CO ₂ Module LED	18-12
18.7.2 Warning Information	18-12
18.7.2.1 ISA Sidestream Gas Analyzer Warning Information	18-12
18.7.3 Airway Obstruction	18-13
18.7.4 Discharging Waste Gases	18-14
18.7.5 Leakage Check	18-14
18.7.6 Safety Symbols.....	18-14
18.7.7 Patents and Trademarks.....	18-15
18.7.8 Consumables.....	18-16
18.7.8.1 ISA Nomoline Family.....	18-16
18.7.9 Maintenance	18-17
18.7.10 Cleaning the Analyzer	18-17
Chapter 19 Data Review.....	19-1
19.1 Wave Save.....	19-1
19.2 Trend Review	19-1
19.3 NIBP Measurement Review	19-3
19.4 Alarm Event Review	19-4
19.5 Full-Disclosure Wave Review.....	19-6
19.6 Patient Event Review	19-7
Chapter 20 Recording.....	20-1
20.1 Description of Recorder	20-1

20.2 Recording Types.....	20-1
20.3 Recorder Operation	20-2
20.4 Ether Recorder Setup.....	20-2
20.4.1 Recording waves Setup	20-2
20.4.2 Paper Speed Setup	20-2
20.4.3 Real-time Recording.....	20-3
20.4.4 Ttimed recording Setup	20-3
20.4.5 Grid.....	20-3
20.5 Load Recorder Paper	20-3
20.6 Clear Jammed Paper	20-4
20.7 Recorder Cleaning	20-4
Chapter 21 Other Functions.....	21-1
21.1 Connection to Central Monitoring System	21-1
21.2 Formatting SD Card	21-1
21.3 Analog Output	21-1
Chapter 22 Battery.....	22-1
22.1 General Introduction.....	22-1
22.2 Battery Alarms	22-2
22.2.1 Low Battery Alarms	22-2
22.2.2 Battery Aging Alarms.....	22-2
22.2.3 Battery Fault Alarms	22-2
22.3 Battery Installation	22-2
22.4 Conditioning and Check Battery Performance	22-3
22.5 Battery Recycling	22-4
Chapter 23 Cleaning and Disinfection.....	23-1
23.1 Overview	23-1
23.2 Cleaning of Monitor and Modules.....	23-2
23.3 Disinfection of Monitor and Modules	23-3
23.4 Cleaning and Disinfection of Accessories.....	23-3
23.4.1 Cleaning and Disinfection of the External Electrode Paddle.....	23-3
23.4.2 Cleaning and Disinfection of NIBP Cuff.....	23-4
23.4.3 Cleaning and Disinfection of Other Accessories	23-5
23.4.3.1 Cleaning of Accessories.....	23-5
23.4.3.2 Disinfection of Accessories	23-5
Chapter 24 Maintenance.....	24-1
24.1 Maintenance Check	24-1
24.2 Maintenance and Test Schedule	24-1
24.2.1 Reusable Accessory Service Life	24-2
24.3 Self-test.....	24-2

24.4 Shift Exchange Check	24-3
24.5 Auto Test	24-3
24.6 User Test.....	24-4
24.6.1 User Test Interface	24-4
24.6.2 Routine Test.....	24-5
24.6.3 Energy Delivery Test.....	24-5
24.6.4 Controls Test	24-5
24.6.5 Test Result Review	24-6
24.6.6 User Test Prompt.....	24-6
24.7 Recorder Test	24-7
24.8 ECG Cable Test.....	24-7
24.9 Manual Defibrillation Test	24-7
24.9.1 Charge/ Shock Function	24-7
24.9.2 Disarming Energy.....	24-8
24.9.3 Synchronized Defibrillation	24-8
24.10 Pacing Test	24-9
24.11 ECG Calibration	24-9
24.12 NIBP Air Leakage Test	24-9
24.13 NIBP Pressure Verification	24-10
24.14 NIBP Overpressure Protection Test	24-11
24.15 Electric Safety Test.....	24-11
Appendix I Accessories.....	I-1
Appendix II Product Specifications	II-1
Appendix III Cardiac Rhythm Recognition Test.....	III-1
Appendix IV System Alarm Information	IV-1
Appendix V Factory default configuration	V-1
Appendix VI EMC.....	VI-1
Appendix VII Defibrillation Monitor Shift Checklist	VII-1

Blank Page

1.1 Safety Information

Danger

- To indicate the dangers which would result in death or severe personal injury.

Warning

- Alerts you to the situations that may result in serious consequences or endanger personal safety. Failure to observe the warning information may cause severe injury or even death of the user or patient.

Caution

- Alerts you to potential dangers or unsafe operations, which, if not avoided, may result in minor injury, product failure or damage, or property damage, or cause more serious injury in the future.

Note

- Emphasizes important precautions and provides instructions or explanations for better use of the product.

Warning

- The defibrillation monitor generates high voltage during defibrillation, which may cause major injury or death. Therefore, the defibrillation monitor should be used by or under the guidance of professional clinicians. Personnel using this defibrillation monitor should receive adequate training. Any unauthorized personnel or personnel without training shall not perform any operations.
- Before using, you must check the monitor and its accessories to ensure that they can work normally and safely.
- Do not conduct therapy on patients lying on wet ground.
- When conducting therapy on patients with pacemaker, the pads or paddles should be placed away from the pacemaker.
- Do not place the power outlet out of the operator's reach.

- **Alarm volume and high/low alarm limits should be set depending on the patient. When a patient is monitored, do not exclusively rely on the audible alarm system. If the alarm volume is set too low or is completely turned off, the alarm will not be heard, and the patient may be put into danger. Pay close attention to the patient's actual clinical conditions is the most reliable monitoring way.**
- **The monitor can only be connected to a power outlet with protective ground. If the power socket is not connected to a ground conductor, use the rechargeable battery to supply power to the monitor instead of using the power outlet.**
- **You should always check whether the power plug is loose or falling off, so as to prevent the device from suddenly shutting down and causing potential harm to the patient, when the battery is not installed or the battery is damaged.**
- **Do not open the housing of the monitor to avoid the potential risk of electric shock. The monitor must be maintained and upgraded by service technician trained and authorized by Comen. Non-professional operation can cause the monitor damage or cause a security risk, and human health may be endangered.**
- **Observe the local laws and regulations or the waste disposal rules of the hospital when disposing of packaging materials. Keep the packaging materials out of the reach of children.**
- **Do not use the monitor in the presence of flammable anesthetics or other flammable substance in combination with air, oxygen-enriched environments, or nitrous oxide.**
- **To ensure safety, avoid stacking multiple equipment or placing anything on the monitor during operation.**
- **Carefully place the monitor power cord and accessories cables to avoid entanglement, potential strangulation, and electrical interference to the patient.**
- **To protect you from electric shock, always remove the sensor and completely disconnect the monitor before bathing the patient.**
- **For patients with pacemakers, the cardi tachometer may be used to record pacemaker pulse in the event of asystole or arrhythmia. Do not completely rely on the alarm function of the cardi tachometer. Patients with pacemakers must be closely monitored. For the pacemaker inhibiting function of the monitor, please refer to relevant section in this Manual.**
- **Keep patient under close surveillance when using this monitor to conduct therapy. If the shock is delayed, the shockable rhythm may change to nonshockable rhythm, leading to delivering wrong shock.**
- **The equipment without defibrillation protection shall be disconnected from the patient during defibrillation.**
- **During defibrillation, the operator should not come into contact with the patient, the monitor or the supporting table; otherwise may result in serious injury or death. Before reusing the cables, check to confirm that their functions are normal.**
- **Any equipment connected to the monitor shall form an equipotential body (effective connection of protective ground).**
- **In order to avoid burns (resulted from electric leakage) to the patient, ensure that the**

monitor's sensors and sensor cables never come into contact with any high-frequency electrosurgical equipment.

- The physiological waveform and parameter, alarm message and other information displayed by the monitor are only for reference by physicians, and not directly used as a basis for clinical treatment.
- Electromagnetic field can affect the performance of the monitor. Therefore, equipment used near the monitor should conform to the applicable EMC requirements. For example, mobile phones and X-ray machines are potential sources of interference, since they transmit high-intensity electromagnetic radiation.
- Do not use the monitor during MRI scanning or in a MRI environment as it may result in physical harm.
- The operator should verify that the synchronous input equipment is applicable to this monitor and the input signals are valid.
- In normal use, the operator should not touch the signal I/O ports, other live equipment and the patient simultaneously. This action may result in injury to the patient.
- The installation and replacement of fuse should be performed by service technician trained and authorized by Comen.
- After defibrillation, the electrocardiogram (ECG) waveform must recover within 5s; other parameters must recover within 10s.
- The user must not make any modifications to the equipment.
- When the monitor is in normal use, please do not repair or maintain.
- Under the environment of 40 °C to 45 °C, the working time of the equipment should not be more than 10 minutes, otherwise the temperature of the application part contacting the patient may be too high.
- When the equipment is in normal operation, the temperature rise of accessories shall not exceed 2 °C.
- Please implement CPR treatment for the patient first, if the use of the equipment is delayed or interrupted during the first aid.



Caution

- To avoid damage to the monitor, and ensure patient's safety, use accessories specified in this manual.
- Handle the monitor carefully to avoid damage caused by drop, collision, strong oscillation or other external mechanical forces.
- Before powering on the monitor, verify that the supply voltage and frequency conform to the requirements specified on the monitor nameplate or in this manual.
- At the end of the monitor and accessories service life, they must be disposed of in accordance with the local laws and hospital's regulations.

- **Dry the equipment immediately in case of rain or water spray.**
- **Check the cables, paddle handles and functional accessories periodically for possible defects or aging.**











Note

- **Place the monitor at a position where observation, operation and maintenance are convenient and not obstructed.**
- **This manual is based on the maximum configuration; therefore, some contents may not be applicable to your monitor.**
- **Keep this manual available for ease of use and timely reference.**
- **The monitor is not intended for home and helicopter use.**
- **The monitor can only be used for one patient at a time.**
- **The service life of the monitor is 10 years.**

1.2 Symbols

	Refer to instruction manual/ booklet	CE1639	Complies with medical equipment directive 93/42/EEC
	Type CF applied parts, with defibrillation-proof function		European community representative
	Type BF applied parts, with defibrillation-proof function		Equipotential symbol
	AC indicator		Network connection symbol
	Battery level indicator		USB port
	Service indicator		Multi-function connector
	Main menu	IP44	Ingress protection rating
	Event		Shock button
I, II...	Lead select		The environmental protection service life of electronic products is 10 years
	Static-sensitive device		Alarm pause key
	Serial number		Separate collection for electrical and electronic equipment

Safety

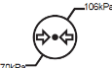
	<p>Manufacturer</p>		<p>Warning: Only use the ECG cable provided by Comen. Other types of ECG cable may decrease the defibrillation energy delivered to the patient.</p>
	<p>This way up</p>		<p>Stacking Layer Limit</p>
	<p>Fragile</p>		<p>Keep away from rain</p>
	<p>Transport and Storage environment temperature of -30°C ~ +70°C</p>		<p>Transport and Storage environment humidity 10%~95%</p>
	<p>Transport and Storage atmospheric pressure of 57kPa~106kPa</p>		

Chapter 2 Overview

2.1 Intended Use

The monitor is used for manual defibrillation, AED defibrillation, pacing and 3-lead or 5-lead ECG monitoring, SpO₂ monitoring, NIBP measurement, two-channel IBP measurement and ETCO₂ monitoring. Manual defibrillation allows synchronous cardioversion. The monitor can be used in hospital, ambulance, emergency scene and other places, and can only be used by qualified medical personnel who have been trained in the operation of the equipment and received basic life support and advanced heart support training. Manual defibrillation is suitable for patients with ventricular fibrillation and ventricular tachycardia. AED defibrillation is suitable for cardiac arrest patients over 8 years old who have lost reactivity, no breathing or abnormal breathing. Pacing is used to treat patients with bradycardia. The monitoring function is used to monitor the vital signs of patients in adults, children or newborns. The monitoring information can be displayed, reviewed, stored and printed.

The expected operator position is about one meter around the monitor in normal use.

2.2 Components

The defibrillator monitor is composed of main unit, battery, paddles, pads and other functional accessories.

2.3 Monitor Views

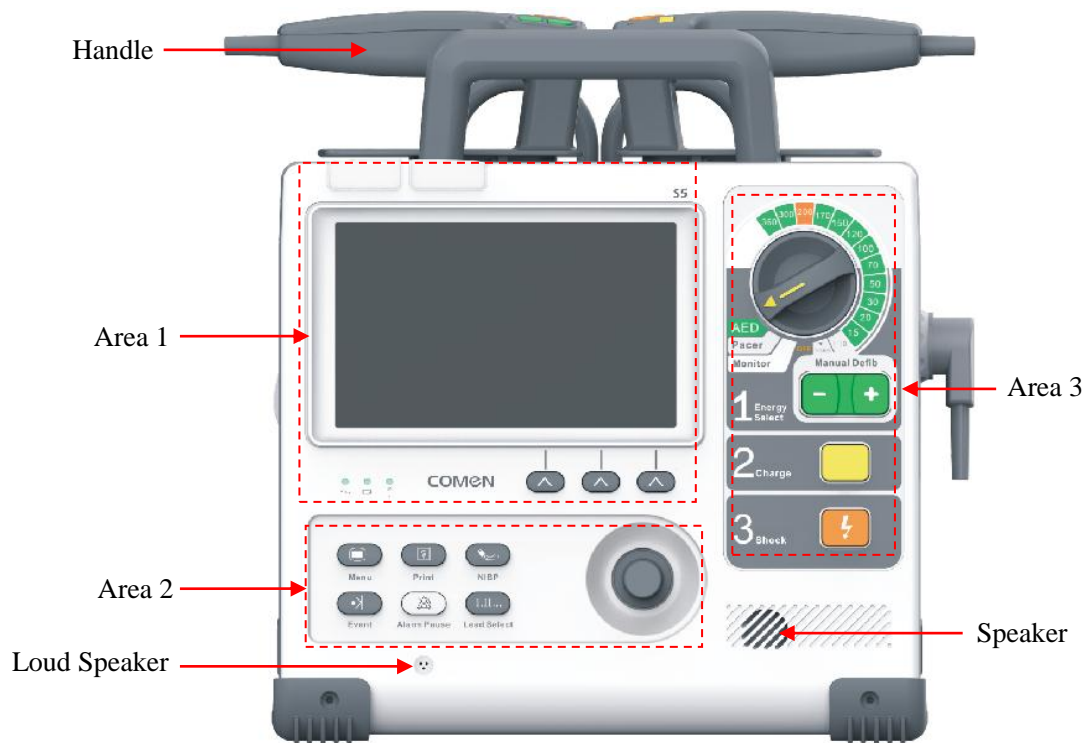

2.3.1 Front View



- 1) Speaker: Used to sound an alarm and a language prompt.
- 2) Loud Speaker: Used to record voices in AED mode.





2.3.1.1 Area 1

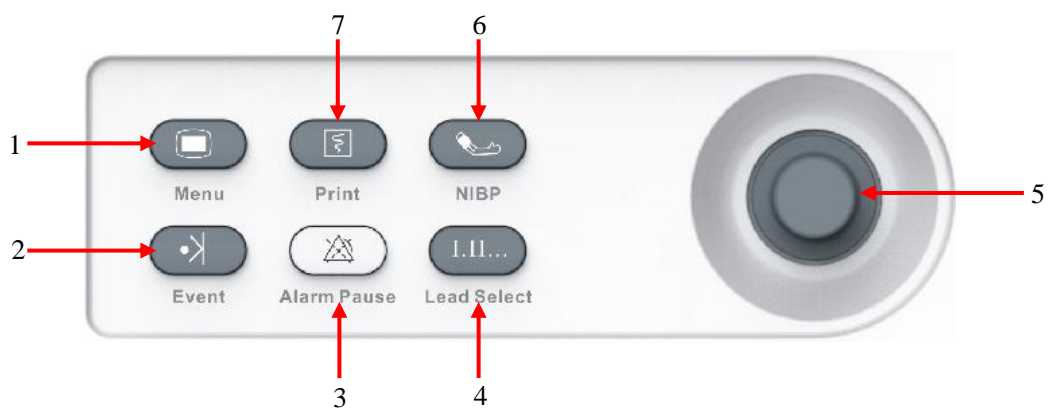

1	Alarm lamps		
2	Display		
3		AC power indicator	Indicator on: this monitor is connected to AC power supply. Indicator off: this monitor is disconnected from AC power supply.
		Battery indicator	Indicator solid on: battery is being charged. Indicator blinks: battery is used to supply power to the monitor. Indicator off: battery is fully charged, is not installed or malfunctions.
		Service indicator	Indicator blinks: The auto test or user test fails Off: The unit operates properly
4	Soft buttons: one-to-one correspondence to the soft button labels on display screen. The buttons have different functions under different operating mode.		

2.3.1.2 Area 2



1		Main Menu	Press to pop up or exit the main menu.
2		Event	Press to mark some specific events, or to pop up or exit [Event Mark Setup] menu.
3		Alarm Pause	Press to pause alarms
4	I.II..	Lead Select	Press to select lead for the first ECG waveform.
5	/	Rotary Knob	Used to select menus and confirm settings; rotate it right or left to move the cursor and press it to select.
6		NIBP Start	Press to start or stop NIBP measurement.
7		Record key	

2.3.1.3 Area 3

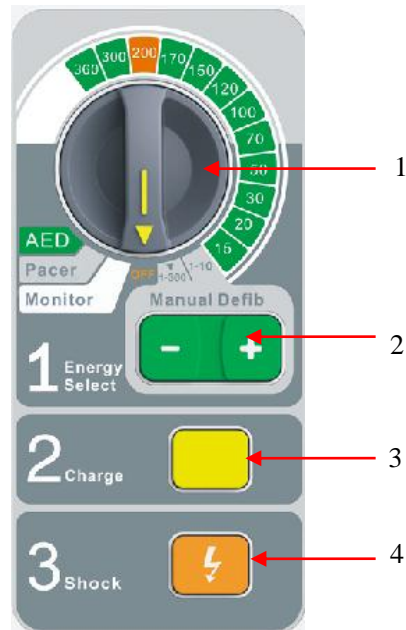

1	Mode Selector: Rotate to switch operating mode, including AED, Pacer, Monitor, Manual defibrillation and OFF mode, and select energy level in Manual defibrillation mode. The monitor will shut down when in OFF position for about 3s.
2	Energy Select button: Press “-” and “+” to decrease and increase energy level respectively in manual defibrillation mode.
3	Charge button: Press to charge the defibrillator.
4	Shock button: Press to deliver defibrillate or energy to patients

2.3.2 Right View



2.3.3 Left View

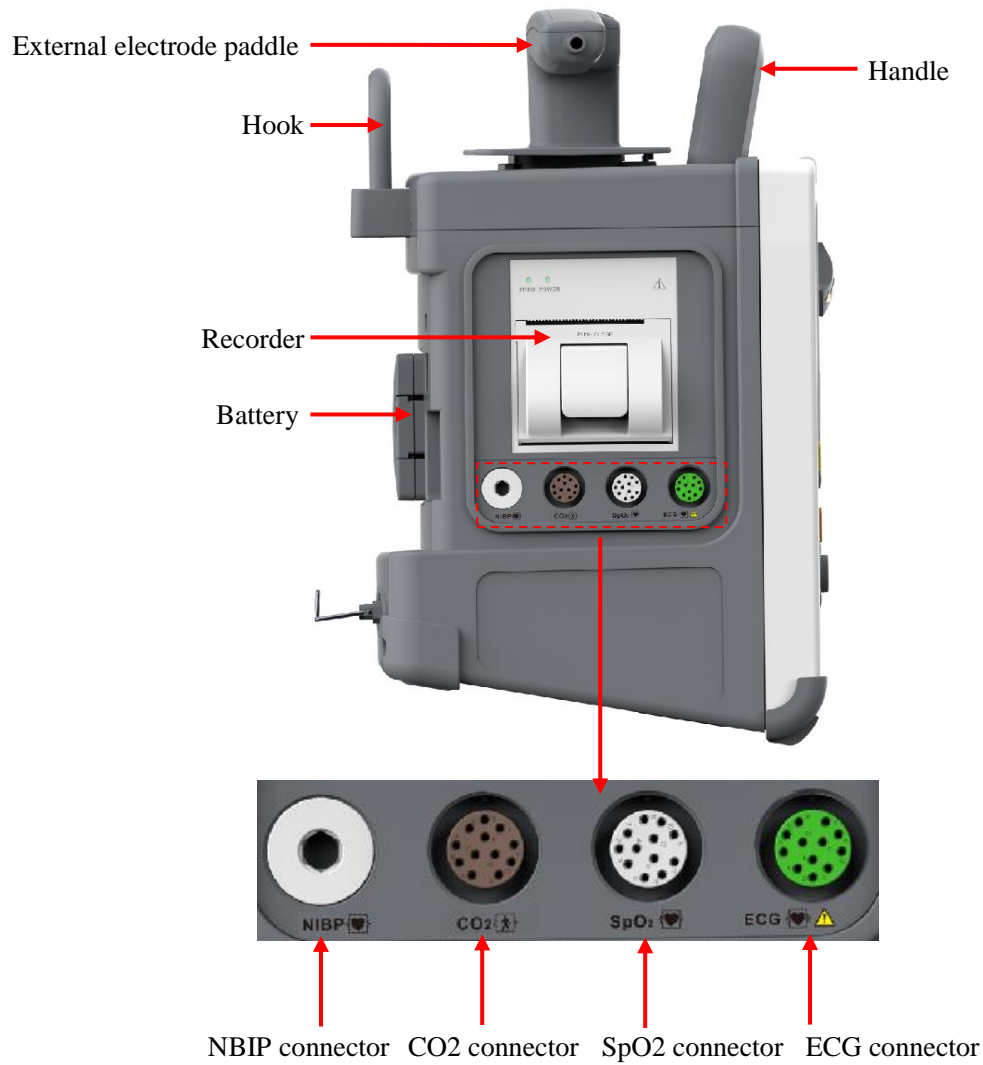

2.3.4 Rear View

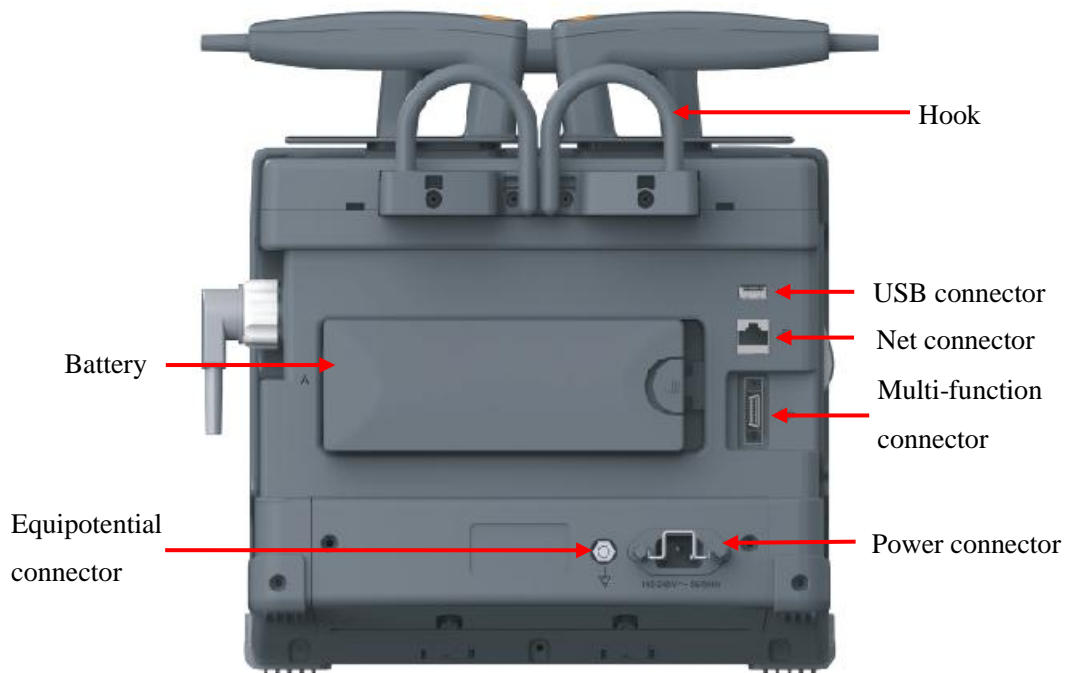

1. Equipotential connector: When the monitor is used together with another equipment, use a wire to connect the equipotential terminals of the monitor with that equipment. This eliminates the ground potential difference, thus ensuring the safety.
2. USB connector: supporting USB equipment (plug and play).
3. Network connector: connecting to the central monitoring system or other equipment by a network cable.
4. Multi-function connector:
 1. Used as defibrillation synchronization port: inputting defibrillation synchronization signal;
 2. Used as analog output port: outputting analog signals;

Warning

- Only the approved analog or digital equipment in accordance with the specified IEC standards (like IEC 60950 safety standards for Information Technology Equipment, IEC 60601-1 safety standards for medical electrical equipment, etc.) are allowed to be connected to the monitor. All configurations should comply with the valid version of the standard IEC 60601-1. Personnel who connects external equipment to the signal I/O ports of the monitor should verify that medical system complies with IEC 60601-1 requirements, before configuring the medical system and connecting the external equipment.
- In normal use, the operator should not touch the signal I/O ports, other live equipment and the patient simultaneously. This action may result in injury to the patient.
- If more than one external equipment is connected to the monitor at one time through the patient cable connector, network connector or other signal ports, the total leakage current should be in accordance with the requirement specified in IEC 60601-1.

2.3.5 External Defibrillation Electrode Paddle

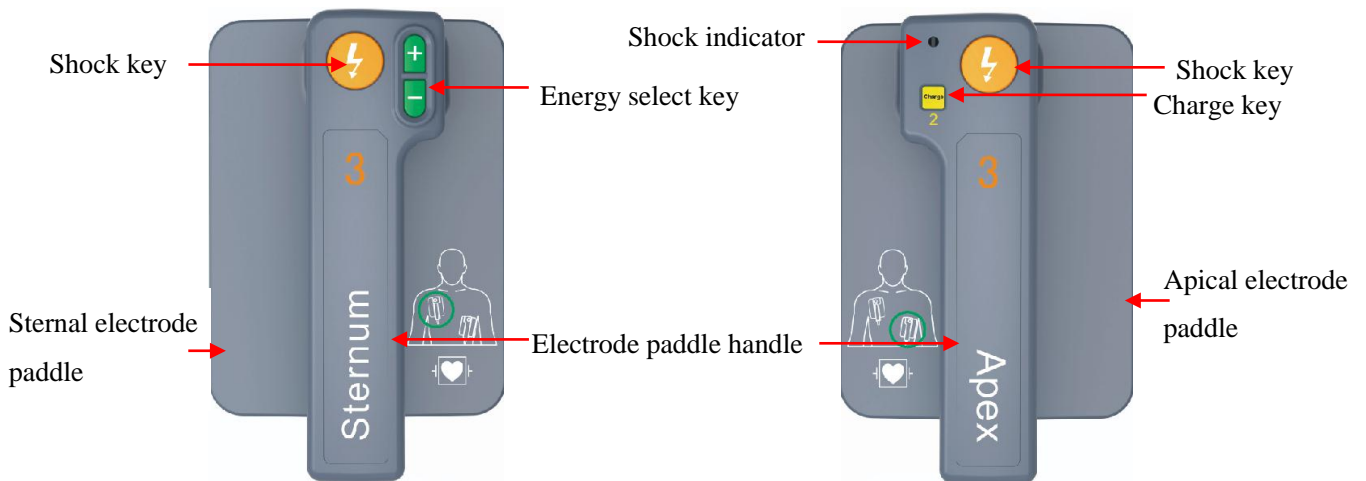

2.4 OSD (On-screen Display)

This monitor uses a backlight LCD color screen which can simultaneously display:

- Physiological parameters,
- Waveforms,
- Alarm message,
- Time,
- Battery level,
- Prompt messages, and so on.

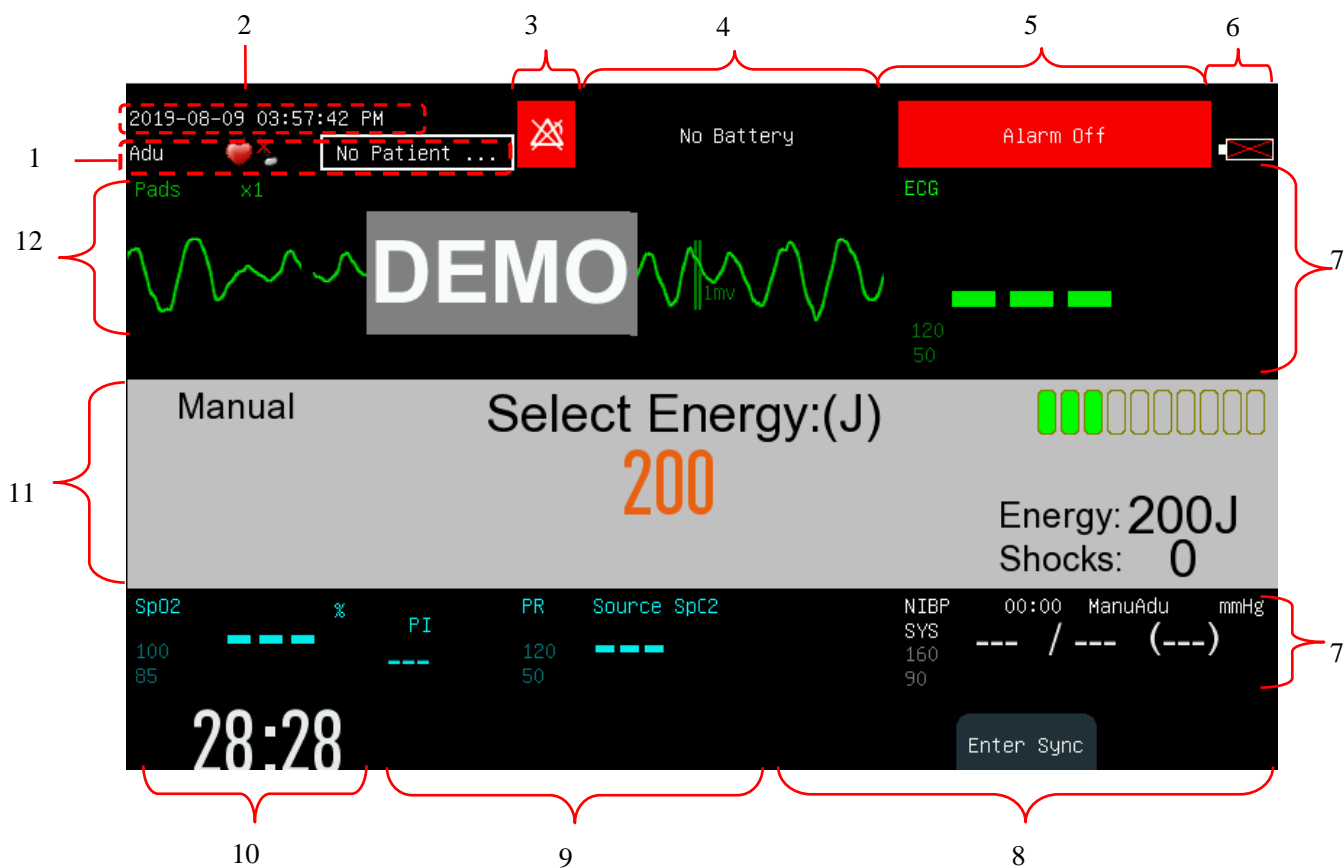

1. Patient information area: Display the patient type (adult, pediatric and neonate), pacemaker status, and name. Select the patient info to enter the [Patient Manage] menu.

For patients with pacemakers, when [Pace] (Pacemaker) in the [Patient Info] menu is enabled, icon is shown at the upper right corner of this area; when [Pace] (Pacemaker) is disabled, icon is shown at the upper right corner of this area.

2. Time: Shows the current configured time of the monitor. You can enter the [Main Menu] → [Maintain] → Enter Password → [Time Setup] menu to reset the system clock according to your local time zone.

3. Prompt icons:

Alarm Pause icon

Alarm volume off icon

Alarm system off icon

Alarm reset icon

4. Technical alarm message:

Display the current technical alarm (for example: ECG LEAD OFF). When there are multiple technical alarms, alarm messages scroll in a cycle. Select the technical alarm message area to enter the [View

Technical Alarm] window.

5. Physiological alarm message:

Display the current physiological alarm (for example: ***RR TOO HIGH). When there are multiple physiological alarms, alarm messages scroll in a cycle. Select the physiological alarm message area to enter the [View Physiology Alarm] window.

6. Battery status icon: Indicate the status of battery. Refer to **Battery** for detail.

7. Parameter Area

- ◆ Display the measured value and the set alarm limit of each physiological parameter. When the measured value is invalid, there is no numerical display in the parameter area, and the horizontal line is displayed.
- ◆ The parameter is displayed as the same color with the corresponding waveform.
- ◆ Select a parameter to open the corresponding setup menu.

For details on the layout of this parameter area, see Section **Screen Setup**.

8. Soft Button Labels

These three labels are one-to-one corresponding to the three soft buttons below them. They will vary with different operating modes and display screens. Blank label indicates the corresponding soft button is invalid.

9. Status Message Area

Display status message and prompt message.

10. Elapsed Time

Display the operating time after this monitor starting up.

11. Manual Defibrillation Message Area

Display the energy selected, shock times and relative prompt message.

12. Waveform Area

Display the measurement waveforms with the waveform name at the left top corner.

2.5 Operating Mode

The Defibrillator Monitor is applicable to pre-hospital and in-hospital use and must only be used by qualified medical personnel who have received enough operation training, basic life support training and advance cardiac life support training.

The monitor supports four operating modes, including manual defibrillation mode, monitor mode, pacemaker mode and AED mode.

2.5.1 Manual Defibrillation Mode

In manual defibrillation mode, operators analyze patient's cardiac rhythm and operate following the steps below according to needs:

1. Select manual defibrillation mode and adjust energy level if necessary;
2. Charge the defibrillator;
3. Shock.

Synchronized cardioversion is also provided in manual defibrillation mode.

Manual defibrillation is applicable to patients suffering from ventricular fibrillation and ventricular tachycardia and without respiration and pulse; synchronized cardioversion is used to stop atrial fibrillation.

Contraindications

Do not conduct manual defibrillation on patients of any kind below:

- ◆ With response
- ◆ With autonomous respiration
- ◆ Can touch the pulse

2.5.2 Monitor Mode

In monitor mode, the Defibrillator Monitor is applicable to adult, pediatric and neonate bedside monitoring and can be used to monitor, display, store, review and transfer multiple physiological parameters including ECG, RESP, SpO₂, NIBP and CO₂.

2.5.3 Pacer Mode

Pacer mode provides noninvasive pacing therapy. Noninvasive pacing is used to conduct therapy for bradycardia patients.

Contraindications

Noninvasive pacing cannot be used for ventricular fibrillation therapy. Noninvasive pacing should be used with caution in case of hypothermia.

2.5.4 AED Mode

In AED mode, the Defibrillator Monitor analyzes patient's cardiac rhythm automatically and gives "Shock Advised" or "No Shock Advised" prompts. What's more, the Defibrillator Monitor can guide operators to conduct defibrillation through voice prompt and display prompt message on the screen as well.

AED is applicable to sudden cardiac arrest patients of the following kinds:

- Without response
- Without respiration or Not breathing properly

Only conduct defibrillation on children below 8 years old in manual defibrillation mode.

Contraindications

Do not conduct AED on patients of any kind below:

- With response
- With normal respiration

Chapter 3 Installation

Warning

- The defibrillator monitor must be installed by the personnel specified by Comen.
- With copyright reserved, any person shall not falsify, photocopy or exchange the software in any manner whatsoever without prior written permission of Comen.
- When the Defibrillator Monitor is connected with other electrical equipment as a combination with specific function, if users could not confirm the combination has no danger (for example, the electric shock hazard caused by the accumulated leakage current) from the specifications of each equipment, please contact the specialist of Comen or the hospital to ensure the combination is safe.
- Only the analog or digital equipment compliant with the specified IEC standards (like IEC 60950 standard for data processing equipment, IEC 60601-1 standard for medical equipment, etc.) are allowed to be connected to the Defibrillator Monitor. The configuration of these equipment should comply with the valid version of IEC 60601-1 standard. The person who connects external equipment to the signal I/O interface should configure the medical system and ensure the medical system complies with IEC 60601-1 standard. If you have any question, please contact Comen.

3.1 Unpacking and Checking

Carefully take the monitor and its accessories out of the packing box and check according to the following aspects..

1. Check whether all accessories are provided according to the Packing List.
2. Check for damage.
3. Check all exposed lead wires and connectors.

For any problem or inconsistencies, contact Comen or your distributor

Keep the packaging materials for future use.

Warning

- This equipment may suffer from microbial contamination during transport, storage or use. Please check whether the packaging is intact, especially for the disposable accessories, and do not use those with any damage.
- The disposal of packaging materials shall comply with the local laws and regulations or the waste disposal rules and regulations of the hospital. Keep the packaging material out of the reach of children.

3.2 Connection of AC Power Cord

Before powering on the monitor, verify that the supply voltage and frequency conform to the requirements specified on the monitor nameplate or in this manual. The steps of connecting the AC power cord:

1. Using the power cord that came with the instrument, connect one end of the power cord to the power connector on the instrument and the other end to a grounded electrical outlet.
2. Check if the AC indicator is lit. The indicator lights up when the AC power is turned on.



Note

- **Connect the power cord to specific hospital outlet.**
- **When a battery is provided, the battery must be charged after transportation or storage. If the battery is low, the monitor may fail to work without connecting an AC power supply. Once the monitor is connected to an AC power outlet, the battery will be charged whether the monitor is switched on or not.**

Connect the equipotential conductor when necessary. Please refer to the content about equipotential grounding in the “*Patient Safety*”.

3.3 Start-up

1. Before power on, please check whether there is mechanical damage on the Defibrillator Monitor and whether the external cables and accessories are connected correctly.
2. Insert the power cord into AC power supply socket. If battery is used to supply power, make sure that there is adequate battery power.
3. Rotate the mode selector to the desired operating mode. First the left alarm lamp turns red and right turns cyan, and then left turns yellow and right turns blue.
4. Startup picture disappears and the Defibrillator Monitor enters the selected operating mode.



Warning

- **If any evidence of failure or any error message is found, do not use this monitor. Contact a service technician of Comen or a biomedical engineer in your hospital.**



Note

- **The system sound an alarm when a major error is detected in the self-test.**
- **Check all monitoring functions to ensure that the monitor can operate normally.**
- **The battery must be charged after each use to ensure that sufficient battery power is available.**
- **To extend the service life of the monitor, after shut-down, wait for at least 1 minute before restarting the monitor.**
- **When the monitor is transferred from the minimum storage temperature or the maximum**

storage temperature to the ambient temperature of 20 °C, the time required for the monitor to achieve its intended use is 10 minutes.

3.4 Shutdown

- 1) Confirm that the device can be stopped.
- 2) Disconnect the device cable and sensor from the patient. Put defibrillation electrode paddles back to their slots properly.
- 3) Save or clear patient data as per need.
- 4) Rotate “Mode Selector” to switch OFF mode, the monitor will shut down. To completely disconnect the power supply, please pull out the power plug.

3.5 Connecting the Sensor or Patient Cable

Confirm what kind of monitoring or treatment is needed and connect the required sensor or patient cable to the monitor and the patient's monitoring site. Please refer to the relevant sections for the correct connection method and related requirements for various sensors and patient cables.

3.6 Install the monitor on the ambulance

When the monitor is used for emergency transportation in the ambulance, it is necessary to install the monitor on the fixed base of the ambulance. As shown in the figure below:

- 1) Install this part into the monitor and fix it on the monitor with the two M3 screws provided.

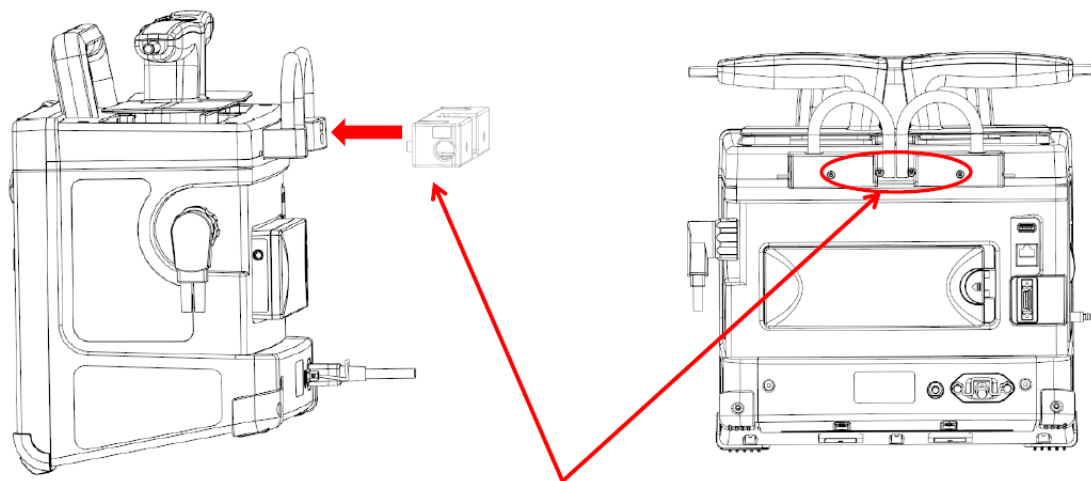

- 2) Use four M5 screws to fix the bracket on the ambulance through the hole in the red circle shown in the figure below.

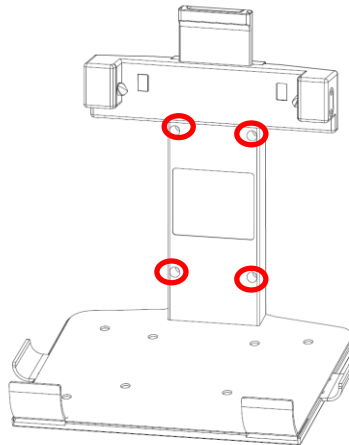

- 3) Put the monitor on the bracket, and then tilt it to the wall, and fix the monitor to the bracket through the hole shown by the red arrow below.

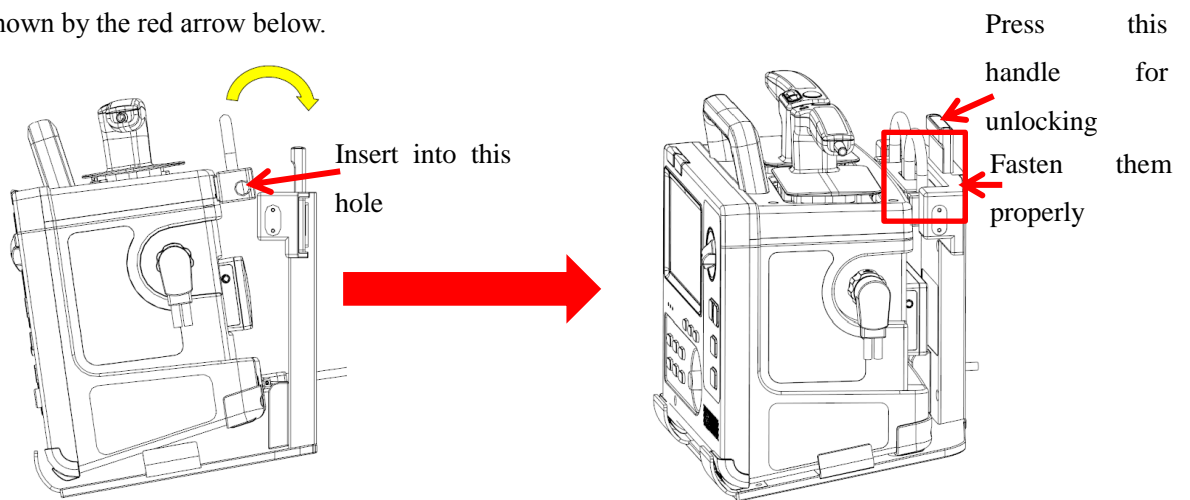

- 4) Use four M4 screws to fix the bracket with the host through the hole in the red circle shown in the figure below from the bottom of the bracket.

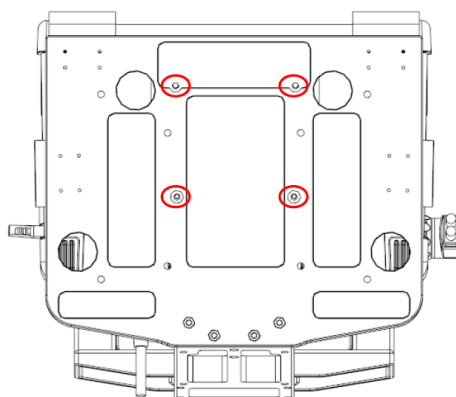

5) The final fixed position of the monitor is shown in the following figure:

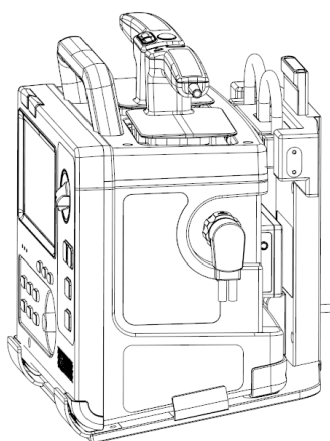

Warning

- **The monitor can only be connected to a power outlet with protective ground. If the power socket is not connected to a ground conductor, use the rechargeable battery to supply power to the monitor instead of using the power outlet.**
- **The monitor installation, including a correct protective earth connection, must only be carried out by qualified service technician.**
- **When the fixed base is installed, it should be verified that its protective ground terminal is reliably connected to the protective ground of the external power supply system.**

Chapter 4 Patient Safety

4.1 Safety Instructions

The monitor is designed in accordance with international safety standards for medical electrical equipment. It is provided with defibrillation-proof and electrosurgical protection with floating ground input.

4.2 Environmental Requirements

Before powering on the monitor, verify that the supply voltage and frequency conform to the requirements specified on the monitor nameplate or in this manual.

The monitor should be used in an environment that can reasonably avoid vibration, dust, corrosive or explosive gases, extreme temperature and humidity, etc.

When the monitor is installed in an enclosed space, make sure the space is well ventilated. Leave at least 2 inches (5cm) free space around the monitor for air circulation. Also, leave sufficient space around it for easy operation and maintenance.

4.3 Protective Grounding

To protect both the patient and the operator, the housing of the monitor must be grounded. The monitor is equipped with a detachable 3-wire power cord, which shall be inserted into a grounded power outlet to ensure that monitor is grounded. If grounded power outlet is not available, contact the maintenance department in your hospital.



Warning

- **It is NOT recommended to connect the 3-wire power cord to a 2-wire power outlet.**

Connect the ground wire to the equipotential connector of the monitor. If you have doubt about whether equipment used may cause any electrical risks, such as risk caused by accumulation of leakage current, consult an expert in this field to ensure the safety of all equipment.

4.4 Equipotential Grounding

The monitor must be connected to a power outlet with protective grounding. For cardiac or cerebral examination, the monitor must be connected to a standalone equipotential grounding system. Connect one end of the equipotential conductor (potential equalization conductor) to the equipotential connector on the rear

panel of the monitor and the other end to a connector of the equipotential grounding system. In the event the protective grounding system is damaged, the equipotential grounding system can provide protection to the patient and operator.

Cardiac (or cerebral) examination can only be performed in a room installed with a protective grounding system. Before each use, ensure the monitor is in a normal operating status. Cables connecting the patient to the monitor must not be contaminated by electrolyte.



Warning

- **If the protective grounding system is not stable, use the built-in battery to supply power to the monitor.**



Note

- **If the use of the equipment is affected by the equipotential grounding, contact the Company's After-Sales Service Department or agents.**

4.5 Condensation

Ensure that the monitor is free from condensation during operation. When the monitor is moved from one room to another, condensation may be formed due to exposure to damp air and temperature difference. In this case, do not use the monitor until it is dry.



Chapter 5 Basic Operations





Note

- The distance between the operator and the monitor should be less than 1 m so that the operator can observe the monitor easily.

5.1 Enter Main Menu

In pacer, monitor and manual defibrillation mode, press  key on the front panel to access [Main Menu] and perform operations and settings. In AED mode, the  key is unavailable.



1.  key: Press this button to exit the current menu.
2. ,  key: Page up/down.

5.2 Enter User Maintain Menu

Enter [Main Menu] → [Maintain]. Enter the correct password in the pop-up [Password] dialog to enter the [User Maintain] menu.

5.3 View Monitor Info

Enter [User Maintain] → [Monitor Info] (Monitor Information). Monitor info includes software and hardware version, etc., which facilitate the manufacturer to maintain and trace the monitor.

5.4 Enter Parameter Setup Window

Enter the setup windows by one of the following ways:

- In the waveform area: Select a waveform and the corresponding setup window will display. For example, you can select ECG waveform to open the [ECG Wave] window.
- In the parameter area: Select a parameter and the corresponding setup window will display. For example, you can select the ECG parameter area to open the [ECG Setup] window.
- In the [Measu. Setup] menu: Enter [Main Menu] → [Measu. Setup] to open the [Measu. Setup] window. You can select and set the desired parameter.

After entering the setup windows, you can set parameters displayed on the screen.

5.5 General Setup

5.5.1 Time Setup

Enter [User Maintain] → [Time Setup]. Set the system time according to the local time zone, including Year, Month, Day, Hour, Minute (Min), Second (s), Date Format, and Time Format. The settings become effective immediately.

5.5.2 Language Setup

Enter [User Maintain] → [Language]. Select the user screen language that you want.

5.5.3 Measurement Unit Setup

Enter [User Maintain] → [Unit Setup]. Set the units you want to use for parameters, including [Height Unit], [Weight Unit], [Press. Unit] (Pressure Unit), and [CO₂ Unit].

5.5.4 Brightness Setup

- 1) Enter [Main Menu] → [Screen Config] (Screen Configuration) → [Brightness].
- 2) Select the appropriate brightness in X~100. 100 indicates the brightest, and X indicates the darkest (X refers to the factory default setting, generally 10).

5.5.5 Keys Backlight Setup

In dark environment, you can turn on keyboard backlight. To configure:

- 1) Enter [Main Menu] → [Screen Config] → [Key Light].

5.5.6 Screen Setup

Enter [Main Menu] → [Screen Config] → [Screen Layout]. In this window, you can adjust the position of waveforms and parameters. Only parameters that have been turned on are shown on the screen.

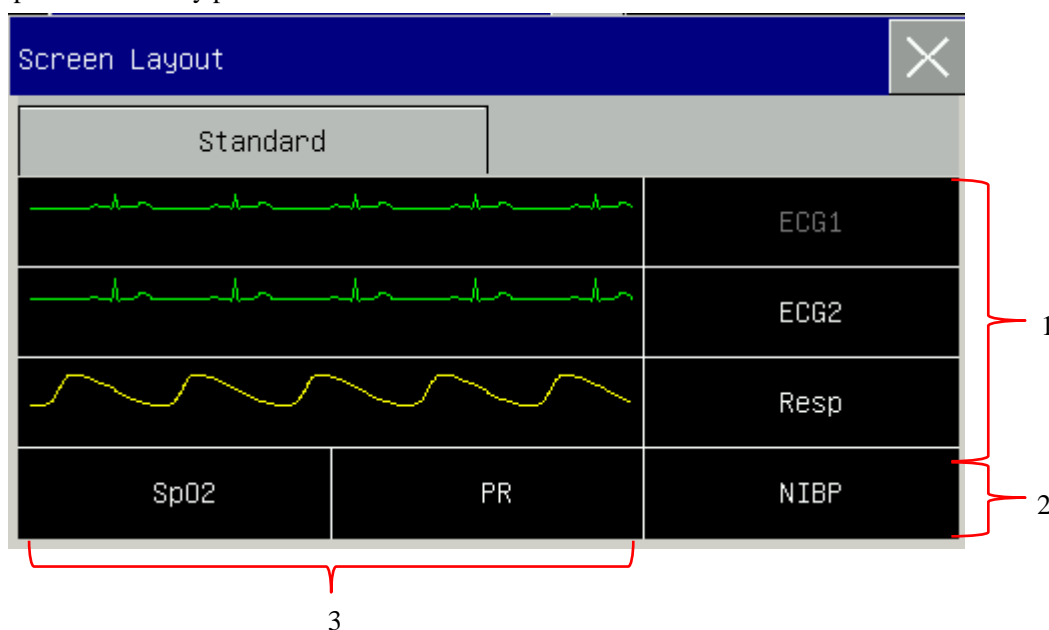

Area 1: Waveform area: You can choose to display the parameters and their waveforms (if one exists). The first row of this area always shows the first ECG waveform and parameter. Waveforms are displayed on the left and parameters on the right. The waveform and its corresponding parameter are shown on the same line.

Area 2: you can choose to display the parameters. But if a particular row in the area 3 has no parameter, the corresponding row in area 2 will display parameters and waveforms at the same time.

Area 3: Parameters without waveform: Only data are displayed for parameters in this area.

After layout setup, select  to exit.

5.5.7 Volume Setup

QRS Volume characteristic: beep

Beat Volume characteristic: beep





Enter [Main Menu] → [Volume Setup].

- 1) Select [Alm Vol] (Alarm Volume): Select the appropriate volume level between X (the lowest volume, which depends on the setting of the Minimum Alarm Volume) and 10 (the loudest volume). Refer to the “*Alarms*” chapter for details;
- 2) Select [QRS Vol.] (QRS Volume): Select the appropriate volume within 0~10;
- 3) Select [Beat Vol]: Select the appropriate volume within 0~10;
- 4) Select [Key Vol]: Select the appropriate volume within 0~10.

5.5.8 Waveform Freeze

In the Monitor mode, select the [Freeze] soft key, then all waveforms on the screen stop refreshing or scrolling and the [Freeze] menu pops up, while the parameter area remains refreshing properly, as shown below.



In the [Freeze] window, use the rotary knob to select the forward or backward key  and then rotate the knob to move the frozen waveform leftward or rightward. A down arrow is shown on the right side above the top waveform, with a time scale displayed to the left of the arrow. The freeze time is marked as [0s ]. With the leftward movement of the waveform, the time scale will change to [-1s , [-2s , [-3s ]... in sequence, indicating that how many seconds the waveform has been frozen.

Record Frozen Waveform

In the [Freeze] window, select the waveform you want to print ([Wave1], [Wave2] and [Wave3] and click the Record key. The recorder prints the frozen waveform and value.

Unfreeze

Click  to exit.

Press the Freeze key on the front panel again.

Press the Freeze Soft Button again.

5.5.9 Event Setup

 **Note**

- **Admit patient first before you manually trigger the event.**

Event setup involves saving waveforms for manually triggered events. During patient monitoring, the occurrence of some events may have certain impacts on the patient, resulting in changes in some waveforms or parameters. You can select manually triggered events in [Manual Trigger] settings. When an event is triggered, the monitor marks it and saves the corresponding waveforms and value. You can review the event later to analyze its impacts. To configure:

- 1) Enter [Main Menu] → [Event Setup] → [Event Marker Setup].
- 2) Choose 3 waveforms from the available options as [Event Save Waves] and mark event: [EVENT A]: Default general event, which cannot be set by the user. [EVENT B/C/D/E/F/G/H]: the following events can be selected: [Epinephrine], [Lidocaine], [ATROPINE], [Nitroglycerin], [MORPHINE], [CANNULA], [VENOUS TRANSFUSION], [ADENOSINE], [AMIODARONE], [VASOPRESSIN], [Isuprel], [Dopamine], [ASPININ], [OXYGEN] and [CPR].
- 3) Users can also set custom events 1, 2, 3 and 4 as needed.
- 4) After the event setting is completed, select the event tag button on the panel to enter [Event Marker Setup], select the event to be triggered, and press the shuttle.

In AED mode, pressing the [Event] button will directly mark event A as a [General] event.

To review a manually triggered event, select the event in the [View Physiology Alarm] menu under [Alarm Event Review].

5.5.10 Module Switch Setup

You can turn on/off the parameter modules as needed. When a parameter module is turned off, the corresponding waveform and parameter are not displayed on the screen, and the monitor stops measurement, analysis and alarm for that module.

- 1) Enter [User Maintain] → [Module Setup].
- 2) Turn on/off a parameter in the setup menu.

5.5.11 User Password Setting

You can set the password for entering the [User Maintenance] according to your own needs.

- 1) Enter [User Maintain] → [Set User PassWord].

5.5.12 High Contrast Display

High contrast display is helpful for operators to view the contents displayed on the screen in the environment with strong light.

In pacer, monitor and manual defibrillation mode, enter [Main Menu], select [High Contrast] and enter high contrast display with [High Contrast] turning to [Normal] simultaneously. Select [Normal] to exit high contrast display.

In AED mode, press [High Contrast] soft button to enter high contrast display and press [Normal] soft button to exit the high contrast display.

The high-contrast display is turned on in one mode of operation, and the high-contrast display is maintained when switching to other clinical modes, but the system no longer saves the settings after shutdown.

5.6 Demo

Enter [User Maintain] → [DEMO] to put the monitor into demonstration mode.



Warning

- **Demo waveforms are used to simulate the actual monitoring process. Demo mode can only be used to demonstrate the monitor performance and assist in training course. In actual clinical use, it is NOT recommended to use the demo mode, because the users/operators may mistake the demo data for waveforms and patient parameters which can put patient safety at risk.**

Chapter 6 Patient Management

You can enter the [Patient Manage] menu in one of two ways:

- a) Enter [Main Menu] and select [Patient Manage];
- b) Click in the patient info area on the upper menu bar.

6.1 Admit

When a patient is connected to the monitor, the monitor displays and saves the patient's physiological data even if the patient is not admitted. But correct patient admission is important for patient monitoring.

You can admit and discharge a patient in the [Patient Manage] window.

To admit a hospitalized patient:

- 1) Enter [Patient Manage] → [Admit].
- 2) If another patient has been admitted on the monitor, the prompt message [Discharge current patient? Admit new patient?] is shown. Select [Yes] to discharge the existing patient. If no patient has been admitted, the prompt message [Apply the monitoring data to the patient to be admitted?] is shown.
 - [Yes]: Apply the monitor data to the new patient.
 - [No]: Clear the stored data on the monitor.
- 3) Enter patient info in the [Patient Info] menu. Pay attention that [Pat Type] (Patient Type) and [Pace] (Pacemaker) are set correctly. You can use keyboard to enter information.
 - ✧ [Pat Type]: the options include [Adu] (Adult), [Ped] (Pediatric), [Neo] (Neonatal). It is essential to select the correct patient type, as it determines the algorithm used to compute and process the patient data, as well as certain safety limits and alarm limits applied to the patient.
 - ✧ [Pace]: This setting determines whether the monitor displays pacemaker pulse. When [Pace] is set to [ON] and pacemaker signal is detected,  symbol is shown above the ECG waveform. When [Pace] is set to [OFF], no prompt message or symbol is displayed, and pacemaker pulse is filtered out.



Warning

- **Whether a patient is admitted or not, the monitor assigns a default value to both [Pat Type] and [Pace]. Make sure the settings in [Patient Info] are consistent with the patient's actual conditions before monitoring.**
- **When the patient type is changed, the system loads the factory default configuration. Verify the alarm limits before patient monitoring to ensure that these alarm limits suit your**

patient. When the patient type is not changed, the current configuration is not changed.

- For the patient without pacemaker, [Pace] must be set to [OFF]. Otherwise, the system cannot detect arrhythmia related to ventricular premature beats (including PVCs count), and ST segment analysis will not be carried out.
- If the patient is admitted with a pacemaker, [Pace] should be set to [ON]. Otherwise, pacemaker pulse may be counted as normal QRS wave, resulting in failure to detect the [ECG Lost] alarm.

6.2 Quick Admit

The [Quick Admit] mode can be used in emergency situation when there is not enough time to fill in patient information. However, you must complete the patient info later.

- 1) Enter [Patient Manage] → [Quick Admit].
- 2) If another patient has been admitted on the monitor, the prompt message [Discharge current patient? Admit new patient?] is shown. Select [Yes] to discharge the existing patient. If no patient has been admitted, the prompt message [Apply the monitoring data to the patient to be admitted?] is shown.
 - [Yes]: Apply the monitor data to the new patient.
 - [No]: Clear the stored data on the monitor.
- 3) Enter the [Patient Info] window, set [Pat Type] and [Pace], and then close the window.

6.3 Discharge

To discharge a patient from the monitor:

- 1) Enter [Patient Manage] → [Discharge].
- 2) The system shows the prompt message [Discharge?].
 - [Yes]: Discharge the current patient. The original patient data will be archived automatically if the monitor is mounted with a SD card. You can review the archived patient data in [Document Manage].
 - [No]: Cancel the discharge operation.



Warning

- After the patient is discharged, [Pace] will be automatically set to off.

6.4 Document Manage

You can inquire, review, delete and export archived patient files in [Document Manage]. However, patient data cannot be archived if the monitor is not installed with a SD card.

[Query]: Enter the patient name in the field at the lower left corner of the [Document Manage] window and click [Query] to search for the patient's file.

[View]: Select the patient info bar you want to review. Click [View] to open [Review] menu, in which you can view [Patient Info], [Trend Review], [NIBP Review], [Alarm Event Review], [Wave Review] and [Patient Event Review].

[Delete]: Delete the selected patient file.

[Export]: Export the selected patient file to a USB flash drive.

To manage patient file, do the followings:

- 1) Enter [Main Menu] → [Document Manage].
- 2) Enter a patient name in the input field at the lower left corner of the window.
- 3) Click [Query] to show the patient files found.

If there are multiple patient files found, click the  keys to select the one you want to view; click the  keys to show more information of the patient.

- 4) You can [View], [Delete] and [Export] the selected patient file.
- 5) If you check the box at the lower left corner, all patient files are selected. At this time, you can click [Delete] to delete all patient files.
- 6) You can export patient files by following these steps:
 - If a single patient file is selected, select [Export] to open the [Data Export] menu.
 - 1) Set the [Start Time] and [End Time].
 - 2) Select [File Format]: options are .bin or .txt.
 - 3) Select [Data Export] to export to a USB flash drive.
 - 4) When it is finished, the prompt message [Data export succeeded, please restart.] is shown.
 - If multiple patient files are selected, operations steps are the same with those for single patient file except that [Start Time] and [End Time] cannot be set.

Document Manage(28) ✕				
Name	MonitorTime	Patient ID	Bed No.	Birth Date
<input type="checkbox"/> 1)	2019-07-03 05:54:43 2019-07-03 05:55:03			
<input type="checkbox"/> 2)	2019-07-03 05:50:01 2019-07-03 05:52:17			
<input type="checkbox"/> 3)	2019-07-03 05:46:01 2019-07-03 05:50:01			
<input type="checkbox"/> 4)	2019-07-03 05:41:22 2019-07-03 05:46:01			
<input type="checkbox"/> 5)	2019-07-03 05:40:03 2019-07-03 05:41:00			
<input type="checkbox"/> 6)	2019-07-03 05:34:52 2019-07-03 05:39:42			
<input type="checkbox"/> 7)	2019-07-03 03:23:22 2019-07-03 05:34:51			
<input type="checkbox"/> 8)	2019-07-03 03:03:53 2019-07-03 03:23:00			

Query View Delete Export ◀ ▶ ▲ ▼



Warning

- Patient alarm messages, physiological and technical alarms are saved in the patient file.
- In the event of a power interruption, alarm events are still saved in the patient file.
- When exporting data to a USB drive, do not remove the USB drive until the export process is completed in order to prevent data corruption.



Note

- When the monitor is shut down, the data in the monitoring period before the shutdown is saved automatically. Upon start-up of the monitor, the system automatically creates a new period (i.e., current period data).
- The monitor allows data storage upon power failure.

6.4.1 Save Tactics

The monitor creates a patient file and save its data even if no patient has been admitted. Such patient file is an unowned temporary case (Temp Case), which can be automatically deleted. Also, the monitor can automatically delete old cases when the SD card is full.

To automatically delete the unowned case and old case, do the followings:

- 1) Enter [User Maintain] → [Save Tactics];
- 2) Select [Auto Del Temp Case] and [Del old case] respectively, and switch them between [ON] or [OFF].

Chapter 7 Configuration Management

7.1 Overview

For continuous monitoring of a patient, the monitor may require adjustment of some settings according to the actual patient conditions. The assembly of predefined settings used to operate the monitor is called a configuration. In order to configure the monitor more effectively and rapidly, this monitor provides a variety of configurations to meet the requirements of different patient types and different hospital departments. You can also customize a configuration according to actual conditions and save it as a user-defined configuration.

Configuration info of the monitor mainly includes:

Parameter Configuration

Settings related to parameter measurements, such as Wave Gain, Speed, Unit, Alarm ON/OFF, and Alarm Limit Setup.

General Configuration

The monitor's general settings, such as Alarm Setup, Screen Layout, and Record.

Maintenance Configuration

Settings related to maintenance, such as Wave Draw and Language

For default system configuration, see Appendix V Factory Default Configuration.



Warning

- **The Config Manage function is protected with password. It can only be operated and approved by professional medical workers.**

To enter the [Config Manage] menu:

- 1) Select [Main Menu].
- 2) Select [Config Manage], and enter the password.

7.2 Department

The department in which the monitor is used. When Department is modified, all user configuration files of the previous department are deleted. Each department has 3 factory default configurations, i.e. ADU (Adult), PED (Pediatric), NEO (Neonatal). At most 3 user-defined configurations can be saved to the current department configuration directory. Before managing the configuration, ensure that the correct department is selected.

Department options: GENERAL (General Monitoring)

OR (Operation Room/Anesthesia Monitoring)

ICU (Intensive Care Unit)

NICU (Neonatal Intensive Care Unit)

CCU (Coronary Care Unit)



Note

- **Upon start-up or before admitting a new patient, you need to check the current configuration of the monitor. This can be viewed in [Load Config]. The configuration name marked with the symbol → in front is the currently loaded configuration.**
- **Make sure the configuration you select is appropriate for the patient being monitored.**
- **Use of different configurations on the monitor in the same department (e.g., ICU or Cardiac OR) may put patient safety at risk.**
- **The monitor automatically loads the corresponding default factory configuration when you switch to another department or change the patient type.**
- **The monitor can memorize system configuration.**

7.3 Manual Defibrillation Settings

Manual defibrillation settings include the following items:

- ✧ [External Defib Energy]: set the default energy for external manual defibrillation. The available energy level includes 2J,5J, 10J, 50J, 100J, 150J, 170J, 200J and 300J.
- ✧ [Auto Disarm Time]:set the time to energy auto disarm, including 30s, 60s, 90s and 120s. If the shock button is not pressed for discharge within the set time, the defibrillation monitor will automatically release the energy.
- ✧ [Sync Keep]: switch [ON] or[OFF]. [ON] means the monitor is still in synchronized cardioversion mode after a synchronized shock. [OFF] means the monitor will auto exit synchronized cardioversion mode after a synchronized shock.
- ✧ [Remote Sync Input]: switch [ON] or[OFF] to activate or deactivate the remote synchronized cardioversion function respectively.
- ✧ [Charge Tone Vol]: adjust the battery tone volume. Available volume level includes [High], [Med]and[Low];
- ✧ [Contact Imped Prompt]: toggle between[ON] and[OFF].[ON] means there will be contact impedance indicator displayed in manual defibrillation mode.

7.4 AED Settings

AED settings include the following items:

- ✧ [Serial Shock Times]: set the serial shock times, including 1,2 and 3. When the number of electric shocks changes, the electric shock energy will change accordingly. When the mode is switched back to AED

mode, the number of electric shocks is cleared and recalculated, and the electric shock energy is counter from the last energy before switching.

- ✧ [First Shock Energy]: set the energy for the first shock. Available energy level includes 100J, 150J, 170J, 200J, 300J and 360J.
- ✧ [Second Shock Energy]: set the energy for the second shock. Available energy level includes 100J, 150J, 170J, 200J, 300J and 360J. Not lower than the first shock energy.
- ✧ [Third Shock Energy]: set the energy for the third shock. Available energy level includes 100J, 150J, 170J, 200J, 300J and 360J. Not lower than the second shock energy.
- ✧ [Auto Disarm Time]: set the time to energy auto disarm, including 30s, 60s, 90s and 120s.
- ✧ [Pre-Shock CPR Time]: set the pre-shock CPR time, including OFF, 30s, 60s, 90s, 120s, 150s and 180s.
- ✧ [CPR Time]: select the CPR duration, including 30s, 60s, 90s, 120s, 150s and 180s.
- ✧ [CPR Metronome]: switch [ON] or [OFF] to activate or deactivate the CPR metronome function respectively.
- ✧ [CPR Mode]: select the CPR mode, including [30: 2], [15:2] and [Only Press].
- ✧ [NSA Process Mode]: select the NSA process mode, including [Continue Analysis] and [CPR].
- ✧ [Voice Prompt]: switch [ON] or [OFF]. [ON] means there will be voice prompt to guide defibrillation in AED mode.
- ✧ [Voice Volume]: set the volume of voice prompt in AED mode, including [High], [Med] and [Low].
- ✧ [Voice Interval]: set the interval of voice prompt in AED mode, including close, 30s, 60s, 90s, 120s, 150s and 180s.
- ✧ [Audio Recording]: switch [ON] or [OFF] to activate or deactivate the audio recording function in AED mode respectively.

7.5 Pacer Settings

Pacer settings include the following items:

- ✧ [Pace Rate]: select the default pacing rate from 40ppm to 170ppm.
- ✧ [Pace Elec]: select the default pacing current from 0mA to 200mA.
- ✧ [Pace Elec Interval]: select the step length of pace current from 1mA, 2mA, 5mA.
- ✧ [Pace Mode]: select the default pacing mode from [Demand Pace], [Fixed Pace].

7.6 Save as User Config

You can save the current configuration as a user configuration after entering a configuration name. The configuration name can consist of alphanumeric characters or underscore (_), but cannot be empty. If the name you have entered is already used by another configuration, the message [Overwrite config with same name?] will display on the screen. The monitor can save up to 3 user configurations.

7.7 Delete Config

Delete user configurations currently saved in the monitor. In this menu, all user configurations saved under the current department are listed, with patient type in brackets added after each configuration name. For example, John (ADU) indicates that the configuration “John” is saved when the patient type is ADU.

7.8 Load Config

The monitor supports up to 6 configurations for one department. Configurations available for loading include the default factory configurations for the current patient type, user-defined configurations, and configurations imported from the USB flash drive. Patient type is marked after the user-defined configuration name. After you load configurations, it replaces the current configurations and become effective.

Enter[Load Config]: enter [Main Menu] or [Config Manage] →[Load Config].

7.9 Import Config from USB

You can import configurations from a USB flash drive if there are less than 6 configurations for the current department.

7.10 Export Config to USB

Export user-defined configurations in the system to a USB flash drive.

7.11 Startup Configuration

You can set the configuration adopted by the monitor when it restarts.

But after the monitor powers off, the configurations are set according to the following rule: If restarted within 120s after powering off, the monitor automatically uses the latest configurations; if restarted 120s later after powering off, the monitor uses the configurations according to [Startup Configuration].

7.12 Record Settings

Record settings include the following items:

- ◇ [RT Record Time]:set the real-time record time, including 3s, 5s, 8s, 16s,32sand[Continual].
- ◇ [Paper Speed]: set the paper speed, including 6.25mm/s, 12.5mm/s, 25mm/s and 50mm/s.
- ◇ [Actual Charge Energy]:switch [ON] or[OFF]. [ON] means the actual delivered energy will be recorded

on record paper when recording shock events.

- ✧ [Grid]: switch [ON] or [OFF]. [ON] means recording with grid.
- ✧ [Auto Record]: the following reports and events will be recorded automatically when they are triggered if they are set to [ON]: [Charge Event], [Shock Event], [User Event] and [Auto Check Report].

7.13 Test Settings

- ✧ [User Test Prompt]: switch [ON] or [OFF]. [ON] means the monitor will give a prompt when the user test is overdue.
- ✧ [Auto Test Time]: set the time when the monitor conduct daily auto test. Available test time includes 0:00, 1:00, 2:00, 3:00, 4:00 and 5:00.

7.14 Network Settings

In this menu, users can set the network card number, IP address, subnet mask, server IP, Server Port, Gateway and MAC address.

When the connection is successful, the message prompt area at the bottom of the screen prompts [CMS Connected]. See " Connection to Central Monitoring System " for details.

Chapter 8 Monitor Screen

8.1 Standard

Standard screen can display waveforms of up to 4 channels with separate parameter display area based on the maximum configuration. The waveform on each channel is not fixed and you can change the position of each waveform as needed.

Switch to monitor mode and open the standard screen as shown below:

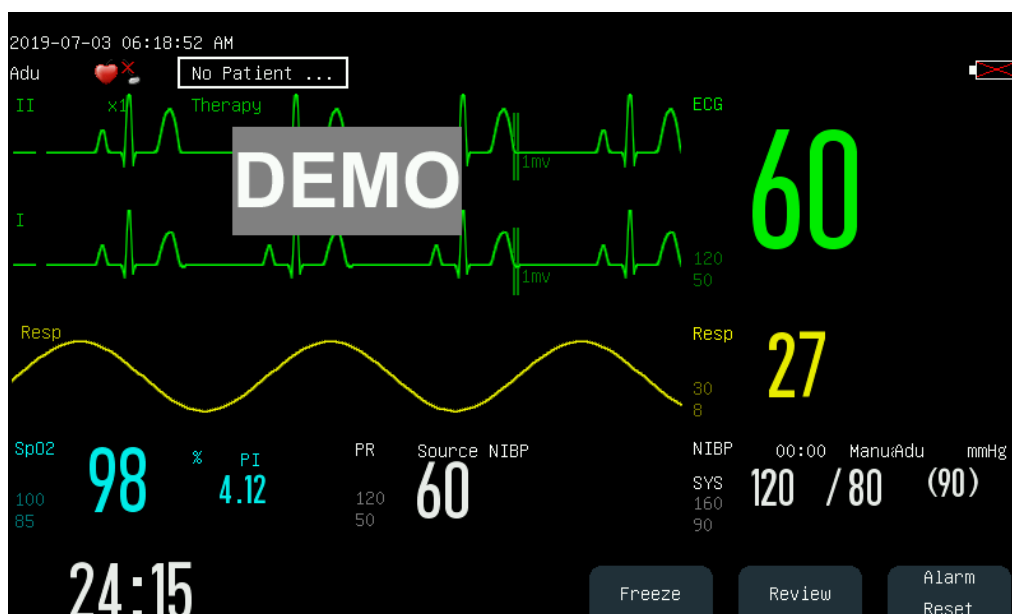

On standard screen, the three soft button labels are [Freeze], [Review] and [Alarm Reset].

8.2 Set Screen Style in Monitoring Mode

You can set the screen style as needed, such as:

- 1) Wave sweep speed.
- 2) Wave style.
- 3) Color of parameters and waves displayed.
- 4) Parameters shown on the screen.

You can set the screen style for all parameters using the same method described in this section.

8.2.1 Set Wave Sweep Speed

- 1) In the [Standard] screen, select the waveform. For example: Select the ECG wave [II] or [I] → [ECG

Wave] → [Sweep].

- 2) Select the appropriate sweep speed.

8.2.2 Set Wave Style

Enter [User Maintain] → [Wave Type] → [Thin],[Med] (Medium) or [Bold].

8.2.3 Set Module Color

- 1) Enter [User Maintain] → [Module Color].
- 2) In the [Module Color] menu, you can select a waveform and set its color to: red, orange, yellow, green, cyan, blue, purple or white.

8.2.4 Set Wave Draw

Enter [User Maintain] → [Wave Draw] → [Color], [MONO].

8.2.5 Set Wave Fill

- 1) Enter [User Maintain] → [Wave FillSetup].
- 2) Select the parameter as needed.

8.2.6 Change Screen Layout

Enter [Main Menu] → [Screen Layout].

In the [Standard] window, you can set parameters and waveforms displayed on the screen. For detailed settings of [Screen Layout], refer to the “*Screen Setup*” section.

Chapter 9 Alarm

When a patient under monitoring or therapy as abnormal vital signs, or when failure occurs in the monitor, the system sounds audible and visual alarm to remind the user.

When there are multiple alarms and prompt messages, messages scroll in a cycle.



Warning

- Use of different configuration on different monitors in one area (e.g., ICU or OR) may affect patient's safety.
- Before monitoring the patient, make sure that the alarm limit is applicable to the current patient.

9.1 Alarm Type

Alarms generated by the monitor are classified into physiological and technical alarms.

◆ Physiological alarm

A physiological alarm is generated when a certain physiological parameter of the patient is beyond the high/low alarm limit or the patient has physiological disorder. Physiological alarm messages are displayed in the physiological alarm area in the upper part of the screen.

◆ Technical alarm

A technical alarm is triggered when the monitor does not operate normally or the monitoring result is unreasonable due to improper operation or system failure. A technical alarm message is displayed in the technical alarm area in the upper part of the screen.

NOTE: In addition to physiological and technical alarms, the monitor also shows messages about system status. Generally, these messages shown in the system message area are not related to vital signs of the patient.

9.2 Alarm Level

Physiological and technical alarms are classified into high, medium and low-level alarms by severity.

	Physiological alarm	Technical alarm
High-level alarm	The patient is in life-threatening situation (i.e. asystole, ventricular fibrillation/ventricular tachycardia). An emergency treatment may be required.	Serious machine failure or mishandling may not be able to detect the patient's critical state or cause the treatment function to fail, making it life-

		threatening, such as low battery.
Medium-level alarm	Abnormality is detected in the patient's vital signs; treatment measures are taken promptly.	Some machine malfunctions or mishandling may not threaten patient safety, but may also affect normal monitoring of critical physiological parameters and patient treatment.
Low-level alarm	Abnormality is detected in the patient's vital signs; treatment may be necessary.	Some equipment failures or mis-operation may result in certain malfunctions, but will not endanger the patient's safety.

The levels of all technical alarms (except ECG and SpO₂) and some physiological alarms have been set before delivery of the monitor and cannot be changed by the user. The levels of some physiological alarms can be modified.

9.3 Alarm Mode

When an alarm is generated, the monitor uses the following alarm modes to alert the user:

Alarm Lamp

Audible Alarm

Alarm Message

Flashing Parameter

9.3.1 Alarm Lamp

Alarm indicators at the upper left corner of the monitor indicate alarm levels with different light colors and flashing frequencies.

Physiological Alarm:

High-level: Red (Left light), flashing.

Medium-level: Yellow (Left light), flashing.

Low-level: Yellow (Left light), consistently on.

Technical Alarm:

High-level: Red (Left light), flashing.

Medium-level: Yellow (Left light), flashing.

Low-level: Cyan (Right light), consistently on.

9.3.2 Audible Alarm

The monitor indicates alarm levels with alarm sounds with different intervals.

High-level: beep-beep-beep--beep-beep---beep-beep-beep--beep-beep

Medium-level: beep-beep-beep

Low-level: beep



Warning

- **Both the monitor and the CMS (Center Monitoring System) are provided with audible alarm function.**
- **When this monitor is connected to the CMS, you can use the same high and low alarm limits for the monitor and CMS. If you enable alarm delay on this monitor, it will not display when CMS indicates an alarm.**
- **When multiple alarms of different levels are generated simultaneously, the monitor will activate the warning sound and light for the highest level alarm.**
- **Certain physiological alarms, such as asystole and respiratory arrest, are exclusive. The sound and light expression of this type of alarm is the same as that of the high-level alarm, but the alarm information is displayed in an exclusive manner, that is, when the general physiological alarm and the exclusive physiological alarm occur simultaneously, only the text alarm information of the exclusive physiological alarm is displayed.**

9.3.3 Alarm Message

Alarm messages are shown in the physiological alarm area or technical alarm area on the screen.

Different background colors are used to indicate the alarm levels:

High-level: Red

Medium-level: Yellow

Low-level: Yellow (Physiological Alarm)/ Cyan (Technical Alarm)

Different marks are added in front of alarm messages to indicate the alarm levels:

High-level: ***

Medium-level: **

Low-level: *

9.3.4 Alarm Parameter Flashing

When a parameter value is outside the alarm limit, the parameter and its high/low limits flash every second, indicating the measured result is beyond the high or low limit.

9.4 Set Alarm Volume

9.4.1 Set Minimum Alarm Volume

Do not set the minimum alarm volume too low; otherwise you cannot hear the alarm sound. This may put the patient safety into danger. Follow the steps below to set the minimum alarm volume:

- 1) Enter [User Maintain] → [Alarm Setup] → [Min. Alm Volume].
- 2) Set the appropriate value.



Note

- **When the alarm volume is turned down, the alarm sound may be hard to be heard. Set the minimum alarm volume should be higher than environmental noise.**
- **The pressure level of alarm sound generated by this monitor is 45-85db.**

9.4.2 Set Alarm Volume

- 1) Enter [Main Menu] → [Volume Setup] or [Alarm Setup].
- 2) Select [Alm Vol] in the pop-up menu.
- 3) Select the volume within the range of X~10. X represents the lowest volume, which depends on the setting of minimum alarm volume.

When the alarm volume is set to 0, the  icon is shown in the message prompt area of the screen, indicating the sound is off.

- 4) Enter the [User Maintain]→ [Alarm Setup]. You can also set the alarm volume of high-level and medium-level alarm respectively by entering the value in[High Alarm] and [Medium Alarm]based on the setting in[Alm Vol].



Warning

- **When the alarm volume is set to 0, the monitor cannot sound an alarm even if a new alarm is generated. Therefore, you should consider this when setting the alarm volume to 0.**
- **Do not rely only the audible alarm. Otherwise, patient safety may be at risk if the alarm volume is low. Pay close attention to the patient's actual clinical conditions.**
- **Maximum alarm volume is no more than 10.**

9.4.3 Set Alarm Reminder

When the alarm volume is set to 0 the monitor provides periodic prompt tone to remind that there is an activated alarm in the system. Follow the steps below to set alarm reminders.

- 1) Enter [User Maintain] → [Alarm Setup].
- 2) Switch [Alarm Reminder] to [ON] or [OFF].
- 3) Select [Reminder Interval]: [1 Min], [2 Min] or [3 Min].

Select [Reminder Volume]: set it to a value between 1 (the minimum volume) ~10 (the maximum volume).

9.5 Set Parameter Alarm

Warning

- When setting alarm limits to extreme values, the alarm system may be useless.
- When setting high and low alarm limits, make sure the patient type is correct (ADU, PED or NEO).
- If you have set the high and low alarm limits manually, the monitor will display these high and low alarm limits instead of the default alarm limits of the system.
- If power-off accidentally occurs, the equipment retain the latest setting for 120s. After 120s, the monitor sets the configurations according to [Startup Configuration] when restarts.

Note

- When applying factory default configurations, alarm limits of the parameters will also change. See “Default Configurations” for details.

9.5.1 Set Alarm Limit



Colors of Alarm Limits

- ◆ Red represents high-level alarms
- ◆ Yellow represents medium-level alarms
- ◆ Cyan represents low-level alarms



Intelligent alarm gradation is a characteristic of the alarm system. For parameters of intelligent alarm gradation, you can simultaneously set the alarm limit ranges of high, medium and low-level alarms without setting alarm levels. When the measured parameter value is outside the normal range, the monitor automatically recognizes which alarm range the measured parameter value belongs to, and then will generate an alarm of the corresponding level.

For parameters of general alarms, you need to set the alarm level and only set the alarm limits corresponding to the alarm level selected. When the measured parameter value is beyond the normal range, the monitor will generate an alarm according to the alarm level selected. Intelligent alarm gradation is available on ECG, NIBP, PR, AwRR and SpO₂ (excluding NellcorSpO₂) and not other parameter.

For parameters subject to intelligent alarm gradation, the procedures to set alarm limit are the same. For example:

- 1) Select the ECG parameter area to enter the setup menu → [Alarm Limit Setup].
- 2) Set the appropriate high and low limits for the parameter.
- 3) Switch the alarm ON/OFF icon  to [ON].
- 4) When setting is finished, select the confirm key .

For parameters subject to general alarms, the procedures to set alarm limit are the same. For example:

- 1) Select the RESP parameter area to enter the setup menu → [Alarm Limit Setup].
- 2) Select the check box  at the lower left corner of the setup window of the corresponding parameter to toggle the alarm level.
- 3) Set the appropriate high and low limits for the parameter under the current level.
- 4) Switch the alarm ON/OFF icon  to [ON].
- 5) When setting is finished, select the confirm key .

9.5.2 Set Auto Alarm Limit

The monitor can automatically set the Alarm Limits for the currently measured parameters according to the patient type.

Before applying these alarm limits, make sure they are appropriate for the patient. If inappropriate, you need to manually set the alarm limits.

Follow the steps to set auto alarm limit:

Enter [User Maintain] → [Alarm Setup] → [Alarm Limit Setup] → [Auto Alarm Limit].

9.6 Set Alarm Delay

The system provides five options for parameter alarm delay: [Not Allowed], [5s], [10s], [15s] and [20s]. If [Not Allowed] is selected, when the measured parameter is beyond the alarm limit, the monitor gives alarm immediately. If [5s]/[10s]/[15s]/[20s] alarm delay is selected, the monitor gives alarm when the measured parameter value has been consistently beyond the alarm limit for 5s, 10s, 15s, 20s, respectively.

NOTE: Alarm delay cannot be applied to ECG.

Follow the steps to set alarm delay time:

- 1) Enter [User Maintain] → [Alarm Setup] → [Alarm Delay].
- 2) Set the appropriate delay time.

9.7 Set Alarm Recording



If the monitor is equipped with a recorder, the monitor recorder will print the parameter waveform and value, if all the following conditions are satisfied: a parameter value is abnormal, the alarm switch is turned on, and [Alm Record] is set to on.

- 1) Enter [Main Menu] → [Alarm Setup] → [Alarm Record Setup].
- 2) Set [Alm Rec Time] to [8s].
- 3) To activate alarm recording for a parameter, switch the alarm record icon  to [ON]; to activate alarm recording for all parameters, select [All Rec. On].

You can switch the alarm record icon  to [OFF] to deactivate alarm record of one specific parameter; to deactivate all parameter alarm records, select [All Rec. Off].

9.8 Alarm Pause

To quickly enter the alarm pause status, press the  key on the control panel. When alarm is paused, the followings occur:

- ◇ Alarm sound, alarm light and alarm message are disabled for physiological alarms, and no physiological alarms will be triggered.
- ◇ The physiological alarm message area shows the prompt message “Alm Pause XXXs”.
- ◇ Alarm sound and alarm light are disabled for technical alarms; if a new technical alarm is triggered, only text prompt will be given.
- ◇ In the event of the battery too low alarm, this alarm will exit the alarm pause status and automatically resume the sound, light and message.
- ◇ The  key on the front panel turns red.
- ◇ There will be  icon displayed in the icons area.

After the alarm pause time expires, the monitor cancels alarm pause automatically; you can press the  key to cancel alarm pause.

To set alarm pause time, follow:

- 1) Enter [User Maintain] → [Alarm Setup] → [Alm Pause Time].
- 2) Set the appropriate pause time: [1min], [2min], [3min], [5min], [10min], [15min].

9.9 Alarm OFF

Only physiological alarms can be turned off. When alarm is turned off, the sign  is shown on the left side below the corresponding parameter in the parameter area:

- ✧ For physiological alarms, sound, light and text prompts are disabled, and no new physiological alarms will be triggered.
- ✧ No measured parameter value and alarm limit flash

Follow the steps to turn alarm off:

- 1) Select the parameter value area, and the setup menu displays. Then select [Alarm Limit Setup].
- 2) Select [All Alm Off] to disable alarms against all parameters. If the alarm ON/OFF icon  of a parameter is switched to [OFF], alarms for that parameter are disabled.

To turn on the alarms of all parameters, select [All Alm On]; to turn on the alarm of one parameter, switch the alarm ON/OFF icon  of that parameter to [ON].



Warning

- **If the alarm is turned off, the monitor cannot provide alarm indications when the parameter is in an alarm condition. Therefore, you should be careful turning the alarm off.**

9.10 Alarm System Off

The alarm system is disabled by default when entering the manual defibrillation mode or AED mode. The monitor provides periodic prompt tone to remind that the alarm system is disabled.

After entering the synchronous defibrillation mode, monitoring mode or pacing mode, the alarm system is automatically turned off.

9.11 Alarm Reset

You can reset the current alarm with the [Alarm Reset] soft key:

- ✧ Cease the audio alarm indication of all physiological alarms and technical alarms.
- ✧ If a new alarm occurs, resetting will be interrupted, and the alarm indications are generated immediately.
- ✧ For the technical alarms of leadoff and sensor off, background color is cleared and alarm light is switched off. Other physiological and technical alarms background color and alarm light cannot be cleared.
- ✧ There will be  icon displayed in the icons area.

The sign  appears in front of the alarm message, indicating that the alarm is acknowledged.

9.12 Alarm System Test

After the monitor is turned on, the alarm indicator will light up in cyan and red, cyan and yellow, and the light alarm signal will start working. If the alarm system does not work properly, please contact our engineers in time.

The system can be further tested through SpO₂ or NIBP parameter. For example:

- 1) Connect the SpO₂ cable to the monitor.
- 2) Set the SpO₂ alarm limits to 90% and 60%, respectively.
- 3) Set [Alm Vol] to any level among 0~10.
- 4) When the measured value is beyond the high/low alarm limit, confirm whether the changes in sound, light, message and parameter flashing on the monitor conform to the descriptions in the section ***“Alarm Lamp”***, ***“Audible Alarm”***, ***“Alarm Message”***, and ***“Alarm Parameter Flashing”*** in this chapter. Meanwhile, the physiological alarm message area shows [SpO₂ Too High] or [SpO₂ Too Low].
- 5) Pull out the SpO₂ sensor from the monitor; the technical alarm message area shows [SpO₂ Finger Off].

Chapter 10 PR Setup

10.1 Overview

Mechanical activity of the heart causes artery pulse. PR value can be obtained by measuring the pulse. Color of the PR parameter area is consistent with the color in which the parameter of PR source is shown.

10.2 PR Source

Select the PR parameter area to enter the setup menu, where you can set PR Source.

[SpO₂]: Display the pulse rate value from SpO₂;

[NIBP]: Display the pulse rate value from NIBP;

10.3 Alarm Limit Setup

Select the PR parameter area to enter the setup menu, where you can carry out alarm limit setup.

11.1 Definition of ECG Monitoring

Electrocardiography (ECG) monitors continuous electrical activity of the patient's heart, which is reflected on the monitor in the form of wave and value, to accurately assess the current physiological status of the patient. Therefore, you must make sure the ECG cables are connected properly to obtain correct measurement values. The monitor is suitable for three-lead or five-lead monitoring. It can also be used for ECG monitoring using external defibrillation electrode paddles and multi-functional electrode pads. Different waveforms are displayed according to ECG cables of different leads.

11.2 Precautions for ECG Monitoring



Warning

- **During defibrillation, do not contact the patient, table or equipment.**
- **Before monitoring, ensure that ECG cable is properly connected. If the ECG cable is disconnected from the connector, the monitor displays the prompt message “ECG Lead Off” and sounds an alarm.**
- **Use only ECG electrodes and cables specified by Comen.**
- **The ECG cable with defibrillation-proof protection should be used when conducting defibrillation.**
- **Different metal materials cannot be used for the electrodes.**
- **Do not use if the electrode package or electrode has signs of damage or expires.**
- **Please do not mix electrodes of different types and brands. Mixing the electrodes may result in a large baseline drift or a longer recovery time after defibrillation.**
- **When connecting the electrodes or patient cable, ensure that the patient does not come into contact with any other conductive parts or the ground. Confirm that all ECG electrodes (including neutral electrode) are attached the patient's body.**
- **Check whether the ECG electrode patch or paddle has irritation to the skin every day. If there is any sign of allergy, replace the electrode or paddle or change its position.**
- **Pacemaker fault: When cardiac conduction is completely blocked, or the pacemaker cannot be moved away, P wave ($> 1/5$ of the mean height of R wave) may be wrongly recorded by the monitor, causing failure to monitor an asystole.**
- **Equipment such as defibrillator and remote measurement unit can generate a filtered ECG signal. When this signal is used as the input signal for the monitor, it is filtered again. If such**

signal after second filtering is transmitted to the arrhythmia algorithm, it may cause failure to detect such conditions as pacemaker pulse, pacemaker capture failure or asystole. This failure degrades the performance of the equipment when it is used for monitoring patients with pacemakers.

- During defibrillation, the ECG cable connected to the patient may get damaged. When reusing such cables, you should check that function properly.
- If electrodes are used correctly and attached according to the manufacturer's instructions, the ECG parameter on monitor screen recovers within 5s after defibrillation. For electro surgery or defibrillation, the measurement accuracy may be reduced temporarily, but this accuracy will not affect the safety of the patient or the equipment.
- When the monitor is connected to an electrosurgical unit (ESU), in order to protect the patient from injury caused by leakage current, do not put the sensors and cables of the equipment in contact with the ESU.
- Do not expose the monitor to X-ray and high-intensity magnetic fields.
- Do not use the electrode when exceed the validity period.



Note

- Interference from ungrounded equipment near the patient, as well as ESU interference may result in a waveform problem. If the monitor is operated under conditions specified in EN60601-1-2 (radiation resistance: 3V/m), electric field intensity over 1V/m may cause measurement errors at different frequencies. Therefore, it is suggested not to use any electric radiation equipment in a place near the monitor if ECG/RESP is being measured.
- If the ECG electrode is correctly placed but the ECG waveform is still inaccurate, replace the leads.
- To protect the environment, recycle and dispose used electrode patches appropriately.
- Do not use external paddles to conduct ECG monitoring.
- If the source of the selected ECG signal is not available, the ECG waveform will be shown as a dotted line.

11.3 ECG Display

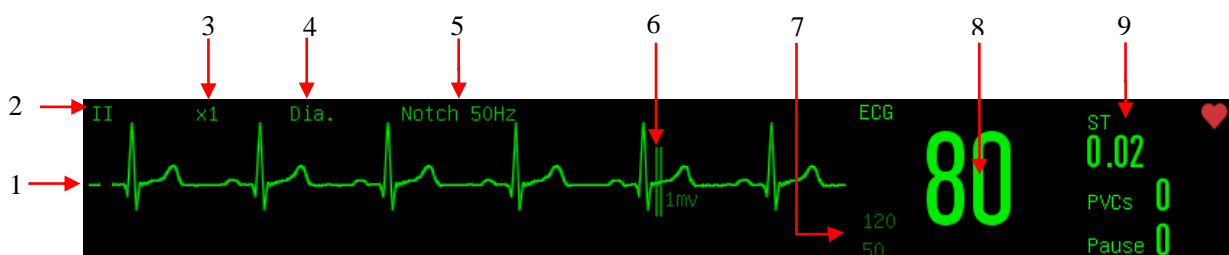

 **Attention**

- **The pacing signal detected will be shown as “|” in the ECG waveform.**

1. ECG waveform
2. ECG lead name
Select the lead name and rotate the knob to switch ECG lead name.
3. ECG wave gain
Select the gain and rotate the knob to switch ECG wave gain.
4. Filter mode
Select the filter mode and rotate the knob to switch the filter mode.
5. Notch status
6. 1 mV Scale
7. ECG alarm limit
8. ECG value
9. PVCs and ST-I analysis
Display the current analysis state of PVCs and ST segment with the refresh rate of once per second.

11.4 Monitoring Steps

- 1) Do skin preparation. Refer to Section “*11.4.1 Prepare Skin*”.
- 2) Place ECG electrodes. Refer to Section “*11.4.2 Install ECG electrodes*”.
- 3) Connect ECG cable to the defibrillator monitor, then the monitor start to monitor ECG.

11.4.1 Prepare Skin

Skin is a poor conductor. Therefore, to achieve good contact between electrodes and skin, it is very important to prepare the patient’s skin:

- 1) Choose a skin area without any damage or abnormality.
- 2) When necessary, shave body hair at positions where electrodes will be placed.
- 3) Use soap water to thoroughly clean the skin. (Do not use diethyl ether or pure alcohol because these substances may increase the skin impedance).
- 4) Air-dry the skin completely.
- 5) Use ECG preparation paper and gently rub the skin, so as to remove dead skin and improve the conductivity at the position where the electrode is attached.

11.4.2 Install ECG electrodes

The table below lists the names of leads in European and American standards. (RA, LA, RL, LL and V are used to represent leads in American standards, whereas R, L, N, F and C are used in European standards):

See table below for marks and color codes of 3-lead and 5-lead electrodes:

U.S.A. Standard		EU Standard	
Mark	Color	Mark	Color
RA	White	R	Red
LA	Black	L	Brown
LL	Red	F	Green
RL	Green	N	Black
V	Brown	C	White

11.4.2.1 Place 3-lead Electrodes

Refer to American and European standards for placing electrodes of 3-lead unit:

White/red (right arm) electrode — Place it below the clavicle, near the right arm.

Black/yellow (left arm) electrode — Place it below the clavicle, near the left arm.

Red/green (left leg) electrode — Place it at the left lower abdomen

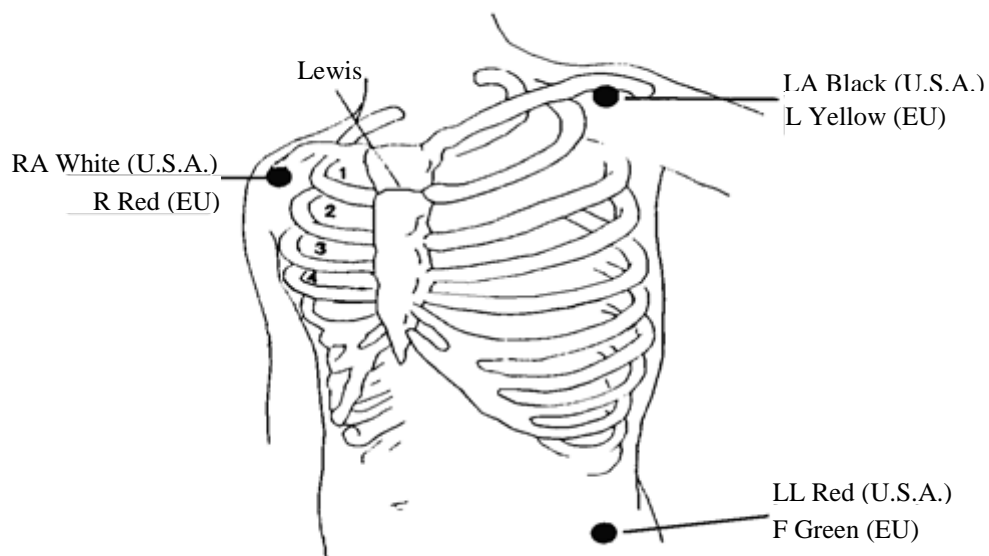

11.4.2.2 Place 5-lead Monitoring Electrodes

Refer to American and European standards for placing electrodes of 5-lead unit:

White/red (right arm) electrode — Place it below the clavicle, near the right arm.

Black/yellow (left arm) electrode — Place it below the clavicle, near the left arm.

Green/black (right leg) electrode — Place it at the right lower abdomen

Red/green (left leg) electrode — Place it at the left lower abdomen

Brown/white (chest) electrode — Place it on the chest wall according to the following figure.

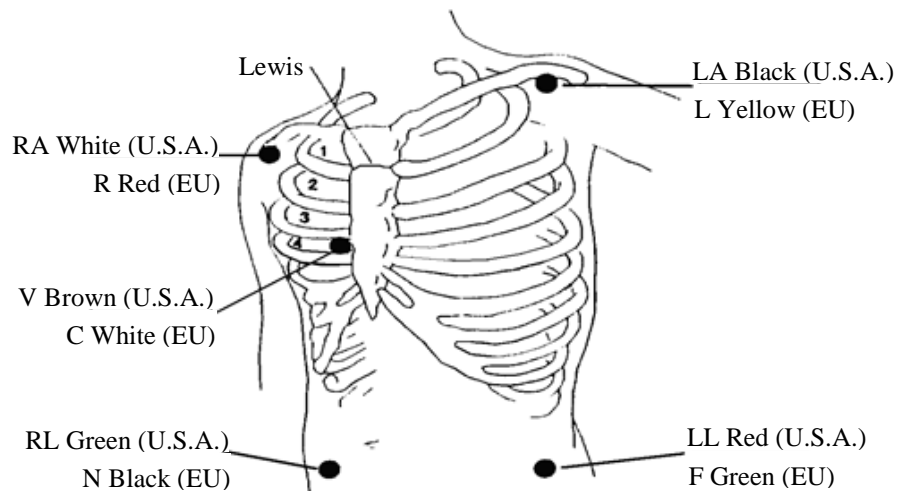

For 5-lead configuration, place the chest (V) lead electrode at one of the following positions:

V1: 4th intercostal space, at the right sternal border.

V2: 4th intercostal space at the left sternal border.

V3: In the middle position between V2 and V4.

V4: 5th intercostal space at the left midclavicular line.

V5: In the left anterior axillary line, just parallel to V4.

V6: In the left midaxillary line, just parallel to V4.

V3R-V6R: On the right side of the chest wall, corresponding to the left-side position.

VE: At the xiphoid eminence position.

V7: 5th intercostal space in the left posterior axillary line at the back.

V7R: 5th intercostal space in the right posterior axillary line at the back.

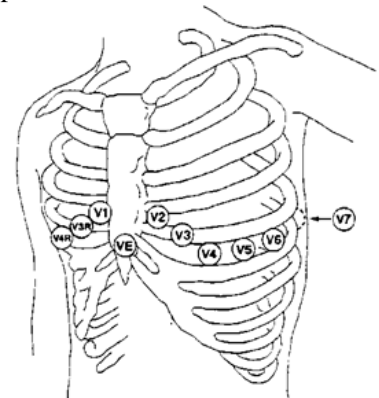

11.4.2.3 Recommended ECG Lead Connection for Surgical Patient



Warning

- **When using an ESU, never place electrodes close to the ground plate of the ESU; otherwise there is too much interference against the ECG signal.**
- **When the monitor is connected to an electrosurgical unit (ESU), in order to protect the patient from injury caused by leakage current, do not put the sensors and cables of the equipment in contact with the ESU.**

The placement of ECG lead depends on the type of operation to be performed. For example, when a thoracotomy is to be performed, the electrode can be placed on the side of the chest or on the back. In the OR, artifacts may affect ECG waveform due to the use of an ESU. In order to reduce artifacts, the electrodes can be placed at the left and right shoulders, close to the left and right sides of the abdomen; the chest lead can be placed left to the middle of the chest. Avoid placing the electrode on the upper arm, or the ECG waveform may become very small.



Note

- **When monitoring the patient with pacemaker, [Pace] must be set to [On]. If it is set to [Off], pacemaker pulses may be counted as QRS complex, resulting in failure to detect asystole. When changing patient info or admitting/discharging a patient, check whether [Pace] is set correctly.**
- **When monitoring the patient with pacemaker, sometimes a part of pacemaker pulses cannot be shielded. If pacemaker pulses are counted as QRS complex, it results in wrong heart rate computation and failure to detect asystole or some arrhythmias. At this point, closely observe the patient.**

11.4.3 Placement of Pads or External Paddles

11.4.3.1 Operating Steps

- 1) Do skin preparation. Refer to Section 11.4.1 Prepare Skin.
- 2) Place external paddles or pads. Refer to Section 11.4.3.2 Anterior-Lateral Placement.
 - For pads: place pads on patient in the anterior-lateral position according to the indication on the packaging.
 - For external paddles: hold the handle of paddles with two hands and take the paddles out from the paddle tray. Apply some conductive gel to the paddles and place them on patient in the anterior-lateral position.
- 3) For pads: connect pads with pads cable.

- 4) Connect paddles cable or pads cable to the defibrillator monitor until the “click” is heard, then the monitor start to monitor ECG.

11.4.3.2 Anterior-Lateral Placement

1. Place the RA pad or Sternum paddle on the patient’s upper right torso, lateral to the sternum and below the clavicle, as shown below:
2. Place either the LL pad or Apex paddle lateral to the patient’s left nipple in the midaxillary line, with the center of the electrode in the midaxillary line, as shown below:

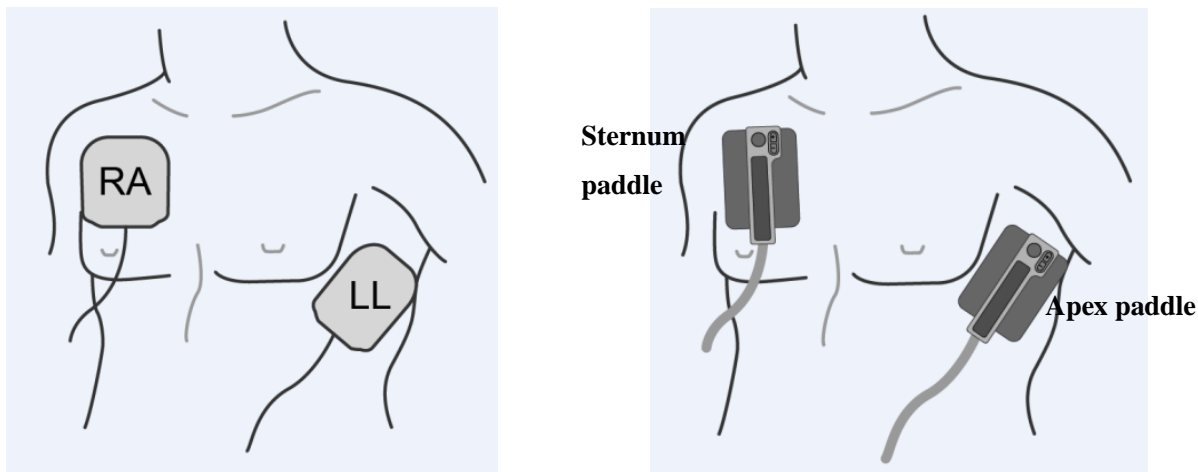



⚠ Attention

- When conducting ECG monitoring, the external paddles and pads can only be placed in the anterior-lateral position.

11.5 ECG Setup

11.5.1 Checking the Pacing Status

It is important to properly set the patient's pacing status before starting ECG monitoring. When [Pace] is set to "On" and the pacing signal is detected, it is indicated by **I** on the ECG waveform and  symbol in the patient information area; when the pacemaker is set to "Off",  is only prompted in the patient information area and the pacing pulse is filtered out.

You can change the pacing status in any of the following ways:

- Select the interface patient information area to enter the [Patient Info] menu and set [Pace] to On or Off.
Or;
- Select [Main Menu] → [Patient Info] and set [Pace] to On or Off in the pop-up menu.
Or;

- Select the ECG parameter area to enter the ECG setting menu, then select [Other Setup] and set [Pace] to On or Off.

**Warning**

- For the patient without pacemaker, [Pace] must be set to [OFF]. Otherwise, the system cannot detect arrhythmia related to ventricular premature beats (including PVCs count), and ST segment analysis will not be carried out.
- If the patient is admitted with a pacemaker, [Pace] should be set to [ON]. Otherwise, pacemaker pulse may be counted as normal QRS wave, resulting in failure to detect the [ECG Lost] alarm.

11.5.2 Set Lead Type

ECG cables with different leads can be used to monitor different ECG waveforms. You can use the 3-lead and 5-lead ECG cables with the monitor.

When the 3-lead ECG cable is used, leads for monitoring include I, II and III. In the standard screen, ECG wave of at most 1 lead is displayed.

When the 5-lead ECG cable is used, leads for monitoring include I, II, III, aVR, aVL, aVF and V. In the standard screen, ECG wave of at most 2 leads are displayed.

When the lead type of the monitor is set to [Auto], the monitor automatically recognizes the leads for monitoring.

Set the lead type for the ECG cable of the monitor:

- 1) Select the ECG parameter area to enter the setup menu → [Lead Type] → [3 Leads], [5 Leads] or [Auto].

11.5.3 Smart Lead Off

When [Smart Lead Off] is ON, if the lead of the current channel comes off, the monitor automatically switches to a channel where the lead is not off. When the lead that comes off is reconnected, the monitor automatically switches back to the original channel.

Enable or disable this function:

- 1) Select the ECG parameter area to enter the setup menu → [Other Setup].
- 2) Select [Smart Lead Off], and switch it to [ON] or [OFF].

11.5.4 Set Alarm Level for Lead Off

Enter [User Maintain] → [Alarm Setup] → [ECG Lead Off Level].

11.5.5 Set Lead Name for Monitoring

In the standard screen, when 3 Leads is selected as the lead type, only one ECG wave is displayed; when 5 Leads is selected, two ECG waves are displayed.

- 1) Select the ECG wave to enter the [ECG Wave] menu → [Lead Name]
- 2) Select the lead for monitoring, such lead as [II].

11.5.6 Set Wave Gain

If the wave size is too big or too small, you can change the displaying size of wave by setting the gain. The gain setting will not affect ECG signal analysis of the monitor. With the wave and the 1mv scale provided on the right side of the wave, you can obtain the optimal wave.

- 1) Select one ECG wave to enter the [ECG Wave] menu → [Gain] → [$\times 0.125$], [$\times 0.25$], [$\times 0.5$], [$\times 1$], [$\times 2$], [$\times 4$] or [Auto].



Note

- **When the input signal is too strong, the wave crest may be cut off. In such case the user can manually change the gain level of ECG wave according to the actual wave to avoid incomplete wave display.**

11.5.7 Set Filter Mode

Filter Mode: Clearer or more accurate waves can be obtained through filtering. Four filter modes are available.

- In the Diagnosis mode, ECG waves displayed are those without filtering.
 - In the monitor mode, the monitor filters artifacts that may result in false alarms.
 - In the Surgery mode that usually used in the OR, the monitor reduces artifacts and interference from the ESU.
 - In the ST filter mode, the distorted reflection of the ECG signal ST segment of the patient being measured can be guaranteed, and high-frequency interference signal above 40Hz, including power frequency interference, can be filtered effectively. In this mode, user obtains the value of ST segment of the patient being measured by adjusting the position of ST segment analysis point.
 - The filter mode acts on two channels simultaneously, and can be displayed above the first ECG wave.
- 1) Select one ECG wave to enter the [ECG Wave] menu → [Filter Mode] → [Dia.], [Monitor], [Therapy] or [ST].



Warning

- The system provides raw signals only in the diagnosis mode. In the [Monitor] and [Therapy] filter modes, the ECG wave distorts to different degrees. In this case, the system only provides the basic ECG information, which greatly affects the result of ST segment analysis.

11.5.8 Set Computation Lead

You are allowed to select the leads for HR computation and arrhythmia analysis. When setting the lead, make sure that the following wave characteristics in this lead are satisfied:

- Tall and narrow without notch.
- R wave is tall, completely above or below the baseline.
- T wave is less than 1/3 height of R wave.

P wave should be much smaller than T wave.

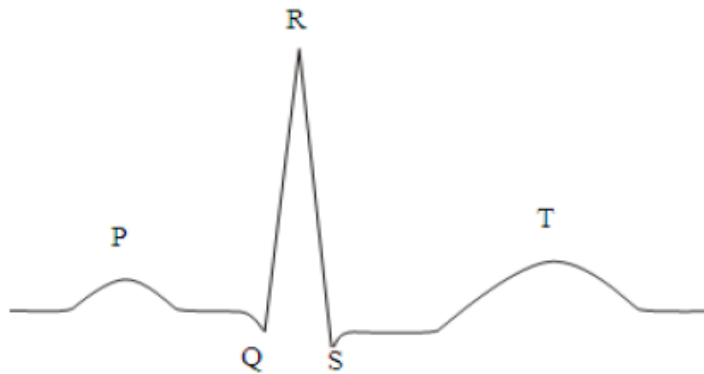

The computation channels are different under different lead types:

The 3 Leads: Lead II, and no other options are provided.

The 5 Leads: Three options are provided: lead I, II and V.

Select a Lead:

- 1) Select the ECG parameter area to enter the setup menu → [Calculate Lead]; set the lead for calculation and arrhythmia analysis.

To obtain 1mV calibrated ECG wave, perform an ECG calibration. For the ECG calibration method, refer to the “*Maintenance*” chapter.

11.5.9 Set Notch Filter

The notch filter removes the line frequency interference. When the filter is not set to diagnosis mode, the system turns on [Notch Filter] automatically. When the filter is set to diagnosis mode, [Notch Filter] can be turned on or off as needed.

- 1) Select the ECG parameter area to enter the setup menu → [Other Setup]

2) Set [Notch Filter] as follows:

[Strength g]: Select it when the wave jitters frequently (e.g., the wave has burrs).

[Weak]: Select it when the wave jitters in a few times.

[Off]: Notching will not be performed.

Set notch frequency according to the electric power frequency of your country.

1) Enter [User Maintain] → [Other Setup] → [Notch Filter].

2) Select [50Hz] or [60Hz] according to the power supply frequency.





Attention

- **The setting of Notch Filter is not affected by the operation of restoring manufacturer configuration or switching machine.**

11.5.10 Set Pacer Rejection

Select the ECG parameter area to enter the setup menu → [Other Setup]. In the pop-up setup menu, select [Pacer Reject] and switch it to [ON] or [OFF].

When [Pace] is turned on:

- In the condition of [Pacer Reject] being on, the display of pacing signal is inhibited. However, when pacing signal is detected, the pacemaker pulse symbol  is still displayed in the ECG wave.
- In the condition of [Pacer Reject] being off, the display of pacing signal is not inhibited. When pacing signal is detected, the pacemaker pulse symbol  is displayed above the ECG wave.

When [Pace] is turned off, [Pacer Reject] cannot be operated.

11.5.11 HR Source

You can set the HR source to determine whether HR value or PR value is displayed in the ECG parameter area. The HR value color is consistent with the source parameter selected. Select the ECG parameter area to enter [ECG Setup], and set [HR Source] as follows:

- [ECG]: The ECG parameter area displays the HR value, and the heartbeat sound is provided.
- [SpO₂]: The ECG parameter area displays the pulse rate value from SpO₂, and the pulse sound is provided.

11.5.12 Multiple Lead Analysis

When [Mul. Lead Analysis] is turned on, the ECG setting of [Calculate Lead] become invalid. The module intelligently selects the lead with good ECG wave for HR computation calculation.

- 1) Select the ECG parameter area to enter the setup menu→[Other Setup].
- 2) Select [Multi. Lead Analyse], and switch it to [ON] or [OFF].

11.5.13 Cascade

Cascade is for user to observe the designated real-time ECG waveform for a long period of time. The Cascade screen shows a cascade waveform of the same lead. In any working mode of the monitor, you can select ECG waveform and turn on [Cascade]in the pop-up[ECG Wave]. The number of cascade waveforms displayed depends on the number of ECG waves present in the current screen. The operation over one of the ECG waves also applies to other ECG waves.

11.6 ST Segment Analysis

11.6.1 About ST Segment Analysis

Normal heartbeat and atrial pacing heartbeat are used in ST segment analysis. The monitor analyzes these heartbeats and calculates the elevation and depression of ST segment. On the monitor, the calculated data can be displayed as the ST value. All available leads can be monitored continuously. For ST segment analysis, it is unnecessary to display ECG waveform on the monitor. During ST segment analysis, a special filter should be used to ensure the diagnosis quality. If you use an ECG filter mode other than [ST] to monitor ECG, the ST segment of ECG wave may be slightly different in appearance from the ST segment of ST fragment for the same waveform. To perform diagnostic assessment of ST segment, always switch to the [ST] filter mode.

In the ST segment analysis, the elevation or depression of ST segment on the designated lead can be measured. Meaning of ST segment value: A positive number represents elevation; a negative number represents depression.



ST segment measurement range: -2.0 ~ +2.0mV.

11.6.2 Influence Factors on ST Segment

Some clinical situations may result in unreliable ST monitoring. For example:

- Lead of low noise cannot be obtained.
- Presence of arrhythmia (e.g., atrial fibrillation/atrial flutter) that can cause irregular baseline.
- The patient is under continuous ventricular pacing.

of each point.

- The cursor position of ISO point is related to R wave peak equipotential. Use  to locate the ISO point in the middle of the flattest part of baseline (between P and Q waves or in front of P wave).
- The cursor position of J point decides the relative position of J point and R wave peak. This can help user to correctly locate the ST point. Use  to place J point at the end of QRS complex and the beginning of ST segment.
- Locate ST point: Select J+60, J+80 or J+40 to convert the value and move J point to locate ST point in the middle of ST segment.

6) When setting is finished, select “” to exit the window.

11.6.5 ST Analysis Review

This monitor saves 20 groups of ST analysis for reference and review. A ST segment shows a complete QRS wave of all ST leads. The stored data is drawn in white; real-time data is drawn in green. Real-time data of ST segment refreshes every 5s.

Enter [ST Analysis Review]:

- 1) Select the ECG parameter area to enter the setup menu → [ST Analysis]; open [ST Analysis] → [ST Analysis Review].

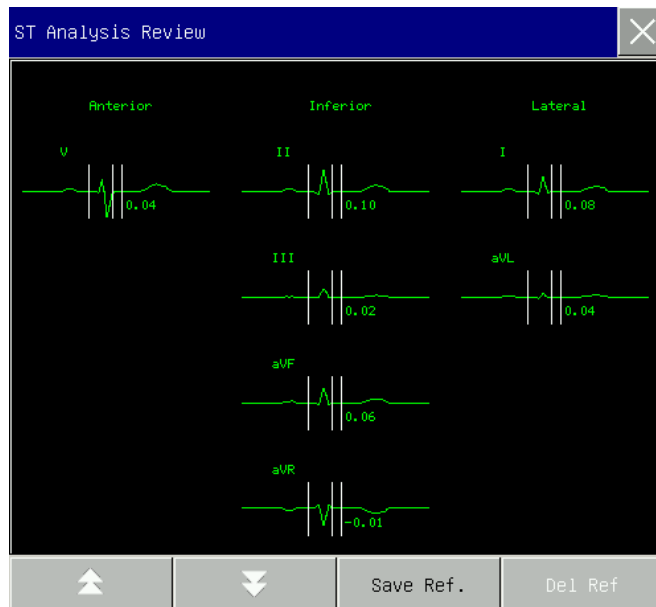

- To save the current ST segment as reference, select [Save Ref.] (Save Reference).
- To delete the current reference segment displayed, select [Del Ref] (Delete Reference).
- To view several groups of ST segments, select  to turn page up and down.

11.6.6 ST Alarm

Select the ECG parameter area to enter the setup menu → [ST Analysis]. Open [ST Analysis] → [Alarm Limit Setup] to set parameter alarm limit. The monitor allows you to set alarm limits for each lead. For operation details, refer to the “*Alarm*” chapter.

11.7 Arrhythmia Analysis

Arrhythmia analysis is clinically used in patient ECG monitoring to detect HR changes and premature ventricular contractions, and to save arrhythmia events and generate alarm messages. Arrhythmia analysis can be used for monitoring patients implanted or not implanted with pacemakers. The doctor can evaluate the patient’s condition (e.g., HR, PVCs (premature ventricular contractions) frequency, rhythm and abnormal heartbeat) according to arrhythmia analysis, and make diagnosis and treatment on this basis.

The arrhythmia monitoring is set off by default. You can enable this function as needed.

The arrhythmia monitoring can measure and classify arrhythmia and abnormal heartbeat, as well as reminding the doctor to observe the patient’s heart rhythm and events that generate alarms.

11.7.1 Arrhythmia Analysis On/Off

- 1) Select the ECG parameter area to enter the Setup menu → [Arr Analysis].
- 2) Select [Arr Analysis], and switch it to [ON] or [OFF].

11.7.2 Arrhythmia Alarm Setup

- 1) Select the ECG parameter area to enter the setup menu → [Arr Analysis].
- 2) Turn on [Arr Analysis].
- 3) Select [Arr Alarm Setup] to enter the [Arr Alarm Setup] window. In the [Arr Alarm Setup] window, you can restore the settings, switch alarm on/off, set alarm level and switch record on/off or the alarms of [Asystole], [Vfib], [R ON T], [VT>2], [Couplet], [PVC], [Bigeminy], [Trigeminy], [SVT], [Brady] (Bradycardia), [Pacer Not Capture], [Pacer Not Pacing], [Missed Beat], [IHB] (Irregular Heart Beat), [Vtac] (Ventricular Tachycardia), [Tachy] (Tachycardia), [PVCs Too High], [Extreme Tachy], [Extreme Brady], [Vent. Rhythm], [Heart Pause], [Vent. Brady], [Multif. PVCs Window], [Nonsus. Vtac], [Afib] and [Pause/min]. Select [Restore] to restore equipment to factory settings for the monitor.

NOTE: The alarm level and alarm on/off status of [Asystole], [Vfib], [Vtac], [Extreme Tachy], [Extreme Brady] and [Vent. Brady] are in default, which cannot be changed by the user.

◆ **When using multi-functional electrode pads and electrode paddles for ECG monitoring, only five**

arrhythmia alarms, Asystole, Vfib, Vtac, PNP, and PNC, are provided, and only Asys. Delay and Vtac Rate threshold settings are provided.

Attention

- Asystole, Vfib, Vtac, Vent. Brady, Extreme Tachy, and Extreme Brady are exclusive high-level alarms. For Asystole alarms, regardless of whether the arrhythmia analysis is turned on, an alarm is triggered as long as the alarm condition is met.

11.7.3 Arrhythmia Threshold Setup

You can set the threshold of each arrhythmia by selecting [ECG] in the parameter area, and then in the pop-up [ECG Setup] menu, enter the [ARR Analysis] menu. The parameter ranges are shown as below:

No.	Arrhythmia Type	Setup Range	Default Value	Step	Unit
1	PVCs	0-31	10	1	PCS
2	Tachycardia	ADU: 60-160 PED:60-180 NEO:60-200	ADU: 120 NEO/PED: 160	1	bpm
3	Extreme Tachycardia	ADU: 120-300 PED:160-300 NEO:160-350	ADU: 160 PED: 180 NEO: 200	1	bpm
4	Extreme Bradycardia	15-40	40	1	bpm
5	Arrest Time	3-10	4	1	s
6	Ventricular Tachycardia HR	100-180	160	1	bpm
7	Ventricular Tachycardia PVC	3-15	12	1	PCS
8	Bradycardia HR	40-120	40	1	bpm
9	Vbrd PVCs	3-99	4	1	PCS
10	Multi. PVC	3-31	15	1	PCS
11	Heart Pause Time	1.5-3.5	2.5	0.5	s
12	Pause/min	1 -15	8	1	min

After setting Arrhythmia Threshold, when a value exceeds this threshold, an alarm will be triggered.

Attention

- The setting of Asys. Delay is associated with ECG self-learning. When the HR is less than 30bpm, it is recommended to set the Asys. Delay to 10 seconds.

11.7.4 Arrhythmia Review

See the “*Alarm Event Review*” chapter.

11.7.5 ARR Relearn

During ECG monitoring, when the ECG template of the patient changes significantly, you may need to start an ARR Relearn. ARR Relearn enables the monitor to learn new ECG templates, thus to correct arrhythmia alarms and heart rhythm values.

- 1) Select the ECG parameter area to enter the Setup menu → [ARR Analysis].
- 2) Select [ARR Relearn]; the system will give the prompt message [ARR Learning].

11.8 ECG Relearn

During ECG monitoring, if the patient's ECG template changes significantly, you may need to manually start an ECG Relearn. Changes in the ECG template may result in:

- ✧ Arrhythmia alarm error
- ✧ ST measurement data loss
- ✧ Inaccurate HR value

Start relearning:

Select the ECG parameter area to enter the setup menu → [Other Setup] → [Relearn].



Caution

- **Start the ECG Relearn during normal rhythm and when ECG signal is not noisy. If you start an ECG Relearn during an arrhythmia period, the monitor may collect the wrong QRS complex as the ECG template.**

Chapter 12 Manual Defibrillation and Synchronized Cardioversion

12.1 Overview

This chapter introduces how to conduct manual defibrillation and synchronized cardioversion by using pads, external paddles.

It is necessary to assess patient's cardiac rhythm correctly and decide whether to conduct asynchronous defibrillation or synchronized cardioversion before manual defibrillation. Select proper energy level to charge the defibrillator. During defibrillation, the screen will display text message to indicate the users how to operate.

In manual defibrillation mode, beside ECG, the monitor can monitor three more physiological parameter. The physiological parameters displayed on the interface can be adjusted through [Screen Layout].

In manual defibrillation mode, if NIBP measurement is being conducted when charging the defibrillator, NIBP measurement will stop. After shock or disarming the defibrillator, NIBP measurement will auto start if NIBP measure mode is auto, while NIBP measurement can be started manually if the measure mode is manual. The alarm is disabled by default when entering the manual defibrillation mode and you can press alarm pause key to enable the alarms.

12.2 Safety Information

Danger

- **Do not conduct defibrillation in the presence of oxygen-rich atmospheres. When conducting defibrillation on the patient with oxygen catheter, place the oxygen catheter properly. Do not put it near the pads to avoid fire and explosion.**
- **During defibrillation, do not allow pads to touch each other or touch ECG electrodes, lead wires, dressings, etc. Otherwise electrical arcing and patient skin burns could be caused.**
- **During defibrillation, do not touch patient and conductive material (including bed and stretcher) connected with the patient to avoid potential injury and death.**
- **During defibrillation, do not touch conductive liquid like saline solution, blood and conductive gel and conductive material like bed and stretcher to avoid forming current path.**
- **Do not use wet hands or the hands with conductive gel to handle the paddles, or the operators may be shocked.**

Warning

- **Do not use liquid conductive agent. Only the conductive gel specified by Comen can be used.**
- **Do not attach the paddles to your body to verify whether the paddles are connected well.**
- **When using the paddles, put the paddles on patient flatly and push them with equal strength. Do not push the paddles with too much strength, or patient could be injured.**
- **Select appropriate defibrillation energy level for children.**
- **During synchronized cardioversion, if ECG waveform is obtained through external paddles, the**

- artifacts caused by paddles' movement may be similar to R wave and trigger defibrillation shock.
- Do not use if the electrode package or electrode has signs of damage or expires.

- ⚠ Caution**
- After therapy, the conductive gel on the paddles should be cleaned immediately to prevent the paddles from corrosion.
 - The medical device which has no defibrillation protection shall be disconnected from the patient during defibrillation.

- ⚠ Attention**
- Too high impedance could have a great impact on patient's therapy. Reduce the impact caused by high impedance to the utmost. When prompt message "Impedance Too High" appears, please check whether patient skin is clean and dry and whether chest hair has been shaved. If the prompt message is still there, please replace pads or pads cable.
 - Alarms are disabled by default when entering asynchronous defibrillation mode with text message "Alarm Off" displayed in physiological alarm message area. You can enable alarms by pressing alarm pause key, entering synchronized cardioversion mode or switching to monitor mode or pacemaker mode.

12.3 Manual Defibrillation Interface

The manual defibrillation interface is shown as follows:

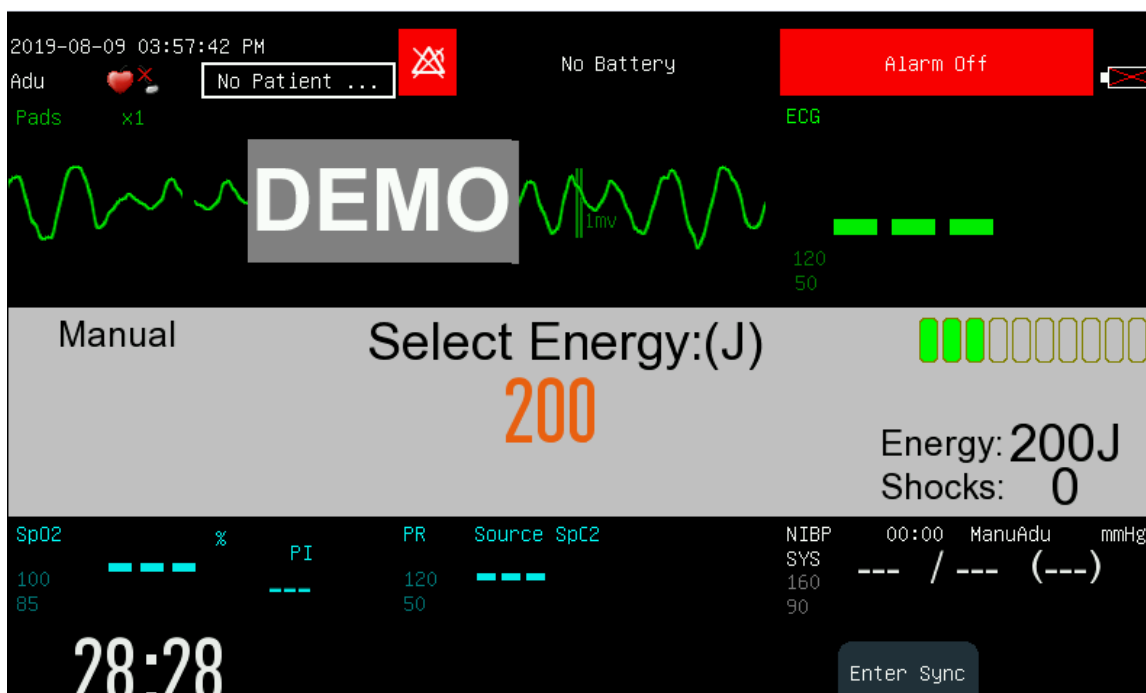

In defibrillation message area at the middle of manual defibrillation interface, such information about manual defibrillation as defibrillation mode, synchronized status, energy level, impedance indicator, defibrillation prompt message, shock times and so on will be displayed.

12.4 Steps of Manual Defibrillation

1. Remove all clothing from patient's chest. Dry patient's chest and do skin preparation if necessary.
2. Choose proper therapy cable and insert it into the therapy cable connector on the right panel of the monitor until a "click" is heard.
3. Place pads or paddles.
 - **Pads:** place pads to the patient in the anterior-lateral position or anterior-posterior position according to the indication on the packaging.
 - **Paddles:** hold the handle of paddles with two hands and take the paddles out from the paddle tray. Apply some conductive gel to the paddles and place them on the patient in the anterior-lateral position.

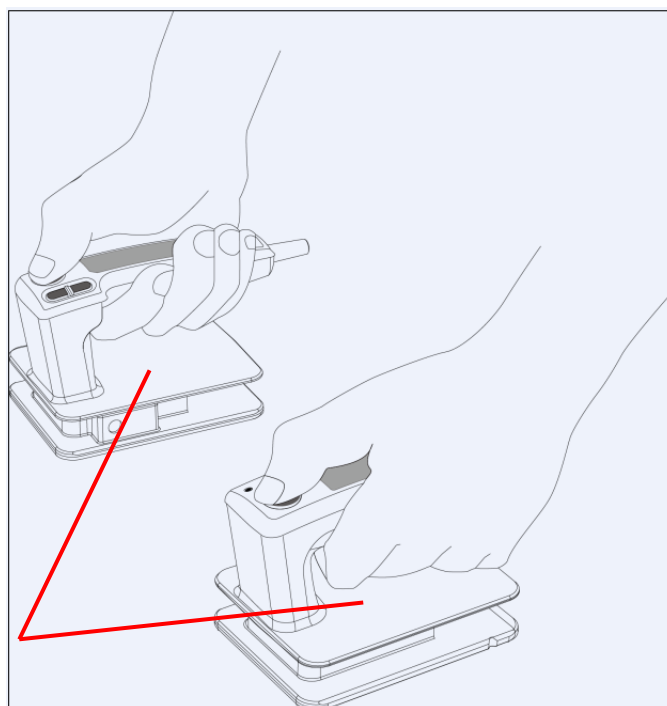

Do not contact this surface and the parts below it.

Warning

- **When charging or electric shock, do not touch the parts of the electrode paddle except the insulated part of the handle, otherwise the operator may receive an electric shock.**

4. Rotate the mode selector to manual defibrillation mode.
5. Select energy level and the energy level selected will be displayed in defibrillation message area.
 - Turn the mode selector to the desired energy level;
 - Turn the mode selector to 1-360 position and press "+" and "-" on the monitor to adjust energy level; if external paddle is used, you can also press "+" and "-" buttons on the paddle to adjust the energy.
6. Charge the defibrillator
 - Press **Charge** button on the front panel. If external paddles are used, you can also press the **Charge**

button on the paddles. When the defibrillator is being charged, the progress bar will be displayed in defibrillation message area and charge tone will be given out. When the defibrillator is charged well, charge completed prompt tone will be given out.

If you want to increase or reduce the selected energy level during charge or after charge completed, change the energy level directly and recharge the defibrillator.

Press the [Disarm] softkey to internally discharge the energy that is being charged or has been charged. When the electric shock button is not pressed for discharge within the set auto release time, the monitor will automatically cancel. You can set [Auto Disarm Time] under [Manul Def Setup] under the [Config Manage] menu.

7. Shock

Make sure the patient needs to be shocked and the charge has been completed. Make sure no one contacts with the patient and on one contacts with the accessories and equipment connected with the patient.

Shout out “STAND CLEAR” loudly and clearly.

- For pads: press the **Shock** button on the front panel
- For external paddles: press the both **Shock** buttons on the paddles simultaneously.

Attention

- **200J energy level is recommended for defibrillation for adult.**
- **When using external paddles, the Shock button on the front panel is not available.**
- **Usually, defibrillation is conducted by using paddles or pads. But you can choose ECG lead wires to conduct ECG monitoring during defibrillation and any available lead can be selected to display.**

12.4.1 Using Child External Paddles

Child paddles are installed inside the external paddles. To use child paddles, press the latch in the side of external paddles and pull the electrodes of external paddles.

For other operating steps, please refer to *12.4 Steps of Manual Defibrillation*.

12.5 Synchronized Cardioversion

In manual defibrillation mode, press [Enter Sync] soft button to enter the synchronized cardioversion mode.

The synchronized state will be displayed in defibrillation message area and an R wave mark will be displayed above each R wave detected as shown below:

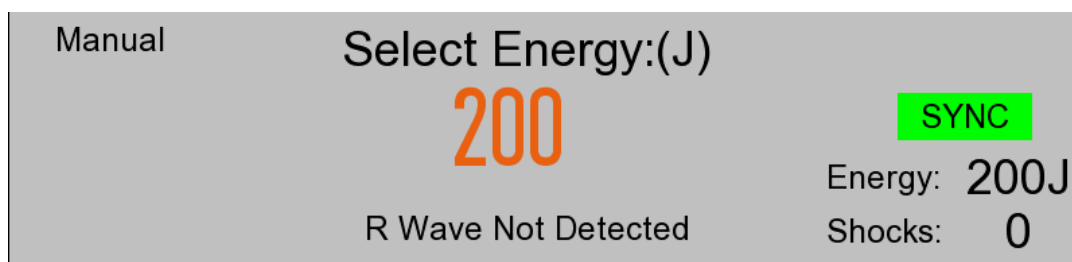

Synchronized Cardioversion

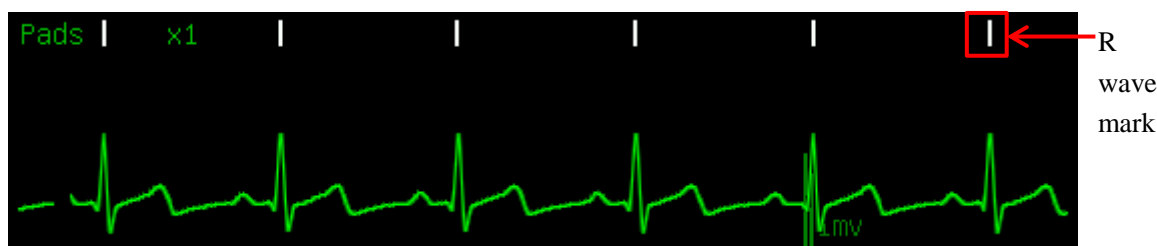

ECG monitoring can be conducted by pads, paddles and also 3-lead ECG cable and 5-lead ECG cable. Use pads and paddles to give shock.

When conducting synchronized cardioversion, it is recommended to monitor ECG by using 3-lead ECG cable or 5-lead ECG cable and give shock by pads and paddles.

12.5.1 Steps of Synchronized Cardioversion

1. Connect therapy cable and place pads or paddles; if using ECG lead to monitor ECG, connect ECG lead wire and place ECG electrodes.
2. In manual defibrillation mode, press [Enter Sync] soft button. If [Remote Sync Input] of [Manul Def Setup] is turned on, select it as required and enter synchronous cardioversion mode.
3. Select the lead. The selected lead must have clear signal and large QRS complex.
4. Make sure the R wave mark appears above the R wave. If the R wave mark doesn't appear or appear at the wrong position (like above T wave), select another lead.
5. Make sure the Defibrillator Monitor has entered synchronized cardioversion mode with text message [SYNC] displayed in defibrillation message area.
6. Select energy level.
7. Press the **Charge** button on the panel. If you are using an external paddle, you can press the **Charge** button on the paddle.
8. Make sure the patient needs to be shocked and the charge has been completed. Make sure no one contacts with the patient and on one contacts with the accessories and equipment connected with the patient. Shout out "STAND CLEAR" loudly and clearly.
9. Press **Shock** button. If the external paddles are used, press both **Shock** buttons on the paddles simultaneously. When the next R wave is detected, the Defibrillator Monitor will give a shock.

Attention

- **The alarms will auto be enabled after enter synchronized cardioversion.**
- **When giving a shock, you should press and hold the Shock button (or Shock buttons on external paddles) until the shock is delivered. The monitor will deliver the shock when the next R wave is detected.**

12.5.2 Giving Another Shock

If another synchronized cardioversion is required after giving a shock, please do the following steps:

- 1) Make sure that the monitor is still in synchronized cardioversion mode.
- 2) Repeat the 4~9 steps of synchronized cardioversion introduced above.

If [Sync Keep] is set to [On], the monitor will still be in synchronized cardioversion mode after giving a shock; while if it is set to [Off], the Defibrillator Monitor will auto exit synchronized cardioversion mode after giving a shock.

12.5.3 Exit Synchronized Cardioversion Mode

Press [Exit Sync] soft button to exit the synchronized cardioversion mode.

12.6 Remote Synchronized Cardioversion

The monitor can realize remote synchronized cardioversion by connecting with the bedside monitor. The bedside monitor providing ECG signal must have a synchronized defibrillation connector and must be connected with the data input/output interface of the Defibrillator Monitor through the synchronized cable. Access [Main Menu]→[Config Manage]→enter password→[Manul Def Setup] →[Remote Sync Input] and select [On] to enable remote synchronized cardioversion function.

Conduct remote synchronized cardioversion following the steps below:

1. Connect the bedside monitor with the Defibrillator Monitor through the synchronized cable.
2. Start the Defibrillator Monitor and enter manual defibrillation mode.
3. Press [Enter Sync] soft button and the [Sync Mode Select] menu will be displayed as shown below:

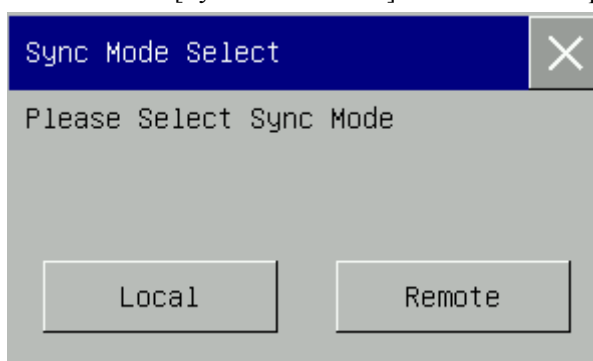

4. Select [Remote] to enter remote synchronized cardioversion mode and the text message [Remote Sync] will appear on the screen.
5. Make sure that each time the bedside monitor detects an R wave, the  mark on the monitor will flash once, which indicates that the synchronized signal has been received once.
6. Connect the therapy cable with the monitor until a “click” is heard.
7. Place pads or paddles.
8. Conduct the remote synchronized cardioversion following the step 6 through step 9 introduced in *12.5.1 Steps of Synchronized Cardioversion*.

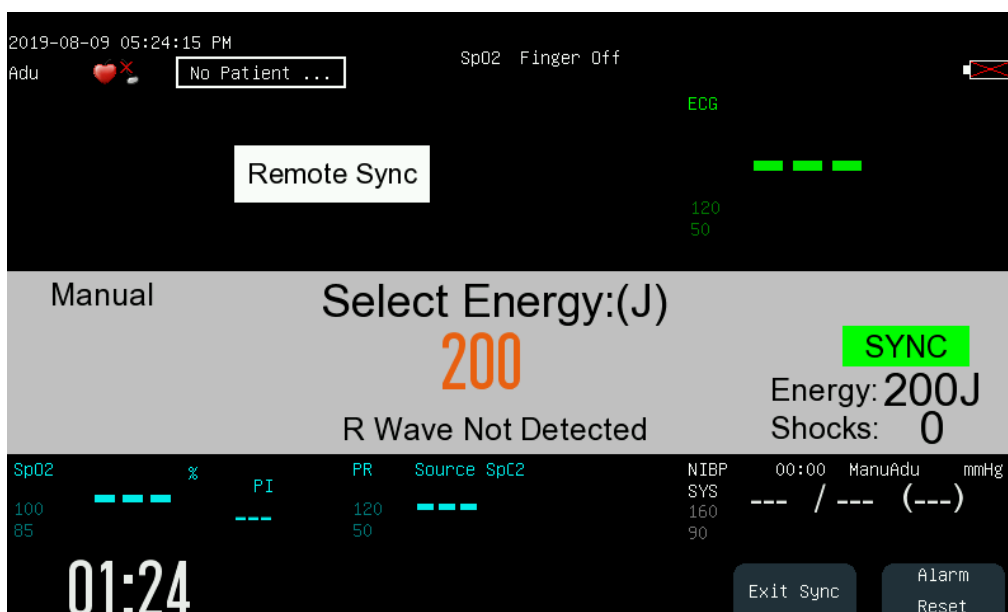

⚠ Attention

- After entering remote synchronized cardioversion mode, the monitor will not display ECG waveform and parameter values of the patient. Please view the ECG waveform of the patient on bedside monitor.
- Make sure that the bedside monitor being used has such performance that when performing remote synchronized cardioversion, the bedside monitor and Defibrillator Monitor used together can deliver shock synchronously within 60ms of detecting the next R wave peak.

12.7 Contact Impedance Indicator

The contact impedance indicator is used to indicate the contact impedance of the patient, as shown in the figure below:



In which

: The contact impedance is too high.

: The contact impedance is high.

: The contact impedance is normal.

: The therapy cable is not connected well.

To open the contact impedance indicator, please follow the steps below:

Access [Main Menu]→[Config Manage]→enter password→[Manul Def Setup] →[Contact Imped Prompt] and select [On] to open the contact impedance indicator.

 **Attention**

- **It is recommended to conduct defibrillation when the contact impedance is normal. The defibrillation can also be conducted when the contact impedance is high.**

Chapter 13 Noninvasive Pacing

13.1 Overview

Noninvasive pacing therapy is used to deliver rhythmical pulse to patient's heart through the pads. When delivering the pacing pulse once, a white pacing mark will appear on ECG waveform. In the demand pacing mode, the white R wave mark will appear above ECG waveform until electrical capture occurs.

In pacer mode, the physiological parameters except RESP can be monitored and trigger alarms.

During demand pacing, ECG monitoring should be performed by using ECG electrodes and 3-lead or 5-lead ECG cable. Pacing pulse is delivered through pads, but pads are not capable of monitoring ECG and delivering pacing pulse at the same time.

13.2 Safety Information

Warning

- For conducting pacing therapy on the patient with oxygen catheter, please place the oxygen catheter properly and do not put it near the pads to avoid fire and explosion.
- During pacing, the heart rate and alarms given by the monitor may be inaccurate. Keep the patient under close surveillance and do not rely entirely on the heart rate displayed on the screen.

Caution

- If pacing needs to be conducted for a long period, you should check the skin in touch with ECG electrodes and pads and replace ECG electrodes and pads periodically.
- For conducting therapy on the patient with implanted device (like permanent pacemaker or cardioverter-defibrillator), please consult the doctors or refer to the user manual of the implanted device.

Attention

- Pacer mode supports arrhythmia analysis and give arrhythmia alarms including Asystole, Ventricular Fibrillation and Ventricular Tachycardia.
- If pacing is interrupted for some reason, press [Start Pace] soft button to continue pacing.
- In pacer mode, the pacing state of the patient cannot be changed.
- If pads do not contact well, prompt message “Pacer Stopped abnormally” and “Electrode Pad Off” will be displayed.
- In pacer mode, pads cannot be used to monitor ECG waveform.

13.3 Pacing Interface

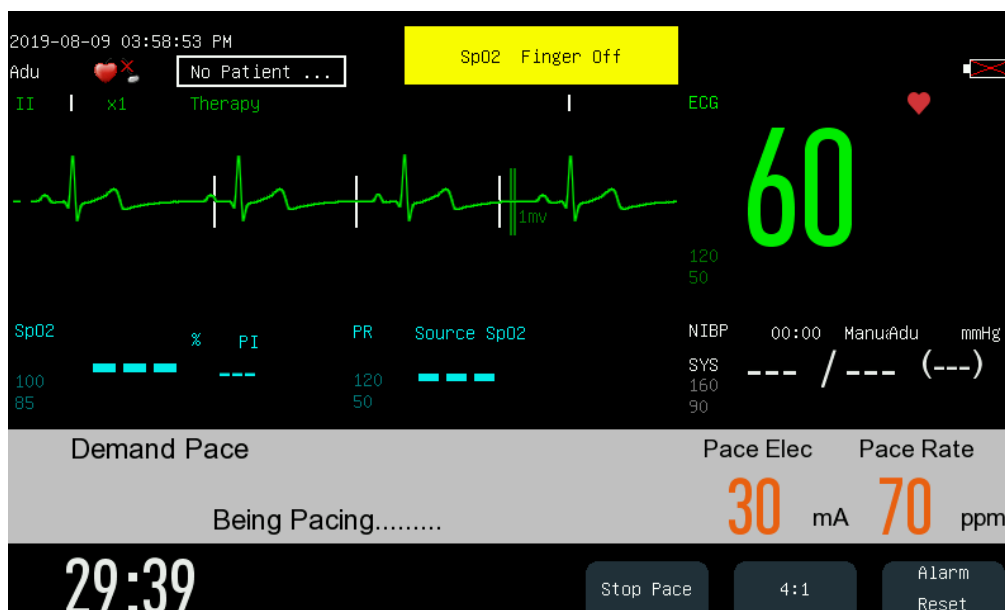

In pacer mode, the monitor can display one ECG waveform and other physiological parameters monitored. In the pacing message area, such information related to pacing as pacing mode shortcut key, pacing message, pacing alarm, pacing current and pacing rate will be displayed.

13.4 Pacing Mode

Two pacing modes are provided by the monitor: [Demand Pace] and [Fixed Pace].

- Demand pace: the monitor will deliver pacing pulse only when patient's heart rate is lower than the set pacing rate.
- Fixed pace: the monitor will deliver pacing pulse at the set pacing rate.

During pacing, you can change the pacing mode through the pacing mode shortcut key. The pacing will not stop when changing the pacing mode and will continue to deliver pacing pulse at the set pacing rate and as the set pacing current.

Attention

- Use demand pacing for most patients. Use fixed pacing only when there is no reliable R wave detected or there is no available monitoring shock due to interference.
- In fixed pacing mode, there is no R wave mark above the pacing QRS complex.
- In demand pacing mode, if patient's heart rate is higher than the pacing rate, the monitor will not deliver pacing pulse and there will be no pacing mark either.

13.5 Preparation for Noninvasive Pacing

1. Connect pads cable with the therapy cable connector on the monitor right panel.
2. Make sure that the packaging of pads is intact and pads are not expired.
3. Connect pads with pads cable.
4. Place pads on the patient in the anterior-lateral or anterior-posterior position.
5. For demand pacing mode, use ECG lead cable to monitor ECG. Connect the ECG lead cable and place ECG electrodes. To receive the best ECG monitoring signal, make sure there is adequate space between the ECG electrodes and pads.

13.5.1 Steps of Demand Pacing

After finishing the preparation, follow the steps below:

1. Switch to pacer mode. Demand pacing is enabled automatically and ECG waveform from lead II will be displayed by default.
2. Select a lead with an easily detectable R-wave.
3. Make sure that the R wave mark appears above R wave, as shown below. If the R wave mark doesn't appear or appear at the wrong position (like above T wave), select another lead.



4. Set the pacing rate. If necessary, set the initial pacing current. Rotate the knob to outline the pacing rate or pacing electricity hotkey and press the knob, then rotate the knob to change the pacing rate or initial pacing current and press the knob to confirm the change or set under [Pace Setup] under the [Config Manage] menu.

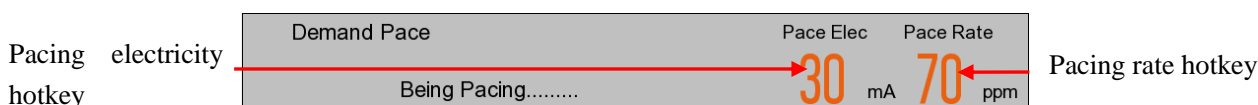

5. Press [Start Pace] soft button to start pacing and the pacing message “Being Pacing.....” will appear.

Attention

- **In demand pacing mode, the monitor will detect the connection of pads cable, pads, ECG cable and ECG electrodes. If any connection error is detected, the pacing will stop and relevant prompt message will appear in the pacing message area until the connection is good.**

6. Make sure the white pacing marker appears on the ECG waveform, as shown in the figure below:

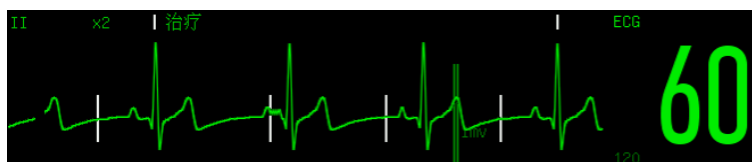

7. Adjust pacing current: increase the pacing current until electrical capture occurs (Electrical capture is indicated by a QRS complex following each pacing mark), then adjust pacing current to the lowest level which can maintain the electrical capture.
8. Confirm the peripheral circulation has a pulse.

To interrupt pacing and view patient’s pulse rate, please press and hold the [4:1] soft button. The Defibrillator Monitor will deliver the pacing pulse at one fourth of the set pacing rate. Release the [4:1] soft key to resume sending the pacing pulse at the set rate.

Press [Stop Pace] soft button to stop pacing. Press [Start Pace] soft button to restart delivering pacing pulse after pacing stops.

Caution

- The patient’s cardiac output shall be routinely evaluated.

13.5.2 Steps of Fixed Pacing

- 1) Enter pacer mode.
- 2) Select the pacing mode hotkey and switch to [Fixed Pace] mode.

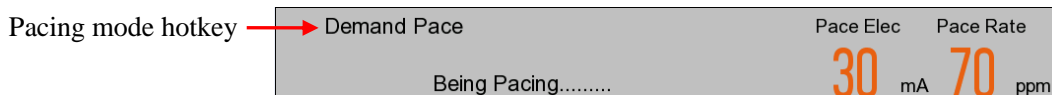

- 3) If ECG lead is used, press **LEAD SELECT** button to select the desired lead.
- 4) Set pacing rate. If necessary, set the initial pacing current.
- 5) Press [Start Pace] soft button to start pacing and the pacing message “Being Pacing.....” will appear.
- 6) Make sure the white pacing marker appears on the ECG waveform.
- 7) Adjust pacing current: increase the pacing current until electrical capture occurs (Electrical capture is indicated by a QRS complex following every pacing mark), then adjust pacing current to the lowest level which can maintain the electrical capture.
- 8) Confirm the peripheral circulation has a pulse.

To interrupt pacing and view patient’s pulse rate, please press [4:1] soft button. The Defibrillator Monitor will deliver the pacing pulse at one fourth of the set pacing rate. Release the [4:1] softkey to resume sending the pacing pulse at the set rate.

Press [Stop Pace] soft button to stop pacing. Press [Start Pace] soft button to restart delivering pacing pulse after pacing stops.

Warning

- Use pads on patient carefully to avoid shock during pacing.
- When operating the monitor on battery in pacer mode, if “Low Battery” alarm triggered, please connect the monitor to AC power supply or replace the battery with a fully charged one

immediately.

 **Attention**

- **The monitor or pacer mode may be instable when electrotoome and other electronic equipment are used.**

14.1 Overview

In AED (Automatic External Defibrillation) mode, the Defibrillator Monitor will analyze patient's ECG waveform automatically and indicate the users to operate according to the cardiac rhythm monitored.

The monitor starts to perform intelligent analysis after entering AED mode. When a shock able rhythm is detected, the Defibrillator Monitor will give "shock advised" prompt and start to auto charge immediately. If the patient is found to be unsuitable for electric shock, enter a state where no electric shock is recommended. Defibrillation intelligence analysis continues throughout the AED process. Defibrillation intelligence analysis is stopped when the defibrillation monitor enters the CPR state or an abnormality occurs in the connection of multi-functional electrode pads.

In AED mode, only the ECG signals acquired through the multi-functional electrode pads are displayed. The monitor will turn off the alarm and parameter measurements, and it is forbidden to enter patient information. Lead Select, Alarm Pause, NIBP, and Menu buttons are all inactive.

Before entering the AED mode to treat patients, go to the [Config Manage] → [AED Setup] screen to set the AED routine. See *7.3 AED Settings* for details.

14.2 Safety Information

Danger

- **Do not conduct defibrillation in the presence of oxygen-rich atmospheres. When conducting defibrillation on the patient with oxygen catheter, place the oxygen catheter properly. Do not put it near the pads to avoid fire and explosion.**
- **During defibrillation, do not allow pads to touch each other or touch ECG electrodes, lead wires, dressings, etc. Otherwise electrical arcing and patient skin burns could be caused.**
- **During defibrillation, do not touch patient and conductive material (including bed and stretcher) connected with the patient to avoid potential injury and death.**
- **During defibrillation, do not touch conductive liquid like saline solution, blood and conductive gel and conductive material like bed and stretcher to avoid forming current path.**

Warning

- **During defibrillation, the bubble between pads and patient skin will cause patient skin burns. Make sure that pads are placed to patient skin tightly to avoid bubbles.**
- **Do not use dry pads. Use the pads immediately after unpacking them.**
- **AED is only applicable to the patients more than eight years old.**

Caution

- **For the patients with pacemaker, the sensitivity and specificity of AED analysis may decline.**
- **Improper operation on pads during storage or before use will damage the pads. Do not use the damaged pads.**

14.3 AED Interface

AED interface is shown as the figure below:

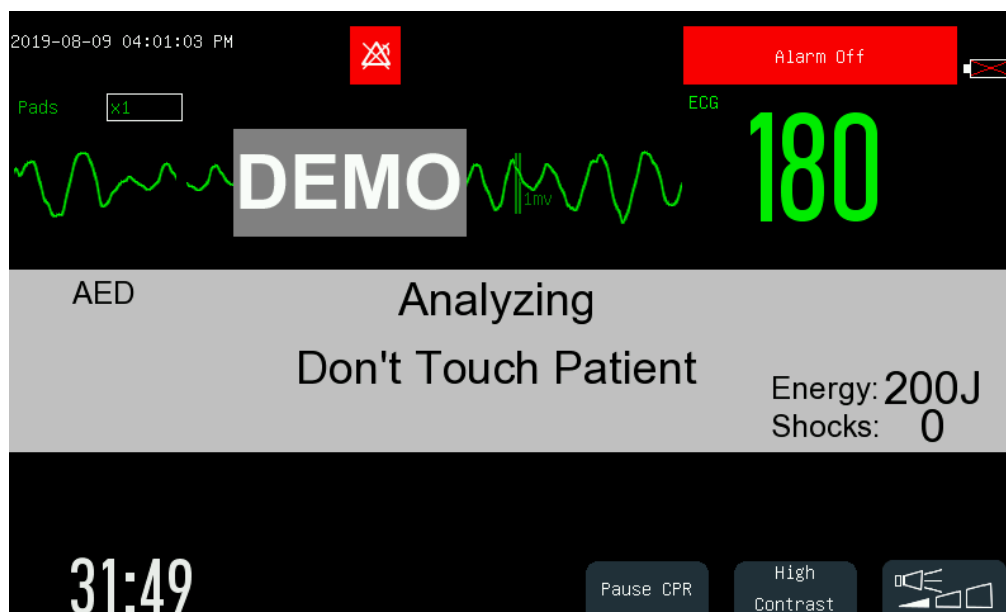

In AED mode, the Defibrillator Monitor will only display one ECG waveform detected by pads and HR value calculated from this displayed waveform. The AED message area at the middle of AED interface will display AED prompt message, contact impedance indicator (settable), shock times and so on.

For the introduction to contact impedance indicator and its setting method, please refer to section **12.7 Contact Impedance Indicator** for detail.

There are three soft buttons at the lower right corner of AED interface.

- When the Defibrillator Monitor is used outdoors, press [HIGH CONTRAST] soft button to view the display screen clearly.
- Press  to adjust voice volume.

14.4 AED Procedure

Verify that the patient is in cardiac arrest without consciousness, pulse or normal breathing.

1. Remove all clothing from patient's chest. Dry patient's chest and do skin preparation if necessary.
2. Place pads on patient in the anterior-lateral position according to the indication on packaging.
3. Connect pads with pads cable. Connect pads cable with the therapy cable connector on the Defibrillator Monitor right panel until a "click" is heard.
4. Rotate the mode selector to AED.

In AED mode, the Defibrillator Monitor will detect the connection of pads cable and pads. If any connection error is detected, relevant prompt message will appear in the AED message area until the connection is good.
5. Perform AED following the voice prompt and prompt message.

The monitor will analyze patient's cardiac rhythm based on the ECG waveform detected by pads and give a warning of "Not Contact Patient". When a shockable rhythm is detected, the Defibrillator Monitor will start to auto charge immediately.

The voice prompt can be enabled or disabled in [Config Manage] menu or by pressing the soft button below .

- If there is a shock advised, press the **Shock** button on the front panel. After charge completes, the monitor will give out "Do not touch patient! Press shock button" voice prompt. At this moment, check that no one touches the patient and accessories or equipment connected with the patient and shout out "STAND CLEAR" loudly and clearly. Then press the **Shock** button on the front panel to deliver a shock.

After shock, the monitor will give "Energy Delivered" voice prompt and text message. The shock times on the screen will update to indicate the number of shocks has been delivered. If the [Serial Shock Times] is set as more than one, the monitor will restart to analyze patient's cardiac rhythm after a shock being delivered and estimate whether the shock is successful. There will be voice prompt and text message for indicating the users to perform more shocks.

Attention

- **Do not place pads in the anterior-posterior position. The AED algorithm of this monitor has not been verified under the anterior-posterior placement.**
- **Keep patient still during cardiac rhythm analysis in order to prevent misdiagnosis and delayed diagnosis.**
- **The monitor will not deliver shocks automatically. Shocks will only be delivered by pressing Shock button.**
- **Too high impedance could have a great impact on patient's therapy. Reduce the impact caused by high impedance to the utmost. When prompt message "Impedance Too High" appears, please check whether patient skin is clean and dry and whether chest hair has been shaved. If the prompt message is still there, please replace pads or pads cable.**

14.5 Shock Advised

If the shockable cardiac rhythm is detected, the defibrillator will be auto charged to the set energy level and charge tone will be given out. The **Shock** button will flash after charge completes.

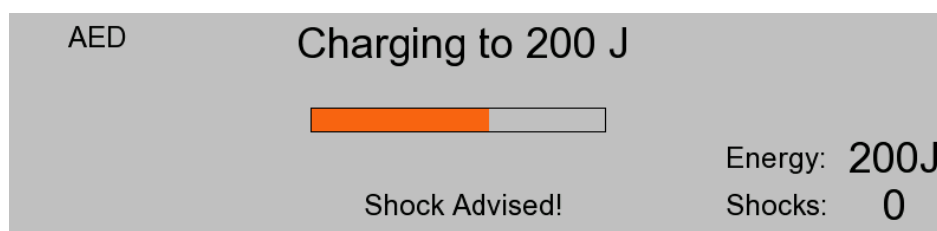

The cardiac rhythm analysis will continue during charge. If the situation that the cardiac rhythm has changed and is not suitable for shock before delivering a shock is detected, the defibrillator will disarm the energy automatically.

After the monitor gives out voice prompt “Do not touch patient! Press shock button.”, if the users do not press **Shock** button during the interval set in [Auto Disarm Time], the defibrillator will disarm the energy automatically and restart cardiac rhythm analysis.

Press [Pause Analysis] soft button to disarm the defibrillator at any time during charge or after charge completes.

Initial shock energy recommended for adult patient is 200J.

14.6 No Shock Advised

When there is no shock able rhythm detected, the monitor will give “No Shock Advised!” prompt message.

If NSA process mode is set as:

- [CPR]: Enter CPR, the monitor will give out voice prompt “No shock advised, Pause, if needed, start CPR” and display text prompt “Pause, If Needed, Begin CPR” in AED message area. CPR countdown will also appear.
- [Continue Analysis]: The monitor will continue to monitor patient’s ECG and analyze the potentially shock able cardiac rhythm. Before shock able cardiac rhythm being detected, the monitor will give out voice prompt “No shock advised. If needed, pause analysis for CPR” repeatedly and display “No Shock Advised!” and “Being Monitoring....” text prompt circularly. The frequency of the language prompt can be set in [Voice Interval] in [AED Setup].

You can press [Pause Analysis] soft button to stop analysis and start CPR. [CPR Time] can be set in [AED Setup].

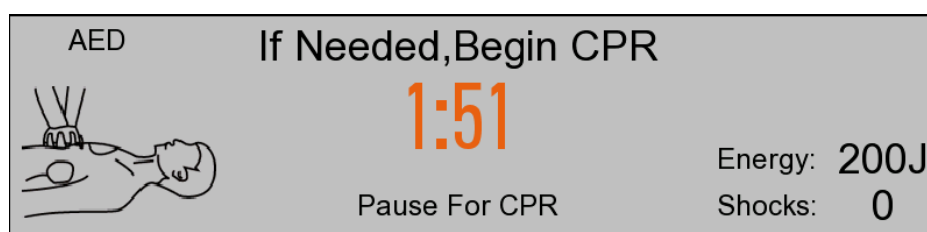

After CPR, the monitor will resume analysis, or during CPR, you can press [Recovery Analysis] soft button to resume cardiac rhythm analysis.

14.7 CPR

If the [Pre-Shock CPR Time] isn't set to [Off], the system will enter initial CPR after entering AED mode. The users can set the pre-shock CPR time or disable the initial CPR function in [Pre-Shock CPR Time].

After finishing the serial shocks, the monitor will pause analysis and enter CPR. The CPR countdown will start and voice prompt “Pause, If Needed, Begin CPR” will be given out. After CPR, the monitor will resume analysis. During CPR, you can press [Recovery Analysis] soft button to resume cardiac rhythm analysis.

During serial shocks, if you press [Pause Analysis] soft button after a shock delivered, the monitor will enter CPR. The CPR duration can be set in [CPR Time] in [AED Setup].

14.7.1 Using CPR Metronome

After enter CPR, the monitor provides the CPR metronome function and indicates the operators to press the patient's chest and perform ventilation at AHA/ERC recommended rate.

You can enable and disable the CPR metronome function in [CPR Metronome] in [AED Setup].

The CPR metronome is turned on by default. With the CPR metronome turned on, you can set the CPR compression/ventilation ratio by selecting [CPR Mode]. The default compression/ventilation ratio is 30:2.

Warning

- **CPR metronome doesn't prompt the current condition of the patient. The operators should assess patient's condition constantly because patient's condition may vary in a very short period. Do not perform CPR on the patients with response and normal breathing.**

Attention

- **CPR metronome can be affected by the on/off state of AED voice prompt and the settings of voice volume.**

14.8 AED Audio Recording

In AED mode, the system can tape the whole therapy process.

You can enable the audio recording function by accessing [Config Manage]→[AED Setup]→[Audio Recording]and select [On].

After audio recording function is enabled,  symbol will appear at the upper right corner of the AED message area.

The system can store audio recording up to 240 min and store audio recording of 60 min for each patient.

Chapter 15 Resp Monitoring

15.1 Resp Measurement

The monitor measures the RESP based on the thoracic impedance between the two electrodes. The changes of such impedance caused by thoracic movements generate a RESP wave on the screen. The RR is calculated from such wave.

15.2 Resp Display

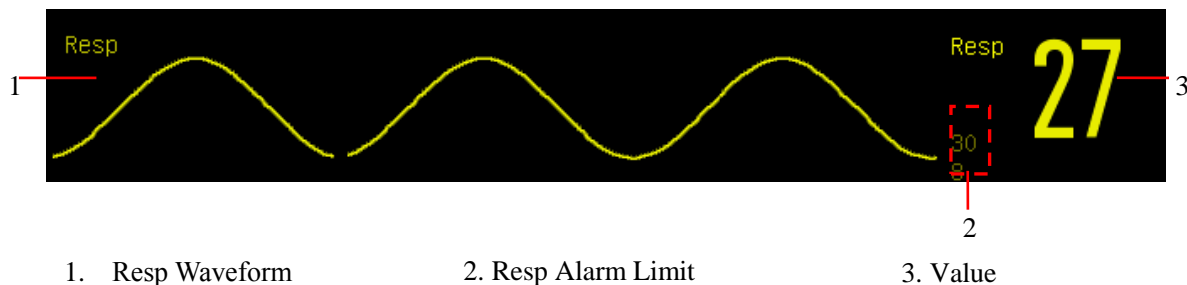

15.3 Placement of Electrodes

In Resp measurement, it is important to prepare the skin properly for electrode placement. Refer to the ECG measurement for relevant information.

The Resp signals are measured through the two ECG electrodes. When the ECG electrodes are placed in standard position, the Resp can be measured through the electrode RA and electrode LL.

15.3.1 Optimization of Lead Position

To measure the ECG and Resp simultaneously, it may be necessary to adjust the positions of the two electrodes for some patients. Non-standard placement of ECG electrodes may cause changes to the ECG waveform and affect the ST segment analysis and ARR analysis.

1) Cardiac Superposition

The cardiac activities affecting the Resp waveform are defined as cardiac superposition. When that the Resp electrodes collect the rhythmic blood flow causes the impedance changes, the phenomenon occurs. Proper placement of electrodes can reduce cardiac superposition. Avoid the liver area and ventricles in the line between the electrodes, which is especially important to neonates.

2) Lateral Thoracic Expansion

The thoracic cage of some patients, especially neonates, may expand to both sides. To obtain the best Resp waveform, place the two electrodes respectively at the right mid-axillary line and left outer chest with strongest Resp movements, as shown below:

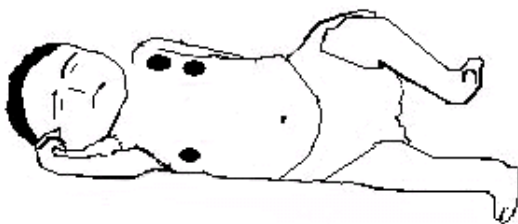

3) Abdominal Respiration

Some patients may have restricted thoracic movements and rely mainly on abdominal respiration. To obtain the best Resp waveform, place the electrode LL on the left abdomen with strongest expansion, as shown below:

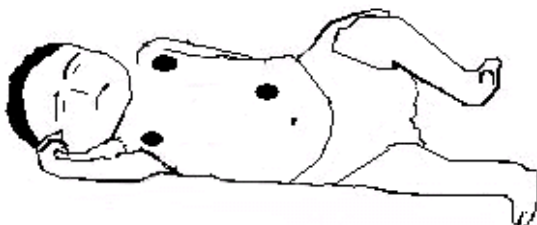

Attention

- Place the green and red electrodes diagonally for the best respiratory wave. The liver region and ventricle should be avoided by connecting them to the respiratory electrodes, so as to avoid the false difference of cardiac coverage or pulsating blood flow, which is especially important for newborns.
- Respiratory monitoring is not appropriate for patients with a high range of activity because it can lead to false alarms.

15.4 Resp Calculation Mode

- 1) Enter [User Maintain] → [Resp Setup] → [Cal. Mode] (Calculation Mode).
- 2) Select [Auto] or [Manual].
- 3) In [Manual] mode, you can set the upper and lower dotted line of the Resp waveform.
- 4) In [Auto] mode, you cannot change the upper or lower dotted line but use the default waveform computation method.

[Auto] mode:

The monitor automatically adjusts the detection level based on the waveform height and ECG artifact. In [Auto] mode, no dotted line of detection level is displayed on the Resp waveform.

Select [Auto] mode if:

- ✧ The RR is not approximate to the HR;
- ✧ The patient relies on spontaneous Resp with or without CPAP;
- ✧ The patient relies on mechanical ventilation (except intermittent mandatory ventilation (IMV)).

[Manual] mode:

In [Manual] mode, you have to set the Resp detection level. The monitor does not auto adjust the dotted lines of detection level. When the Resp depth changes or the Resp waveform gain is adjusted, you may need to adjust the position of the dotted lines of detection level on the Resp waveform manually by selecting [Up Line] and [Down Line].

Select [Manual] mode if:

- ✧ The RR is approximate to the HR;
- ✧ The patient relies on IMV;
- ✧ The Resp signals are weak (try to improve the signal quality by relocating the electrodes).

In [Manual] mode, the superposition of some cardiac activities may trigger the Resp counter and result in incorrect high RR indication or no-breath detection failure. If you doubt that the cardiac superposition has been treated as Resp activities, improve the RESP detection level until it is higher than the cardiac superposition. If you do not improve the Resp detection level due to small Resp waveform size, follow the instructions of Lateral Thoracic Expansion in Section *15.3.1 Optimization of Lead Position* to optimize the position of the electrodes.

15.5 Resp Setup

15.5.1 Gain

Gain is used to adjust the amplitude of the Resp wave. You can select $\times 0.25$, $\times 0.5$, $\times 1$, $\times 2$ or $\times 4$ as the gain.

- 1) Select the Resp parameter area to enter [Resp Wave] and select an appropriate [Gain].

15.5.2 Resp Lead

Resp leads indicate the source of the current Resp waveform. You can set [Resp Lead] to RA-LA (I), RA-LL (II) or [Auto]. If you select [Auto], the monitor automatically selects the appropriate Resp lead.

- 1) Select the Resp parameter area to enter [Resp Setup] → [Resp Lead].
- 2) Select RA-LA (I), RA-LL (II) or [Auto].

15.5.3 No Breath Alarm Delay

No-breath detection is to detect the longest interval between two respirations. When the actual no-breath time of the patient exceeds the set no-breath time, the monitor responds to no-breath alarms according to the value of [No Breath Alm Delay].

Set [No Breaths Timeout]:

- 1) Select the Resp parameter area to enter [Resp Setup] → [No Breaths Timeout] and set an appropriate detection time.

Set [No Breath Alm Delay]:

- 1) Enter [User Maintain] → [Other Setup].
- 2) Set [No Breath Alm Delay] to [Close], [10s], [15s], [20s], [25s], [30s], [35s], [40s], [45s], [50s], [55s] or [1min].

If you select [Close], the alarm delay function will be disabled.

15.5.4 Enhance Filter

This parameter is designed to filter out the Resp interference. Its default is [On].

- 1) Select the Resp wave area to enter [Resp Wave].
- 2) Select [Enhance Filter] to switch between [ON] and [OFF].



Note

- **In Resp measurement, the monitor cannot recognize any obstructive or mixed nobreathing but trigger an alarm when the interval between two respirations exceeds the set time.**

Chapter 16 SpO₂ Monitoring

16.1 Overview

The SpO₂ plethysmography measures the arterial SpO₂, namely, the percentage of the oxyhemoglobin count. The SpO₂ is measured with the pulse oximetry; a continuous noninvasive method measuring how many of the lights emitted from the sensor (light source) can penetrate the patient's tissues (fingers or ears) and reach the receiver.

The monitor measures the following parameters:

Arterial SpO₂: the ratio of the oxyhemoglobin to the sum of oxyhemoglobin and non-oxygenated hemoglobin (functional arterial SpO₂)

Pleth waveform: a visible indication of the patient's pulse;

PR (calculated from pleth waveform): the patient's pulse count per minute;

PI (perfusion index, not for Nellcor SpO₂): pulse signal strength as the percentage of pulsatile signal to non-pulsatile signal.



Warning

- **If there is any carboxyhemoglobin (COHb), methemoglobin (MetHb) or dye dilution chemical, the SpO₂ value has a deviation.**

16.1.1 Identification of SpO₂ Sensor Type

The SpO₂ sensor type is pre-configured before the monitor is delivered. You can identify it based on the silkscreened logo beside the original SpO₂ sensor below the left side sensor connector of the monitor:

- ◆ Comen SpO₂ sensor:

Sensor connector: circular white connector at the side panel;

Silkscreened logo: SpO₂.

- ◆ Masimo SpO₂ sensor:

Sensor connector: circular blue connector at the side panel;

Silkscreened logo: MasimoSET.

- ◆ Nellcor SpO₂ sensor:

Sensor connector: circular blue connector at the side panel;

Silkscreened logo: Nellcor.

The information about wavelength range and maximum optical output power of the sensor is useful to the clinician for some therapy, for example, photodynamic therapy.

- ◆ The Comen SpO₂ sensor can measure a wavelength of 660nm (red LED) or 905nm (IR LED).

- ◆ The Masimo SpO₂ sensor can measure a wavelength of 660nm (red LED) or 905nm (IR LED).
- ◆ The Nellcor SpO₂ sensor can measure a wavelength of 660nm (red LED) or 905nm (IR LED).
- ◆ The maximum optical output power of the sensor is lower than 15mW.

Warning

- The monitor can automatically recognize the SpO₂ sensor type. However, the monitor is configured with a specific internal SpO₂ hardware before delivery, the monitor cannot measure SpO₂ if using a incompatible sensor.

16.2 SpO₂ Display

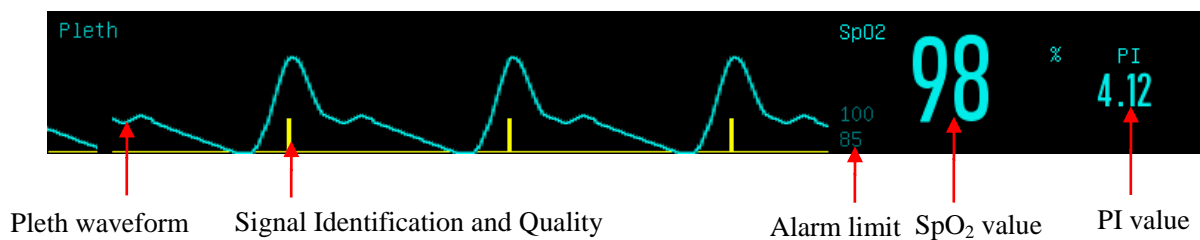

16.3 Safety Instructions

Warning

- The monitor is compatible with the SpO₂ sensor designated by Comen only. Before monitoring the patient, check the sensor and extension cord are compatible with the monitor. Incompatible accessories reduce the performance of the monitor.
- Before monitoring the patient, check the sensor cable works properly. Remove the SpO₂ sensor cable from the sensor interface and the monitor displays the prompt message “SpO₂Finger off” and triggers the alarm sound.
- If the SpO₂ sensor or its package seems damaged, do not use it. Return the damaged product to the manufacturer.
- Long-time continuous monitoring increases the risk of undesired skin characteristic changes (extremely sensitive, turning red, blistered or pressure necrosis), especially for neonates or the patients with perfusion disorder or variable or immature skin morphology diagram. Align the sensor with the light path, adhere the sensors properly and check the sensors position regularly based on skin quality (change the sensor position when the skin quality decreases). Perform such check frequently if necessary (subject to the condition of the patient).
- Make sure the sensor cable and the electrosurgical equipment cable are not intertwined.
- Do not place the sensor on a limb with ductus arteriosus or intravenous tube.
- Setting the high SpO₂ alarm limit to 100% disables the high-limit alarm. Premature infants may

get infected with crystalline posterior fibrous tissue diseases in case of high SpO₂. Please set the high SpO₂ alarm limit cautiously based on recognized clinical practices.

- The pulse oximeter is to be operated by, or under the supervision of, qualified personnel only. The manual, accessories, directions for use, all precautionary information, and specifications should be read before use.
- As with all medical equipment, carefully route patient cabling to reduce the possibility of patient entanglement or strangulation.
- Do not place the pulse oximeter or accessories in any position where it might fall on the patient.
- Do not start or operate the pulse oximeter unless the setup was verified to be correct.
- Do not use the pulse oximeter during magnetic resonance imaging (MRI) or in an MRI environment.
- Do not use the pulse oximeter if it appears or is suspected to be damaged.
- Explosion hazard: Do not use the pulse oximeter in the presence of flammable anesthetics or other flammable substances in combination with air or nitrous oxide or in oxygen-enriched environment.
- To ensure safety, avoid stacking multiple equipment or placing anything on the equipment during operation.
- To protect against injury, follow the directions below:
 - Do not soak or immerse the equipment in liquids.
 - Do not attempt to sterilize the equipment.
 - Use cleaning solutions only as instructed in this operator's manual.
 - Do not attempt to clean the equipment while monitoring a patient.
- To protect from electric shock, always remove the sensor and completely disconnect the pulse oximeter before bathing the patient.
- If any measurement seems questionable, first check the patient's vital signs by alternate means and then check the pulse oximeter for proper functioning.
- Inaccurate SpO₂ readings may be caused by:
 - Improper sensor application and placement.
 - Elevated levels of COHb or MetHb: High levels of COHb or MetHb may occur with a seemingly normal SpO₂. When elevated levels of COHb or MetHb are suspected, laboratory analysis (CO-Oximetry) of a blood sample should be performed.
 - Elevated levels of bilirubin.
 - Elevated levels of dyshemoglobin.
 - Vasospastic disease, such as Raynaud's, and peripheral vascular disease.
 - Hemoglobinopathies and synthesis disorders such as thalassemias, such as thalassemias, Hb s, Hb c, sickle cell, etc.
 - Hypocapnic or hypercapnic conditions.
 - Severe anemia
 - Very low arterial perfusion.

- **Extreme motion artifact.**
- **Abnormal venous pulsation or venous constriction.**
- **Severe vasoconstriction or hypothermia.**
- **Arterial catheters and intra-aortic balloon.**
- **Intravascular dyes, such as indocyanine green or methylene blue.**
- **Externally applied coloring and texture, such as nail polish, acrylic nails, glitter, etc.**
- **Birthmark(s), tattoos, skin discolorations, moisture on skin, deformed or abnormal fingers. etc.**
- **Skin pigment disorders.**
- **Interfering Substances: Dyes or any coloring substance that can change usual blood pigmentation may cause erroneous readings.**
- **The pulse oximeter should not be used as the sole basis for medical decisions. It must be used in conjunction with clinical signs and symptoms.**
- **The pulse oximeter is not an apnea monitor.**
- **The pulse oximeter may be used during defibrillation, but this may affect the accuracy or availability of the parameters and measurements.**
- **The pulse oximeter may be used during electrocautery, but this may affect the accuracy or availability of the parameters and measurements.**
- **The pulse oximeter should not be used for arrhythmia analysis.**
- **SpO₂ is empirically calibrated in healthy adult volunteers with normal levels of carboxyhemoglobin (COHb) and methemoglobin (MetHb).**
- **Do not adjust, repair, open, disassemble, or modify the pulse oximeter or accessories. Injury to personnel or equipment damage could occur. Return the pulse oximeter for service if necessary.**
- **Check the patient's skin every two hours to ensure good skin quality and lighting. In case of any skin change, move the sensor to another part. Change the wearing part at least every four hours.**
- **When the blood oxygen has no value, the waveform at this time has no reference meaning.**

Cautions

- **Do not place the pulse oximeter where the patient can control it.**
- **Electrical shock and flammability hazard: Before cleaning, always turn off the equipment and disconnect from any power supply.**
- **When patients are undergoing photodynamic therapy they may be sensitive to light sources. Pulse oximeter may be used only under careful clinical supervision for short time periods to minimize interference with photodynamic therapy.**
- **Do not place the pulse oximeter on electrical equipment that may affect the normal work of the oximeter.**
- **If SpO₂ values indicate the possibility of the hypoxemia, a laboratory blood sample should be taken to confirm the patient's condition.**

- If using pulse oximeter during full body irradiation, keep the sensor out of the radiation field. If the sensor is exposed to the radiation, the reading might be inaccurate or the equipment might be zero for the duration of the active irradiation period.
- To ensure that alarm limits are appropriate for the patient monitored, check the limits each time the pulse oximeter is used.
- Variation in measurements may be profound and may be affected by sampling technique as well as the patient's physiological conditions. Any results exhibiting inconsistency with the patient's clinical status should be repeated and/or supplemented with additional test data. Blood samples should be analyzed by laboratory instruments prior to clinical decision made to completely understand the patient's condition.
- Do not submerge the pulse oximeter in any cleaning solution or attempt to sterilize by autoclave, irradiation, steam, gas, ethylene oxide or any other method. This will seriously damage the pulse oximeter.
- **Electrical Shock Hazard:** Carry out periodic tests to verify that leakage currents of patient-applied circuits and the system are within acceptable limits as specified by the applicable safety standards. The summation of leakage currents must be checked and in compliance with IEC 60601-1 and UL60601-1. The system leakage current must be checked when connecting external equipment to the system. When an event such as a component drop of approximately 1 meter or greater or a spillage of blood or other liquids occurs, retest before further use. Injury to personnel could occur.
- **Disposal of product -** Comply with local laws in the disposal of the equipment and/or its accessories.
- To minimize radio interference, other electrical equipment that emits radio frequency transmissions should not be in close proximity to the pulse oximeter.

Notes

- High-intensity extreme lights (such as pulsating strobe lights) directing on the sensor may not allow the pulse oximeter to provide vital sign readings.
- Pulse oximeter is calibrated to display functional blood oxygen saturation.

16.3.1 Masimo SpO₂ Specific Information

Cautions

- If the Low Perfusion message is frequently displayed, find a better perfused monitoring site. In the interim, assess the patient and, if indicated, verify oxygenation status through other means.
- Replace the cable or sensor if the instructions in the manual after firstly tried don't work when a low SIQ message is displayed in the process of consistently monitoring patients. after completing troubleshooting steps listed in this manual.

 **Notes**

- When using the Maximum Sensitivity setting, performance of the "Sensor Off" detection may be compromised. If the equipment is in this setting and the sensor becomes dislodged from the patient, the potential for false readings may occur due to environmental "noise" such as light, vibration, and excessive air movement.
- Do not loop the patient cabling into a tight coil or wrap around the equipment, as this can damage the patient cabling.
- Additional information specific to the Masimo sensors compatible with the pulse oximeter, including information about parameter/measurement performance during motion and low perfusion, may be found in the sensor's directions for use (DFU).
- Cables and sensors are provided with X-Cal™ technology to minimize the risk of inaccurate readings and unanticipated loss of patient monitoring. Refer to the Cable or Sensor DFU for the specified duration of the patient monitoring time.

16.4 SpO₂ Accuracy Test

 **Warning**

- A functional tester cannot be used to assess the accuracy of the pulse oximeter.

Assess the SpO₂ accuracy by comparing the readings respectively on the monitor and Index-2 SpO₂ simulator of FLUKE.

16.5 Monitoring Steps

 **Warning**

- Place the SpO₂ sensor properly based on the SpO₂ sensor type. This is especially important for neonates.

Monitor SpO₂:

- 1) Set the patient type;
- 2) Insert the SpO₂ cable connector into the SpO₂ connector of the monitor;
- 3) Place the sensor to an appropriate position on the patient's finger.

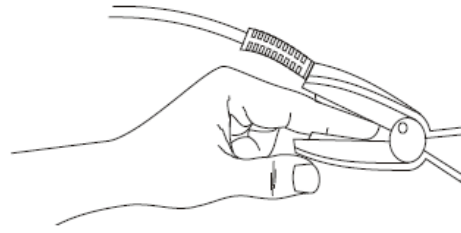
Fig 16-1 Placement of SpO₂ Sensor**Monitor SpO₂ for neonates:**

The SpO₂ for neonates is almost the same as that for adults. The neonatal SpO₂ sensor and its placement is provided below.

➤ Neonatal SpO₂ Sensor

The neonatal SpO₂ sensor consists of the Y-shaped SpO₂ sensor and neonatal SpO₂ sensor cover. Insert the LED end and PD end of the Y-shaped SpO₂ sensor respectively to the upper and lower slot of the neonatal SpO₂ sensor cover as shown in Fig. 16-2. The assembled neonatal SpO₂ sensor is shown in Fig. 16-3.

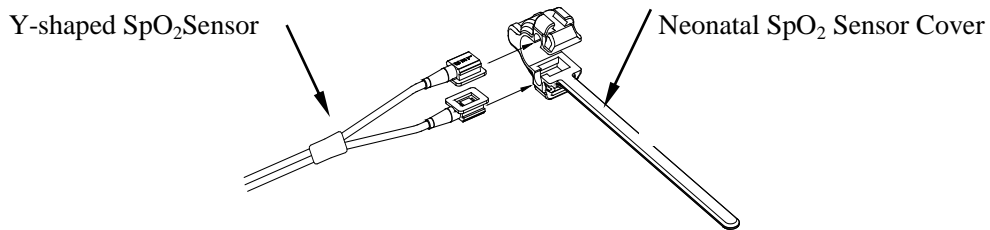
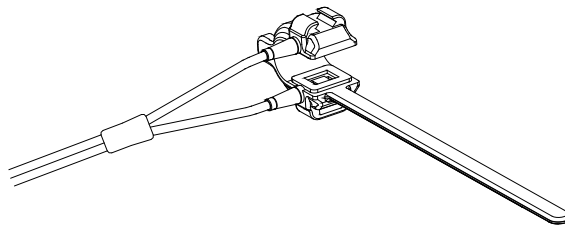
Fig 16-2 Neonatal SpO₂ SensorFig 16-3 Neonatal SpO₂ Sensor➤ Placement of Neonatal SpO₂ Sensor

Clip the SpO₂ probe to the newborn's hand or foot (as shown in Figure 16-4). Hold the SpO₂ probe, pull the strap and place the 'V' shaped edge on one side of the strap into the 'V' shaped slot on the corresponding side of the sheath. Properly stretch the strap (about 20 mm or so) and place the 'V' shaped edge on the other side of the strap into the 'V' shaped slot on the other side of the sheath. Then loosen the strap and thread the strap into the first latch to lock the strap with the 'V' shaped edges on both sides of the strap and the 'V' shaped slots on

both sides of the sheath. If the strap is too long, it can be threaded into the second latch. The SpO₂ probe must be positioned so that the optoelectronic component can be in the correct facing position. Also, be careful not to pull the strap too long, as this will result in inaccurate measurements and severe blockage of blood circulation.



Fig 16-4 Placement of Neonatal SpO₂ Sensor

16.6 Measurement Restrictions

In operations, the following factors may affect the SpO₂ measurement accuracy:

- 1) High-frequency radio interference, whether from the monitor or from the electrosurgical equipment connected to the monitor. To minimize radio interference, other electrical equipment that emits high-frequency transmission should not be in close proximity to the monitor.
- 2) Do not use the oximeter or SpO₂ sensor during MRI scanning, or the induced current may cause burns.
- 3) Intravenous dyes.
- 4) The patient moves frequently.
- 5) Ambient ray radiation.
- 6) The sensor is fixed improperly or in an improper position on the patient.
- 7) Improper sensor temperature.
- 8) The sensor is placed on a limb with blood pressure cuff, ductus arteriosus or intravenous tube.
- 9) Concentration of the non-functional hemoglobin, like COHb or MetHb.
- 10) Low SpO₂.
- 11) Poor circulation perfusion at the tested part.
- 12) The shock, anemia, hypothermia and vasoconstrictors may reduce the arterial blood flow to a level that is not measureable.
- 13) The SpO₂ measurement accuracy depends also on the absorption of the lights with special wavelength by oxyhemoglobin and reduced hemoglobin. If any other substance also absorbs such lights, like COHb, MetHb, methylene blue or indigo carmine, you may obtain a false or low SpO₂ value.

16.7 SpO₂ Setup

16.7.1 Set Off Level

Enter [User Maintain] → [Alarm Setup] → [SpO₂ Sensor Off Level].

16.7.2 Smart Alarm

- 1) Select the SpO₂ parameter area to enter [SpO₂ Setup] → [SatSecond] (Saturation Seconds).
- 2) Select [10], [25], [50], [100] or [Not Allowed].

Note: this function is available for NELLCOR SpO₂ only.

The smart alarm is designed to reduce false alarms and keep the clinician informed of the SpO₂ changes more accurately and timely. For example, if you set [Sat second] to [50] and the high and low alarm limit of NELLCOR SpO₂ respectively to 97% and 90%, and the measured SpO₂ value keeps at 80% for 3s and then to 78% for 2s, the monitor will provide audible and visual alarm indications 5s after the SpO₂ value goes beyond the alarm limit and the circle beside the SpO₂ value will return to the origin.

Calculation method:

Percentage points × seconds = Sat second (integer)

The calculated Sat second is displayed as follows:

% SpO ₂	Seconds	Sat second
--------------------	---------	------------

(90%-80%)	× 3	= 30
-----------	-----	------

(90%-78%)	× 2	= 24
-----------	-----	------

Total Sat second = 54

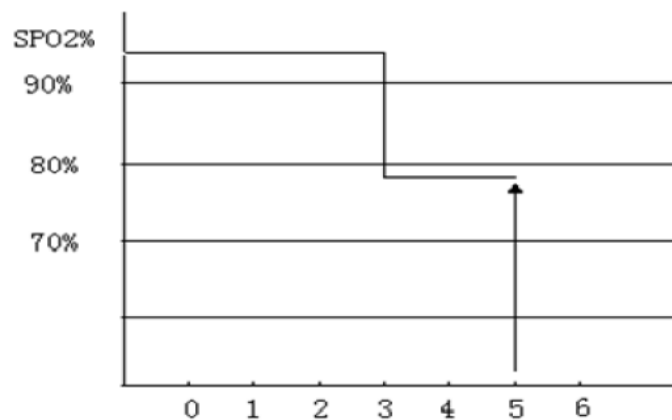

Fig 16-5AnExample

In the above Sat second example:

About 4.9s later, the monitor will report a Sat second alarm because you've set [Sat second] to [50], smaller than 54.

The SpO₂ value may fluctuate for a few seconds rather than remain unchanged. Usually the patient's SpO₂ value fluctuates within the alarm limit and sometimes goes beyond the alarm limit. The monitor accumulates the positive and negative percentage points until the set value of [Sat second] is reached or the patient's SpO₂ value remains within the alarm limit.

16.7.3 Smart Pulse Tone

If smart pulse tone is enabled, you can hear the pulse tone even when the signal is unstable or the equipment is in a noisy environment. You won't hear the pulse tone in the case of unstable signal or ambient noise if this function is disabled.

Set [Smart Tone]:

- 1) Select the SpO₂ parameter area to enter [SpO₂ Setup].
- 2) Select [Smart Tone] to switch between [ON] and [OFF].

Note: this function is available for Masimo SpO₂ only.

16.7.4 NIBP Same Side

Set [NIBP Same Side]:

- 1) Select the SpO₂ parameter area to enter [SpO₂ Setup].
- 2) Select [NIBP Same Side] to switch to [ON].

If you do not select [ON], the weak perfusion caused by NIBP measurement leads to inaccurate SpO₂ measurement or trigger a physiological SpO₂ alarm when the NIBP measurement and SpO₂ measurement are performed on the same limb.

16.7.5 Set Signal IQ

The magnitude of the SpO₂ SIQ waveform provides an assessment of the confidence in the measurement displayed. A higher value indicates higher confidence in the measurement whereas a smaller value indicates lower confidence in the displayed measurement.

Movements usually affect the signal quality. When the arterial pulse reaches the peak, the monitor marks its location on the vertical line (signal indicator). The smart tone volume (if enabled) remains consistent with the indication in the vertical line (the volume of the smart tone will increase or decrease accordingly when the SpO₂ value increases or decreases).

The height of the vertical line represents the quality of the measured signal (the higher line, the higher quality).

Set [Signal IQ] (Signal Identification and Quality):

- 1) Select the SpO₂ parameter area to enter [SpO₂ Setup].
- 2) Select [Signal IQ] to switch between [ON] and [OFF].

Note: this function is available for Masimo SpO₂ and simulated SpO₂ only.

16.7.6 Average Time

The SpO₂ value displayed on the monitor is the average of the SpO₂ values acquired in a given time. Shorter (longer) average time will lead to quicker (slower) response and lower (higher) measurement accuracy of the monitor when the patient's SpO₂ value changes. For a critical patient, please set a short average time so as to analyze his/her condition timely. Set average time:

Masimo SpO₂:

- 1) Select the SpO₂ parameter area to enter [SpO₂ Setup] → [Average Time].
- 2) Select [2-4s], [4-6s], [8s], [10s], [12s], [14s] or [16s].

Comen SpO₂:

- 1) Select the SpO₂ parameter area to enter [SpO₂ Setup] → [Sensitivity].
- 2) Select [High], [Medium] or [Low].

16.7.7 Fast Sat

Fast Sat enables rapid response to, and display of, fast changes in SpO₂ by giving priority to the most recent data. This aids the clinician in clinical settings requiring fast response time such as those seen with induction, intubation, sleep studies and resuscitation.

- 1) Select the SpO₂ parameter area to enter [SpO₂ Setup].
- 2) Select [Fast Sat] (Fast Saturation) to switch between [On] and [Off].

Note: this function is available for Masimo SpO₂ only; if this function is enabled, you can find the prompt message “Fast Sat” at the main screen.

16.7.8 Sensitivity

[Sensitivity] can be set to [Normal], [Maximum] or [APOD] (Adaptive Probe Off Detection). [Maximum] represents the highest sensitivity. In typical monitoring conditions, select [Normal]. If the sensor is likely to fall off the patient due to wet skin, violent movement or other causes, select [Maximum]. If the patient's perfusion level is extremely low, select [APOD].

Set [Sensitivity]:

- 1) Select the SpO₂ parameter area to enter [SpO₂ Setup] → [Sensitivity].
- 2) Select an appropriate [Sensitivity]: [Normal], [Maximum] or [APOD].

Note: this function is available for Masimo SpO₂ only.

16.8 Masimo Information

1) Masimo Patent Information

Masimo Patents: www.masimo.com/patents.htm

2) No Implied License Statement

Possession or purchase of this equipment does not convey any express or implied license to use the equipment with unauthorized sensors or cables which would, alone or in combination with this equipment, fall within the scope of one or more of the patents relating to this equipment.

3) Other Information

©2006 Masimo Corporation. Masimo, Radical, Discrete Saturation Transform, DST, Satshare, SET, LNOP, LNCS and LNOPv are federally registered trademarks of Masimo Corporation.

RadNet, Radicalsreen, signal IQ, FastSat, fastStart and APOD are trademarks of Masimo Corporation.

Chapter 17 NIBP Monitoring

17.1 Overview

NIBP monitoring is applicable to adults, children, neonates, pregnant women and pre-eclampsia patients. The monitor uses the vibration method (measuring the cuff pressure vibration amplitude) to measure the noninvasive blood pressure (NIBP). Blood pressure changes cause the cuff vibration. The pulse wave range varies from the cuff pressure and when the maximum pulse wave range is obtained, according to the corresponding proportionality calculating the pulse wave ranges of systolic and diastolic pressure, the systolic pressure and diastolic pressure can be obtained. The BP values measured by this equipment are equivalent to the values measured by invasive method. The error complies with the requirements of IEC80601-2-30. The brachial artery is selected for verification in the clinical trials using the invasive method.

When making measurements on children and newborns, it must be ensured that the correct mode setting has been selected (see Patient Information Menu Settings). Using the wrong patient mode may jeopardize patient safety as higher adult blood pressure levels are not applicable to children and newborns.

NIBP measurement can be applied in electrosurgical operations and defibrillator discharges according to IEC80601-2-30.

17.2 NIBP Display

The NIBP measurement results are displayed in the parameter area. The figure below is for reference only. The actual display may be slightly different from this figure.

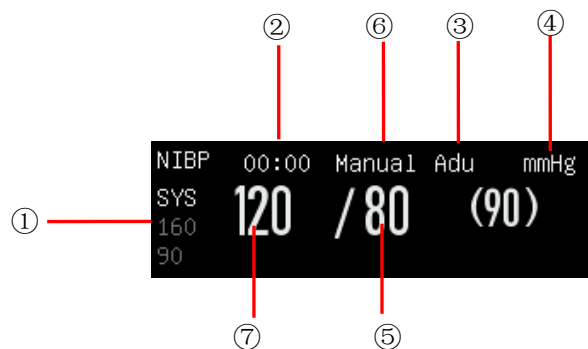

①	Alarm limit of systolic pressure	②	Time of the previous measurement
③	Patient type: ADU, PED or NEO.	④	Pressure unit: mmhg or kPa
⑤	Diastolic pressure	⑥	Measurement mode: auto, manual or continual.
⑦	Systolic pressure		

17.3 Safety Instructions



Warning

- Before the NIBP measurement, make sure the selected monitoring mode is appropriate for the patient (adult, pediatrics or neonate). It is dangerous to select a non-neonatal mode for neonatal patients.
- Do not place the cuff on a limb with intravenous infusion or cannula in place, or the tissues around the cannula may be damaged when the infusion is slowed or blocked in the cuff inflation process.
- Make sure the inflation tube connecting the blood pressure cuff to the monitor is not obstructed or entangled, otherwise it will cause harm to the patient.
- Do not perform the NIBP measurement to a patient with sickle cell disease or existing or expected skin lesions.
- For a patient with severe disturbances of blood coagulation, please determine the applicability of automatic NIBP measurement based on clinical evaluation, or the limb contacting the cuff may suffer from hematoma due to friction.
- Frequent measurements could cause blood flow disturbance and injure the patient.
- To prevent further injury, do not place the cuff on any wound.
- Do not place the blood pressure cuff on a limb under intravenous infusion, intravenous therapy or arteriovenous shunt, or the transient blood flow disturbance will injure the patient.
- Do not place the cuff on the arm at the same side as mastectomy or lymph node dissection.
- The increasing cuff pressure could cause transient function failure to other monitoring equipment used on the same limb.
- If the measurement time is too long (such as repeated use interval and continuous measurement mode), friction between the cuff and the limb may cause purpura. Ischemia and nerve damage. When monitoring patients, always check the color, temperature, and sensitivity of the distal limbs. Once any abnormality is found, the cuff placement position should be changed or blood pressure measurement should be stopped
- When clinicians get unexpected readings, they should take corresponding measures based on the actual clinical conditions of the patient, such as retesting or adjusting the cuff position.

17.4 NIBP Measurement

17.4.1 Preparations for Measurement



Warning

- The measurement location may affect the NIBP measurement value.

- 1) Connect the inflation tube to the blood pressure cuff.
- 2) Connect the inflation tube to the NIBP connector of the monitor without compressing or blocking the pressure tube.
- 3) Use the correct size cuff and make sure the airbag is not folded or twisted.
 - ◆ An incorrect cuff size or a folded or twisted airbag causes inaccurate measurement. Make sure the cuff is deflated thoroughly. The cuff width should be 40% (50% for neonates) of the limb perimeter or 2/3 of the upper arm length. The inflated part of the cuff should be long enough to circle 50~80% of the limb.

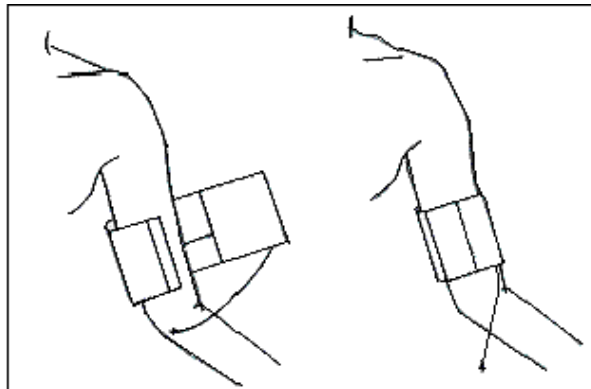

- 4) Wrap and secure the cuff around the limb and make sure the cuff is at the same level as the patient's heart. If you fail to do so, use the following methods to correct the measurement result:
 - ◆ Make sure the mark "φ" is located at an appropriate artery. Do not wrap or secure the cuff too tightly, or the distal extremity may suffer from discoloration or ischemia. Regularly check the skin condition of the contact part and the color, temperature and feeling of the limb which wears the cuff. If the skin condition changes or the blood circulation of the limb is affected, move the cuff to another body part for continued measurement or stop the NIBP measurement immediately. In auto measurement mode, observe the skin condition frequently.
 - ◆ If the cuff is not at the same level as the heart, use the following correction formulas:
 - ◇ If the cuff is at a higher level than the heart: displayed NIBP value + 0.75mmHg (0.10kPa) × level difference (cm).

- ◇ If the cuff is at a lower level than the heart: displayed NIBP value - 0.75mmHg (0.10kPa) × level difference (cm).

17.4.2 Measurement Restrictions

The vibration method has some restrictions, depending on the patient's condition. The vibration method detects the regular pulse wave generated by arterial pressure. If the patient's condition makes it difficult to detect such waves, the measured pressure value is unreliable and the pressure measurement time increases. In the following cases, the pressure measurement is affected.

1) Patient Movement

If the patient is moving, trembling or under cramps, which may affect the detection of arterial pressure pulse, the NIBP measurement is unreliable or impossible and the pressure measurement time will increase.

2) Arrhythmia

If the patient has irregular heartbeats due to arrhythmia, the NIBP measurement is unreliable or impossible and the pressure measurement time increases.

3) Heart-lung Machine

Do not perform the NIBP measurement if the patient is connected to a heart-lung machine.

4) Pressure Changes

If the patient's blood pressure changes rapidly within a certain time when the monitor analyzes the arterial pressure pulse for measurement purpose, the NIBP measurement is unreliable or impossible.

5) Severe Shock

If the patient is under severe shock or hypothermia, the NIBP measurement is unreliable as the reduced blood flow to the periphery will cause lower arterial pulse.

6) Extreme HR

Do not perform the NIBP measurement if the HR is lower than 40bpm (beats per minute) or higher than 240bpm.

7) Obese Patient

Due to the thick fat layer of the limb, the vibration from the artery fails to reach the cuff, which causes lower measurement accuracy than in normal weight cases.

8) Patient with Hypertension

To measure the NIBP of a patient with hypertension accurately, follow the steps below:

- Adjust his/her sitting posture until:
 - ◇ He/she sits comfortably;
 - ◇ His/her legs are not crossed;
 - ◇ His/her feet are laid flat on the ground;
 - ◇ He/she leans his/her back against the chair and puts his/her hands on the desk;

- ◇ The middle part of the cuff is at the same level as his/her right atrium.
- Ask the patient to relax as much as possible and not talk during the measurement.
- 5 min elapses before the first reading is taken.

17.4.3 Start the Measurement

17.4.3.1 Start the Manual Measurement

Select the NIBP parameter area to enter the setup menu→[Measure Mode]→[Manual] or select quick key [Mode Setup], then select [Manual]. Whether to start the NIBP measurement depends on the user's need.

17.4.3.2 Start the Whole Point Measurement

1. Select the NIBP parameter area to enter the setup menu→[Whole point Mea.], and switch it to "On".
2. Select the [NIBP] key on the control panel and manually start the first measurement. After the first measurement, the monitor will automatically and repeatedly start the measurement according to the interval time set before.

For example, if you start the first measurement at 08:23, and set [Interval] to [5min], the monitor will operate the next measurement at 08:25. The measurement will start in synchronization with the clock, and then at 08:30 by parity of reasoning.

**Note**

- The monitor operate the [Whole point Mea.] only when the [Interval] is not less than 5min.

17.4.3.3 Start the Interval Measurement

1. Select the NIBP parameter area to enter the setup menu→[Measure Mode]→[Auto].
2. Select the [Interval]: from 1 minute to 720 minutes.
3. Select the [NIBP] key on the control panel and manually start the first measurement. After the first measurement, the monitor will automatically and repeatedly start the measurement according to the interval time set before.

17.4.3.4 Start the Continual Measurement

Select the NIBP parameter area to enter [NIBP Setup]→ [Continual Measure], then start the 5min measurement continuously.

 **Note**

- If you have any doubt about the reading accuracy, check the patient's vital signs first before checking the monitor functions. Use the same method for checking the monitor as checking the patient.
- In order not to injure the patient, the [Continual Measure] mode is not available for the patient [Neo].
- The automatic measurement results are affected by the temperature, RH and altitude limit.

 **Warning**

- If any liquid splashes onto the monitor or its accessories, especially when it is likely to flow into the monitor or its tubes, please contact the maintenance department of the hospital.

17.4.4 Stop the Measurement

When a measurement is complete, the monitor can automatically deflate and stop the measurement. During the measurement, you can press the [NIBP] key on the control panel to stop the measurement.

17.5 NIBP Setup

17.5.1 Patient Type

The patient type includes adult, pediatric and neonate. The patient type is the same as the setting of [PAT Type] in [Patient Info].

- 1) Select the NIBP parameter area to enter [NIBP Setup] → [Pat Type].
- 2) Select [ADU], [PED] or [NEO].

17.5.2 Initial Pressure

- 1) Select the NIBP parameter area to enter [NIBP Setup] → [Initial Pressure].
- 2) Set an appropriate value for [Initial Pressure].

17.6 NIBP Reset

Select [NIBP] in the parameter area to enter [NIBP Setup] → [Reset]. This function can restore the initial pressure of the blood pressure pump. If the blood pressure pump works improperly, use this function to check the blood pressure pump and automatically recover in the event of failures.

17.7 Assistance in Venipuncture

Inflate the NIBP cuff to a pressure approximate to the diastolic pressure to block the vein vessel and assist in venipuncture.

- 1) Select the NIBP parameter area to enter [NIBP Setup] → [Other Setup] → [Cuff Pressure] and then select an appropriate pressure value.
- 2) Select [Venipuncture Start], then the key change to [Venipuncture Stop].
- 3) Puncture the vein and take the blood sample.
- 4) Press the [NIBP] key or the [Venipuncture Stop] key to deflate the cuff. If you fail to do so, the cuff automatically deflates after a set time.

In the venipuncture process, the NIBP parameter area displays the cuff pressure and remaining time of venipuncture.

Chapter 18 CO₂ Monitoring

Note

- The function is only applicable to S5.

18.1 Overview

The monitor uses the CO₂ measurement to monitor the patient's respiration status and control patient's ventilation. There are two methods of measuring the CO₂ in the patient's airway:

- ◆ Sidestream measurement method: take sample from the respiratory gas module in the patient's airway at a constant flow rate and use the built-in remote CO₂ module in the measurement system to analyze them.
- ◆ Mainstream measurement method: install the CO₂ sensor onto the airway connector of the respiratory system inserted directly into the patient.

The measurement principle is IR emission. Use the optical detector to measure the intensity of the infrared rays penetrating the respiratory system. The intensity depends on the CO₂ concentration as some infrared ray is absorbed by CO₂ molecules.

The CO₂ measurement involves the following parameters (see the figure below):

- ◇ CO₂ waveform ①
- ◇ End-tidal CO₂ (EtCO₂): the maximum partial pressure of CO₂ at the end of respiration ②
- ◇ EtCO₂ alarm limit ③
- ◇ Fraction of inspiratory CO₂ (FiCO₂): the minimum CO₂ value during inspiration ④
- ◇ Airway respiration rate (AWRR): the respiration per minute calculated from the CO₂ waveform ⑤
- ◇ Measurement unit ⑥

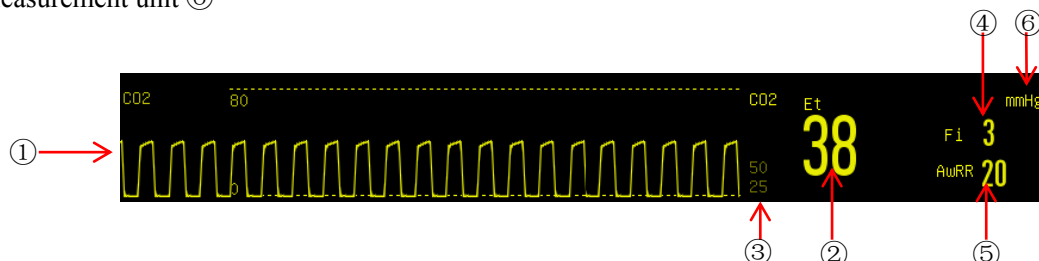

Warning

- Try to avoid collision and vibration of the CO₂ module.

**Note**

- Do not use the monitor in an environment with any flammable anesthetic gas.
- Only the trained professionals familiar with this manual are allowed to operate the monitor.

18.2 Measurement Principle and Working Process

The CO₂ measurement principle is mainly based on the feature that CO₂ can absorb infrared light with a wavelength of 4.26 μm. The measurement method is to send CO₂ gas to the measurement chamber. One side is irradiated with infrared rays, and the other side is measured by a sensor to measure the degree of attenuation of the received infrared rays. The degree of attenuation is proportional to the CO₂ concentration.

The conversion relational expression between CO₂ partial pressure and CO₂ concentration is:

CO₂ partial pressure (mmHg) = CO₂ concentration (%) × P_{amp} (ambient pressure)

For instance: 5% CO₂ at 760mmHg = 38mmHg

5% CO₂ at 700mmHg = 35mmHg

The CO₂ module uses the Auto run command measurement mode, and the waveform sampling rate is performed every 31 milliseconds.

18.3 Adverse Effects on Performance

1) The following factors are known adverse effects on the specified performance:

- Quantitative effects of RH or condensation;
- Quantitative effects of barometric pressure;
- Interfering gas or water vapor; and
- Other interference sources.

2) Gas Measurement Unit

Use volume percentage as the gas concentration unit. The concentration calculation formula is:

$$\%gas = \frac{\text{Partial pressure of gas component}}{\text{Total pressure of gas mixture}} * 100$$

Use the cup-making pressure sensor of the ISA gas analyzer to measure the total pressure of the gas mixture.

To convert into any other unit, use the actual barometric pressure sent from the ISA sidestream (IRMA mainstream).

CO₂ (mmHg) = (CO₂ Concentration) × (Barometric Pressure from ISA (kPa)) × (750 / 100).

Take 5.0 vol% CO₂ @ 101.3kPa as an example: 0.05 × 101.3 × 750 / 100 = 38 (mmHg).

3) Effects of RH

The partial pressure and volume percentage of the CO₂, N₂O, O₂ and anesthetic gas depend on the water vapor content in the measured gas. Calibrate the O₂ measurement, and the displayed value at the ambient

temperature and RH level will be 20.8 vol%, not the actual partial pressure. The 20.8 vol% O₂ represents the actual O₂ concentration of the room air (water concentration: 0.7 vol %) (for example, 25 °C and 23% RH @ 1013hPa). The monitor displays the actual partial pressure at the current RH level when measuring the CO₂, N₂O and anesthetic gas (like all gases measured by infrared cell).

In the patient's alveoli, the water vapor in the respiratory gas is saturated (BTPS) at the body temperature.

Before the acquired respiratory gas in the sampling tube is transferred to the ISA sidestream gas analyzer, its temperature becomes approximate to the ambient temperature. No water enters the ISA gas analyzer after the Nomoline sampling tube removes all condensed water. The RH of the acquired gas is approximately 95%.

Use the following formula to calculate the CO₂ value at BTPS:

$$EtCO_2(BTPS) = EtCO_2 * \left(1 - \left(\frac{3.8}{P_{amb}} \right) \right)$$

In the above formula:

EtCO₂: EtCO₂ value [vol%] sent from ISA

Pamb: barometric pressure [kPa] sent from ISA

3.8 : typical partial pressure [kPa] of the water vapor condensed between the patient circuit and ISA

EtCO₂ (BTPS) = EtCO₂ concentration [vol%] at BTPS

It is assumed that the O₂ is calibrated by the room air at 0.7 vol% H₂O (RH).

18.4 CO₂ Measure



WARNING

- **Check the airway adapter before use. Replace it if the airway adapter suffers from any exterior damage or breakage.**
- **Turn it off when the CO₂ module is idle, or it will remain in working state and its service life will be shortened.**
- **Hang the external CO₂ analyzer onto the CO₂ sensor holder on the back housing of the device reliably against falling and damage.**
- **MAKE SURE all connections are firm and reliable. Any leakage will cause the respiratory gas of the patient to include the ambient air, resulting in incorrect readings.**
- **Check CO₂ sensor regularly for avoiding excessive humidity or secretion accumulation.**

 **CAUTION**

- The Water Filter Assembly of Respironics sidestream CO₂ sensor will last up to 12 hours when used without the Dehumidification Tubing in a non-humidified environment.
- The Water Filter Assembly of Respironics sidestream CO₂ sensor will last up to 120 hours when used with the Dehumidification Tubing under conditions of ISO 80601-2-55 § 201.7.9.2.9.101b.
- The life of the water filter assembly of Respironics sidestream CO₂ sensor will be significantly reduced if used in a humidified circuit without dehumidification tubing.

The Dehumidification Tubing is a replaceable part and is attached directly to the Water Filter Assembly. The Dehumidification tubing should be regularly examined for cracks or visual contaminants on its walls. If these conditions exist, the Dehumidification Tubing should be discarded in accordance with clinical protocol and replaced with a new part.

18.4.1 Preparations for Mainstream CO₂ Sensor Connection

- 1) Connect the adapter cable with the CO₂ sensor cable (no need for Comen mainstream CO₂).
- 2) Insert the other end of the adapter cable into the CO₂ sensor interface on the device.
- 3) Wait for a moment until the sensor reaches its working temperature and a stable thermal state.
- 4) Fix the sensor to the airway adapter.

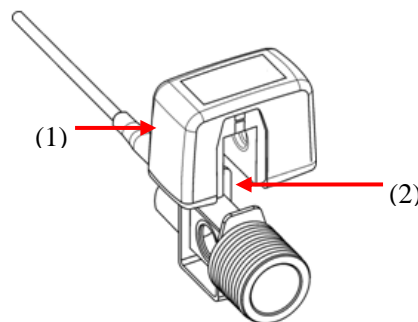

(1) Sensor (2) Airway adapter

- 5) For zero calibration of the sensor, refer to "**Section 18.5 Zero CO₂ Sensors**".
- 6) Install the airway adapter onto one end of the breathing tube, between the Y-shaped tube (see figure below).

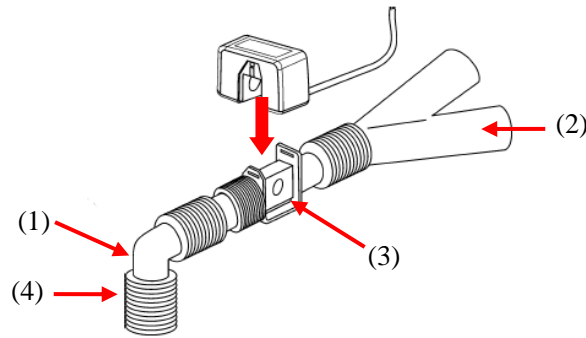

- (1) Elbow tube (2) Y-shaped tube (3) Airway adapter (4) Breathing tube port

- 7) Make sure the airway is tight.
- 8) Set CO₂ parameters; please refer to “**Section 18.6 CO₂ Setup**” for more information.
- 9) Start measurement.

18.4.2 Preparations for Respironics Sidestream CO₂ Sensor

- 1) Connect one end of Respironics patch cable to the CO₂ sensor cable.
- 2) Connect the other end of patch cable to the CO₂ interface of the monitor
- 3) Connect one end of the drying tube to the water filter component, and the other end with the sampling line, thus forming the sampling line component.
- 4) Insert the sampling line component into the CO₂ interface. A sound of “click” represents it is inserted correctly and locked in place.
- 5) Wait for a moment until the sensor reaches its working temperature and a stable thermal state.
- 6) Zero the sensor; please refer to "**Section 18.5 Zero CO₂ Sensors** " for more information.
- 7) Set CO₂ parameters; please refer to "**Section 18.6 CO₂ Setup**" for more information.
- 8) For the patient with tracheal cannula: install the airway adapter of sampling line onto one end of the breathing tube, exactly speaking, between the elbow tube and the Y-shaped tube, shown as the figure below:

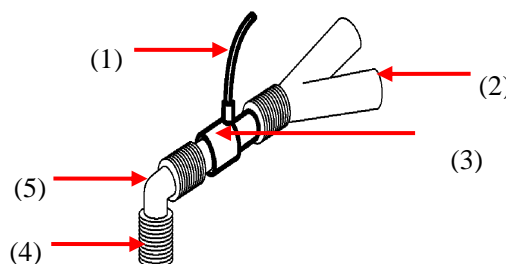

- (1) Sampling line (2) Y-shaped tube (3) Airway adapter (4) Breathing tube port (5) Elbow tube

- 9) Wear the nasal cannula for the patient without tracheal cannula: wear the nasal or oral-nasal O₂ cannula

onto the patient's face, connect the O₂ supply tube to the O₂ supply system and set the O₂ flow as directed.

- 10) Connect an exhaust pipe to the vent on the sensor so as to exhaust waste gases into the waste gas treatment system.
- 11) Start the measurement after confirming the airway tightness.

18.4.3 Preparations for Masimo Sidestream CO₂ Sensor

- 1) Connect one end of Masimo patch cable to the CO₂ sensor cable.
- 2) Connect the other end of patch cable to the CO₂ interface of the monitor.
- 3) Insert sampling line into the interface of CO₂ sensor reliably until you hear a "click" sound.
- 4) Wait for a moment until the sensor reaches its working temperature and a stable thermal state.
- 5) Zero the sensor; please refer to "**Section 18.5 Zero CO₂ Sensors**" for more information.
- 6) Check before its use; please refer to "**Section 18.4.3.1 Pre-use Checks**" for more information.
- 7) Set CO₂ parameters; please refer to "**Section 18.6 CO₂ Setting**" for more information.
- 8) For the patient with tracheal cannula: install the airway adapter onto one end of the breathing tube, exactly speaking, between the elbow tube and the Y-shaped tube, shown as the figure below:

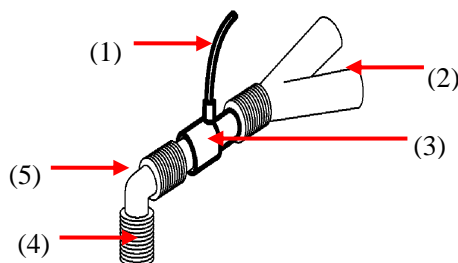

(1) Sampling line (2) Y-shaped tube (3) Airway adapter (4) Breathing tube port (5) Elbow tube

- 9) Wear the nasal cannula for the patient without tracheal cannula: wear the nasal or oral-nasal O₂ cannula onto the patient's face, connect the O₂ supply tube to the O₂ supply system and set the O₂ flow as directed.
- 10) Connect an exhaust pipe to the vent on the sensor so as to exhaust waste gases into the waste gas treatment system.

18.4.3.1 Pre-use Checks

Perform the following operations before connecting the sampling line to the breathing tube:

- 1) Connect the sampling line to the CO₂ interface.
- 2) Check if the sensor interface LED remains green stably (an indication of normal system).

- 3) Expire into the sampling line and check if the ventilator displays the effective CO₂ waveform and value.
- 4) Block the sampling line with a fingertip and wait 10s.
- 5) Check if the prompt message "Sampling line clogged" appears and the sensor interface LED flashes in red.
- 6) Check the tightness of the patient circuit connected to the sampling line when appropriate.

 **WARNING**

- **Place the IRMA sensor, if not protected by HME, with the status LED pointing up.**
- **Do not stretch the cable of the ISA sidestream gas analyzer.**
- **Operate the ISA sidestream gas analyzer in the specified working temperature environment only.**

 **Note**

- **In order to prevent the condensed water dropping into the gas sampling line and blocking it, the gas sampling line connection end of the airway adapter should point up.**

18.4.4 Preparations for Comen Sidestream CO₂ Sensor

- 1) Insert CO₂ cable to the ventilator's CO₂ interface.
- 2) Wait for a moment until the sensor reaches its working temperature and a stable thermal state.
- 3) Insert sampling line into the interface of CO₂ sensor reliably until you hear a click sound.
- 4) Zero the sensor; please refer to "**Section 18.5 Zero CO₂ Sensors**" for more information.
- 5) Set CO₂ parameters; please refer to "**Section 18.6 CO₂ Setting**" for more information.
- 6) For the patient with tracheal cannula: install the airway adapter of sampling line onto one end of the breathing tube, exactly speaking, between the elbow tube and the Y-shaped tube, shown as the figure below:

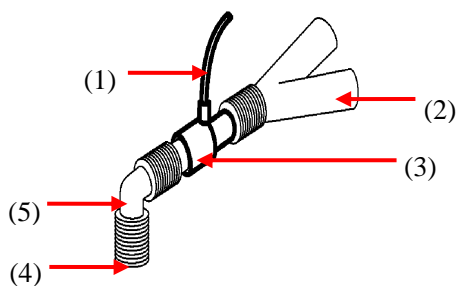

(1) Sampling line (2) Y-shaped tube (3) Airway adapter (4) Breathing tube port (5) Elbow tube

- 7) Wear the nasal cannula for the patient without tracheal cannula: wear the nasal or oral-nasal O₂ cannula onto the patient's face, connect the O₂ supply tube to the O₂ supply system and set the O₂ flow as directed.
- 8) Connect an exhaust pipe to the vent on the sensor so as to exhaust waste gases into the waste gas treatment system.
- 9) Start the measurement after confirming the airway tightness.

18.5 Zero CO₂ Sensor



WARNING

- If the alarm message "CO₂ Need Zero" appears directly after zeroing, please re-zero it.

18.5.1 Zero Masimo CO₂ Sensor

The Masimo CO₂ sensor performs auto zeroing by switching the gas sample source from respiration circuit to ambient air. Auto zeroing starts after the sensor reaches its working temperature (usually 30min after startup) and is performed then every 24 hours. Masimo CO₂ sensor finishes auto zeroing within 3s.

18.5.2 Zero Respironics & Comen Mainstream CO₂ Sensors

In order to eliminate the effect of baseline drift on measurement results and obtain accurate measurement results, please zero it before using CO₂ sensor to monitor the patient. Usually, the CO₂ sensor will be auto zeroed when necessary. You can zero it manually when you consider it necessary by the following steps:

- 1) Connect the sensor following steps 1-4 in section *18.4.1 Preparations for Mainstream CO₂ Sensor Connection*.
- 2) Expose the sensor to room air and keep it away from all CO₂ sources, including ventilator, patient's breath and user's breath.
- 3) Select CO₂ parameter tile or waveform tile to enter [CO₂] menu.
- 4) Select [Zero] to zero CO₂ sensor, and the message [Zeroing...] will be displayed on the screen; after zero calibration, the corresponding message will also be displayed on the screen.

18.5.3 Zero Respironics & Comen Sidestream CO₂ Sensors

- 1) Connect Respironics Sidestream CO₂ Sensor following steps 1-5 in section *18.4.2 Preparations for Respironics Sidestream CO₂ Sensor*, or connect Comen Sidestream CO₂ Sensor following steps 1-3 in section *18.4.4 Preparations for Comen Sidestream CO₂ Sensor*.
- 2) After preheating, expose the sampling line to room air and keep it away from all CO₂ sources, including ventilator, patient's breath and user's breath.
- 3) Select CO₂ parameter tile or waveform tile to enter [CO₂] menu.
- 4) Select [Zero] to zero CO₂ sensor, and the message [Zeroing...] will be displayed on the screen; after zero calibration, the corresponding message will also be displayed on the screen.



NOTE

- For the best zeroing result, please zero Respironics CO₂ sensor after preheating for 5min.

18.6 CO₂ Setup

18.6.1 Work Mode

Follow the steps below to set CO₂ work mode after connecting the CO₂ module to the monitor. Turn off the CO₂ module for service life protection purpose once the CO₂ measurement is stopped.

- 1) Select the CO₂ parameter area to enter [CO₂ Setup] → [Work Mode].
- 2) Select [Standby] or [Measure].

18.6.2 Pressure Unit

Enter [User Maintain] to set [Press. Unit].

18.6.3 Gas Compensation

- 1) Select the CO₂ parameter area to enter [CO₂ Setup].
 - ◆ Masimo CO₂ module:
 - ✧ Select [O₂ Compensate] → [High], [Med] or [Low].
 - ✧ Select [N₂O Compensate] → [On] or [Off].
 - ◆ Respironics and Comen CO₂ module:
 - ✧ Select [O₂ Compensate] → set the O₂ compensation value.

**Warning**

- Set [O₂ Compensate] and [N₂O Compensate] based on the actual conditions, or the measurement results could differ greatly from the actual values which can cause misdiagnosis.

18.6.4 No Breath Alarm Delay

No breath detection is to detect the longest interval between two adjacent RESPs. When the actual no-breath time of the patient exceeds the set apnea time, the monitor responds to apnea alarms according to the value of [No Breath Alm Delay].

To set the [No Breaths Timeout]:

- 1) Select the CO₂ parameter area to enter [CO₂ Setup] → [No Breaths Timeout] and set an appropriate detection time.

To set the [No Breath Alm Delay]:

- 1) Enter [User Maintain] → [Other Setup].
- 2) Set [No Breath Alm Delay] to [Off], [10s], [15s], [20s], [25s], [30s], [35s], [40s], [45s], [50s], [55s] or [1min].

If you select [Off], the alarm delay function is disabled. The monitor responds to no-breath alarms (if any) immediately.

18.6.5 Altitude

For Masimo CO₂ module, there is no need to set the altitude. It is equipped with automatic barometric pressure compensation.

For Respirationics and Comen CO₂ module:

- 1) Select the CO₂ parameter area to enter [CO₂ Setup] → [Altitude Unit].
- 2) Select the CO₂ parameter area to enter [CO₂ Setup] → [Altitude].
- 3) Set an altitude value, and the monitor is automatically set to [Baro. Pressure] (Barometric Pressure) based on the altitude value.

Altitude, Barometric Pressure & ETCO₂ Table

Altitude		Barometric Pressure	5% CO ₂
Feet	Meters	mmHg	EtCO ₂ mmhg
Sea Level (0)	Sea Level (0)	760	38
500	152.4	745	37
750	228.6	738	37
1,000	304.8	731	37

CO₂ Monitoring

1,500	457.2	717	36
2,000	609.6	704	35
2,500	762	690	35
3,000	914.9	677	34
3,500	1066.8	665	33
4,000	1219.2	652	33
4,500	1371.6	640	32
5,000	1524	628	31
5,500	1676.4	616	31
6,000	1828.8	604	30
6,500	1981.2	593	30
7,000	2133.6	581	29
7,500	2286	570	29
8,000	2438.4	560	28
8,500	2590.8	549	27
9,000	2743.2	539	27
10,000	3048	518	26
10,500	3200.4	509	25
11,000	3352.8	499	25
11,500	3505.2	490	24
12,000	3657.6	480	24
12,500	3810	471	24
13,000	3962.4	462	23
13,500	4114.8	454	23
14,000	4267.2	445	22
14,500	4419.6	437	22
15,000	4572	428	21
15,500	4724.4	420	21
16,000	4876.8	412	21
16,500	5029.2	405	20
16,800	5120.6	400	20

Note: It is assumed that the sea level is of 760mmHg and 0°C, and that the ambient temperature is 0°C when calculating barometric pressure based on elevation. For details, please refer to the table.

**Warning**

- **The monitor has no automatic air compensation function. Set the correct altitude before using the CO₂ measurement function for the first time. Incorrect altitude causes incorrect CO₂ reading (5% CO₂ error per 1,000m altitude difference).**

18.6.6 Balance Gas

Only the Respirationics and Comen CO₂ module requires setting the balance gas manually (for Masimo CO₂ module, the balance gas is automatically set).

- 1) Select the CO₂ parameter area to enter [CO₂ Setup] → [Balance Gas].
- 2) Select [Room Air], [N₂O] or [Helium].

18.6.7 Waveform Scale

If you adjust the scale value, the waveform amplitude changes accordingly.

Select the CO₂ waveform area to enter [Waveform Setup] → [Scale].

18.7 Masimo Sidestream Module Related Information**18.7.1 CO₂ Module LED**

LED indications:

Indication	Status
Steady green light	System OK
Blinking green light	Zeroing in progress
Steady red light	Sensor error
Blinking red light	Check adapter

18.7.2 Warning Information**18.7.2.1 ISA Sidestream Gas Analyzer Warning Information****Warning**

- **The ISA sidestream gas analyzer is intended for use by authorized healthcare professionals only.**
- **Carefully route the sampling line to reduce the risk of patient entanglement or strangulation.**

- Do not lift the ISA gas analyzer by the sampling line as it could disconnect from the ISA, causing the ISA gas analyzer to fall on the patient.
- Dispose Nomoline Family sampling lines in accordance with local regulations for biohazardous waste.
- Use only airway T-adapters with the sampling point in the center of the adapter.
- Do only use sample lines intended for anesthetic agents if N₂O and/or anesthetic agents are being used.
- Do not use T-adapter with infants, as this adds 7 ml dead space to the patient circuit.
- Do not use the ISA gas analyzer with metered-dose inhalers or nebulized medications as this may clog the bacteria filter.
- Since a successful zeroing requires the presence of ambient air (21% O₂ and 0% CO₂), ensure that the ISA is placed in a well ventilated place. Avoid breathing near the ISA sidestream gas analyzer before or during the zeroing procedure.
- Never sterilize or immerse the ISA sidestream gas analyzer in liquid.
- The ISA sidestream gas analyzer is intended only as an adjunct in patient assessment. It must be used in conjunction with other assessments of clinical signs and symptoms.
- Measurements can be affected by mobile and portable RF communications equipment. Make sure that the ISA sidestream gas analyzer is used in the electromagnetic environment specified in this manual.
- Replace the sampling line if the sampling line input connector starts flashing red, or the medical backboard equipment displays a “Check sampling line” message.
- No modification of this equipment is allowed without authorization of the manufacturer. If this equipment is modified, appropriate inspection and testing must be conducted to ensure continued safe operation.
- The ISA sidestream gas analyzers are not designed for MRI environments.
- During MRI scanning, ISA must be placed outside the MRI suite.
- Use of high frequency electrosurgical equipment in the vicinity of the ISA/medical backboard equipment may produce interference and cause incorrect measurements.

Caution

- The ISA analyzers should be securely mounted in order to avoid the risk of damage to the ISA.
- Do not operate the ISA sidestream gas analyzer outside the specified operating environment.
- (US Only) Caution: Federal law restricts this equipment to sale by or on the order of a physician.
- For professional use. See instructions for use for full prescribing information, including indications, contraindications, warnings, precautions and adverse events.

18.7.3 Airway Obstruction

When the anesthetic gas airway is obstructed, on the screen there will be such a prompt message as “Sampling Line Clogged”; under such a circumstance, replace the Nomoline sampling line.

Warning

- Do not use the ISA gas analyzer together with a quantitative spraying agent or pulverization treatment; otherwise it may result in the clogging of the germ filter.

18.7.4 Discharging Waste Gases

When nitrous oxide and/or an anesthetic gas are/is used, you should prevent these gases from polluting the operating room. The gas discharging outlet should be connected to (via the gas discharging pipe connected to the sample gas outlet of the host equipment):

A discharging system (used for discharging collected gases) or the patient circuit (used for the back flowing of collected gases)







Warning













- **Anesthetics: If you measure the parameter of a patient who is using or recently has used an anesthetic, the gas discharging port on the module must be connected to a scavenging system or the patient circuit (on the anesthesia machine or the ventilator), so as to prevent medical personnel from inhaling the anesthetic.**

18.7.5 Leakage Check

1. Connect a new Nomoline sampling line with male Luer lock to the ISA gas inlet connector and check that the gas inlet connector shows a steady green light.
2. Connect a short silicon tubing with an inner diameter of 3/32" (2.4 mm) to the Nomoline male Luer.
3. Exhale a long breath into the silicon tubing until the CO₂ concentration is greater than 4.5 vol% or 34 mmHg.
4. Quickly connect the silicon tubing tightly to the exhaust port.
5. Wait for 1 minute until the CO₂ concentration has stabilized. Note the value.
6. Wait 1 minute and check that the CO₂ concentration has not decreased more than 0.4 vol% or 3 mmHg. If it has decreased more there is a major leakage in the ISA unit or in the Nomoline. Do not operate the ISA if there is a major leakage in the unit.

18.7.6 Safety Symbols

Symbol	Text, Color Code and Text Format	Description
	Warning: additional information.	"Warning" indicates the hazardous conditions causing possible personal injuries or death. The warning symbol should comply with ISO 7010-W001.
	User's Manual	Refer to the User's Manual.
	Reference No.	/
	Serial No.	/
	Lot No.	/
	Valid until [YYYY-MM-DD]	Do not use the monitor after such date.

	Temperature limit	/
	Pressure limit	/
	RH limit	/
	No reuse	/
	WEEE directive	Recycle this electrical and electronic equipment according to 2002/96/EC.
	Contain Pb	/
IPX4	IP grade	The IP grade indicates the water ingress protection performance.
IP44	IP grade against water and solid object ingress	Protection against tools and short cable ends (>1mm). Protection against water sprays from all directions.
Rx ONLY	Sold on prescription only	Warning (U.S.): the monitor shall be sold by medical practitioners or on prescription according to U.S. federal laws.
	CO ₂	The ISA analyzer measures CO ₂ only.
	Multiple gases (AX+ or OR+)	The ISA analyzer can measure multiple gases.
	Gas inlet	/
	Gas (exhaust) outlet	/
	Connect to patient circuit	Illustrate the connection between Nomoline and patient circuit.
	Connect to ISA	Illustrate the connection between Nomoline and ISA.
	Not sterile, latex free	The monitor is latex free and not sterile.

18.7.7 Patents and Trademarks

(1) Patent Statement

Masimo Sweden AB owns the following patents for relevant products described in this operating instruction manual: SE519766; SE519779; SE523461; SE524086. Other patents are being applied.

(2) Trademark

Masimo IRMA™, Masimo ISA™, Masimo XTP™, Sigma Multigas Technology™, LEGI™, Nomoline™, IRMA EZ Integrator™, MasimoGasMaster™ and ISA MaintenanceMaster™ are

trademarks of Masimo Sweden AB.

18.7.8 Consumables

18.7.8.1 ISA Nomoline Family

ISA samples gas from the respiratory circuit through the Nomoline Family sampling line at a rate of 50 sml/min, making measurements of CO₂ possible for adult, pediatric and infant patients.

The Nomoline Family sampling lines incorporate a unique water separation (NO MOisture) section, which can remove the condensed water. The NOMO section is also fitted with a bacteria filter that protects the gas analyzer from water intrusion and cross contamination.

As long as no sampling line is connected, the ISA gas analyzer remains in a low-power sleep mode. Once the sampling line is connected, the ISA gas analyzer switches to measuring mode and starts delivering gas data.

The Nomoline Family sampling lines are available in a wide variety of versions for both intubated and spontaneously breathing patients and in both disposable and reusable configurations. For instance, the disposable Nomoline Airway adapter Set or a combination of the reusable Nomoline Adapter and a disposable Nomoline Extension / T-adapter, is available for the intubated patient. For spontaneously breathing patients, similarly a disposable Nomoline Nasal CO₂ Cannula or a combination of the reusable Nomoline Adapter and a disposable Nomoline Nasal CO₂ Cannula (with Luer Connector) can be applied.

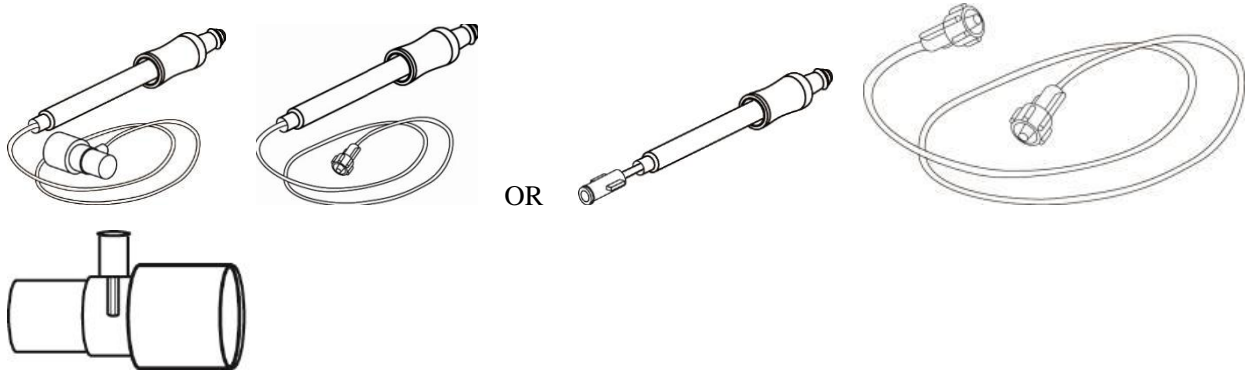

The disposable Nomoline Airway Adapter Set is an alternative to the combination of the reusable Nomoline Adapter and a disposable Nomoline Extension / T-adapter.

The Nomoline Adapter may be used with other third party sampling lines and cannulas. However, note that the Nomoline Family sampling lines are designed for optimal performance and measurement fidelity when used with the ISA gas analyzers. For instance, when connecting to a respiratory circuit, the Masimo T-adapter provides a central gas sampling point thereby minimizing the risk of sampling line occlusion (see below)

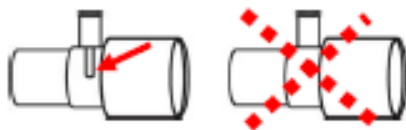

For optimal water handling, always use T-adapters with the sampling point in the center of the adapter, as shown to the left above.

**Note**

- **Using sample tubes or cannulas with larger inner diameter than 1 mm will increase the response time of ISA system.**

Nomoline Family sampling line replacement

Nomoline Family sampling lines should be replaced according to good clinical practice or when the sampling line gets occluded. Occlusion occurs when water, secretion etc. is aspirated from the respiratory circuit to such extent that ISA cannot maintain the normal 50 sml/min sample flow. This situation is indicated by a red flashing gas of inlet connector and an alarm message “Sampling Line Clogged”; Replace the Nomoline and wait until the gas inlet connector switches to green indicating that the ISA gas analyzer is ready for use.

18.7.9 Maintenance

The user should verify gas readings regularly; If any problem, contact an engineer of the manufacturer for maintenance.

18.7.10 Cleaning the Analyzer

The “Plug in and measure” ISA sidestream gas analyzer should be cleaned regularly. Use ethanol or isopropyl alcohol with a maximum concentration of 70% and a wet cloth to clean the analyzer..

In order to prevent the cleaning liquid and dust from entering into the ISA gas analyzer through the LEGI connector, the Nomoline sampling line should be connected all the time during analyzer cleaning.

**Warning**

- **The Nomoline sampling line is not a sterile equipment. In order to prevent the sampling line from causing damages, do not carry out high-pressure sterilization on any part of the sampling line.**
- **Do not sterilize the ISA sidestream gas analyzer and the IRMA probe or soak them into a liquid.**

Chapter 19 Data Review

Select the [Review] soft key, or select [Main Menu] and then select [Review] to enter the review screen.

Data Review includes: NIBP Review, Alarm Event Review, Trend Graph Review, Trend Table Review, Wave Review, and Patient Event Review.

The monitor provides 160h trend data, 2,000 sets of NIBP measurement data, 200 times of storage of parameter alarm events, and at most 10min wave review of single-channel wave, 1,000 patient events, and up to 60 minutes of AED recording storage for each patient (up to 240min of all AED recording). This chapter introduces the method to view these saved data in detail.

19.1 Wave Save

You can select the wave to be saved according to the requirements. Only waves set to be saved can be viewed in [Wave Review]. After admitting a patient, it will be impossible to modify [Wave Save] selection.

1) Enter [User Maintain] → [Wave Save].

2) Select the wave to be saved, and select [Enter]; operate according to the prompt message.

[Rec. Merge]: When admitting a new patient, the monitor creates a patient file, and save current monitoring data to the patient file created.

[Rec. Not Merge]: When admitting a new patient, the monitor creates a patient file, but current monitoring data is not saved to the patient file created.

19.2 Trend Review

Trend is a set of patient data over time shown in the form of graph or table.

In the [Trend Review] window, select [Trend Graph] or [Trend Table] to review the corresponding data.

The trend graph continuously shows the updated data. The bottom of the screen shows the time scale.

You can select the desired wave in the parameter area on the left side of the window; besides, you can browse the trend database using a cursor crossing all measurement items in the window. When moving the cursor, the current parameter trend data and specific time of data are shown on the right side of the corresponding window:

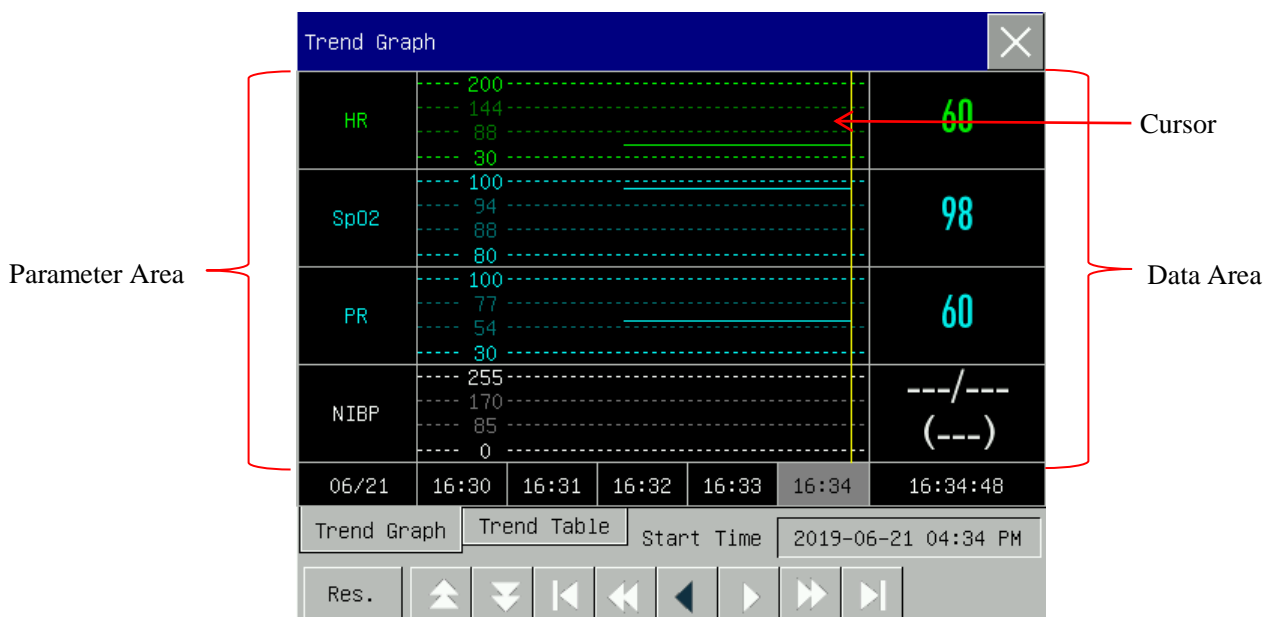

Aperiodic measurements can be viewed from the trend table. This table shows measurement data and measurement time. During a maximum period of 160h, the trend table data can be viewed.

The screenshot shows a 'Trend Table' window with a dark background and colored text. The parameters listed are HR, SpO2, PR, NIBP, RR, CO2, and AwRR. The table includes columns for parameter name, measurement values, and measurement time. The interface includes a 'Trend Table' header, a 'Start Time' field, and navigation buttons.

Parameter	16:30	16:31	16:32	16:33	16:34	16:34:48
HR	---	---	---	---	60	60
SpO2	---	---	---	---	98	98
PR	---	---	---	---	60	60
NIBP	---/--- (---	---/--- (---	---/--- (---	---/--- (---	---/--- (---	---/--- (---
RR	---	---	---	---	27	27
CO2	---/---	---/---	---/---	---/---	38/3	38/3
AwRR	---	---	---	---	20	20
Time	07/03 07:15	07:16	07:17	07:18	07:19	07:19

◆ Symbol Description

Symbol	Introduction
	Scroll the page up and down to view other parameter trend graphs not shown in the current view.
	Move the cursor left or right by one step to view along the timeline of trend database.
	Move the cursor left or right by one page to view along the timeline of trend database.
	Jump to the starting point or the end point of the trend database to view the farthest (earliest) or nearest (latest) trend info saved.

- ◆ Select the date field beside [Start Time], and the setup window will pop up, where you can set the start time of trend graph review.
- ◆ Trend Interval refers to the resolution of trend data shown on the screen. For neonate monitoring, since

the clinical condition of the patient changes fast, a high resolution can be selected; for adult monitoring, since the clinical condition of the patient changes relatively slowly, a low resolution can be selected.

Set [Res.] (Resolution)

1) In the [Trend Graph] review window

- ✧ Select [1s] or [5s] to view the short trend during the past 1h.
- ✧ Select [10s] to view the medium trend during the past 4h.
- ✧ Select [1 Min], [5 Min] or [10 Min] to view the long trend during the past 160h.

2) In the [Trend Table] review window

- ✧ Select [1 Min], [5 Min], [10 Min], [30 Min], [60 Min], [120 Min] or [180 Min] to view the trend during the past 160h.

◆ In the [Trend Table] menu, select  to enter the [Trend Table Review Report] menu. You can set the following in this menu:

- Record time: Determine which period of trend data is to be output via [Start Time] and [Forward Time]. For example: If [Start Time] is set to 2015-4-21 10:00:00 and [Forward Time] to [2h], the trend data to be output are those during 2015-4-21 08:00:00~2015-4-21 10:00:00. When [Forward Time] is set to [Auto], trend table data within 30min will be printed. When [Forward Time] is set to [All], all of the trend table data will be printed.
- [Res.]: Select the resolution for trend table output.
- [Param.] (Parameter Selection): Select the specific parameter to be output in this menu.
- [Record]: After setting, select [Record] to start data output.

Note: Trend graph has no recording setup.

19.3 NIBP Measurement Review

This monitor displays the latest 2,000 sets of NIBP measurement data in [NIBP Review]. In the [Review] menu, select [NIBP Review], as shown in the figure below:

NIBP Review					
	SYS	DIA	MAP	PR	Time
1	120	80	90	60	2019-06-21 16:36

Num: 1 ↑ ↓ ↻ Page 1/1

- ◆ Select  to enter the [NIBP List Report] menu.
 - Record time: Determine which period of trend data is to be output by [Start Time] and [Forward Time]. For example: If [Start Time] is set to 2015-4-21 10:00:00 and [Forward Time] to [2h], the trend data to be output are those during 2015-4-21 08:00:00~2015-4-21 10:00:00. When [Forward Time] is set to [Auto], NIBP list data during 1h will be recorded. When [Forward Time] is set to [All], all of NIBP list data will be recorded.
 - [Record]: After setting, select [Record] to start data output.

19.4 Alarm Event Review



Warning

- Only current physiological and technical information is displayed. Once the monitor is restarted, all the alarm information is cleared.
- Alarm information in this window is not classified by patient.
- When the alarm event storage reaches the maximum, the oldest alarm events are deleted.

The monitor can display the latest 200 parameter alarm events in [Alarm Event Review], including physiological alarm events, technical alarm events, arrhythmia alarm events, and manual events. When an alarm event occurs, the monitor saves the values of relevant parameters and the waveforms 8s before and after such occurrence. There are three ways to enter the physiological alarm or technical alarm event review window, as described below:

- 1) Select the physiological alarm information area or technical alarm information area;
- 2) Or in the monitoring mode, press the [Review] soft key, select [Alarm Event Review] → [View

Physiology Alarm] or [View Technical Alarm];

- 3) Or enter the [Main Menu], select the [Review] menu, and then select [Alarm Event Review] → [View Physiology Alarm] or [View Technical Alarm];

See the figure below:

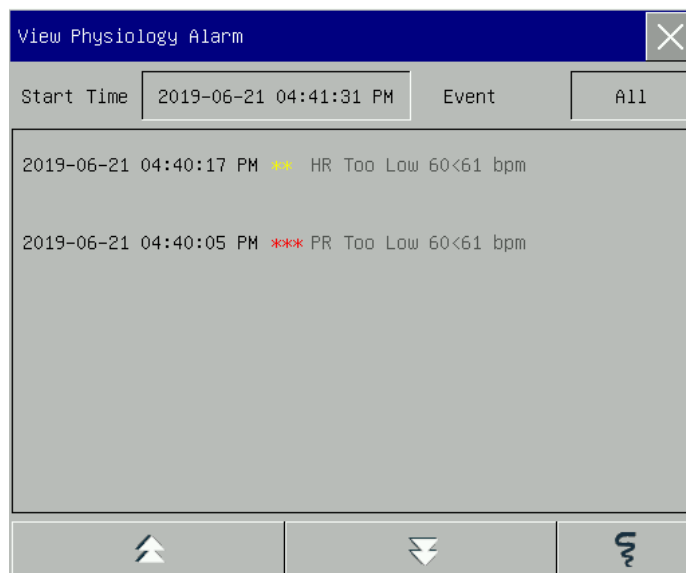

- ◆ You can set the start time of review in [Start Time].
- ◆ In [Event] under Alarm Review, you can select the alarm information of the parameter to be viewed.
- ◆ Select  to directly print current page alarm event data with recorder.

Select [View Technical Alarm] → [View Technical Alarm] menu. See the figure below:

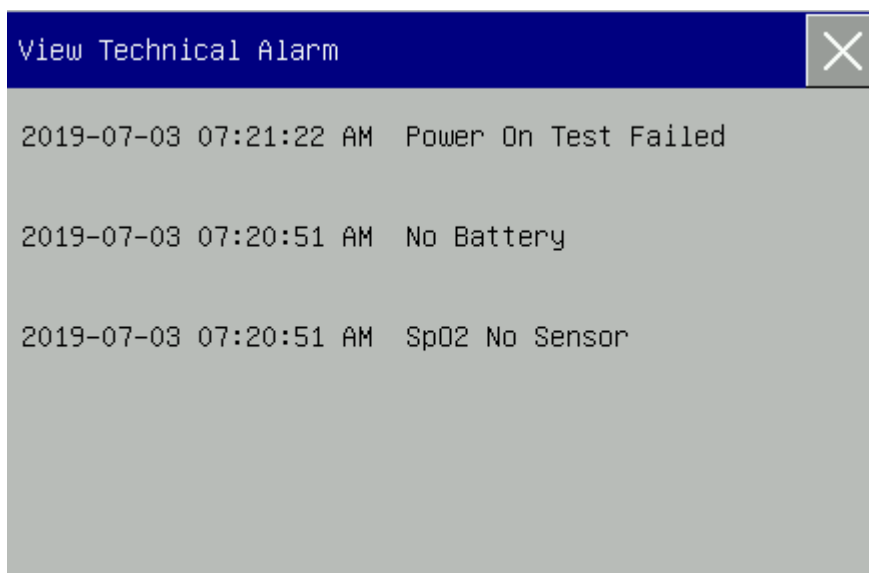

 **Note**

- **Technical alarm can only be viewed and cannot be printed.**

19.5 Full-Disclosure Wave Review

You can review full-disclosure waves only after the SD card is installed and waveform is set to be saved. The monitor displays single-channel wave playback for a maximum of 10min in the [Wave Review] window. You can review the waveform of any parameter of functions configured on the monitor:

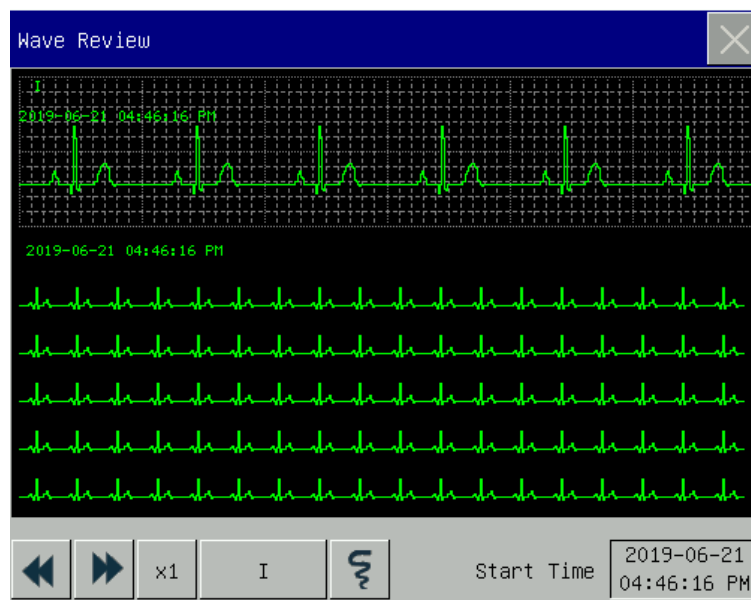

Symbol	Introduction
	Scroll up or down on the page
	Waveform gain; select this button to choose the appropriate gain
	Waveform currently reviewed; select the waveform to be viewed.
	Start time of waveform view.
	Record full-disclosure waveform.

➤ Operation Examples

ECG Wave Review:



- 1) Before admitting a patient, enter the [Wave Save] window under [User Maintain]; select the waveform to be saved.
- 2) In the [Review] menu, select [Wave Review].
- 3) In the [Wave Review] window, select the parameter to be reviewed.
- 4) In the [Wave Review] window, you can use to view changes in trend graph time and trend curve.
- 5) Select to enter the [Wave Review Report] menu. After setting the recorded start time in this menu, select [Record] to record full-disclosure waveform for 6s.

6) Press  to exit the [Wave Review] window.

19.6 Patient Event Review

The user enters the [Patient Event Review] interface to view 1,000 operation records, as shown in the figure below:

Patient Event Review 		
	Event	Time
1	Switch To Monitoring Interface	2019-06-21 16:47
2	Switch To 1-10J Interface	2019-06-21 16:47
3	Switch To Monitoring Interface	2019-06-21 16:47
4	Switch To 1-10J Interface	2019-06-21 16:47
5	Switch To Monitoring Interface	2019-06-21 16:47
6	Switch To 1-10J Interface	2019-06-21 16:47
7	Switch To Monitoring Interface	2019-06-21 16:46

Num: 8    Page 1/2

Select record icon  to print all events on the current page.

20.1 Description of Recorder

The monitor uses a thermal array recorder which supports several recording types and outputs the patient's information, measured data, reviews and at most 3 waves.

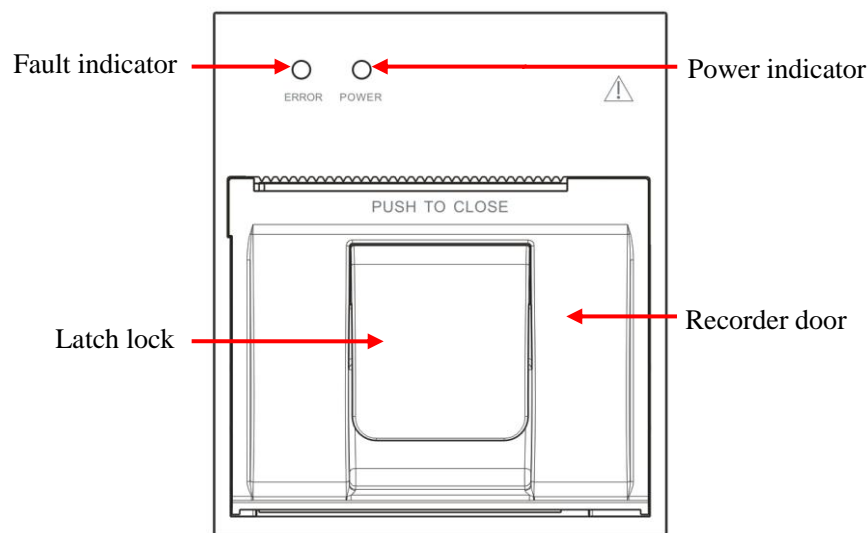

Attention

- The three channels that record the waveform cannot select the same waveform at the same time.

20.2 Recording Types



Recordings are categorized into the following types according to the ways in which they are triggered:

- ◇ Real-time recording triggered manually
- ◇ Timed recording automatically triggered by the recorder at the set interval
- ◇ Alarm recording triggered by parameter exceeding alarm limit, etc.

Recordings related to specific functions

- Waveform Freeze
- Events: such as charging event, discharge event, marking event, and automatic inspection report
- Review data

20.3 Recorder Operation

- ◆ Start recording manually:
 - To start real-time recording, select  on the front panel of the monitor.
 - To start recordings related to specific functions, select the [Record] button in the current menu or window.
- ◆ Stop recording manually:
 - Select  on the front panel of the monitor or the [Record] quick key.
- ◆ The recorder starts recording automatically in the following situations:
 - If the timed recording function is enabled, the recorder starts recording automatically at the set interval.
 - When [Alarm On/Off] and [Alarm Record] of a parameter are both set to [On]; as soon as an alarm is generated for this parameter, the monitor starts alarm recording.
- ◆ The recorder stops recording automatically in the following situations:
 - ◇ The recording task is fulfilled
 - ◇ The recorder is out of paper
 - ◇ The recorder is not operating property.

20.4 Ether Recorder Setup

Open [Main Menu], and select [Record Setup] or enter [Config Manage], and select [Record Setup] to enter [Record Setup] menu.

20.4.1 Recording waves Setup

The recorder can print 3 waves at one time. In the recording output setup window, set Record Waves 1, 2 and 3. These settings apply to real-time record and timed record.

20.4.2 Paper Speed Setup

- 1) Enter [Record Setup], select [Paper Speed].
- 2) Paper speed:[6.25mm/s], [12.5mm/s], [25mm/s], [50mm/s].

20.4.3 Real-time Recording

- 1) In this menu, select [Rt Record Time] (Real-time Record Interval): select a value among [3s], [5s], [8s], [16s], [32s] and [Continual] as needed.

If [8s] is selected, waves for 8s after the current moment are recorded.

If [Continual] is selected, waves after the current moment are recorded; to stop the recording, use the manual operation.

20.4.4 Timed recording Setup

You can set the recording interval as needed; the setting of real-time record determines the time length between two adjacent recordings.

- 1) In this menu, select [Timed Record Interval].
- 2) Select the interval: [Off], [1h], [2h], [3h] and [4h].

20.4.5 Grid

Select [Grid] and switch it between On and Off. When set it to On, the grid is printed out by the recorder on the paper; when set to Off, the grid is not printed out on the paper.

20.5 Load Recorder Paper

Load the recorder paper to the thermal recorder (optional) on the right side of the monitor according to the steps shown in the right figure below:

- 1) Use the latch lock at the top of the recorder door to open the door.
- 2) Remove the empty paper core.
- 3) Load new roll paper and fix it onto the paper clip.
- 4) The roll feeds paper from the bottom; paper runs across the top of the recorder door.
- 5) At least one inch of paper should extend out of the edge of the door.
- 6) Push the recorder door up to close it tightly.
- 7) To check whether paper is properly loaded, start a recording.
- 8) If printing is not performed, it indicates the paper may be loaded inversely. Try reloading the paper.

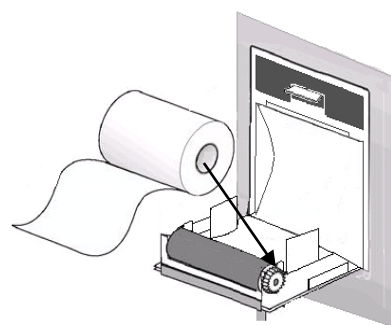

Load Record Paper

**Caution**

- **Load the paper carefully; otherwise the thermal print head may be damaged.**
- **When the recorder is printing, do not pull the record paper with force; otherwise the recorder may be damaged.**
- **Do not keep the recorder door open except for paper change or troubleshooting.**
- **Use only the recording paper provided by the company.**

20.6 Clear Jammed Paper

If the recorder makes any abnormal sound during running or the record paper outputs abnormally, check if there is a paper jam. If yes, clear the jam according to the following steps:

- 1) Open the recorder door.
- 2) Take out the paper, and cut off the folded part.
- 3) Reload the paper, and close the recorder door.

20.7 Recorder Cleaning

After a long-term use of the recorder, scraps of paper and impurities could accumulate on the print head, which affects the quality of recording and the service life of print head and roll shaft.

Cleaning procedures:

- 1) Before cleaning the recorder, prevent the equipment from being damaged by static electricity.
- 2) Open the recorder door; take out the paper, and use a cotton ball to dip an appropriate amount of alcohol.
- 3) Gently wipe the surface of the thermal part of print head.
- 4) When the alcohol becomes completely dry, reload the paper and close the recorder door.

**Note**

- **Do not use any materials (such as abrasive paper), that can damage the thermal part.**
- **Do not squeeze the thermal print head with force.**

Chapter 21 Other Functions

21.1 Connection to Central Monitoring System

Wired connection:

- 1) Enter [User Maintain] → [Net Protocol] (Network Protocol).
- 2) Go to [Main Menu] → [Config Manage] → [Network Setup]
- 3) Set [Net Bed] (Network Bed Number), [IP Address], [Gateway], [Server IP] and [Server Port]. Normally, you only need to set Net Bed and leave other options to the default settings.
 - ✧ [Net Bed] is an identification number used by the monitor to communicate with the central monitoring system.

When the connection is successful, the message prompt area at the bottom of the interface prompts [CMS Connected].



Note

- **Network bed number must be unique in the central monitoring system (CMS).**
- **For details, see the User's *Instruction Manual for Comen Central Monitoring System*.**
- **After the monitor is connected to the central monitoring system, [Time Settings] turns to gray, and you cannot make any operations.**

21.2 Formatting SD Card

The monitor allows user to format SD card. When [Format SD Card] is selected, all data is removed. Therefore, this function should be used with caution. During SD card formatting, all operations on the screen are disabled. When formatting is finished, the monitor restarts automatically.

Steps for formatting SD card:

- 1) Enter [User Maintain] → [Format SD Card]. A warning dialog [The monitor will auto restart after formatting SD card! Confirm to format?] displays. Select [Enter] to format the SD card. The monitor restarts automatically after formatting is finished.

21.3 Analog Output

Enter [User Maintain] → [Analog Out].

3 leads includes Off, I, and II; 5 leads includes Off, I, II, and V; 12 leads includes Off, I, II, V1, V2, V3, V4, V5 and V6 (varying with the lead type selected). The monitor can be connected to an oscilloscope or other external equipment via cables, and outputs analog signals such as lead I or lead II for use by such equipment.

22.1 General Introduction

This monitor is equipped with one lithium rechargeable batteries. The batteries will be charged automatically once the monitor is connected to the AC power supply, no matter whether the monitor is turned on or turned off. When the battery is charged, the monitor can work normally. Under the circumstance of sudden power failure, this monitor will automatically operate on batteries without any operation interruption. The battery indicator will turn green after cutting off AC power supply.

When the battery is being charged, the battery bar is moving and the battery indicator turns yellow.

The battery bar displayed on the upper right corner of the screen indicates the battery's charge level:



Indicates the battery is full.



Indicates the battery is not full.



Indicates the battery is low and should be charged.



Indicates no battery or damaged battery.

There are multiple LEDs on the battery to indicate its approximate battery level. Press the button beside the LEDs and the LEDs will be illuminated to show the battery level.

Warning

- **Check the battery periodically to ensure there is adequate battery power.**
- **Improper replacement of the lithium battery will result in unacceptable equipment risk.**
- **Battery electrolyte is hazardous. In case that battery electrolyte comes into contact with your skin or enters your eyes, wash it with clean water immediately and seek for medical help.**
- **Keep the battery out of the reach of children.**
- **When the battery is used for operation, the monitor powers off automatically when the battery is low.**
- **Only use the battery specified by the manufacturer.**

Note

- **If the battery is not to be used for a long period of time, please remove the battery and store it properly according to the manufacturer's instructions.**
- **If the monitor is provided with a built-in battery, the battery must be charged after each use to ensure sufficient charge.**

- As the battery is used and aged, the remaining battery power displayed by the battery icon may deviate from the actual power. Please refer to the system alarm information.
- In order to prevent the treatment or monitoring from being affected by accidental battery damage or power depletion when only using battery power supply, you can prepare a fully charged battery backup.

22.2 Battery Alarms

22.2.1 Low Battery Alarms

If battery power is used, when the battery is low, the instrument will report the “Low Battery” alarm. In this case, the battery shall be replaced or AC power shall be inserted in time to avoid affecting the patient's treatment and monitoring. When the battery is seriously depleted, the instrument triggers an alarm and shuts down the countdown. In this case, plug in the AC or replace the battery immediately.



Note

- After the alarm “Low Battery” is triggered, this monitor can at least conduct vital signs monitoring for 20 minutes and 6 maximum energy deliveries. The battery shall be replaced or AC power shall be connected immediately.

22.2.2 Battery Aging Alarms

If the operation time of battery is obviously shorter than the time declared in battery specification, the system will trigger a technical alarm “Battery Aging”. Under such circumstance, contact the manufacturer to replace the battery.

22.2.3 Battery Fault Alarms

When there is any battery fault, the system will trigger a technical alarm “Battery Fault”. Under such circumstance, replace battery or contact the maintenance personnel.

22.3 Battery Installation

- 1) Turn off the monitor and disconnect power cord and other connecting cables.
- 2) Put the back panel of the monitor upwards.

- 3) Align the battery connector with battery pin.
- 4) Press the battery into the battery pin until it clicks into place.
- 5) To replace a battery, press the latch on the right end of the battery with right hand and push the battery to the right with left hand; reinsert a new battery.



Warning

- **Only the battery specified by the manufacturer can be used.**
- **The installation of the battery should be performed by the personnel authorized by the manufacturer.**
- **Watch your hand when installing the battery.**
- **Do not remove the battery when the equipment is working.**

22.4 Conditioning and Check Battery Performance

1) Conditioning Battery Performance

If it is the first time to use the battery, ensure that the battery has undergone at least two complete conditioning cycles. A complete conditioning period means uninterrupted charging till the battery is fully charged, and then discharging it till the monitor shuts down automatically.

When conditioning the battery, follow these steps:

- 1) Completely disconnect the monitor from the patient and stop all monitoring and measurement.
- 2) Put the battery for conditioning in the battery compartment of the equipment.
- 3) When charging the battery, please ensure that the battery is charged uninterruptedly until it is fully charged.
- 4) Disconnect AC power supply, and use the battery to supply power to the monitor until the monitor shuts down automatically.
- 5) Battery conditioning is finished.

2) Check Battery Performance

The battery service life varies with the storage and operation environments, frequency of battery discharging and charging time. The battery performance degrades gradually even if the battery is not used.

Here are the steps for checking the battery:

- 1) Determine whether the battery is damaged. When the battery icon shows , it indicates the battery is damaged or there is no battery in the battery compartment.
- 2) Check whether the battery can be charged normally when connected to AC power supply.
- 3) Completely disconnect the monitor from the patient and stop all monitoring and measurement.
- 4) When charging the battery, ensure that the battery is charged uninterruptedly for at least 6h till it is fully

charged.

- 5) Disconnect AC power supply, and use the battery to supply power to the monitor until the monitor shuts down automatically; meanwhile note down the start time and end time of discharging.
- 6) The length of discharging time reflects the performance of the battery.
- 7) When the discharge time is significantly lower than the time stated in the specifications, replace the battery.



Note

- **In order to prolong the service life of the rechargeable battery, if the battery is to be stored for a long period of time, it is suggested that the battery is charged every three months to prevent excessive discharging.**
- **The power supply time of the battery depends on the configuration and operation of the equipment. For example, frequent NIBP measurement reduces the power supply time of the battery.**
- **The battery life depends on the frequency and time of use. If the battery is properly stored, the service life of the lithium battery is about 2 years. If the battery is used improperly, its life may be shortened. We recommend replacing the battery every 2 years.**

22.5 Battery Recycling

If the battery is obviously damaged or runs out, it should be replaced. Dispose of batteries in accordance with applicable laws and regulations or the rules of the hospital.



Warning

- **Do not disassemble or short-circuit the battery or place it in fire; otherwise the battery may cause fire, explosion, leakage of hazardous gas or other hazards.**

Chapter 23 Cleaning and Disinfection

Only materials and methods listed in this chapter that are approved by the company can be used for cleaning or disinfection of the equipment. For any damage arising from use of unaccepted materials or methods, the warranty does not cover. This chapter describes how to clean and disinfect the monitor and some accessories. The cleaning and disinfection methods for the remaining accessories are detailed in the corresponding accompanying documents.

The company does not assume any liability for the effectiveness of listed chemicals or methods when they are used as infection control means. For infection control methods, consult the Infection Prevention Department or an epidemiologist in your hospital. Besides, refer to local policies that apply to your hospital and country.

23.1 Overview

Keep the equipment and its accessories dustless. After cleaning, check the equipment carefully. If there is any evidence of ageing or damage, stop using it immediately. If it is necessary to send the monitor back to Comen for repair, send us a clean monitor. Observe the following precautions:

- ✧ Before cleaning the device, you must turn off the power, remove the battery, and disconnect the power cord from the outlet.
- ✧ Dilute the detergent and disinfectant as specified by the manufacturer, or use a concentration as low as possible.
- ✧ Do not allow any liquid to flow into the housing.
- ✧ Do not pour any liquid onto any part or accessory of the equipment.
- ✧ Do not soak the equipment in any liquid.
- ✧ Do not attempt to sterilize the equipment.
- ✧ Use cleaning solutions only as instructed in this operator's manual.
- ✧ Do not attempt to clean the equipment while monitoring a patient.
- ✧ Do not use any abrasive or corrosive material, bleaching powder or strong solvent (for example, acetone or detergent containing acetone).
- ✧ Keep the electrode paddle clean. The electrode paddle and the electrode base shall be thoroughly cleaned after each use and before the user detects it.

**Warning**

- **Only use detergents and disinfectants recommended in this manual. Using other detergents and disinfectants may result in damage to the equipment or other risks.**
- **Before cleaning the monitor, power it off and disconnect it from the AC power supply.**
- **Do not use EtO (ethylene oxide) to disinfect the monitor.**
- **Do not leave any disinfectant residue on the surface and accessory of the monitor. Use a wet cloth to clean it immediately.**
- **It is not allowed to use detergent mixture; otherwise hazardous gases may generate.**
- **This chapter only introduces the methods for cleaning reusable accessories. Disposable accessories should not be reused after cleaning and disinfection to avoid cross infection.**
- **To protect the environment, disposable accessories must be recycled or disposed of properly.**
- **After cleaning, if the sensor cable is damaged or shows any evidence of ageing, it should be replaced with a new cable.**
- **High-temperature sterilization of the monitor and all accessories is not allowed.**
- **Do not use any cleaning solution not recommended in this manual; failure to do so may result in permanent damage to the equipment, sensor or cable.**
- **Do not soak the sensor or connector in any solution for cleaning or disinfection.**
- **In order to prevent the entry of cleaning solution and dust into the ISA gas analyzer via LEGI port, the Nomoline sampling line should always be connected when cleaning the ISA analyzer. Do not soak the ISA sidestream gas analyzer in any liquid for disinfection.**
- **The Nomoline sampling line is not a sterile equipment. In order to avoid damage, do not sterilize any part of the sampling line under high pressure.**

**Caution**

- **If you carelessly pour any liquid onto the equipment or any accessory, contact the maintenance personnel or our Company immediately.**

23.2 Cleaning of Monitor and Modules

The monitor and modules should be kept clean. It is suggested that the external surface of the housing should be cleaned frequently; especially in environments with tough conditions or very windy and dusty places, the cleaning frequency should be increased. Before cleaning, first consult or understand relevant rules of your hospital on equipment cleaning. Water, neutral soap, hydrogen peroxide (diluted concentration), alcohol (diluted concentration), isopropanol (diluted concentration), and sodium hypochlorite solution (diluted aqueous solution) are recommended by our company.

➤ Cleaning steps:

- 1) Power the equipment off, and unplug the power cord, accessories and batteries.

- 2) Use a soft cloth dipped with an appropriate amount of detergent to wipe the housing of the monitor and modules.
- 3) Use a soft cloth dipped with an appropriate amount of detergent to wipe the display screen of the monitor.
- 4) If necessary, you can use a soft, dry cloth to remove residual detergent.
- 5) Put the monitor and modules in a cool, well-ventilated environment to air-dry it.

23.3 Disinfection of Monitor and Modules

It is suggested that the monitor and modules can be disinfected only when it is considered necessary in the maintenance plan of your hospital. Before disinfection, clean the monitor and modules first. OPA (5.5g/L), 70% alcohol, 70% isopropanol, 70% n-propanol, 2% glutaraldehyde, 3% hydrogen peroxide and 0.5% sodium hypochlorite solution are recommended by our company.

23.4 Cleaning and Disinfection of Accessories

It is suggested that the accessories can be disinfected only when it is considered necessary in the maintenance plan of your hospital. Before disinfection, clean the accessories first.



Warning

- **Do not use a chlorine-containing disinfectant such as sodium hypochlorite solution, bleach, or chlorhexidine gluconate to wipe the metal parts of the defibrillation electrode paddle. Chlorine disinfectants and or other oxidizing disinfectants can corrode the electrode paddles.**

23.4.1 Cleaning and Disinfection of the External Electrode Paddle

Our recommended external electrode paddle cleaners are: water, neutral soap, alcohol (diluted concentration), and isopropyl alcohol (diluted concentration); disinfectants are: OPA (5.5 g/L), 70% alcohol, 70% isopropanol, 70% n-propanol, and 2% glutaraldehyde. Check carefully before cleaning and disinfection. If the external electrode paddle is damaged, it shall not be used any more.

The specific method is as follows:

- 1) Soak a soft cloth in a detergent or disinfectant (no water can be squeezed out), and wipe the defibrillation electrode surface, handle, and cable of the external electrode paddle.
- 2) If necessary, use a soft, dry cloth to remove excess detergent or disinfectant.
- 3) If necessary, you can use a soft, dry cloth to remove residual detergent.

- 4) Put the paddles in a cool, well-ventilated environment to air-dry it.
- 5) The two defibrillation electrodes shall be separately wrapped to prevent damage to the electrode surface.

23.4.2 Cleaning and Disinfection of NIBP Cuff

Our recommended NIBP cuff cleaners are: Water, neutral soap, hydrogen peroxide (diluted concentration), alcohol (diluted concentration), isopropanol (diluted concentration), and sodium hypochlorite solution (diluted aqueous solution); disinfectants are: OPA (5.5 g/L), 70% alcohol, 70% isopropanol, 70% n-propanol, 2% glutaraldehyde, 3% hydrogen peroxide and 0.5% sodium hypochlorite solution.

Before cleaning the cuff, remove the rubber bag.

The cuff can be washed by machine or hand with warm water and mild detergent. Hand wash can prolong its service time. The rubber bag can be cleaned using a wet cloth dipped with clean water. Naturally air-dry it after cleaning.

The cuff can be disinfected using a wet cloth dipped with disinfection. Long-term use of disinfectants may result in color fading or discoloration of the cuff.



Warning

- Do not squeeze the rubber tube on the cuff.
- During cleaning, only wipe the external surface of the connector. Do not wipe its inner surface.
- Carefully clean the rubber bag. Do not allow any liquid to flow into the rubber bag.
- Do not dry-clean the cuff.
- The disposable cuff can be cleaned with soap to control infection.

After cleaning, put the rubber bag into the cuff according to the following steps:

- 1) Place the rubber bag on the top of the cuff;
- 2) Roll the rubber bag lengthwise and insert it into the large opening;
- 3) Hold the hose and the cuff and shake the complete cuff until the rubber is in position;
- 4) Thread the hose from inside the cuff and out through the small hole under the internal flap, as shown below:

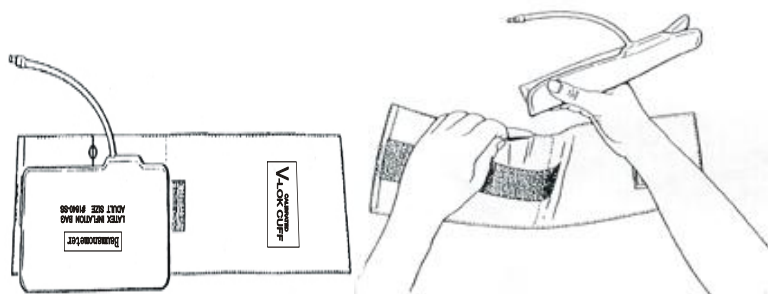

23.4.3 Cleaning and Disinfection of Other Accessories

23.4.3.1 Cleaning of Accessories

The cleaning steps are as follows:

- 1) After using a soft cloth to absorb the proper amount of detergent, wipe the accessories.
- 2) Wipe off excess detergent with a soft, dry cloth.
- 3) Place the accessories in a cool and ventilated environment.

The following table lists the recommended detergents.

Cleaning/Disinfection Parts	Detergent
Power cord	Water, hydrogen peroxide, and diluted sodium hypochlorite solution
ECG cable, Analog SpO ₂ main cable, and CO ₂ extension cable, Analog SpO ₂ probe	Water, neutral soap, hydrogen peroxide (diluted concentration), alcohol (diluted concentration), isopropanol (diluted concentration), and sodium hypochlorite solution (diluted aqueous solution)
Masimo and Nellcor SpO ₂ probes and SpO ₂ cables	Water, neutral detergent, and 70% isopropanol
BP air tube	Water, neutral soap, alcohol (diluted concentration), and isopropyl alcohol (diluted concentration)

23.4.3.2 Disinfection of Accessories

The following table lists the recommended disinfectants.

Cleaning/Disinfection Parts	Disinfectant
ECG cable, Analog SpO ₂ main cable, and CO ₂ extension cable, Analog SpO ₂ probe	OPA (5.5 g/L), 70% alcohol, 70% isopropanol, 70% n-propanol, 2% glutaraldehyde, 3% hydrogen peroxide and 0.5% sodium hypochlorite solution

Cleaning and Disinfection

Masimo and Nellcor SpO ₂ cables	0.5% sodium hypochlorite solution
BP air tube	OPA (5.5 g/L), 70% alcohol, 70% isopropanol, 70% n-propanol, and 2% glutaraldehyde

24.1 Maintenance Check

A comprehensive maintenance check including safety check should be conducted by the qualified maintenance personnel before using, after 6-12 continuous operation or after each maintenance and upgrading. Check items including:

- ◆ Self-test
- ◆ Shift exchange check
- ◆ User test
- ◆ Recorder test
- ◆ Manual defibrillation test
- ◆ Pacing test
- ◆ Functional module test
- ◆ NIBP overpressure protection test
- ◆ Electrical safety test

Cables and paddles which can be abraded easily are key accessories for this Defibrillator Monitor. Daily inspection and test is recommended.

If you find any damage on the Defibrillator Monitor, stop using it on patient, and contact the biomedical engineer of the hospital or our customer service immediately.

All the safety and maintenance checks that need to dismantle the monitor should be performed by a qualified customer service technician. Non-professional operation can cause the monitor damage or cause a security risk, and human health may be endangered.

The circuit diagrams key list of the Defibrillator Monitor can be provided by Comen as per customer demands. Qualified technicians can use it to help the user repair some apparatus that Comen classifies as “can be maintained by the user”.

Warning

- **If the hospital or agency who uses this Defibrillator Monitor does not follow a satisfactory maintenance schedule, the Defibrillator Monitor may become damaged and personal safety may be endangered.**

24.2 Maintenance and Test Schedule

The following maintenance and test items can only be conducted by the maintenance personnel approved by Comen. Please clean and disinfect this Defibrillator Monitor before maintenance and test.

Maintenance and test items	Schedule
Clean this equipment and accessories	After use
User test (Routinetest, Energy Delivery test, Controlstest)	Once a week or as required. Controls test is once a year.
Recorder test	Once a year or as required

ECG cable test	Once a year or as required
Manual defibrillation test (charge and shock function, disarming energy, synchronized defibrillation)	Once a year or as required
Pacing test	Once a year or as required
ECG calibration	Once a year or as required
NIBP test (pressure verification, air leakage test)	Once every two years or as required.
NIBP overpressure protection test	Once a year or as required
Functional test	Once a year or as required
Electrical safety test (Housing leakage current test, Earth leakage current earth test, Patient leakage current test, Patient auxiliary current test)	Once every two years, after Defibrillator Monitor falling off and replacing power supply or as required.

24.2.1 Reusable Accessory Service Life

Testing and maintenance items	Frequency
ECG lead wire	It is recommended to change once every two years.
Comen SpO2 probe	It is recommended to change once every two years.
Nellcor and Masimo SpO2 probe	It is recommended to change once every 4380 hours.
Reusable blood pressure cuff	It is recommended to change once every 18 months.
CO ₂ module	It is recommended to change once every five years.
External paddle	It is recommended to change once every two years.

24.3 Self-test

Each time you turn on the Defibrillator Monitor, it performs internal self-test. If any error is found during self-test, service indicator will be illuminated and alarm message will be displayed in technical alarm message area.

Self-test contains the following test items:

- Power module test
- Therapy module test

Self-test should be performed every day or after initial installation and replacing components for the main unit to make sure that the Defibrillator Monitor can work properly.

Specific steps are as follows:

1. Put paddles into the paddle tray and make them contact well. Install the Defibrillator Monitor with battery and connect AC power supply. Check whether AC indicator and battery indicator are illuminated.
2. Rotate mode selector to monitor mode. Check whether the Defibrillator Monitor can be turned on.
3. Observe technical alarm message area, physiological message area and battery icon for error message.

24.4 Shift Exchange Check

In order to ensure that your Defibrillator Monitor is available at any time, it is recommended to perform checks according to the “Shift Exchange Checklist” in Appendix.

24.5 Auto Test

As long as the Defibrillator Monitor is connected to AC power supply, it will perform routine test and energy delivery test daily at the specified time and remind the users of the error found.

How to set auto test time:

1. Access [Main Menu]→[Config Manage]→enter password
2. Select [Detection Setup]→[Auto Test Time] and select auto test time. Available options include 0:00, 1:00, 2:00, 3:00, 4:00 and 5:00.

Auto test item and schedule are listed below:

Test item	Description	Schedule
Routine test	Test battery and therapy modules	Once a day from 0:00 to 5:00
Energy delivery test	Deliver 200J energy	Once a week after routine test.

There is no prompt message on the screen of Defibrillator Monitor during auto test. If auto test fails, the maintenance indicator will flash and the buzzer will continue to sound at regular intervals until it is turned back on. After turning on the Defibrillator Monitor, a low level technical alarm “Last Auto Test Failed” will be triggered. If the next auto test passes, or the routine test or energy delivery test which fails in auto test passes during user test, the “Last Auto Test Failed” alarm will be cleared.

It is recommended to perform user test if the auto test fails.

The Defibrillator Monitor will save an auto test report after each auto test. You can choose whether to print auto test report after each auto test. Specific steps are:

1. Access [Main Menu]→[Config Manage]→enter password.
2. Select [Record Setup]→[Auto Record] →[Auto Check Report] and select [On] or [Off].

You can select [History] in user test interface to view the auto test results.



Attention

- If the Defibrillator Monitor is switched off, it will perform auto test daily at the specified time only when it is connected to AC power supply.
- Install the defibrillator monitor with battery, place the paddles in the paddle tray correctly or connect electrode cable and 50Ω test load, or the auto test will not pass.
- Clean the paddles and place them into paddle tray correctly after each use. Only when the paddles contact well with the metal parts of paddle tray, will the auto test pass.

24.6 User Test

User test performs routine test, energy delivery test and controls test.



Warning

- **Make sure that patient is not connected to the Defibrillator Monitor when conducting user test.**



Attention

- **Install the defibrillator monitor with battery, place the paddles in the paddle tray correctly or connect electrode cable and 50Ω test load, or the auto test will not pass.**
- **Clean the paddles and place them into paddle tray correctly after each use. Only when the paddles contact well with the metal parts of paddle tray, will the auto test pass.**

24.6.1 User Test Interface

Access [Main Menu]→[User Test] to enter user test interface.

Select items to be tested	
<input checked="" type="checkbox"/> Routine Test	Last Test: 0000-00-00 Fail
<input checked="" type="checkbox"/> High Energy Test	Last Test: 0000-00-00 Fail
<input checked="" type="checkbox"/> Control Test	Last Test: 2019-07-03 PASSED

Start History

Figure24-1User test interface

Select items to be tested and select [Start] to start test. Perform the test following what indicated on the screen. After test, the “Test completed” prompt message will be displayed. Press [Record] to print the test result. Press [Back] soft button to return to user test interface.

24.6.2 Routine Test

Routine test includes the following test items:

- ◆ Battery
- ◆ Main board
- ◆ Power board
- ◆ Defibrillation/pacer function
- ◆ Monitor function

Perform the test following what indicated on the screen.

If any test item of routine test fails, the service indicator will be illuminated. The test result of each test item will be displayed on the screen. The system will give low level technical alarm “Last User Test Failed” when switching on the Defibrillator Monitor next time and it is suggested to perform a successful user test to clear this alarm.



Attention

- **It is recommended to perform user test when changing shift.**

24.6.3 Energy Delivery Test

Energy delivery test includes 200J charge and shock test and charge and shock circuit function test. Perform the energy delivery test following what indicated on the screen.

If energy delivery test fails, the service indicator will be illuminated and the system will give low level technical alarm “Last User Test Failed” when switching on the Defibrillator Monitor next time. It is suggested to perform a successful user test to clear this alarm.

24.6.4 Controls Test

Controls test includes the following test items:

- ◆ Controls (all the buttons on front panel and mode selector)
- ◆ Audio test
- ◆ Display test

Perform the controls test following what indicated on the screen.

If any test item of controls test fails, the service indicator will be illuminated and the system will give low level technical alarm “Last User Test Failed” when switching on the Defibrillator Monitor next time. It is suggested to perform a successful user test to clear this alarm.



Attention

- **During controls test, the controls have been tested turn green.**
- **Controls test doesn't test the OFF mode. If you rotate the mode selector to OFF for more than**

2s, the Defibrillator Monitor will shut down.

24.6.5 Test Result Review

The Defibrillator Monitor could save the test results of routine test, energy delivery test and controls test. Press [History] in user test interface to view the test results.

User Test- History			
No.	Test Time	Item	Test Result
1	2019-7-3 05:56	Control Test	Controls/Pass, Audio/Pass, Display/Pass
2	2019-7-3 05:55	Control Test	Controls/Pass, Audio/Pass, Display/Pass
3	2019-7-3 05:55	Control Test	Controls/Pass, Audio/Pass, Display/Pass

Pre Page Next Page Delete All

Figure24-2 Test result review

The Defibrillator Monitor could save up to 300 test reports which are listed in chronological order. Select a certain test report to view it in detail. Select [Record] to record this test report.

Press [Pre Page] and [Next Page] to view the test reports not on current page. Press [Delete All] to delete all the test reports. Press [Back] soft button to return to user test interface.

24.6.6 User Test Prompt

It is recommended to perform routine test and energy delivery test once a week and controls test once a year. Each time you turn on the Defibrillator Monitor, the system will check the time period from last routine test, energy delivery test and controls test automatically. If user test prompt function is activated and you do not perform corresponding test within the suggested time period, the system will give technical alarm “User Test Due”. If user test prompt function is deactivated and there will be no prompt even when user test is overdue.

How to activate or deactivate user test prompt function:

1. Access [Main Menu]→[Config Manage]→enter password
2. Select [Detection Setup]→[User Test Prompt] and select [On] or [Off].

24.7 Recorder Test

1. Start the Defibrillator Monitor and switch to monitor mode.
2. Print ECG waveforms. Verify that the recorder can print normally and what printed is clear.
3. Simulate such troubles as no recording paper and recorder door open, and check whether there is corresponding prompt message on the screen. After clearing all these troubles, check whether the recorder can work properly.

24.8 ECG Cable Test

It is recommended to conduct ECG cable test once a year.

Test tool: ECG simulator

Specific test steps are as follows:

1. Switch to monitor mode.
2. Connect the ECG cable to the Defibrillator Monitor and connect the ECG lead wire to ECG simulator.
3. Start ECG simulator and select a normal ECG rhythm
4. After several seconds, check that there is normal ECG waveform displayed and there is no “ECG LEAD OFF” technical alarm.

24.9 Manual Defibrillation Test

Test tool: Defibrillator/Pacer analyzer

24.9.1 Charge/ Shock Function

1. Remove two batteries, connect the Defibrillator Monitor to AC power supply only, switch on the Defibrillator Monitor and switch to manual defibrillation mode.
2. Connect paddle cable with the therapy cable connector on the Defibrillator Monitor. Place the paddles on the defibrillator/pacer analyzer correctly.
3. Access [Config Manage]→ [Record Setup]→[Auto Record] and set [Charge Event] and [Shock Event] to [ON].
4. Set the operating mode of defibrillator/pacer analyzer as energy measurement mode (the displayed energy is 0 or blank this moment).
5. Select 1J energy for the Defibrillator Monitor.
6. Charge the defibrillator and deliver the energy to verify whether the value measured by the defibrillator/pacer analyzer meets the accuracy requirements shown in the following table.

Energy select (J)	Measured value (J)
1	0~3
100	85~115
360	306~414

7. Adjust energy level to 100J and 360J respectively and repeat step 6.
8. Operate the Defibrillator Monitor on fully charged battery, switch on it and switch to manual

- defibrillation mode. Repeat step 2 through step 7.
9. Check whether the charge/shock event has been recorded automatically and what has been recorded is correct.
 10. Use the pads and repeat step 3 through step 9.

24.9.2 Disarming Energy

1. Operate the Defibrillator Monitor on fully charged battery, switch it on and switch to manual defibrillation mode.
2. Connect paddle cable with the therapy cable connector on Defibrillator Monitor. Place paddles on the defibrillator/pacer analyzer correctly.
3. Set the operating mode of defibrillator/pacer analyzer as energy measurement mode (the displayed energy should be 0 or blank at this moment).
4. Select 360J energy for the Defibrillator Monitor.
5. Charge the Defibrillator Monitor.
6. Check whether there is charge tone during charge.
7. After charge, press [Disarm] soft button to disarm the energy.
8. Check there is “Charge Removed” prompt message and the charge completed prompt tone stops.
9. Check that the measured energy value on defibrillator/pacer analyzer is 0J or blank.
10. Access [Config Manage]→[Manul Def Setup] and set [Auto Disarm Time] to 60s.
11. Exit [CONFIG SETUP] menu.
12. Set the operating mode of defibrillator/pacer analyzer as energy measurement mode (the displayed energy should be 0 or blank at this moment). Select 360J energy for the Defibrillator Monitor and charge.
13. From the moment charge completes, check whether there is “SHOCK CANCELED” prompt message after 60s and whether the measured energy value on defibrillator/pacer analyzer is 0J or blank.
14. Use pads and repeat step 3 through step 12.

24.9.3 Synchronized Defibrillation

1. Connect paddle cable with the therapy cable connector on Defibrillator Monitor. Place paddles on the defibrillator/pacer analyzer correctly. Connect ECG cable with the Defibrillator Monitor and connect the lead wires to the defibrillator/pacer analyzer.
2. Set the operating mode of defibrillator/pacer analyzer as synchronized defibrillation time measurement mode and output normal sinus rhythm (for example: amplitude 1mV, heart rate 60bpm).
3. Access [Config Manage]→[Manul Def Setup] and set [Sync Keep] to [On].
4. Select 10J for the Defibrillator Monitor.
5. Press [Enter Sync] soft button to enter synchronized defibrillation mode. If remote synchronization input function is activated, after pressing [Enter Sync] soft button, select [Local] in the pop-up dialog box to enter synchronized defibrillation mode.
6. Press LEAD SELECT button on the front panel to select [Pads] as ECG source and charge the defibrillator.
7. After charge, press both shock buttons on paddles to deliver the energy synchronously.
8. Check whether the system can deliver the energy synchronously. The delivered energy measured by the defibrillator/pacer analyzer should meet the requirement of $10J \pm 2J$.
9. Check that the delay of defibrillation synchronization measured by the defibrillator/pacer analyzer is less than 60ms.

10. Check that the synchronized shock marker is above R wave.
11. Check that the prompt messages are correct during the test.
12. Select lead II as ECG source. Charge the defibrillator and repeat step 7 through step 11.
13. Use pads and repeat step 2 through step 12.

24.10 Pacing Test

Test tool: defibrillator/ pacer analyzer

1. Operate the Defibrillator Monitor on fully charged battery, switch it on and switch to pacer mode. Enter [Config Manage] and set the pacing mode to [Fixed Pace].
2. Connect pads cable to the Defibrillator Monitor and place pads on defibrillator/pacer analyzer correctly.
3. Set the operating mode of defibrillator/pacer analyzer as pacing measurement mode and set test load as 50Ω .
4. Set the [Pace Rate] to [70ppm] and [Pace Ele] to [30mA].
5. Press [Start Pace] soft button. Verify whether the pacing rate measured by the defibrillator/pacer analyzer meets the requirement of $70\text{ ppm}\pm 1\text{ ppm}$ and pacing current meets the requirement of $30\text{ mA}\pm 5\text{ mA}$.
6. Press [Stop Pace] soft button. Set the [Pace Rate] to [170ppm] and [Pace Ele] to [200mA].
7. Press [Start Pace] soft button. Verify whether the pacing rate measured by the defibrillator/pacer analyzer meets the requirement of $170\text{ ppm}\pm 2\text{ ppm}$ and pacing current meets the requirement of $200\text{ mA}\pm 10\text{ mA}$.

24.11 ECG Calibration

During the use of monitor, ECG calibration is required when the ECG signal is inaccurate. ECG calibration should be conducted by the serviceman approved by Comen at least once a year or when you doubt the measured value.

Specific steps are as follows:

1. Enter [Main Menu]→[Maintain]→[User Maintain]→enter password →[ECG Calibrate].Then the screen displays square wave signal and displays prompt message “Cal...can't monitor!”.
2. Compare the amplitude of the square wave with the wave scale. The difference should be within 5%.
3. After calibrating, press [Stop ECG Cal].

24.12 NIBP Air Leakage Test

The NIBP Leakage Test is used to detect whether the NIBP measuring pump leaks. When the NIBP cuff is connected, this button can be used to activate the NIBP inflation process, so as to detect whether the NIBP gas circuit is in good airtight condition. If the result of gas leakage test is OK, the system does not give any prompt; if not, a corresponding error message is shown in the NIBP info area.

Gas Leakage Test Process:

- 1) Properly connect the cuff to the NIBP opening in the monitor.
- 2) Wrap the cuff around a cylinder of proper size.
- 3) Enter [Main Menu] →[Maintain]→[User Maintain]→ [Leakage Test].
- 4) At this moment, [Leakage Testing] is shown in the lower part of the NIBP parameter area on the screen,

indicating that the system started performing the air leakage test.

- 5) The system inflates the cuff automatically until the pressure reaches 180mmHg.
- 6) About 20s later, the system turns on the deflation valve automatically, indicating that leakage measurement is finished.

If no prompt message is shown in the NIBP parameter area, it indicates the system has no leakage. If [Pneumatic Leak...] is shown, it indicates the air circuit may leak. At this moment, the operator should check the complete connection to see if there is any looseness. After confirming the connection is correct, perform the leakage test again. If there is still any fault prompt, contact the manufacturer for repair.

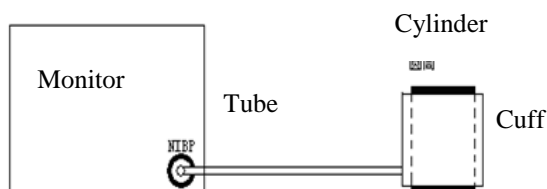

Warning

- This leakage test is different from those described in EN 1060-1. This is simply for the user to test whether there is air leakage during NIBP inflation. If the system shows NIBP air leakage at the end of the test, contact Comen's service technician.

24.13 NIBP Pressure Verification

Warning

- Calibration of NIBP measurement should be performed once every two years (or according to maintenance rules of your hospital). Check its performance according to the following details.

NIBP pressure verification should be carried out once a year or when you doubt the measured NIBP by the serviceman approved by Comen.

Manufacturers recommend a calibrated pressure gauge (or mercury sphygmomanometers) with a precision more than 1mmHg to be used for NIBP pressure verification. Specific steps are as follows:

1. Set measure mode to adult mode and select a metal container with a volume of 500ml \pm 5% to replace cuff.
2. Connect a calibrated standard gauge with measurement error of less than 1mmHg, a spherical air pumps with a t-interface and inflatable tubes with NIBP socket on the monitor as the figure shown below:

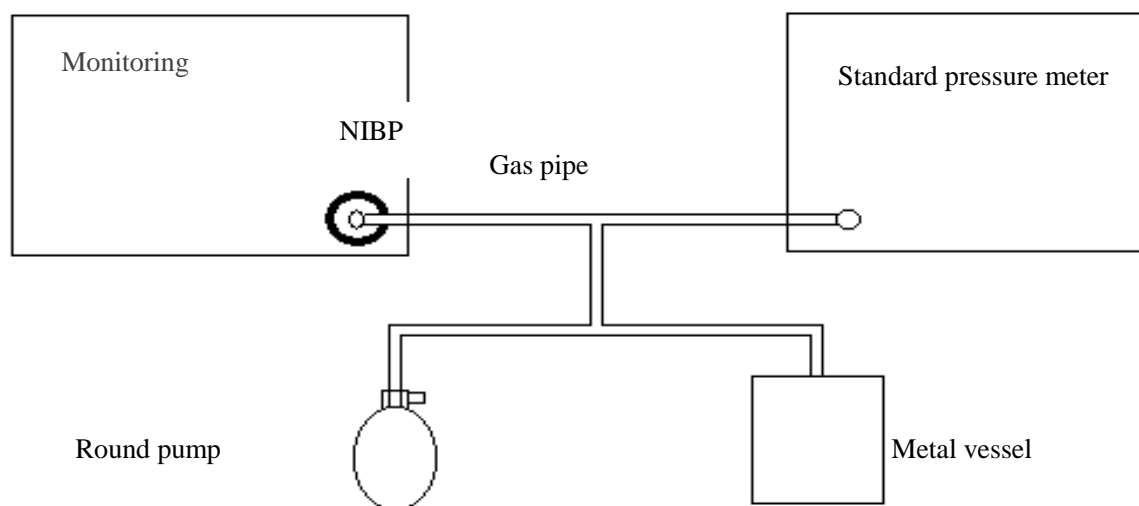

3. Access [Main Menu]→[Maintain] →[User Maintain] → [NIBP Verify].
4. The standard pressure gauge shall read zero before inflation. If it is not zero, open the ball pump valve so that the entire gas circuit leads to the atmosphere, and then close the valve after the standard pressure gauge reads zero.
5. Inflate the metal container with spherical air pump to pressure of 50 and 200 mmHg respectively. The difference of pressure value between standard pressure gauge and monitor should be within 3mmHg. Otherwise, please contact the Comen maintenance engineers.

24.14 NIBP Overpressure Protection Test

It is recommended to conduct NIBP overpressure protection test once a year. The specific steps are as follows:

1. Open the housing of the Defibrillator Monitor, take out the multi-parameter module, remove the gas tube connected with NIBP measuring transducer and block it up.
2. Connect NIBP cuff.
3. Start NIBP measurement. When the pressure rises to the overpressure protection point (300~330mmHg), the valve will open and the sound of deflation will be heard, and the prompt message “Over Pressure” will be displayed on the screen.

If the system can give an alarm and deflate normally, the overpressure protection function is normal.

Otherwise, please contact the service technician of our company.

24.15 Electric Safety Test

The users can not conduct the electric safety test including ground impedance test, leakage current test and so on. Please contact the service technician for the electric safety test when necessary.

Appendix I Accessories

Warning

- Please use the accessory models specified by the manufacturer. Using other models of accessories may damage the monitor or affect performance.
- Disposable accessories can only be used once. Repeated use may result in reduced performance or cross-infection.
- Please check the packaging of the accessories before using the accessories. Do not use the accessory if it is found to be damaged or not.
- Expired and damaged accessories may cause environmental pollution and must be disposed of in accordance with relevant local laws and regulations or hospital systems.
- When using accessories, refer to the accessory manual, and consider the requirements for operating environment of accessories.
- This monitor and its supporting accessories have been tested for compliance with relevant standards.
- Before monitoring the patient, check the accessories are compatible with the monitor. Incompatible accessories reduce the performance of the monitor.
- The accessories provided in this manual are used in conjunction with this monitor.
- Electrode, the metal end of electrode plate, the surface of SpO₂ probe in contact with the measuring part, blood pressure cuff and CO₂ sampling tube are applied parts.

Defibrillation accessory		
Model/Specification	Name	Remark
CM3901	External defibrillation electrode paddle	Reusable
DF20N	Defibrillation pads (adult)	Disposable
DF31G	Defibrillation pads (pediatric)	Disposable
CM3905	Paddle cable	Reusable
CM3912	Test load of paddle extension wire	Reusable
Signa Gel REF 15-25	Defibrillation conductive paste	Reusable
ECG accessory		
Model/Specification	Name	Remark
T-401	Neonatal ECG Electrode	Disposable
FS-TC1	Adult ECG Electrode	Disposable
ECG lead wire		
Model/Specification	Name	Remark
98ME01AC458	3-lead, AHA standard, split clip, ECG cable	Reusable

Accessories

98ME01AC457	5-lead, AHA standard, split clip, ECG cable	Reusable
98ME01AB076	12-lead, AHA standard, split clip, ECG cable	Reusable
98ME01EC681	3-lead, IEC standard, split clip, ECG cable	Reusable
98ME01EC680	5-lead, IEC standard, split clip, ECG cable	Reusable
98ME01EB075	12-lead, IEC standard, split clip, ECG cable	Reusable
98ME01AD473	3-lead, AHA standard, integrated clip, ECG cabl	Reusable
98ME01AD474	5-lead, AHA standard, integrated clip, ECG cable	Reusable
98ME01AD475	12-lead, AHA standard, integrated clip, ECG cable	Reusable
98ME01EB477	3-lead, IEC standard, integrated clip, ECG cable	Reusable
98ME01EB478	5-lead, IEC standard, integrated clip, ECG cable	Reusable
98ME01EB479	12-lead, IEC standard, integrated clip, ECG cable	Reusable
98ME01EB046	3-lead, neonate, main cable (AHA / IEC)	Reusable
98ME01AC658	3-lead, pediatric / neonate, IEC standard, , ECG cable	Reusable
SpO₂ accessory		
Model/Specification	Name	Remark
SAL104	Analog adult SpO ₂ probe, finger clip	Reusable
SLZ122	Analog SpO ₂ main cable	Reusable
SAS104	Analog adult SpO ₂ probe, finger clip	Reusable
ES104-068-01	Analog SpO ₂ probe, bundled	Reusable
A0816-SA105PV	Analog SpO ₂ probe, finger clip	Reusable
SLZ101	Masimo SpO ₂ extension cable (main cable)	Reusable
M-LNCS DCI	Masimo adult SpO ₂ probe, finger clip	Reusable
M-LNCS YI	Masimo Y-type SpO ₂ probe	Reusable
RD SET DCI	Masimo adult SpO ₂ probe, finger clip	Reusable
RD SET YI	Masimo Y-type SpO ₂ probe	Reusable
CM12-RD-L	Masimo SpO ₂ main cable	Reusable
RD SET MD14-12	Masimo SpO ₂ main cable	Reusable
049-000256	Masimo Y-type SpO ₂ sheath	Reusable
SLZ068	Nellcor SpO ₂ extension cable (main cable)	Reusable
DS-100A	Nellcor adult SpO ₂ probe, finger clip	Reusable
D-YS	Nellcor Y-type bundled SpO ₂ probe	Reusable
NIBP cuff		
Model/Specification	Name	Remark
U1880S	NIBP cuff, Adult /25-35cm	Reusable
U1881S	NIBP cuff, Pediatric /18-26cm	Reusable

Accessories

U1882S	NIBP cuff, infant /10-19cm	Reusable
U1883S	NIBP cuff, neonate /6-11cm	Reusable
U1884S	NIBP cuff, Adult thigh /46-66cm	Reusable
U1885S	NIBP cuff, small adult /20-28cm	Reusable
U1869S	NIBP cuff, large adult /33-47cm	Reusable
U1889S	NIBP cuff, large adult /33-47cm	Reusable
U1681S	NIBP cuff, neonate /3cm to 6cm/Disposable	Disposable
U1682S	NIBP cuff, neonate/4cm to 8cm/ Disposable	Disposable
U1683S	NIBP cuff, neonate /6cm to 11cm/ Disposable	Disposable
U1684S	NIBP cuff, neonate/7cm to 13cm/ Disposable	Disposable
U1685S	NIBP cuff, neonate/8cm to 15cm/ Disposable	Disposable
CMAN0B02	NIBP catheter	Reusable
CMAN0B01	NIBP catheter	Reusable
CO₂ accessory		
Model/Specification	Name	Remark
1022054	Respironics LoFlo sidestream CO ₂ module	Reusable
98ME07GC067	Respironics LoFlo Sidestream CO ₂ extension cable	Reusable
3473ADU-00	Respironics LoFlo Sidestream children / adults airway adapter (with dehumidification tube)	Disposable
3473INF-00	Respironics LoFlo Sidestream children / infant airway adapter (with dehumidification tube)	Disposable
1027730	Respironics LoFlo Sidestream module fixing clip	Reusable
F-01	External CO ₂ module(Respironics CapnoTrak sidestream CO ₂ module)	Reusable
1103416	Respironics Capno Trak sidestream ETCO ₂ filter tube	Disposable
1103417	Respironics Capno Trak sidestream ETCO ₂ drying tube	Disposable
1103414	Respironics Capno Trak sidestream CO ₂ Sampling tube (large airway adapter)	Disposable
1103415	Respironics Capno Trak sidestream CO ₂ Sampling tube (small airway adapter)	Disposable
F-02	COMEN sidestream CO ₂ module (share one set of accessories with Respironics CapnoTrak Sidestream CO ₂)	Reusable
M-01	Comen mainstream CO ₂ module (share one set	Reusable

Accessories

	of accessories with Respirationics capnostat5 Sidestream CO2)	
98ME07GC968	Masimo CO2 / AG extension cable	Reusable
Nomoline ISA CO2	Masimo Nomoline ISA CO2 module	Reusable
CAT.NO.108210	Masimo sidestream CO2 / AG sampling tube	Disposable
REF 3827	Masimo sidestream CO2 / AG sampling tube (adult / child)	Disposable
REF 3829	Masimo sidestream CO2 / AG sampling tube (infant)	Disposable
REF 3830	Masimo sidestream CO2 / AG sampling tube nose tube (adult)	Disposable
REF 3831	Masimo sidestream CO2 / AG sampling tube nose tube (children)	Disposable
REF 3832	Masimo sidestream CO2 / AG sampling tube nose tube (infant)	Disposable
IRMA CO2	Masimo mainstream CO2 external module	Reusable
CAT.NO.106220	Masimo mainstream CO2 / AG adapter (adult / child)	Disposable
CAT.NO.106260	Masimo mainstream CO2 / AG adapter (infant)	Disposable
1015928	Respirationics Capnostat5 mainstream CO2 external module	Reusable
6063-00	Respirationics mainstream adult airway adapter/Single patient use	Disposable
6312-00	Respirationics mainstream neonate airway adapter/Single patient use	Disposable
8751-0	Cable fixing slot	Reusable

Appendix II Product Specifications

1) Monitor Type

Classified by	Type	
Electric shock protection type	Class I with internal power	
Electric shock protection level	BF	CO ₂
	CF	Defibrillation, ECG, NIBP, SpO ₂ , RESP, and PR/pulse
Safety standards	IEC 60601-1, IEC 60601-2-27, ISO 80601-2-55, IEC 80601-2-30, IEC 60601-2-49, EN 60601-1-8, IEC 60601-2-34	
Anti-liquid penetration degree	IPX4: can prevent the harmful effects of splashing water on the equipment	
Anti-solid particle entry level	IP4X: can prevent solid foreign objects with a diameter of not less than 1.0mm from entering	
The degree of safety in the condition of flammable anesthetic gas mixed with the mixture like air, the oxygen or nitrous oxide mixture (It's NA)	The device cannot be used in the case of flammable anesthetic gas mixed with air and the mixture of oxygen or nitrous oxide.	
Work mode	Continuous operation equipment	
Mobile level	Portable	

2) General Specifications

2.1 Dimension and Weight

Item	Specification
Dimension	295 mm×252 mm×316mm
Weight	5.384kg (Main Unit)

2.2 Environmental Specifications

Item	Specification	
Working conditions	Ambient temperature	0°C ~ 45°C
	RH	10% ~ 95%, non-condensing
	Barometric pressure	570hPa~1060hPa
Transportation and Storage conditions	Transportation and Storage temperature	-30°C ~ 70°C
	RH	10% ~ 95%, non-condensing
	Barometric pressure	570hPa~1060hPa
	Protect the monitor against violent impact, vibration, rain and snow in transportation.	

2.3 Power Supply

Item	Specification
input voltage	100~240VAC($\pm 10\%$)
input frequency	50Hz/60Hz ± 3 Hz
Input current	2.5~1.0A
Input power	200VA

2.4 Display

Name	Specification
Display	7-inch screen, TFT display, and color LCD screen
Display information	Up to 4 waveform displays
Resolution	800 \times 480 pixels

2.5 Recording (optional parts)

Item	Specification
Recording paper width	50mm
Effective recording width	48mm
Paper speed	6.25/12.5/25/50 mm/s
RT record time	3s, 5s, 8s, 16s, 32s, or continual
Number of waveforms	Up to 3 waveforms
Any alarm record	Yes

2.6 Battery

Name	Specification
Battery specification	<ul style="list-style-type: none"> ◆ 7500mAh d.c.14.8V has a relative error of +5% and -10%. ◆ 5000mAh d.c.14.8V has a relative error of +5% and -10%.
Battery charging time	<p>Battery of 7500mAh d.c.14.8V: Charging to 80% is less than 2 hours, charging to 90% is about 2 hours, and charging to 100% is less than 3 hours.</p> <p>Battery of 5000mAh d.c.14.8V: Charging to 80% is less than 1.5 hours, charging to 90% is about 2 hours, and charging to 100% is less than 2.5 hours.</p>
Battery operating time	<p>The operating time of each new battery at an ambient temperature of 20 °C is as follows (the operating time of two batteries is twice that of a battery)</p> <p>Battery of 7500mAh d.c.14.8V:</p> <ul style="list-style-type: none"> ◆ Monitoring mode: Operate for no less than 6 hours ◆ Defibrillation mode: no less than 210 discharges (maximum energy, charging interval is not less than one minute, and the recorder does not print); ◆ Pacing mode: no less than 4.5 hours (load of 50Ω, frequency of 80bpm, current of 60mA, and the recorder does not print); <p>Battery of 5000mAh d.c.14.8V:</p>

	<ul style="list-style-type: none"> ◆ Monitoring mode: Operate for no less than 4 hours ◆ Defibrillation mode: no less than 130 discharges (maximum energy, charging interval is not less than one minute, and the recorder does not print); ◆ Pacing mode: no less than 3 hours (load of 50Ω, frequency of 80bpm, current of 60mA, and the recorder does not print);
Battery capacity meter	The battery body has a multi-segment LED battery level indicator that can be used to quickly assess battery power.
Low battery alarm	Continuous vital signs monitoring for 20 minutes after an alarm has occurred, with a minimum of 6 maximum energy deliberations.

2.7 Defibrillation specification

Defibrillation mode	Specification
Defibrillation mode	Manual asynchronous defibrillation, simultaneous defibrillation, and AED defibrillation modes
Defibrillation waveform	BTE waveform, and waveform parameters can be automatically compensated according to patient impedance
Supported electrode type	External defibrillation electrode paddle and multi-functional electrode paddle , wherein the external electrode paddle is adult/pediatric multi-functional type
Control and indication of external electrode paddle	The external electrode paddle of the defibrillation monitor has functions such as charging, discharging, energy selection, etc., and has a charging completion indicator.

Manual defibrillation energy selection range	
External defibrillation	1/2/3/4/5/6/7/8/9/10/15/20/30/50/70/100/120/150/170/200/220/250/270/300/360J

Patient impedance range	
External defibrillation	20Ω ~ 300Ω

Energy output accuracy	
Under 25Ω, 75Ω, 100Ω, 125Ω, 150Ω, and 175 Ω loads, the deviation between the release energy and the rated release energy value of the defibrillation monitor does not exceed ±2J or ±15% (whichever is greater).	
Under a 50 Ω load, the deviation between the release energy and the rated release energy value of the defibrillation monitor does not exceed ±1.5J or ±10% (whichever is greater).	

360J defibrillation waveform (load impedance is 25Ω, 50Ω, 75Ω, 100Ω, 125Ω, 150Ω and 175Ω, respectively)

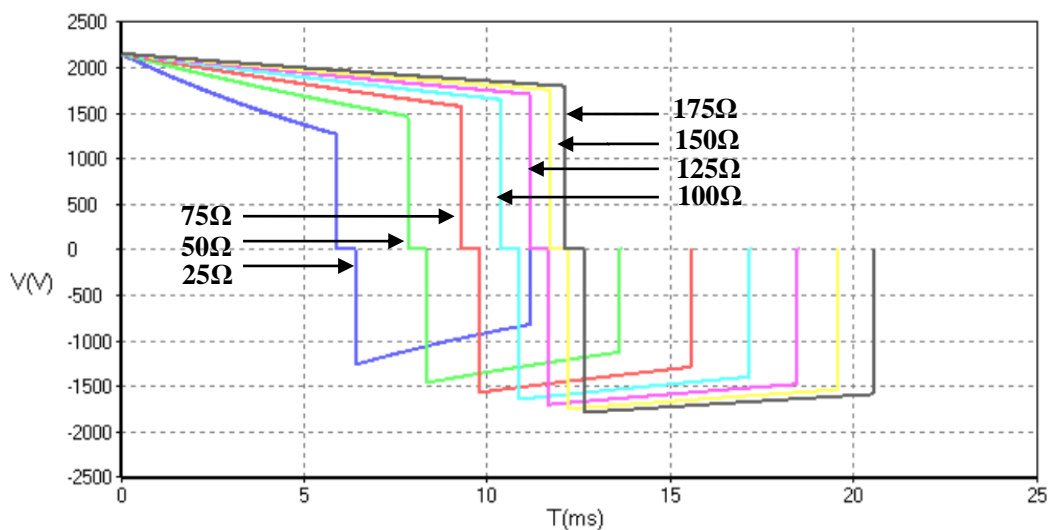

Energy accuracy								
Impedance Energy	25Ω	50Ω	75Ω	100Ω	125Ω	150Ω	175Ω	Accur acy
1J	1	1	1.1	1	1 ¹⁰	0.9	0.8	±2J
2J	2	2	2	2	2	1.8	1.8	±2J
3J	2.8	3	3	2.8	3	2.7	2.5	±2J
4J	3.8	4	4.1	3.8	4	3.6	3.5	±2J
5J	4.8	5	5.0	4.8	4	4.5	4.2	±2J
6J	5.8	6	5.9	5.9	5	5.4	5.3	±2J
7J	6.8	7	6.9	6.9	6.8	6.3	6.0	±2J
8J	7.8	8	8	8.0	7.5	7.2	7.0	±2J
9J	8.8	9	9	8.6	8.5	8.1	7.7	±2J
10J	9.6	10	9.9	9.6	9.3	9.0	8.4	±2J
15J	15	15	15	14	14	13	13	±15%
20J	19	20	20	19	18	17	17	±15%
30J	29	30	30	29	27	26	25	±15%
50J	49	50	49	48	45	44	42	±15%
70J	68	70	69	66	63	60	58	±15%
100J	98	101	98	95	90	86	83	±15%
120J	118	122	119	114	109	104	100	±15%
150J	148	152	148	142	136	130	124	±15%
170J	167	172	168	160	151	147	140	±15%
200J	197	203	198	189	180	173	165	±15%
220J	217	224	218	209	199	190	182	±15%
250J	245	254	247	237	226	216	207	±15%
270J	267	275	267	256	244	233	223	±15%
300J	297	305	296	284	270	258	247	±15%

Product Specifications

360J	356	363	354	339	324	310	296	±15%
------	-----	-----	-----	-----	-----	-----	-----	------

Charge time (Note: at 20 °C of ambient temperature)								
	Manual defibrillation				AED			
	Charge time		From initial power on to charge done		From initiation of rhythm analysis to charge done		From initial power on to charge done	
	200J	360J	200J	360J	200J	360J	200J	360J
With a new, fully charged battery	<3s	<7s	<11s	<14s	<16s	<20s	<21s	<24s
With a new, fully charged battery, depleted by 15 360 J discharges	<3s	<7s	<12s	<15s	<17s	<21s	<22s	<25s
With 90% to 100% rated mains voltage	<4s	<8s	<13s	<16s	<16s	<19s	<22s	<28s
AC mains: 100 to 240 VAC (±10%)								

Synchronous discharge delay	
Local synchronous discharge delay	Less than 60ms (from the R wave spike)
Remote synchronous discharge delay	Less than 25ms (from the rising edge of the synchronous signal)

AED defibrillation	
Electric shock sequence	Electric shock energy: 100~360J can be set Number of electric shocks: once, twice, and 3 times can be set
Shockable rhythm	VF and VT

AED algorithm performance		
Cardiac rhythm type	Performance requirement	Remark
Shockable cardiac rhythm VF	Sensitivity >90%	Meet AAMI DF80 requirements and AHA recommendations for adult defibrillation (sensitivity > 90%)
Shockable cardiac rhythm VT	Sensitivity >75%	Meet AAMI DF80 requirements and AHA recommendations for adult defibrillation (sensitivity > 75%)
Non-shockable cardiac rhythm Normal sinus rhythm	Specificity >99%	Meet AAMI DF80 requirements and AHA recommendations for adult defibrillation (specificity > 99%)
Non-shockable cardiac rhythm Cardiac arrest	Specificity >95%	Meet AAMI DF80 requirements and AHA recommendations for adult defibrillation (specificity > 95%)
Non-shockable cardiac rhythm	Specificity >95%	Meet AAMI DF80 requirements and AHA recommendations for adult

All other non-shockable cardiac rhythms		defibrillation (specificity > 95%)
---	--	------------------------------------

2.8 Pacing Specification

Pacing	
Pacing mode	Fixed pacing, and on-demand pacing
Pacing waveform	One-way square wave pulse with a pulse width of 20ms \pm 5% or 40ms \pm 5%
Pacing frequency	30ppm~210ppm, and frequency accuracy is \pm 1ppm or \pm 1.5% (whichever is greater)
Pacing current	0mA~200mA, and current accuracy is \pm 5% or 5mA (whichever is greater)
Slow-down pacing	When this function is activated, the pacing frequency is reduced to 1/4 of the original value.
Output protection	The output end can withstand 360J energy discharge without any damage.

2.9 ECG Specifications

Item	Specification	
Applicable standards:	IEC 60601-2-27.	
ECG input	Support 3-lead ECG lead wires, 5-lead ECG lead wires, electrode paddles and multi-functional electrode pads as the ECG input sources	
ECG update time	1s	
Sensitivity (gain) and error	Support at least 1.25 mm/mV (\times 0.125), 2.5 mm/mV (\times 0.25), 5 mm/mV (\times 0.5), 10 mm/mV (\times 1), 20 mm/mV (\times 2), 40 mm/mV (\times 4) and automatic gain, and the error is less than \pm 5%. With a DC polarization voltage of \pm 750 mV, the sensitivity varies by \pm 5%.	
Scanning speed	50mm/s, 25mm/s, 12.5mm/s, and 6.25mm/s, and the error is no more than \pm 10%	
ECG signal range	\pm 0.2~ \pm 8mV	
Overload protection	Load 1V, power frequency, differential-mode AC voltage for 10s without damage (p-v)	
Resp, lead off detection and active noise suppression	AC waveform: Current of Measurement electrode <0.1 μ A Current of drive electrode <1 μ A Frequency 64kHz, \pm 10%	
QRS wave amplitude and interval	Amplitude (p-v RTI)	0.2mV~8mV
	Width (adult)	70ms~120ms
	Width (neonate/pediatrics)	40ms~120ms
	Not respond to the following signals:	a) with amplitude (p-v RTI) not exceeding 0.15mV (except in neonate/pediatrics mode); or b) with 10ms width (except in neonate/pediatrics mode) in case of 1mV amplitude.
Voltage tolerance of power frequency	> 100 μ V (p-v)	
Power frequency	a) Power frequency interference suppression capability: \geq 20dB;	

Product Specifications

notch	b) Monitoring and surgical modes: Support the 50/60Hz notch function; c) Diagnostic mode: Support the 50/60Hz notch manual setting and manual selection of strong / weak notch.	
Drift tolerance	Triangular wave amplitude (p-v RTI)	4mV
	QRS wave amplitude (p-v RTI)	0.5 mV
	QRS wave width	100ms
	QRS wave recurrence frequency	80bpm
HR measurement range and accuracy	Adult	15~300bpm
	Neonate/pediatrics	15~350bpm
	accuracy	±1% or ±1 bpm, whichever is greater
	Resolution	1bpm
Alarm limit range	Adult	high limit : (low limit+2bpm)~300bpm low limit: 15bpm~(high limit-2bpm)
	Neonate/Pediatrics	high limit : (low limit+2bpm)~350bpm low limit: 15bpm~(high limit-2bpm)
Alarm limit error	±1 bpm	
Alarm start time for asystole and high/low HR	11s	
Start time of cardiac arrest alarm	11s	
Bandwidth	Surgery mode: 1 Hz~20 Hz (-3.0dB~+0.4dB); Monitoring Mode: 0.5 Hz~40 Hz (-3.0dB~+0.4dB); Diagnosis mode: 0.05Hz~150 Hz (-3.0dB~+0.4dB); ST mode : 0.05Hz~40Hz(-3.0dB~+0.4dB)	
Analog Output	Bandwidth	0.5-40Hz
	Gain	1000 times larger, error ±5%
	Transmission delay	≤35ms
	The output signal contains the unprocessed raw pacing signal.	
Dynamic input range	Input signal amplitude	±8mV (peak-to-peak value);
	Rate (RTI)	320mV/s;
	DC offset voltage	±750mV;
	Output signal change	±10%;
	Failure display (attenuation prior to display)	Maximum attenuation 50%
Input impedance	≥5MΩ	
System noise (p-v RTI)	<25 μV	
Multi-channel crosstalk	<5%	

Product Specifications

Time selection and accuracy	Time reference	Permanent display	25mm/s	
		Non-permanent display	12.5 mm/s、 25 mm/s、 50 mm/s	
	Maximum time reference error	±10%。		
Output display	Channel width	30mm		
	Aspect ratio	0.4s/mV		
Input signal reproduction accuracy	Total system error	±20% or ±100μV, whichever is larger.		
	Frequency response	Sinusoidal input	0.67~40Hz (attenuation: -3dB)	
		Response to 20ms (width) triangular wave	0~25Hz attenuation in amplitude of wave peak	
	Response to 0.3mV s shock in the shock range	Offset (RTI)	≤0.1mV	
		Slope (RTI)	≤0.30mV/s	
	Electrode weighting factor	≥±5%		
	Delay effect of 15mm offset	≤0.5mm		
Calibration voltage	±5% error at 1mV			
Common mode rejection	Surgery mode	>90dB		
	Monitoring mode	>105dB		
	Diagnosis mode	>105dB		
	ST mode	>105dB		
Baseline control and stability	Recovery time after reset	3s		
	Drift rate in 10s	10μV/s		
	Baseline drift in 1h	≤500μV		
	Baseline drift at working temperature	≤50μV/°C		
Non-overshoot pacemaker pulse inhibition	<p>Amplitude: ±2mV~±700mV; width: 0.1ms~2.0ms; if overshoot < 0.05ap, settling time < 5μs; start time, end time, rise time and fall time of pulse: ≤ 100μs; start time of pulse: 40ms or earlier before the start time of QRS wave; there is an identical pulse 150ms~250ms before the above pacemaker pulse.</p>			
Inhibition of pacemaker pulse detector on quick ECG signals	Minimum input slew rate: 660mV/s			
Pacemaker pulse display capability	Amplitude: ±2MV~±700MV; width: 0.5MS~2MS;	≥0.2mV		

	maximum rise time: 100 μ S; the ECG display when the pacemaker pulse appears at 100/min.	
ST segment detection	Measuring range	-2.0mV~+2.0mV (-20.0 mm~+20.0 mm)
	Measurement accuracy	The measurement error in the range of -0.8 mV to +0.8 mV is ± 0.02 mV or $\pm 10\%$; the other ranges are not defined.
	Resolution	0.01 mV (0.1 mm)
ST alarm range and alarm error	The upper limit alarm setting range is (lower limit +0.2) to 2.0 mV, the lower limit alarm setting range is -2.0 to (upper limit -0.2 mV), and the alarm error is set value ± 0.1 mV.	
Arrhythmia types	Asystole, ventricular fibrillation, R ON T, VT>2, Couplet, PVC, Bigeminy, Trigeminy, Brady (Bradycardia), PNC (Pacer Not Capture), PNP (Pacer Not Pace), Missed Beats, IHB (Irregular Heart Beat), VTAC (Ventricular Tachycardia), Tachy (Tachycardia), PVCs Too High, Extreme Tachycardia, Extreme Bradycardia, Ventricular Rhythm, Heart Pause	
Range of PVCs	1-31 PVCs/min	
Leakage current	< 10 μ A	
Electrosurgical interference inhibition	HR change caused by interference: $\leq \pm 10\%$	
ESU protection	Cut mode: 300W Condense mode: 100W Recovery time: ≤ 10 s	
Enhance/Reject (PACE)	Do not have pace reject or enhance.	
Level trigger threshold for HR detection	Level trigger threshold for HR detection is 200 μ V	
Noise suppression of electrotope	ECG lead wire conforming to the standard is used, relative to ECG baseline, peak-to-peak noise ≤ 2 mV	
Input bias current	Input loop current shall be no more than 0.1 μ A	

2.10 Defibrillation ECG specification

Single-lead ECG, electrode paddles and multi-functional electrode pads as the ECG input sources	
Frequency characteristic	Defibrillation electrode: 1Hz ~ 20Hz (-3.0dB ~ +0.4dB)
Common mode suppression ability	Defibrillation electrode: >105dB
Differential input impedance	Defibrillation electrode: ≥ 5 M Ω
Input signal range	± 8 mV (peak-to-peak value);
HR detection level trigger threshold	200 μ V
Input dynamic range	DC bias voltage up to ± 500 mV

System noise	The noise level converted to the input shall be no more than 25 μ V (peak-to-peak value)	
Calibration voltage	1 mV, with an error range of $\pm 5\%$	
Arrhythmia analysis	ASY, VF, VT, PNC, and PNP	
HR measuring range and accuracy	Measuring range	15bpm ~ 300bpm for adults; 15bpm ~ 350bpm for newborns/children
	Accuracy	± 1 bpm or $\pm 1\%$, whichever is greater
Resolution	1bpm	
Noise suppression of electrocardiogram	ECG lead wire conforming to the standard is used, relative to ECG baseline, peak-to-peak noise ≤ 2 mV	
Input bias current	Input loop current shall be no more than 0.1 μ A	
HR alarm setting range	Adults: upper limit: (lower limit + 2bpm) ~ 300bpm, lower limit: 15bpm ~ (upper limit - 2bpm); Newborns/children: upper limit: (lower limit + 2bpm) ~ 350bpm, lower limit: 15bpm ~ (upper limit - 2bpm)	
Alarm accuracy	± 1 bpm	

HR algorithm		
High T-wave suppression ability		1.2mV
HR mean	As required in Section 201.7.9.2.9.101 b) 3) of IEC 60601-2-27, the HR is calculated as follows. If all of the last 3 RR intervals are longer than 1200ms, the average of the last 4 RR intervals is the HR. In other cases, the average of the last 12 RR intervals (with the longest interval and shortest interval excluded) is the HR.	
HR meter accuracy and response to arrhythmias	Meet the requirements of IEC 60601-2-27: Clause 201.12.1.101.17 b) 4), the HR is displayed as follows after the 20s stable segment: Figure A1, Ventricular bigeminy: 80 ± 1 bpm Figure A2, Slow alternating ventricular bigeminy: 60 ± 1 bpm Figure A3, Rapid alternating ventricular bigeminy: 120 ± 1 bpm Figure A4, Bidirectional systoles: 90 ± 2 bpm	
HR change response time	As required in Section 201.7.9.2.9.101 b) 5) of IEC 60601-2-27, HR increases from 80 to 120bpm: less than 11s; HR decreases from 80 to 40bpm: less than 11s.	
Start time of TACHY alarm	Meet the requirements of IEC 60601-2-27: Clause 201.7.9.2.9.101 b) 6), the waveform (including one-half and twice amplitudes): Figure B1 1 - range: 11s Figure B1 0.5 - range: 11s Figure B1 2 - range: 11s Figure B2 1 - range: 11s Figure B2 0.5 - range: 11s Figure B2 2 - range: 11s	

2.11 Resp Specifications

Item	Specification		
Method	Thoracic impedance method		
Measuring lead	Leads I and II are optional		
Respiratory excitation waveform	<300 excitation waveform RTI, 64kHz ($\pm 10\%$)		
Measurement range	Adult	0rpm-120rpm	
	Pediatrics/neonate	0rpm-150rpm	
Measurement accuracy	7rpm~150rpm: ± 2 rpm or $\pm 2\%$, whichever is greater. 0rpm~6rpm: not defined.		
No RESP alarm	No RESP alarm setting time for adults shall be in the range of 10s ~ 60s; setting range for children and newborns: 10s~40s; measurement error shall be ± 5 s		
RR alarm limit range and error	Adult	high limit	(low limit+2rpm)~120rpm
		low limit	0rpm~(high limit-2rpm)
RR alarm limit range and error	Neonate/child	high limit	(low limit+2rpm)~150rpm
		low limit	0rpm~(high limit-2rpm)
	Error	± 1 rpm	
CVA identification	The monitor will display the relevant alarm message when the HR is identical with the RR.		

2.12 NIBP Specifications

Item	Specification		
The NIBP sensor complies with IEC 80601-2-30.			
Measurement method	Auto oscillation method		
COMEN NIBP Measurement range and accuracy	Measurement range (adult)	Systolic pressure	5.3~36kPa (40~270mmHg)
		Diastolic pressure	1.3~28.7kPa (10~215mmHg)
		MAP	2.7~31.3kPa (20~235mmHg)
	Measurement range (pediatrics)	Systolic pressure	5.3~30.7kPa (40~230mmHg)
		Diastolic pressure	1.3~20kPa (10~150mmHg)
		MAP	2.7~22kPa (20~165mmHg)
	Measurement range (neonate)	Systolic pressure	5.3~18kPa (40~135mmHg)
		Diastolic pressure	1.3~13.3kPa (10~100mmHg)
		MAP	2.7~14.7kPa (20~110mmHg)
SUNTECH NIBP Measurement	Measurement range (adult)	Systolic pressure	40mmHg~260mmHg(5.3kPa~34.7kPa)

Product Specifications

range		MAP	26mmHg~220mmHg(3.5kPa~29.3kPa)
		Diastolic pressure	20mmHg~200mmHg(2.7kPa~26.7kPa)
	Measurement range (pediatrics)	Systolic pressure	40mmHg~160mmHg(5.3kPa~21.3kPa)
		MAP	26mmHg~133mmHg(3.5kPa~17.7kPa)
	Measurement range (neonate)	Diastolic pressure	20mmHg ~120mmHg(2.7kPa~16kPa)
		Systolic pressure	40mmHg~130mmHg(5.3kPa~17.3kPa)
		MAP	26mmHg~110mmHg(3.5kPa~14.7kPa)
		Diastolic pressure	20mmHg~100mmHg(2.7kPa~13.3kPa)
	Static measurement range and accuracy	Range: 0~300mmHg; Adult and Pediatrics: 0~300mmHg, Neonate: 0~150mmHg Accuracy: ± 3 mmHg (± 0.4 kPa)	
Initial inflation pressure	COMEN NIBP: Adults: 80mmHg ~ 280mmHg (10.7kPa ~ 37.3kPa); Children: 80mmHg ~ 210mmHg (10.7kPa ~ 28kPa); Newborns: 60mmHg ~ 140mmHg (8kPa ~ 18.7kPa). SUNTECH NIBP: Adults: 120mmHg~280mmHg(16kPa~37.3kPa); Children: 80mmHg~170mmHg(10.7kPa~22.7kPa); Newborns: 60mmHg ~ 140mmHg (8kPa ~ 18.7kPa).		
Overpressure protection range and tolerance	COMEN NIBP	Adult mode	297mmHg (39.6kPa)
		Pediatrics mode	240mmHg (32kPa)
		Neonate mode	147mmHg (19.6kPa)
		Tolerance	± 3 mmHg (0.4kPa)
	SUNTECH NIBP	Adult/ Pediatrics mode	300mmHg(40.0kPa)
		Neonate mode	150mmHg(20.0kPa)
Alarm limit range and error	Adult	Systolic pressure	High limit: 5.6kPa~36kPa(42mmHg~270mmHg), Low limit: 5.3kPa~35.7kPa (40mmHg~268mmHg)
		Diastolic pressure	High limit : 1.6kPa ~ 28.7kPa (12 mmHg ~ 215mmHg) , Low limit : 1.3kPa ~ 28.4kPa (10 mmHg ~ 213mmHg)
		MAP	High limit : 2.9kPa ~ 31.3kPa (22 mmHg ~

Product Specifications

			235mmHg) , Low limit: 2.6kPa ~ 31.1 kPa (20 mmHg ~ 233mmHg)
	Pediatrics	Systolic pressure	High limit: 5.6kPa~26.7kPa (42mmHg~230mmHg) , Low limit: 5.3kPa~26.3kPa (40mmHg~228mmHg)
		Diastolic pressure	High limit: 1.6kPa~20kPa (12mmHg~150mmHg) , Low limit: 1.3kPa~19.7kPa (10 mmHg~148mmHg)
		MAP	High limit : 2.9 kPa ~ 22kPa (22mmHg ~ 165mmHg) , Low limit : 2.6kPa ~ 21.7kPa (20mmHg ~ 163mmHg)
	neonate	Systolic pressure	High limit : 5.6kPa ~ 18kPa (42mmHg ~ 135mmHg) , Low limit : 5.3kPa ~ 17.7kPa (40mmHg ~ 133mmHg)
		Diastolic pressure	High limit : 1.6kPa ~ 13.3kPa (12 mmHg ~ 100mmHg) , Low limit : 1.3kPa ~ 13.1kPa (10 mmHg ~ 98mmHg)
		MAP	High limit: 2.9 kPa ~ 14.7kPa(22mmHg ~ 110mmHg), Low limit: 2.6kPa ~ 14.4kPa(20 mmHg ~ 108mmHg)
	accuracy	±0.1kPa or ±1mmHg, whichever is greater.	
NIBP measurement mode	Manual, auto (cyclic) or continual (not applicable to neonates)		
	Interval for auto mode	1min, 2.5min, 2min, 3min, 4min, 5min, 10min, 15min, 30min, 60min, 90min, 120min, 180min, 240min, 480min, 720min	
	Continual	5min	
Maximum measurement cycle	COMEN NIBP: Adult/Pediatrics: 120s; Neonate: 85s SUNTECH NIBP: Adult: 130s; Pediatrics: 90s; Neonate: 75s		

2.13 SpO₂ Specifications

Item	Specification	
Applicable standards: ISO 80601-2-61		
Range	1% ~ 100%	
Resolution	1%	
Response time	Under normal perfusion without interference conditions: <30s (SpO ₂ value mutation from 70% to 100%) <30s (the sudden change of PR value from 25bpm to 220bpm)	
Measurement accuracy	a) Comen SpO ₂ : measurement range: 0%~100%; measurement accuracy: When measurement range is 70%~100%, the accuracy is ±2% (adult/ pediatrics, in non-motion state) or ±3% (neonate, in non-motion state) b) Masimo SpO ₂ : measurement range 1% ~ 100%; measurement accuracy: During No Motion Conditions¹ Adults and Pediatric 70% - 100% ± 2 digits 0% - 69% unspecified Neonates 70% - 100% ± 3 digits 0% - 69% unspecified During Motion Conditions^{2,3} Adults and Pediatric 70% - 100% ± 3 digits 0% - 69% unspecified Neonates 370% - 100% ± 3 digits 0% - 69% unspecified c) Nellcor SpO ₂ : measurement range 0% ~ 100%; measurement accuracy: When measurement range is 70%~100%, the accuracy is ±2% (adult/ pediatrics, in non-motion state) or ±3% (neonate, in non-motion state). d) Measurement accuracy is not defined in other ranges	
Alarm limit range and accuracy	Comen SpO ₂ : 0% ~ 100%, high limit : (low limit+1%)~100% low limit: 0%~(high limit-1%) Masimo SpO ₂ : 1% ~ 100%, high limit : (low limit+1%)~100% low limit: 1%~(high limit-1%) Nellcor SpO ₂ : 20% ~ 100%, high limit : (low limit+1%)~100% low limit: 20%~(high limit-1%)	
	<table border="1"> <tr> <td>Accuracy</td> <td>±1%</td> </tr> </table>	Accuracy
Accuracy	±1%	
Data update time	≤ 1s	
Perfusion index (PI)		
Measurement Range	Masimo: 0.02 % ~ 20 % , the accuracy is not defined; Comen: 0.05 % ~ 20 % , the accuracy is not defined	

Product Specifications

Resolution	Masimo: 0.02%~9.99%: 0.01%; 10.0% ~20.0%: 0.1%. Comen: 0.05%~9.99%: 0.01%. 10.0%~20.0%: 0.1%
Weak perfusion	
Weak perfusion condition	Pulse amplitude: > 0.2%
SpO ₂ accuracy	±3%

Masimo Accuracy Footnotes:

- 1 The Masimo SET technology with Masimo sensors has been validated for no motion accuracy in human blood studies on healthy adult male and female volunteers with light to dark skin pigmentation in induced hypoxia studies in the range of 70-100% SpO₂ against a laboratory CO-Oximeter and ECG monitor. This variation equals ±1 standard deviation. Plus or minus one standard deviation encompasses 68% of the population.
- 2 The Masimo SET technology with Masimo sensors has been validated for motion accuracy in human blood studies on healthy adult male and female volunteers with light to dark skin pigmentation in induced hypoxia studies while performing rubbing and tapping motions, at 2 to 4 Hz at an amplitude of 1 to 2 cm and a non-repetitive motion between 1 to 5 Hz at an amplitude of 2 to 3 cm in induced hypoxia studies in the range of 70-100% SpO₂ against a laboratory CO-Oximeter and ECG monitor. This variation equals ±1 standard deviation, which encompasses 68% of the population.
- 3 The Masimo SET technology has been validated for low perfusion accuracy in bench top testing against a Biotek Index 2™ simulator and Masimo's simulator with signal strengths of greater than 0.02% and transmission of greater than 5% for saturations ranging from 70 to 100%. This variation equals ±1 standard deviation. Plus or minus one standard deviation encompasses 68% of the population.
- 4 The Masimo SET Technology with Masimo Neo sensors has been validated for neonatal motion accuracy in human blood studies on healthy adult male and female volunteers with light to dark skin pigmentation in induced hypoxia studies while performing rubbing and tapping motions, at 2 to 4 Hz at an amplitude of 1 to 2 cm and a non-repetitive motion between 1 to 5 Hz at an amplitude of 2 to 3 cm in induced hypoxia studies in the range of 70-100% SpO₂ against a laboratory CO-Oximeter and ECG monitor. This variation equals ±1 standard deviation. Plus or minus one standard deviation encompasses 68% of the population. 1% has been added to the results to account for the effects of fetal hemoglobin present in neonates.
- 5 The Masimo SET technology with Masimo sensors has been validated for pulse rate accuracy for the range of 25 -240 bpm in bench top testing against a Biotek Index 2™ simulator. This variation equals ±1 standard deviation. Plus or minus one standard deviation encompasses 68% of the population.
- 6 Sensor accuracy specified when used with Masimo technology using a Masimo patient cable for LNOP sensors, RD SET sensors, the LNCS sensors, or the M-LNCS sensors. Numbers represent Arms (RMS error compared to the reference). Because pulse oximeter measurements are statistically distributed, only about two-thirds of the measurements can be expected to fall within a range of ± Arms compared to the reference value. Unless otherwise noted, SpO₂ accuracy is specified from 70% to 100%. Pulse Rate accuracy is specified from 25 to 240 bpm.
- 7 Masimo M-LNCS, LNOP, RD SET, and LNCS sensors types have the same optical and electrical properties and may differ only in application type (adhesive/non-adhesive/hook & loop), cable lengths, optical component locations (top or bottom of sensor as aligned with cable), adhesive material type/size,

and connector type (LNOF 8 pin modular plug, RD 15 pin modular plug, LNCS9 pin, cable based, and M-LNCS 15 pin, cable based). All sensor accuracy information and sensor application instructions are provided with the associated sensor directions for use.

2.14 PR Specifications

Item	Specification
Measurement range and accuracy	<p>a) Comen SpO₂: Measurement range: 20bpm~254bpm; resolution: 1bpm; measurement error: ±2bpm.</p> <p>b) Masimo SpO₂: Measurement range: 25bpm~240bpm; resolution: 1bpm; Accuracy: During No Motion Conditions¹ Adults, Pediatric and Neonates 25 – 240 bpm ± 3 digits During Motion Conditions^{2,3} Adults, Pediatric and Neonates 25 – 240 bpm ± 5 digits Low Perfusion Performance⁴ >0.02% Pulse Amplitude and % Transmission > 5% Pulse Rate: ± 3 digits</p> <p>c) Nellcor SpO₂: Measurement range: 20bpm~300bpm; resolution: 1bpm; measurement error: ±3bpm within 20bpm~250bpm range. The measurement accuracy within 251bpm~300bpm range is not defined.</p> <p>d) COMEN NIBP Measurement range: 40bpm~240bpm; resolution : 1bpm measurement error: ±3bpm or ±3%, whichever is greater.</p> <p>e) SUNTECH NIBP Measurement range: 20bpm~350bpm; resolution : 1bpm measurement error: ±1bpm or ±1%, whichever is greater.</p>
PR alarm limit range and resolution	high limit : (low limit+1bpm)~350bpm low limit: 20bpm~(high limit-1bpm) ±1bpm

2.15 CO₂ Specifications (only applicable to S5)

Item	Specification
The EtCO₂ sensor complies with ISO 80601-2-55.	

CO ₂ measurement range	<p>a) Respironics LoFlo CO₂: The range is 0mmHg~150mmHg, 0%~19.7%, 0kPa~20kPa (at760mmHg). CapnoTrak CO₂: 0mmHg ~ 99mmHg, 0% ~ 13.03%, 0kPa ~ 13.2kPa(at760mmHg) CAPNOSTAT CO₂: 0 mmHg~150 mmHg, 0%~19.7% , 0kPa~20kPa (at760mmHg)</p> <p>b) MASIMO CO₂ The range is 0mmHg~190mmHg, 0 vol %~25 vol % (at760mmHg);</p> <p>c) COMEN CO₂ The range is 0mmHg~150mmHg, 0%~19.7%, 0kPa~20kPa (at760mmHg);</p>
CO ₂ resolution	1mmHg, 0.1kPa or 0.1%
Sampling flow velocity	50±10 ml/min
Data sampling rate	20Hz/channel
Total system response time	<p>Masimo sidestream CO₂: < 3s Respironics LoFlo and CapnoTrak sidestream CO₂: Less than 3 seconds (with dehumidification and extension tubing). Comen sidestream CO₂: Less than 3 seconds (with dehumidification and extension tubing). Masimo IRMA mainstream: <1s Respironics CAPNOSTAT 5 and COMEN CO₂: < 1s</p>
10% to 90% Rise time	<p>Masimo sidestream CO₂: Typical rise time at 50 ml/min sample flow: ≤200ms Respironics LoFlo and CapnoTrak sidestream CO₂: Less than 410 ms (with dehumidification and extension tubing) Comen sidestream CO₂: Less than 410 ms (with dehumidification and extension tubing)</p>
ETCO ₂ Calculation	<p>Masimo IRMA: The highest concentration of CO₂ during one breathing cycle with a weight function applied to favor values closer to the end of the cycle. (Measured at I/E ratio 1:1 using breath simulator according to EN ISO 80601-2-55 fig. 201.101.) Masimo sidestream: The highest concentration of CO₂ during one breathing cycle with a weight function applied to favor values closer to the end of the cycle. (Measured according to EN ISO 80601-2-55.) Respironics LoFlo and Comen sidestream: Method: Peak of the expired CO₂ waveform Selections: 1 breath, 10 second, 20 second Respironics CAPNOSTA and Comen mainstream: Method: Peak of the expired CO₂ waveform Selections: 1 breath, 10 second, 20 second Note: the minimum reported differential value between the baseline and the CO₂ value shall be 5 mmHg. Respironics Capno: Range: 0, 5 to 99 mmHg</p>

	<p>Method: Peak of the expired CO2 waveform over selected time period. Minimum of 5 mmHg between peak and valley of waveform required. Time Period Selections: 10 second, 20 second</p>
ETCO2 Accuracy	<p>Masimo IRMA: ETCO2 will be within specification for all respiratory rates up to 150 bpm Masimo sidestream: EtCO2 will typically decrease below nominal value (ETnom) when respiration rate (RR) exceeds the RR threshold (RRth) according to the following formula:</p> $Et = Et_{nom} \times \sqrt{95/RR} \text{ for } RR > 95$ <p>Respironics LoFlo and Comen sidestream: Above 80 breath per minute ±12% of reading NOTE: Gas temperature at 25 °C. Respironics Capno: Range: 0, 5 to 99 mmHg 0 to 40 Breaths per Minute: +0.5 mmHg, -2 mmHg 41 to 70 Breaths per Minute: +0.5 mmHg, -6% 71 to 100 Breaths per Minute: +0.5 mmHg, -14% NOTES: (1) Accuracy is based upon the following conditions: Gas mixtures of CO2, balance N2, Dry gas at 760 mmHg at 25 °C. (2) Additional error is defined as the deviation from the CO2 value at 0 br/m. (3) Accuracy will be measured using the sampling inlet tube, front panel connector, water filter assembly and large airway adapter at 50 ml/minute flow rate. (4) Maximum additional error is specified at 5% and 10% using an I:E ratio of 1:2. I:E Ratio Effects: I:E ratios <2:1 have no effect on stated EtCO2 accuracy stated above. For I:E ratios >2:1 the EtCO2 accuracy specification is as follows: IE2:1 -7% + -4% for every 10BPM over 40 IE3:1 -7% + -5% for every 10BPM over 30 IE4:1 -12% + -6% for every 10BPM over 30</p>
CO2 Stability	<p>Masimo sidestream: No drift Respironics Capno CO2: Short Term Drift: Drift over 6 hours shall not exceed 0.80 mmHg maximum. Long Term Drift: Accuracy specification will be maintained over a 120 hour period. Respironics LoFlo and Comen sidestream CO2: Short Term Drift: Drift over four hours shall not exceed 0.8 mmHg maximum. Long Term Drift: Accuracy specification will be maintained over a 120 hour period. Masimo IRMA mainstream: No drift Respironics CAPNOSTAT 5 and COMEN CO2: Short Term Drift: Drift over four hours shall not exceed 0.8 mmHg maximum; Long Term Drift: Accuracy specification will be maintained over a 120 hour period.</p>
Warm-up time	<p>Masimo sidestream: <10s (Concentrations reported and full accuracy)</p>

	<p>Respironics LoFlo and Comen sidestream CO₂: Capnogram displayed in less than 20 seconds, At an ambient temperature of 25 °C, full specifications within 2 minutes.</p> <p>Respironics Capno CO₂: Capnogram available in less than 10 seconds. Full accuracy specifications within 3 minutes at an ambient temperature of 25 °C.</p> <p>Masimo IRMA mainstream: < 10 seconds (full accuracy)</p> <p>Respironics CAPNOSTAT 5 and COMEN CO₂: Capnogram displayed in less than 15 seconds, at an ambient temperature of 25 °C, full specifications within 2 minutes</p>
CO ₂ accuracy	<p>a) Respironics</p> <p>LoFlo CO₂:</p> <ol style="list-style-type: none"> 1) 0mmHg~40mmHg: ±2mmHg; 2) 41mmHg~70mmHg: ±5% ×reading; 3) 71mmHg~100mmHg: ±8% ×reading; 4) 101mmHg~150mmHg: ±10% ×reading。 <p>CapnoTrak CO₂:</p> <ol style="list-style-type: none"> 1) 0mmHg~38mmHg: ±2mmHg; 2) 38.01mmHg~99mmHg: ±10% ×actual <p>CAPNOSTAT CO₂: (NOTE: Gas temperature at 35 °C)</p> <ol style="list-style-type: none"> 1) 0mmHg~40mmHg: ±2mmHg; 2) 41mmHg~70mmHg: ±5% ×reading; 3) 71mmHg~100mmHg: ±8% ×reading; 4) 101mmHg~150mmHg: ±10% ×reading。 <p>b) MASIMO CO₂</p> <p>(The following accuracy specifications are valid for dry single gases at 22°C ±5°C and 1013±40hPa) :</p> <ol style="list-style-type: none"> 1) 0 mmHg ~ 114 mmHg : ± (1.52mmHg+2% ×reading) 。 2) 114 mmHg ~ 190 mmHg unspecified。 <p>CO₂ accuracy (All environment) :</p> <ol style="list-style-type: none"> 1) 0 mmHg ~ 114 mmHg: ± (2.25mmHg +reading×4%) 。 2) 114 mmHg ~ 190 mmHg unspecified。 <p>c) COMEN CO₂</p> <ol style="list-style-type: none"> 1) 0mmHg~40mmHg: ±2mmHg; 2) 41mmHg~70mmHg: ±5% ×reading; 3) 71mmHg~100mmHg: ±8% ×reading; 4) 101mmHg~150mmHg: ±10% ×reading。
awRR measurement range and accuracy	<p>a) Respironics CO₂</p> <p>LoFlo CO₂:</p> <ol style="list-style-type: none"> 1) measurement range: 2rpm~150rpm; 2) measurement accuracy: ±1rpm。 <p>CapnoTrak CO₂:</p> <p>awRR measurement range: 0rpm, 2rpm~100rpm</p>

	awRR measurement accuracy: ± 1 rpm CAPNOSTAT CO ₂ : awRR measurement range: 0rpm~150rpm awRR measurement accuracy: ± 1 rpm
	b) MASIMO CO ₂ 1) measurement range: 0rpm~150rpm; 2) measurement accuracy ± 1 rpm.
	c) COMEN CO ₂ 1) measurement range: 0rpm~150rpm; 2) measurement accuracy: ± 1 rpm.
alarm limit range	a) Respironics and COMEN CO ₂ Shall be 0 mmHg~150mmHg high limit: (low limit +2mmHg)~150mmHg, low limit: 0mmHg~(high limit -2mmHg) AWRR high limit: (low limit +2rpm) ~150rpm, low limit: 0rpm~ (high limit -2rpm) inCO ₂ high limit: (low limit +1mmHg) ~76mmHg, low limit: 0mmHg
	b) MASIMO CO ₂ Shall be 0 mmHg~190mmHg high limit: (low limit +2mmHg)~190mmHg, low limit : 0mmHg~(high limit -2mmHg) AWRR high limit: (low limit +2rpm)~150rpm, low limit: 0rpm~(high limit -2rpm) inCo ₂ high limit : (low limit +1mmHg)~99mmHg,low limit: 0mmHg
measurement accuracy	± 0.1 kPa or ± 1 mmHg

2.16 Alarm System

Item	Specification
	The alarm system complies with IEC 60601-1-8.

Appendix III Cardiac Rhythm Recognition Test

According to the requirements of the standard IEC60601-2-4 and AAMI DF80, the algorithm evaluation indicators mainly include sensitivity and specificity. The calculation is as follows:

$$Sensitivity = \frac{A}{A + C}$$

$$Specificity = \frac{D}{B + D}$$

Where: A - true positive, B - false positive, C - false negative, D - true negative

The number of evaluation samples and indicator requirements are shown in the following table:

Rhythm	Minimum test sample	Result
Shockable		
Coarse VF, Fine VF	250	>90% sensitivity
Shockable VT	50	>75% sensitivity
Nonshockable 300 total		
NSR	100(arbitrary)	>99% specificity
AF, SB, SVT, heart block, idioventricular, PVCs, etc.	30(arbitrary)	>95% specificity
Asystole	100(for safety)	>95% specificity
Unshockable VT	25	Report only

Refer to the AHA recommendations: Automatic External Defibrillators for Public Access Defibrillation: Recommendations for Specifying and Reporting Arrhythmia Analysis Algorithm Performance, Incorporating New Waveforms, and Enhancing Safety) ;

ECG test database

The database used for evaluation mainly includes:

- MIT-BIT Malignant Ventricular Arrhythmia Database (VFDB)。
- The American Heart Association Electrocardiographic Database (AHAADB) (ANSI/AAMI EC57 standard requirements).
- MIT-BIT arrhythmia Database (MITDB)(ANSI/AAMI EC57 standard requirements).
- Creighton University Ventricular Tachyarrhythmia Database (CUDB) (ANSI/AAMI EC57 standard requirements).

The three results of the sample test are evaluated as the criteria for eligibility. See the following table for details:

Test conclusion				
Rhythm	Minimum test sample	Actual test sample	Result	Standard
Coarse VF, Fine VF	250	300	93.6%	>90%

Cardiac Rhythm Recognition Test

Shockable VT	50	80	90.8%	>75%
NSR	100	500	100%	>99%
AF, SB, SVT, heart block, idioventricular, PVCs, etc.	30	50	100%	>95%
Asystole	100	110	100%	>95%
Unshockable VT	25	50	94.6%	Report

Appendix IV System Alarm Information

Some of the most important physiological and technical alarm messages are listed in this section, and some of the alarm information may not be listed.

The corresponding countermeasures are listed for the alarm information. After following the countermeasures, if the problem persists, please contact your service representative.

Among which, technical alarm category classification: A means that it can be completely cleared, B means that the sound and light can be cleared, and C means that it cannot be cleared.

And the level of technical alarms is not adjustable after leaving the factory (except ECG and SpO₂).

(1) Physiological alarm

Source	Default level	Adjustable level	Cause	Countermeasures
ECG				
XX too high	Medium-level	High-level, medium-level, and low-level	The value of the measured parameter is above the upper alarm limit or below the lower alarm limit.	Check the patient's physiological condition, and confirm if the patient type and alarm limit settings are appropriate for the patient.
XX too low	Medium-level	High-level, medium-level, and low-level		
Among which, XX stands for ST, ST-I, ST-II, ST-III, ST-aVR, ST-aVL, ST-aVF, ST-V.				
HR too high	Medium-level	High-level, and medium-level		
HR too low	Medium-level	High-level, and medium-level		
PVCs too high	Medium-level	High-level, medium-level, and low-level		
PVCs too low	Medium-level	High-level, medium-level, and low-level		
ECG Lost	Low-level	Low-level	The patient's ECG Lost for the system to analyze.	Check the patient's condition, electrodes, cables and lead wires.
ECG Noise	Low-level	Low-level	The patient has arrhythmia.	Check the patient's condition, electrodes, cables and lead wires.
Heart Pause	Medium-level	High-level, and medium-level		
Vent.Rhythm	Medium-level	High-level, and medium-level		
Asystole	High-level	High-level		

System Alarm Information

Source	Default level	Adjustable level	Cause	Countermeasures
Vfib/Vtac	High-level	High-level		
Vent. Brady	High-level	High-level		
Pause/min	Medium-level	High-level, and medium-level		
R ON T	Medium-level	High-level, and medium-level		
VT>2	Medium-level	High-level, and medium-level		
Couplet	Medium-level	High-level, and medium-level		
PVC	Medium-level	High-level, and medium-level		
Bigeminy	Medium-level	High-level, and medium-level		
Trigeminy	Medium-level	High-level, and medium-level		
SVT	Medium-level	High-level, and medium-level		
Tachy	Medium-level	High-level, and medium-level		
Pacer Not Capture	Medium-level	High-level, and medium-level		
Pacer Not Pacing	Medium-level	High-level, and medium-level		
Bradycardia Threshold	Medium-level	High-level, and medium-level		
Missed Beat	Medium-level	High-level, and medium-level		
ARR	Medium-level	High-level, and medium-level		
Noise signal	Medium-level	High-level, and medium-level		
Signal amplitude is too small	Medium-level	High-level, and medium-level		
SVT	Medium-level	High-level, and medium-level		
Extreme Tachy	High-level	High-level		
Extreme Brady	High-level	High-level		
SpO ₂				
SpO ₂ too high	High-level	High-level, and	The value of	Check the patient's

System Alarm Information

Source	Default level	Adjustable level	Cause	Countermeasures
		medium-level	the measured parameter is above the upper alarm limit or below the lower alarm limit.	physiological condition, and confirm if the patient type and alarm limit settings are appropriate for the patient.
SpO ₂ too low	High-level	High-level, and medium-level		
PR too high	High-level	High-level, medium-level, and low-level		
PR too low	High-level	High-level, medium-level, and low-level		
No Pulse	High-level	High-level	The patient's pulse signal is too weak for the system to analyze.	Check the patient's condition, SpO ₂ sensor and measurement site.
NIBP				
SYS/MAP/DIA too high	Medium-level	High-level, and medium-level	The value of the measured parameter is above the upper alarm limit or below the lower alarm limit.	Check the patient's physiological condition, and confirm if the patient type and alarm limit settings are appropriate for the patient.
SYS/MAP/DIA too low	Medium-level	High-level, and medium-level		
RESP				
RR too high	Medium-level	High-level, medium-level, and low-level	The value of the measured parameter is above the upper alarm limit or below the lower alarm limit.	Check the patient's physiological condition, and confirm if the patient type and alarm limit settings are appropriate for the patient.
RR too low	Medium-level	High-level, medium-level, and low-level		
No Breaths	High-level	High-level	The patient's RESP signal is too weak for the system to analyze.	Check the patient's condition, electrodes, cables and lead wires.
Resp Artifact	High-level	High-level	The patient's heartbeat interfered with the RESP and the RR is not measured	

System Alarm Information

Source	Default level	Adjustable level	Cause	Countermeasures
			correctly.	
CO₂				
CO ₂ too high	Medium-level	Not adjustable	The value of the measured parameter is above the upper alarm limit or below the lower alarm limit.	Check the patient's physiological condition, and confirm if the patient type and alarm limit settings are appropriate for the patient.
CO ₂ too low	Medium-level	Not adjustable		
AwRR too high	Medium-level	High-level, medium-level, and low-level		
AwRR too low	Medium-level	High-level, medium-level, and low-level		
INS too high	Medium-level	High-level, and medium-level		
INS too low	Medium-level	High-level, and medium-level		

(2) Technical alarm

XX stands for: certain module names and physiological parameters in the HR, ST, RR, SpO₂, PR, CO₂ (including AwRR, INS, and Fi), NIBP and other systems.

Source	Alarm information	Alarm level	Alarm level	Cause	Countermeasures
XX	XX Init Err	High	A	Error X occurs during initialization of XX module	Reboot and try again. If the error persists, contact the manufacturer for repair.
	XX Comm Stop	High	C	The XX module cannot communicate with the main system.	
	XX Comm Err	High	A	The XX module cannot communicate normally with the main system.	
XX	XX Alm Lmt Err	Low	C	The alarm limit of the XX parameter is accidentally changed.	Contact the manufacturer for repair.
XX	XX Overrange	Low	C	The measured value of the XX parameter is beyond the measurement range that the system can perform.	
ECG	ECG Lead	Hig	B	The ECG lead wire	Check the connection of

System Alarm Information

Source	Alarm information	Alarm level	Alarm level	Cause	Countermeasures
	Off	h, Medium, Low adjustable		is not connected well.	the ECG lead wire.
	ECG YY Lead Off (YY stands for: V, LL, LA, RA, V)	High, Medium, Low adjustable	B	The ECG YY lead wire is not connected well.	Check the connection of the YY lead wire.
	ECG Noise	Low	A	Large interference signals appear in the ECG signal.	Check the connection of the ECG lead wire, check the current condition of the patient, and whether there is a big action.
SpO ₂	SpO ₂ Finger Off	High, Medium, Low adjustable	B	The SpO ₂ sensor has been removed from the finger.	Check the connection of the SpO ₂ sensor.
	SpO ₂ No Sensor	Low	B	The SpO ₂ sensor is not connected well.	
	SpO ₂ Low Signal	Low	C		
	NELLC failure, resetting	Low	C	NELLCOR module error, system reset	If the fault still exists after the system fails to reset or restart the monitor, please contact the manufacturer for repair.
	Search Pulse	Low	B	The SpO ₂ sensor is not connected well or the patient's arm is moving.	Check the connection of the SpO ₂ sensor and the current condition of the patient.
	SpO ₂ Over range	Low	C	The measured value is beyond the claimed measuring range.	Please follow the manufacturer's stated range for measurement.
	SpO ₂ Low Perfusion (masimo)	Low	C	The peripheral circulation is not smooth	Replace other fingers, or detect the presence or absence of limb compression resulting in poor peripheral circulation.

System Alarm Information

Source	Alarm information	Alarm level	Alarm level	Cause	Countermeasures
	SpO ₂ Sensor Fault (masimo)	Low	C	Sensor failure	Check and replace the sensor. If the fault persists, contact the manufacturer for repair.
	SpO ₂ Interference (masimo)	Low	C	External interference is too strong	Check the connection of the SpO ₂ lead wire, check the current condition of the patient, and whether there is a big action.
	Too Much Light (masimo)	Low	C	The patient (sensor) receives too much light. Improper fabric covers the sensor detector.	Check that the SpO ₂ probe is clamped, remove or reduce the light, cover the sensor from light, and reposition the sensor.
	SpO ₂ Unknown Sensor (masimo)	Low	C	The SpO ₂ module cannot recognize the probe.	Check and replace the probe. If the fault persists, contact the manufacturer for repair.
	SpO ₂ No Cable (masimo)	Low	B	The cable is not connected or not connected well.	Check and replace the cable. If the fault persists, contact the manufacturer for repair.
	SpO ₂ No Adhesive Sensor (masimo)	Low	C	The SpO ₂ module cannot recognize the probe.	Check and replace the probe. If the fault persists, contact the manufacturer for repair.
	SpO ₂ Module Error (masimo)	Low	C	Module failure	Return to the manufacturer for repair.
NIBP	NIBP Selftest Err.	High	A	NIBP initialization error	Select the reset function in the NIBP menu. If the error persists, please contact the manufacturer for repair.
	NIBP Comm Error	High	A	NIBP communication part has a problem.	
	Loose Cuff	Low	A	NIBP cuff is not connected well.	Please reconnect the NIBP cuff.
	Pneumatic Leak	Low	A	There is gas leakage at the NIBP gas circuit.	Check the connection of each part or update a cuff. If the fault persists, please contact the manufacturer for repair.
	Pressure Overage	Low	A	A problem occurs during the measurement of	

System Alarm Information

Source	Alarm information	Alarm level	Alarm level	Cause	Countermeasures
				curves, and the system is unable to conduct measurement analysis and calculation.	
	Air Leak	Low	A	NIBP cuff is not connected well, or there is gas leakage at the gas circuit.	
	Air Pressure Error	Low	A	A problem occurs during the measurement of curves, and the system is unable to conduct measurement analysis and calculation.	
	Weak Signal	Low	A	A problem occurs during the measurement of curves, and the system is unable to conduct measurement analysis and calculation.	Check if the patient type setting is correct, and check the connection of each part or update a cuff. If the fault persists, please contact the manufacturer for repair.
	Cuff Type Error	Low	A	It may be that the cuff used does not match the type of patient being set.	
	Excessive Motion	Low	A	The patient's arm moves.	
	Signal Saturated	Low	A	A problem occurs during the measurement of curves, and the system is unable to conduct measurement analysis and calculation.	Check the connection of each part, and the patient's condition, and measure again. If the fault persists, please contact the manufacturer for repair.
	NIBP System Failure	High	A		
	NIBP Measure Timeout	Low	A		
	NIBP Measure Failed	Low	A		

System Alarm Information

Source	Alarm information	Alarm level	Alarm level	Cause	Countermeasures
	Over Pressure	Low	A	Gas circuit may be folded.	Check if the gas circuit is clear and the patient's condition, and measure again. If the fault persists, please contact the manufacturer for repair.
	NIBP Reset Error	Low	A	An illegal reset occurs during NIBP measurements.	Check the NIBP's gas circuit to see if there is any blockage before taking measurements. If the error persists, please contact the manufacturer for repair.
CO ₂	CO ₂ is sleeping	Low		The CO ₂ operating mode is on standby.	Select the CO ₂ operating mode as the measurement mode.
	CO ₂ Sampling Line Clogged	Low	B	The sampling tube is blocked.	Check and replace the sampling tube. If the fault persists, contact the manufacturer for repair.
	CO ₂ No Sample Line (Masimo)	Low	B	The sampling tube is not connected or has poor contact.	
	CO ₂ Out Of Accuracy Range	Low	C	The measured value is beyond the claimed accuracy range.	Please follow the manufacturer's stated accuracy range for measurement.
	CO ₂ internal temperature is beyond the range.	Low	C	Module failure	Return to the manufacturer for repair.
	CO ₂ Span Cal Error (Masimo)	Low	C		
	Factory Calibration Lost (Masimo)	Low	C		
	Speed Out Of Bounds (Masimo)	Low	C		
	Pressure Overrange (Masimo)	Low	C		
	CO ₂ Span	Low	C	CO ₂ range is	Return to the

System Alarm Information

Source	Alarm information	Alarm level	Alarm level	Cause	Countermeasures
	Calibrating... (Masimo)			calibrating	manufacturer
	Replace Adapter (Masimo)	Low	C	Adapter exception	Check and replace the adapter. If the fault persists, contact the manufacturer for repair.
	No Adapter (Masimo)	Low	C	The adapter is not connected or has poor contact.	
	Need Zero (Masimo)	Low	C	CO ₂ needs to be zeroed.	Enter the CO ₂ setting to return to zero. Returning zero here is equal to zero calibration.
	Software Error (Masimo)	Low	C	Software error	Reboot.
	Hardware Error (Masimo)	Low	C	Hardware error	Check and replace the sensor. If the fault persists, contact the manufacturer for repair.
Battery	Low Battery	High	A	Battery is low.	Please charge the battery in time.
	Battery Aging	Low	C	Battery aging	Please replace the battery. Restart the instrument. If the fault persists, please contact the manufacturer for repair.
	Battery Fault	High	C	The battery has failed.	Check the battery for compatibility, damage, or battery replacement. Restart the instrument. If the fault persists, please contact the manufacturer for repair.
	No Battery	Low	A	Batteries is not installed.	Please install the battery.
	Battery Charge Fault	Medium	C	Battery failure or power board charging circuit failure	Please replace the battery. If the problem persists, please contact the maintenance personnel.
Treatment	Paddle Over	Low	A	The input signal is	Reconnect the lead wires

System Alarm Information

Source	Alarm information	Alarm level	Alarm level	Cause	Countermeasures
module	Load			out of the measurement range.	or electrode pads; or treat the patient's skin.
	Pad Over Load	Low	A	The input signal is out of the measurement range.	Reconnect the lead wires or electrode pads; or treat the patient's skin.
	Pad/Plate Off	Low	A	Electrode pad or electrode plate detachment	Reconnect the lead wires or electrode pads; or treat the patient's skin.
	Last self-test has failed.	Low	C	Self-test items failed in the last self-test.	Perform self-test again.
	Defib Comm Stop	High	C	Defibrillation function malfunctions	Restart the instrument. If the fault persists, please contact the manufacturer for repair.
	Defib Comm Err	High	C	Defibrillation function malfunctions	Restart the instrument. If the fault persists, please contact the manufacturer for repair.
	Defib Fault	High	C	Defibrillation function malfunctions.	Restart the instrument. If the fault persists, please contact the manufacturer for repair.
	Pace Fault	High	C	Pacing function malfunctions.	Restart the instrument. If the fault persists, please contact the manufacturer for repair.
	Pace Unlrmal Stop	High	A	Pacing failure	Re-pacing
	Defib/Pace Malfunction	High	C	Fault code, defibrillation malfunction or simultaneous defibrillation malfunction and pacing malfunction.	Restart the instrument. If the fault persists, please contact the manufacturer for repair.

System Alarm Information

Source	Alarm information	Alarm level	Alarm level	Cause	Countermeasures
	Failed Energy Released	High	C	Fault code, the treatment board self-discharge circuit is abnormal.	Replace the low-pressure board and the high-pressure board. Restart the instrument. If the fault persists, please contact the manufacturer for repair.
	ECG Lost	Low	C	Fault code	None
	Last self-test has failed.	Low	C	Power-on self-test is abnormal.	Restart the instrument. If the exception persists, please contact the manufacturer for repair.
	Power Voltage Abnormal	Low	C	Fault code	Restart the instrument. If the fault persists, please contact the manufacturer for repair.
	Power Board RTC Error	Low	C	Fault code	Restart the instrument. If the fault persists, please contact the manufacturer for repair.
	Internal Temp Too High	Low	C	Fault code	Restart the instrument. If the fault persists, please contact the manufacturer for repair.
	Power Board Comm Stop	High	C	Fault code, power board failure or unit communication failure	Restart the instrument. If the fault persists, please contact the manufacturer for repair.
	Key Board Comm Stop	High	C	Fault code, button board failure or unit communication failure	Restart the instrument. If the fault persists, please contact the manufacturer for repair.
Recorder	No Record Paper	Low	A	The printer is out of paper.	Please load new printing paper.
	Recorder Comm Error	Low	C	Recorder has a communication error.	Check if the recorder is installed correctly or replace the recorder.
	Recorder Head Hot	Low	A	Recorder works for a long time.	Record after cooling. Output

System Alarm Information

Source	Alarm information	Alarm level	Alarm level	Cause	Countermeasures
Others	No SD card exist!	Low	A	No SD card installed	Install SD card.
	SD Storage Full	Low	A	Storage is full.	Empty or reduce storage.

(3) Prompt information

SOURCE	ALARM INFORMATION	ALARM LEVEL	CAUSE	
NIBP	Manual Measuring...	None	The system prompts only the monitor to prompt for a function or an action that is being operated.	
	Calibrating...	None		
	Leakage Test...	None		
	Resetting...	None		
	Continual measuring...	None		
	Please Start	None		
	Reset For Error	None		
	Auto Measuring...	None		
	Leakage Test Stopped	None		
	Measure Stopped	None		
	Over Pressure	None		
	Reset Failed	None		
	Venipuncture Start	None		
	Venipuncture Stop	None		
CO ₂ zero calibration	Zeroing	None	The system prompts only the monitor to prompt for a function or an action that is being operated.	
	CO ₂ Zeroing	None		
	CO ₂ Zero Succeeded	None		
	CO ₂ Zero Failed	None		
ECG	ECG Calibrating	None		The system prompts only the monitor to prompt for a function or an action that is being operated.
Alarm prohibition prompt information	ECG Alarm Disabled!	None		
	Cal...can't monitor!	High		
	Resp Alarm Disabled!	None		
	SpO ₂ Alarm Disabled!	None		
	NIBP Alarm Disabled!	None		
	CO ₂ Alarm Disabled!	None		
	Defib Alm Disabled	None		
	Ip conflict	None		
	Import Succeeded	None		

System Alarm Information

SOURCE	ALARM INFORMATION	ALARM LEVEL	CAUSE
	Import Failed	None	
	Config Load Success	None	
	Config Load Failed	None	
	Delete Config Succeeded	None	
	Delete Config Failed	None	
	Sampling	None	
	Relearn	None	
	Arr Learning	None	
	The same module exists, only one can be kept!	None	
	User Test Due	None	
	Formatting SD Card	None	
	Cannot format SD card	None	
	Format SD Card Succeeded	None	
	Rebuilding Index...	None	
	CMS Connected	None	
	CMS Disconnected	None	
	U-disk Connected	None	
	U-disk Disconnected	None	
	Cal...can't monitor!	None	
	Recording ...	None	
	Recorder Comm Error	None	

Appendix V Factory default configuration

(1) General settings

Configuration item	Default value	Remark
Pat Type	Adu	/
Date Format	YYYY-MM-DD	/
Time format	12h	/
Brightness	2	/
Key Vol	5	/

(2) Manual defibrillation settings

Configuration item	Default value	Remark
External defibrillation energy default value	200J	/
Auto Disarm Time	60s	/
Sync Keep	No	/
Remote Sync Input	ON	/
Battery Charge Vol	Medium	/
Contact impedance indication	OFF	/

(3) AED settings

Configuration item	Default value	Remark
Serial Shock Times	1	/
First Shock Energy	200J	≤ second
Second Shock Energy	300J	≥ first, and ≤ third.
Third Shock Energy	360J	≥ second
Auto Disarm Time	30s	/
Pre-Shock CPR Time	OFF	/
CPR Time	120s	/
CPR Metronome	ON	/
CPR mode	30:2	/
NSA Process Mode	CPR	/
Voice Prompt	ON	/
Voice Volume	High	/
Voice Interval	30s	/
Audio Recording	OFF	/

(4) Pacing settings

Configuration item	Default value	Remark
Pace Rate	70ppm	/
Pace Elec	30mA	/
Pace Mode	On-demand pacing	/

(5) Event tag settings

Configuration item	Default value	Remark
Event Save Wave1	II	/
Event Save Wave2	I	/
Event Save Wave3	PLETH	/
EVENT A	SIMPLE	/
EVENT B	LIDOCAINE	/
EVENT C	ATROPINE	/
EVENT D	NITROGLYCERIN	/
EVENT E	MORPHINE	/
EVENT F	CANNULA	/
EVENT G	VENOUS TRANSFUSION	/
EVENT H	ADENOSINE	/

(6) Record settings

Configuration item	Default value	Remark
Actual Charge Energy	OFF	/
Grid	OFF	/
Charge Event	OFF	/
Electric shock event	OFF	/
User Event	OFF	/
Auto Check Report	OFF	/
RT Record Time	8s	/
Record output speed	25 mm/s	/

(7) Alarm settings

Configuration item	Default value	Remark
Alm Vol	2	/
Alm Rec Time	8s	/

Factory default configuration

Alm Pause Time	2min	/
Alarm delay time	Not Allowed	/
Min. Alm Volume	2	/
Alarm mute prompt	OFF	/
Reminder Interval	1min	/
Reminder Volume	1	/

(8) Network settings

Configuration item	Default value	Remark
Net Bed	1	User settings
Local IP	200.200.200.10	/
Subnet Mask	255.255.255.0	/
Service IP	200.200.200.100	/

(9) Detection settings

Configuration item	Default value	Remark
User Test Prompt	OFF	/
Auto Test Time	3:00	/

(10) Event settings

Name	General	OR	ICU	NICU	CCU
Waveform 1	I				
Waveform 2	II				
Waveform 3	PLETH				

(11) Module Color

Name	General	OR	ICU	NICU	CCU
Waveform/parameter color	ECG	Green			
	SpO ₂	Cyan			
	RESP	Yellow			
	NIBP	White			
	CO ₂	Yellow			

(12) ECG settings

Name	General	OR	ICU	NICU	CCU
Cascade switch	OFF				
Lead name	II				
Gain	X1				

Factory default configuration

Sweep	25 mm/s			
Filter Mode	Monitor			
Lead Type	5-lead			
Calculate Lead	II			
HR Source	ECG			
Alarm switch	ON			
Alm Record	OFF			
Alm Level	Medium			
Power frequency suppression	ON (50HZ)			
Smart Lead Off	OFF			
HR alarm limit		Adu	Ped	Neo
	Upper limit	120	160	200
	Lower limit	50	75	100

(13) RESP settings

Configuration item	Default value				Remark
Alm Level	Medium				
Alm Record	OFF				
Display color	Yellow				
Lead	II				
Waveform speed	12.5mm/s				
Gain	X1				
Apnea	20s				
Enhance Filter	OFF				
RESP alarm limit		Adu	Ped	Neo	
	Upper limit	30	30	100	
	Lower limit	8	8	30	

(14) ST default settings

Name	General	OR	ICU	NICU	CCU
ST Analysis	OFF				
Alarm switch	OFF				
Alm Level	Medium				
Alm Record	OFF				
Limit	(-0.20, 0.20)				

(15) Arrhythmia default settings

Name	General	OR	ICU	NICU	CCU
Arrhythmia analysis switch	OFF				
TACHY threshold	ADU	120			
	PED	160			
	NEO				
Extreme tachycardia threshold	ADU	160			
	PED	180			
	NEO	200			
Brady	ADU	40			
	PED				
	NEO				
Extreme bradycardia threshold	ADU	40			
	PED	40			
	NEO				
Arrhythmia alarm switch	All OFF				
Arrhythmia alarm record	All OFF				
Arrhythmia alarm level	The alarm level of ASY, VT, VF, extreme tachycardia, and extreme bradycardia are high-level alarms, while the others are medium-level alarms.				

(16) RESP settings

Name	General	OR	ICU	NICU	CCU
Gain	X1				
Enhance Filter	ON				
Sweep	12.5 mm/s				
Apnea alarm	20s				
Resp Lead	RA-LL(II)				
Alarm switch	ON				
Alm Level	Medium				
Alm Record	OFF				
Limit	ADU	(8 --- 30)			
	PED				
	NEO	(30--- 100)			

(17) SpO₂ settings

Name	General	OR	ICU	NICU	CCU
Sweep	25 mm/s				
Sat-Second(Nellcor)	50s				
Fast Sat	OFF				
Average Time (Masimo)	8s				
Smart Tone	ON				

Factory default configuration

Sensitivity (Masimo)		APOD
Signal IQ		ON
Alarm switch		ON
Alm Record		OFF
Alm Level (Nellcor)		High
SpO ₂ alarm limit (Nellcor)	ADU	(90 --- 100)
	PED	
	NEO	
SpO ₂ alarm limit (Masimo and Digital SpO ₂)	ADU	(85 --- 100)
	PED	
	NEO	

(18) PR settings

Name	General	OR	ICU	NICU	CCU
Alarm switch	ON				
Alm Record	OFF				
PR source	SpO ₂				
Alm Level	High				
PR alarm limit		Adults	Children	Newborns	
	Upper limit	120	160	200	
	Lower limit	50	75	100	

(19) NIBP settings

Name	General	OR	ICU	NICU	CCU
Pat Type	Adu				
Measure Mode	Manual				
Interval	1min				
Initial Pressure	ADU	160			
	PED	120			
	NEO	100			
Alarm switch	ON				
Alm Record	OFF				
Alm Level	Medium				
NIBP alarm limit			Adults	Children	Newborns
	SYS	Upper limit	160	120	90
		Lower limit	90	70	40
	MAP	Upper limit	110	90	70
		Lower limit	60	50	25
	DIA	Upper limit	90	70	60
Lower limit		50	40	20	

(20) CO₂ settings

Name	General	OR	ICU	NICU	CCU
Gain	X1				
Sweep	6.25 mm/s				
Work Mode	Measurement				
O ₂ Compensate (Respironics)	16				
O ₂ Compensate (Masimo)	High				
Balance Gas (National Medical, and Bicom)	Room Air				
Altitude Unit	m				
Altitude (National Medical, and Bicom)	0.0 m				
Baro. Pressure	760mmHg				
N ₂ O compensation switch (Masimo)	OFF				
No Breaths Timeout	20s				
Alarm switch	ON				
Alm Record	OFF				
CO ₂ alarm limit			Adults	Children	Newborns
	CO ₂	Upper limit	50	50	45
		Lower limit	25	25	30
	INS	Upper limit	4	4	4
		Lower limit	0	0	0
	AWRR	Upper limit	30	30	100
Lower limit		8	8	30	

(21) User Maintenance Settings

Name	General	OR	ICU	NICU	CCU
Wave Draw	MONO				
Waveform line	Thin				
Analog Out	OFF				
Alarm settings	Alarm mute prompt	OFF			
	Reminder Interval	1min			
	Alarm tone volume	1			
	Min. Alm Volume	2			
	Alm Pause Time	2min			

Factory default configuration

	Alarm delay time	Not Allowed
--	---------------------	-------------

Appendix VI EMC

Warning

- Use of the S5/S3 adjacent to or stacked with other equipment should be avoided because it could result in improper operation. If such use is necessary, the S5/S3 and the other equipment should be observed to verify that they are operating normally.
- Use of accessories, transducers and cables other than those specified or provided by the manufacturer of the S5/S3 could result in increased electromagnetic emissions or decreased electromagnetic immunity of the S5/S3 and result in improper operation.
- Portable RF communications equipment (including peripherals such as antenna cables and external antennas) should be used no closer than 30 cm (12 inches) to any part of the S5/S3, including cables specified by the manufacturer. Otherwise, degradation of the performance of the S5/S3 could result.

declaration - electromagnetic emission	
Emissions test	Compliance
RF emissions CISPR 11	Group 1
RF emissions CISPR 11	Class B
Harmonic emissions IEC 61000-3-2	Class A
Voltage fluctuations/ flicker emissions IEC 61000-3-3	Clause 5

declaration - electromagnetic immunity		
Immunity test	IEC 60601 test level	Compliance level
Electrostatic discharge (ESD) IEC 61000-4-2	±8 kV contact ±2 kV, ±4 kV, ±8 kV, ±15 kV air	±8 kV contact ±2 kV, ±4 kV, ±8 kV, ±15 kV air
Electrical fast transient/burst IEC 61000-4-4	± 2 kV for power supply lines ± 1 kV for input/output lines	± 2 kV for power supply lines ± 1 kV for input/output lines
Surge IEC 61000-4-5	±0.5kV, ± 1 kV line(s) to lines ± 0.5kV, ± 1 kV, ± 2 kV line(s) to earth	±0.5kV, ± 1 kV line(s) to lines ±0.5kV, ± 1 kV, ± 2 kV line(s) to earth
Voltage dips, short interruptions and voltage	0 % UT; 0.5 cycle At 0 °, 45 °, 90 °, 135 °, 180 °, 225 °, 270 ° and 315 °	0 % UT; 0.5 cycle At 0 °, 45 °, 90 °, 135 °, 180 °, 225 °, 270 ° and 315 ° 0 % UT; 1 cycle and

EMC

variations on power supply input lines IEC 61000-4-11	0 % UT; 1 cycle and 70 % UT; 25/30 cycles Single phase: at 0 ° 0 % UT; 250/300 cycles	70 % UT; 25/30 cycles Single phase: at 0 ° 0 % UT; 250/300 cycles
Power frequency (50/60 Hz) magnetic field IEC 61000-4-8	30 A/m	30 A/m
NOTE: UT is the a.c. mains voltage prior to application of the test level.		

declaration - electromagnetic immunity		
Immunity test	IEC 60601 test level	Compliance level
Conducted RF IEC 61000-4-6	3 V 0.15 MHz to 80 MHz 6 V in ISM bands between 0.15 MHz and 80 MHz	3 V 0.15 MHz to 80 MHz 6 V in ISM bands between 0.15 MHz and 80 MHz
Radiated RF IEC 61000-4-3	3V/m 80 MHz to 2.7 GHz	3V/m

declaration - IMMUNITY to proximity fields from RF wireless communications equipment					
Immunity test	IEC60601 test level				Compliance level
	Test frequency	Modulation	Maximum power	Immunity level	
Radiated RF IEC 61000-4-3	385 MHz	**Pulse Modulation: 18Hz	1.8W	27 V/m	27 V/m
	450 MHz	*FM+ 5Hz deviation: 1kHz sine	2 W	28 V/m	28 V/m
	710 MHz 745 MHz 780 MHz	**Pulse Modulation: 217Hz	0.2 W	9 V/m	9 V/m
	810 MHz 870 MHz 930 MHz	**Pulse Modulation: 18Hz	2 W	28 V/m	28 V/m
	1720 MHz 1845 MHz 1970 MHz	**Pulse Modulation: 217Hz	2 W	28 V/m	28 V/m
	2450 MHz	**Pulse Modulation:	2 W	28 V/m	28 V/m

EMC

		217Hz			
	5240 MHz 5500 MHz 5785 MHz	**Pulse Modulation: 217Hz	0.2 W	9 V/m	9 V/m
<p>Note* - As an alternative to FM modulation, 50 % pulse modulation at 18 Hz may be used because while it does not represent actual modulation, it would be worst case.</p> <p>Note** - The carrier shall be modulated using a 50 % duty cycle square wave signal.</p>					

Appendix VII Defibrillation Monitor Shift Checklist

Please check the defibrillator monitor once a day according to the items in the list below. Check the passed items by typing “√” or “×” in the “pass/fail” column, indicating pass and fail respectively, and filling in “-” for items not involved. If the device is found to be abnormal during the inspection process, please describe it in the “Exception Description” column.

Device name: Serial No.: Department name:

Test item	Description	Pass/Fail	Exception description
Device appearance	Device surface is clean, with no damage, crack and foreign matter		
Battery	Equipped with battery, battery indicator is on, and battery icon shows more than 3 grids		
AC power	Connect AC power, and the AC power indicator lights up		
Recording paper	Recording paper is loaded and the recording paper is sufficient		
Cable and connector	The cable is not damaged, and the plug pin is not loose or bent		
ECG cable and electrode pad (not used is not involved)	The ECG cable and electrode pads are complete, the cable is not damaged, the plug pins are not loose or bent, and the electrode pads are not expired.		
Electrode pad (not used is not involved)	The electrode paddle cable is not damaged, the plug pin is not loose or bent, and the electrode paddle is correctly placed in the electrode paddle slot.		
Treatment cable and electrode pad (not used is not involved)	The treatment cable and electrode pads are complete, the treatment cable is not damaged, the plug pins are not loose or bent, and the electrode pads are not expired.		
Treatment cable shock test* (not used is not involved)	Turn on the unit, select “Manual Defibrillation”, connect the treatment cable and test the load. The charging value is 200J. Press the “Discharge” button to indicate that the electric shock is released normally. Remove the test load after the test is complete.		
Electrode paddle shock test**	Turn on the unit, select "Manual Defibrillation", connect the electrode		

Defibrillation Monitor Shift Checklist

(not used is not involved)	paddle, put the electrode paddle into the slot, charge to 10J, and press the "Discharge" button, prompting the electric shock to release normally.		
Maintenance indicator	Maintenance indicator is not lit		
Tester signature: Date:			

*: This check is required only if the automatic self-test or the automatic self-test fails when the treatment cable is not used.

** : This check is required only if the automatic self-test or the automatic self-test fails when the electrode paddle is not used.



Attention

- **After the test is completed, if the test load is not removed, the patient's treatment may be delayed.**