



PAVING THE WAY.

THE NEW PAVERS IN THE UNIVERSAL AND HIGHWAY CLASS.



MILLIONS OF KILOMETRES BEAR OUR SIGNATURE.

You build the finest roads so we can all make the quickest progress. And to ensure your rapid progress, we build the best machines. As part of the internationally leading FAYAT Group, we offer machines for all areas of road construction: Cold planers, recyclers, asphalt rollers, soil compactors and, of course, pavers.

For over 60 years, the history of our company has been synonymous with the history of road construction. With our accumulated know-how, we set the pace for an entire industry. BOMAG has developed a number of innovations such as ECOMODE, the active engine and hydraulics management system that reduces operating costs, MAGMALIFE, the most

effective screed heating system on the market, and now A-Pave, with new, convenient, and cost-saving assistance systems.

We offer solutions for a wide variety of applications. Our global network of experts and partners in over 120 countries supports you comprehensively, from the configuration of the machines to providing solutions for the most challenging of tasks. And, of course, they also provide an intelligent service concept.

More than 2,200 BOMAG employees worldwide apply their dedication and know-how to achieve something very special: Your success.





HIGHWAY PAVERS
BF 900 and BF 800

UNIVERSAL PAVERS
BF 700 and BF 600

TOP PERFORMERS. ACROSS THE ENTIRE RANGE.

BOMAG offers you a complete “line-up” of pavers. For all requirements. And with a focus on maximum efficiency in every class. This applies as much to the lower fuel consumption as to fast operational readiness and excellent pre-compaction. In the Universal and Highway class, this is also demonstrated by the brand new Advanced Pave operating concept, which increases convenience intelligently and

reduces costs. Developed by engineers who not only know “how road construction works”, but also understand the challenges our customers face today and tomorrow. They develop solutions for this. For your future security. For the good feeling that an investment has really paid off. In this respect, too, we want to be at the “top” of our game.



CITY PAVER
BF 300

MINI PAVER
BF 200

DEVELOPED TO THE MAXIMUM.

WHAT MAKES OUR UNIVERSAL AND HIGHWAY CLASS FIRST CHOICE:

PERFECT ALL-ROUND VIEW

- New swivel seat concept
- Slidable driver's stand with SIDEVIEW function
- All-round weather protection



MAXIMUM DURABILITY

- Sturdy design
- Guaranteed service life
- Intelligent system layout
- Strongly-built wheel or chain drives
- Robust screed construction

HIGH ENERGY EFFICIENCY

- Intelligent engine and hydraulics management
- Optimal performance with reduced fuel consumption
- Lower noise emission



INTUITIVE OPERATING CONCEPT

- Comfortable swivel seat with controls in the armrests
- Ergonomic driver's stand with individual adjustment options
- Full-graphic display for complete transparency and flexibility
- Fully electronic side-mounted control panels
- Clever storage options

HIGH DIGITAL CONNECTIVITY

- Process data in real time
- Open digital interface
- Integration of the paver into the construction site network
- Digital construction site management



FASTEST POSSIBLE HEAT-UP TIMES

- MAGMALIFE innovative screed technology
- Best results right from the start
- Uniform thermal image
- Hard-wearing screed plates for low maintenance costs
- Long-life heating plates



SHORTER SETUP TIMES

- Quick attachment system with sliding couplings
- More flexibility on the construction site
- Lower costs through faster retooling



THE NEW COMFORT COCKPIT.

BETTER VIEW, BETTER WORK.

Comfort on the construction site is defined differently. That's why the new cockpit of our Universal and Highway class pavers is all about the best possible functionality. This is where the latest generation of our machines sets standards. With a clear safety plus thanks to perfect all-

round visibility. As a driver, you are completely in the picture. This improves workflow efficiency and optimises communication with the entire paving crew. Ready for a 360° tour of the cockpit?



3



Excellent visibility to the screed operator on the right. This also improves communication within the team.

4



The screed edge and the material flow are directly in view. This improves the work result.



Direction rod and machine edge are clearly visible. Perfect for precise manoeuvring.

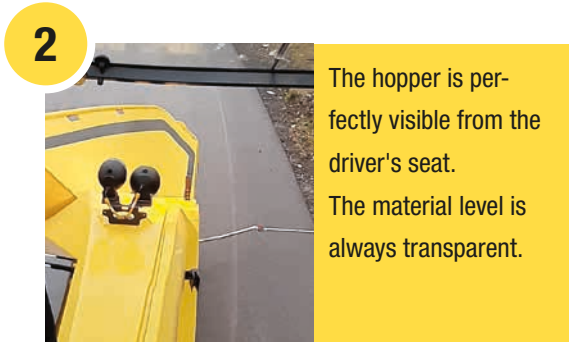

The hopper is perfectly visible from the driver's seat. The material level is always transparent.



Clear and concise: the new side-mounted control panel.

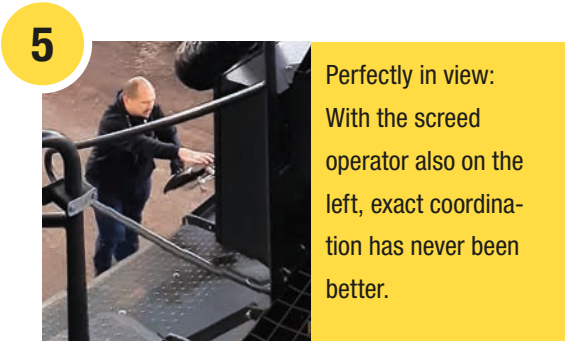

Perfectly in view: With the screed operator also on the left, exact coordination has never been better.

SIDEVIEW.
 The entire operating platform can be moved to the left and right with an overhang of up to 60 cm – thanks to BOMAG's patented SIDEVIEW system, the operator has optimum control.





This enables your drivers to “direct the show” perfectly. The optional multi-function swivel seat gives the driver the exact flexibility required to communicate optimally with the screed operators. This ensures smooth workflows.

THE NEW ERGONOMICS.

COMPLEX WORK COMPLETELY UNDER CONTROL.

Perfect and efficient paving requires the smooth interaction of many factors. The driver's stand on the new Universal and Highway class pavers is designed to do just that. This is particularly due to the optional multi-function swivel seat, where the control units are ideally positioned on the operator's left and right, putting the driver right in the centre of the action. From here, he or she not only has a perfect overview of all important information, but can also

comfortably control every driving and working manoeuvre. All functions can be operated precisely without having to leave the seat. Thanks to the new ergonomics, the operator can now fully concentrate on the paving process itself. Optimal results can thus be achieved more easily and effectively.

1

The new dashboard with full-graphic display is clearly structured for quick access to all information.

2

The control unit for precise and accurate operation of the machine lies perfectly in the hand.

3

The travel joystick is an ergonomically designed control element that also integrates the hopper operation.

4

All important material functions – on the left as well as on the right – can be accessed with a flick of the wrist.

PERFECT ERGONOMICS



Even in standard models, the dashboard presents practical and robust control elements – incorrect operation is impossible. The optimised seat guarantees fatigue-free working.



The dashboard is a highly adaptable information hub. It can be rotated by up to 80° to the left or right and is therefore always optimally positioned in the driver's field of vision.

THE NEW SIDE-MOUNTED CONTROL PANEL.

WORKING OUTSIDE, BUT AT THE HEART OF THE ACTION.

The operator of the side-mounted control panel plays an important role in the paving process team. To ensure the operator can fulfil the task of keeping a close eye on the paving quality, we have developed a new, electronic side-mounted control panel that provides full transparency at all times. Levelling controller, material calculator, assistance and automatic functions provide information on the

most important working modes in each phase. All machine settings, such as crown profile, tamper frequency, vibration and path meter, can be called up at any time as a clear graphical representation. All information displayed is designed to focus on the essentials: producing excellent work for an optimal result.

1

So the operator is always up to date: Automatic profile adjustment for setting the slopes and crown profile over a defined distance.

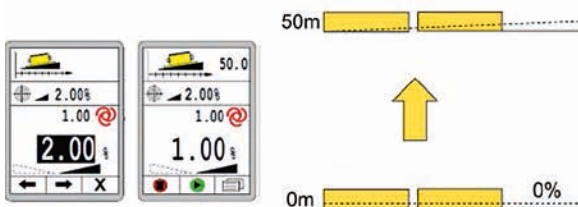

2

An end to hot questions: Thanks to (optional) sensors, the material temperature is always transparent.



3

The material calculator provides information on the quantity of material to be paved or that has already been laid.

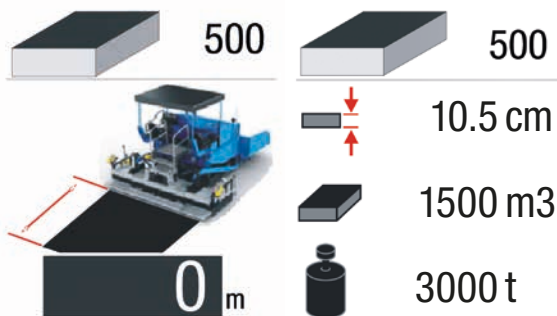

4

Makes hard work easier: The most important functions can be operated intuitively and quickly. Without requiring intensive training.

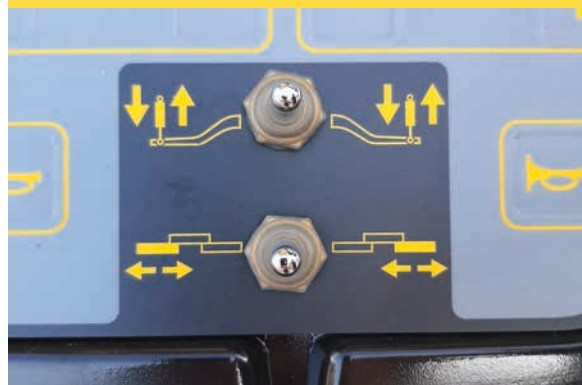



The side-mounted control panel provides exactly the information that is crucial for paving.

THE NEW ASSISTANCE SYSTEMS.

ADVANCED PAVE – GREATER CONVENIENCE MEANS LOWER COSTS.

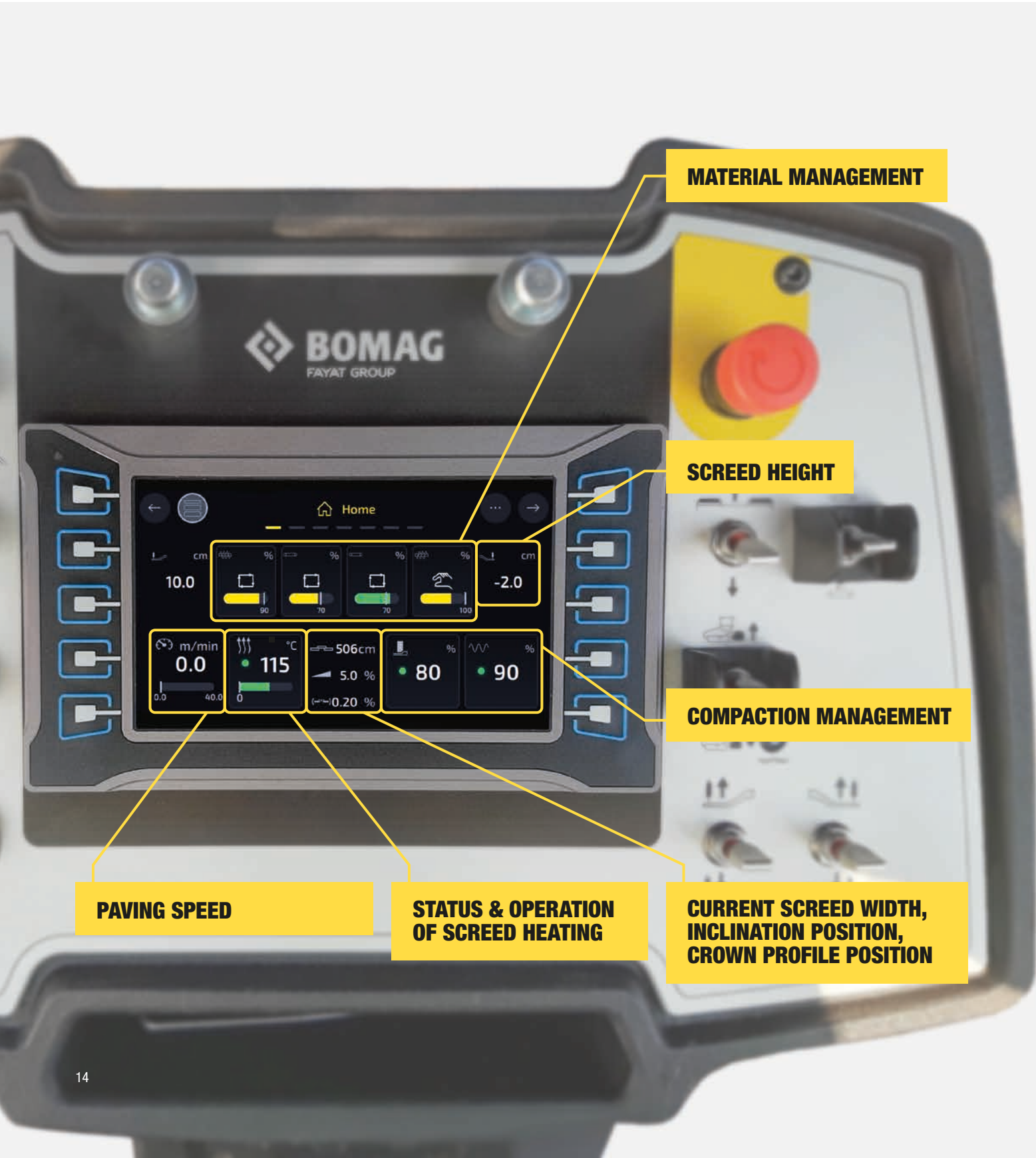

MATERIAL MANAGEMENT

SCREED HEIGHT

COMPACTION MANAGEMENT

PAVING SPEED

STATUS & OPERATION OF SCREED HEATING

CURRENT SCREED WIDTH, INCLINATION POSITION, CROWN PROFILE POSITION

With the latest model generation, new digital assistance systems are also moving into our Universal and Highway class. Advanced Pave is the name of the system that transparently provides the operator with all machine and process-relevant functions at a glance and allows direct access. In addition, Advanced Pave offers the possibility to

“automate” essential paver functions in a simple and convenient manner. This means that pre-programmed settings can either be retrieved up at any time or the operator can personally enter defined settings, save them, and access them as required. The outcome: great results with less effort.



THE A-PAVE SET FUNCTION:

The machine can be switched to transport or working position at the press of a button. All necessary functions such as screed, levelling cylinder, distributor auger, etc. are automatically set to the appropriate position.

As a result, the machine is ready for the next work step in a matter of seconds. Or for the upcoming transport.



THE A-PAVE START FUNCTION:

When starting or interrupting the work process, the screed is automatically relieved, locked and returned to floating position. This guarantees a consistently even and smooth surface during paving.

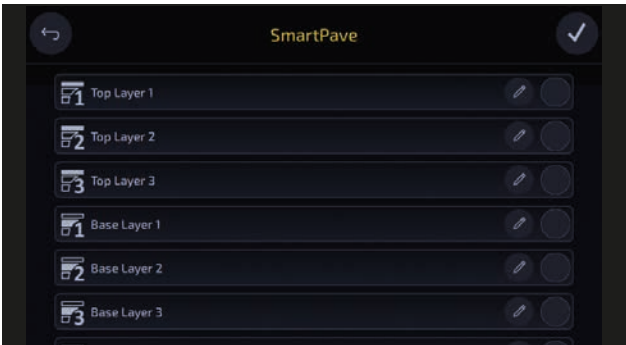

THE A-PAVE SMARTPAVE FUNCTION:

What used to require many steps, now only takes one. The operator selects the desired paving layer and automatically receives the appropriate machine setting: Conveyor belt and auger intensity, screed temperature, and tamper and vibration frequency are thus always perfectly matched to each other. The settings can be individually adjusted and saved.

THE DIGITAL CONSTRUCTION SITE.

KNOW EVERYTHING, PLAN BETTER.

The new Universal and Highway class is ready for the future. A future in which all machines on the construction site are connected, process data is transmitted in real time, and in which you as contractor can achieve a new level of planning security thanks to 100% transparency.

To achieve this comprehensive transparency, BOMAG has combined a whole range of modules into TELEMATIC to provide one integrated solution. It forms the backbone and prerequisite for construction site digitisation.

With JOBLINK the unbeatable potential of BOMAP comes into play. BOMAG machines are equipped with intelligent measuring technology and process sensors. The BOMAG JOBLINK interface collects all process-relevant parameters from measuring systems and the machine and makes them available for further processing, e.g. in BOMAP: E_{VIB} , frequency, amplitude, temperature (on asphalt rollers and pavers), screed width (on pavers), as well as travel speed are just some of the numerous parameters JOBLINK provides to its users. Even machines with ECONOMIZER can provide their compaction information.

A connection to BOMAP is automatically initiated when the machine is started. As soon as the wireless connection via the JOBLINK plug-and-play Bluetooth adapter is established, BOMAP independently takes over the machine configuration. All the measuring data appears in the app automatically – without the need for additional equipment. An additional JOBLINK Dashboard serves as a visual aid. As a consequence, the relevant measured values can be displayed in the driver's field of vision at any time without losing sight of the lane. The final documentation contains all the measuring data sent to BOMAP via JOBLINK. Regardless of whether it concerns soil compaction or asphalt paving, you now have the ability to meet any future tender requirements such as Surface Covering Dynamic Compaction Control (SCDCC).

BOMAP Connect links the machines together, for example, to create a complete compaction map of the construction site – across all machines; even from different manufacturers. The result is a transparent construction site. Thanks to this unique link, BOMAG is the only company that can map and document everything from planning to the finished compacted asphalt in real time. For your company, this means: better offers, better working processes, maximum planning capability. Effort and return are optimally balanced.

LEADING THE WAY IN DIGITAL SOLUTIONS.

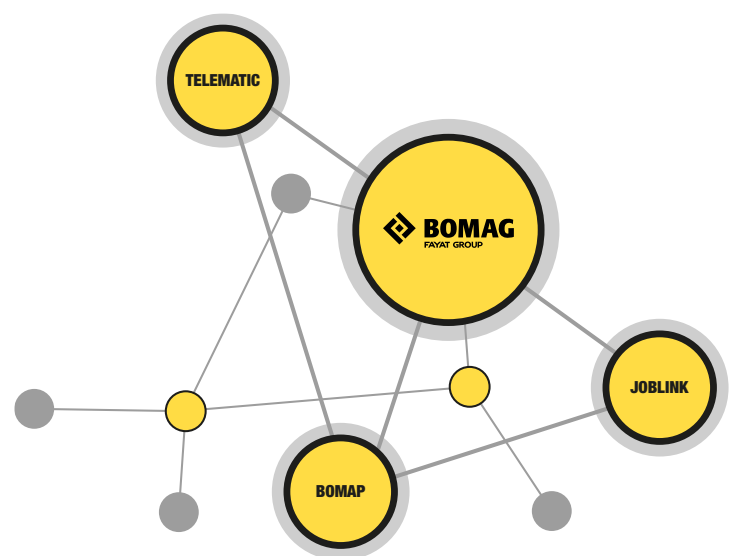



BOMAG MACHINES.
YOUR GUARANTEE
FOR SUCCESS.



JOBLINK.
THE OPEN INTERFACE.

360° DIGITAL



TELEMATIC.
THE EFFICIENT FLEET
MANAGER.



BOMAP.
YOUR SMART HELPER ON
CONSTRUCTION SITES.



HEATS UP FASTER, LONGER IN USE.

The right temperature is crucial in asphalt construction. And with MAGMALIFE, it simply goes faster: All the screed plate heating rods are cast into one aluminium block. Thanks to its excellent thermal conductivity, the paver needs just 20 minutes to heat up with uniform temperature distribution. Greater speed saves money during work

processes. The long service life of the heating plates offers even more saving potential. The well-protected heating elements resist the most adverse conditions, whether from vibration impacts or corrosion. You can count on long maintenance intervals and lower maintenance costs.

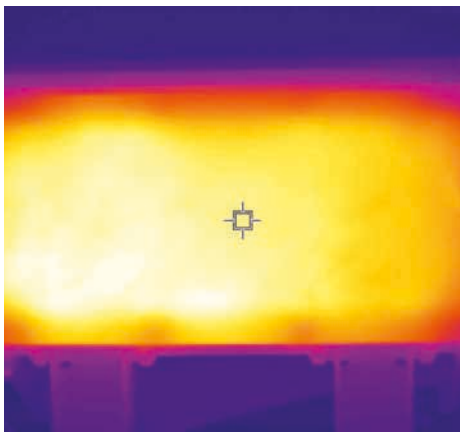

Optimal temperature distribution.

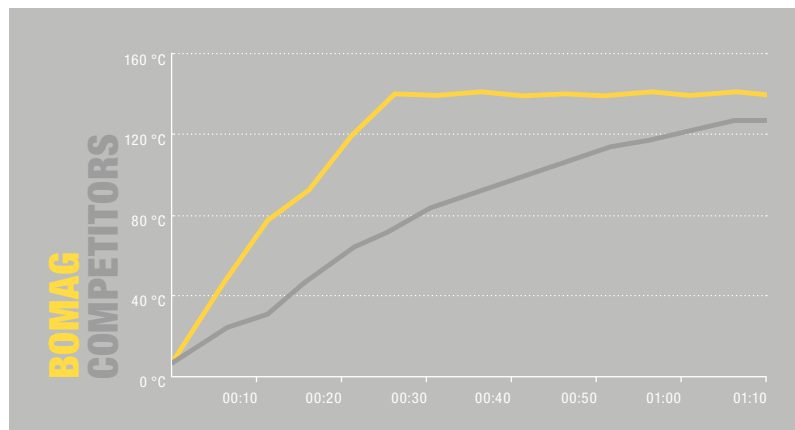

BOMAG compared to conventional electric screeds: up to 50% faster heat-up time.



Perfectly protected: cast-in heating elements.



EQUIPPED WITH SHORT SETUP TIMES.

Highest efficiency best describes our QUICK COUPLING technology. This is a smart quick-attachment system, which allows the screed extension to be simply hooked into place, making it much easier to install.

Result: shorter refitting times, significantly lower costs, maximum flexibility for all paving widths.

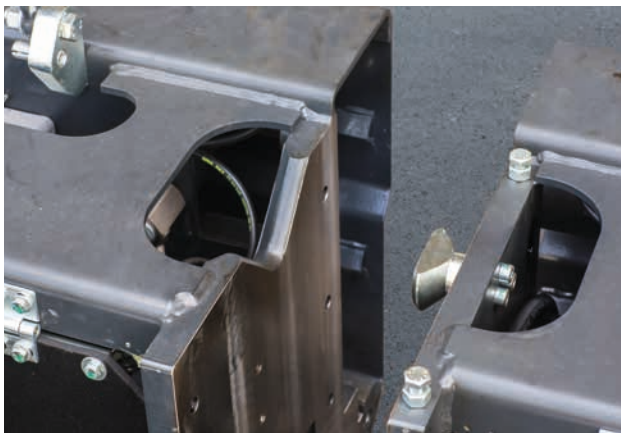

Brilliantly simple: the receptacle of the QUICK COUPLING system.



Faster to extend, faster to use.

PAVING WIDTHS FOR ANY CONSTRUCTION SITE CONDITION: SCREEDS S500/S600

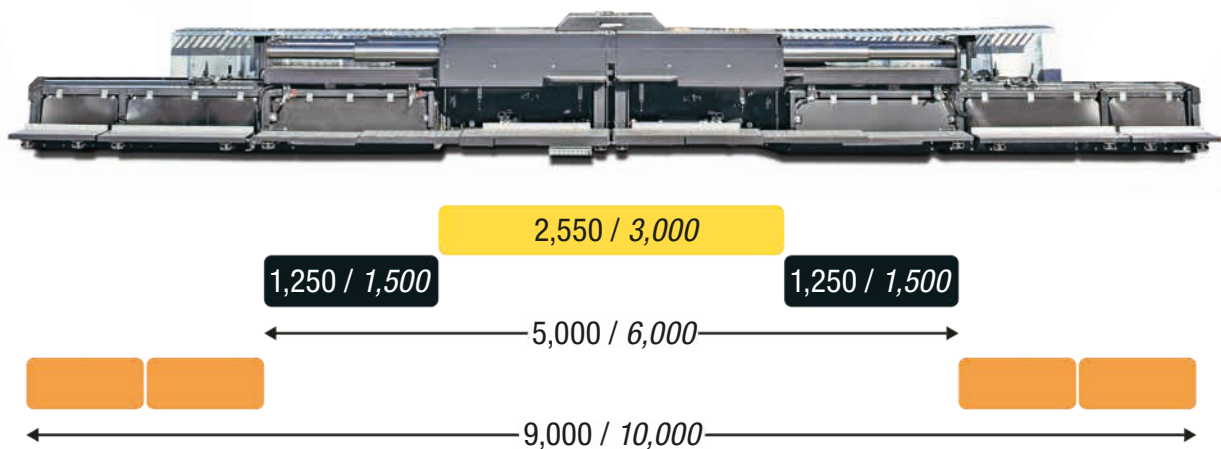

MAXIMUM PRE-COMPACTION.

IT'S THE BEGINNING THAT COUNTS.

The better the pre-compaction, the more efficient the whole paving process will be. BOMAG's high-performance screeds do an excellent job in this respect. Thanks to the screed's high dead weight in combination with the large

depth of the screed plates. The degree of pre-compaction can be individually adjusted by controlling the frequencies for the vibration units and the tamper bar.

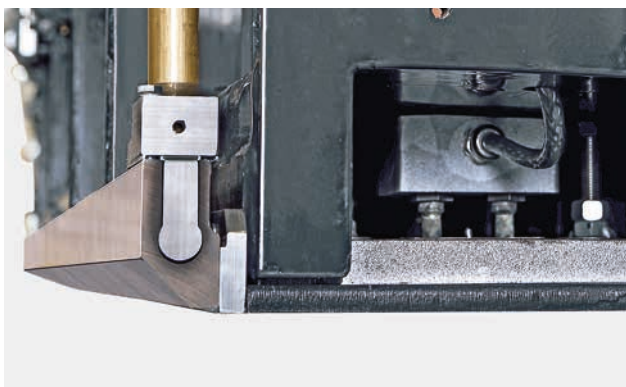
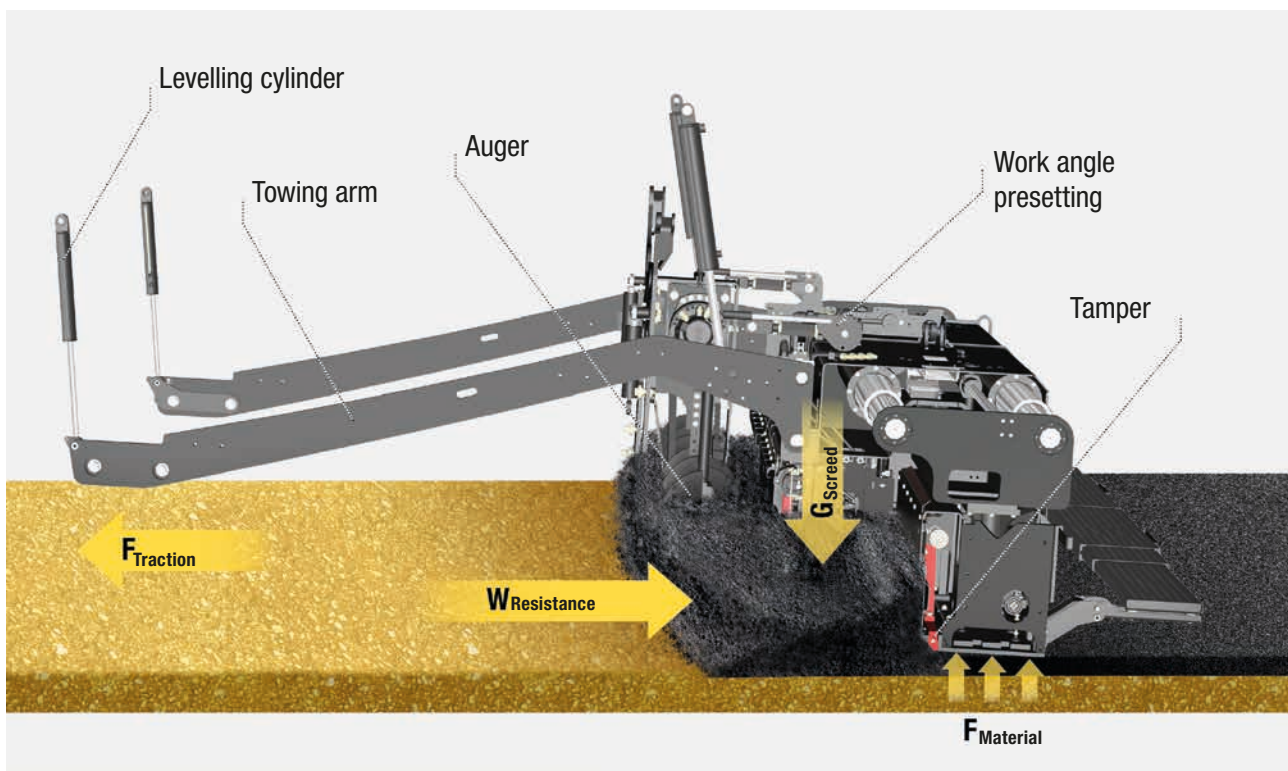

Tamper bar of BOMAG high-performance screeds.



Very long screed plates for perfect asphalt evenness.

PERFECT MATERIAL FLOW.

THE KEY TO ACHIEVING EVENNESS.

The decisive factor for evenness is the optimum floating behaviour of the screed. This requires uniform material distribution in front of the screed, which is where our pavers' generously dimensioned spreading augers really come into their own. By ensuring a strong and uniform flow of

material. The augers prevent material segregation even with large paving widths. In addition, the augur blades can be replaced individually, making maintenance simple and less expensive, providing another reason to be happy besides the perfect evenness.



Smooth material flow: the reversible conveyor belt.



400 mm auger made of wear-resistant cast iron.



Perfect evenness as a result—especially when under time constraints such as here on a night time construction site at the airport.



SMARTER UNDER THE HOOD.

The 6-cylinder engines of the Universal and Highway class meet the latest exhaust classification V, and are as economical as they are low in emissions. ECOMODE is an active engine and hydraulics management system that saves up to 20% fuel, reduces noise and has a lower envi-

ronmental impact. It regulates the engine speed so that most of the work takes place in the most economical mode. If more power is required, the sensors adjust the engine speed, and the demand-driven hydraulics supply the exact power needed.

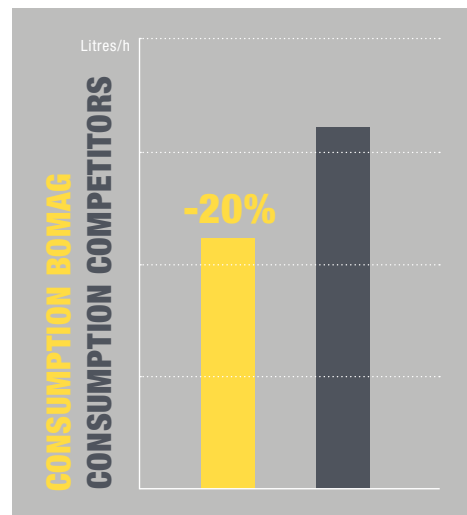

DRIVE ALTERNATIVES.

MORE GRIP OR GREATER MANOEUVRABILITY?

Every construction site is different – that’s why you can also choose between track chain and wheel drive. When traction and larger paving widths are particularly important, there is a lot to be said for the hydrostatically driven crawler track with its dead-straight paving results. On nar-

rower, more winding stretches or when a high degree of mobility is required, the 4 x 6 or 6 x 6 wheel drive is recommended, which can even travel to the site under its own steam if necessary.



GENUINE PARTS AND SERVICE.

DON'T WASTE ANY TIME.

When it comes to service and spare parts, you can rely on proven BOMAG quality. With BOMAG Genuine Parts Kits, you are optimally prepared for any situation and can be sure that your machine will be up and running again quickly.

SERVICE KITS: EASY MAINTENANCE. FULL PERFORMANCE.

Our service kits are precisely tailored to your paver and contain all the genuine parts required for professional maintenance in one convenient package. This saves you time and money and also protects your warranty claim. Downtimes are avoided by using genuine BOMAG parts.



EMERGENCY KITS – THE MOST IMPORTANT THINGS ALWAYS AT HAND.

The kits contain function-relevant components specially tailored to your paver for quick and efficient repairs. For example: control levers and switches, sensors and pressure switches, potentiometers, relays and fuses. Downtimes and the associated outage costs are reduced to a minimum. Profitability increases.



WEAR PART KITS, LONGER SERVICE LIFE, LOWER COSTS.

Always suitable for your machine, all parts needed for replacement in one kit. This saves time because all wear parts can be ordered with just one part number. The laborious search for individual parts is no longer necessary. At the same time, you make your paver more cost effective.



OPTIONAL EQUIPMENT.

FOR ALL THOSE WHO WANT A FEW MORE CLEVER IDEAS.



EXTRACTION SYSTEM FOR ASPHALT FUMES:

The asphalt fumes are extracted by the system directly at the tunnel and vented above the roof.



FOLDABLE & HYDRAULIC SIDE PLATES:

The side plate offers you the best possible functionality and flexibility both during transport and installation.



HYDRAULIC FRONT GATE/PUSH ROLLERS:

The individually controllable front gate ensures an ideal material flow at all times. Hydraulic push rollers always adapt to the truck.



TRUCK DOCK:

The perfect “assistant” for smooth and continuous communication with the mix truck.



THERMAL SCANNER:

The temperature scanner gives you an overview of the paved asphalt temperature at all times. Additional sensors document the position of the machine as well as the current weather conditions.



LAYER THICKNESS MEASUREMENT:

Continuous layer thickness measurements enable you to guarantee the correct paving thickness at all times and prevent the use of too much material.



BOMAG TELEMATIC:

This means that all machine data is permanently available for optimum fleet and service management. AEMP 2.0 standard-compatible.



POWER MOON:

If you would like to further increase the already high level of illumination provided as standard, we offer an additional balloon together with mounting materials.



WEATHER PROTECTION:

The windshield and side panel provide optimum protection in all weather conditions. This supports the driver, thus improving the work process.



TEMPERATURE MEASUREMENT:

Option for material temperature measurement – two freely positionable temperature sensors.

TOTAL COST OF OWNERSHIP.

OVERALL BETTER FIGURES.

What our machines do best? Provide a perfect quality-profitability ratio. On the one hand, the quality of the technical details delivers outstanding work results and, on the other, ensures a long service life and low service requirements. Just consider the durability and performance of MAGMALIFE. Or the efficiency thanks to ECOMODE.

This all adds up to the lowest cost of ownership in the Universal and Highway class. With savings of up to 30%. And that's a figure that not only convinces engineers, but also the accounting department.

OPERATING COSTS/H BOMAG OPERATING COSTS/H COMPETITORS

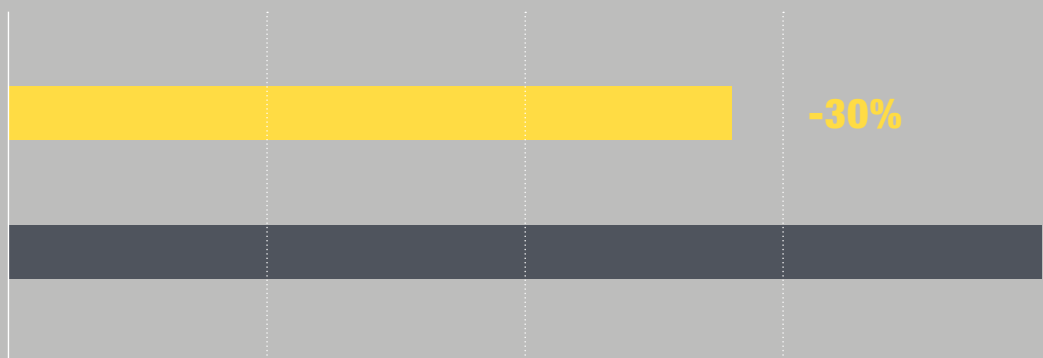

TECHNICAL DATA.

FIGURES THAT ARE JUST AS CONVINCING.

The pavers BF 600-3 to BF 800-3 of the Universal and Highway class are state-of-the-art precision machines. Thanks to the intelligent system design and the intuitive and modern operating concept, they are the best choice

for demanding tasks. And with their efficient drive technology, they also protect the environment.

	BF 600 C-3	BF 600 P-3	BF 700 C-3	BF 800 C-3
Paving performance	600 t/h	700 t/h	700 t/h	800 t/h
Engine	Deutz 6-cylinder (116/116 kW)	Deutz 6-cylinder (129 kW)	Deutz 6-cylinder (128/129 kW)	Deutz 6-cylinder (135/140 kW)
Exhaust classification	Stage IIIa/TIER3 Stage V/TIER4f	Stage V/TIER4f	Stage IIIa/TIER3 Stage V/TIER4f	Stage IIIa/TIER3 Stage V/TIER4f
Screed type	S500/S600	S500/S600	S500/S600	S500/S600
Compaction unit	Tamper vibration	Tamper vibration	Tamper vibration	Tamper vibration
Basic screed	2.5 – 5.0 m 3.0 – 6.0 m	2.5 – 5.0 m 3.0 – 6.0 m	2.5 – 5.0 m 3.0 – 6.0 m	2.5 – 5.0 m 3.0 – 6.0 m
Max. paving width	8.0 m	7.5 m	9.0 m	10.0 m

Subject to technical changes. Machines may be shown with optional accessories.



YOU DELIVER PERFECTION, WE DELIVER THE RIGHT TOOLS.

Success always comes from teamwork. This applies not only to your crew on the job site, but also to the interaction between you and us. We develop our machines on the basis of your experience and according to your needs. We want to give you exactly the tool you need to complete your tasks. Efficient in handling resources, convenient

in operation and reliable in delivering convincing work results. Like here on a B road near Oberhof in Thuringia, Germany. That's what drives us: contributing to the success of our customers. Our Universal and Highway class pavers are an excellent example of this. Welcome to BOMAG.





Head Office:

BOMAG
Hellerwald
56154 Boppard
GERMANY
Tel. +49 6742 100-0
info@bomag.com

**BOMAG Maschinen-
handels-gesellschaft m.b.H.**

Klausenweg 654
2534 Alland
AUSTRIA
Tel. +43 2258 20202
austria@bomag.com

BOMAG MARINI EQUIPAMENTOS LTDA.

Avenida Clemente Cifali, 530
Distrito Industrial Ritter
Cachoeirinha – RS
BRAZIL
ZIP code 94935-225
Tel. +55 51 2125-6642
brasil@bomag.com

BOMAG (CANADA), INC.

2233 Argentia Road, East Tower
Suites 302
L5N 2X7 Mississauga, ON
CANADA
Tel. +1 800 782 6624
canada@bomag.com

BOMAG (CHANGZHOU)

Construction Machinery Co., Ltd.
No. 66 Bopa Road
Xuejia Town
Xinbei District
Changzhou 213125
CHINA
Tel: +86 519 88585566
china@bomag.com

BOMAG India Pvt Ltd

Unit No. 614, B Wing, 6th Floor
Kanakia Wall Street
Chakala Andheri Kurla Road
Andheri East
Mumbai 400 093 Maharashtra
INDIA
Tel.: +91 8657492418
india@bomag.com

BOMAG France S.A.S.

2, Avenue du Général de Gaulle
91170 Viry-Châtillon
FRANCE
Tel. +33 1 69578600
france@bomag.com

BOMAG (GREAT BRITAIN), LTD.

Sheldon Way
Larkfield, Aylesford
Kent ME20 6SE
GREAT BRITAIN
Tel. +44 1622 716611
gb@bomag.com

BOMAG Italia

Via Roma 50
48011 Alfonsine
ITALY
Tel. +39 0544 864235
italy@bomag.com

FAYAT BOMAG Polska Sp. z o.o.

Ul. Szyszkowa 52
02-285 Warszawa
POLAND
Tel. +48 22 482 04 00
poland@bomag.com

FAYAT BOMAG RUS OOO

141400, RF, Moscow region
Khimki, Klayazma block, h. 1-g
RUSSIA
Tel. +7 (495) 287 92 90
russia@bomag.com

BOMAG GmbH

300 Beach Road
The Concourse, #18-06
Singapore 199555
SINGAPORE
Tel. +65 6 294 1277
singapore@bomag.com

BOMAG Americas, Inc.

125 Blue Granite Parkway
Ridgeway SC 29130
U.S.A.
Tel. +1 803 3370700
usa@bomag.com



Whether on the construction site or in the office.
Simply download a digital copy of this BOMAG
product brochure from our website.

