



Centrifuges



USER MANUAL

DM0424 Clinical Centrifuge user manual

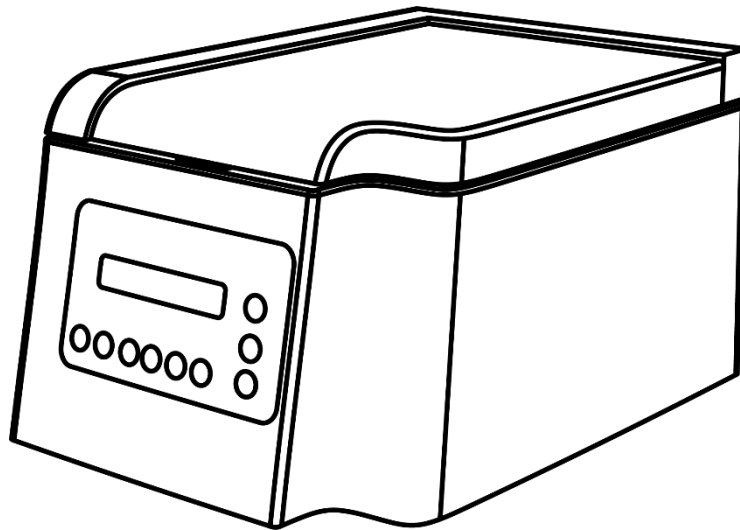

CE FC

12301646

Ver.20211215





CONTENTS

SAFETY NOTICE	1
1. INTRODUCTIONS	5
2. Specifications	5
3. DECLARATION OF CONFORMITY	7
4. REQUIRED OPERATIONAL CONDITION	8
4.1. Basic Operational Conditions	8
4.2. Transport and storage condition	8
5. INSTALLATION	9
5.1. Location	9
5.2. Connection of the power cord and grounding	10
6. STRUCTURE	11
7. OPERATION PANEL	12
8. ROTOR PREPARATION	14
8.1. Prepare the samples	14





8.2. Transfer the samples into tubes	14
8.3. Keep the tubes in balance	14
8.4. Inspect the rotor	14
8.5. Symmetrically load centrifuge tubes onto the rotor	15
9. OPERATION	16
9.1. Normal operation.....	16
9.2. RCF operation.....	20
10. MAINTENANCE	22
10.1. Cleaning.....	22
10.2. Rotor installation	24
11. COMMON FAILURES AND SOLUTIONS	25
11.1. List of common failures.....	25
11.2. How to open the upper cover.....	26
12. Introduction to rotor and centrifuge tube	27
12.1. Introduction to rotor	27
12.2. Centrifuge tube.....	29





13. RCF CALCULATION..... 32

14. FACTORY REPAIR AND SCRAPPING 32

 14.1. Factory repair 32

 14.2. Scrapping 32

AFTER-SALES SERVICES 33







SAFETY NOTICE

The symbol  is the internationally accepted safety mark. Please carefully read and fully understand the following safety rules.

- Comply with the operating requirements of the instructions and ensure correct and safe use of this centrifuge.
- Carefully read all safety information and safety tips.
- Safety information is marked as follows and safety sign  is combined with warnings and cautions respectively to remind users of potential danger. These two combinations and prompt signs are defined as follows:

	<p>WARNING: Personal Danger</p> <p>Warning notes indicate any condition or practice, which if not strictly observed, could result in personal injury or possible death.</p>
--	--

	<p>CAUTION: Possible damage to instrument</p> <p>Caution notes indicate any condition or practice, which if not strictly observed or remedied, could result in damage or destruction of the instrument.</p>
--	--



Reminder: Matters that generally call for attention.

- Do not operate this centrifuge in any manner not described in this manual. When in doubt or trouble with this centrifuge, ASK FOR HELP from original manufacturer or authorized distributors.
- The precautions described in this manual are carefully developed in an attempt to cover all the possible risks. However, it is also important that you are alert for unexpected incidents. Please operate with care.



WARNING:

- This centrifuge is not explosion-proof. Never use explosive or flammable samples.
- Do not install the centrifuge in or near places where inflammable gases are generated or chemicals are stored.
- Do not place dangerous material within 30 cm around the centrifuge.
- Make sure to prepare necessary safety measures before using samples that are toxic, radioactive or contaminated with pathogenic micro-organisms at your own responsibility.
- If the instrument, rotor and/or accessories that has been contaminated by solutions with toxic, radioactive or pathogenic materials, clean it according to the decontamination procedure accordingly.



- If you require services at site, please sterilize and decontaminate it in advance, and then describe the details of the hazardous substance to the service center involved in.
- Do not handle the power cord or turn on or off the POWER switch with wet hands to void electrical shocks.
- For safety purposes, do not enter within 30 cm around this centrifuge while it is running.
- While the rotor is rotating, never release the door lock by force.
- Do not repair, disassemble the centrifuge or carry out other maintenance without proper authorization. Please contact the service center of the manufacturer or nearest distributor if you need such service.

**CAUTION**

- This centrifuge must be located on solid and level workbench top.
- Make sure the centrifuge is installed in a precise level manner before running.
- Make sure the angle between the door and cover is greater than 70 degrees when open the door.
- Do not put your fingers or hands under the door when you press the door to close it.
- Do not move or relocate this centrifuge while it is running.



- If fluid spills in the rotor chamber, please promptly clean and dry with a dry cloth to avoid sample contamination.
- Ensure to remove any objects and fragments of the tubes dropped inside the rotor chamber before running this centrifuge.
- Cautions on rotors
 - (1) Always check for corrosion and damages on the rotor surface before using it. Do not use the rotor in question.
 - (2) Do not set the centrifuge speed beyond the speed limitation of the rotor kits (the combination of rotor and adapters). Make sure to run it below the lowest permissible speed.
 - (3) Do not exceed the imbalance tolerance.
 - (4) Do not over fill centrifuge tubes.
 - (5) Ensure the lid is fastened onto the rotor if there is one before running.
- In case of anomalies such as strange noises during operation, please stop it immediately and contact our service center. Keep a record of the error code if displayed and inform the service personnel of the code.
- Intense vibrations like earthquake could possibly damage the centrifuge. Contact our service center in case of such suspicion.



1. INTRODUCTIONS

This device is a medical device (laboratory centrifuge) and this centrifuge is mainly used to separate blood, urine or feces samples. Before using this instrument, please undergo specialized training and operate it strictly according to the instructions.

2. Specifications

Max. rotation speed	4000 rpm (500-4000 rpm), step: 100 rpm
Max. relative centrifugal acceleration	2500 xg, step: 100 xg
Capacity	50 ml×4, 15 ml×24, 10 ml×12
Timing	1 min-99 min-HOLD (continuous operation)
Noise	≤65 dB(A)
Drive motor	Brushless DC motor
Safety mechanism	Single door locks, over speed and status diagnosis system
Power supply	Single phase, 100V-240V, 50Hz/60Hz, 3A/115VAC ,1.7A/230VAC, 110W



Ambient conditions		
-place	Indoor	
-altitude	No more than 2,000 m	
-ambient temperature	2°C - 40°C	
-humidity	80%	
-over-voltage category	II	
-contamination level	2	
Protection class	I	
EMC		
-radiated interference	EN/IEC 61326-1	FCC Class A
-radiation immunity	Class A	
Dimensions (mm)	364 (L) × 440 (W) × 268 (H)	
Weight	14.5kg	
Other functions	Rotation speed/acceleration switchover, operation process display, sound reminder	





3. DECLARATION OF CONFORMITY

In compliance with the following safety standards:

UL 61010-1:2012 R4.16

CAN/CSA-C22.2 NO.61010-1-12+GI1+GI2

IEC 61010-2-020:2016

In compliance with the following electromagnetic compatibility standards:

FCC Part 15 Subpart B: 2017

IECS-001: 2006



4. REQUIRED OPERATIONAL CONDITION

4.1. Basic Operational Conditions

- (1) Power supply: 100V-240V, 50Hz/60Hz, 3A/115VAC, 1.7A/230VAC.
- (2) Ambient temperature: 2°C~40°C.
- (3) Relative humidity: ≤ 80 .
- (4) No vibration or airflow around.
- (5) No airborne dust with charge, explosive and corrosive gases around.

4.2. Transport and storage condition

- (1) Storage temperature: -40°C~55°C.
- (2) Relative humidity: $\leq 93\%$.



5. INSTALLATION

Users must strictly comply with the installation instructions contained in this chapter.

**WARNING:**

- Improper power supply may damage centrifuge.
- Make sure the power source conforms to the requirement before connecting.

5.1. Location

- (1) Place the centrifuge on a firm, flat and level bench top, ensure the four feet of this centrifuge stand on the table firmly. Avoid slippery surface or surface prone to vibration.
- (2) The recommended ambient temperature is $20^{\circ}\text{C}\pm 5^{\circ}\text{C}$. Avoid temperature over 30°C or direct exposure to sunlight.
- (3) Keep clear of the centrifuge at least 10 cm on both sides and at least 30cm behind it to guarantee the cooling efficiency.
- (4) Keep away from heat source or liquid leakage to avoid elevated sample temperature or centrifuge failures.



5.2. Connection of the power cord and grounding

**WARNING:**

- To avoid electrical shocks, ensure your hands are dry when touching the power cord.
- This centrifuge must be properly grounded.

A power outlet rated for 10 A or above, with proper earth protection and in compliance with municipal safety requirements is compulsory.



6. STRUCTURE

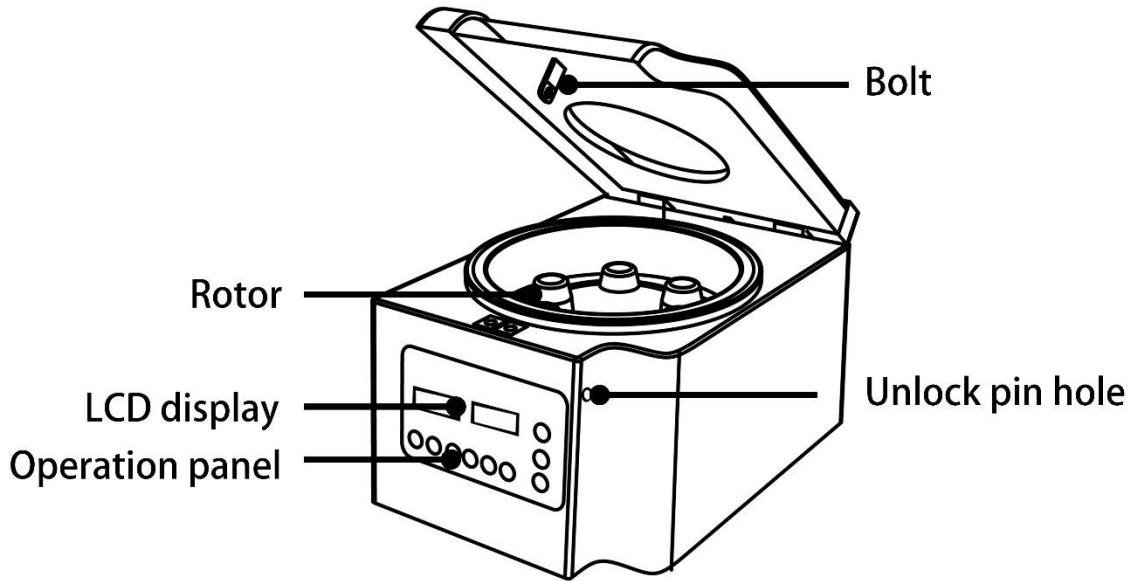

Figure 6.1 Front view of the centrifuge

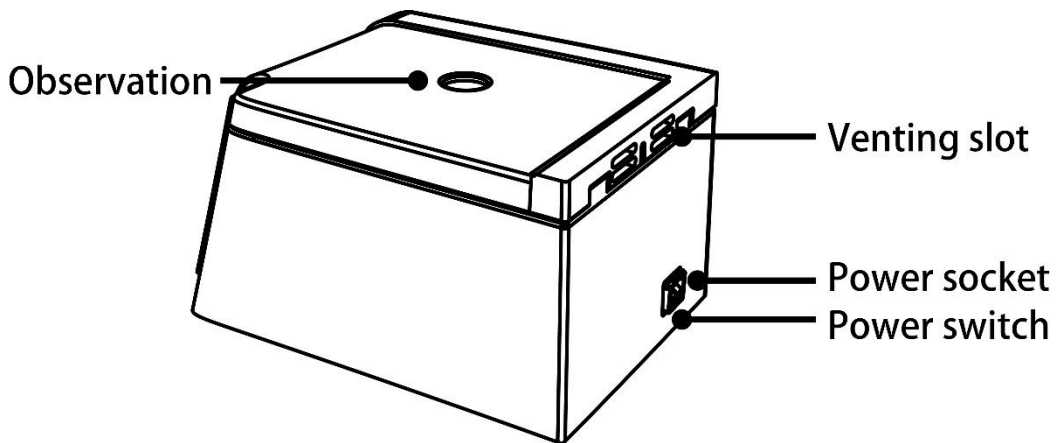

Figure 6.2 Rear view of centrifuge

7. OPERATION PANEL

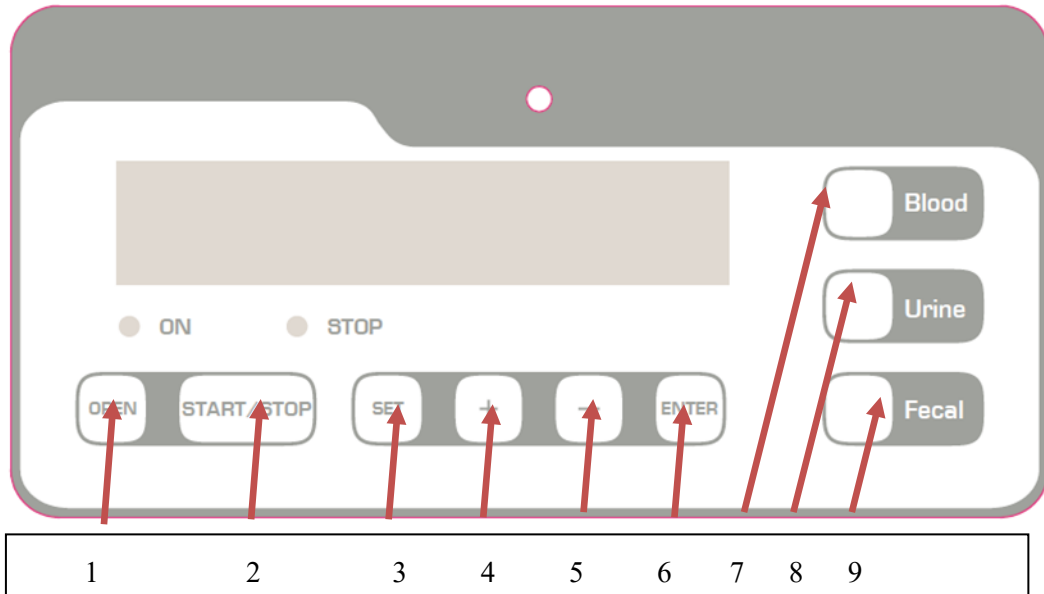

Figure 7.1 Layout of operation panel

Item	Markings	Name	Function
1	OPEN	Open key	When the speed is zero, press this key to open the door lock. When the speed is not zero, It will not work.
2	START/ STOP	Start/Stop key	When the speed is zero, press this key to start running. While the centrifuge is running, press this key to stop.
3	SET	SET key	Press this key to choose the parameters to be input.
4	+	Parameter input key	Parameter increase



5		Parameter input key	Parameter decrease
6		ENTER key	Confirm the parameter.
7		Blood program key	Press this key to load the parameter settings for blood separation.
8		Urine program key	Press this key to load the parameter settings for urine separation.
9		Fecal program key	Press this key to load the parameter settings for fecal separation.



Figure 7.2 LCD Screen Display

The LCD display layout is shown in Figure 7-2, in which the speed is set at 4,000 rpm, the upper cover is open and the set running time is 88 min. The acceleration is set to level 1 (fastest), the deceleration is set to level 1 (fastest) and the current program slot is No. 0.

When the speed icon is rotating, it is indicating that the centrifuge is running. Faster the rotation is, higher the speed is.

The time display icon displays the ratio of elapsed time against set time. The set time is divided into 10 scales.



8. ROTOR PREPARATION

8.1. Prepare the samples

8.2. Transfer the samples into tubes



Caution

- Do not over fill the tube with sample and avoid liquid leakage.

8.3. *Keep the tubes in balance*

- *Although this centrifuge may be used with visually confirmed balance, we recommend that samples be weighed using a balance to ensure balanced centrifuge tube in order to prolong the service life of centrifuge, with the deviation of no more than ± 1.5 g.*
- *Never intentionally run the centrifuge with rotor imbalance, no matter within the tolerance or not.*

8.4. Inspect the rotor

Check the rotor for corrosion or structural damage before using.



Caution

- If any corrosion or scratch is found on the rotor, please stop using it.



- Only use rotors from the manufacturer.
- Never press the unlocking button while the rotor is in operation.

8.5. Symmetrically load centrifuge tubes onto the rotor



Caution

- Be sure to tighten the rotor and the spindle firmly and ensure that the cover is securely fixed on the rotor. Otherwise, the rotor might fall off while the centrifuge is in operation, resulting in damage to the centrifuge or rotor.
- Tighten the rotor cover and rotor firmly.



9. OPERATION



Caution

- While the centrifuge is in operation, don't move the centrifuge or lean against it.
- Before running the centrifuge, keep the centrifugal chamber clean and be sure to remove any foreign object from the centrifugal chamber, such as fragments of centrifuge tube.
- If any abnormal phenomenon such as strange noise occurs during the operation, please immediately stop the centrifuge, contact the service center and inform them of the error code on the LCD display.

9.1. Normal operation

Turn on the power switch and the self-test will launch automatically. Then the most recent program setting is loaded and displayed as shown in Figure 8-1.

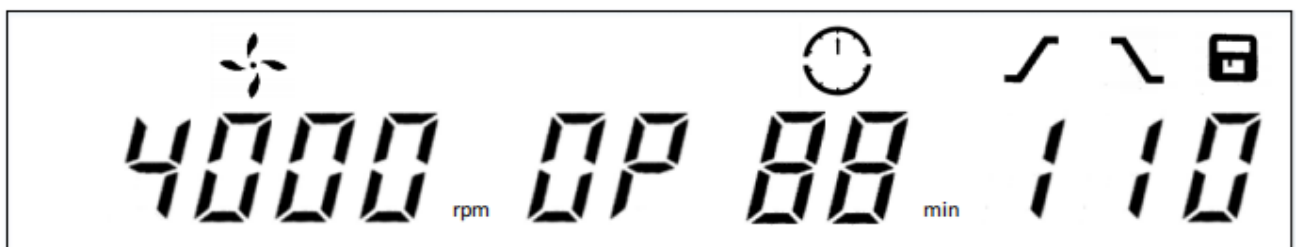



Figure 9-1 The most recent operation interface

- Speed setting: 4000 rpm. Time setting: 88 min, the acceleration setting is level 1, deceleration setting is level 1 and current program slot is No. 0.
- The upper cover is open.







(1) Set the operating parameters

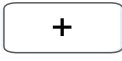

Press the SET key  gently to switch between different parameters. The parameter will blink on the LCD display when it is chosen. Press the parameter input keys to increase or decrease the selected parameter. Press and hold the parameter input keys, the value of the selected parameter will change faster.

Press the parameter input keys briefly to change the parameter value slowly. The increment is 100rpm for the rotation speed, and 1 minute for the timer. Press the ENTER key  to confirm the parameters.

(a) Set the rotation speed

- Press the SET key  to choose the rotation speed in rpm.
- When the speed parameter is selected, it will blink on the LCD screen.
- Increase the speed from 500 rpm by 100 rpm each time.
- Press the parameter input key  to increase the parameter; press the parameter input key  to decrease the parameter.
- Press and hold the parameter input key  or  to accelerate the parameter change.

(b) Set the running time

- Press the SET key  to make the time value blink and enter into the time setting mode.
- Press the parameter input key  or  to input the set time



within a range of 1min-99 min.

- HD refers to unlimited time for continuous running.

(c) Set ACC

- Press the SET key to make the ACC value blink and enter into the ACC setting mode.
- Press the parameter input key or to set the acceleration to level 1-3.

(d) Set DEC







- Press the SET key to make the DEC value blink and enter into the DEC setting mode.
- Press the parameter input key or to set the deceleration to level 0-3.

(e) Preset program setting

- Press the blood program key Blood to load parameter settings for the blood sample.
- Press the urine program key Urine to load the parameter settings for the urine sample.
- Press the fecal program key Fecal to load the parameter settings of the fecal sample.

(f) Modify the preset mode parameter



- After setting the speed and running time, press and hold the SET key  + blood program Key  for over 5s to save the current parameter settings as the blood presetting program.
- After setting the speed and running time, press and hold the SET key  + urine program Key  for over 5s to save the current parameter settings as the urine presetting program.
- After setting the speed and running time, press the SET key  + fecal program key  for over 5s to save the current parameter settings as the fecal presetting program.

(2) Start running

(a) Press the running key  to start operation.

- **The upper cover is locked, the rotor starts rotating and the red LED indicator is lit.**
- **Begin timing after startup, with the time display indicating the remaining running time.**

(b) Error display

- **It will automatically stop if any failure occurs in the running process, with the error code indicated on the time display window. By looking up it from table 11-1, the cause of error can be found and appropriate action may be taken.**

(3) Stop running





(a) When the running time is out or by pressing the key **START/STOP**, the centrifuge begins deceleration to stop.

- When the rotor fully stops, the buzzer will beep to remind the user that the operation is over.
- After the rotor fully stops, the red LED and green LED indicators will blink alternately and you will see a blinking text “OPEN” in the time display area to remind you that the operation is over. If there is no operation within 1 minute, the red LED indicator goes out and the green LED indicator stays on. If there is any operation within 1 minute, both the red and the green LED indicators will go out.

(b) The upper cover lock is opened.

- After the end of operation, the upper cover may be opened by pressing the door-opening button.
- After the end of operation, the program will automatically save the set parameters of this operation. When the device is started up again, the program will automatically retrieve the set parameters of the last operation.

(c) Open the upper cover and take out the samples and rotor.

9.2. RCF operation

- (1) Turn on the power switch
- (2) Set the RCF (relative centrifugal force)

**Caution**

- The relative centrifugal force set may not exceed the max. relative centrifugal force allowed by the centrifuge tube and its adaptor.

- Press the SET key to choose the rotation speed in “xg”. It will blink on the LCD display when it is chosen.
- Press the parameter input key or to change the relative centrifugal force by 100 xg each time.

(3) Set the operating conditions

See Section 8.1 for further instruction.



10. MAINTENANCE

10.1. Cleaning



Caution

- Cleaning or sterilizing the centrifuge without complying with the instructions contained herein might cause damage to the centrifuge.

(1) Centrifuge

- The color of housing might change and the label thereon might fall off if the centrifuge is exposed to ultraviolet for a prolonged period of time. After use, please cover the centrifuge with cloth to avoid exposure to light.
- Please clean the centrifuge using cloth or sponge soaked with neutral cleaning agent.
- The centrifuge may be sterilized using cloth soaked with 70% alcohol.

(2) Centrifugal chamber



Caution

- Cleaning or sterilizing the centrifuge without complying with the instructions contained herein might cause damage to the centrifuge.

- Clean the chamber using cloth or sponge soaked with neutral cleaning agent and sterilize the centrifuge using cloth soaked with 70% alcohol.

(3) Drive shaft

- We recommend to clean the drive shaft with a piece of soft cloth and apply a





thin layer of silicone grease on it periodically.

(4) Upper cover

- Clean or sterilize the upper cover in the same manner as (1) centrifuge.

(5) Rotor

- If the rotor is put out of service for a prolonged period, please remove the rotor from the centrifugal chamber, remove the rotor's lid and place the rotor upside down to empty the rotor hole in order to prevent corrosion.
- If any sample leaks into the rotor hole, flush the rotor hole with clean water and apply a thin layer of silicone grease on the rotor surface after it dries up.
- The rotor needs periodical maintenance. We recommend to clean the rotor every three months by cleaning the tube hole and spindle hole and applying a thin layer of silicone grease thereafter.





10.2. Rotor installation

(1) Installation

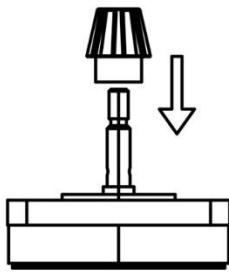

①

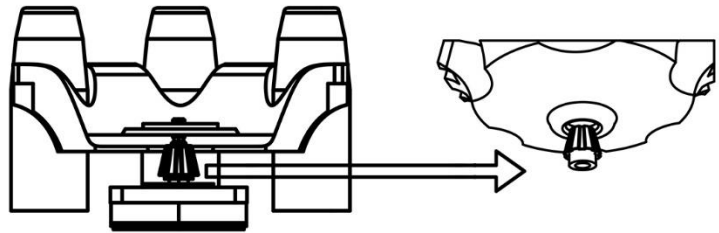

②

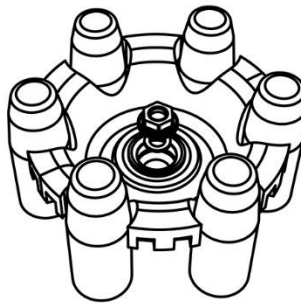

③

(2) Adjustment

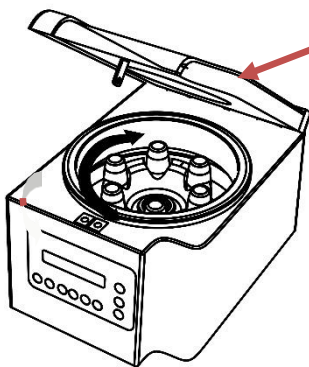

Observe here.

Before tightening the rotor, rotate the rotor with hand while carefully observing for any visible vibration. If yes, please remove the rotor and rotate it to a certain angle before remounting it until the rotor has no visible vibration. Then tighten it.



11. COMMON FAILURES AND SOLUTIONS

11.1. List of common failures

This centrifuge is capable of self diagnosis. When the centrifuge fails, the time display area will show the error code to identify the cause of failure.

Failure		Possible cause	Solution
No display after powering on		No power supply to power socket.	Check the power and reconnect the power supply.
Abnormal vibration of centrifuge		The rotor does not match with the drive shaft. The sample installed asymmetrically	Reinstall the rotor. Weigh using a balance and install it symmetrically.
Error code shown in the time display area	E-02 Upper cover door failed	Door opened during operation Press the key  when the door is open.	Immediately close the cover door. Close the cover door and press 'SET' button, then start operation.
	E-10-86	See the service manual.	Contact the service representative.

Table 11-1 Common failure and solutions

- Error code E-02 is related to erroneous operation. The centrifuge may





continue in operation after elimination of the failure.

11.2. How to open the upper cover

1) When the centrifuge is powered on

	<p>Reminder</p> <ul style="list-style-type: none"> ● Open the upper cover only when the centrifuge is powered on and the rotor is not running.
--	--

(1) The centrifuge is powered on and the upper cover locking electromagnet automatically opens.

When the rotor fully stops, press the uncovering button to open the upper cover.

(2) When the centrifuge is powered off

When the upper cover cannot be opened due to sudden power outage, the upper cover may be opened manually. Pls confirm the rotor fully stops before operation. Use the screw driver inside the package to press the hole in front middle position as below, pls be noticed that to push the locking crescent shrapnel by upper left direction to open the door.

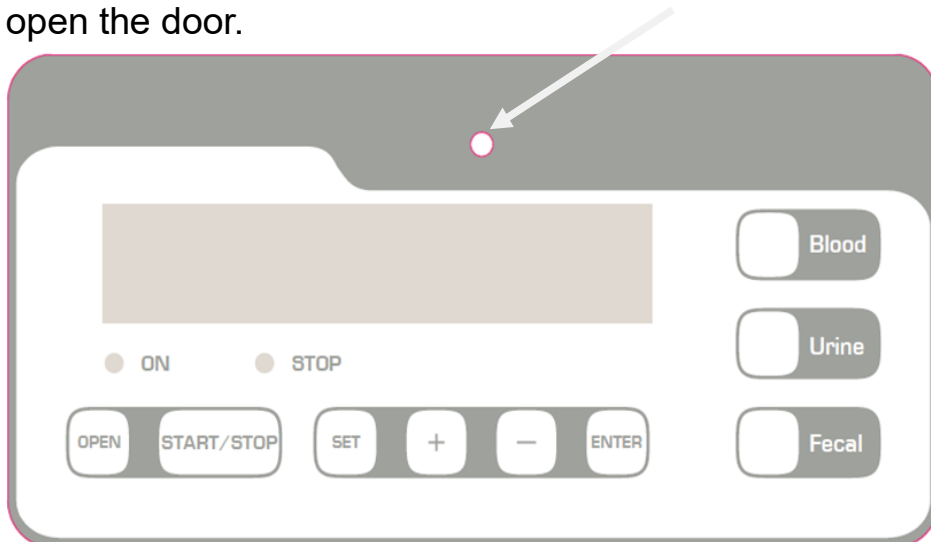



12. Introduction to rotor and centrifuge tube

	<p>Caution</p> <ul style="list-style-type: none"> ● Carefully read the user manual and correctly install and use the rotor. ● Don't exceed the max. speed allowed by the rotor, test tube and adaptor. The max. speed allowed by certain adaptors is lower than the max. speed of the rotor.
--	---

12.1. Introduction to rotor

1) Rotor structure

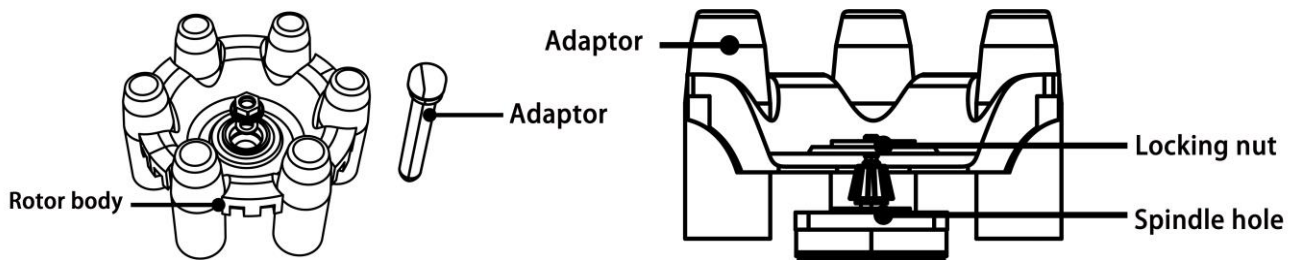

Figure 12-1 Rotor structure



2) Rotor and adaptor

Rotor model	Centrifuge tube	Holding capacity	Max. rotation speed (rpm)	Max. relative centrifugal acceleration (×g)	Adaptive
S6-15P	15ml	6	4000	2500	Optional
S4-50P	50ml	4	4000	2500	Optional
A8-15P	15ml	8	4000	1900	Optional
A24-15P	15ml	24	4000	2300	Optional
12-10P	10ml	12	4000	1900	Optional

Table 12-1 List of rotors and adaptors

3) Precautions

- The density of sample that centrifuge rotor can separate is less than 2.0 g/ml. If the density of sample to be separated exceeds 2.0 g/ml, please calculate the permissible rotation speed using the following formula:

$$\text{Permissible speed (rpm)} = \text{Max. speed} \times \sqrt{\frac{2.0(\text{g/ml})}{\text{Sample density (g/ml)}}}$$

4) Sterilization

A8-15P rotor body is made of high-strength plastics and cannot be autoclaved or radiated by ultraviolet beam.



12.2. Centrifuge tube

1) Cleaning and sterilization

Conditions		Materials	PA	PC	PP
Cleaning	Fluid cleaning	Acid cleaner (pH5 or lower)	X	X	X
		Acid cleaner (higher than pH5)	O	O	O
		Alkaline cleaner (higher than pH9)	O	X	O
		Alkaline cleaner (pH9 or lower)	O	O	O
		Neutral cleaner (pH7)	O	O	O
		70°C hot water	O	O	O
	Ultrasonic cleaning	Neutral cleaner (pH7)	O	O	O
Sterilization	Autoclaving	115°C (0.7kg/cm ²) 30min	O	O	O
		121°C (1.0kg/cm ²) 20min	X	O	O
		126°C (1.4kg/cm ²) 15min	X	X	X
	Boiling sterilization	15min to 30min	O	O	O
	Ultraviolet sterilization	200-300nm	X	X	X
	Gas sterilization	Ethylene oxide	O	X	O
Formaldehyde		O	O	O	

PA: Polyallomer PC: Polycarbonate PP: Polypropylene

Table 12.2 Cleaning and sterilization conditions for centrifuge tube

2) PC centrifuge tube cleaning

PC material has relatively low chemical stability to alkaline solvent, therefore any use of cleaning agent with pH value of over 9 should be avoided. Some neutral



cleaning agents still have pH value of over 9 after being diluted as recommended by the vendor, therefore use of cleaning agent with pH value of 7-9 is recommended.

3) Autoclaving of PA, PC and PP centrifuge tube

PA begins softening at the temperature of 120°C, while PC and PP begin softening at 130°C. Generally, PA may be sterilized for 30 min at 115°C (0.7 kg/cm²), while PC and PP may be sterilized for 20 min at 121°C (1.0 kg/cm²). Too high temperature would result in deformation of centrifuge tube. When autoclave is used, take the following steps

- (1) Place the centrifuge tube upright with opening facing upward. If the centrifuge tube is placed in an inclined or horizontal manner, it will deform due to gravity.
- (2) Remove the threaded cover and inner cover to prevent deformation or crack of the centrifuge tube.
- (3) Take the centrifuge tube only when the autoclave cools down to the room temperature.

4) Service life of centrifuge tube

The service life of plastic centrifuge tube depends upon the nature of sample, rotor speed and centrifugation temperature. When the plastic centrifuge tube is used for centrifugation of conventional neutral samples (pH5-pH9), its estimated service life



at the max. rotation speed is as follows:

When used at the max. rotation speed:

High-quality centrifuge tube (PA, PC, PP): 30-50 times

Conventional centrifuge tube: about 10 times (number of uses may be increased in case of low-speed use).

The service life of centrifuge tube is also related to the cleaning and sterilization conditions and might decrease somewhat.

Note: Never use any centrifuge tube with cracks on it.





13. RCF CALCULATION

Relative centrifugal force (RCF) can be calculated using the following formula:

$$RCF=1.118 \times r \times n^2 \times 10^{-5}$$

r-rotation radius, unit: cm; n-rotation speed, unit: rpm ;

14. FACTORY REPAIR AND SCRAPPING

14.1. Factory repair



Caution

- Before returning the instrument to factory for repair, please confirm it has been securely fixed for transport.

To protect human health, environment and material safety, please sterilize and clean the equipment and accessories before return to the factory for repair.

14.2. Scrapping

To protect human health and environmental safety, please decontaminate the equipment before scrapping it and comply with applicable laws when scrapping it. According to 2002/96/EC (WEEE), equipment purchased after August 13, 2005 may not be scrapped as domestic article. These pieces of equipment fall within type 8 (medical device) and company-to-company domain. The trash can icon with cross mark indicates that this equipment may not be scrapped as domestic article. Different EC countries have different standards for disposal of this type of wastes. If necessary, please contact the supplier.



AFTER-SALES SERVICES

To ensure safe and efficient operation of centrifuge, periodical maintenance is required. If the centrifuge fails, don't try to repair it.

Please contact the service representative center.





Centrifuges



CONTACT US



DLAB Scientific Co., Ltd

Yu An Road 31, Beijing Airport Economic core zone,

Shun yi District, Beijing, China 101318

Tel: 86-10- 85653451/52/53

Fax: 86-10-85653383

E- mail: info@dlabsci.com

web: www.dlabsci.com

