

Integration Guide

Force Sensing Resistor

To be used in conjunction with current FSR series data-sheets available at www.ohmite.com

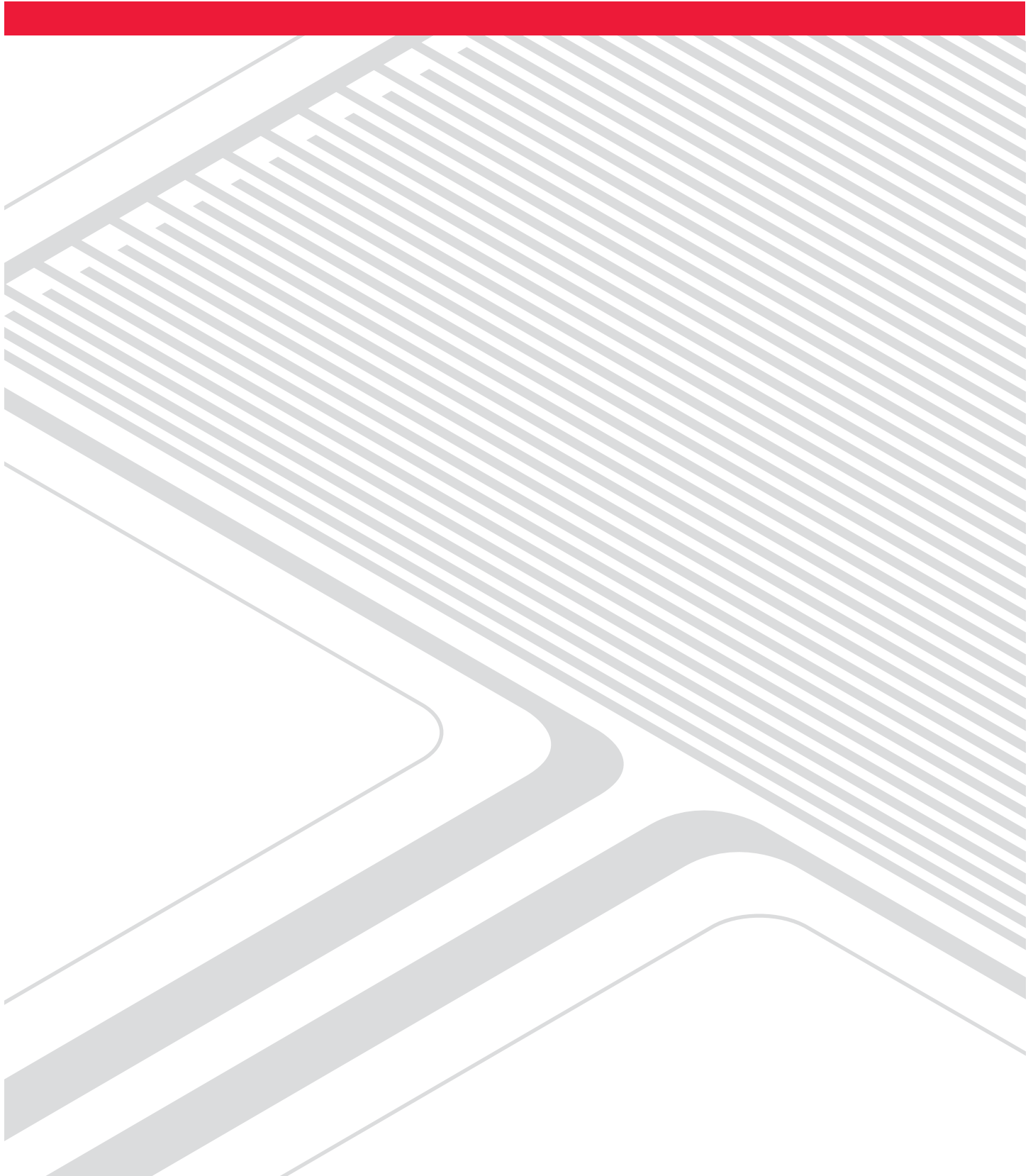

Integration Guide

Force Sensing Resistor

CONTENTS

1	Force-Sensing Resistors Overview	Page 3
2	FSR Sensor Types	Page 5
3	Single-point FSR Sensor Styles	Page 5
4	FSR Implementation Considerations	Page 6
5	FSR Interface Circuits	Page 7
6	Questions and Answers	Page 8
7	FSR Dos and Don'ts	Page 9
8	Contact	Page 10

Integration Guide

Force Sensing Resistor

1 Force-Sensing Resistors Overview

Force-Sensing Resistors (FSRs) exhibit the unique characteristic of dynamic resistance related to the amount of applied force. In general, the more force applied to the surface of the sensor, the lower the resistance. The resistance change is inversely proportional to the applied force (Figure 1).

Typical force-sensing resistors are characterized for Human-Machine Interface (HMI) or Machine-Machine Interface (MMI) applications with a sensing range from circa 20g to 5Kg. Specific device characteristics will depend on the size, shape and materials used in construction.

Force-sensing resistors are intended for applications where a delta in applied force is to be detected. They are not intended for high accuracy or specific weight measurement applications

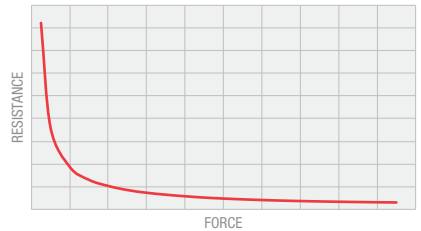

Figure 1. Typical FSR Force vs Resistance

1.1 FSR Explained

In an FSR sensor there are 3 different mechanisms in effect which together form the force resistance characteristics. Each of these mechanisms add together and merge to create the total response curve of a typical FSR and each mechanism has different dependencies on sensor construction, mechanical integration and the electrical properties of the ink.

Break force This is the force required for the 2 membrane layers to contact. In this region the resistance is infinite until enough force is applied to make contact.

Area Effect In this region the size of the contact area between the two layers is increasing with increasing force and thereby reducing the resistance.

Surface Effect In this region as the force is increased the contact of the two ink surfaces increases at a microscopic level.

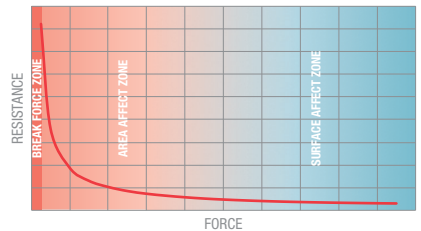
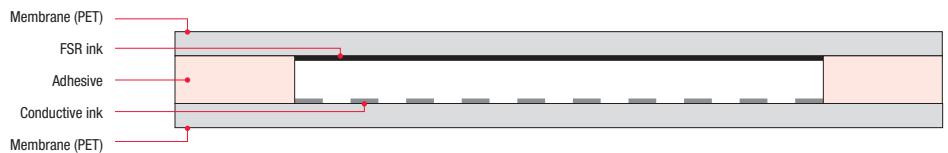

Figure 2. Typical FSR Force vs Resistance showing mechanisms

1.2 FSR Construction

FSR construction can generally be categorized into two types, Shunt Mode or Thru Mode. These alternate types exhibit different Force vs. Resistance characteristics. In general the construction of both types of FSR is similar in that both are an assembly of two separate printed substrate layers laminated together with a spacer adhesive around the outside of the sensing area.



The difference between Thru and Shunt mode is in the printed electrode structure. It is these different electrode structures that change the dominance of the different mechanisms to give different characteristics.

Integration Guide

Force Sensing Resistor

Shunt Mode Stacked view

- A PET
- B FSR
- C Spacer
- D Silver conductive
- E Tail carbon

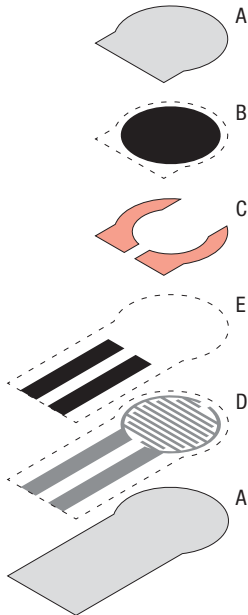

Figure 3. Basic construction Force-Sensing Resistor: Shunt Mode

Thru Mode Stacked view

- A PET
- B FSR
- C Spacer
- D Silver conductive

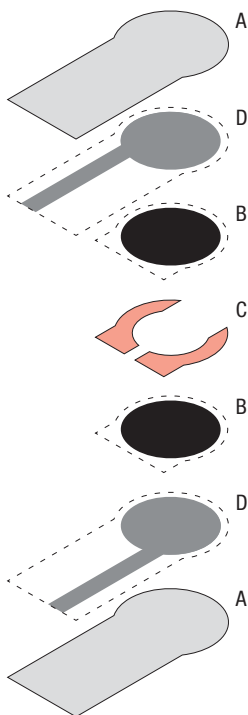

Figure 4. Generic Thru Mode design

1 Force-Sensing Resistors Overview (continued)

1.2 FSR Construction (continued)

1.2.1 Shunt Mode

A shunt mode FSR is typically constructed from two layers of PET. One layer is printed with FSR ink. The other layer is printed with an electrode layer in an interdigitated finger arrangement, typically using silver. The membranes are assembled using an adhesive perimeter spacer, typically 50-125 microns thick.

When the two layers are pressed together, the FSR ink on one layer bridges or 'shunts' the traces on the other layer (hence the name Shunt Mode).

Comments:

- All electrical connections on one layer
- Extended force range, can be up to 5kg
- Shallower curve giving better control esp. at higher forces i.e. >100g
- Fewer print layers and less silver ink required so typically cost is < Thru Mode sensors

1.2.2 Thru Mode

A Thru Mode FSR is also constructed with two membrane layers, typically PET. However, In Thru Mode construction, the FSR layer is printed on a solid conductive area. This is done identically on both the top and bottom layers, which are then assembled using an adhesive perimeter spacer. The solid conductor on each layer runs to a single output terminal, and current passes through one layer to the other, hence the name Thru Mode.

Comments:

- Electrical connection required to both top and bottom layers
- Force range is limited typically <0.5-1kg
- More print layers and more silver ink required so typically cost is greater than shunt mode

1.3 FSR Construction: Interconnect Types

Similar to a membrane switch, the tail trace pin out can be terminated and connected in a variety of methods. Ohmite's standard FSR series sensors are available with a female pin and housing option:



For custom sensors Ohmite can offer additional interconnect options including,

- Bare tail
- Crimpflex series: solder tabs, female and male connectors
- Friction fit: ZIF, TIF, gold / tin / nickel pins
- Friction fit with protective overprint
- Housing including standard, latch and detent
- Other options

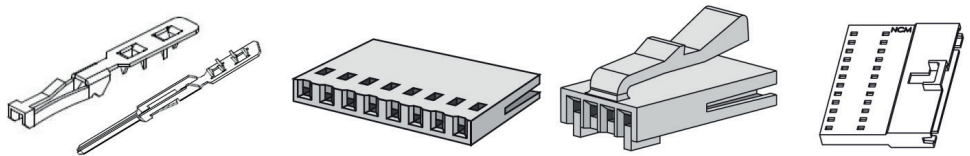

Integration Guide

Force Sensing Resistor

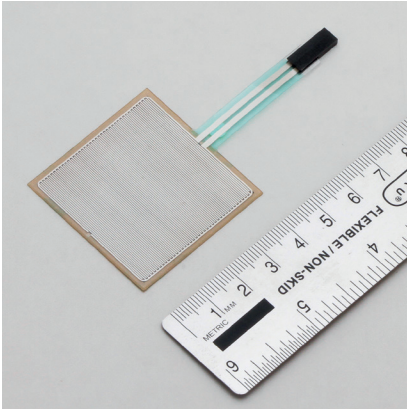

Figure 5. Example of a single-point sensor (FSR01CE)



Figure 6. Example of a single-point sensor (FSR02CE)

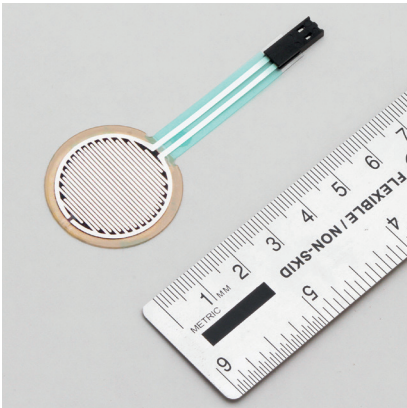

Figure 7. Example of a single-point sensor (FSR03CE)

2 FSR Sensor Types

FSR sensors can be categorized into four basic types:

2.1 Single-point

Varying shapes and sizes from small round to long strip, a single-point sensor will report applied force in the Z axis only. Single-point sensors can be individuals or multiple sensors can be manufactured in a single assembly to create arrays and other custom sensor arrangements.

2.2 Linear Potentiometer*

Typically strip or scroll-wheel configuration a linear potentiometer will report both position (X or Y) and applied force (Z) simultaneously for one touch point.

2.3 3D Single-touch*

A trackpad that can report position in two dimensions, i.e., X & Y, plus applied force Z simultaneously for one touch point.

2.4 3D Multi-touch*

A trackpad that simultaneously reports X, Y, and Z for multiple touch points.

* Not discussed in this guide.

3 Single-point FSR Sensor Styles

Ohmite offers a range of standard FSR sensors to purchase from stock with a variety of shapes and sizes. Our current range can be accessed here: www.ohmite.com

Integration Guide

Force Sensing Resistor

4 FSR Implementation Considerations

Force Sensing Resistors offer many benefits for HMI sensing in a wide range of markets and applications versus mechanical switching or capacitive sensing. These include but are not limited to:

- Small, thin and light
- Largely immune to EMI and water events
- Low power
- False touch rejection
- Cost effective
- Highly Durable (>10M activations typical)

However, as with any sensing technology, it is important from the outset to understand its suitability and design-best-practices. Key considerations at the beginning of your project should include:

4.1 General Accuracy

FSRs are not intended to replace strain gauges or load cells in designs where high absolute accuracy is required.

4.2 Integration & Actuation

Force Sensing Resistors are electro-mechanical devices where the quality and consistency of the electrical output is directly related to the quality and consistency of the mechanical input. We recommend mounting sensors to a flat rigid surface/chassis to enable full force transfer and avoid preloading. Actuation should be consistent: we recommend an actuator no larger than 80% of the active area of the sensor, preferably domed and conformable. The actuator may be an integrated element of the top-cover. The thickness and rigidity of the top layer should be considered in regard to desired characteristics and HMI model of the implementation.

4.3 Shape & Size

The shape and size of the sensor should be optimized to the required characteristics of the required HMI model. This should include expectations for sensitivity, force range, thickness & rigidity of cover material and method of actuation. For example, smaller sensors are generally less sensitive to "first touch" but this can be addressed either in the method of actuation or by a custom design sensor.

4.4 Environmental

All printed polymer sensors will change characteristics with extremes of temperature, becoming more sensitive when hot and less sensitive when cold. Humidity also impacts on FSR stability and should be considered in the application. Standard sensors should not be directly exposed to liquids as they are not fully sealed. Generally a sensor will be adequately protected from most environmental impacts when appropriately integrated into the end product.

4.5 Drift & Hysteresis

All printed polymer sensors exhibit drift, in basic terms a change in output over time for the same applied force. Similarly, hysteresis is evident in FSR sensors which may or may not be a factor in the implementation. It is often sufficient to simply limit load magnitude and duration to values which will not impose excessive hysteresis.

4.6 Part-to-Part & Single-Part Repeatability

Understanding the permissible tolerances in the application will determine if the stated repeatability of the chosen sensor will or will-not require any form of one-time or dynamic calibration.

4.7 Electrical Considerations

Generally, electrical variables are less significant and typically easier to control and understand. We recommend:

- Consistent voltage/current supply
- Consistent and reliable connection resistance
- low voltage and currents, ideally <6V and <1mA

A well considered mechanical implementation including the location of the sensor in the material stack, its actuation, and the choice of materials used above the sensor can mitigate any potential undesirable characteristics. Should a standard FSR sensor not be suitable in your application Ohmite has a full custom design and manufacturing capability.

Integration Guide

Force Sensing Resistor

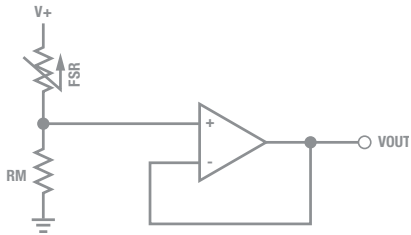

Figure 8. Voltage divider.

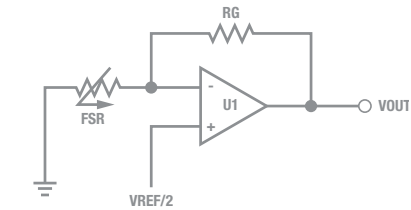

Figure 9. Alternative force sensor current to voltage converter.

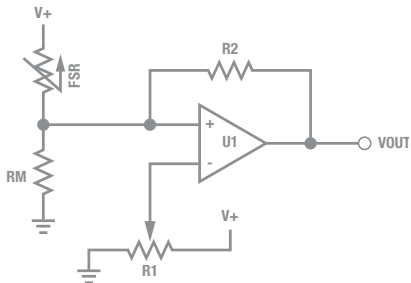

Figure 10. Force-Sensing Resistor Variable Force Threshold Switch

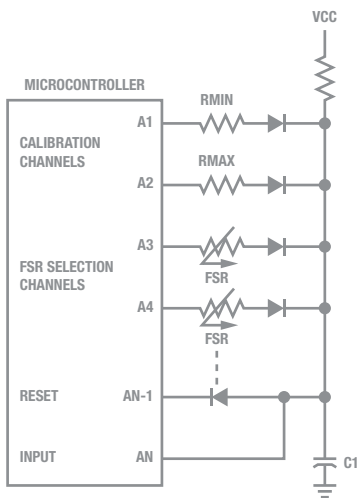

Figure 11. Multi-channel Analog-to-Digital Interface

5 FSR Interface Circuits

Single-point Force Sensing Resistors are 2-wire devices that are easily interfaced electronically. Example configurations include:

5.1 Voltage Divider

For a force to voltage conversion, the sensor is connected to a measuring resistor in a voltage divider configuration (Figure 8). The output is described by the equation:

$$V_{OUT} = \frac{R_M V +}{(R_M + R_{FSR})}$$

In the equation, the output voltage increases with increasing force. The measuring resistor RM is chosen to maximize the desired force sensitivity range and to limit current.

Alternative force sensor current to voltage converters include the configuration in Figure 9.

The output of this configuration is described by the equation:

$$V_{OUT} = R_M \left(\frac{V_{OUT} - V_+}{V_+} \right)$$

The output swing of this circuit is from VREF/2 to 0V. In the case where RG is greater than RFSR, the output will go into negative saturation.

5.2 Variable Force Threshold Switch

The circuit in Figure 10 is an example of how a Force Sensing Resistor can be used in applications requiring “on-off” interfaces. Examples include membrane switches and limit switches. Common designs of Force Sensing Resistors allow the interface to develop switches that actuate at a specific force. Variations of this circuit can be designed depending on the application.

5.3 Multi-channel Analog-to-digital Interface

The circuit (Figure 11) is an example of how a force sensor can be used in a cycle switch. The number of cycles required to active the switch is proportional to the resistance of the sensor. Multi-channel switches are mostly engineered high or low side configured. This can require more than one force sensor if mixed load configurations need to be driven.

Integration Guide

Force Sensing Resistor

6 Questions and Answers

6.1 What environmental conditions could affect or damage the sensor?

A Force-Sensing Resistor has similar properties as any electrical or membrane switch. Therefore, care must be taken to protect the sensor from the environment. Water submersion, high or low temperatures (operating temperature -20°C to +85°C acceptable), sharp objects, puncture, shear forces, folding and electrical shock can all have adverse effects.

However, depending on the application, any sensor can be engineered to overcome many extreme conditions.

6.2 What can the sensor be attached or laminated to?

Ideally, a clean flat surface covering the entire sensor area is the preferred conditions when laminating the sensor. Air bubbles, dirt or surface inconsistencies will affect the sensors performance. Sensors can be laminated to metal, plastic, circuit boards and PCB boards.

However, depending on the application, many sensors can be laminated to curved, uneven or layered surfaces with the correct design and engineering.

6.3 What drive voltages can be applied to the sensor?

Typical range from 0.1V to 5V. To test the resistance change over pressure, it is recommended to use a multi-meter for initial testing and calibrations. More complicated design and testing can be done on LabView or equivalent software.

6.4 Does the sensor have to be calibrated?

Force-Sensing Resistors may require calibration depending upon the application force accuracy requirements. Just like any other resistor, electrical noise, intense RF sources and electro-static build up can affect the sensor. Part calibration might be required with the use of reference voltage and feedback resistors for each force sensor to calibrate responses closer to the desired nominal curve.

6.5 How can you get repeatable and reproducible results?

When actuation design is being considered, force distribution is critical. Sensor response when subjected to the distribution of an applied force is more likely to be repeatable if the force distribution remains the same. Actuator location and placement will also affect the sensor performance.

The maximum actuator size should be 80% of the active area of the sensor. If the actuator is above 80% or bigger than the sensor area, the repeatability of the sensor may suffer due to the interference of the spacer.

Integration Guide

Force Sensing Resistor

7 FSR Dos and Don'ts

7.1 DO avoid air bubbles, sharp objects or contaminates when laminating the sensor.

The surface should be flat, firm and smooth. This will help prevent any preloading of the resistor or false readings.

7.2 DO be careful when laminating the sensor to curved surfaces.

Bends and corners can unintentionally actuate the sensor.

7.3 DON'T crease the sensor or tail containing trace prints.

This can potentially crack the conductive inks and cause intermitted response.

7.4 DON'T trap or block the spacer air vent.

The vent ensures equalisation of air pressure within the sensor.

7.5 DON'T apply excessive shear force.

This may cause delamination.

Integration Guide

Force Sensing Resistor

8 Contact

Headquarters	27501 Bella Vista Parkway, Warrenville IL, 60555 - USA
Toll-Free	1-866-9-OHMITE
International	1-847-258-0300
Fax	1-847-574-7522
Web	www.ohmite.com
Email	info@ohmite.com