

TEST REPORT

Application No.: SHEM2509006124HS
Applicant: Ningbo Coldspot Intelligent Technology Co.,LTD
Address of Applicant: No.555 Xiangshan road, Cixi Binhai Economic Development Zone, Zhejiang Province, China
Manufacturer: Ningbo Coldspot Intelligent Technology Co.,LTD
Address of Manufacturer: No.555 Xiangshan road, Cixi Binhai Economic Development Zone, Zhejiang Province, China
Factory: Ningbo Coldspot Intelligent Technology Co.,LTD
Address of Factory: No.555 Xiangshan road, Cixi Binhai Economic Development Zone, Zhejiang Province, China

Equipment Under Test (EUT):
EUT Name: Split-type Air Conditioner
Model No.: KFR-30GW/BpH3-100, KF-9GW/C1-100, KF-12GW/C1-100, KF-18GW/C1-100, KF-24GW/C1-100, KF-30GW/C1-100, KFR-9GW/H1-100, KFR-12GW/H1-100, KFR-18GW/H1-100, KFR-24GW/H1-100, KFR-30GW/H1-100, KF-9GW/BpC3-100, KF-12GW/BpC3-100, KF-18GW/BpC3-100, KF-24GW/BpC3-100, KF-30GW/BpC3-100, KFR-9GW/BpH3-100, KFR-12GW/BpH3-100, KFR-18GW/BpH3-100, KFR-24GW/BpH3-100

Remark: Please refer to section 2 of this report which indicates which model was actually tested and which were electrically identical.

Standard(s) : EN IEC 55014-1: 2021
EN IEC 61000-3-2: 2019 +A1:2021 +A2:2024
EN 61000-3-3: 2013 +A1:2019 +A2:2021
EN IEC 55014-2: 2021

Date of Receipt: 2025-09-10
Date of Test: 2025-09-12 to 2025-11-21
Date of Issue: 2026-01-23

Test Result:	Pass*
---------------------	--------------

* In the configuration tested, the EUT complied with the standards specified above.

This document is issued by the Company subject to its General Conditions of Service printed overleaf, available on request or accessible at <http://www.sgs.com/en/Terms-and-Conditions.aspx> and, for electronic format documents, subject to Terms and Conditions for Electronic Documents at <http://www.sgs.com/en/Terms-and-Conditions/Terms-e-Document.aspx>. Attention is drawn to the limitation of liability, indemnification and jurisdiction issues defined therein.

Any holder of this document is advised that information contained hereon reflects the Company's findings at the time of its intervention only and within the limits of Client's instructions, if any. The Company's sole responsibility is to its Client and this document does not exonerate parties to a transaction from exercising all their rights and obligations under the transaction documents. This document cannot be reproduced except in full, without prior written approval of the Company. Any unauthorized alteration, forgery or falsification of the content or appearance of this document is unlawful and offenders may be prosecuted to the fullest extent of the law.

Unless otherwise stated the results shown in this test report refer only to the sample(s) tested and such sample(s) are retained for 30 days only.

Member of the SGS Group (SGS SA)

Revision Record			
Version	Description	Date	Remark
00	Original	2025-11-26	/
01	Updated EUT name	2026-01-23	Amendment

Remark: This report supersedes our previous report SHEM250900612401, issued on 2025-11-26, which is hereby deemed null and void.

Authorized for issue by:			
Tested By	<i>Andy Yang</i>		

	Andy Yang/Project Engineer		
Approved By	<i>Parlam zhan</i>		

	Parlam Zhan / Reviewer		

2 Test Summary

Emission Part				
Item	Standard	Method	Requirement	Result
Conducted Emissions at AC Mains Power Port (150kHz-30MHz)	EN IEC 55014-1: 2021	CISPR 16-2-1: 2014 +A1:2017	Table 5	Pass
Conducted Emissions at Load Terminals and Additional Terminals		CISPR 16-2-1: 2014 +A1:2017	Table 5	Pass
Discontinuous Disturbance (150kHz-30MHz)		EN IEC 55014-1: 2021	Clause 4.4.2	Pass
Disturbance Power		CISPR 16-2-2: 2010	Table 7 & 8	Pass
Harmonic Current Emission	EN IEC 61000-3-2: 2019 +A1:2021 +A2:2024	EN IEC 61000-3-2: 2019 +A1:2021 +A2:2024	Class A	Pass
Voltage Fluctuations and Flicker	EN 61000-3-3: 2013 +A1:2019 +A2:2021	EN 61000-3-3: 2013 +A1:2019 +A2:2021	Clause 5	Pass

Immunity Part				
Item	Standard	Method	Requirement	Result
Electrostatic Discharge	EN IEC 55014-2: 2021	EN 61000-4-2: 2009	4kV Contact Discharge, 8kV Air Discharge	Pass
Radiated Immunity (80MHz-1GHz)		EN IEC 61000-4-3: 2020	3V/m, 80%, 1kHz Amp. Mod.	Pass
Electrical Fast Transients Burst at AC Mains Power Port		EN 61000-4-4: 2012	1kV, 5/50ns Tr/Td, 5kHz Repetition Frequency	Pass
Electrical Fast Transients Burst at Signal Port		EN 61000-4-4: 2012	0.5kV, 5/50ns Tr/Td, 5kHz Repetition Frequency	Pass
Surge at AC Mains Power Port		EN 61000-4-5: 2014 +A1:2017	1.2/50µs Tr/Td, 1kV Line to Line, 2kV Line to Ground	Pass
Conducted Immunity at AC Mains Power Port (150kHz-80MHz)		EN 61000-4-6: 2014	3Vrms (emf), 80%, 1kHz Amp. Mod.	Pass
Conducted Immunity at Signal Port (150kHz-80MHz)		EN 61000-4-6: 2014	1Vrms (emf), 80%, 1kHz Amp. Mod.	Pass
Voltage Dips and Interruptions		EN IEC 61000-4-11: 2020	For 50Hz: 0 % UT for 0.5cycle, 40 % UT for 10cycles, 70 % UT for 25cycles, UT is Supply Voltage	Pass

Note: There are series models mentioned in this report and they are the similar in electrical and electronic characters. Only the model KFR-30GW/BpH3-100 was tested since their differences were model number and appearance.

3 Contents

	Page
1 COVER PAGE	1
2 Test Summary	3
3 Contents	4
4 General Information	6
4.1 Details of E.U.T.	6
4.2 Description of Support Units.....	6
4.3 Measurement Uncertainty & Decision Rule.....	6
4.4 Test Location	7
4.5 Test Facility	7
4.6 Deviation from Standards	7
4.7 Abnormalities from Standard Conditions	7
4.8 EMS Monitor	7
5 Equipment List	8
6 Emission Test Results	13
6.1 Conducted Emissions at AC Mains Power Port (150kHz-30MHz)	13
6.1.1 E.U.T. Operation	13
6.1.2 Test Mode Description	13
6.1.3 Test Setup Diagram	13
6.1.4 Measurement Procedure and Data	14
6.2 Conducted Emissions at Load Terminals and Additional Terminals	17
6.2.1 E.U.T. Operation	17
6.2.2 Test Mode Description	17
6.2.3 Test Setup Diagram	17
6.2.4 Measurement Procedure and Data	18
6.3 Discontinuous Disturbance (150kHz-30MHz).....	20
6.3.1 E.U.T. Operation	20
6.3.2 Test Mode Description	20
6.3.3 Test Setup Diagram	21
6.3.4 Measurement Procedure and Data	21
6.4 Disturbance Power	22
6.4.1 E.U.T. Operation	22
6.4.2 Test Mode Description	22
6.4.3 Test Setup Diagram	22
6.4.4 Measurement Procedure and Data	22
6.5 Harmonic Current Emission.....	24
6.5.1 E.U.T. Operation	24
6.5.2 Test Mode Description	24
6.5.3 Test Setup Diagram	24
6.5.4 Measurement Procedure and Data	24
6.6 Voltage Fluctuations and Flicker	27
6.6.1 E.U.T. Operation	27
6.6.2 Test Mode Description	27
6.6.3 Test Setup Diagram	27
6.6.4 Measurement Procedure and Data	27
7 Immunity Test Results	28
7.1 Electrostatic Discharge	29
7.1.1 Test Setup Diagram	29
7.1.2 E.U.T. Operation	29

7.1.3	Test Mode Description	29
7.1.4	Test Condition and Results:	30
7.2	Radiated Immunity (80MHz-1GHz)	31
7.2.1	Test Setup Diagram	31
7.2.2	E.U.T. Operation	31
7.2.3	Test Mode Description	31
7.2.4	Test Condition and Results:	31
7.3	Electrical Fast Transients Burst at AC Mains Power Port	32
7.3.1	Test Setup Diagram	32
7.3.2	E.U.T. Operation	32
7.3.3	Test Mode Description	32
7.3.4	Test Condition and Results:	32
7.4	Electrical Fast Transients Burst at Signal Port	33
7.4.1	Test Setup Diagram	33
7.4.2	E.U.T. Operation	33
7.4.3	Test Mode Description	33
7.4.4	Test Condition and Results:	33
7.5	Surge at AC Mains Power Port	34
7.5.1	Test Setup Diagram	34
7.5.2	E.U.T. Operation	34
7.5.3	Test Mode Description	34
7.5.4	Test Condition and Results:	35
7.6	Conducted Immunity at AC Mains Power Port (150kHz-80MHz)	36
7.6.1	Test Setup Diagram	36
7.6.2	E.U.T. Operation	36
7.6.3	Test Mode Description	36
7.6.4	Test Condition and Results:	36
7.7	Conducted Immunity at Signal Port (150kHz-80MHz)	37
7.7.1	Test Setup Diagram	37
7.7.2	E.U.T. Operation	37
7.7.3	Test Mode Description	37
7.7.4	Test Condition and Results:	37
7.8	Voltage Dips and Interruptions	38
7.8.1	Test Setup Diagram	38
7.8.2	E.U.T. Operation	38
7.8.3	Test Mode Description	38
7.8.4	Test Condition and Results:	39
8	Test Setup Photo	40
9	EUT Constructional Details (EUT Photos)	47

4 General Information

4.1 Details of E.U.T.

Power supply:	AC 220-240V 50Hz Test Voltage: AC 230V 50Hz Maximum clock frequency: 8 MHz
Cable(s):	AC cable 1.8m Signal cable 5m

4.2 Description of Support Units

Description	Manufacturer	Model No.	Serial No.
--	--	--	--

The EUT has been tested as an independent unit.

4.3 Measurement Uncertainty & Decision Rule

Measurement Uncertainty:

No.	Item	Measurement Uncertainty (U_{Lab})	U_{CISPR}
1	Conducted Emission at mains port using AMN	3.4dB (9kHz to 150kHz)	3.8dB (9kHz to 150kHz)
		2.9dB (150kHz to 30MHz)	3.4dB (150kHz to 30MHz)
2	Conducted Emission at mains port using VP	2.2dB (9kHz to 30MHz)	2.9dB (9kHz to 30MHz)
3	Conducted Emission at telecommunication port using AAN	4.6dB (150kHz to 30MHz)	5.0dB (150kHz to 30MHz)
4	Radiated Power	3.4dB (30MHz to 300MHz)	4.5dB (30MHz to 300MHz)
5	Radiated emission	5.7dB (30MHz-1GHz)	6.3dB (30MHz-1GHz)
		4.8dB (1GHz-6GHz)	5.2dB (1GHz-6GHz)
		5.0dB (6GHz-18GHz)	5.5dB (6GHz-18GHz)
6	Radiated disturbance (disturbance current in a LLAS)	2.6dB (9kHz to 30MHz)	3.3dB (9kHz to 30MHz)

Note: The measurement uncertainty represents an expanded uncertainty expressed at approximately the 95% confidence level using a coverage factor of k=2.

Decision Rule:

- CISPR 16-4-2 for emission measurements is as below described.

Pass means the test result passed the test standard requirement, please find the detailed decision rule in the report relative section.

U_{LAB} less than U_{CISPR} , therefore:

- compliance is deemed to occur if no measured disturbance level exceeds the disturbance limit;
- non-compliance is deemed to occur if any measured disturbance level exceeds the disturbance limit.

4.4 Test Location

All tests were performed at:

SGS-CSTC Standards Technical Services (Shanghai) Co., Ltd. E&E Lab

588 West Jindu Road, Xinqiao, Songjiang, 201612 Shanghai, China

Tel: +86 21 6191 5666 Fax: +86 21 6191 5678

No tests were sub-contracted.

Note:

1. SGS is not responsible for wrong test results due to incorrect information (e.g., max. internal working frequency, antenna gain, cable loss, etc) is provided by the applicant. (If applicable).
2. SGS is not responsible for the authenticity, integrity and the validity of the conclusion based on results of the data provided by applicant. (If applicable).
3. Sample source: sent by customer.

4.5 Test Facility

The test facility is recognized, certified, or accredited by the following organizations:

• **A2LA (Certificate No. 6332.01)**

SGS-CSTC Standards Technical Services (Shanghai) Co., Ltd. is accredited by the American Association for Laboratory Accreditation(A2LA).

• **FCC (Designation Number: CN1301)**

SGS-CSTC Standards Technical Services (Shanghai) Co., Ltd. has been recognized as an accredited testing laboratory.

• **ISED (CAB Identifier: CN0020)**

SGS-CSTC Standards Technical Services (Shanghai) Co., Ltd. EMC Laboratory has been recognized by Innovation, Science and Economic Development Canada (ISED) as an accredited testing laboratory.
Company Number: 8617A

• **VCCI (Member No.: 3061)**

The 3m Semi-anechoic chamber and Shielded Room of SGS-CSTC Standards Technical Services (Shanghai) Co., Ltd. has been registered in accordance with the Regulations for Voluntary Control Measures with Registration No.: R-13868, C-14336, T-12221, G-10830 respectively.

4.6 Deviation from Standards

None

4.7 Abnormalities from Standard Conditions

None

4.8 EMS Monitor

Visual: Working status of EUT.

5 Equipment List

Conducted Emissions at AC Mains Power Port (150kHz-30MHz)					
Equipment	Manufacturer	Model No.	Inventory No.	Cal Date	Cal Due Date
EMI test receiver	Rohde & Schwarz	ESR7	SHEM162-1	2024/12/18	2025/12/17
Line impedance stabilization network	SCHWARZBECK	NSLK8127	SHEM061-1	2024/12/18	2025/12/17
Line impedance stabilization network	EMCO	3816_2	SHEM019-1	2024/12/18	2025/12/17
Pulse limiter	Rohde & Schwarz	ESH3-Z2	SHEM029-1	2024/12/18	2025/12/17
Shielding Room	ZHONGYU	8*4*3M	SHEM079-2	2023/12/19	2026/12/18
CE test Cable	/	9kHz-30MHz	SHEM172-2	2024/12/18	2025/12/17
Passive Voltage probe	Rohde & Schwarz	ESH2-Z3	SHEM028-2	2024/12/18	2025/12/17
Capacitive Voltage Probe	SCHWARZBECK	CVP9222 B	SHEM169-1	2025/07/30	2026/07/29
Current Probe	SCHWARZBECK	SW9605	SHEM170-1	2025/07/30	2026/07/29
Test Software	ESE	e3	Version: 6.191211	N/A	N/A
3 Phase LISN	SCHWARZBECK	NNLK 8129 RC	SHME035-4	2025/09/19	2026/09/18
3 Phase LISN	Beijing Kehuan	KH3765-100	SHEM292-1	2025/07/30	2026/07/29

Conducted Emissions at Load Terminals and Additional Terminals					
Equipment	Manufacturer	Model No.	Inventory No.	Cal Date	Cal Due Date
EMI test receiver	Rohde & Schwarz	ESR7	SHEM162-1	2024/12/18	2025/12/17
Line impedance stabilization network	SCHWARZBECK	NSLK8127	SHEM061-1	2024/12/18	2025/12/17
Line impedance stabilization network	EMCO	3816_2	SHEM019-1	2024/12/18	2025/12/17
Pulse limiter	Rohde & Schwarz	ESH3-Z2	SHEM029-1	2024/12/18	2025/12/17
Shielding Room	ZHONGYU	8*4*3M	SHEM079-2	2023/12/19	2026/12/18
CE test Cable	/	9kHz-30MHz	SHEM172-2	2024/12/18	2025/12/17
Passive Voltage probe	Rohde & Schwarz	ESH2-Z3	SHEM028-2	2024/12/18	2025/12/17
Capacitive Voltage Probe	SCHWARZBECK	CVP9222 B	SHEM169-1	2025/07/30	2026/07/29
Current Probe	SCHWARZBECK	SW9605	SHEM170-1	2025/07/30	2026/07/29
Test Software	ESE	e3	Version: 6.191211	N/A	N/A

Discontinuous Disturbance (150kHz-30MHz)					
Equipment	Manufacturer	Model No.	Inventory No.	Cal Date	Cal Due Date
Click analyzer	SCHAFFNER	DIA1512D	SHEM013-1	2024/12/18	2025/12/17
Line impedance stabilization network	SCHWARZBECK	NSLK8127	SHEM061-1	2024/12/18	2025/12/17
Line impedance stabilization network	EMCO	3816_2	SHEM019-1	2024/12/18	2025/12/17
Shielding Room	ZHONGYU	8*4*3M	SHEM079-2	2023/12/19	2026/12/18
Test Software	SCHAFFNER	DIS9966	Version: 2.5	N/A	N/A

Disturbance Power					
Equipment	Manufacturer	Model No.	Inventory No.	Cal Date	Cal Due Date
EMI test receiver	Rohde & Schwarz	ESR7	SHEM162-1	2024/12/18	2025/12/17
Absorbing clamp	LUTHI	MDS21	SHEM014-1	2024/12/18	2025/12/17
DE coupling clamp	LUTHI	FTC101	SHEM027-2	N/A	N/A
Attenuator	HUAXIANG	TS2-6dB-2G-B	SHEM208-1	2024/12/18	2025/12/17
Shielding Room	ZHONGYU	8*4*3M	SHEM079-2	2023/12/19	2026/12/18
DP test Cable	/	30MHz-300MHz	SHEM179-1	2024/12/18	2025/12/17
Test Software	ESE	e3	Version: 6.191211	N/A	N/A

Harmonic Current Emission					
Equipment	Manufacturer	Model No.	Inventory No.	Cal Date	Cal Due Date
Harmonic&Flicker analyzer	AMETEK	PACS-1	SHEM024-2	2025/07/30	2026/07/29
AC Power Source 5KVA	AMETEK	5001iX	SHEM025-2	2025/07/30	2026/07/29
Test Software	AMETEK	CTS4	Version: 4.29.0	N/A	N/A
Harmonic&Flicker analyzer	EM TEST	DPA500	SHEM024-1	2025/07/30	2026/07/29
AC Power Source 6KVA	EM TEST	ACS500	SHEM025-1	2025/07/30	2026/07/29
Test Software	EM TEST	DPA	Version: 5.1.4	N/A	N/A
Harmonic & Flicker test system	DEWETRON	DEWE2-A4	SHEM274-1	2025/07/30	2026/07/29

Voltage Fluctuations and Flicker					
Equipment	Manufacturer	Model No.	Inventory No.	Cal Date	Cal Due Date
Harmonic&Flicker analyzer	AMETEK	PACS-1	SHEM024-2	2025/07/30	2026/07/29
AC Power Source 5KVA	AMETEK	5001iX	SHEM025-2	2025/07/30	2026/07/29
Test Software	AMETEK	CTS4	Version: 4.29.0	N/A	N/A
Harmonic&Flicker analyzer	EM TEST	DPA500	SHEM024-1	2025/07/30	2026/07/29
AC Power Source 6KVA	EM TEST	ACS500	SHEM025-1	2025/07/30	2026/07/29
Test Software	EM TEST	DPA	Version: 5.1.4	N/A	N/A
Harmonic & Flicker test system	DEWETRON	DEWE2-A4	SHEM274-1	2025/07/30	2026/07/29

Electrostatic Discharge					
Equipment	Manufacturer	Model No.	Inventory No.	Cal Date	Cal Due Date
Electrostatic Discharge Simulator	TESEQ	NSG 437	SHEM041-2	2025/07/30	2026/07/29
Electrostatic Discharge Simulator	3CTEST	EDS20H	SHEM199-1	2024/12/18	2025/12/17
Electrostatic discharge simulator	EM TEST	ditto	SHEM289-1	2025/02/10	2026/02/09

Radiated Immunity (80MHz-1GHz)					
Equipment	Manufacturer	Model No.	Inventory No.	Cal Date	Cal Due Date
Signal generator	Rohde & Schwarz	SMB100A	SHEM194-1	2024/12/18	2025/12/17
Power Meter	Rohde & Schwarz	NRP	SHEM057-1	2025/07/30	2026/07/29
Power meter sensor	Rohde & Schwarz	NRP-Z91	SHEM057-4	2025/07/30	2026/07/29
Antenna	SCHWARZBECK	STLP9128D	SHEM130-1	N/A	N/A
Amplifier	MILMEGA	80RF1000-250	SHEM132-1	2024/12/18	2025/12/17
ElectroMagnetic Field Probe	ETS-Lindgren	HI-6105	SHEM134-1	2025/08/05	2026/08/04
Semi/Fully Anechoic	ST	11*6*6M	SHEM078-2	2023/05/06	2026/05/05
Test Software	Rohde & Schwarz	EMC32	Version: 10.20.01	N/A	N/A
Power meter sensor	Rohde & Schwarz	NRP-Z91	SHEM057-5	2024/12/18	2025/12/17

Electrical Fast Transients Burst at AC Mains Power Port					
Equipment	Manufacturer	Model No.	Inventory No.	Cal Date	Cal Due Date
Immunity Test System	EMC PARTNER	TRA3000 F-S-D-V	SHEM163-1	2024/12/18	2025/12/17
Test Software	EMC-PARTNER	GENECS	Version: 3.29	N/A	N/A
Immunity Test System	TESEQ	NSG 3060	SHEM224-1	2025/07/30	2026/07/29
Coupling / Decoupling Network (CDN)	TESEQ	CDN 3061	SHEM224-3	2025/07/30	2026/07/29
EFT & Surge Generator	PRIMA	PRM61045TB	SHEM200-1	2025/09/23	2026/09/22
CDN for EFT & Surge	PRIMA	PRM-CDN	SHEM200-2	2025/09/23	2026/09/22

Electrical Fast Transients Burst at Signal Port					
Equipment	Manufacturer	Model No.	Inventory No.	Cal Date	Cal Due Date
Immunity Test System	EMC PARTNER	TRA3000 F-S-D-V	SHEM163-1	2024/12/18	2025/12/17
Test Software	EMC-PARTNER	GENECS	Version: 3.29	N/A	N/A
Immunity Test System	TESEQ	NSG 3060	SHEM224-1	2025/07/30	2026/07/29
Coupling / Decoupling Network (CDN)	TESEQ	CDN 3061	SHEM224-3	2025/07/30	2026/07/29
Capacitive Coupling Clamp	EM TEST	HFK	SHEM026-2	2024/12/18	2025/12/17
EFT & Surge Generator	PRIMA	PRM61045TB	SHEM200-1	2025/09/23	2026/09/22
CDN for EFT & Surge	PRIMA	PRM-CDN	SHEM200-2	2025/09/23	2026/09/22
Capacitive coupling clamp	PRIMA	EFT-CLAMP	SHEM200-4	2024/12/18	2025/12/17

Surge at AC Mains Power Port					
Equipment	Manufacturer	Model No.	Inventory No.	Cal Date	Cal Due Date
Immunity Test System	EMC PARTNER	TRA3000 F-S-D-V	SHEM163-1	2024/12/18	2025/12/17
Test Software	EMC-PARTNER	GENECS	Version: 3.29	N/A	N/A
Immunity Test System	TESEQ	NSG 3060	SHEM224-1	2025/07/30	2026/07/29
Coupling / Decoupling	TESEQ	CDN 3061	SHEM224-3	2025/07/30	2026/07/29

Network (CDN)					
EFT & Surge Generator	PRIMA	PRM61045TB	SHEM200-1	2025/09/23	2026/09/22
CDN for EFT & Surge	PRIMA	PRM-CDN	SHEM200-2	2025/09/23	2026/09/22
CDN for unsymmetrical interconnection lines (1.2/50us)	SCHAFFNER	CDN 117	SHEM224-5	2025/07/30	2026/07/29
CDN for symmetric datalines & Resistor network (Surge 1.2/50 or 10/700 us)	SCHAFFNER	CDN 118 & INA172	SHEM224-6 & SHEM224-7	2025/07/30	2026/07/29

Conducted Immunity at AC Mains Power Port (150kHz-80MHz)					
Equipment	Manufacturer	Model No.	Inventory No.	Cal Date	Cal Due Date
Signal generator	Rohde & Schwarz	SMB100A	SHEM194-1	2024/12/18	2025/12/17
Power Amplifier	HAEFFLY	PAMP250	SHEM023-1	2024/12/18	2025/12/17
6dB Attenuator	HUAXIANG	DTS50-6dB-1G-A	SHEM123-2	2024/12/18	2025/12/17
Power Meter	Rohde & Schwarz	NRP	SHEM057-1	2025/07/30	2026/07/29
Power meter sensor	Rohde & Schwarz	NRP-Z91	SHEM057-4	2025/07/30	2026/07/29
Coupling and Decoupling Network (CDN)	LUTHI	L-801 M2/M3	SHEM023-6	2024/12/18	2025/12/17
Shielding Room	ZHONGYU	5*3*3M	SHEM079-6	2022/12/20	2025/12/19
Coupling and Decoupling Network	Teseq	CDN M016	SHEM168-1	2025/07/30	2026/07/29
Test Software	Rohde & Schwarz	EMC32	Version: 10.20.01	N/A	N/A
CDN	TESEQ	CDN M532	SHEM250-3	2024/12/18	2025/12/17
Power meter sensor	Rohde & Schwarz	NRP-Z91	SHEM057-5	2024/12/18	2025/12/17
Current Injection Probe	PRANA	IP-DR250	SHEM273-1	2024/12/18	2025/12/17
Test System for Conducted Immunity	TESEQ	NSG 4070	SHEM295-1	2024/12/18	2025/12/17

Conducted Immunity at Signal Port (150kHz-80MHz)					
Equipment	Manufacturer	Model No.	Inventory No.	Cal Date	Cal Due Date
Signal generator	Rohde & Schwarz	SMB100A	SHEM194-1	2024/12/18	2025/12/17
Power Amplifier	HAEFFLY	PAMP250	SHEM023-1	2024/12/18	2025/12/17
6dB Attenuator	HUAXIANG	DTS50-6dB-1G-A	SHEM123-2	2024/12/18	2025/12/17
Coupling clamp	LUTHI	EM 101	SHEM027-1	2025/04/30	2026/04/29
Power Meter	Rohde & Schwarz	NRP	SHEM057-1	2025/07/30	2026/07/29
Power meter sensor	Rohde & Schwarz	NRP-Z91	SHEM057-4	2025/07/30	2026/07/29
Coupling and Decoupling Network (CDN)	LUTHI	L-801 M2/M3	SHEM023-6	2024/12/18	2025/12/17
Shielding Room	ZHONGYU	5*3*3M	SHEM079-6	2022/12/20	2025/12/19
Coupling and Decoupling Network	Teseq	CDN M016	SHEM168-1	2025/07/30	2026/07/29
Test Software	Rohde & Schwarz	EMC32	Version:	N/A	N/A

			10.20.01		
Power meter sensor	Rohde & Schwarz	NRP-Z91	SHEM057-5	2024/12/18	2025/12/17
Current Injection Probe	PRANA	IP-DR250	SHEM273-1	2024/12/18	2025/12/17
Test System for Conducted Immunity	TESEQ	NSG 4070	SHEM295-1	2024/12/18	2025/12/17

Voltage Dips and Interruptions					
Equipment	Manufacturer	Model No.	Inventory No.	Cal Date	Cal Due Date
Immunity Test System	EMC PARTNER	TRA3000 F-S-D-V	SHEM163-1	2024/12/18	2025/12/17
Test Software	EMC-PARTNER	GENECS	Version: 3.29	N/A	N/A
Immunity Test System	TESEQ	NSG 3060	SHEM224-1	2025/07/30	2026/07/29
Coupling / Decoupling Network (CDN)	TESEQ	CDN 3061	SHEM224-3	2025/07/30	2026/07/29
Manual step transformer	TESEQ	INA 6501	SHEM224-4	2025/07/30	2026/07/29
3 phase voltage dips & interruptions simulator	LIONCEL	VDS-1132A & TGL-332	SHME143-1~SHME143-4	2025/04/30	2026/04/29

General used equipment					
Equipment	Manufacturer	Model No.	Inventory No.	Cal Date	Cal Due Date
Atmospheric Pressure Meter	Nanjing XiangRuiDe	DYM3	SHEM082-2	2024/01/18	2027/01/17
Temperature&humidity recorder	ShangHai weather meter work	ZJ 1-2B	SHEM042-9~10	2024/12/22	2025/12/21
Temperature&humidity recorder	ShangHai weather meter work	ZJ 1-2B	SHEM042-5	2025/07/09	2026/07/08
Digital Temperature& humidity recorder	Jianda Renke	RS-WS-N01-6J	SHEM247-1~8	2025/01/06	2026/01/05
Digital Multimeter	FLUKE	17B+	SHEM271-7	2025/07/07	2026/07/06
AC Power Supply	APC	KDF-31020T-V0-F0-IO	SHEM216-1	2024/12/18	2025/12/17
DC Power Supply	HP	6010A	SHEM222-1	2024/12/18	2025/12/17
Multi-purpose tong tester	FLUKE	317	SHEM001-2	2025/10/23	2026/10/22

6 Emission Test Results

6.1 Conducted Emissions at AC Mains Power Port (150kHz-30MHz)

Test Requirement: EN IEC 55014-1: 2021
 Test Method: CISPR 16-2-1: 2014 +A1:2017

Limit:
 0.15M-0.5MHz 66dB(μV)-56dB(μV) quasi-peak, 59dB(μV)-46dB(μV) average
 0.5M-5MHz 56dB(μV) quasi-peak, 46dB(μV) average
 5M-30MHz 60dB(μV) quasi-peak, 50dB(μV) average
 Detector: Peak for pre-scan (9kHz resolution bandwidth) 0.15M to 30MHz

6.1.1 E.U.T. Operation

Operating Environment:
 Temperature: 25 °C Humidity: 56 % RH Atmospheric Pressure: 1010 mbar

6.1.2 Test Mode Description

Pre-scan / Final test	Mode Code	Description
Final test	00	Test the EUT in cooling mode, keep swinging at high speed, and adjust the EUT temperature at the lowest temperature position.
Pre-scan	01	Test the EUT in heating mode, keep swinging at high speed, and adjust the EUT temperature at the highest temperature position.
Pre-scan	02	Test the EUT in dehumidification mode.
Pre-scan	03	Test the EUT in fan mode, keep swinging at high speed.
Pre-scan	04	Test the EUT in idle mode.

6.1.3 Test Setup Diagram

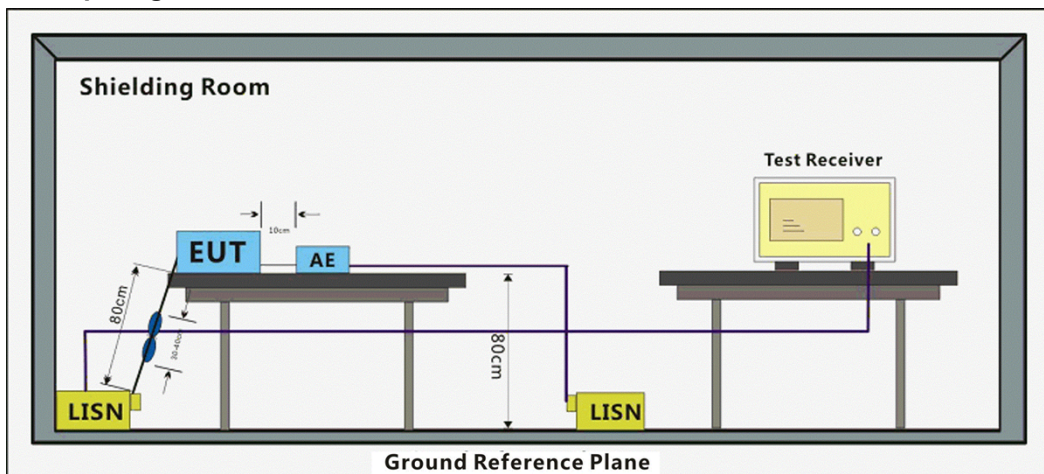



SGS-CSTC Standards Technical Services (Shanghai) Co., Ltd.

SHEM-TRF-001 Rev. 02 Sep01, 2023

Report No.: SHEM250900612401V01

Page: 14 of 47

6.1.4 Measurement Procedure and Data

Frequency Range: 150kHz to 30MHz

An initial pre-scan was performed with peak detector. Quasi-Peak or Average measurement were performed at the frequencies with maximized peak emission were detected. The red line show in graphic is the limit in standard used in this section.

Measured Level = Read level + Cable Loss + LISN Factor

Test Mode: 00; Line: Live line

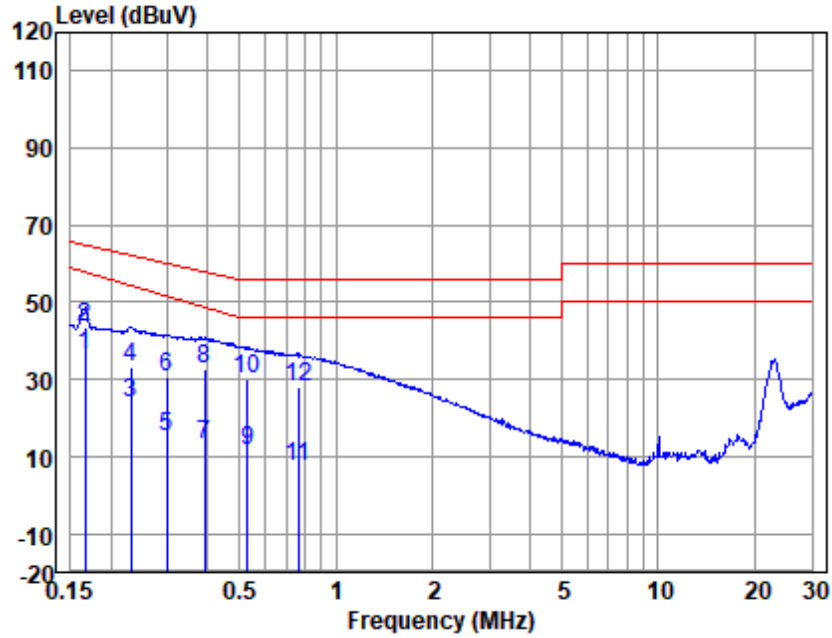

LISN : LINE
 EUT/Project No : 6124HS
 Test Mode : 00

	Freq (MHz)	Read level (dBuV)	LISN Factor (dB)	Cable Loss (dB)	Emission Level (dBuV)	Limit (dBuV)	Over Limit (dB)	Remark
1	0.17	25.84	0.50	9.90	36.24	57.91	-21.67	Average
2	0.17	32.97	0.50	9.90	43.37	65.16	-21.79	QP
3	0.23	13.77	0.47	9.90	24.14	54.37	-30.23	Average
4	0.23	22.75	0.47	9.90	33.12	62.44	-29.32	QP
5	0.30	4.72	0.41	9.90	15.03	51.56	-36.53	Average
6	0.30	20.32	0.41	9.90	30.63	60.28	-29.65	QP
7	0.39	2.98	0.35	9.90	13.23	48.65	-35.42	Average
8	0.39	22.25	0.35	9.90	32.50	58.03	-25.53	QP
9	0.53	1.34	0.30	9.90	11.54	46.00	-34.46	Average
10	0.53	19.90	0.30	9.90	30.10	56.00	-25.90	QP
11	0.76	-2.84	0.30	9.90	7.36	46.00	-38.64	Average
12	0.76	17.59	0.30	9.90	27.79	56.00	-28.21	QP

Notes1: Emission Level = Read Level + LISN Factor + Cable loss

Notes2: Average in Remark means CISPR AV detector

Test Mode: 00; Line: Neutral Line

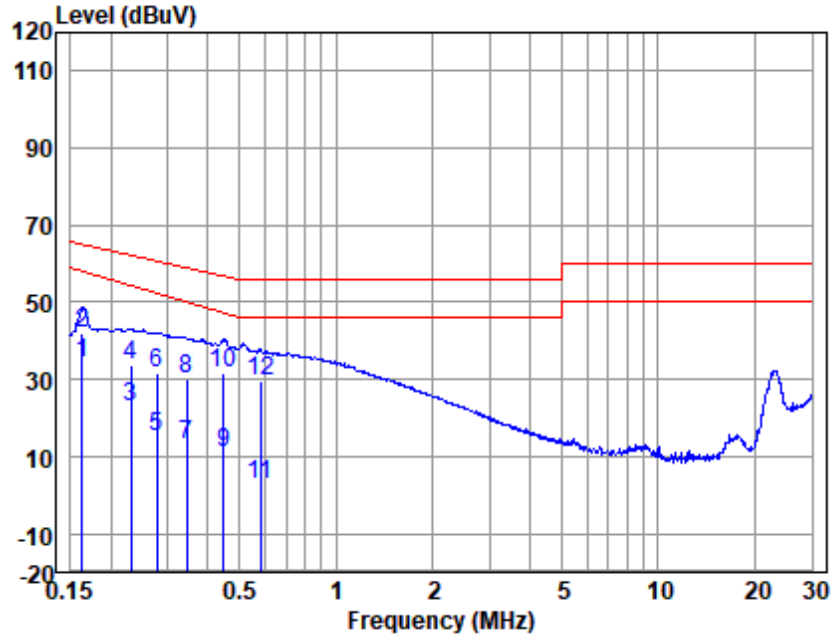

LISN : NEUTRAL
 EUT/Project No : 6124HS
 Test Mode : 00

	Freq (MHz)	Read level (dBuV)	LISN Factor (dB)	Cable Loss (dB)	Emission Level (dBuV)	Limit (dBuV)	Over Limit (dB)	Remark
1	0.16	24.02	0.43	9.90	34.35	58.08	-23.73	Average
2	0.16	31.52	0.43	9.90	41.85	65.30	-23.45	QP
3	0.23	12.35	0.40	9.90	22.65	54.37	-31.72	Average
4	0.23	23.50	0.40	9.90	33.80	62.44	-28.64	QP
5	0.28	4.98	0.40	9.90	15.28	52.31	-37.03	Average
6	0.28	21.37	0.40	9.90	31.67	60.85	-29.18	QP
7	0.34	2.86	0.40	9.90	13.16	50.02	-36.86	Average
8	0.34	19.67	0.40	9.90	29.97	59.09	-29.12	QP
9	0.45	0.82	0.40	9.90	11.12	47.16	-36.04	Average
10	0.45	21.24	0.40	9.90	31.54	56.89	-25.35	QP
11	0.58	-7.45	0.35	9.90	2.80	46.00	-43.20	Average
12	0.58	19.22	0.35	9.90	29.47	56.00	-26.53	QP

Notes1: Emission Level = Read Level + LISN Factor + Cable loss

Notes2: Average in Remark means CISPR AV detector

6.2 Conducted Emissions at Load Terminals and Additional Terminals

Test Requirement: EN IEC 55014-1: 2021
 Test Method: CISPR 16-2-1: 2014 +A1:2017

Limit:

Disturbance voltage limits

0.15MHz – 0.5MHz 80dB(μV) quasi-peak, 70dB(μV) average

0.5MHz – 30MHz 74dB(μV) quasi-peak, 64dB(μV) average

Detector: Peak for pre-scan (9kHz resolution bandwidth) 0.15MHz to 30MHz

Disturbance current limits

0.15MHz – 0.5MHz 40dB(μA)-30dB(μA) quasi-peak

30dB(μA)-20dB(μA) average

0.5MHz – 30MHz 30dB(μA) quasi-peak, 20dB(μA) average

Detector: Peak for pre-scan (9kHz resolution bandwidth) 0.15MHz to 30MHz

6.2.1 E.U.T. Operation

Operating Environment:

Temperature: 24 °C Humidity: 56 % RH Atmospheric Pressure: 1010 mbar

6.2.2 Test Mode Description

Pre-scan / Final test	Mode Code	Description
Final test	00	Test the EUT in cooling mode, keep swinging at high speed, and adjust the EUT temperature at the lowest temperature position.
Pre-scan	01	Test the EUT in heating mode, keep swinging at high speed, and adjust the EUT temperature at the highest temperature position.
Pre-scan	02	Test the EUT in dehumidification mode.
Pre-scan	03	Test the EUT in fan mode, keep swinging at high speed.
Pre-scan	04	Test the EUT in idle mode.

6.2.3 Test Setup Diagram

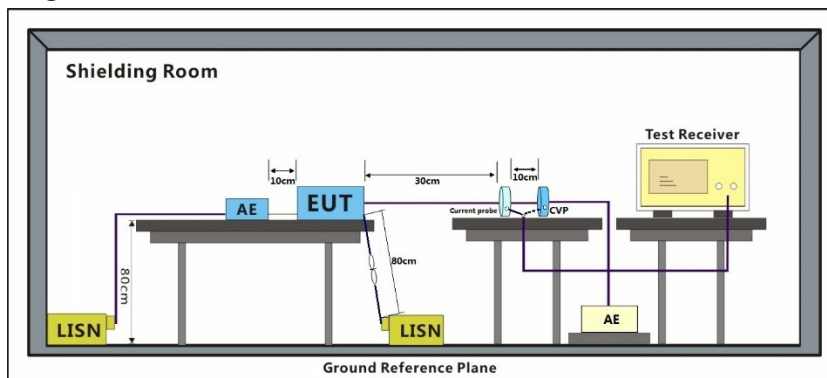



SGS-CSTC Standards Technical Services (Shanghai) Co., Ltd.

SHEM-TRF-001 Rev. 02 Sep01, 2023

Report No.: SHEM250900612401V01

Page: 18 of 47

6.2.4 Measurement Procedure and Data

Frequency Range: 150kHz to 30MHz

An initial pre-scan was performed with peak detector. Quasi-Peak or Average measurement were performed at the frequencies with maximized peak emission were detected. The red line show in graphic is the limit in standard used in this section.

Measured Level = Read level + Cable Loss + Probe Factor

Test Mode: 00

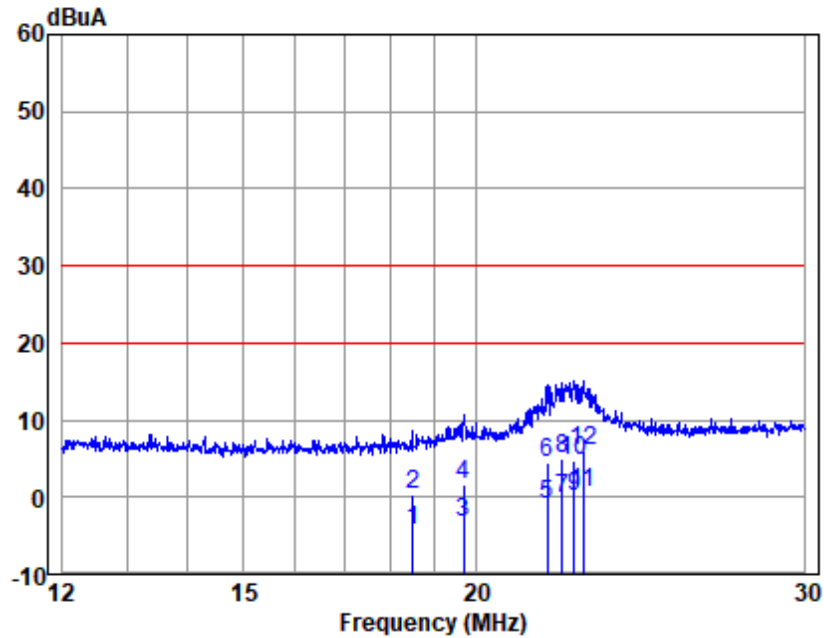

Current Probe : SW 9605

EUT/Project No : 6124HS

Test Mode : 00

	Freq (MHz)	Read level (dBuV)	SW Factor (dBS)	Cable Loss (dB)	Emission Level (dBuA)	Limit (dBuA)	Over Limit (dB)	Remark
1	18.49	-14.52	0.10	10.07	-4.35	20.00	-24.35	Average
2	18.49	-9.73	0.10	10.07	0.44	30.00	-29.56	QP
3	19.70	-13.53	0.10	10.09	-3.34	20.00	-23.34	Average
4	19.70	-8.69	0.10	10.09	1.50	30.00	-28.50	QP
5	21.85	-11.19	0.10	10.14	-0.95	20.00	-20.95	Average
6	21.85	-5.67	0.10	10.14	4.57	30.00	-25.43	QP
7	22.25	-10.40	0.10	10.15	-0.15	20.00	-20.15	Average
8	22.25	-5.29	0.10	10.15	4.96	30.00	-25.04	QP
9	22.58	-10.06	0.10	10.15	0.19	20.00	-19.81	Average
10	22.58	-5.46	0.10	10.15	4.79	30.00	-25.21	QP
11	22.83	-9.54	0.10	10.16	0.72	20.00	-19.28	Average
12	22.83	-4.31	0.10	10.16	5.95	30.00	-24.05	QP

Notes1: Emission Level = Read Level + SW Factor + Cable loss

Notes2: Average in Remark means CISPR AV detector

6.3 Discontinuous Disturbance (150kHz-30MHz)

Test Requirement: EN IEC 55014-1: 2021

Test Method: EN IEC 55014-1: 2021

Limit:

Provision	Click Rate (N)		
1	All clicks ≤ 20 ms	90 % click ≤ 10 ms	$N \leq 5$
2	$N < 0,2$	$L_q^b = L^a + 44$	Clicks $^c \leq 25\%$ exceed L_q^b
3	$30 > N \geq 0,2$	$L_q^b = L^a + 20 \lg(30/N)$	Clicks $^c \leq 25\%$ exceed L_q^b
<p>^a The limits L of Conducted Emissions apply also to discontinuous disturbances from all equipment which produce:</p> <p>1) disturbances other than clicks, or</p> <p>2) clicks with a click rate N equal to or greater than 30</p> <p>^b The click limit L_q is calculated by increasing the relevant quasi-peak limit L for continuous disturbances by certain value.</p> <p>The click limit applies to the disturbance assessed according to the upper quartile method</p> <p>^c a quarter of the number of the clicks registered during the observation time T is allowed to exceed the click limit L_q</p>			

6.3.1 E.U.T. Operation

Operating Environment:

Temperature: 25 °C Humidity: 56 % RH Atmospheric Pressure: 1010 mbar

6.3.2 Test Mode Description

Pre-scan / Final test	Mode Code	Description
Final test	00	Test the EUT in cooling mode, keep swinging at high speed, and adjust the EUT temperature at the lowest temperature position.
Pre-scan	01	Test the EUT in heating mode, keep swinging at high speed, and adjust the EUT temperature at the highest temperature position.
Pre-scan	02	Test the EUT in dehumidification mode.
Pre-scan	03	Test the EUT in fan mode, keep swinging at high speed.
Pre-scan	04	Test the EUT in idle mode.

6.3.3 Test Setup Diagram

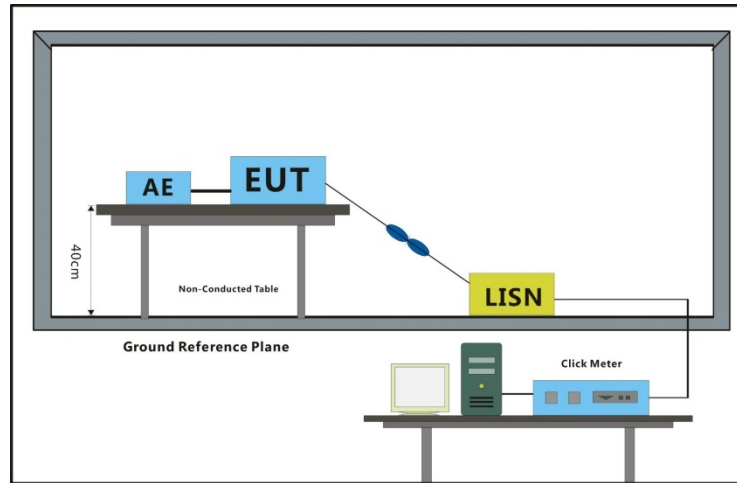

6.3.4 Measurement Procedure and Data

Frequency Range: 150kHz to 30MHz

Test Mode: 00

Run A Observation time T1= 120mins				
Switching Operation: -			Factor: -	
Frequency (MHz)	150kHz	500kHz	1.4MHz	30MHz
Limit value (L) (dB μ V)	66	56	56	60
Short clicks	0	0	0	0
long clicks	0	0	0	0
Total (short + long) n	0	0	0	0
Click Rate:	0.00	0.00	0.00	0.00
<input checked="" type="checkbox"/> EUT has a click rate N of not more than five and which has instantaneous switching (the duration of each click is less than 10ms) shall be deemed to comply the limits, independent of the amplitude of the clicks.				

6.4 Disturbance Power

Test Requirement: EN IEC 55014-1: 2021

Test Method: CISPR 16-2-2: 2010

Limit:

30MHz- 300MHz: 45dB(pW)-55dB(pW) quasi-peak, 35dB(pW)-45dB(pW) average

200MHz- 300MHz: 0dB(pW)-10dB(pW) quasi-peak (reduction limit)

Detector: Peak for pre-scan (120kHz resolution bandwidth) 30MHz to 300MHz

6.4.1 E.U.T. Operation

Operating Environment:

Temperature: 23 °C

Humidity: 56 % RH

Atmospheric Pressure: 1010 mbar

6.4.2 Test Mode Description

Pre-scan / Final test	Mode Code	Description
Final test	00	Test the EUT in cooling mode, keep swinging at high speed, and adjust the EUT temperature at the lowest temperature position.
Pre-scan	01	Test the EUT in heating mode, keep swinging at high speed, and adjust the EUT temperature at the highest temperature position.
Pre-scan	02	Test the EUT in dehumidification mode.
Pre-scan	03	Test the EUT in fan mode, keep swinging at high speed.
Pre-scan	04	Test the EUT in idle mode.

6.4.3 Test Setup Diagram

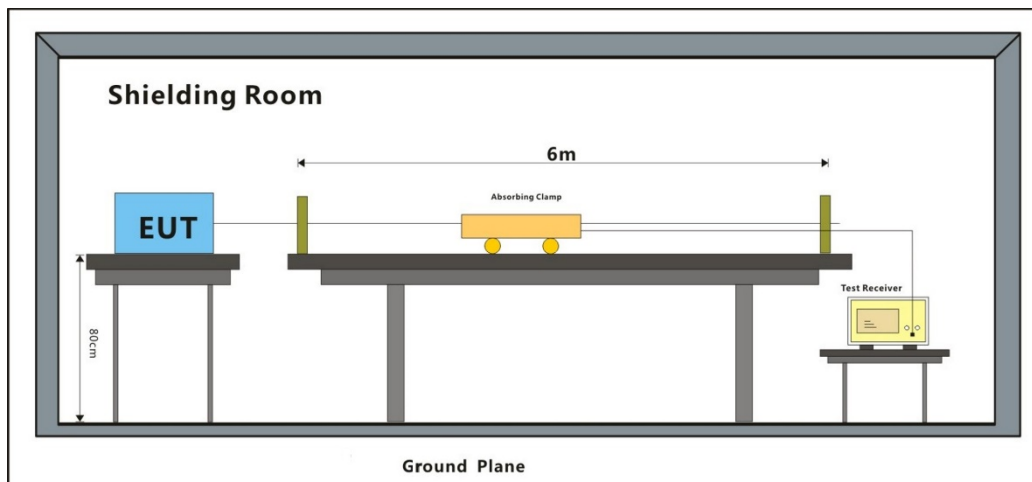

6.4.4 Measurement Procedure and Data

Frequency Range: 30MHz to 300MHz

An initial pre-scan was performed with peak detector. Quasi-Peak or Average measurement were performed at the frequencies with maximized peak emission were detected. The red line show in graphic is the limit in standard used in this section.

Measured Level = Read level + Cable Loss + Clamp Factor

Test Mode: 00

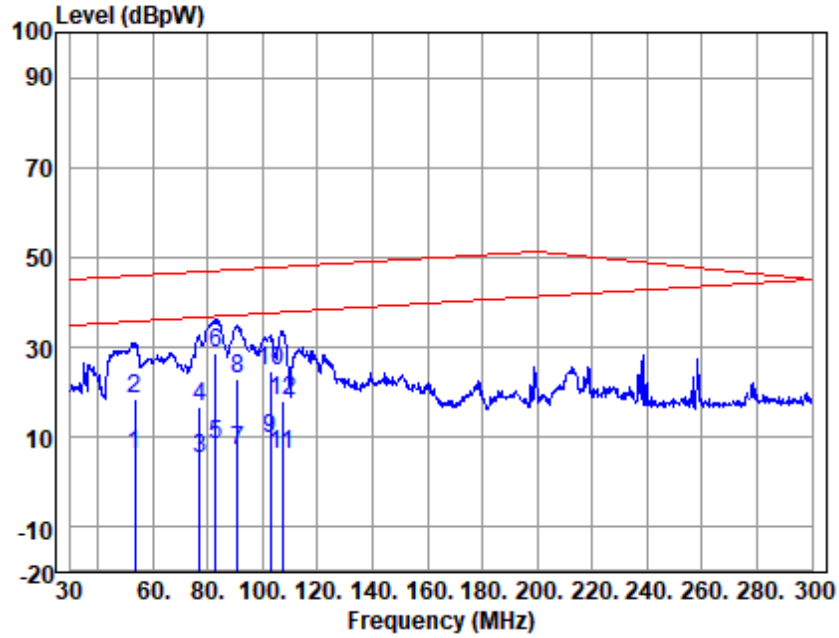

EUT/Project No : 6124HS

Test Mode : 00

	Freq (MHz)	Read level (dBpW)	Aux Factor (dB)	Cable Loss (dB)	Emission Level (dBpW)	Limit (dBpW)	Over Limit (dB)	Remark
1	53.49	-17.23	16.79	6.64	6.20	35.88	-29.68	Average
2	53.49	-4.73	16.79	6.64	18.70	45.88	-27.18	QP
3	76.98	-18.60	16.72	6.97	5.09	36.75	-31.66	Average
4	76.98	-6.97	16.72	6.97	16.72	46.75	-30.03	QP
5	82.65	-14.96	16.40	7.05	8.49	36.96	-28.47	Average
6	82.65	5.30	16.40	7.05	28.75	46.96	-18.21	QP
7	90.75	-16.43	16.45	7.21	7.23	37.26	-30.03	Average
8	90.75	-0.81	16.45	7.21	22.85	47.26	-24.41	QP
9	102.63	-15.00	17.21	7.32	9.53	37.70	-28.17	Average
10	102.63	0.31	17.21	7.32	24.84	47.70	-22.86	QP
11	107.22	-18.70	17.59	7.35	6.24	37.87	-31.63	Average
12	107.22	-6.82	17.59	7.35	18.12	47.87	-29.75	QP

Notes1: Emission Level = Read Level +Aux Factor + Cable loss

Notes2: Average in Remark means CISPR AV detector

6.5 Harmonic Current Emission

Test Requirement: EN IEC 61000-3-2: 2019 +A1:2021 +A2:2024

Test Method: EN IEC 61000-3-2: 2019 +A1:2021 +A2:2024

6.5.1 E.U.T. Operation

Operating Environment:

Temperature: 24.4 °C Humidity: 52 % RH Atmospheric Pressure: 1010 mbar

6.5.2 Test Mode Description

Pre-scan / Final test	Mode Code	Description
Final test	00	Test the EUT in cooling mode, keep swinging at high speed, and adjust the EUT temperature at the lowest temperature position.
Pre-scan	01	Test the EUT in heating mode, keep swinging at high speed, and adjust the EUT temperature at the highest temperature position.
Pre-scan	02	Test the EUT in dehumidification mode.
Pre-scan	03	Test the EUT in fan mode, keep swinging at high speed.
Pre-scan	04	Test the EUT in idle mode.

6.5.3 Test Setup Diagram

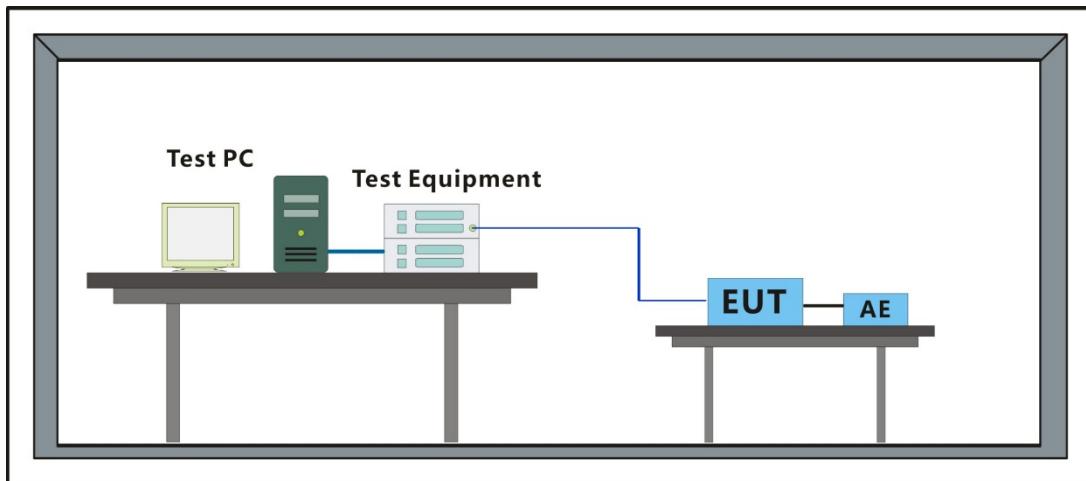

6.5.4 Measurement Procedure and Data

Frequency Range: 100Hz to 2kHz



SGS-CSTC Standards Technical Services (Shanghai) Co., Ltd.

SHEM-TRF-001 Rev. 02 Sep01, 2023

Report No.: SHEM250900612401V01

Page: 25 of 47

Test Mode: 00

Highest parameter values during test:

V_RMS (Volts):	230.32	Frequency(Hz):	50.00
I_Peak (Amps):	13.126	I_RMS (Amps):	7.731
I_Fund (Amps):	7.689	Crest Factor:	1.706
Power (Watts):	1767.5	Power Factor:	0.995

Harm#	Harms(avg)	100%Limit	%of Limit	Harms(max)	150%Limit	%of Limit	Status
2	0.030	1.080	N/A	0.036	1.620	N/A	Pass
3	0.352	2.300	15.3	0.363	3.450	10.5	Pass
4	0.033	0.430	N/A	0.037	0.645	N/A	Pass
5	0.026	1.140	N/A	0.033	1.710	N/A	Pass
6	0.030	0.300	N/A	0.033	0.450	N/A	Pass
7	0.083	0.770	10.8	0.086	1.155	7.5	Pass
8	0.017	0.230	N/A	0.019	0.345	N/A	Pass
9	0.042	0.400	N/A	0.046	0.600	N/A	Pass
10	0.013	0.184	N/A	0.015	0.276	N/A	Pass
11	0.036	0.330	N/A	0.039	0.495	N/A	Pass
12	0.013	0.153	N/A	0.016	0.230	N/A	Pass
13	0.037	0.210	N/A	0.041	0.315	N/A	Pass
14	0.009	0.131	N/A	0.011	0.197	N/A	Pass
15	0.040	0.150	N/A	0.044	0.225	N/A	Pass
16	0.007	0.115	N/A	0.009	0.173	N/A	Pass
17	0.047	0.132	35.2	0.059	0.198	29.8	Pass
18	0.005	0.102	N/A	0.006	0.153	N/A	Pass
19	0.037	0.118	N/A	0.056	0.178	N/A	Pass
20	0.005	0.092	N/A	0.006	0.138	N/A	Pass
21	0.037	0.107	N/A	0.052	0.161	N/A	Pass
22	0.004	0.084	N/A	0.005	0.125	N/A	Pass
23	0.035	0.098	N/A	0.050	0.147	N/A	Pass
24	0.003	0.077	N/A	0.004	0.115	N/A	Pass
25	0.037	0.090	N/A	0.042	0.135	N/A	Pass
26	0.003	0.071	N/A	0.004	0.107	N/A	Pass
27	0.034	0.083	N/A	0.036	0.125	N/A	Pass
28	0.003	0.066	N/A	0.004	0.099	N/A	Pass
29	0.027	0.078	N/A	0.033	0.116	N/A	Pass
30	0.003	0.061	N/A	0.005	0.092	N/A	Pass
31	0.027	0.073	N/A	0.032	0.109	N/A	Pass
32	0.004	0.058	N/A	0.006	0.086	N/A	Pass
33	0.023	0.068	N/A	0.026	0.102	N/A	Pass
34	0.003	0.054	N/A	0.005	0.081	N/A	Pass
35	0.017	0.064	N/A	0.022	0.096	N/A	Pass
36	0.003	0.051	N/A	0.005	0.077	N/A	Pass
37	0.018	0.061	N/A	0.029	0.091	N/A	Pass
38	0.004	0.048	N/A	0.006	0.073	N/A	Pass
39	0.022	0.058	N/A	0.036	0.087	N/A	Pass
40	0.006	0.046	N/A	0.010	0.069	N/A	Pass

N/A: Harmonic currents less than 0.6% of the input current measured under the test conditions, or less than 5mA, whichever is greater, are disregarded



SGS-CSTC Standards Technical Services (Shanghai) Co., Ltd.

SHEM-TRF-001 Rev. 02 Sep01, 2023

Report No.: SHEM250900612401V01

Page: 26 of 47

Harm#	Harmonics V-rms	Limit V-rms	% of Limit	Status
2	0.074	0.460	16.07	OK
3	0.366	2.072	17.64	OK
4	0.051	0.460	11.03	OK
5	0.047	0.921	5.08	OK
6	0.027	0.460	5.81	OK
7	0.046	0.691	6.65	OK
8	0.011	0.460	2.33	OK
9	0.018	0.460	3.98	OK
10	0.021	0.460	4.47	OK
11	0.013	0.230	5.74	OK
12	0.030	0.230	12.82	OK
13	0.026	0.230	11.34	OK
14	0.017	0.230	7.33	OK
15	0.028	0.230	12.09	OK
16	0.015	0.230	6.72	OK
17	0.033	0.230	14.47	OK
18	0.011	0.230	4.69	OK
19	0.036	0.230	15.47	OK
20	0.012	0.230	5.21	OK
21	0.045	0.230	19.65	OK
22	0.006	0.230	2.77	OK
23	0.041	0.230	18.01	OK
24	0.014	0.230	6.13	OK
25	0.041	0.230	17.73	OK
26	0.012	0.230	5.38	OK
27	0.042	0.230	18.08	OK
28	0.009	0.230	3.75	OK
29	0.034	0.230	14.65	OK
30	0.011	0.230	4.76	OK
31	0.036	0.230	15.73	OK
32	0.014	0.230	6.15	OK
33	0.036	0.230	15.44	OK
34	0.014	0.230	6.14	OK
35	0.030	0.230	12.90	OK
36	0.013	0.230	5.44	OK
37	0.039	0.230	16.93	OK
38	0.017	0.230	7.38	OK
39	0.048	0.230	21.04	OK
40	0.023	0.230	9.94	OK

6.6 Voltage Fluctuations and Flicker

Test Requirement: EN 61000-3-3: 2013 +A1:2019 +A2:2021

Test Method: EN 61000-3-3: 2013 +A1:2019 +A2:2021

6.6.1 E.U.T. Operation

Operating Environment:

Temperature: 24.4 °C Humidity: 52 % RH Atmospheric Pressure: 1010 mbar

6.6.2 Test Mode Description

Pre-scan / Final test	Mode Code	Description
Final test	00	Test the EUT in cooling mode, keep swinging at high speed, and adjust the EUT temperature at the lowest temperature position.
Pre-scan	01	Test the EUT in heating mode, keep swinging at high speed, and adjust the EUT temperature at the highest temperature position.
Pre-scan	02	Test the EUT in dehumidification mode.
Pre-scan	03	Test the EUT in fan mode, keep swinging at high speed.
Pre-scan	04	Test the EUT in idle mode.

6.6.3 Test Setup Diagram

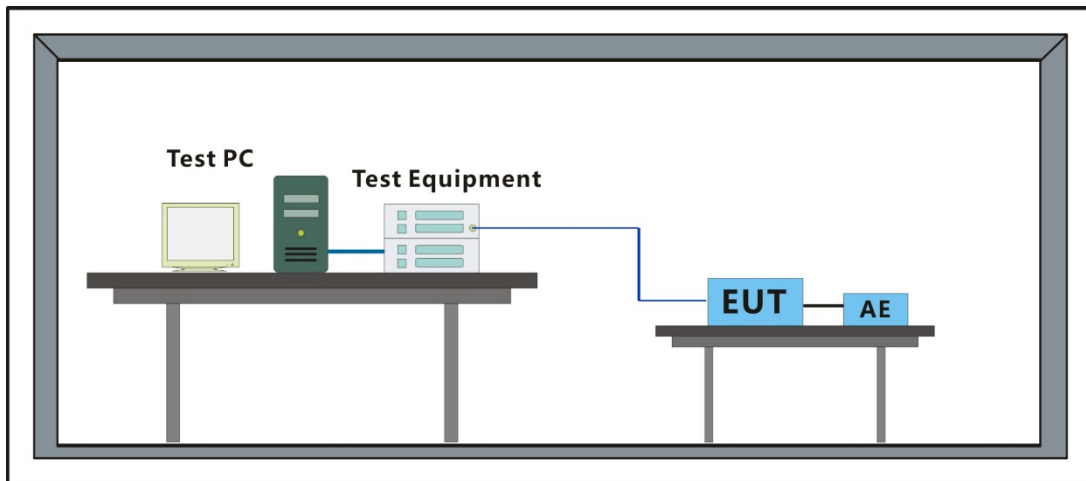

6.6.4 Measurement Procedure and Data

Test Mode: 00

Parameter values recorded during the test:

Vrms at the end of test (Volt): 227.02

Highest dt (%):

T-max (mS): 0

Highest dc (%): 0.00

Highest dmax (%): 0.24

Highest Pst (10 min. period): 0.242

Highest Plt (2 hr. period): 0.106

Test limit (%):

Test limit (mS): 500.0 Pass

Test limit (%): 3.30 Pass

Test limit (%): 6.00 Pass

Test limit: 1.000 Pass

Test limit: 0.650 Pass

7 Immunity Test Results

Performance Criteria Description

- Criterion A:** The apparatus shall continue to operate as intended during the test. No degradation of performance or loss of function is allowed below a performance level (or permissible loss of performance) specified by the manufacturer, when the apparatus is used as intended. If the minimum performance level or the permissible performance loss is not specified by the manufacturer, then either of these may be derived from the product description and documentation, and from what the user may reasonably expect from the apparatus if used as intended.
- Criterion B:** The apparatus shall continue to operate as intended after the test. No degradation of performance or loss of function is allowed below a performance level (or permissible loss of performance) specified by the manufacturer, when the apparatus is used as intended. During the test, degradation of performance is allowed, however. No change of actual operating state or stored data is allowed. If the minimum performance level or the permissible performance loss is not specified by the manufacturer, then either of these may be derived from the product description and documentation and from what the user may reasonably expect from the apparatus if used as intended.
- Criterion C:** Temporary loss of function is allowed, provided the function is self recoverable or can be restored by the operation of the controls, or by any operation specified in the instructions for use.

7.1 Electrostatic Discharge

Test Requirement: EN IEC 55014-2: 2021

Test Method: EN 61000-4-2: 2009

7.1.1 Test Setup Diagram

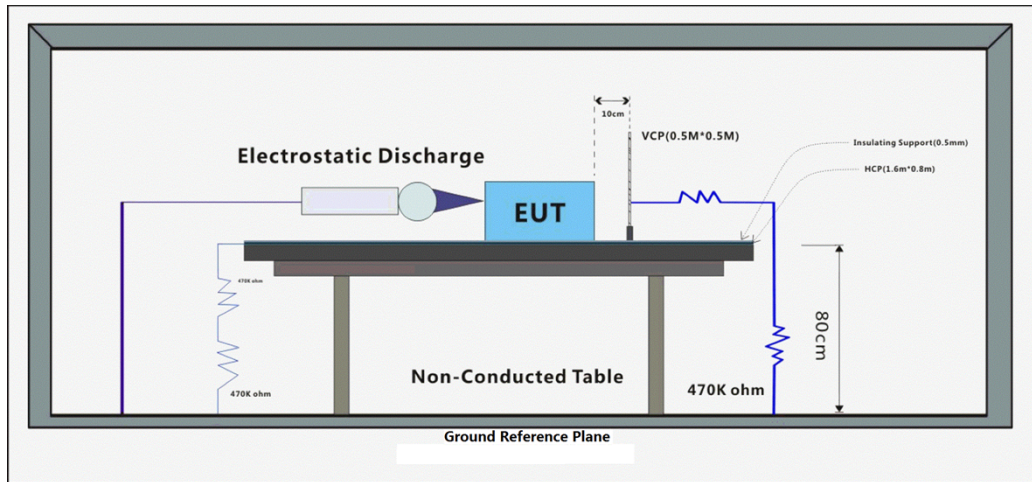

7.1.2 E.U.T. Operation

Operating Environment:

Temperature: 24 °C

Humidity: 56 % RH

Atmospheric Pressure: 1010 mbar

7.1.3 Test Mode Description

Pre-scan / Final test	Mode Code	Description
Final test	00	Test the EUT in cooling mode, keep swinging at high speed, and adjust the EUT temperature at the lowest temperature position.
Pre-scan	01	Test the EUT in heating mode, keep swinging at high speed, and adjust the EUT temperature at the highest temperature position.
Pre-scan	02	Test the EUT in dehumidification mode.
Pre-scan	03	Test the EUT in fan mode, keep swinging at high speed.
Pre-scan	04	Test the EUT in idle mode.

7.1.4 Test Condition and Results:

Performance Criterion: B

Discharge Impedance: 330 Ω / 150 pF

Discharge Voltage: Air Discharge: 8 kV; Contact Discharge:4 kV; VCP/HCP: 4 kV.

Polarity: Positive & Negative

Number of Discharge: Minimum 10 times at each test point

Discharge Mode: Single Discharge

Discharge Period: 1 second minimum

Test Point 1: All insulated enclosure & seams.

Test Point 2: All accessible metal parts of the enclosure.

Test Point 3: All sides.

Discharge type	Level (kV)	Polarity	Test Point	Result / Observations
Air Discharge	8	+	1	A
Air Discharge	8	-	1	A
Contact Discharge	4	+	2	A
Contact Discharge	4	-	2	A
Vertical Coupling	4	+	3	A
Vertical Coupling	4	-	3	A

A: No degradation in the performance of the EUT was observed

7.2 Radiated Immunity (80MHz-1GHz)

Test Requirement: EN IEC 55014-2: 2021

Test Method: EN IEC 61000-4-3: 2020

7.2.1 Test Setup Diagram

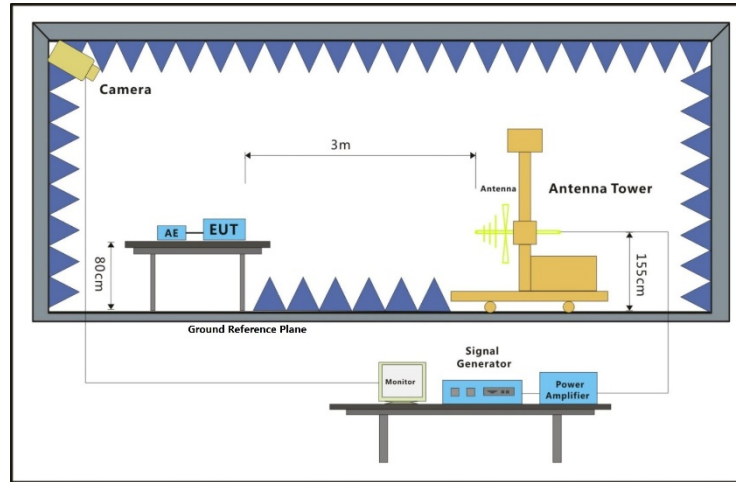

7.2.2 E.U.T. Operation

Operating Environment:

Temperature: 22 °C

Humidity: 50 % RH

Atmospheric Pressure: 1010 mbar

7.2.3 Test Mode Description

Pre-scan / Final test	Mode Code	Description
Final test	05	Only for remote controller: Test the IR remote controller in continuously emitting mode.

7.2.4 Test Condition and Results:

Performance Criterion: A

Frequency Range: 80MHz to 1GHz

Antenna Polarisation: Vertical and Horizontal

Modulation 1kHz, 80% Amp. Mod, 1% increment

Frequency	Level (V/m)	EUT Face	Dwell time	Result / Observations
80MHz-1GHz	3	Front	3s	A
80MHz-1GHz	3	Back	3s	A
80MHz-1GHz	3	Left	3s	A
80MHz-1GHz	3	Right	3s	A
80MHz-1GHz	3	Top	3s	A
80MHz-1GHz	3	Underside	3s	A

A: No degradation in the performance of the EUT was observed

7.3 Electrical Fast Transients Burst at AC Mains Power Port

Test Requirement: EN IEC 55014-2: 2021

Test Method: EN 61000-4-4: 2012

7.3.1 Test Setup Diagram

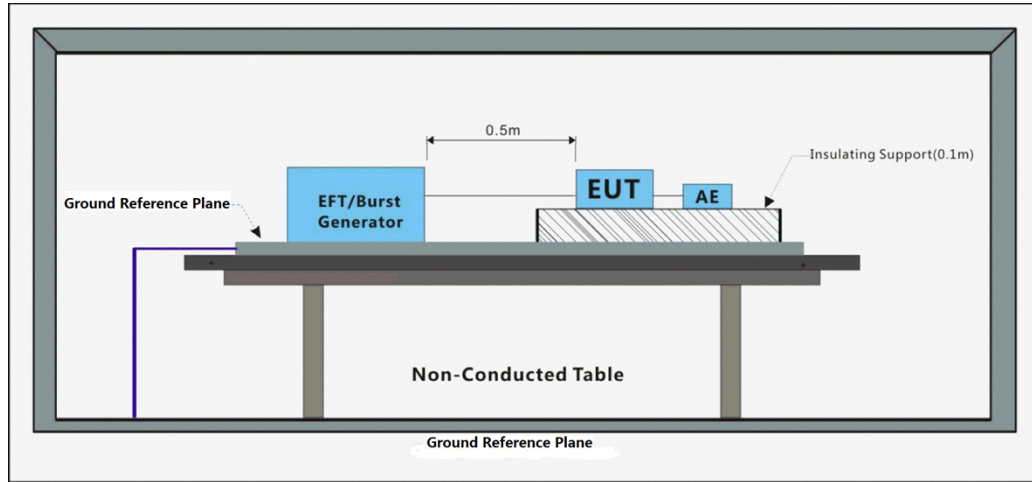

7.3.2 E.U.T. Operation

Operating Environment:

Temperature: 24 °C

Humidity: 56 % RH

Atmospheric Pressure: 1010 mbar

7.3.3 Test Mode Description

Pre-scan / Final test	Mode Code	Description
Final test	00	Test the EUT in cooling mode, keep swinging at high speed, and adjust the EUT temperature at the lowest temperature position.
Pre-scan	01	Test the EUT in heating mode, keep swinging at high speed, and adjust the EUT temperature at the highest temperature position.
Pre-scan	02	Test the EUT in dehumidification mode.
Pre-scan	03	Test the EUT in fan mode, keep swinging at high speed.
Pre-scan	04	Test the EUT in idle mode.

7.3.4 Test Condition and Results:

Performance Criterion: B

Repetition Frequency: 5kHz

Burst Period: 300ms

Test Duration: 2 minute per level & polarity

Test Level: 1.0kV

Polarity: Positive & Negative

Test Line	Level (kV)	Polarity	CDN/Clamp	Result / Observations
AC power port	1	+	CDN	A
AC power port	1	-	CDN	A

A: No degradation in the performance of the EUT was observed

7.4 Electrical Fast Transients Burst at Signal Port

Test Requirement: EN IEC 55014-2: 2021

Test Method: EN 61000-4-4: 2012

7.4.1 Test Setup Diagram

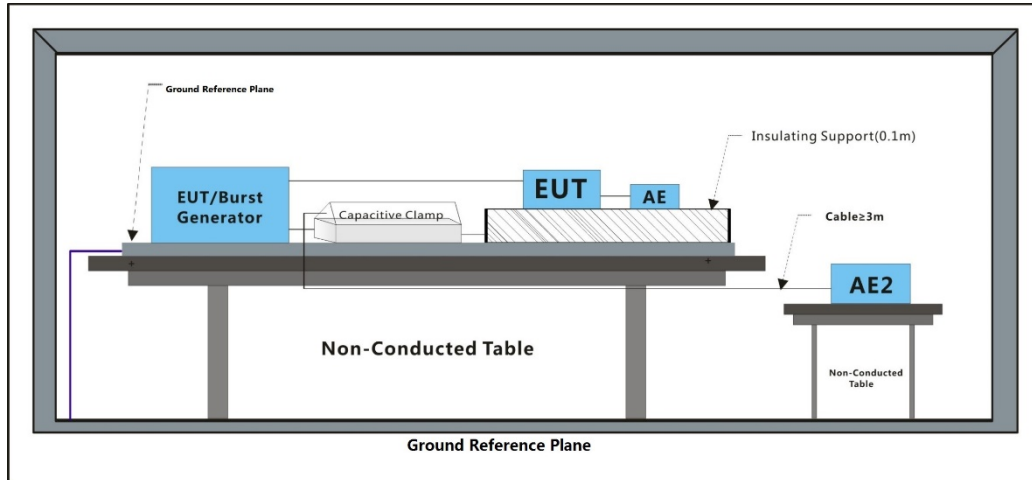

7.4.2 E.U.T. Operation

Operating Environment:

Temperature: 24 °C

Humidity: 56 % RH

Atmospheric Pressure: 1010 mbar

7.4.3 Test Mode Description

Pre-scan / Final test	Mode Code	Description
Final test	00	Test the EUT in cooling mode, keep swinging at high speed, and adjust the EUT temperature at the lowest temperature position.
Pre-scan	01	Test the EUT in heating mode, keep swinging at high speed, and adjust the EUT temperature at the highest temperature position.
Pre-scan	02	Test the EUT in dehumidification mode.
Pre-scan	03	Test the EUT in fan mode, keep swinging at high speed.
Pre-scan	04	Test the EUT in idle mode.

7.4.4 Test Condition and Results:

Performance Criterion: B

Repetition Frequency: 5kHz

Burst Period: 300ms

Test Duration: 2 minute per level & polarity

Test Level: 0.5kV

Polarity: Positive & Negative

Port	Level (kV)	Polarity	CDN/Clamp	Result / Observations
Signal	0.5	+	Clamp	A
Signal	0.5	-	Clamp	A

A: No degradation in the performance of the EUT was observed

7.5 Surge at AC Mains Power Port

Test Requirement: EN IEC 55014-2: 2021

Test Method: EN 61000-4-5: 2014 +A1:2017

7.5.1 Test Setup Diagram

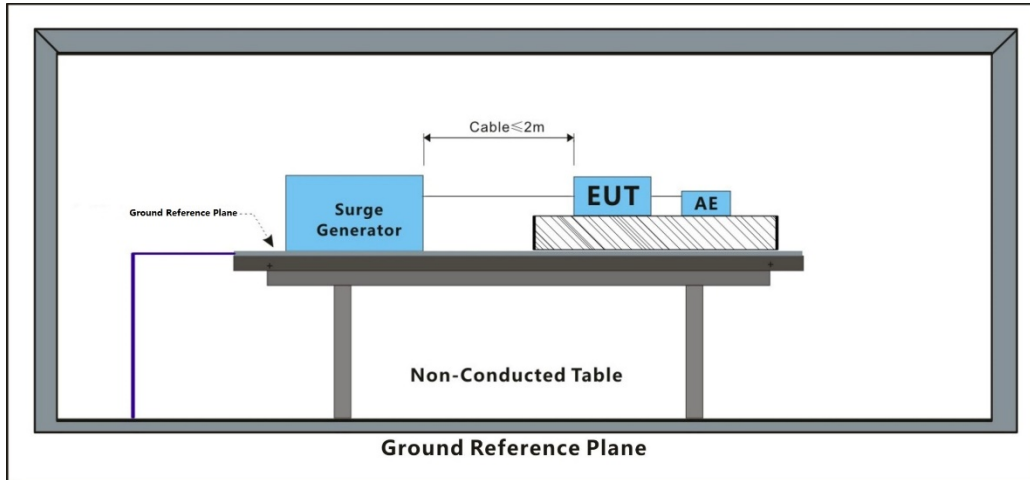

7.5.2 E.U.T. Operation

Operating Environment:

Temperature: 24 °C

Humidity: 56 % RH

Atmospheric Pressure: 1010 mbar

7.5.3 Test Mode Description

Pre-scan / Final test	Mode Code	Description
Final test	00	Test the EUT in cooling mode, keep swinging at high speed, and adjust the EUT temperature at the lowest temperature position.
Pre-scan	01	Test the EUT in heating mode, keep swinging at high speed, and adjust the EUT temperature at the highest temperature position.
Pre-scan	02	Test the EUT in dehumidification mode.
Pre-scan	03	Test the EUT in fan mode, keep swinging at high speed.
Pre-scan	04	Test the EUT in idle mode.

7.5.4 Test Condition and Results:

Performance Criterion: B

Interval: 60s between each surge

Test Level: ±1kV Live to Neutral; ±2kV Live, Neutral to Earth

Polarity: Positive & Negative

Generator source impedance: 2Ω

CDN coupling impedance(Line-to-ground):10Ω

Trigger Mode: Internal

No. of surges: 5 positive at 90°, 5 negative at 270°.

Test Line	Level (kV)	Polarity	Phase (deg)	Result / Observations
L-N	1	+	90°	A
L-N	1	-	270°	A
L-PE	2	+	90°	A
L-PE	2	-	270°	A
N-PE	2	+	90°	A
N-PE	2	-	270°	A

A: No degradation in the performance of the EUT was observed

7.6 Conducted Immunity at AC Mains Power Port (150kHz-80MHz)

Test Requirement: EN IEC 55014-2: 2021

Test Method: EN 61000-4-6: 2014

7.6.1 Test Setup Diagram

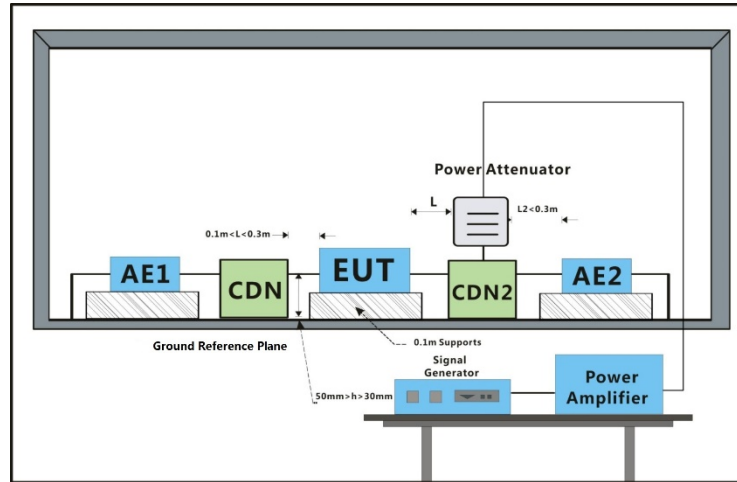

7.6.2 E.U.T. Operation

Operating Environment:

Temperature: 24 °C

Humidity: 56 % RH

Atmospheric Pressure: 1010 mbar

7.6.3 Test Mode Description

Pre-scan / Final test	Mode Code	Description
Final test	00	Test the EUT in cooling mode, keep swinging at high speed, and adjust the EUT temperature at the lowest temperature position.
Pre-scan	01	Test the EUT in heating mode, keep swinging at high speed, and adjust the EUT temperature at the highest temperature position.
Pre-scan	02	Test the EUT in dehumidification mode.
Pre-scan	03	Test the EUT in fan mode, keep swinging at high speed.
Pre-scan	04	Test the EUT in idle mode.

7.6.4 Test Condition and Results:

Performance Criterion: A

Step Size: 1%

Frequency Range: 0.15MHz to 80MHz

Modulation: 80%, 1kHz Amplitude Modulation

Cable Port	Level (Vrms)	CDN/Clamp	Dwell time	Result / Observations
AC power port	3	CDN	3s	A

A: No degradation in the performance of the EUT was observed

7.7 Conducted Immunity at Signal Port (150kHz-80MHz)

Test Requirement: EN IEC 55014-2: 2021

Test Method: EN 61000-4-6: 2014

7.7.1 Test Setup Diagram

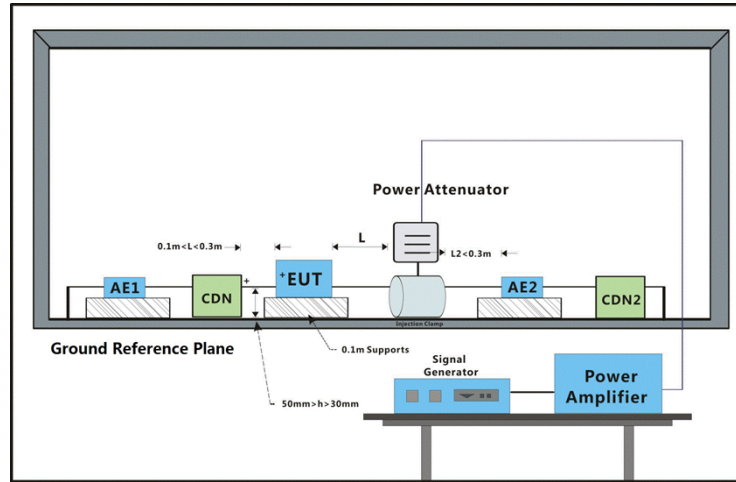

7.7.2 E.U.T. Operation

Operating Environment:

Temperature: 24 °C

Humidity: 56 % RH

Atmospheric Pressure: 1010 mbar

7.7.3 Test Mode Description

Pre-scan / Final test	Mode Code	Description
Final test	00	Test the EUT in cooling mode, keep swinging at high speed, and adjust the EUT temperature at the lowest temperature position.
Pre-scan	01	Test the EUT in heating mode, keep swinging at high speed, and adjust the EUT temperature at the highest temperature position.
Pre-scan	02	Test the EUT in dehumidification mode.
Pre-scan	03	Test the EUT in fan mode, keep swinging at high speed.
Pre-scan	04	Test the EUT in idle mode.

7.7.4 Test Condition and Results:

Performance Criterion: A

Step Size: 1%

Frequency Range: 0.15MHz to 80MHz

Modulation: 80%, 1kHz Amplitude Modulation

Port	Level (Vrms)	CDN/Clamp	Dwell time	Result / Observations
Signal Port	1	Clamp	3s	A

A: No degradation in the performance of the EUT was observed

7.8 Voltage Dips and Interruptions

Test Requirement: EN IEC 55014-2: 2021

Test Method: EN IEC 61000-4-11: 2020

7.8.1 Test Setup Diagram

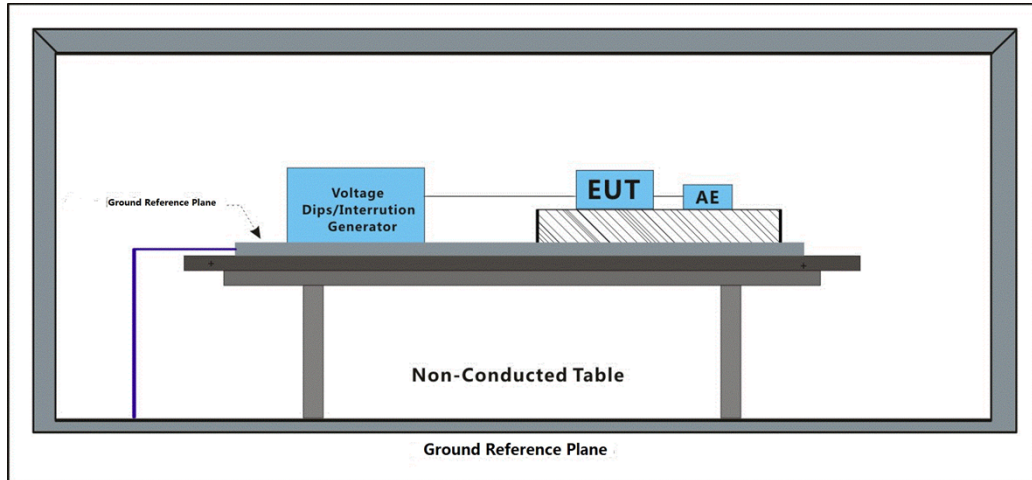

7.8.2 E.U.T. Operation

Operating Environment:

Temperature: 24 °C

Humidity: 56 % RH

Atmospheric Pressure: 1010 mbar

7.8.3 Test Mode Description

Pre-scan / Final test	Mode Code	Description
Final test	00	Test the EUT in cooling mode, keep swinging at high speed, and adjust the EUT temperature at the lowest temperature position.
Pre-scan	01	Test the EUT in heating mode, keep swinging at high speed, and adjust the EUT temperature at the highest temperature position.
Pre-scan	02	Test the EUT in dehumidification mode.
Pre-scan	03	Test the EUT in fan mode, keep swinging at high speed.
Pre-scan	04	Test the EUT in idle mode.

7.8.4 Test Condition and Results:

Performance Criterion:

For 50Hz: 0% of UT (Rated Voltage) for 0.5 Cycle: C; 40% of UT for 10 Cycles: C; 70% of UT for 25 Cycles: C.

No. of Dips / Interruptions: 3 per Level

Time between dropout: 10s

Level % UT	Phase (deg)	Duration	No. of Dips / Interruptions	Result / Observations
0	0°	0.5 Cycle for 50Hz	3	A
0	180°	0.5 Cycle for 50Hz	3	A
40	0°	10 Cycles for 50Hz	3	A
40	180°	10 Cycles for 50Hz	3	A
70	0°	25 Cycles for 50Hz	3	A
70	180°	25 Cycles for 50Hz	3	A

A: No degradation in the performance of the EUT was observed

8 Test Setup Photo

Conducted Emissions at AC Mains Power Port (150kHz-30MHz)



Conducted Emissions at Load Terminals and Additional Terminals



Discontinuous Disturbance (150kHz-30MHz)



Disturbance Power



Harmonic Current Emission



Voltage Fluctuations and Flicker



Electrostatic Discharge



Radiated Immunity (80MHz-1GHz)

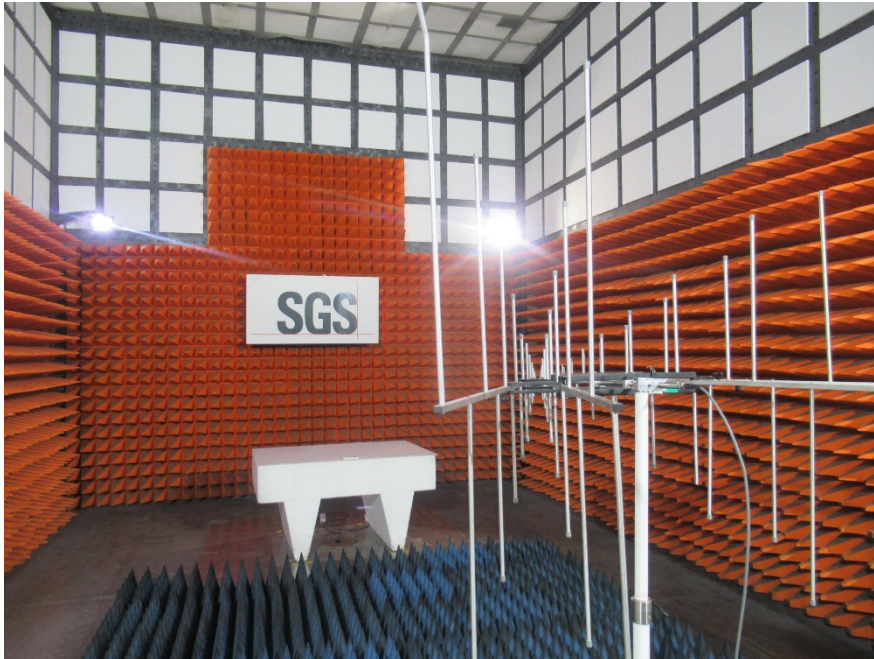

Electrical Fast Transients Burst at AC Mains Power Port



Electrical Fast Transients Burst at Signal Port



Surge at AC Mains Power Port



Conducted Immunity at AC Mains Power Port (150kHz-80MHz)



Conducted Immunity at Signal Port (150kHz-80MHz)



Voltage Dips and Interruptions



9 EUT Constructional Details (EUT Photos)

