

# BMI® Medical

## Shunting System



# BMI® Medical

## Antibacterial Ventricular Catheter 21101

The Antibiotic-Impregnated Catheters reduce the colonization of gram-positive bacteria using a combination of rifampicin and silver salts.

### Features

1. Impregnated with two antibiotics: rifampicin and silver salts
2. Show to reduce colonization of gram-positive bacteria on all catheter surfaces.
3. Features same-sized tubing as our standard non-antibiotic-impregnated catheters to resist kinking and compression.
4. Barium impregnation allows for visualization of the catheter on x-ray.
5. non-ferrous design won't interfere with CT scans or MRI.

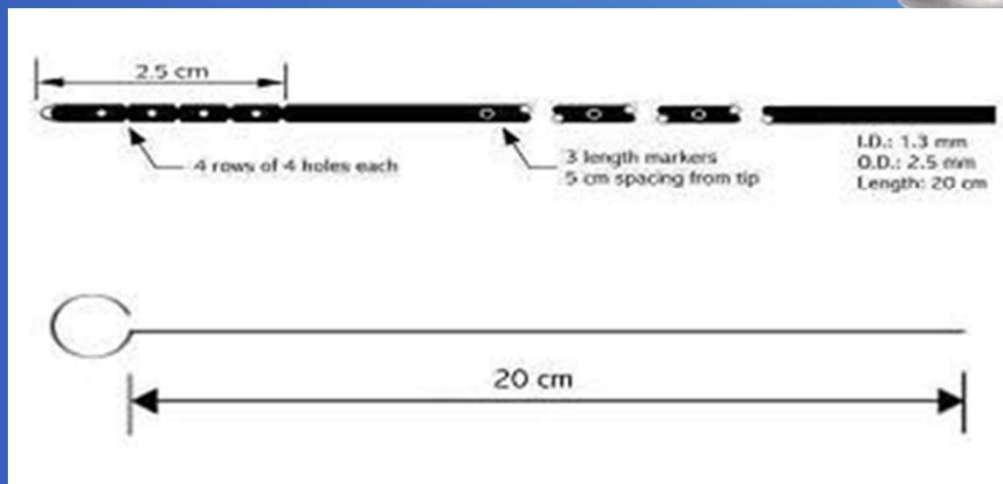

Included with product  
1ea. Ventricular Catheter  
Barium Impregnated

I.D.: 1.3 mm

O.D.: 2.5 mm

Length: 20 cm

1ea. Stainless Steel Stylet (20 cm)

# BMI® Medical

## CSF Valve Burr Hole (L. M. H) 02512, 02514

Two sizes are available: 12mm/14mm. (Pediatric/Adult)  
High, Medium, Low pressure are available .

### Features

1. Flexible silicone elastomer eliminating valve sticking and deformation.
2. Connector included.
3. Internal flow path is uncomplicated.
4. Two-way flushing eliminates separate reservoirs or antechambers.
5. Non-metallic design will not interfere with CT scans or MRI.
6. Polypropylene needle guard prevents complete penetration of the valve by needles.
7. Silicone elastomer dome is injectable.

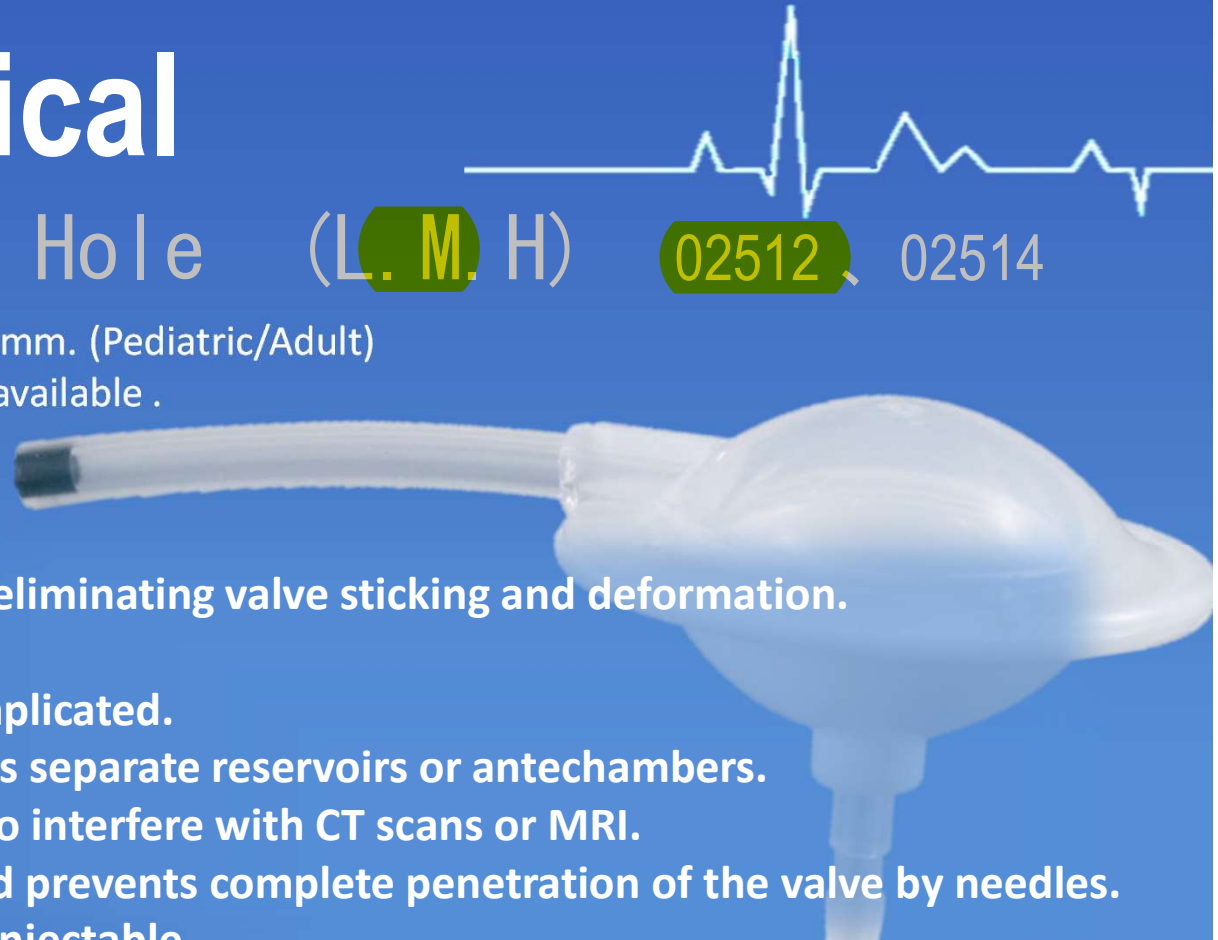
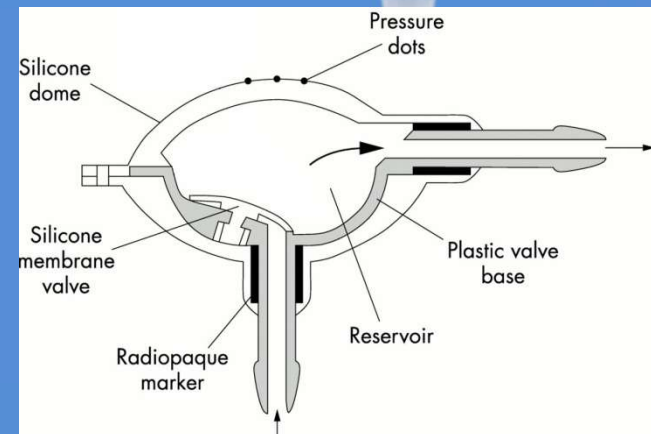
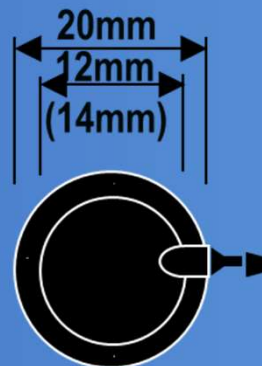
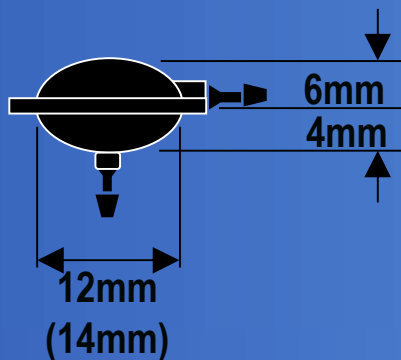

# BMI<sup>®</sup> Medical

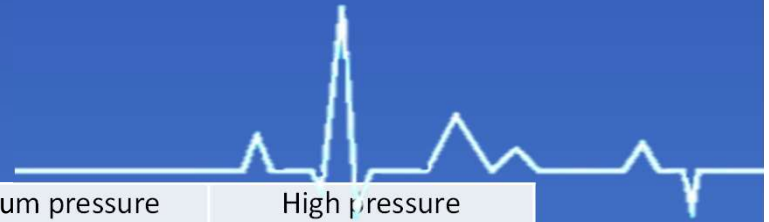

	Low Low Pressure	Low pressure	Medium pressure	High pressure
Flow rate 5 ml / hr	1 cm / H <sub>2</sub> O	2 cm / H <sub>2</sub> O	6 cm / H <sub>2</sub> O	12 cm / H <sub>2</sub> O
Flow rate 50 ml / hr	3 cm / H <sub>2</sub> O	8 cm / H <sub>2</sub> O	14 cm / H <sub>2</sub> O	20 cm / H <sub>2</sub> O
remark		.	..	...

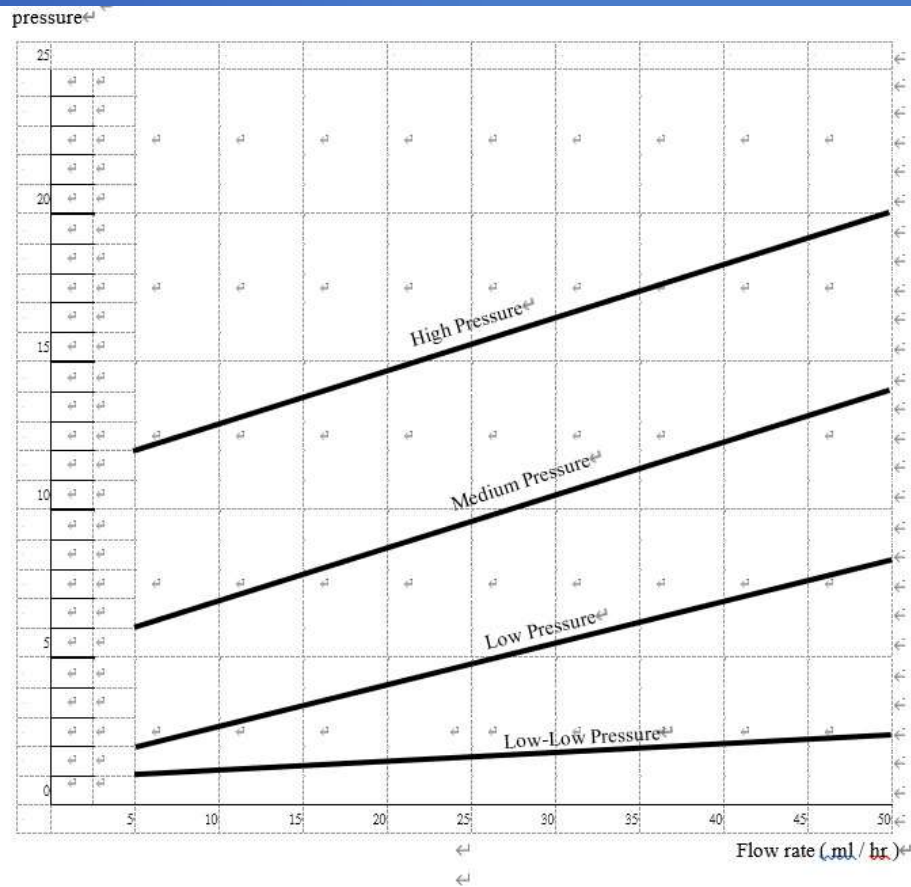

Flow rate between 5~50 ml / hr : tolerance  $\pm 2$ cm / H<sub>2</sub>O

## Pressure / Flow Characteristics

# BMI® Medical

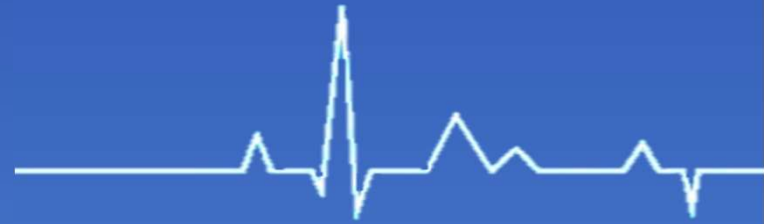

## Shunting System-Instructions for Use

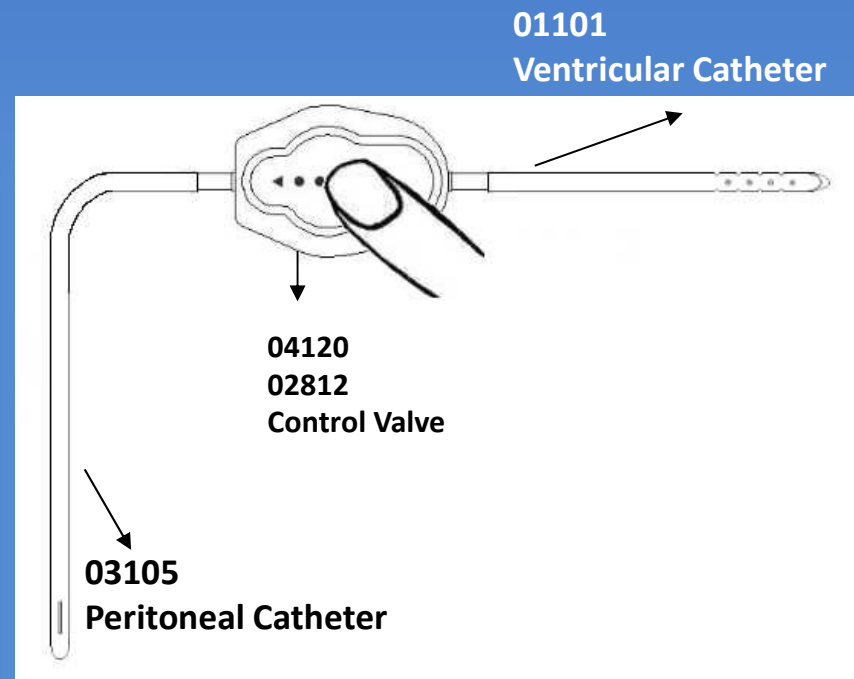
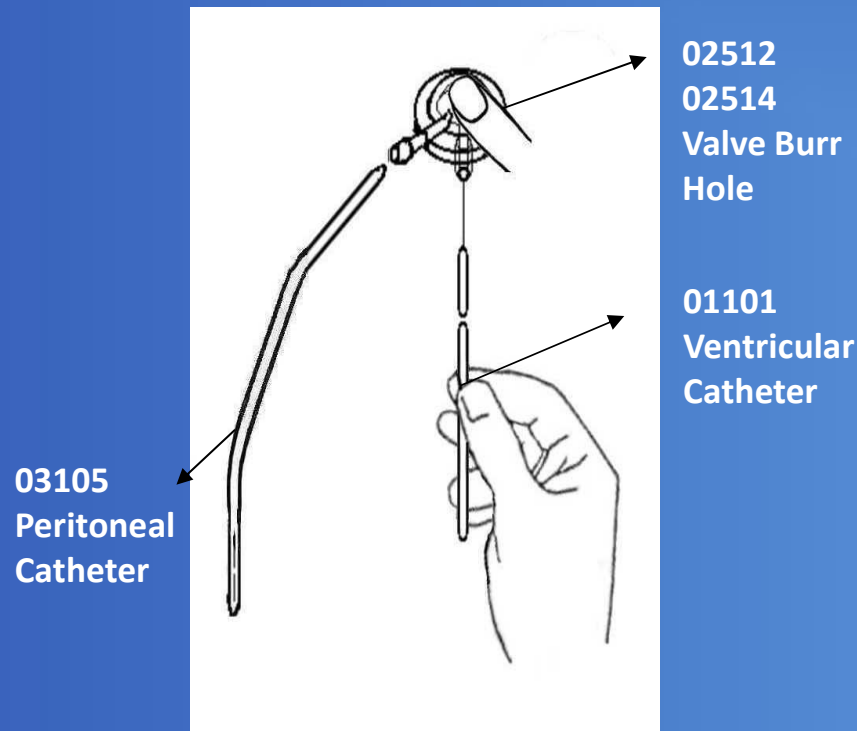



# Bulb Drainage Instructions

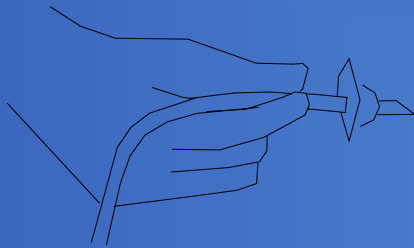

1. Starting with trocar inside wound, push trocar through to a separate exit site 2 to 5 cm from the wound.

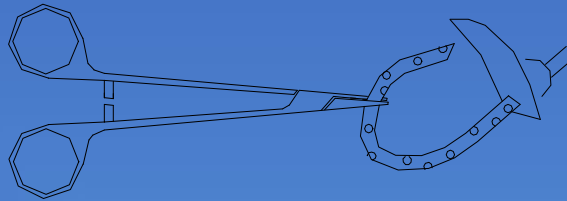

2. Cut catheter section with holes to needed wound length and insert into wound site.  
**CAUTION:** Make sure all drainage holes are contained tissue in order to maintain suction.

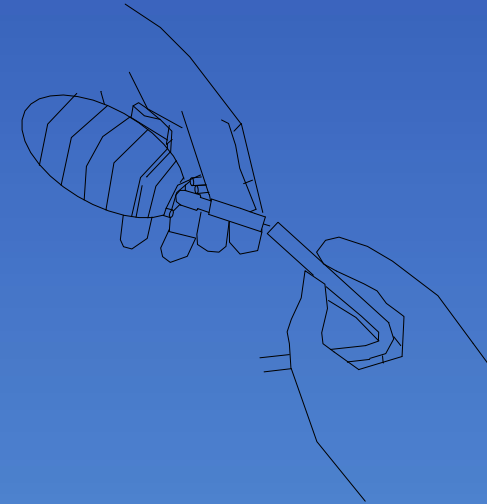

3. Cut off trocar, place slide clamp on catheter, and attach catheter to connector with a pushing and twisting motion  
**CAUTION:** Check tubing seals at all connecting points

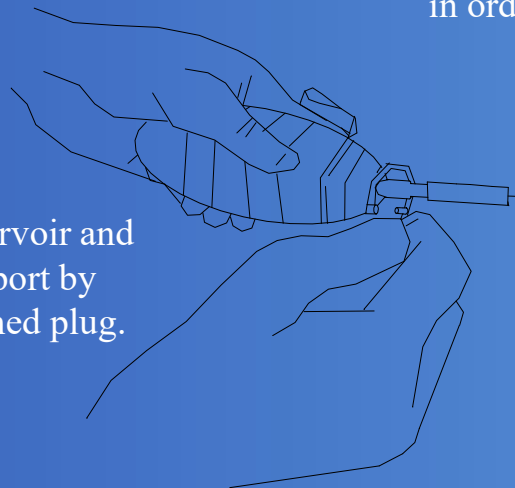

4. Squeeze reservoir and close FLUSH port by inserting attached plug.

5. TO empty or reset, open FLUSH port, FLUSH contents into appropriate container, compress reservoir and reseal port.  
**NOTE:** For optimal drainage place the reservoir below wound site.

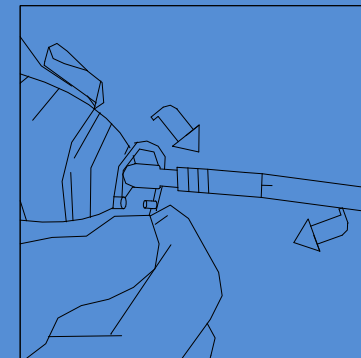

## BMI MEDICAL

### Peritoneal Catheter 23105 ( L, M, H )

---

#### Features :

1. Impregnated with two antibiotics: rifampicin and Silver Salts
  2. Show to reduce colonization of gram-positive bacteria on all catheter surfaces.
  3. Features same-sized tubing as our standard non-antibiotic-impregnated catheters to resist kinking and compression.
  4. Barium impregnation allows for visualization of the catheter on x-ray.
  5. non-ferrous design won't interfere with CT scans or MRI.
- 

#### Description

The **Antibiotic-Impregnated** Catheters were designed with the same diameters as our standard catheters for seamless connection to all Wellong shunt valves. High, Medium, Low pressure are available according to the size of slit. The spherical tip of catheter is tantalum-impregnated. CSF flow from 4 wall slits around the circumference of the catheter near the tip. The graphic markers are imprinted at each 10 cm from the tip. All impregnate with white barium to provide radiopacity fully.

#### 23105 Peritoneal Catheter ( L, M, H )

I.D.:1.3 mm

O.D.:2.5 mm

Length: 90~120 cm



1.5mm Connector



## **Indications**

The Peritoneal Catheters is designed as the distal component of a flow control shunt for use in shunting cerebrospinal fluid from the ventricles of the brain into the peritoneal cavity.

## **Instructions for use**

A variety of surgical techniques may be utilized in placing the catheters into peritoneal cavity. Position of placement is at the discretion of the surgeon.

## **Peritoneal Catheter Patency Check**

Place Peritoneal Catheter into sterile physiological saline and check the patency before implant. See figure below, first fill 1 with saline, then connect with 2 and 3. Press 1, if saline flows out from the tip, the catheter passes the patency test.

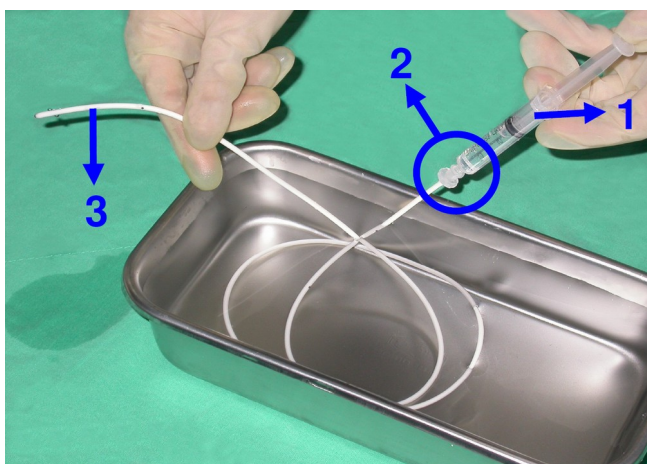

1. Syringe
2. Connector
3. Peritoneal Catheter



# BMI® Medical

Wellong Instruments Co., Ltd.

E-mail : [cctco@ms35.hinet.net](mailto:cctco@ms35.hinet.net)

Phone Number : +886-2-25719829 · +886-2-25413710

Fax Number : +886-2-25627884

Address : 2F., No.63, Linsen N. Rd., Zhongshan Dist.,  
Taipei City 104, Taiwan (R.O.C.)