

Micro Forceps with Round Handles and Counter Balance

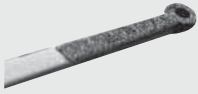

■ The diamond dust coating ensures an even harder and more wear resistant surface on the inside of the jaws. Moreover, the structure of the Dia Dust® coating enables a reliable grip for fine needles and sutures, as well as for tissue.

| Jaw type       | Diam. of ring:<br>1 mm,<br>straight<br>Dia Dust® | Diam. of ring:<br>1 mm,<br>curved<br>Dia Dust® | Diam. of ring:<br>2 mm,<br>straight<br>Dia Dust® | Platform tip,<br>straight<br>Dia Dust® | Platform tip,<br>curved<br>Dia Dust® | DeBakey tip,<br>1 mm |
|----------------|--|--|--|--|--------------------------------------|----------------------|
|                |  |  |  |  |                                      |                      |
| Total length   |  |  |  |  |                                      |                      |
| 150 mm, 6"     | <b>FM570R</b>                                    | <b>FM571R</b>                                  |  | <b>FM578R</b>                          | <b>FM581R</b>                        |                      |
| 185 mm, 7 1/4" | <b>FM572R</b>                                    | <b>FM573R</b>                                  | <b>FM579R</b>                                    | <b>FM580R</b>                          | <b>FM583R</b>                        | <b>FM592R</b>        |
| 210 mm, 8 1/4" | <b>FM574R</b>                                    | <b>FM575R</b>                                  |  | <b>FM599R</b>                          | <b>FM585R</b>                        | <b>FM600R</b>        |
| 230 mm, 9"     | <b>FM576R</b>                                    | <b>FM577R</b>                                  |  |  |                                      |                      |
| 250 mm, 10"    | <b>FM596R</b>                                    | <b>FM595R</b>                                  |  | <b>FM594R</b>                          | <b>FM593R</b>                        |                      |

Dia Dust® Micro Needle Holders with Round Handles



with ratchet

Total length



Suture size

7/0 and smaller



5/0 and smaller



4/0 and smaller



4/0 and smaller

120 mm  
4 3/4"

FM520R

145 mm  
5 3/4"

FM522R

160 mm  
6 1/4"

FM521R

FM523R

185 mm  
7 1/4"

FM563R

FM564R

FM218R

210 mm  
8 1/4"

FM565R

FM566R

FM228R

FM221R

230 mm  
9"

FM567R

FM568R

FM230R

FM223R



Suture size

7/0 and smaller



5/0 and smaller

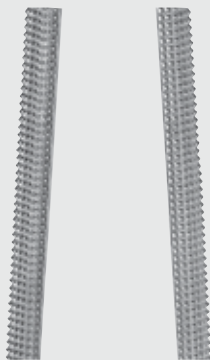

without ratchet

Total length

120 mm  
4 3/4"

FM524R

145 mm  
5 3/4"

FM528R

160 mm  
6 1/4"

FM525R

FM529R

185 mm  
7 1/4"

FM526R

FM530R

210 mm  
8 1/4"

FM527R

FM531R

230 mm  
9"

FM532R

FM533R

## Scheren – Scissors

Präparierscheren, feine Modelle

Dissecting Scissors, Delicate Patterns

BC



| BC180R | BC181R |
|--------|--------|
| 145 mm | 175 mm |
| 5 3/4" | 7"     |

REYNOLDS

**BC180R-BC181R**

Präparierscheren  
Dissecting scissors



POTTS

**BC178R**

Präparierschere  
Dissecting scissors  
180 mm, 7"

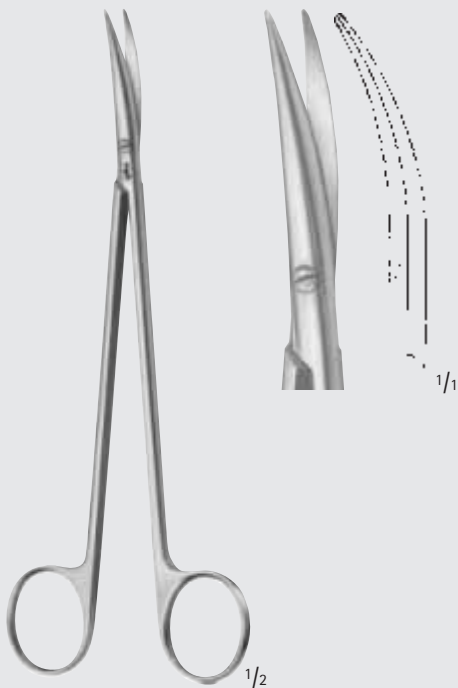

DE BAKEY

**BC629R**

Arteriotomie-Schere  
Arteriotomy scissors  
175 mm, 7"



**BC630R**

sehr fein  
very delicate

**BC631R**

fein  
delicate

TÖNNIS-ADSON

**BC630R-BC631R**

Präparierscheren  
Dissecting scissors  
175 mm, 7"







# Pinzetten – Dissecting- and Tissue Forceps

Feine Anatomische Pinzetten  
Delicate Dissecting Forceps

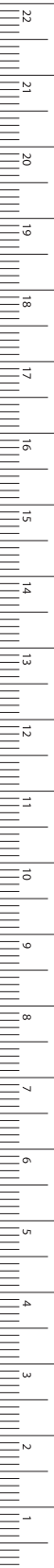
**BD**

| BD238R | BD239R | BD243R | BD240R |
|--------|--------|--------|--------|
| 180 mm | 200 mm | 200 mm | 250 mm |
| 7"     | 8"     | 8"     | 10"    |

**CUSHING**  
BD238R-BD243R

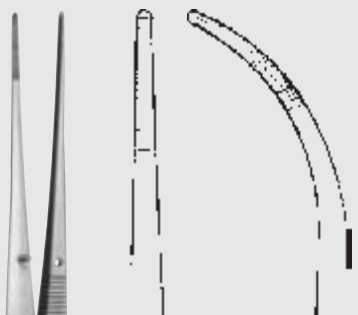

**BROPHY**  
BD246R-BD247R

1/2 200 mm, 8"



**BD081R**

1/2 200 mm, 8"

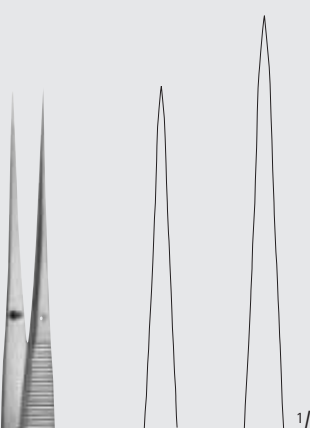

| BD231R | BD232R |
|--------|--------|
| 185 mm | 200 mm |
| 7 1/4" | 8"     |

**BD231R-BD232R**  
glattes Maul  
smooth jaws

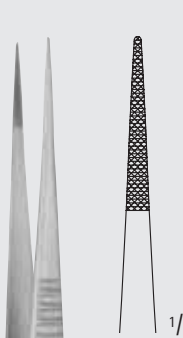

**COOLEY**  
BD250R

1/2 200 mm, 8"

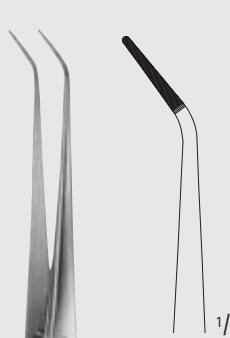

**BD257R**

1/2 200 mm, 8"

## Pinzetten – Dissecting- and Tissue Forceps

Pinzetten, bajonettförmig gebogen

Forceps, Bayonet-Shaped

BD

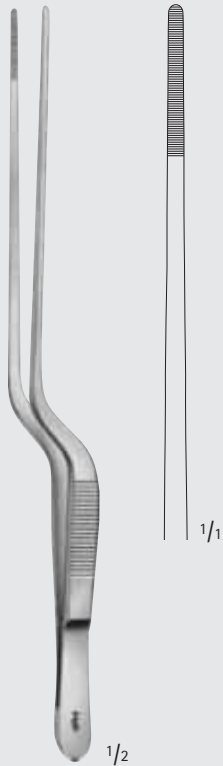

GRUENWALD

**BD883R**

200 mm, 8"

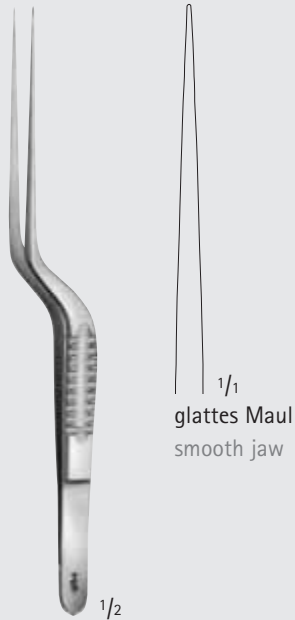

glattes Maul  
smooth jaw

**BD887R**

160 mm, 6 1/4"

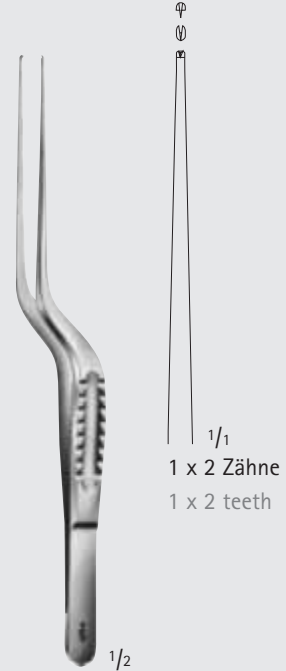

1 x 2 Zähne  
1 x 2 teeth

**BD888R**

160 mm, 6 1/4"



glattes Maul  
smooth jaw

**BD885R**

185 mm, 7 1/4"

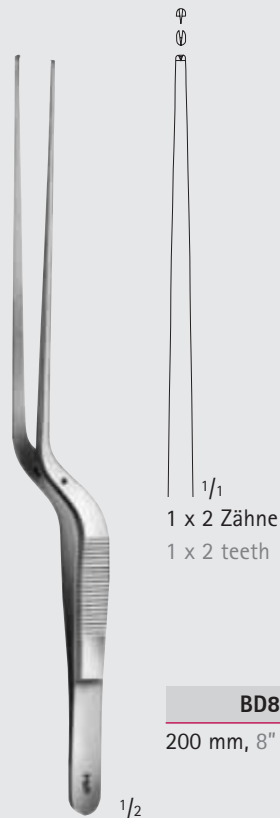

1 x 2 Zähne  
1 x 2 teeth

**BD886R**

200 mm, 8"

## Arterienklemmen – Hemostatic Forceps

Feine Arterienklemmen

Delicate Hemostatic Forceps

BH

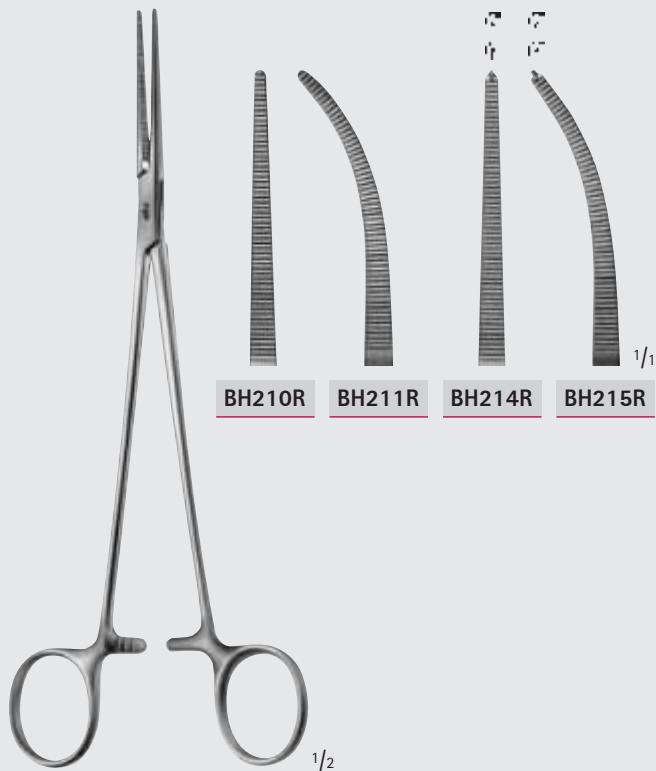

BH210R

BH211R

BH214R

BH215R

1/2

HALSTED-MOSQUITO

BH210R-BH215R

200 mm, 8"



1/1

1/2

JACOBSON

BH187R

190 mm, 7 1/2"



1/1

1/2

ADSON

BH205R

215 mm, 8 1/2"



1/1

1/2

FRASER-KELLY (CRILE)

BH183R

180 mm, 7"



## Arterienklemmen – Hemostatic Forceps

Feine Arterienklemmen  
Delicate Hemostatic Forceps

BH



DUNHILL

**BH191R**

190 mm, 7 1/2"

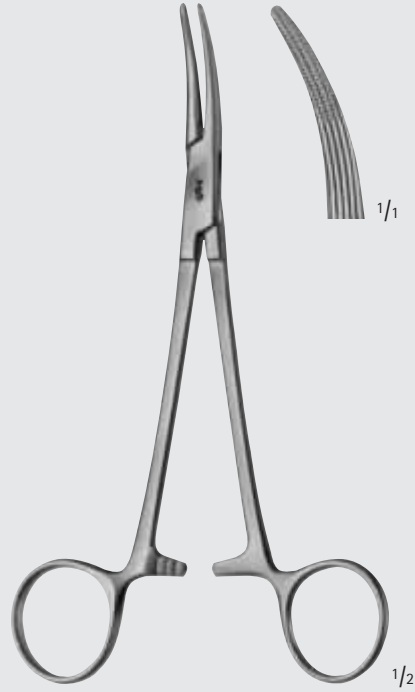

GREY-TURNER

**BH193R**

180 mm, 7"

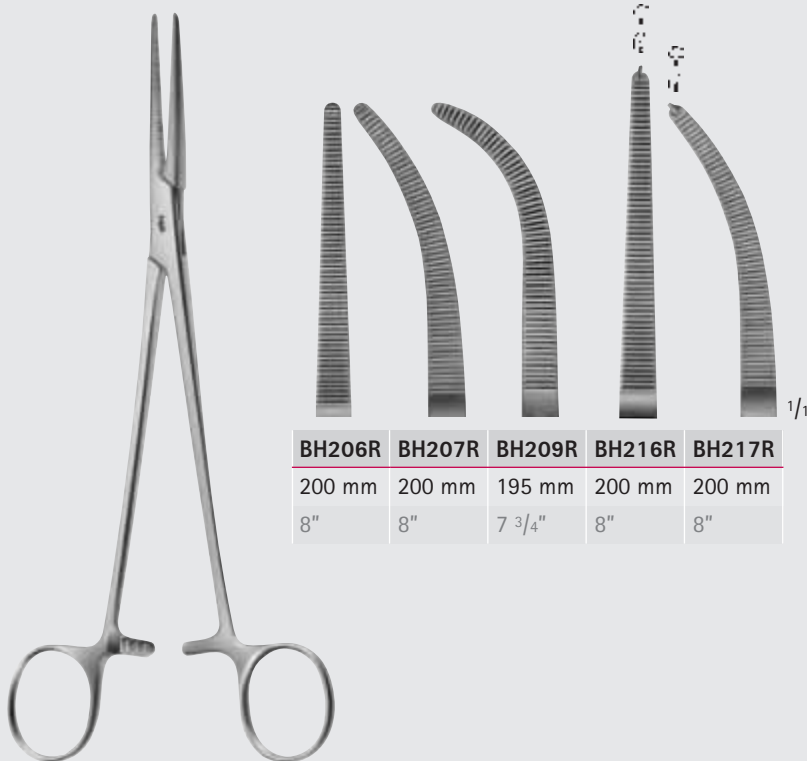

| BH206R | BH207R | BH209R | BH216R | BH217R |
|--------|--------|--------|--------|--------|
| 200 mm | 200 mm | 195 mm | 200 mm | 200 mm |
| 8"     | 8"     | 7 3/4" | 8"     | 8"     |

HEISS

**BH206R-BH217R**

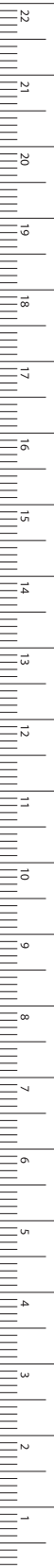

MILLIMETERS



# Arterienklemmen – Hemostatic Forceps

Arterienklemmen  
Hemostatic Forceps

**BH**

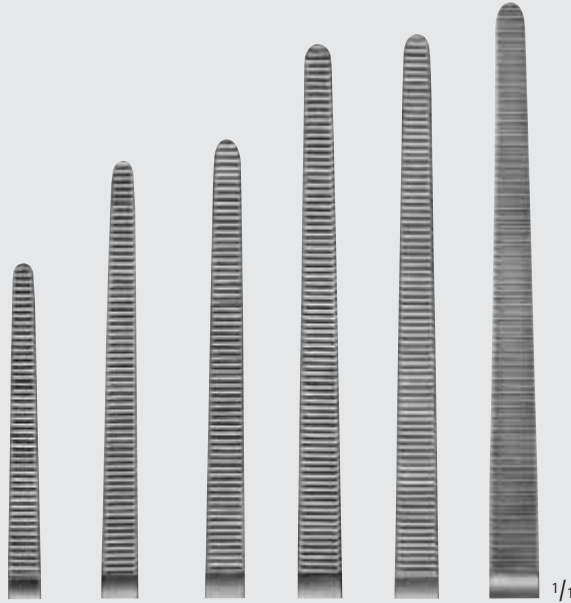

| BH442R | BH444R | BH446R | BH448R | BH450R | BH456R |
|--------|--------|--------|--------|--------|--------|
| 160 mm | 185 mm | 200 mm | 225 mm | 240 mm | 350 mm |
| 6 1/4" | 7 1/4" | 8"     | 9"     | 9 1/2" | 14"    |

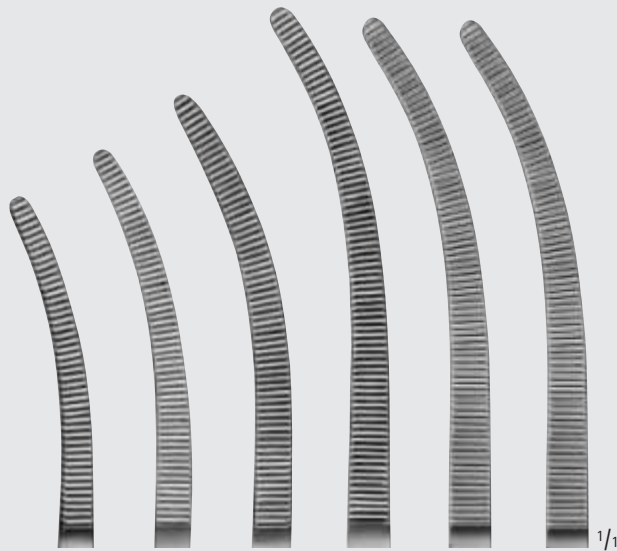

| BH443R | BH445R | BH447R | BH449R | BH451R | BH457R |
|--------|--------|--------|--------|--------|--------|
| 160 mm | 185 mm | 200 mm | 225 mm | 240 mm | 350 mm |
| 6 1/4" | 7 1/4" | 8"     | 9"     | 9 1/2" | 14"    |



ROCHESTER-PEAN

**BH442R-BH457R**

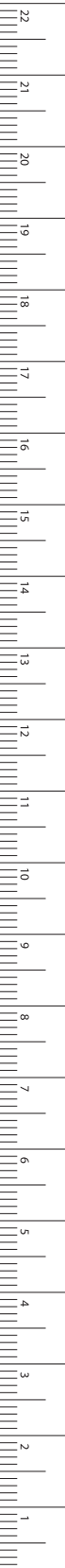

MILLIMETERS





## Klemmen – Forceps

Präparier- und Ligaturklemmen  
Dissecting- and Ligature Forceps

BJ

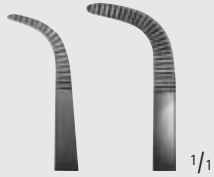
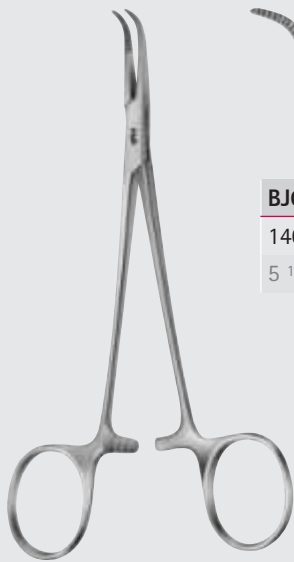

| BJ013R | BJ014R |
|--------|--------|
| 140 mm | 180 mm |
| 5 1/2" | 7"     |

BABY-ADSON

**BJ013R-BJ014R**



| MD569  | MD570R |
|--------|--------|
| 140 mm | 180 mm |
| 5 1/2" | 7"     |

**MD569-MD570R**

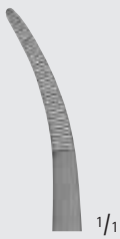
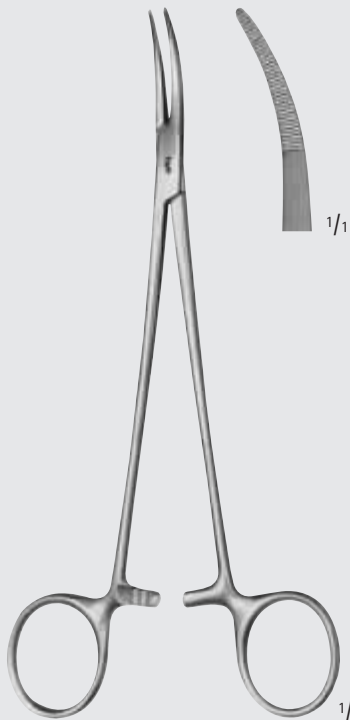

NISSEN

**BH199R**

185 mm, 7 1/4"

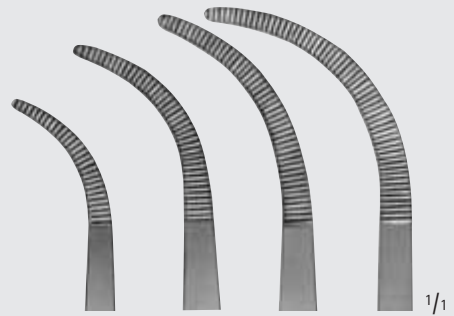
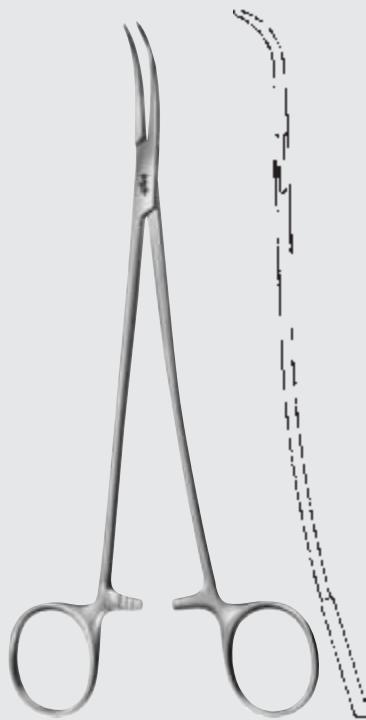

| BJ015R | BJ016R | BJ017R | BJ018R |
|--------|--------|--------|--------|
| 185 mm | 210 mm | 215 mm | 220 mm |
| 7 1/4" | 8 1/4" | 8 1/2" | 8 3/4" |

**BJ015R-BJ018R**

S-förmig gebogen, grazil  
S-shaped, delicate

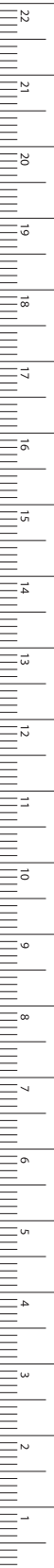

MILLIMETERS

## Nadelhalter – Needle Holders

DUROGRIP® Nadelhalter, Drahtspannzangen, Ligaturzangen

DUROGRIP® Needle Holders, Wire Twisters, Ligature Forceps

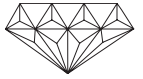

BM



**BM110R**

150 mm, 6"



**BM111R**

150 mm, 6"



**BAUMGARTNER**

**BM112R**

200 mm, 8"



**BM113R**

175 mm, 7"



**BERRY**

**MD456R**

185 mm, 7 1/4"



# Wundspreizer, Bauchdeckenhalter – Self-Retaining Retractors, Abdominal Retractors

Wundspreizer  
Self-Retaining Retractors

BV

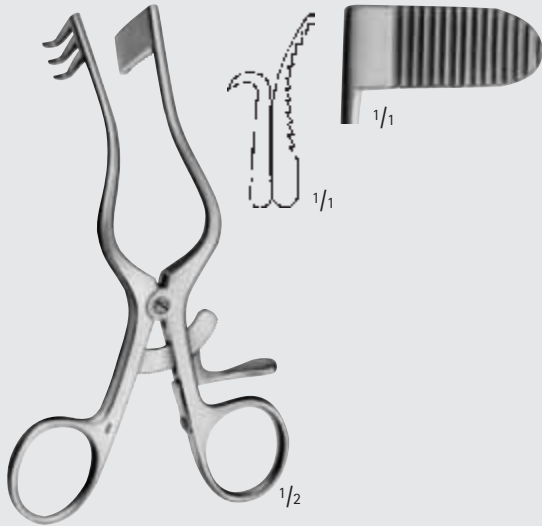

PERKINS

**OK794R**

130 mm, 5 1/8"

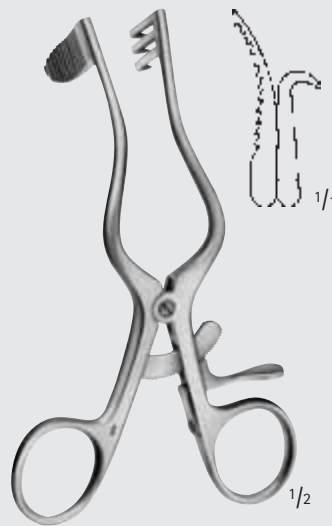

PERKINS

**OK795R**

130 mm, 5 1/8"



RNTNE HOSPITAL

**BV084R**

scharf

sharp

165 mm, 6 1/2"

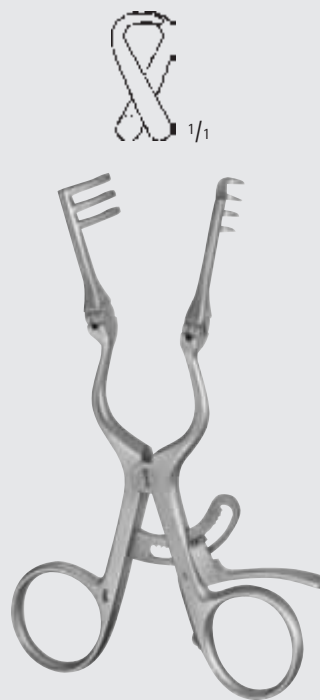

ADSON-BABY

**BV085R** 140 mm 5 1/2"

**BV094R** 165 mm 6 1/2"

halbscharf

semi-sharp

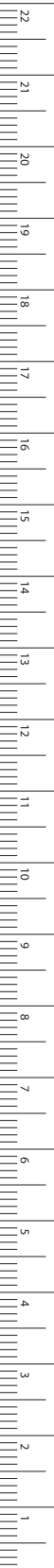

MILLIMETERS

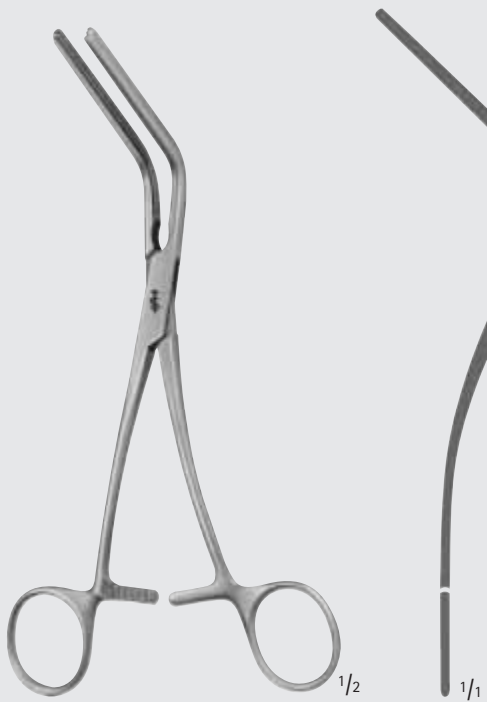
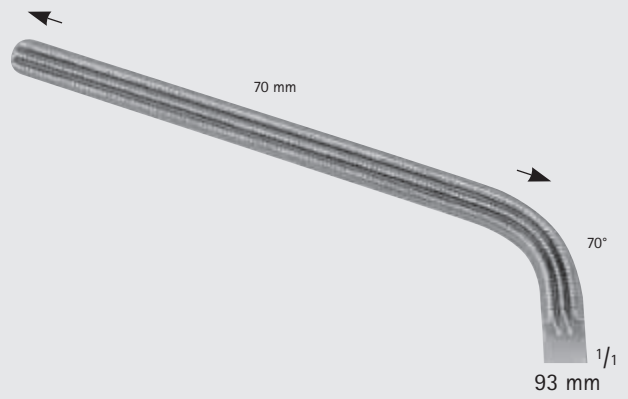
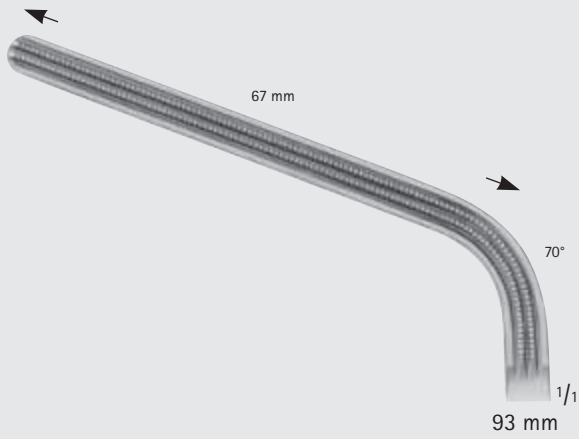

MORRIS

FB493R

175 mm, 7"

DE BAKEY  
(MORRIS MODIF.)

FB494R

240 mm, 9"



MILLIMETERS



# Knochenstanzen, Rongeurs – Bone Punches, Rongeurs

Rongeurs  
Rongeurs

Winkelstellungen bei Rongeurs  
Angled positions for rongeurs

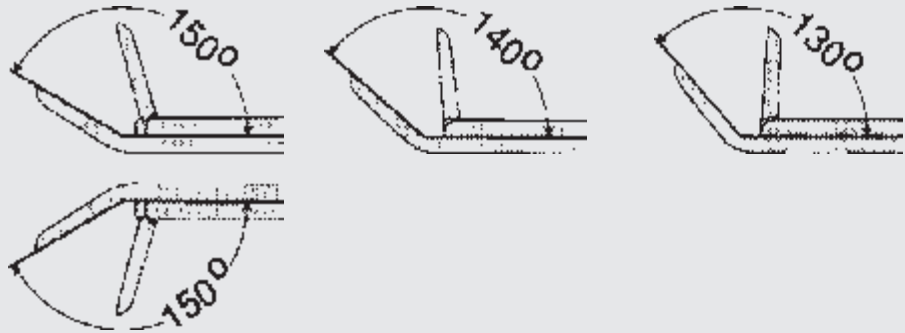

FF

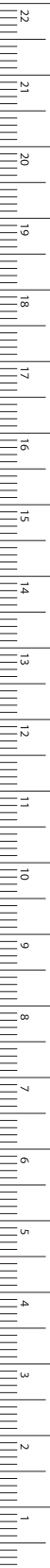

**OK505R**

3,0 mm



**OK506R**

3,6 mm



**OK507R**

4,2 mm



**OK508R**

4,8 mm



**OK509R**

5,6 mm

1/1

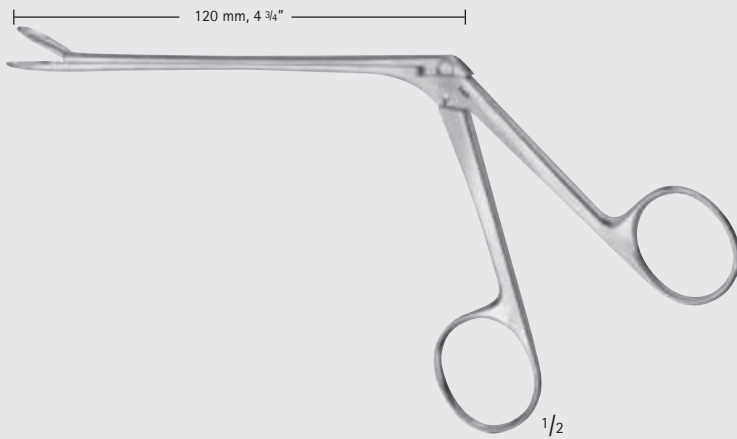

WEIL-BLAKESLEY

**OK505R-OK509R**

140°



**OK520R**

3,6 mm



**OK521R**

4,2 mm



**OK522R**

4,8 mm

1/1

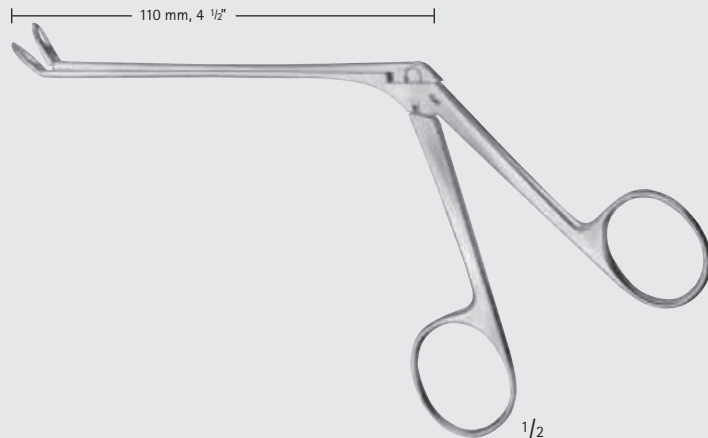

WEIL-BLAKESLEY

**OK520R-OK522R**



# Knochenheber, Raspatorien, Scharfe Löffel – Bone Levers, Elevators, Bone Curettes

Raspatorien  
Raspatories

**FK**

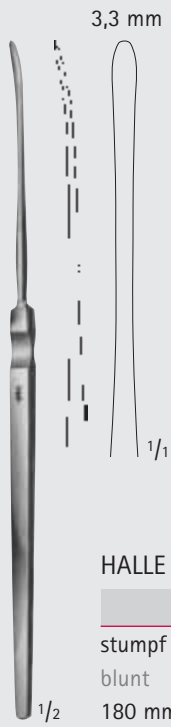

**HALLE**  
**OL160R**  
stumpf  
blunt  
180 mm, 7"



**FREER**  
**OL163R**  
stumpf  
blunt  
190 mm, 7 1/2"



**FREER**  
**OL162R**  
scharf  
sharp  
190 mm, 7 1/2"



**SEWALL**  
**OL198R**  
stumpf  
blunt  
200 mm, 8"

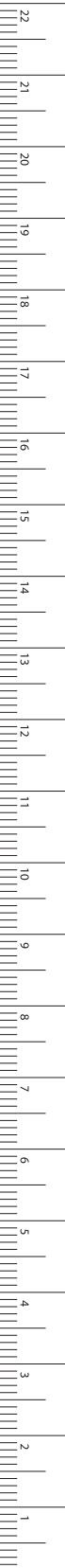

MILLIMETERS

## Sauginstrumente – Suction Instruments

Sauginstrumente  
Suction Instruments



Olive Ø 6 - 9 mm  
olive diam. 6 - 9 mm

FERGUSSON

**GF933R** Ø diam. 4,0 mm

isoliert, mit Saugunterbrecher und Mandrin,  
Griffplatte 90° zur Biegung, LUER-Bohrung

isolated, with finger cut-off and stylet,  
thumb piece 90° to curve, with LUER hub

180 mm, 7"



Olive Ø 6 - 9 mm  
olive diam. 6 - 9 mm

FRAZIER

| Ø | diam. |
|---|-------|
|   |       |

**GF923R** 3,0 mm

**GF925R** 5,0 mm

mit Saugunterbrecher und Mandrin,  
Griffplatte 90° zur Biegung, LUER-Bohrung

with finger cut-off and stylet, thumb  
piece 90° to curve, with LUER hub

180 mm, 7"



FRAZIER

| Ø | diam. |
|---|-------|
|   |       |

**MD124R** 2,3 mm

**MD125R** 2,7 mm

**MD127R** 3,4 mm

**MD129R** 4,0 mm

mit Saugunterbrecher und Mandrin,  
Griffplatte 90° zur Biegung, LUER-Bohrung  
with finger cut-off and stylet, thumb piece 90°  
to curve, with LUER hub

110 mm, 4 1/4"

# Noir

## SUPREME CUT SCISSORS

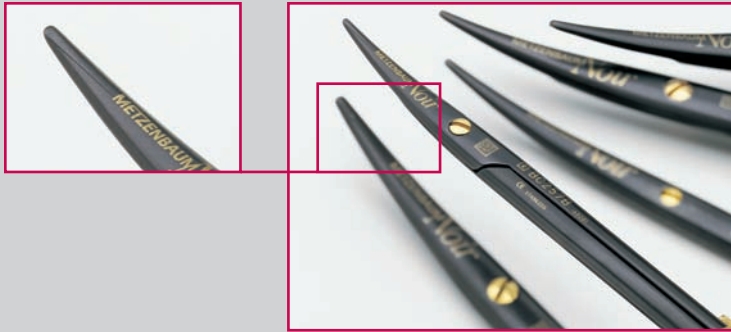

The particularly delicate shape permits smooth dissection even in very delicate tissue structures.







|  |                                |  |                                    |  |                                |                                     |                                 |
|--|--------------------------------|--|------------------------------------|--|--------------------------------|-------------------------------------|---------------------------------|
|  | Delicate                       |  |                                    |  | Delicate                       | Delicate                            |                                 |
|  |                                |  |                                    |  |                                |                                     |                                 |
|  | 1/1                            |  | 1/1                                |  | 1/1                            | 1/1                                 |                                 |
|  | <b>BC273WB</b><br>curved<br>7" |  | <b>BC259WB</b><br>curved<br>5-3/4" |  | <b>BC267WB</b><br>curved<br>9" | <b>BC279WB</b><br>curved<br>10-1/4" | <b>BC281WB</b><br>curved<br>11" |
| NOIR TOENNIS-ADSON<br>Dissecting Scissors,<br>with Wavecut |                                | NOIR BABY-METZENBAUM<br>Dissecting Scissors,<br>with Wavecut |                                    | NOIR NELSON-METZENBAUM<br>Dissecting Scissors,<br>with Wavecut |                                |                                     |                                 |

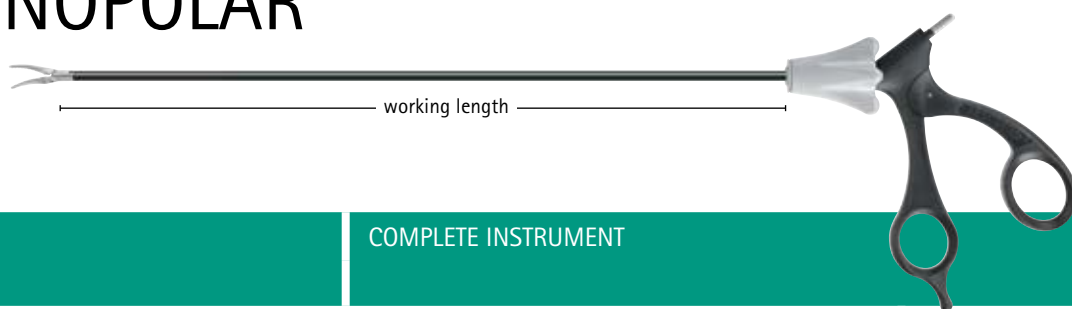











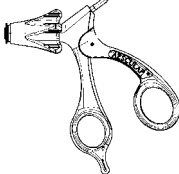

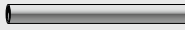

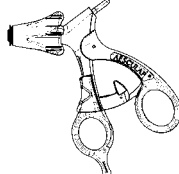







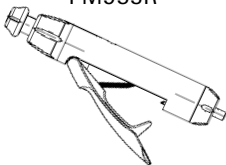

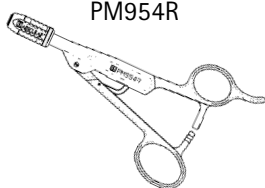

# AdTec® MONOPOLAR

## SCISSORS





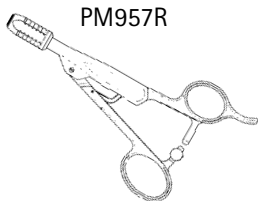



|   |               | COMPLETE INSTRUMENT   |                |
|---|---------------|---|----------------|
|    | <b>PO030R</b> | Medium-METZENBAUM<br>Scissors, serrated, tips curved to the left, with carbide inserts                                    | 5 mm / 310 mm  |
| ← 18 mm →   | 1/1           |   |                |
|    | <b>PO031R</b> | Medium-METZENBAUM<br>Scissors, serrated, tips curved to the left, with carbide inserts*                                   | 5 mm / 420 mm  |
| ← 18 mm →   | 1/1           |   |                |
|    | <b>PO023R</b> | Mini-METZENBAUM<br>Scissors, serrated, tips curved to the left, with carbide inserts                                      | 5 mm / 220 mm  |
| ← 14 mm →   | 1/1           |   |                |
|  | <b>PO011R</b> | Mini-METZENBAUM<br>Scissors, serrated, tips curved to the left, with carbide inserts                                      | 5 mm / 310 mm  |
| ← 14 mm →   | 1/1           |   |                |
|  | <b>PO028R</b> | Mini-METZENBAUM<br>Scissors, serrated, tips curved to the left, with carbide inserts                                      | 5 mm / 420 mm  |
| ← 14 mm →   | 1/1           |   |                |
|  |               | Mini-METZENBAUM<br>Scissors, serrated, tips curved to the left, with carbide inserts, PEEK insulation of the distal shaft | 10 mm / 310 mm |
| ← 13 mm →   | 1/1           | Instrument with protruding jaw parts  |                |
|  |               | Mini-METZENBAUM<br>Scissors, serrated, tips curved to the left, with carbide inserts, PEEK insulation of the distal shaft | 5 mm / 310 mm  |
| ← 13 mm →   | 1/1           | Instrument with protruding jaw parts  |                |

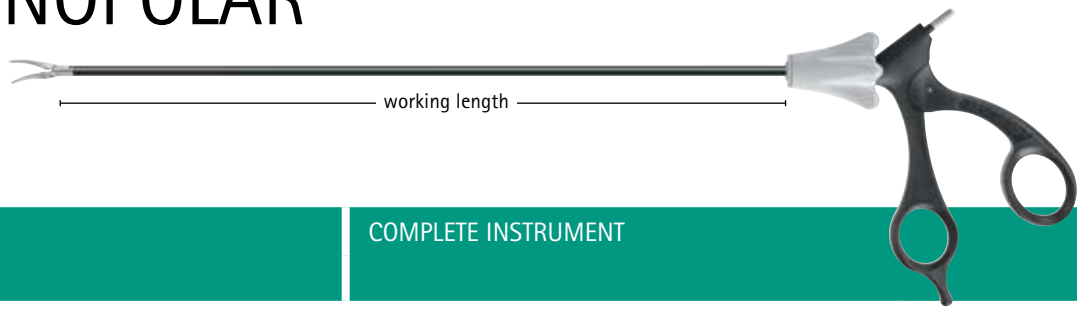









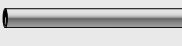

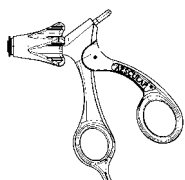

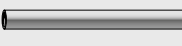

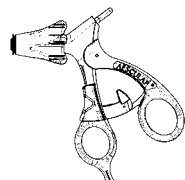

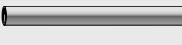

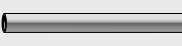
| SINGLE PARTS  |   |   | INDIVIDUAL COMPONENTS   |   |
|---|---|---|---|---|
| Jaw insert  | Insulated outer tube  | Handle  |   |   |
| P0715R<br>   | PM970R<br>   | P0958R<br>   |   | P0958R<br>   |
| P0716R<br>   | PM981R<br>   | P0958R<br>   |   | P0959R<br>   |
| P0738R<br>   | PM970R<br>   | P0958R<br>  | PM971R<br><br>Ø 5/10 mm   |   |
| P0655R<br> | PM973R<br> | P0958R<br> | PM975R<br><br>Ø 5/10 mm | PM953R<br> |
| P0754R<br> | PM981R<br> | P0958R<br> |   | PM954R<br> |
| PM698R<br> | PM973R<br> | P0958R<br> | PM975R<br><br>Ø 5/10 mm |   |
| PM710R<br> | PM973R<br> | P0958R<br> | PM975R<br><br>Ø 5/10 mm | PM957R<br> |

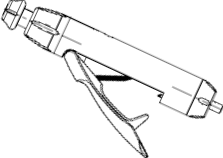
# AdTec® MONOPOLAR

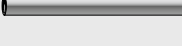
DISSECTING FORCEPS



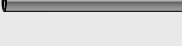

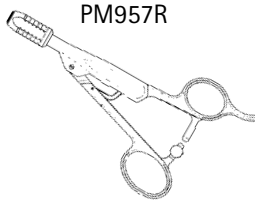



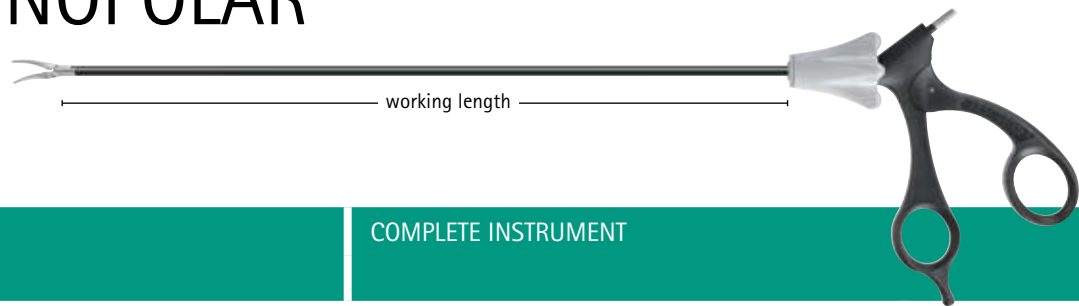

|   |       | COMPLETE INSTRUMENT |  |
|---|-------|---------------------|--|
|    | 21 mm | 1/1                 | MARYLAND<br>Fixation and dissecting forceps, curved<br>5 mm / 220 mm   |
|    | 21 mm | 1/1                 | PO102R MARYLAND<br>Fixation and dissecting forceps, curved<br>5 mm / 310 mm  |
|   | 21 mm | 1/1                 | PO202R MARYLAND<br>Fixation and dissecting forceps, curved<br>5 mm / 420 mm  |
|  | 19 mm | 1/1                 | MARYLAND<br>Fixation and dissecting forceps, insulation of the distal shaft<br>5 mm / 310 mm<br>Instrument with protruding jaw parts |
|  | 21 mm | 1/1                 | PO237R MARYLAND<br>Fixation and dissecting forceps, curved with cross teething<br>5 mm / 310 mm                                      |
|  | 21 mm | 1/1                 | PO238R MARYLAND<br>Fixation and dissecting forceps, curved with cross teething<br>5 mm / 420 mm                                      |

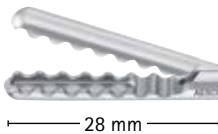



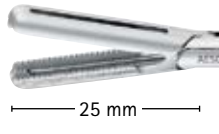

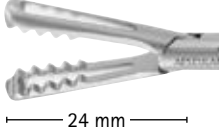







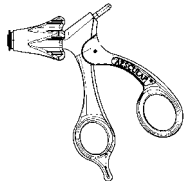



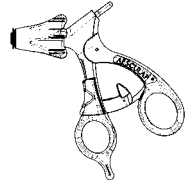



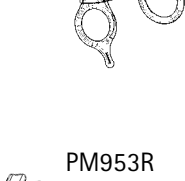

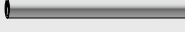

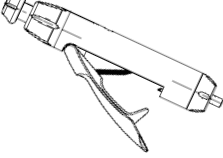

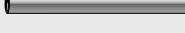

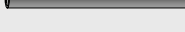

| SINGLE PARTS  |   |   | INDIVIDUAL COMPONENTS   |   |
|---|---|---|---|---|
| Jaw insert  | Insulated outer tube  | Handle  |   |   |
| P0632R<br>   | PM970R<br>   | P0958R<br>   | PM971R<br><br>Ø 5/10 mm   | P0958R<br>   |
| P0608R<br>   | PM973R<br>   | P0958R<br>   | PM975R<br><br>Ø 5/10 mm   | P0959R<br>   |
| P0752R<br>   | PM981R<br>   | P0958R<br>  |   |   |
| PM699R<br> | PM973R<br> | P0958R<br> | PM975R<br><br>Ø 5/10 mm | PM953R<br> |
| P0717R<br> | PM973R<br> | P0958R<br> |   | PM954R<br> |
| P0718R<br> | PM981R<br> | P0958R<br> |   | PM957R<br> |

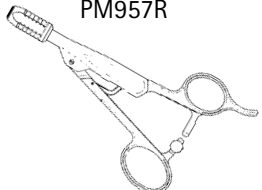
# AdTec® MONOPOLAR

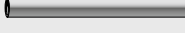
GRASPING FORCEPS

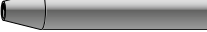

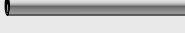
|   |   | COMPLETE INSTRUMENT |
|---|---|---------------------|
|    | <b>PO233R</b>   | 5 mm / 310 mm       |
|   | Atraumatic universal forceps with grooves                   |                     |
|    | <b>PO234R</b>   | 5 mm / 420 mm       |
|   | Atraumatic universal forceps with grooves                   |                     |
|   | <b>PO235R</b>   | 5 mm / 310 mm       |
|   | Atraumatic universal forceps with grooves                   |                     |
|  | <b>PO236R</b>   | 5 mm / 420 mm       |
|   | Atraumatic universal forceps with grooves                   |                     |
|  | <b>PO216R</b>   | 5 mm / 310 mm       |
|   | Atraumatic grasping forceps, jaw part fenestrated           |                     |
|  | <b>PO217R</b>   | 5 mm / 420 mm       |
|   | Atraumatic grasping forceps, jaw part fenestrated           |                     |
|  | <b>PO128R</b>   | 5 mm / 310 mm       |
|   | Atraumatic universal grasping forceps, jaw part fenestrated |                     |
|  | <b>PO229R</b>   | 5 mm / 420 mm       |
|   | Atraumatic universal grasping forceps, jaw part fenestrated |                     |





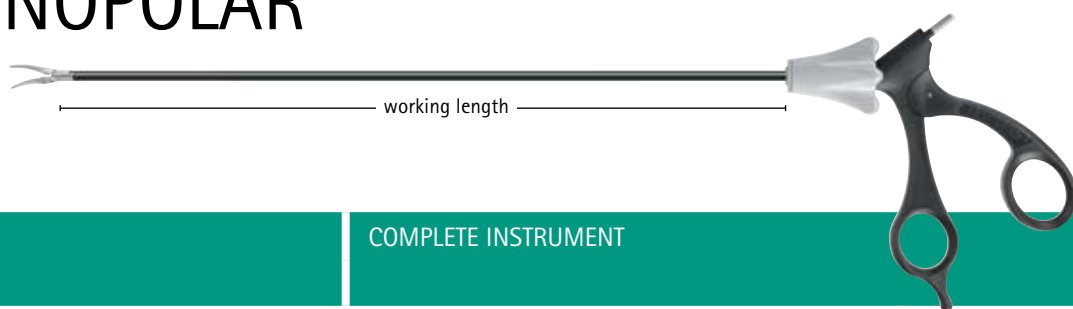

|  | SINGLE PARTS  |   |   | INDIVIDUAL COMPONENTS   |   |
|--|---|---|---|---|---|
|  | Jaw insert  | Insulated outer tube  | Handle  |   |   |
|  | P0786R<br>   | PM973R<br>   | P0959R<br>   | PM975R<br><br>Ø 5/10 mm   | P0958R<br>   |
|  | P0787R<br>   | PM981R<br>   | P0959R<br>   | PM975R<br><br>Ø 5/10 mm   | P0959R<br>  |
|  | P0788R<br>   | PM973R<br>   | P0959R<br>  | PM975R<br><br>Ø 5/10 mm   | P0958R<br>  |
|  | P0789R<br> | PM981R<br> | P0959R<br> |   | PM953R<br> |
|  | P0769R<br> | PM973R<br> | P0958R<br> | PM975R<br><br>Ø 5/10 mm | PM954R<br> |
|  | P0770R<br> | PM981R<br> | P0958R<br> |   | PM957R<br> |
|  | P0647R<br> | PM973R<br> | P0959R<br> | PM975R<br><br>Ø 5/10 mm |   |
|  | P0782R<br> | PM981R<br> | P0959R<br> | PM975R<br><br>Ø 5/10 mm |   |







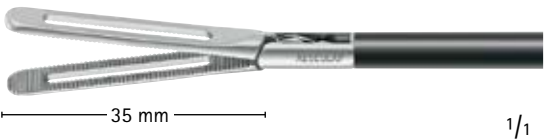







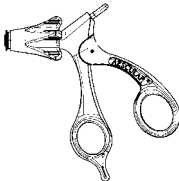



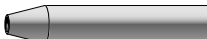
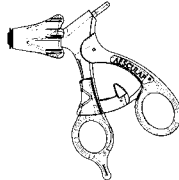

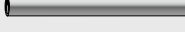

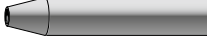
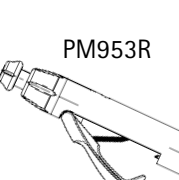

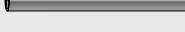

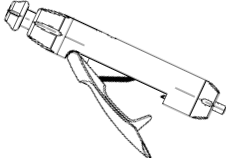

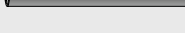

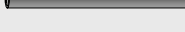

# AdTec® MONOPOLAR

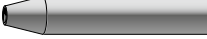
GRASPING FORCEPS

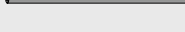

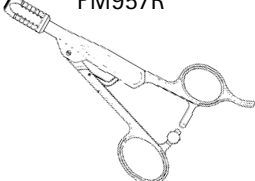
COMPLETE INSTRUMENT

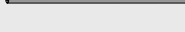
|  |  |
|--|--|
|  |  |
|  <p>30 mm</p>   | <p><b>P0191R</b> 5 mm / 310 mm<br/>           Universal fixation and dissecting forceps,<br/>           jaw part fenestrated<br/>           1/1</p>                        |
|  <p>30 mm</p>   | <p><b>P0185R</b> 5 mm / 310 mm<br/>           CROCE/OLMI<br/>           Atraumatic grasping forceps<br/>           1/1</p>   |
|  <p>30 mm</p>  | <p><b>P0232R</b> 5 mm / 310 mm<br/>           CROCE/OLMI<br/>           Atraumatic grasping forceps,<br/>           jaw part fenestrated<br/>           1/1</p>            |
|  <p>19 mm</p> | <p><b>P0222R</b> 5 mm / 310 mm<br/>           Short universal fixation and dissecting<br/>           forceps, jaw part fenestrated<br/>           1/1</p>                  |
|  <p>19 mm</p> | <p><b>P0223R</b> 5 mm / 420 mm<br/>           Short universal fixation and dissecting<br/>           forceps, jaw part fenestrated<br/>           1/1</p>                  |
|  <p>35 mm</p> | <p><b>P0112R</b> 5 mm / 310 mm<br/>           DORSEY<br/>           Intestinal grasping forceps<br/>           Instrument with protruding jaw parts<br/>           1/1</p> |
|  <p>35 mm</p> | <p>DORSEY 5 mm / 370 mm<br/>           Intestinal grasping forceps<br/>           Instrument with protruding jaw parts<br/>           1/1</p>                              |
|  <p>35 mm</p> | <p><b>P0204R</b> 5 mm / 420 mm<br/>           DORSEY<br/>           Intestinal grasping forceps<br/>           Instrument with protruding jaw parts<br/>           1/1</p> |

|  | SINGLE PARTS  |   |   | INDIVIDUAL COMPONENTS   |   |
|--|---|---|---|---|---|
|  | Jaw insert  | Insulated outer tube  | Handle  |   |   |
|  | P0736R<br>   | PM973R<br>   | P0959R<br>   | PM975R<br><br>Ø 5/10 mm   | P0958R<br>   |
|  | P0728R<br>   | PM973R<br>   | P0959R<br>   | PM975R<br><br>Ø 5/10 mm   | P0959R<br>  |
|  | P0785R<br>  | PM973R<br>   | P0959R<br>  | PM975R<br><br>Ø 5/10 mm   | P0959R<br> |
|  | P0775R<br> | PM973R<br> | P0959R<br> | PM975R<br><br>Ø 5/10 mm | PM953R<br> |
|  | P0776R<br> | PM981R<br> | P0959R<br> |   | PM954R<br> |
|  | P0618R<br> | PM973R<br> | P0959R<br> | PM975R<br><br>Ø 5/10 mm |   |
|  | PM618R<br> | PM976R<br> | P0959R<br> | PM978R<br><br>Ø 5/10 mm | PM957R<br> |
|  | P0755R<br> | PM981R<br> | P0959R<br> |   |   |







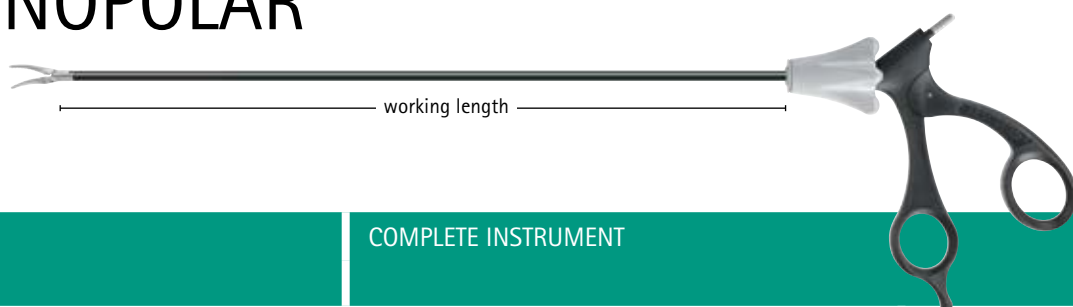





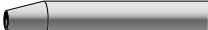
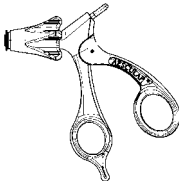



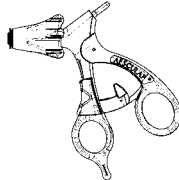



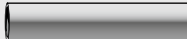

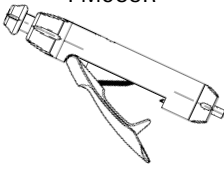



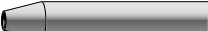

# AdTec® MONOPOLAR

GRASPING FORCEPS

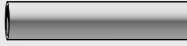

|   |               | COMPLETE INSTRUMENT  |  |
|---|---------------|--|--|
|    | <b>P0113R</b> | BABCOCK<br>Tissue-grasping forceps                                     | 5 mm / 310 mm                            |
|   | 33 mm         | 1/1  |  |
|    |               | BABCOCK<br>Tissue-grasping forceps                                     | 5 mm / 310 mm                            |
|   | 31 mm         | 1/1  | For use with flexible 13 mm trocars only |
|   | <b>P0114R</b> | BABCOCK<br>Tissue-grasping forceps                                     | 10 mm / 310 mm                           |
|   | 34 mm         | 1/1  |  |
|  | <b>P0205R</b> | BABCOCK<br>Tissue-grasping forceps                                     | 10 mm / 420 mm                           |
|   | 34 mm         | 1/1  |  |
|  | <b>P0212R</b> | BABCOCK<br>Tissue-grasping forceps                                     | 5 mm / 310 mm                            |
|   | 30 mm         | 1/1  |  |
|  | <b>P0209R</b> | BABCOCK<br>Tissue-grasping forceps                                     | 5 mm / 420 mm                            |
|   | 30 mm         | 1/1  |  |
|  | <b>P0196R</b> | BABCOCK<br>Tissue-grasping forceps                                     | 10 mm / 370 mm                           |
|   | 49 mm         | 1/1  |  |
|  | <b>P0197R</b> | MEYER<br>Tissue grasping and manipulation forceps,<br>jaw length 90 mm | 10 mm / 370 mm                           |
|   | 95 mm         | 3/4  |  |

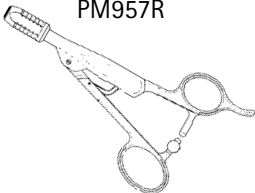
| SINGLE PARTS  |   |   | INDIVIDUAL COMPONENTS   |   |
|---|---|---|---|---|
| Jaw insert  | Insulated outer tube  | Handle  |   |   |
| P0619R<br>   | PM973R<br>   | P0959R<br>   | PM975R<br><br>Ø 5/10 mm   | P0958R<br>   |
| PM640R<br>   | PM973R<br>   | P0959R<br>   | PM975R<br><br>Ø 5/10 mm   | P0959R<br>  |
| P0620R<br>  | PM974R<br>  | P0959R<br>  |   |   |
| P0757R<br> | PM982R<br> | P0959R<br> |   | PM953R<br> |
| P0765R<br> | PM973R<br> | P0959R<br> | PM975R<br><br>Ø 5/10 mm | PM954R<br> |
| P0762R<br> | PM981R<br> | P0959R<br> |   |   |
| P0741R<br> | PM977R<br> | P0959R<br> |   |   |
| P0742R<br> | PM977R<br> | P0959R<br> |   | PM957R<br> |

# FESS, Rhinology, Rhinoplasty – FESS, Rhinologie, Septum- und Nasenplastik

## Nasal Scissors, Micro Scissors

### Nasenscheren, Mikro-Schere



- The LUER-Lock flushing ports of tubular shaft instruments allow easy cleaning of the instruments as well as lubrication with a steam permeable oil (e.g. Aesculap Sterilit®).
- Die LUER-Lock Spülanschlüsse bei Rohrschaft Instrumenten ermöglichen eine einfache Reinigung der Instrumente, sowie die Pflege mit einem dampfdurchlässigen Öl (z.B. Aescuclap Sterilit®).

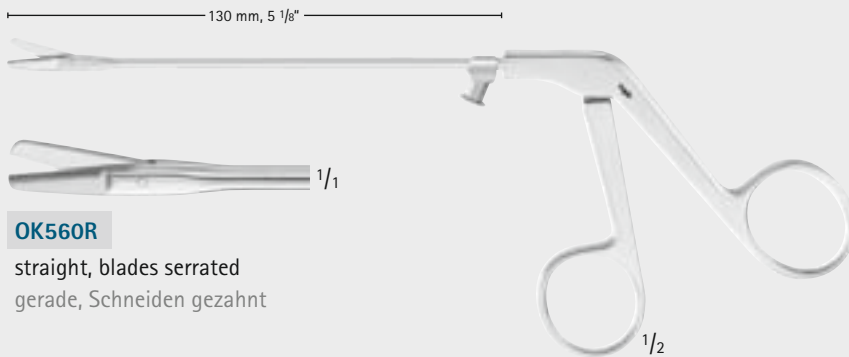

**OK560R**

straight, blades serrated  
gerade, Schneiden gezahnt



**OK561R**

left curved, blades serrated  
links gebogen, Schneiden gezahnt



**OK562R**

right curved, blades serrated  
rechts gebogen, Schneiden gezahnt

**OK560R-OK562R**

Nasal scissors  
Nasenscheren

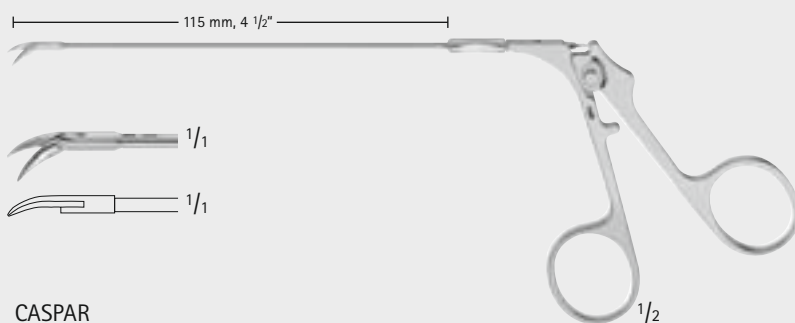

CASPAR

**FD228R**

Micro scissors, curved rotatable 360°,  
detachable for cleaning  
Mikro-Schere, gebogen, 360° drehbar,  
zerlegbar zur Reinigung

## FESS, Rhinology, Rhinoplasty – FESS, Rhinologie, Septum- und Nasenplastik

### Nasal Polypus Snare, Wire Loops For Nasal Snares

### Nasenpolypenschnürer, Schlingen für Nasenpolypenschnürer



**KRAUSE**  
**OK260R-OK262R**  
 Nasal Polypus snare, angled  
 Nasenpolypenschnürer, kniegebogen  
 250 mm, 9 3/4"

**OK261R**  
 Tube only  
 Rohraufsatz alleine

**OK262R**  
 Wire guide only  
 Drahtführer alleine

**KRAUSE-VOSS**  
**OK263R**  
 Nasal polypus snare, angled, complete with  
 OK264R tube vertical, OK265R tube horizontal  
 Nasenpolypenschnürer, kniegebogen, komplett mit  
 OK264R Rohraufsatz vertikal, OK265R Rohraufsatz horizontal  
 250 mm, 9 3/4"

**WILDE**  
**OK270R**  
 Nasal polypus snare, bayonet shaped  
 Nasenpolypenschnürer, bayonettförmig gebogen  
 250 mm, 9 3/4"

**OK293R**  
 Wire loops for nasal snares,  
 diam. 0.3 mm  
 Sales unit: PAK = Package of 100 pieces  
 Schlingen für Nasenpolypenschnürer,  
 Ø 0,3 mm  
 Bestelleinheit: PAK = Packung à 100 Stück



For more information please see our brochure no. C46811.



Weitere Informationen finden Sie in unserem Prospekt C46811.

| Order number<br>Artikelnummer              | Description<br>Beschreibung | for Clip Size<br>für Clipgröße | Diameter<br>Durchmesser | Shaft length<br>Schaftlänge |
|--|-----------------------------|--------------------------------|-------------------------|-----------------------------|
| <b>Clip Appliers<br/>Clip Anlegezangen</b> |                             |                                |                         |                             |
| PL504R                                     |                             | Medium                         | 10 mm                   | 330 mm                      |
| PL503R                                     |                             | Medium-large                   | 10 mm                   | 330 mm                      |
| PL528R                                     |                             | Large                          | 12 mm                   | 330 mm                      |

| Order number<br>Artikelnummer                          | Description<br>Beschreibung | Clip Size<br>Clipgröße | Clip length<br>Cliplänge | Clip width<br>Clipbreite | Color code<br>Farbmarkierung |
|--|-----------------------------|------------------------|--------------------------|--------------------------|------------------------------|
| <b>Titanium Ligation-Clips<br/>Titan Ligatur-Clips</b> |                             |                        |                          |                          |                              |
| PL567T   |                             | Medium                 | 4.9 mm                   | 6.2 mm                   | blue<br>blau                 |
| PL568T   |                             | Medium-large           | 7.8 mm                   | 8.8 mm                   | green<br>grün                |
| PL561T   |                             | Large                  | 10.8 mm                  | 11.3 mm                  | orange<br>orange             |

# AESCULAP® SPECIAL ENDOSCOPIC INSTRUMENTATION FOR LAPAROSCOPY

## Accessories // Zubehör

| Order number<br>Artikelnummer | Description<br>Beschreibung   | Diameter<br>Durchmesser | Shaft Length<br>Schaftlänge |
|-------------------------------|---|-------------------------|-----------------------------|
| BN320R                        | Exploratory probe with retention function and scaling<br>Tastsonde mit Rückhaltefunktion und Skalierung | 5 mm                    | 400 mm                      |
|                               |                       |                         |                             |
| BN321R                        | Exploratory probe with retention function and scaling<br>Tastsonde mit Rückhaltefunktion und Skalierung | 5 mm                    | 500 mm                      |
|                               |                       |                         |                             |
| BN322R                        | Exploratory probe with scaling<br>Taststab mit Skalierung   | 3.5 mm                  | 400 mm                      |
|                               |                      |                         |                             |

| Order number<br>Artikelnummer | Description<br>Beschreibung  | Diameter<br>Durchmesser | Shaft Length<br>Schaftlänge |
|-------------------------------|--|-------------------------|-----------------------------|
|                               | <i>Gall bladder extractor for assisting the recovery process extends the abdominal access.</i><br><i>Gallenblasen-Extraktor zur Unterstützung des Bergevorganges, dient der Erweiterung des abdominalen Zugangs.</i> |                         |                             |
| BV941R                        | Gall bladder extractor with 3 blades (blade length: 55 mm)<br>for use with a 10 mm trocar<br><br>Gallenblasen-Extraktor mit 3 Blättern (Blattlänge: 55 mm)<br>zum Einsatz mit einem 10 mm Trokar                     |                         |                             |
|                               |   |                         |                             |

# AESCULAP® SPECIAL ENDOSCOPIC INSTRUMENTATION FOR LAPAROSCOPY

## ENDOSCOPIC SUTURE INSTRUMENTS // ENDOSKOPISCHE NAHTINSTRUMENTE

| Order number<br>Artikelnummer | Description<br>Beschreibung   | Diameter<br>Durchmesser | Length<br>Länge |
|-------------------------------|---|-------------------------|-----------------|
| PL162R                        | <p>Fascial suture instrument for subcutaneous closure of trocar incisions.<br/>Reduces the risk of postoperative hernias when using trocars with diam. <math>\geq 10</math> mm<sup>1,2</sup>.</p> <p>Nahtinstrument zum subkutanen Faszienschluß von Trokarinzisionen.<br/>Reduziert das Risiko von postoperativen Hernien bei Verwendung von Trokaren mit Durchmesser <math>\geq 10</math> mm<sup>1,2</sup>.</p> | 2.5 mm                  | 170 mm          |

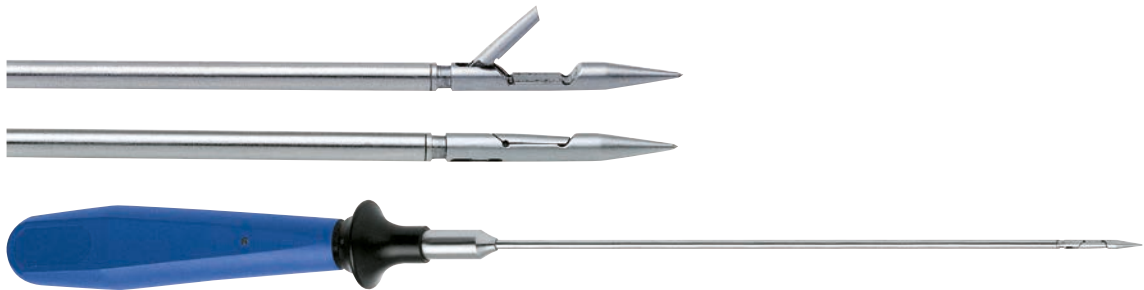

<sup>1</sup> Comajuncos J, Vallverdu H, Orbeal R, Pares D. Trocar site incisional hernia in laparoscopic surgery. CIR ESP. 2011 Feb;89(2):72-6.  
<sup>2</sup> Uslu HY, Erkek AB, Cakmak A, Kepenekci I, Sozener U, Kocayay FA, Turkcapar AG, Kuterdem E. Trocar site hernia after laparoscopic cholecystectomy. J Laparoendosc Adv Surg Tech A. 2007 Oct;17(5):600-3.

|        |  |  |  |
|--------|--|--|--|
| PL163R | <p>Shaft only for PL162R consisting of: outer tube, inner tube and jaw insert<br/>Schaft allein für PL162R bestehend aus: Außenrohr, Innenrohr und Mauleinsatz</p> |  |  |
|--------|--|--|--|

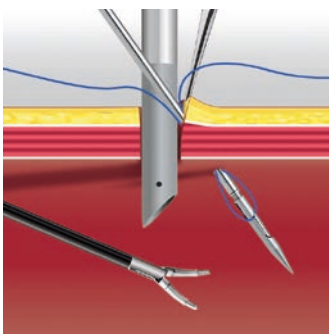

**Pic. 1:**  
The suture material held by the jaw part of the instrument will be placed under endoscopic visual control through all subcutaneous tissue layers into the abdominal cavity.

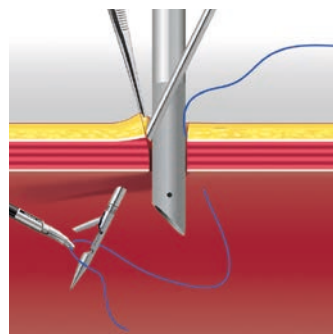

**Pic. 2 and 3:**  
The suture material will then be grasped by a holding forceps. The instrument will be introduced into the pneumoperitoneum in the same way at the opposite of the first approach.

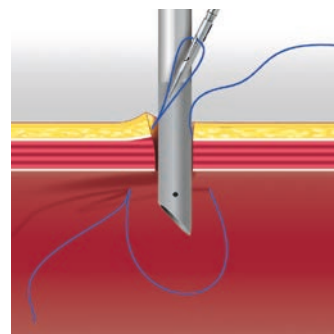

The suture material is being grasped by the fascial closure instrument and pulled through all tissue layers.

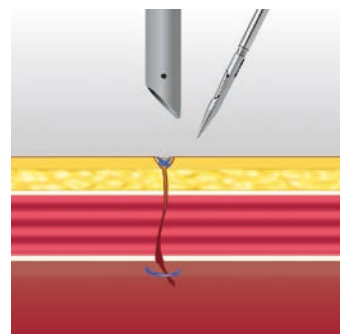

**Pic. 4:**  
The trocar is being removed and the tightened suture material closed by conventional knot technique.

**Bild 1:**  
Das im Maul des Nahtinstruments fixierte Nahtmaterial wird unter endoskopischer Sicht durch alle Schichten des subkutanen Gewebes in die abdominale Kavität gebracht.

**Bild 2 und 3:**  
Übergabe des Nahtmaterials an die Haltezange. Gegenüberliegender Einstich des Nahtinstruments durch alle Schichten des subkutanen Gewebes in die abdominale Kavität.

Das Nahtmaterial wird in das Nahtinstrument übergeben und durch alle Gewebeschichten gezogen.

**Bild 4:**  
Der Trokar wird entfernt. Das Nahtmaterial wird angezogen und konventionell verknotet.







# Needle Holders and Suturing



| Extracorporeal | Description  | Item No.                   | Diam.  | Length |
|----------------|--|----------------------------|--------|--------|
| 1/1            | Durogrip™ needle holder, straight, tungsten carbide inserts (PO959R handle)  | PO550R                     | 5 mm   | 31 cm  |
| 1/1            | Durogrip needle holder, curved tungsten carbide inserts (PO959R handle)  | PO559R                     | 5 mm   | 31 cm  |
| 1/1            | Knot pushing forceps   | PM654R<br>PM973R<br>PO958R | 5 mm   | 31 cm  |
| 1/1            | CROCE/OLMI Dissecting and suture scissors with knot pusher (PO958R handle)   | PO022R                     | 5 mm   | 31 cm  |
|                | Knot Pusher  | PL651R                     | 5 mm   | 31 cm  |
|                | Knot pusher  | PL435R                     | 3.5 mm | 31 cm  |
|                |  | PL432R                     | 5 mm   | 31 cm  |
| 3/1            | Suture hook for intracorporeal tightening of the suture line by pulling on the suture throws in case of continuous anastomosis | PO193R                     | 5 mm   | 33 cm  |
|                | Loop applicator, 4.5 mm inner diameter   | PL650R                     | 5 mm   | 15 cm  |
|                | Sealing cap, box of 20   | PL650250                   |        |        |





| Intracorporeal   | Description  | Item No. | Diam.  | Length |
|--|--|----------|--------|--------|
| <br>1/1   | Durogrip™ TC needle holder, straight                                 | PL419R   | 3.5 mm | 20 cm  |
|  |  | PL418R   | 3.5 mm | 29 cm  |
| <br>1/1   | Durogrip TC needle holder, straight                                  | PL407R   | 5 mm   | 31 cm  |
|  |  | PL404R   | 5 mm   | 37 cm  |
|  |  | PL416R   | 5 mm   | 42 cm  |
| <br>1/1   | Durogrip TC needle holder, curved left                               | PL408R   | 5 mm   | 31 cm  |
|  |  | PL405R   | 5 mm   | 37 cm  |
|  |  | PL417R   | 5 mm   | 42 cm  |
| <br>1/1  | Durogrip TC needle holder, curved right                              | PL413R   | 5 mm   | 31 cm  |
|  |  | PL415R   | 5 mm   | 37 cm  |
| <br>1/1 | "The Viper" Durogrip TC suture Assistant/ needle holder, 2 x 3 Teeth | PL409R   | 5 mm   | 31 cm  |
| <br>1/1 | Super righting needle holder   | PL414R   | 5 mm   | 31 cm  |
| <br>1/1 | Durogrip TC needle holder, fenestrated                               | PL410R   | 5 mm   | 31 cm  |
| <br>1/1 | Durogrip TC needle holder, crimped/ fenestrated                      | PL411R   | 5 mm   | 31 cm  |

# Retractors

|  | Description   | Item No. | Diam. | Length |
|--|---------------|----------|-------|--------|
|  | Fan retractor | PL680R   | 10 mm | 40 cm  |

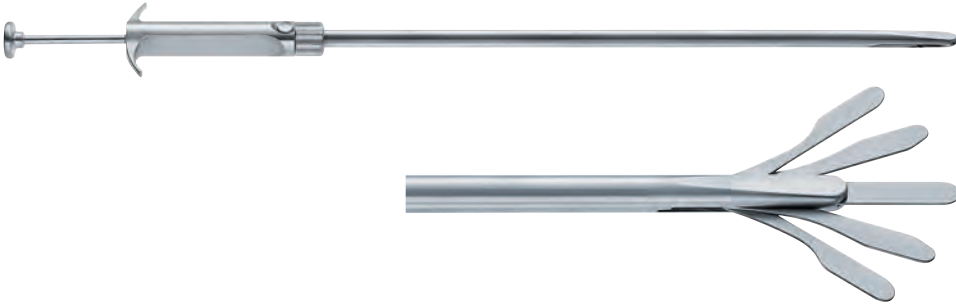

|  |                    |        |       |       |
|--|--------------------|--------|-------|-------|
|  | Prostate retractor | PL682R | 10 mm | 37 cm |
|--|--------------------|--------|-------|-------|



# Access Instruments

| Description  | Item No. | Diam.  | Length |
|--|----------|--------|--------|
| VERESS needle, single use, box of 20                     | EJ995    | 2.1 mm | 120 mm |
|  | EJ996    | 2.1 mm | 150 mm |
| VERESS needle with 1.6 mm (14 gauge) distal tip diameter | PG003    | 2.1 mm | 100 mm |
|  | PG008    | 2.1 mm | 120 mm |
|  | PG011    | 2.1 mm | 150 mm |
| Exploratory probe with scaling                           | BN320R   | 5 mm   | 40 cm  |
|  | BN321R   | 5 mm   | 50 cm  |
| Exploratory probe with scaling                           | BN322R   | 3.5 mm | 40 cm  |

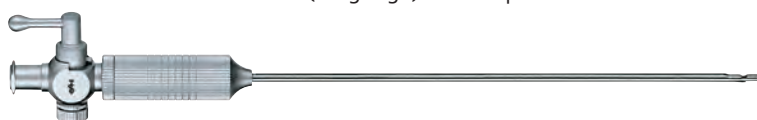

# Closure

| Port Closure Instrument | Description  | Item No. | Diam.  | Length |
|-------------------------|--|----------|--------|--------|
|                         | Fascial suture instrument for subcutaneous closure of trocar incisions. Prevents the risk of postoperative hernias when using 10 mm trocars or bigger. | PL162R   | 2.5 mm | 17 cm  |
|                         | Shaft only for PL162R consisting of: outer tube, inner tube and jaw insert   | PL163R   |        |        |

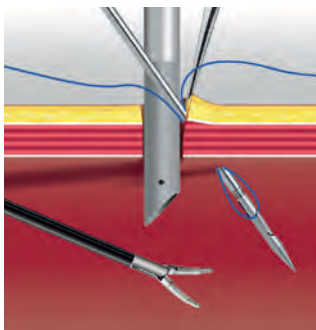
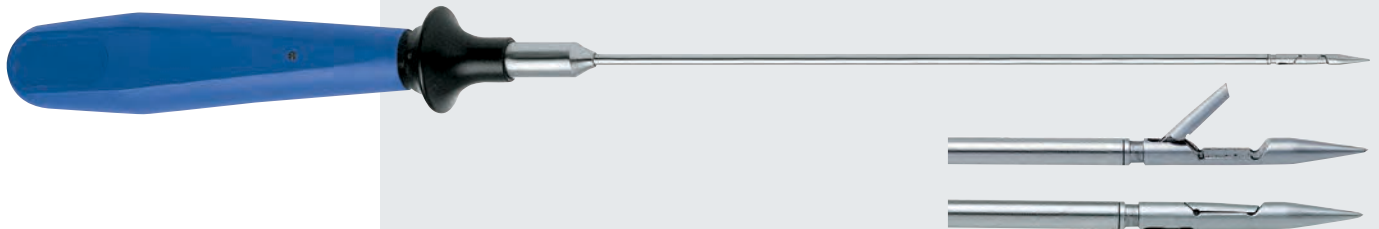

**Pic. 1:**  
The suture material hold by the jaw part of the instrument will be placed under endoscopic visual control through all subcutaneous tissue layers into the abdominal cavity.

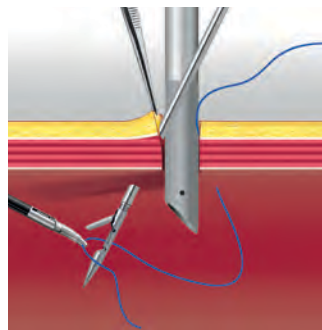

**Pic. 2 and 3:**  
The suture material will then be grasped by a holding forceps. The instrument will be introduced into the pneumoperitoneum in the same way at the opposite of the first approach.

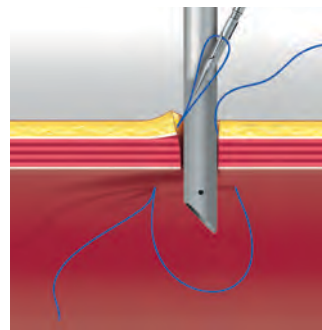

The suture material is being grasped by the fascial closure instrument and pulled through all tissue layers.

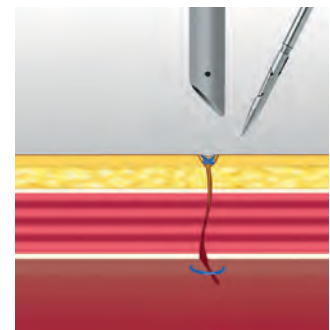

**Pic. 4:**  
The trocar is being removed and the tightened suture material closed by conventional knot technique.

# Aesculap® Valve XS

## Scissors



|  | Art. No.      | Version  | Jaw type                                 | Working length | Total length |
|--|---------------|----------|--|----------------|--------------|
| <br>1/1                      | <b>FC470R</b> | short    | 15° curved, 2 movable blades             | 175 mm         | 315 mm       |
|  | <b>FC265R</b> | standard |  | 235 mm         | 370 mm       |
|  | <b>FC370R</b> | long     |  | 285 mm         | 420 mm       |
| <br>1/1                    | <b>FC471R</b> | short    | 30° curved, 2 movable blades             | 175 mm         | 315 mm       |
|  | <b>FC266R</b> | standard |  | 235 mm         | 370 mm       |
|  | <b>FC371R</b> | long     |  | 285 mm         | 420 mm       |
| <br>1/1                    | <b>FC472R</b> | short    | 30° curved, 1 rigid and 1 movable blade  | 165 mm         | 300 mm       |
|  | <b>FC267R</b> | standard |  | 220 mm         | 360 mm       |
|  | <b>FC372R</b> | long     |  | 270 mm         | 410 mm       |
| <br>1/1                    | <b>FC473R</b> | short    | 70° curved, 2 movable blades             | 175 mm         | 310 mm       |
|  | <b>FC268R</b> | standard |  | 230 mm         | 370 mm       |
|  | <b>FC373R</b> | long     |  | 280 mm         | 420 mm       |
| <br>POTTS-DIETHRICH<br>1/1 | <b>FC474R</b> | short    | 45° angled, 1 rigid and 1 movable blade  | 155 mm         | 295 mm       |
|  | <b>FC269R</b> | standard |  | 215 mm         | 355 mm       |
|  | <b>FC374R</b> | long     |  | 265 mm         | 405 mm       |
| <br>POTTS-DIETHRICH<br>1/1 | <b>FC475R</b> | short    | 125° angled, 1 rigid and 1 movable blade | 150 mm         | 285 mm       |
|  | <b>FC271R</b> | standard |  | 205 mm         | 345 mm       |
|  | <b>FC375R</b> | long     |  | 255 mm         | 395 mm       |

| Blade length | Shaft diameter |
|--------------|----------------|
| 15 mm        | 5 mm           |
| 15 mm        | 5 mm           |
| 10 mm        | 5 mm           |
| 15 mm        | 5 mm           |
| 12 mm        | 3.5 mm         |
| 8 mm         | 3.5 mm         |



**FC470R - FC475R**

Short version

**FC265R - FC271R**

Standard version

**FC370R - FC375R**





Long version

# Aesculap® Valve XS

## Needleholders



with catch and tungsten carbide inserts

|   | Art. No.      | Version  | Jaw type | Recommended suture size | Working length | Total length |
|---|---------------|----------|----------|-------------------------|----------------|--------------|
| <br>1/1                   | <b>FC478R</b> | short    |          |                         | 170 mm         | 305 mm       |
|   | <b>FC275R</b> | standard | straight | 2/0, e.g. Premicron®    | 225 mm         | 365 mm       |
|   | <b>FC378R</b> | long     |          |                         | 275 mm         | 415 mm       |
| <br>1/1                 | <b>FC479R</b> | short    |          |                         | 170 mm         | 305 mm       |
|   | <b>FC276R</b> | standard | curved   | 2/0, e.g. Premicron®    | 225 mm         | 365 mm       |
|   | <b>FC379R</b> | long     |          |                         | 275 mm         | 415 mm       |
| <br>1/1                 | <b>FC480R</b> | short    |          |                         | 170 mm         | 305 mm       |
|   | <b>FC277R</b> | standard | curved   | 2/0, e.g. Premicron®    | 225 mm         | 365 mm       |
|   | <b>FC380R</b> | long     |          |                         | 275 mm         | 415 mm       |
| "RYDER type"<br><br>1/1 | <b>FC481R</b> | short    |          |                         | 170 mm         | 305 mm       |
|   | <b>FC278R</b> | standard | straight | 5/0 and smaller         | 225 mm         | 365 mm       |
|   | <b>FC381R</b> | long     |          |                         | 275 mm         | 415 mm       |
| "Mini-Jaw"<br><br>1/1   | <b>FC482R</b> | short    |          |                         | 160 mm         | 300 mm       |
|   | <b>FC279R</b> | standard | curved   | 5/0 and smaller         | 220 mm         | 360 mm       |
|   | <b>FC382R</b> | long     |          |                         | 270 mm         | 410 mm       |

| Jaw size     | Shaft diameter |
|--------------|----------------|
| 3.0 x 8.0 mm | 5 mm           |
| 3.0 x 8.0 mm | 5 mm           |
| 2.0 x 8.0 mm | 5 mm           |
| 1.5 x 7.0 mm | 5 mm           |
| 1.5 x 6.0 mm | 2.7 mm         |



**FC478R - FC482R**

Short version

**FC275R - FC279R**

Standard version

**FC378R - FC382R**

Long version



# Aesculap® Valve XS

## Forceps



DeBakey toothing



1/1



1/1



1/1

RESANO  
toothing



1/1



1/1



1/1

Suture forceps



1/1

Knot pusher



1/1

| Art. No.      | Version  | Jaw type, jaw size                                 | Working length |
|---------------|----------|--|----------------|
| <b>FC485R</b> | short    | straight, 1.5 x 11.0 mm jaw serration              | 175 mm         |
| <b>FC285R</b> | standard |  | 230 mm         |
| <b>FC385R</b> | long     |  | 280 mm         |
| <b>FC486R</b> | short    | 45° upwards angled,<br>1.5 x 15.0 mm jaw serration | 170 mm         |
| <b>FC286R</b> | standard |  | 230 mm         |
| <b>FC386R</b> | long     |  | 280 mm         |
| <b>FC487R</b> | short    | 45° angled to side, 1.5 x 15.0 mm jaw serration    | 170 mm         |
| <b>FC287R</b> | standard |  | 230 mm         |
| <b>FC387R</b> | long     |  | 280 mm         |
| <b>FC488R</b> | short    | straight, 3.0 x 16.0 mm jaw serration              | 175 mm         |
| <b>FC288R</b> | standard |  | 230 mm         |
| <b>FC388R</b> | long     |  | 280 mm         |
| <b>FC489R</b> | short    | straight, 2.8 x 11.0 mm jaw serration              | 175 mm         |
| <b>FC289R</b> | standard |  | 230 mm         |
| <b>FC389R</b> | long     |  | 280 mm         |
| <b>FC490R</b> | short    | straight, 1.5 x 11.0 mm jaw serration              | 170 mm         |
| <b>FC290R</b> | standard |  | 230 mm         |
| <b>FC390R</b> | long     |  | 280 mm         |
| <b>FC491R</b> | short    | straight, 8.0 mm jaw                               | 170 mm         |
| <b>FC291R</b> | standard |  | 225 mm         |
| <b>FC391R</b> | long     |  | 280 mm         |
| <b>FC492R</b> | short    | 45° angled   | 175 mm         |
| <b>FC292R</b> | standard |  | 230 mm         |
| <b>FC392R</b> | long     |  | 280 mm         |

| Total length               | Shaft diameter | Miscellaneous                                |
|----------------------------|----------------|--|
| 310 mm<br>365 mm<br>415 mm | 5 mm           | -  |
| 310 mm<br>365 mm<br>415 mm | 5 mm           | 1 rigid and 1 movable jaw part               |
| 310 mm<br>365 mm<br>415 mm | 5 mm           | 1 rigid and 1 movable jaw part               |
| 310 mm<br>370 mm<br>420 mm | 5 mm           | 1 rigid and 1 movable jaw part               |
| 310 mm<br>370 mm<br>420 mm | 5 mm           | -  |
| 310 mm<br>365 mm<br>415 mm | 3 mm           | malleable shaft                              |
| 305 mm<br>365 mm<br>415 mm | 5 mm           | suture forceps with tungsten carbide inserts |
| 310 mm<br>370 mm<br>420 mm | 5 mm           | knot pusher                                  |



**FC485R - FC492R**

Short version

**FC285R - FC292R**

Standard version

**FC385R - FC392R**

Long version

INCHES

· specially hardened cutting edges



**LX159NR**

for hard wire with diam. maximum up to 1.5 mm  
180 mm, 7"

· specially hardened cutting edges

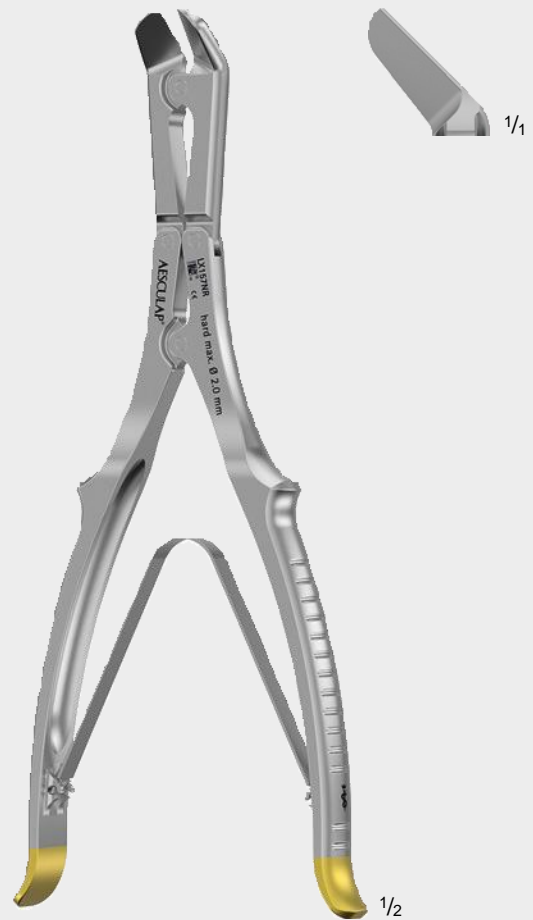





**LX157NR**

for hard wire with diam. maximum up to 2.0 mm  
240 mm, 9 1/2"

| Reducing sleeves | Working length | Diameter | Guide | Sealing caps |
|------------------|----------------|----------|-------|--------------|
|------------------|----------------|----------|-------|--------------|



|        |        |       |        |          |                 |
|--------|--------|-------|--------|----------|-----------------|
| PL650R | 150 mm | 5 mm  | 4 mm   | PL650250 | Pack of 20 pcs. |
| EJ601R | 165 mm | 10 mm | 5.5 mm | EJ601250 | Pack of 20 pcs. |
| EJ602R | 165 mm | 13 mm | 5.5 mm | EJ602203 | Pack of 1 pc.   |
| EJ604R | 165 mm | 13 mm | 10 mm  | EJ645P   | Pack of 20 pcs. |
| EJ614R | 190 mm | 20 mm | 10 mm  | EJ624P   | Pack of 10 pcs. |

| Order number | Description                     |   | Diameter |
|--------------|---------------------------------|---|----------|
| EJ446255     | Sealing cap,<br>pack of 20 pcs. |    | 5.5 mm   |
| EJ449255     |                                 |  | 10.0 mm  |
| EJ450255     |                                 |  | 12.5 mm  |
| EJ643P       |                                 |  | 13.0 mm  |

Sealing cap set, pack of 5 pcs.

**EJ640P**

(green) for diam.  
5 mm / 10 mm

**EJ641P**

(black) for diam.  
5 mm / 10 mm / 12.5 mm

**EJ642P**

(yellow) for diam.  
5 mm / 10 mm / 13 mm

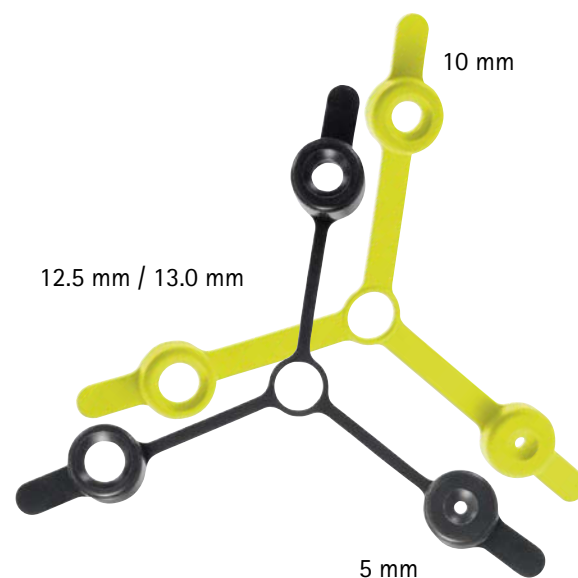

# AESFULAP<sup>®</sup> MIT-System

MULTI INTERCHANGEABLE TROCAR-SYSTEM

Ø 10 mm



## SILICONE FLAP VALVE

- Less instrument friction
- No damage to telescope and instrument tips
- Safe CO<sub>2</sub> seal



## MANUAL FLAP VALVE

- Trocar body with manual opening mechanism for 5 and 10 mm trocars
- Compatible to all rigid trocar shafts
- Functional reliability in the removal of resected materials

## TROCAR BODY



### EJ750R

Standard trocar body  
diam. 10 mm

1 piece

for 10 mm instruments

### EJ760R

Special trocar body (manual opening)  
diam. 10 mm

1 piece

for 10 mm instruments

# INDIVIDUAL TROCAR CONFIGURATION

## TROCAR SHAFT

stainless steel

plastic, black



**EJ752R**

smooth  
110 mm

**EJ762R**

smooth  
150 mm

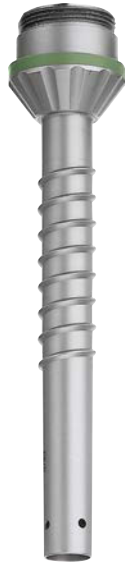

**EJ753R**

with thread  
110 mm



**EJ754P**

with thread  
110 mm

**EJ764P**

with thread  
150 mm

## OBTURATOR



**EJ775R**

triangular  
110 mm

**EJ765R**

triangular  
150 mm



**EJ756R**

conical sharp  
110 mm

**EJ766R**

conical sharp  
150 mm



**EJ558R**

conical blunt  
110 mm

**EJ568R**

conical blunt  
150 mm



**Project Overview**

**Description of Similarity:**

equal – the same article

like – nearly equal but with some slight differences

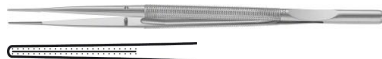
maybe – only as an alternative

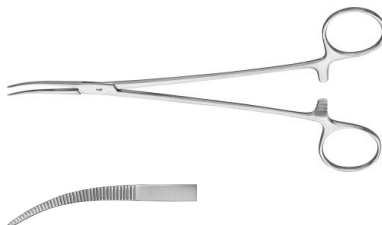
| Pos No. | Item Code | Description / Comment  | Qty. |
|---------|-----------|--|------|
| 10      | FM599R    | <p><b>(FM599R)</b><br/>Dia Dust® Micro Plateau Forceps, straight, platform tip, tungsten carbide coated, with weight, 210 mm (8 1/4")</p>  <p>Customer Reference: 4</p> | 2    |
| 20      | FM600R    | <p><b>(FM600R)</b><br/>DE BAKEY Atraumatic Micro Forceps, straight, toothing DE BAKEY, with weight, 210 mm (8 1/4")</p>  <p>Customer Reference: 5</p>                   | 2    |
| 30      | FM566R    | <p><b>(FM566R)</b><br/>Dia Dust® Micro Needle Holder, straight, 210 mm (8 1/4")</p>  <p>Customer Reference: 6</p>   | 2    |
| 40      | FM565R    | <p><b>(FM565R)</b><br/>Dia Dust® Micro Needle Holder, straight, 210 mm (8 1/4")</p>  <p>Customer Reference: 7</p>   | 2    |
| 50      | BH187R    | <p><b>(BH187R)</b><br/>JACOBSON Hemostatic Forceps, curved, 190 mm (7 1/2"), serrated</p>  <p>Customer Reference: 8</p>   | 5    |

**Project Overview**

**Description of Similarity:**

equal – the same article

like – nearly equal but with some slight differences

maybe – only as an alternative

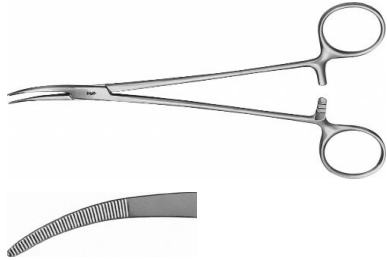
| Pos No. | Item Code | Description / Comment  | Qty. |
|---------|-----------|--|------|
| 60      | BH199R    | <p><b>(BH199R)</b><br/>NISSEN Hemostatic Forceps, curved, 185 mm (7 1/4"), serrated</p>  <p>Customer Reference: 9</p> | 5    |
| 70      | BH207R    | <p><b>(BH207R)</b><br/>HEISS Hemostatic Forceps, curved, 200 mm (7 7/8\" data-bbox="348 441 591 556"/&gt; <p>Customer Reference: 10</p> </p>   | 5    |
| 80      | BH165R    | <p><b>(BH165R)</b><br/>RANKIN Hemostatic Forceps, curved, 160 mm (6 1/4\" data-bbox="348 636 591 751"/&gt; <p>Customer Reference: 11</p> </p>  | 60   |





**Project Overview**

**Description of Similarity:**

equal – the same article

like – nearly equal but with some slight differences

maybe – only as an alternative

| Pos No. | Item Code | Description / Comment  | Qty. |
|---------|-----------|--|------|
| 90      | MD465R    | <p><b>(MD465R)</b><br/>COLLER Hemostatic Forceps, curved, 145 mm (5 1/2"), serrated</p>  <p>Customer Reference: 12</p>  | 40   |
| 100     | BH442R    | <p><b>(BH442R)</b><br/>ROCHESTER-PEAN Hemostatic Forceps, straight, 160 mm (6 1/4"), serrated</p>  <p>Customer Reference: 13</p>  | 60   |
| 110     | LX159NR   | <p><b>(LX159NR)</b><br/>SQ.LINE TC Wire Cutting Forceps, 180 mm (7\"), ergonomic handle, double articulated joint, up to Ø 1,5 mm, non-sterile, reusable</p>  <p>Customer Reference: 14</p> | 4    |



**Project Overview**

**Description of Similarity:**

equal – the same article

like – nearly equal but with some slight differences

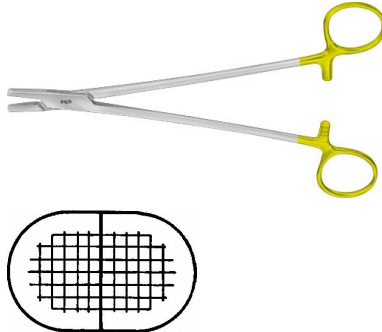
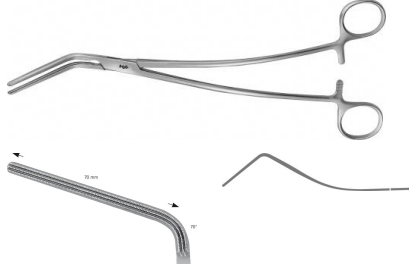
maybe – only as an alternative

| Pos No. | Item Code | Description / Comment  | Qty. |
|---------|-----------|--|------|
| 120     | BM112R    | <p><b>(BM112R)</b><br/>BAUMGARTNER DUROGRIP® Wire Twister, TC: yes, straight, 200 mm (8")</p>  <p>Customer Reference: 15</p>  | 4    |
| 130     | FB494R    | <p><b>(FB494R)</b><br/>DE BAKEY (MODIF. MORRIS) ATRAUMATA® Aorta Clamp, angled, 70 °, 240 mm (9 1/2"), tothing DE BAKEY, jaw length: 93 mm</p>  <p>Customer Reference: 16</p> | 3    |
| 140     | BD257R    | <p><b>(BD257R)</b><br/>Dressing Forceps (Tweezers), angled, serrated, 200 mm (7 7/8")</p>  <p>Customer Reference: 17</p>  | 6    |
| 150     | GF821R    | <p><b>(GF821R)</b><br/>COOLEY Suction Tube, 335 mm (13 1/4"), diam. 8 mm, non-sterile, reusable</p>  <p>Customer Reference: 18</p>  | 2    |





**Project Overview**

**Description of Similarity:**

equal – the same article

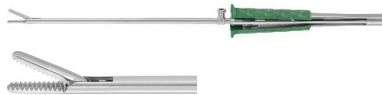
like – nearly equal but with some slight differences

maybe – only as an alternative

| Pos No. | Item Code | Description / Comment  | Qty. |
|---------|-----------|--|------|
| 160     | FC488R    | <p><b>(FC488R)</b><br/>VALVE XS Forceps, straight, 310 mm, working length: 175 mm , tothing RESANO, jaw length: 16 mm, shaft diam.: 5 mm, width: 3 mm</p>  <p>Customer Reference: 19</p>  | 1    |
| 170     | FC269R    | <p><b>(FC269R)</b><br/>POTTS-DIETHRICH VALVE XS Micro scissors, angled, 45 °, 355 mm (14"), working length: 215 mm (8 1/2"), diam. 3,50 mm, jaw length: 13 mm, sharp/sharp, Golfball design handle, round plastic handle, blue, single action, non-sterile, reusable</p>  <p>Customer Reference: 20</p> | 1    |
| 180     | FC268R    | <p><b>(FC268R)</b><br/>VALVE XS Micro scissors, curved, 70 °, 370 mm (14 1/2"), working length: 230 mm (9"), diam. 5 mm, jaw length: 15 mm, blunt/blunt, Golfball design handle, round plastic handle, blue, double action, non-sterile, reusable</p>  <p>Customer Reference: 21</p>                  | 1    |
| 190     | FC286R    | <p><b>(FC286R)</b><br/>VALVE XS Atraumatic Forceps, 45 °, angled upwards, 365 mm, working length: 230 mm , tothing De Bakey, jaw length: 15 mm, shaft diam.: 5 mm</p>  <p>Customer Reference: 22</p>  | 1    |
| 200     | FC276R    | <p><b>(FC276R)</b><br/>VALVE XS Needle Holder, TC: yes, curved, Ø 5 mm, 365 mm (14 3/8"), working length: 225 mm (8 7/8")</p>  <p>Customer Reference: 23</p>  | 1    |





**Project Overview**

**Description of Similarity:**

equal – the same article

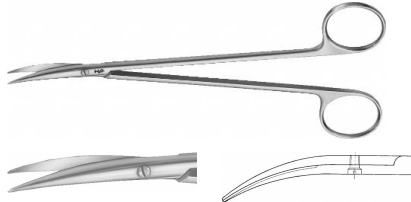
like – nearly equal but with some slight differences

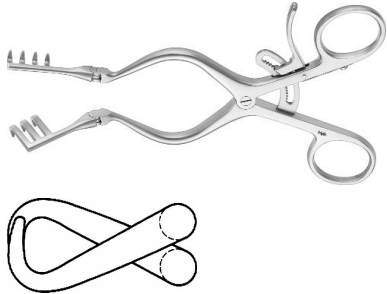
maybe – only as an alternative

| Pos No. | Item Code | Description / Comment   | Qty. |
|---------|-----------|---|------|
| 210     | BC629R    | <p><b>(BC629R)</b><br/>DE BAKEY Dissecting Scissors (Arteriotomy Scissors), curved, delicate pattern, blunt/blunt, 175 mm (6 7/8")</p>  <p>Customer Reference: 24</p>  | 10   |
| 220     | BC281WB   | <p><b>(BC281WB)</b><br/>NELSON-METZENBAUM Noir® Dissecting Scissors, curved, TC: yes, wave cut, blunt/blunt, 285 mm (11 1/4")</p>  <p>Customer Reference: 25</p>  | 2    |
| 230     | BV094R    | <p><b>(BV094R)</b><br/>ADSON (BABY) Retractor (Self Retaining), with joint, 165 mm (6 1/2"), 3 x 4 prongs, semi-sharp, non-sterile, reusable</p>  <p>Customer Reference: 26</p>  | 2    |
| 240     | PO028R    | <p><b>(PO028R)</b><br/>METZENBAUM (MINI) ADTEC MONOPOLAR TC Dissecting Scissors, complete instrument, monopolar, curved to left, working length: 420 mm (16 1/2"), diam. 5 mm, serrated (fine), blunt/blunt, rotatable, insulated, double action, consisting of PM981R, PO745R, PO958R, detachable, non-sterile, reusable</p>  <p>Customer Reference: 31</p> | 32   |



**Project Overview**

**Description of Similarity:**

equal – the same article

like – nearly equal but with some slight differences

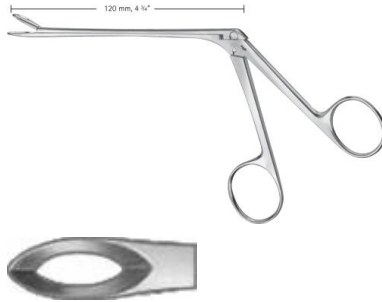
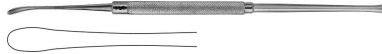
maybe – only as an alternative

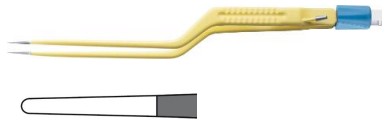
| Pos No. | Item Code | Description / Comment  | Qty. |
|---------|-----------|--|------|
| 250     | OK506R    | <p><b>(OK506R)</b><br/>WEIL-BLAKESELEY Rongeur, straight, 120 mm (4 3/4"), oval, fenestrated, width: 3,60 mm</p>  <p>Customer Reference: 38</p>                               | 4    |
| 260     | OL163R    | <p><b>(OL163R)</b><br/>FREER Elevator, curved, 190 mm (7 1/2"), blunt, width: 4 mm, non-sterile, reusable</p>  <p>Customer Reference: 39</p>                                | 5    |
| 270     | MD124R    | <p><b>(MD124R)</b><br/>FRAZIER Suction Cannula, curved, 110 mm (4 1/4"), diam. 2,30 mm, extra small, luer hub, non-sterile, reusable</p>  <p>Customer Reference: 45</p>     | 4    |
| 280     | GK845R    | <p><b>(GK845R)</b><br/>Bipolar Forceps, straight, 205 mm (8"), working length: 90 mm (3 1/2"), bayonet-shaped, insulated, width: 1,30 mm</p>  <p>Customer Reference: 46</p> | 2    |



**Project Overview**

**Description of Similarity:**

equal – the same article

like – nearly equal but with some slight differences

maybe – only as an alternative

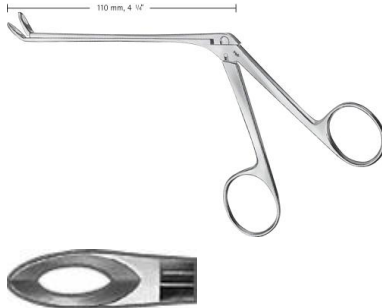
| Pos No. | Item Code | Description / Comment   | Qty. |
|---------|-----------|---|------|
| 290     | BD883R    | <p><b>(BD883R)</b><br/>GRUENWALD Dressing Forceps (Tweezers), straight, bayonet-shaped, serrated, 200 mm (7 7/8")</p>  <p>Customer Reference: 59</p>   | 5    |
| 300     | OK560R    | <p><b>(OK560R)</b><br/>Nasal Scissors, straight, working length: 130 mm (5 1/8"), serrated (one blade), vertical cutting, with tubular shaft, ring handle, single action, non-sterile, reusable</p>  <p>Customer Reference: 60</p> | 2    |
| 310     | OK260R    | <p><b>(OK260R)</b><br/>KRAUSE NASL POLYPUS SNAREKNEE-SHP250MM</p>  <p>Customer Reference: 61</p>   | 3    |
| 320     | OK520R    | <p><b>(OK520R)</b><br/>WEIL-BLAKESELEY Rongeur, 140 °, upwards cutting, 115 mm (4 1/2"), oval, fenestrated, width: 3,60 mm</p>  <p>Customer Reference: 62</p>  | 3    |





**Project Overview**

**Description of Similarity:**

equal – the same article

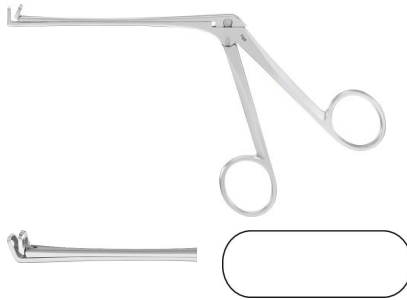
like – nearly equal but with some slight differences

maybe – only as an alternative

| Pos No. | Item Code | Description / Comment   | Qty. |
|---------|-----------|---|------|
| 330     | OK544R    | <p><b>(OK544R)</b><br/>BLAKESLEY Nasal Forceps, 90 °, upwards cutting, working length: 110 mm (4 1/2), width: 3,50 mm</p>  <p>Customer Reference: 63</p>                 | 3    |
| 340     | PG011     | <p><b>(PG011)</b><br/>Veress cannula, 2.1 mm diam., 150 mm, reusable, to be used with PG002; PG013; PG012; PG014; PG082</p>  <p>Customer Reference: 64</p>             | 24   |
| 350     | PL528R    | <p><b>(PL528R)</b><br/>Clip Applier Forceps, single-fire, 330 mm, diam. 12,50 mm, Size L, orange, reusable, to be used with: PL561T</p>  <p>Customer Reference: 67</p> | 11   |
| 360     | PL680R    | <p><b>(PL680R)</b><br/>Fan Retractor, 400 mm, diam. 10 mm, 5 fingers, non-sterile, reusable</p>  <p>Customer Reference: 69</p>   | 8    |
| 370     | PL651R    | <p><b>(PL651R)</b><br/>KNOT-TYING INSTRUMENT 5MM 330MM</p>  <p>Customer Reference: 70</p>  | 11   |







**Project Overview**

**Description of Similarity:**

equal – the same article

like – nearly equal but with some slight differences

maybe – only as an alternative

| Pos No. | Item Code | Description / Comment  | Qty. |
|---------|-----------|--|------|
| 380     | PL162R    | <p><b>(PL162R)</b><br/>Fascial suture Instrument, 2.5 mm diam., 170 mm, for subcutaneous closure of trocar incisions</p>   <p>Customer Reference: 71</p> | 6    |
| 390     | BN320R    | <p><b>(BN320R)</b><br/>Probe, straight, 400 mm, diam. 5 mm, reusable</p>  <p>Customer Reference: 72</p>   | 6    |
| 400     | PO222R    | <p><b>(PO222R)</b><br/>ADTEC MONOPOLAR Grasping Forceps, straight, 310 mm, diam. 5 mm, serrated, fenestrated, short, double action, consisting of PM973R, PO775R, PO959R, reusable</p>  <p>Customer Reference: 73</p>                   | 32   |
| 410     | PO769R    | <p><b>(PO769R)</b><br/>ADTEC MONOPOLAR Grasping Forceps, jaw inserts, straight, 310 mm, diam. 5 mm, toothing De Bakey, fenestrated, double action, reusable</p>  <p>Customer Reference: 74</p>  | 32   |
| 420     | PM973R    | <p><b>(PM973R)</b><br/>Insulated outer tube, PEEK, 5 mm diam., 310 mm, to be used with AdTec monopolar, AdTec bipolar</p>  <p>Customer Reference: 74</p>  | 32   |







**Project Overview**

**Description of Similarity:**

equal – the same article

like – nearly equal but with some slight differences

maybe – only as an alternative

| Pos No. | Item Code | Description / Comment  | Qty. |
|---------|-----------|--|------|
| 430     | PO959R    | <p><b>(PO959R)</b><br/>AdTec monopolar Standard ring handle, PEEK insulated, with ratchet, ratchet can be deactivated, to be used with PO182R</p>  <p>Customer Reference: 74</p>  | 32   |
| 440     | PO196R    | <p><b>(PO196R)</b><br/>BABCOCK ADTEC MONOPOLAR Organ Grasping Forceps, complete instrument, straight, working length: 370 mm (14 1/2"), diam. 10 mm, serrated, fenestrated, double action, consisting of PM977R, PO741R, PO959R, non-sterile, reusable</p>  <p>Customer Reference: 75</p> | 32   |
| 450     | PO717R    | <p><b>(PO717R)</b><br/>MARYLAND ADTEC MONOPOLAR Dissecting Forceps, jaw inserts, curved, 310 mm, diam. 5 mm, serrated (fine), double action, reusable</p>  <p>Customer Reference: 76</p>  | 32   |
| 460     | PM973R    | <p><b>(PM973R)</b><br/>Insulated outer tube, PEEK, 5 mm diam., 310 mm, to be used with AdTec monopolar, AdTec bipolar</p>  <p>Customer Reference: 76</p>  | 32   |





**Project Overview**

**Description of Similarity:**

equal – the same article

like – nearly equal but with some slight differences

maybe – only as an alternative

| Pos No. | Item Code | Description / Comment   | Qty. |
|---------|-----------|---|------|
| 470     | PO959R    | <p><b>(PO959R)</b><br/>AdTec monopolar Standard ring handle, PEEK insulated, with ratchet, ratchet can be deactivated, to be used with PO182R</p>  <p>Customer Reference: 76</p>   | 32   |
| 480     | PO232R    | <p><b>(PO232R)</b><br/>CROCE-OLMI ADTEC MONOPOLAR Grasping Forceps, complete instrument, straight, 310 mm, diam. 5 mm, serrated, fenestrated, single action, consisting of PM973R, PO785R, PO959R, reusable</p>  <p>Customer Reference: 77</p> | 14   |
| 490     | PL408R    | <p><b>(PL408R)</b><br/>ADTEC Needle Holder, TC: yes, complete instrument, curved to left, Ø 5 mm, working length: 310 mm (12 1/4")</p>  <p>Customer Reference: 78</p>  | 12   |
| 500     | PL407R    | <p><b>(PL407R)</b><br/>ADTEC Needle Holder, TC: yes, complete instrument, straight, Ø 5 mm, working length: 310 mm (12 1/4")</p>  <p>Customer Reference: 79</p>  | 2    |



**Project Overview**

**Description of Similarity:**

equal – the same article

like – nearly equal but with some slight differences

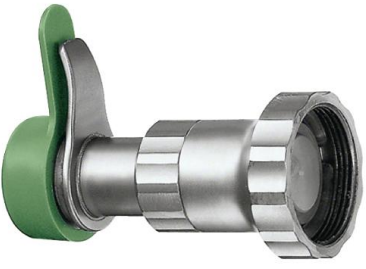
maybe – only as an alternative

| Pos No. | Item Code | Description / Comment  | Qty. |
|---------|-----------|--|------|
| 510     | EJ601R    | <p><b>(EJ601R)</b><br/>REDUCING SLEEVE D:10 MM TO 5.5 MM</p>  <p>Customer Reference: 80</p>   | 35   |
| 520     | EJ760R    | <p><b>(EJ760R)</b><br/>TROCAR BODY MANUAL OPENING W/INSUL.10MM</p>  <p>Customer Reference: 81.1</p>  | 73   |
| 530     | EJ752R    | <p><b>(EJ752R)</b><br/>Shaft for reusable trocar, stainless steel, smooth, green, 10 mm diam., 110 mm, with silicone flap valve, to be used with EJ755R; EJ 756R; EJ558R</p>  <p>Customer Reference: 81.1</p> | 73   |
| 540     | EJ756R    | <p><b>(EJ756R)</b><br/>Obturator for reusable trocar, sharp conical tip, 10 mm diam., 110 mm, to be used with EJ751R; EJ752R; EJ753R; EJ754P</p>  <p>Customer Reference: 81.2</p>                             | 48   |