

Specifications

Model Name		CL-S200BF : Protective Filter CL-S200BN : No Protective Filter	CL-S300BF : Protective Filter CL-S300BN : No Protective Filter
LCD Panel	Technology	21.3" color TFT IPS technology	21.3" color TFT IPS technology
	Display Area	324 mm × 432 mm	324.86 mm × 433.15 mm
	Pixel Pitch	0.270 mm × 0.270 mm	0.2115 mm × 0.2115 mm
	Contrast Ratio	1800 : 1 (typ.)	1500 : 1 (typ.)
	Maximum Luminance	1000 cd/m ² (typ.) 410 cd/m ² / 500 cd/m ² (calibrated)	1000 cd/m ² (typ.) 410 cd/m ² / 500 cd/m ² (calibrated)
	Viewing Angle	178° vertical and horizontal	178° vertical and horizontal
Visual Performance	Native Resolution	1200 × 1600	1536 × 2048
	Display Colors	16.77 million colors from a palette of 68 billion colors 1.07 billion colors with DisplayPort and 10-bit viewer	16.77 million colors from a palette of 68 billion colors 1.07 billion colors with DisplayPort and 10-bit viewer
Interface	Input Signal	DVI-D (DVI 1.0 compliant) DisplayPort (DisplayPort 1.2a compliant)	DVI-D (DVI 1.0 compliant) DisplayPort (DisplayPort 1.2a compliant)
	Output Signal	DisplayPort (DisplayPort 1.2a compliant)	DisplayPort (DisplayPort 1.2a compliant)
	Plug and Play	DDC2B compliant	DDC2B compliant
Input Power Supply	Input Power Supply	100 V - 240 V 50 / 60Hz	100 V - 240 V 50 / 60Hz
	Maximum Power Consumption	65 W (typ.)	95 W (typ.)
Features	Calibration Control	Luminance, Gamma, Color temperature Capable of storing 3 sets of LUT (Optional Calibration Kit is required)	Luminance, Gamma, Color temperature Capable of storing 3 sets of LUT (Optional Calibration Kit is required)
	OSD Information Display	Model name, Serial No., Total operating time, Calibration settings (Operating time since last calibration, Luminance, Gamma), Current Luminance, Color temperature and Ambient light, DICOM conformance	Model name, Serial No., Total operating time, Calibration settings (Operating time since last calibration, Luminance, Gamma), Current Luminance, Color temperature and Ambient light, DICOM conformance
	USB Hub	USB Rev.2.0 compliant, Self-powered USB upstream connector (x1), USB downstream connector (x2)	USB Rev.2.0 compliant, Self-powered USB upstream connector (x1), USB downstream connector (x2)
	Other Features	Uniformity Equalizer, Hardware pivot, LED indicator, Advanced power management, Human Presence Sensor, Dynamic Gamma, Auto Text Mode, Luminance stabilization, Multiple LUT, Self DICOM check, Self-calibration	Uniformity Equalizer, Hardware pivot, LED indicator, Advanced power management, Human Presence Sensor, Dynamic Gamma, Auto Text Mode, Luminance stabilization, Multiple LUT, Self DICOM check, Self-calibration
Approvals		ANSI/AAMI ES60601-1 (2005) + A1 (2012), CAN/CSA-C22.2 No. 60601-1 (2014), CE (EN60601-1, EN60601-1-2), RCM, FCC Part15 subpart B Class B, ICES-003-B, VCCI-B, FDA510(k), J-Moss, RoHS	ANSI/AAMI ES60601-1 (2005) + A1 (2012), CAN/CSA-C22.2 No. 60601-1 (2014), CE (EN60601-1, EN60601-1-2), RCM, FCC Part15 subpart B Class B, ICES-003-B, VCCI-B, FDA510(k), J-Moss, RoHS
Physical Characteristics	Dimensions (W × H × D)	Landscape : 493 mm × 451.3 / 546.3 mm × 196.5 mm Portrait : 361.5 mm × 517 / 612 mm × 196.5 mm	Landscape : 493 mm × 451.3 / 546.3 mm × 196.5 mm Portrait : 361.5 mm × 517 / 612 mm × 196.5 mm
	Weight	approx. 9 kg	approx. 10 kg
	Tilt Stand	Tilt, Swivel, Portrait / Landscape	Tilt, Swivel, Portrait / Landscape
	Mount	VESA standard (100 mm × 100 mm)	VESA standard (100 mm × 100 mm)
	Security Slot	Anti-theft security slot	Anti-theft security slot
Accessories		Power cord, DisplayPort cable, USB cable, Operation manual, Installation manual, Software (QA Medivisor Agent LE)	Power cord, DisplayPort cable, USB cable, Operation manual, Installation manual, Software (QA Medivisor Agent LE)

Dimensions (mm)

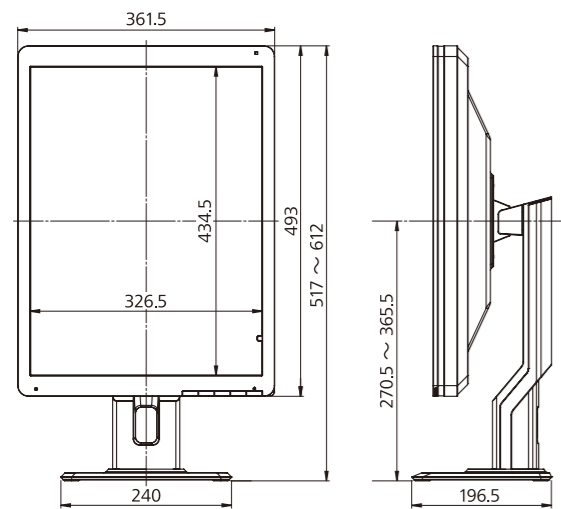

Interface

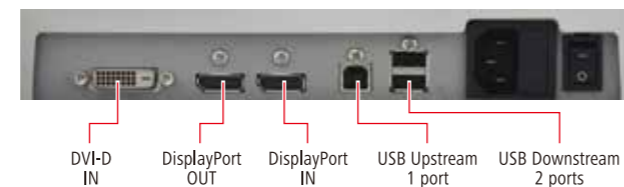

Options

Calibration Kit CAL-016

- Software
- Color Sensor



●“JVC” is a brand of medical and industrial monitors manufactured and sold by JVCKENWOOD Corporation. ●Company names and product names are the registered trademarks of the respective companies. ●Product specifications and appearance are subject to change without notice. ●Colors in photographs may differ from actual colors due to the printing process. ●Images on screens are simulated.

Safety Precautions

- Please read the user's manual for safe and proper use.
- Do not expose the product to dust, moisture, steam, or oily smoke. It could cause fire, electric shock, or a failure.

Please contact our distributor below with inquiries and orders.

Healthcare Business Division
JVCKENWOOD Corporation
3-12, Moriya-cho, Kanagawa-ku, Yokohama-shi, Kanagawa, 221-0022, JAPAN
TEL: +81-45-450-1908 FAX: +81-45-450-1926
Email: MEDICAL-DISPLAY.J_JKC@jvckenwood.com
JVC Healthcare Website: <http://healthcare.jvc.com/>

JVC

2 Megapixel 21.3" Color Monitor

CL-S200

3 Megapixel 21.3" Color Monitor

CL-S300

Unparalleled Innovation in Diagnostic Imaging



i3 for Medical Imaging
SERIES

21.3" 1000 cd/m² CL-S200 1800:1 CL-S300 1500:1 16Bit LUT DisplayPort & DVI-D Calibration Function Color Front Sensor Uniformity Equalizer Dynamic Gamma Auto Text Mode Human Presence Sensor LED Backlight

Providing the Best Diagnostic Environment

Fully redesigned hardware and software bring innovation in multi-modality image reading.

Pursuing an Effective Diagnostic Reading Environment

Quality Assurance Made Easy and Cost Effective

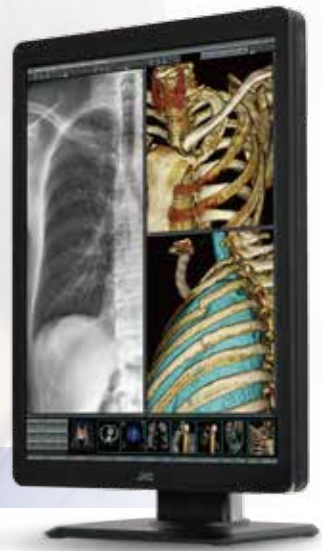

Clearly Defined Diagnostic Images

The new i3 color series render more precise color and monochrome modality images. One of its unique technologies the built-in self-calibrating sensor ensures that the monitor constantly performs at its best.

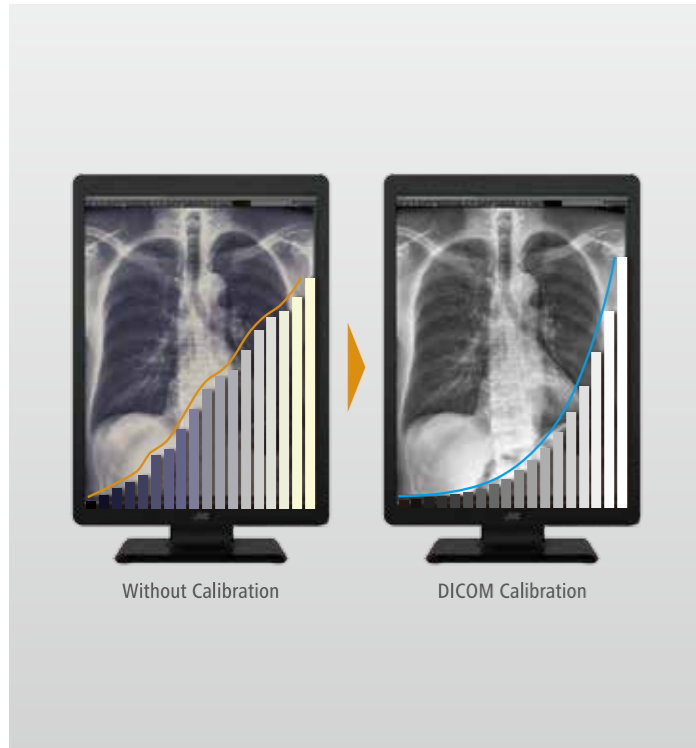

Dynamic Gamma

Color Images are automatically recognized to provide optimized contrast, brightness and gamma. No user intervention is required.

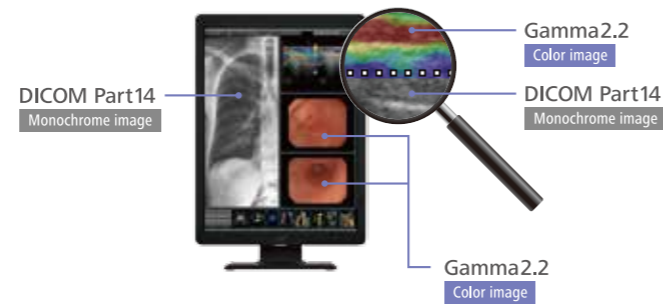

Auto Text Mode

Brightness is automatically adjusted on patient lists and reporting applications to reduce eye strain.

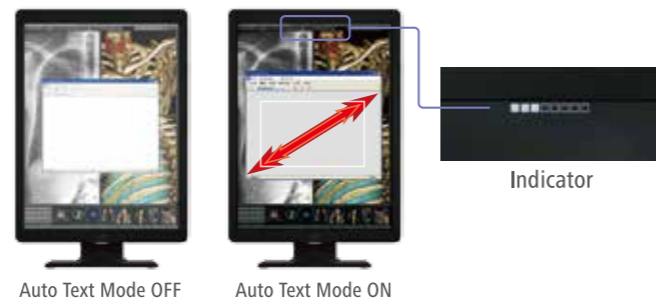

Integrated QA Solution **QA Medivisor Agent** (Option)

QA Medivisor Agent providing calibration and QA standard testing capabilities through an intuitive and easy to navigate user interface makes it effective to manage day-to-day operation in the radiology department. Simplified calibration scheduling tool QA Medivisor Agent LE is included.



*Optional calibration kit CAL-016 is required for standard QA testing.

Self-calibration

With the integrated color front sensor, the CL-S200 / CL-S300 self-calibrates to the DICOM Part 14 Standard on a regular schedule.



Schedule Setting (QA Medivisor Agent)

Razor-sharp Color Precision

Utilizing its unique X, Y, Z, color level tracking and color management technologies, any of the i3 model perfectly color-matches one another.



i3 for Medical Imaging SERIES

Advanced Features

- Premium Design
- LED Indicator / Front Buttons
- Built-in Sensor
- Space Saving
- Two-tone Color
- Wire Management / DisplayPort Daisy Chains

■ Premium Design

A simple and slim design for a modern look



■ LED Indicator / Front Buttons

The soft LED light indicator and front buttons are streamlined for intuitive operation.



■ Built-in Sensor



Ambient Light Sensor

Detects the level of ambient light to offset the effect for optimal calibration.

Color Front Sensor

Stabilizes luminance and color for consistent image quality.

Human Presence Sensor

Automatically switching to power save mode when sensor does not detect human presence.

■ Space Saving

The new design of the CL-S200 / CL-S300 reduces 25% of the stand footprint compared to the conventional models.



■ Two-tone Color

The back side features a stylish gray-white tone color.

■ Wire Management / DisplayPort Daisy Chains

With the DisplayPort 1.2, the use of daisy chains allows for easier wiring connections.

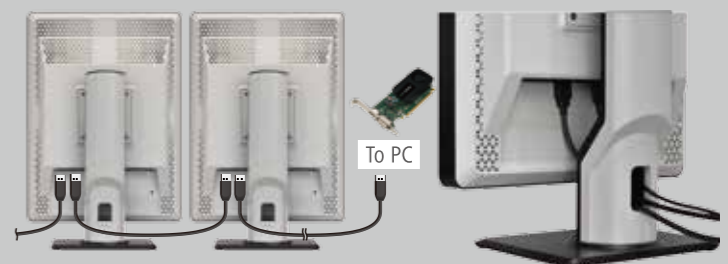

Optional graphic card is required for daisy chains connections.