



## Minimally Invasive Surgery Instruments

*Instruments de Chirurgie Mini-Invasive - Instrumentos de Cirugía Mini-Invasiva*

**2018**

For all information, quotes and orders:

Pour tout renseignement, devis et commandes :

Para más información, presupuestos y pedidos:



Tel. (World - Mundo) : +33 3 25 02 10 35

Tél. (France) : 03 25 02 10 10

Monday to Friday - Du lundi au vendredi - De lunes a viernes

From 8:00 am to 6:00 pm (non stop) - De 8 heures à 18 heures - De las 8 a las 18



Fax (World - Mundo) : +33 3 25 02 10 20

Fax (France) : 03 25 02 10 20



World - Mundo : [contact@delacroix-chevalier.com](mailto:contact@delacroix-chevalier.com)

France : [contact@landanger.com](mailto:contact@landanger.com)



Corporate office - Siège - Sede

**Delacroix-Chevalier**

13 avenue de la République

75011 Paris

FRANCE

Manufacturing & Logistic - Production et Logistique - Fabricación y Logística

Rue Renée et Louis Landanger

CS 52152

52906 Chaumont cedex 9

FRANCE

[www.delacroix-chevalier.com](http://www.delacroix-chevalier.com)

Contact - Contact - Contacto :

---

---

---

---

---



Delacroix-Chevalier

---

*Paris*

*Since - Depuis - Desde*  
*1920*

Index / Index / Índice

References Références Referencias	Page Page Página	References Références Referencias	Page Page Página	References Références Referencias	Page Page Página	References Références Referencias	Page Page Página	References Références Referencias	Page Page Página	References Références Referencias	Page Page Página
DC30212-20	49	DC80111-25	26	DC80412-34	71	DC81363-24	35	DC82131-30	41	DC83110-44	30
DC30222-38	49	DC80112-25	26	DC80413-34	71	DC81364-36	35	DC82131-40	41	DC83200-36	11
DC30223-43	49	DC80113-36	22	DC80414-34	70	DC81400-00	95	DC82131-50	41	DC83200-44	11
DC30300-00	49	DC80114-30	19	DC80415-34	70	DC81400-01	95	DC82132-30	41	DC83201-36	11
DC30600-00	46	DC80115-30	19	DC80416-34	72	DC81410-28	93	DC82132-40	41	DC83201-44	11
DC30800-00	50	DC80116-28	17	DC80417-24	100	DC81900-03	113	DC82132-50	41	DC83207-36	11
DC30810-25	50	DC80117-28	17	DC80418-36	100	DC81900-04	113	DC82133-30	41	DC83207-44	11
DC30811-35	50	DC80120-30	24	DC80419-36	100	DC81901-00	115	DC82133-40	41	DC83208-36	13
DC30812-45	50	DC80121-30	24	DC80420-24	100	DC81902-00	115	DC82133-50	41	DC83208-44	13
DC30813-55	50	DC80122-30	24	DC80425-34	14	DC81903-00	112	DC82141-30	41	DC83209-36	13
DC32300-00	44	DC80123-30	21	DC80426-34	14	DC81904-00	112	DC82141-40	41	DC83209-44	13
DC32900-00	45	DC80124-30	21	DC80427-34	14	DC81906-00	114	DC82141-50	41	DC83210-36	65
DC71337-33	96	DC80127-30	24	DC80428-34	14	DC81907-00	114	DC82142-30	41	DC83210-44	65
DC71337-33-C	96	DC80130-30	27	DC80429-34	69	DC81908-00	114	DC82142-40	41	DC83211-36	65
DC71337-33-S	96	DC80130-36	27	DC80450-34	87	DC81910-01	112	DC82142-50	41	DC83211-44	65
DC71710-50	86	DC80131-30	27	DC80451-34	87	DC81910-02	112	DC82143-30	41	DC83213-36	64
DC80009-36	81	DC80131-36	27	DC80452-34	87	DC81910-03	112	DC82143-40	41	DC83213-44	64
DC80010-36	80	DC80132-30	28	DC80453-34	87	DC81912-01	113	DC82143-50	41	DC83216-36	63
DC80011-36	80	DC80133-30	28	DC80459-34	85	DC81912-02	113	DC82150-00	37	DC83221-44	64
DC80012-25	79	DC80200-28	8	DC80460-29	31	DC81912-03	113	DC82150-01	37	DC83222-44	13
DC80012-30	79	DC80200-30	8	DC80461-34	31	DC81930-01	103	DC82151-20	36	DC83223-44	30
DC80012-36	79	DC80200-36	8	DC80462-22	32	DC81930-02	103	DC82151-30	36	DC83224-36	12
DC80012-43	79	DC80201-30	8	DC80700-30	97	DC82100-00	39	DC82151-40	36	DC83224-44	12
DC80013-25	79	DC80201-36	8	DC80701-30	97	DC82100-01	40	DC82152-99	36	DC83225-36	12
DC80013-30	79	DC80201-43	8	DC80702-30	97	DC82100-02	40	DC82153-30	36	DC83225-44	12
DC80013-36	79	DC80202-30	10	DC80710-23	98	DC82100-99	39	DC82152-00	36	DC89100-00	104
DC80013-44	79	DC80202-36	10	DC80711-23	98	DC82101-30	39	DC82160-00	38	DC89101-00	104
DC80014-28	74	DC80203-28	5	DC80721-02	102	DC82101-40	39	DC82161-30	38	DC89111-10	104
DC80014-36	79	DC80203-30	5	DC80721-03	102	DC82101-50	39	DC82161-40	38	DC89112-05	104
DC80015-28	75	DC80204-30	9	DC80730-30	99	DC82102-30	39	DC82161-50	38	E0623001	107
DC80017-28	75	DC80204-36	9	DC81000-00	45	DC82102-40	39	DC82160-99	38	E0623004	107
DC80018-28	74	DC80205-28	5	DC81115-00	35	DC82102-50	39	DC82162-30	38	E220600	55
DC80019-30	81	DC80205-30	5	DC81117-94	35	DC82103-30	39	DC82162-40	38	E220601	55
DC80019-36	81	DC80205-36	9	DC81116-30	35	DC82103-40	39	DC82162-50	38	E220602	55
DC80020-30	77	DC80207-30	9	DC81116-40	35	DC82103-50	39	DC82200-00	47	E220604	55
DC80022-30	76	DC80207-36	9	DC81116-50	35	DC82104-40	40	DC82210-00	48	E220606	55
DC80022-36	76	DC80208-36	8	DC81301-00	57	DC82111-30	39	DC82950-38	51	E220607	55
DC80023-30	76	DC80209-36	9	DC81301-01	57	DC82111-40	39	DC82960-07	52	E220609	55
DC80024-30	76	DC80220-30	6	DC81301-30	57	DC82111-50	39	DC82960-10	52	E220610	55
DC80100-30	25	DC80221-30	6	DC81302-00	57	DC82112-30	39	DC82961-07	52	E220611	55
DC80100-36	25	DC80222-30	7	DC81302-30	57	DC82112-40	39	DC82961-10	52	E220628	55
DC80101-30	25	DC80224-30	6	DC81303-33	59	DC82112-50	39	DC82962-07	52	E220618	55
DC80101-36	25	DC80227-30	6	DC81304-00	57	DC82113-30	39	DC82962-10	52	E220622	55
DC80101-43	25	DC80300-30	82	DC81304-30	57	DC82113-40	39	DC82963-07	52	E220626	55
DC80102-30	25	DC80300-36	82	DC81305-21	58	DC82113-50	39	DC82963-10	52	E220650	56
DC80102-36	25	DC80302-36	82	DC81305-30	58	DC82114-40	40	DC82964-07	52	E220651	56
DC80102-43	25	DC80303-36	82	DC81307-00	57	DC82115-40	40	DC82964-10	52	E220653	56
DC80103-30	22	DC80401-37	66	DC81307-30	57	DC82120-30	42	DC82965-70	53	E220659	56
DC80103-36	22	DC80402-32	67	DC81308-00	83	DC82120-50	42	DC82970-07	53	E220661	56
DC80104-30	22	DC80402-37	67	DC81308-28	83	DC82120-90	42	DC82970-10	53	E220666	56
DC80104-36	22	DC80403-35	67	DC81308-35	83	DC82120-95	42	DC82981-07	54	E220668	56
DC80105-28	20	DC80404-32	67	DC81310-00	93	DC82121-16	42	DC82981-10	54	E229121	53
DC80105-30	20	DC80404-36	67	DC81310-28	93	DC82121-20	42	DC82982-07	54	E251105	29
DC80106-28	20	DC80405-31	67	DC81320-38	92	DC82122-22	43	DC82982-10	54	E0619040	84
DC80106-30	20	DC80405-33	67	DC81322-38	92	DC82122-24	43	DC82983-07	54	E0619041	84
DC80107-30	25	DC80406-35	68	DC81323-21	83	DC82122-26	43	DC82983-10	54	E0619042	84
DC80107-36	25	DC80407-36	68	DC81323-30	83	DC82123-01	42	DC83002-36	78	E0619043	84
DC80109-28	23	DC80408-35	68	DC81330-00	101	DC82123-02	42	DC83002-44	78	J00011	18
DC80109-30	23	DC80409-35	68	DC81330-01	101	DC82124-30	42	DC83003-36	78	J00012	18
DC80110-30	29	DC80410-34	71	DC81330-33	101	DC82125-05	42	DC83003-44	78	J00021	91
DC80110-36	29	DC80411-34	71	DC81331-33	101	DC82130-00	41	DC83110-36	30	J00022	91

DISSECTING FORCEPS / PINCES À DISSECTION / PINZAS PARA DISECCIÓN

Ø 3,5 mm



P 5

Ø 3,5 mm / Ø 5 mm



P 6 - 7

Ø 5 mm



P 8 - 9 - 10

DISSECTING FORCEPS WITH RATCHET / PINCES À DISSECTION À CRÉMAILLÈRE / PINZAS PARA DISECCIÓN CON CREMALLERA

Ø 5 mm

Titanium



P 11

DISSECTORS / DISSECTEURS / DISECTORES

HF DISSECTORS / DISSECTEURS HF / HF DISECTORES

Titanium



P 12

Titanium



P 13

Curved shaft / Tube courbe / Tubo curvado

Titanium



P 13

TRANSTHORACIC DISSECTORS / DISSECTEURS TRANSTHORACIQUES / DISECTORES TRANSTORÁCICOS



P 14





DeBakey

Ø 3.5 mm

Straight  
Droite  
Recta

2.75 mm



 **DC80203-28**

L : 280 mm - 11"

**DC80203-30**

L : 300 mm - 11<sup>4/5</sup>"

Only one mobile jaw  
Un seul mors mobile  
Sólo una boca móvil



 3/5

Angled on flat  
Coudée sur le plat  
Angulada en el plano

1.5 mm

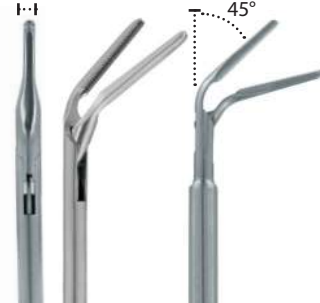

**DC80205-28**

L : 280 mm - 11"

**DC80205-30**

L : 300 mm - 11<sup>4/5</sup>"

Dissecting Forceps / Pincés à Dissection / Pinzas para Disección

Ø 3.5 mm / Ø 5 mm



DeBakey

Straight  
Droite  
Recta

1.5 mm



**DC80221-30**

L : 300 mm - 11<sup>4</sup>/<sub>5</sub>"

Curved  
Courbe  
Curva

2.75 mm

45°



**DC80224-30**

L : 300 mm - 11<sup>4</sup>/<sub>5</sub>"

2.75 mm



**DC80220-30**

L : 300 mm - 11<sup>4</sup>/<sub>5</sub>"

2.75 mm



**DC80227-30**

L : 300 mm - 11<sup>4</sup>/<sub>5</sub>"



3/5



Ø 3.5 mm / Ø 5 mm



Resano

Straight  
Droite  
Recta

2.9 mm  
|---|



**DC80222-30**

L : 300 mm - 11<sup>4</sup>/<sub>5</sub>"



Dissecting Forceps / Pincés à Dissection / Pinzas para Disección



DeBakey

Ø 5 mm

Straight  
Droite  
Recta

1.5 mm



**DC80201-30**

L : 300 mm - 11<sup>4</sup>/<sub>5</sub>"

**DC80201-36**

L : 360 mm - 14<sup>1</sup>/<sub>5</sub>"

**DC80201-43**

L : 430 mm - 17"

2.75 mm



**DC80200-28**

L : 280 mm - 11"

**DC80200-30**

L : 300 mm - 11<sup>4</sup>/<sub>5</sub>"



**DC80200-36**

L : 360 mm - 14<sup>1</sup>/<sub>5</sub>"

Straight  
Droite  
Recta

Only one mobile jaw  
Un seul mors mobile  
Sólo una boca móvil

Teeth / Dents / Dientes : 2 x 3

5 mm



**DC80208-36**

L : 360 mm - 14<sup>1</sup>/<sub>5</sub>"





DeBailey

Ø 5 mm

Curved  
Courbe  
Curva



**DC80207-30**

L : 300 mm - 11<sup>4</sup>/<sub>5</sub>"

**DC80207-36**

L : 360 mm - 14<sup>1</sup>/<sub>5</sub>"

Angled  
Angulés  
Anguladas



**DC80204-30**

L : 300 mm - 11<sup>4</sup>/<sub>5</sub>"

**DC80204-36**

L : 360 mm - 14<sup>1</sup>/<sub>5</sub>"

Very curved  
Très courbe  
Muy curva



**DC80209-36**

L : 360 mm - 14<sup>1</sup>/<sub>5</sub>"

Angled on flat - Only one mobile jaw  
Coudée sur le plat - Un seul mors mobile  
Angulada en el plano - Sólo una boca móvil

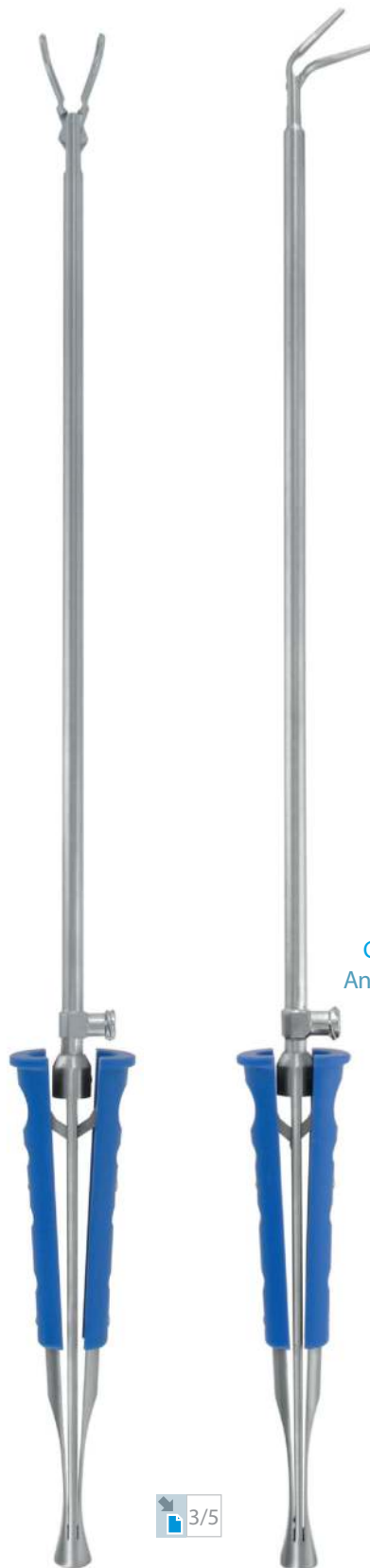

**DC80205-36**

L : 360 mm - 14<sup>1</sup>/<sub>5</sub>"



Dissecting Forceps / Pincès à Dissection / Pinzas para Disección



Resano

Ø 5 mm

Straight  
Droite  
Recta

2.9 mm  
|---|



**DC80202-30**

L : 300 mm - 11<sup>4</sup>/<sub>5</sub>"



**DC80202-36**

L : 360 mm - 14<sup>1</sup>/<sub>5</sub>"





DeBaKey

Ø 5 mm

Registered Design  
Modèle déposé  
Diseño registrado

Straight  
Droite  
Recta

2.75 mm  
I-I



**DC83200-36**

L : 360 mm - 14<sup>1</sup>/<sub>5</sub>"

**DC83200-44**

L : 440 mm - 17<sup>1</sup>/<sub>3</sub>"

Curved  
Courbe  
Curva

2.75 mm  
I-I



**DC83207-36**

L : 360 mm - 14<sup>1</sup>/<sub>5</sub>"

**DC83207-44**

L : 440 mm - 17<sup>1</sup>/<sub>3</sub>"

1.5 mm  
I-I



**DC83201-36**

L : 360 mm - 14<sup>1</sup>/<sub>5</sub>"

**DC83201-44**

L : 440 mm - 17<sup>1</sup>/<sub>3</sub>"



Progressive locking system  
Crémaillère progressive  
Cremallera progresiva

**Titanium**  
*line*



Ø 5 mm

90°



 **DC83225-36**

L : 360 mm - 14<sup>1</sup>/<sub>5</sub>"

**DC83225-44**

L : 440 mm - 17<sup>1</sup>/<sub>3</sub>"

To be used with oval 16x25mm trocar  
À utiliser avec un trocart oval de 16 x 25 mm  
Usar con un óvalo trocart de 16 x 25 mm

Very curved jaws  
Mors très courbes  
Bocas muy curvas



**DC83224-36**

L : 360 mm - 14<sup>1</sup>/<sub>5</sub>"

**DC83224-44**

L : 440 mm - 17<sup>1</sup>/<sub>3</sub>"



**Titanium**<sup>line</sup>

 3/5

MARYLAND

Curved  
Courbe  
Curva



**DC83208-36** \*

L : 360 mm - 14<sup>1</sup>/<sub>5</sub>"

**DC83208-44** \*

L : 440 mm - 17<sup>1</sup>/<sub>3</sub>"

Ø 5 mm

MARYLAND

Curved shaft  
Tube courbe  
Tubo curvado



**DC83222-44** \*

L : 440 mm - 17<sup>1</sup>/<sub>3</sub>"

GOSSOT

Long curved jaws  
Mors courbes longs  
Bocas curvas largas



**DC83209-36**

L : 360 mm - 14<sup>1</sup>/<sub>5</sub>"

**DC83209-44**

L : 440 mm - 17<sup>1</sup>/<sub>3</sub>"

To be used with Ø 10mm trocar

À utiliser avec un trocart de Ø 10 mm

Usar con un trocart de Ø 10 mm



Titanium  
line



\*For regulatory reason, please check with your distributor for availability in your country

\* Por razones reglamentarias, por favor póngase en contacto con su distribuidor para conocer la disponibilidad en su país

Transthoracic Dissectors / Dissecteurs Transthoraciques / Disectores Transtorácicos



 **DC80427-34**

L : 335 mm - 13<sup>1/5</sup>"  
With Ratchet  
Avec Crémaillère  
Con Cremallera

**DC80428-34**

L : 335 mm - 13<sup>1/5</sup>"  
Without Ratchet  
Sans Crémaillère  
Sin Cremallera

 **DC80425-34**

L : 335 mm - 13<sup>1/5</sup>"  
With Ratchet  
Avec Crémaillère  
Con Cremallera

**DC80426-34**

L : 335 mm - 13<sup>1/5</sup>"  
Without Ratchet  
Sans Crémaillère  
Sin Cremallera





ANGLED SCISSORS / CISEAUX ANGULÉS / TIJERAS ANGULADAS

Ø 2 mm / Ø 2.5 mm



P 17

Ø 2 mm / Ø 2.5 mm

Angled shaft / Tube angulé / Tubo anguladas



P 18

Ø 3 mm



P 19

Ø 3,5 mm



P 20

Ø 3,5 mm / Ø 5 mm



P 21

Ø 5 mm



P 22

CURVED SCISSORS / CISEAUX COURBES / TIJERAS CURVAS

Ø 3,5 mm



P 23

Ø 3,5 mm / Ø 5 mm



P 24

Ø 5 mm



P 25 - 26

Ø 5 mm

TC blades / Lames TC / Hojas TC



P 27

Ø 5 mm / Ø 7 mm



P 28

HANDLES FOR SCISSORS TIPS / MANCHES POUR EMBOUTS CISEAUX / MANGOS PARA PUNTAS DE TIJERAS

Ø 5mm



P 29

HF HANDLES FOR SCISSORS TIPS / MANCHES HF POUR EMBOUTS CISEAUX / MANGOS HF PARA PUNTAS DE TIJERAS

Ø 5mm



P 30

Ø 5mm

Curved shaft / Tube courbe / Tubo curvado



P 30

TRANSTHORACIC SCISSORS / CISEAUX TRANSTHORACIQUES / TIJERAS TRANSTORÁDICAS

Ø 10 mm

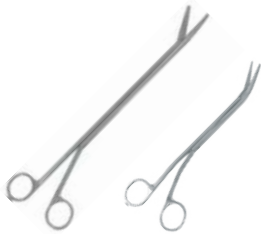

P 31 - 32

Angled Scissors / Ciseaux Angulés / Tijeras Anguladas

Ø 2 mm / Ø 2.5 mm

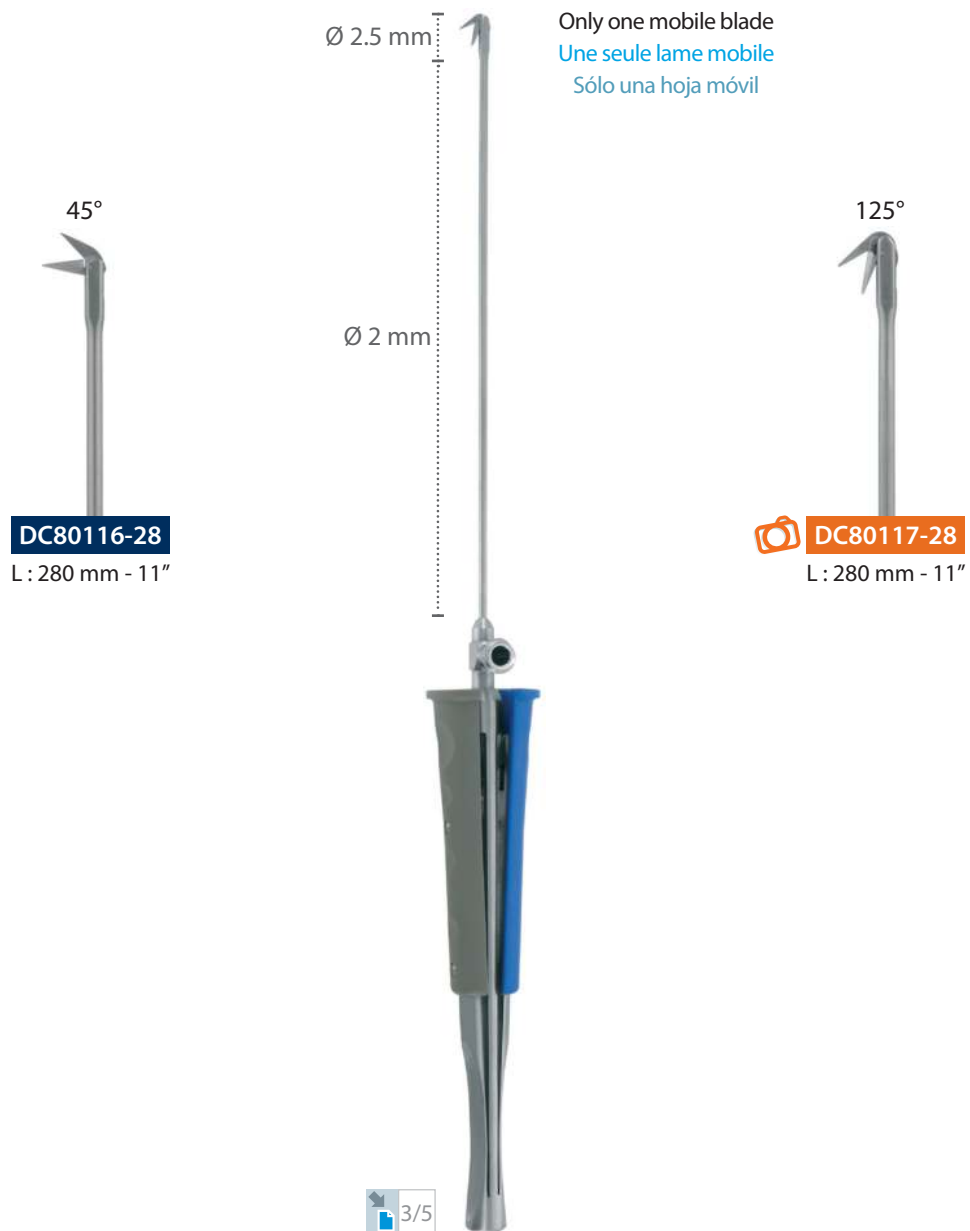

Angled Scissors / Ciseaux Angulés / Tijeras Anguladas

Ø 2 mm / Ø 2.5 mm

Angled Shaft / Tube Angulé / Tubo Angulado

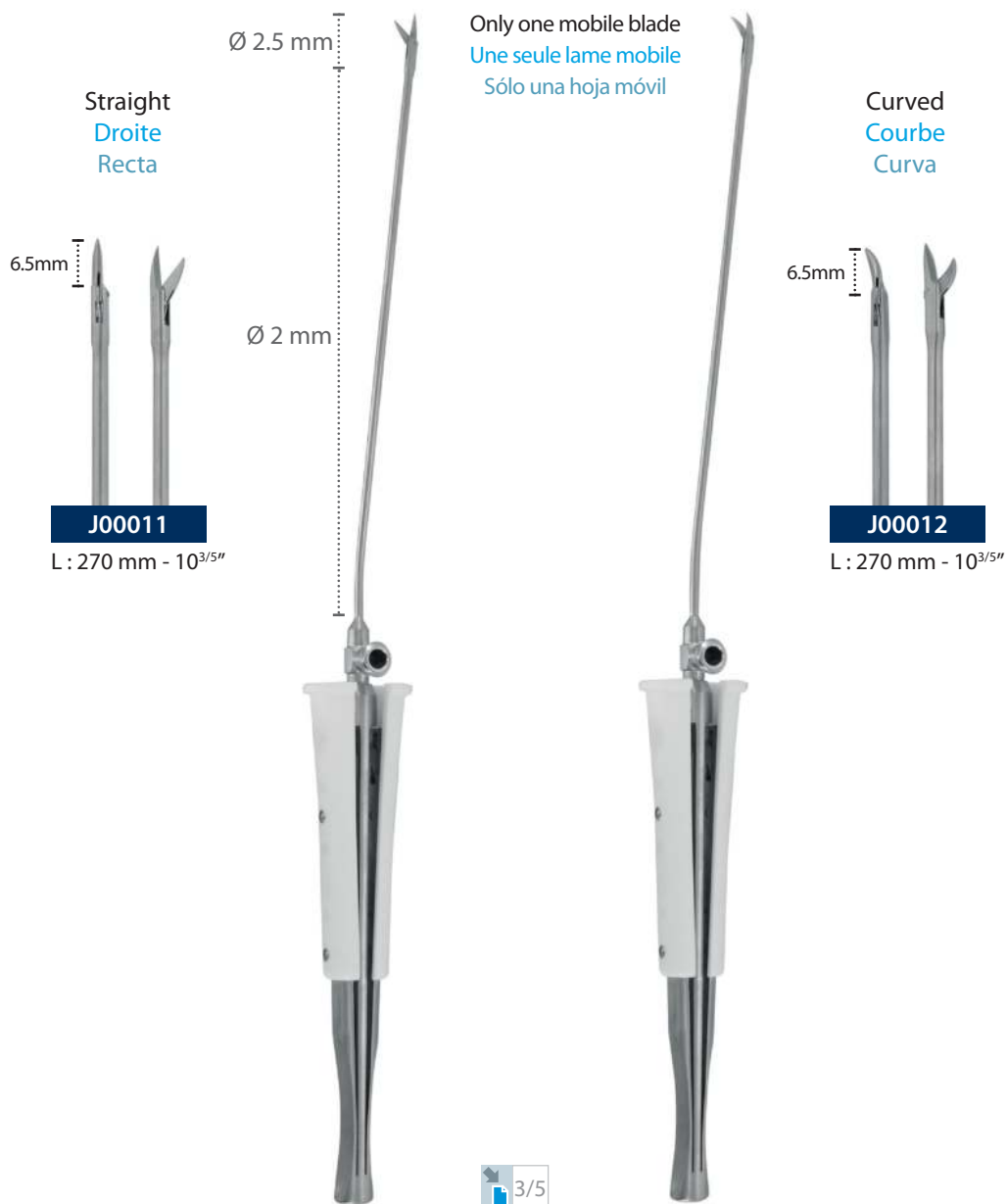

Angled Scissors / Ciseaux Angulés / Tijeras Anguladas

Ø 3 mm

Only one mobile blade  
Une seule lame mobile  
Sólo una hoja móvil

45°



DC80114-30

L : 300 mm - 11<sup>4</sup>/<sub>5</sub>"

120°



DC80115-30

L : 300 mm - 11<sup>4</sup>/<sub>5</sub>"



Angled Scissors / Ciseaux Angulés / Tijeras Anguladas

Ø 3.5 mm

Only one mobile blade  
Une seule lame mobile  
Sólo una hoja móvil



Angled Scissors / Ciseaux Angulés / Tijeras Anguladas

Ø 3.5 mm / Ø 5 mm

Only one mobile blade  
Une seule lame mobile  
Sólo una hoja móvil

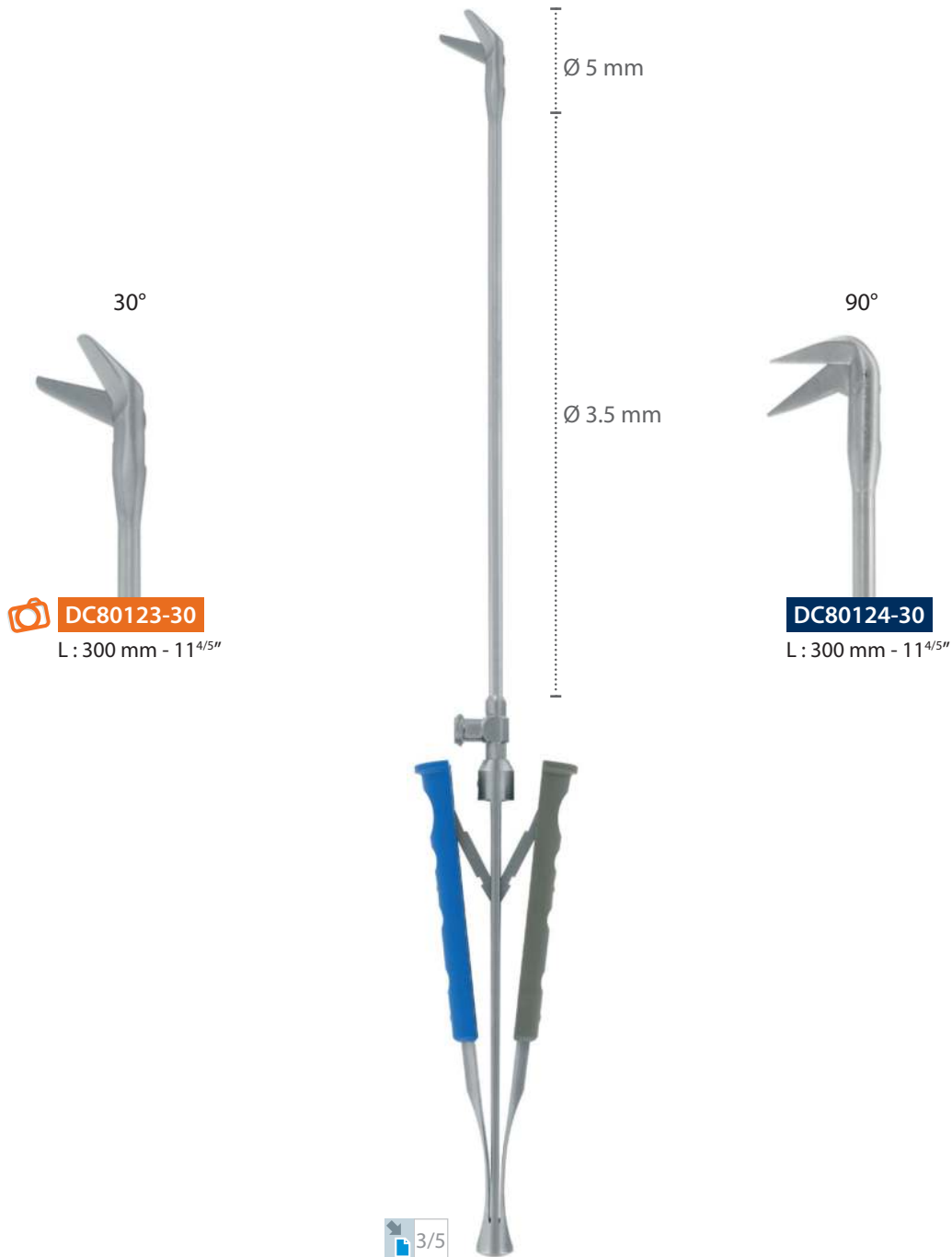

Angled Scissors / Ciseaux Angulés / Tijeras Anguladas

Ø 5 mm

Only one mobile blade  
Une seule lame mobile  
Sólo una hoja móvil

30°



**DC80113-36**

L : 360 mm - 14<sup>1</sup>/<sub>5</sub>"

45°



**DC80103-30**

L : 300 mm - 11<sup>4</sup>/<sub>5</sub>"



**DC80103-36**

L : 360 mm - 14<sup>1</sup>/<sub>5</sub>"

90°



**DC80104-30**

L : 300 mm - 11<sup>4</sup>/<sub>5</sub>"

**DC80104-36**

L : 360 mm - 14<sup>1</sup>/<sub>5</sub>"



3/5



Curved Scissors / Ciseaux Courbes / Tijeras Curvas

Ø 3.5 mm

Curved  
Courbe  
Curva



**DC80109-28**

L : 280 mm - 11"

**DC80109-30**

L : 300 mm - 11<sup>4</sup>/<sub>5</sub>"



Curved Scissors / Ciseaux Courbes / Tijeras Curvas

Ø 3.5 mm / Ø 5 mm

Curved - Only one mobile blade  
Courbe - Une seule lame mobile  
Curva - Sólo una hoja móvil



**DC80127-30**

L : 300 mm - 11<sup>4/5</sup>"

Curved  
Courbe  
Curva



**DC80121-30**

L : 300 mm - 11<sup>4/5</sup>"

Lightly Curved  
Légèrement Courbes  
Ligeramente curvas



**DC80120-30**

L : 300 mm - 11<sup>4/5</sup>"

Strongly Curved  
Très Courbes  
Muy curvas



**DC80122-30**

L : 300 mm - 11<sup>4/5</sup>"



Curved Scissors / Ciseaux Courbes / Tijeras Curvas

Ø 5 mm

Curved - Only one mobile blade  
Courbe - Une seule lame mobile  
Curva - Sólo una hoja móvil



**DC80107-30**

L : 300 mm - 11<sup>4</sup>/<sub>5</sub>"

**DC80107-36**

L : 360 mm - 14<sup>1</sup>/<sub>5</sub>"

Curved  
Courbe  
Curva



**DC80101-30**

L : 300 mm - 11<sup>4</sup>/<sub>5</sub>"



**DC80101-36**

L : 360 mm - 14<sup>1</sup>/<sub>5</sub>"

**DC80101-43**

L : 430 mm - 17"

Lightly Curved  
Légèrement Courbes  
Ligeramente curvas



**DC80100-30**

L : 300 mm - 11<sup>4</sup>/<sub>5</sub>"

**DC80100-36**

L : 360 mm - 14<sup>1</sup>/<sub>5</sub>"

Strongly Curved  
Très Courbes  
Muy curvas



**DC80102-30**

L : 300 mm - 11<sup>4</sup>/<sub>5</sub>"

**DC80102-36**

L : 360 mm - 14<sup>1</sup>/<sub>5</sub>"

**DC80102-43**

L : 430 mm - 17"



Curved Scissors / Ciseaux Courbes / Tijeras Curvas

Ø 5 mm

NEW  
NOUVEAU  
NUEVO

With Reduced Spring Action Force  
Avec Lames Ressorts Affinées  
Con cuchillas resortes delicados

Curved  
Courbe  
Curva



DC80111-25

L : 250 mm - 10"

Strongly Curved  
Très Courbes  
Muy curvas



DC80112-25

L : 250 mm - 10"



3/5

Curved Scissors with TC blades / Ciseaux Courbes avec Lames TC / Tijeras Curvas con Hojas TC



TC Insert

Ø 5 mm

TC blades  
Lames TC  
Hojas TC

Lightly Curved  
Légèrement Courbes  
Ligeramente curvas



**DC80130-30**

L : 300 mm - 11<sup>4</sup>/<sub>5</sub>"



**DC80130-36**

L : 360 mm - 14<sup>1</sup>/<sub>5</sub>"

Curved  
Courbe  
Curva



**DC80131-30**

L : 300 mm - 11<sup>4</sup>/<sub>5</sub>"

**DC80131-36**

L : 360 mm - 14<sup>1</sup>/<sub>5</sub>"



3/5

Curved Scissors / Ciseaux Courbes / Tijeras Curvas

Ø 5 mm / Ø 7 mm

NEW  
NOUVEAU  
NUEVO

Very Strong Cutting Force  
Pouvoir de Coupe Élevé  
Fuerza de Corte muy Fuerte

Curved  
Courbe  
Curva



DC80132-30

L : 300 mm - 11<sup>4</sup>/<sub>5</sub>"

Strongly Curved  
Très Courbes  
Muy curvas



DC80133-30

L : 300 mm - 11<sup>4</sup>/<sub>5</sub>"



3/5

Ø 5 mm



Disposable  
Usage unique  
Uso único

Curved Metzenbaum scissors  
Ciseaux Metzenbaum courbes  
Tijeras Metzenbaum curvas



15 mm

**E251105** \*

Ø : 5 mm  
Box of 10 tips  
Boîte de 10 embouts  
Caja de 10 puntas



3/5

**DC80110-30**

L : 300 mm - 11<sup>4/5</sup>"



**DC80110-36**

L : 360 mm - 14<sup>1/5</sup>"

HF Handles for Scissors Tips / Manches HF pour Embouts Ciseaux / Mangos HF para Puntas de Tijeras

Ø 5 mm



Disposable  
Usage unique  
Usó único

Curved Metzenbaum scissors  
Ciseaux Metzenbaum courbes  
Tijeras Metzenbaum curvas



E251105 \*

Ø : 5 mm  
Box of 10 tips  
Boite de 10 embouts  
Caja de 10 puntas

Straight Shaft  
Tube droit  
Tubo recto



DC83110-36 \*

L : 360 mm - 14<sup>1/5"</sup>

DC83110-44 \*

L : 440 mm - 17<sup>1/3"</sup>

Curved Shaft  
Tube courbe  
Tubo curvado



DC83223-44 \*

L : 440 mm - 17<sup>1/3"</sup>

Titanium *line*





NEW  
NOUVEAU  
NUEVO



**DC80460-29**

L : 290 mm - 11<sup>2/5</sup>"

Curved jaws  
Mors Courbes  
Bocas Curvas



**DC80461-34**

L : 340 mm - 13<sup>2/5</sup>"

Curved jaws  
Mors Courbes  
Bocas Curvas

3/5



ATRIAL RETRACTOR / ÉCARTEUR ATRIAL / SEPARADOR ATRIAL

Obadia



P 35

RING RETRACTOR / ÉCARTEUR CIRCULAIRE / SEPARADOR CIRCULAR

Obadia

C Ring Retractor/ Écarteur en C / C Separador

Ring Retractor/ Écarteur Circulaire / Separador Circular

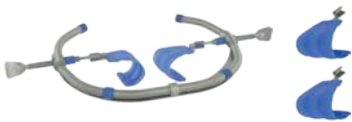

P 36



P 37

RETRACTORS / ÉCARTEURS / SEPARADORES

Yan

Mini-Access

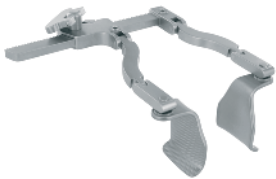

P 38

ThorAccess

Intercostal / Intercostal / Intercostal



P 39 - 40

ThorAccess

Sternal / Sternal / Esternal



P 41

ThorAccess

Accessories / Accessoires / Accesorios



P 42 - 43

MIS

Double hinged / Double articulation / Doble articulación

MIS retractors / Écarteurs / Separadores



P 44



P 45

Mini Finochietto-Mathey



P 46

CORONARY RETRACTORS / ÉCARTEURS CORONAIRES / SEPARADORES CORONARIOS

Midaccess



P 47

Small Thoracotomy



P 48

Mini IMA



P 49

Direct Vision



P 50

RETRACTORS & TROCARS / ÉCARTEURS & TROCARTS / SEPARADORES & TROCARES

Subcarinal / Sous carénaire / Subcarineal



P 51

Trocars for thoracoscopy / Trocarts pour thoroscopie / Trocares para toroscopia



P 52 - 53 - 54

Magnetic Trocars  
Trocarts magnétiques  
Trocares magnéticos

SOFT TISSUES RETRACTORS / ÉCARTEURS SOUPLES / RETRACORES DE TEJIDOS BLANDOS

Fixed Height / Hauteur Fixe / Altura fija



P 55

Adjustable Height / Hauteur Ajustable / Altura Ajustable



P56

HOOKS / CROCHETS / GANCHOS

Pr. Obadia

Hooks / Crochets / Ganchos



P 57

Dr. Yilmaz

Hooks / Crochets / Ganchos



P 58

Pr. Obadia

Double hooks / Double crochets / Doble ganchos



P 59

3D Atrial Retractor / Écarteur Atrial 3D / Separador Atrial 3D

OBADIA

**NEW**  
**NOUVEAU**  
**NUEVO**

**DC81115-00**

Included 3 blades

3 valves incluses

3 valvas incluidas :

35 mm x 30 mm

35 mm x 40 mm

35 mm x 50 mm

Flexible additional atrial blades for DC81115-00

Valves atrial additionnelle flexible pour DC81115-00

Válvulas adicionales flexibles para DC81115-00



**DC81117-94**

94 mm

Optional blades for DC81115-00

Valves optionnelles pour DC81115-00

Valvas opcionales para DC81115-00



**DC81116-30**

35 mm x 30 mm



**DC81116-40**

35 mm x 40 mm



**DC81116-50**

35 mm x 50 mm

All blade sizes available on custom request and quotation

Toutes dimensions de valves possibles sur demande et devis

Todas las dimensiones de valvas disponibles bajo pedido y presupuesto



Forceps for blades  
Pince pose valves  
Pinza para colocar valvas



**DC81363-24**

L : 240 mm - 9<sup>1</sup>/<sub>2</sub>"



**DC81364-36**

L : 360 mm - 14<sup>1</sup>/<sub>5</sub>"

"C-Ring" Retractor / Écarteur en "C" / "C" Separador

OBADIA

NEW  
NOUVEAU  
NUEVO

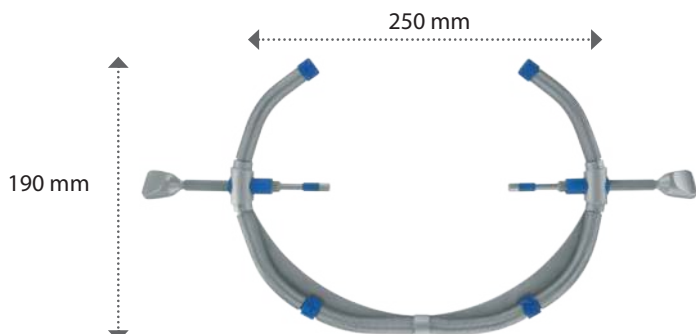

**DC82152-99**

c max with blades DC82153-30 : 70 mm



**DC82153-30**

a : 70 mm - b : 30 mm

1 pair of blades - 1 paire de valves - 1 pares de valvas

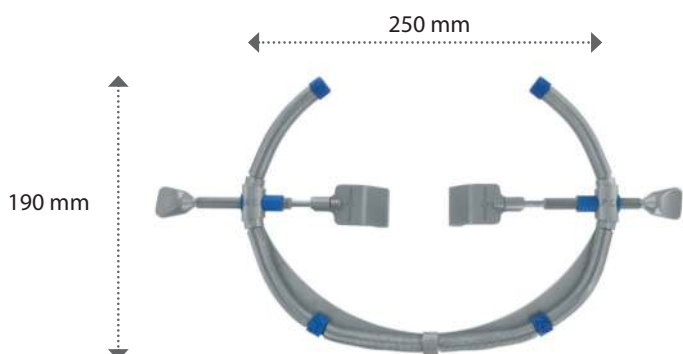

**DC82152-00**

c max : 100 mm



DC82151-20

DC82151-30

DC82151-40

Included 3 pairs of blades - 3 paires de valves incluses - 3 pares de valvas incluidas:

**DC82151-20**

+

**DC82151-30**

+

**DC82151-40**

a : 27 mm - b : 20 mm

a : 27 mm - b : 30 mm

a : 27 mm - b : 40 mm

Ring Retractor / Écarteur Circulaire / Separador Circular

OBADIA

Registered Design  
Modèle déposé  
Diseño registrado



**DC82150-00**

Ø : 220 mm - 8<sup>2/3</sup>" - c max : 85 mm

Included 3 pairs of blades - 3 paires de valves incluses - 3 pares de valvas incluidas:

**DC82151-20**

+

**DC82151-30**

+

**DC82151-40**

a : 27 mm - b : 20 mm

a : 27 mm - b : 30 mm

a : 27 mm - b : 40 mm



Also compatible with this version of Obadia Ring Retractor  
Également compatible avec cette version de l'écarteur circulaire Obadia  
También es compatible con esta versión del separador circular Obadia



**DC82150-01**

With Luer Lock - Avec raccord Luer Lock - Con conexión Luer Lock



**DC82153-30**

a : 70 mm - b : 30 mm

1 pair of blades - 1 paire de valves - 1 pares de valvas

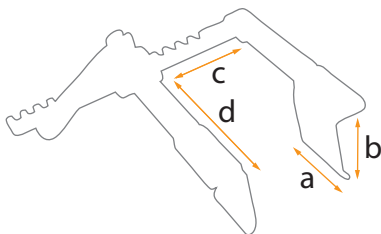

Mini-Access Retractor / Écarteur Mini-Access / Separador Mini-Access

**DC82160-00**

c : 112 mm - d : 96 mm

Included - Inclus - Incluidos

DC82161-30 (pair / paire / par)

DC82161-40 (pair / paire / par)

DC82161-50 (pair / paire / par)

Prof Yan blades

Valves Pr Yan

Valvas Pr Yan

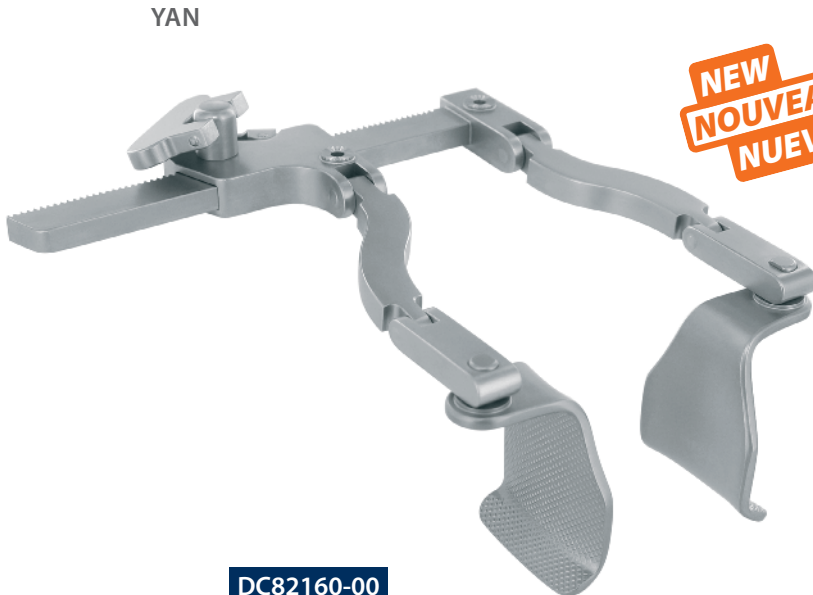

**DC82160-00**

c : 108 mm - d : 96 mm

**DC82161-30**

a : 36 mm - b : 30 mm



**DC82161-40**

a : 36 mm - b : 40 mm

**DC82161-50**

a : 36 mm - b : 50 mm

Standard blades

Valves standard

Valvas estándar



**DC82162-30**

a : 36 mm - b : 30 mm



**DC82162-40**

a : 36 mm - b : 40 mm

**DC82162-50**

a : 36 mm - b : 50 mm



Alone

Seul

Solo

**DC82160-99**

c : 108 mm - d : 96 mm

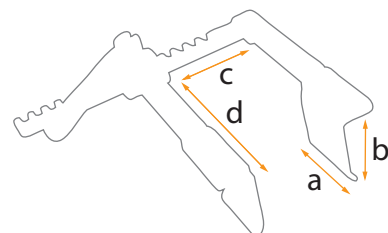

All products on this page are **NOT** compatible with ThorAccess retractors  
Les produits de cette page ne sont **PAS** compatibles avec l'écarteur ThorAccess  
Los productos de esta página **NO** son compatibles con las separador ThorAccess



**DC82100-00**

c : 112 mm - d : 96 mm

Included - Inklus - Incluidos

- DC82102-30 (pair / paire / par)
- DC82102-40 (pair / paire / par)
- DC82102-50 (pair / paire / par)
- DC82120-30
- DC82121-16



Standard blades  
Valves standard  
Valvas estándar



**DC82101-30**

a : 28 mm - b : 30 mm

**DC82101-40**

a : 28 mm - b : 40 mm

**DC82101-50**

a : 28 mm - b : 50 mm

**DC82102-30**

a : 36 mm - b : 30 mm



**DC82102-40**

a : 36 mm - b : 40 mm

**DC82102-50**

a : 36 mm - b : 50 mm

**DC82103-30**

a : 44 mm - b : 30 mm

**DC82103-40**

a : 44 mm - b : 40 mm

**DC82103-50**

a : 44 mm - b : 50 mm

Up & Down blades  
Valves réversibles  
Valvas reversibles



**DC82111-30**

a : 28 mm - b : 30 mm

**DC82111-40**

a : 28 mm - b : 40 mm

**DC82111-50**

a : 28 mm - b : 50 mm

**DC82112-30**

a : 36 mm - b : 30 mm



**DC82112-40**

a : 36 mm - b : 40 mm

**DC82112-50**

a : 36 mm - b : 50 mm

**DC82113-30**

a : 44 mm - b : 30 mm

**DC82113-40**

a : 44 mm - b : 40 mm

**DC82113-50**

a : 44 mm - b : 50 mm



Alone  
Seul  
Solo

**DC82100-99**

c : 112 mm - d : 96 mm

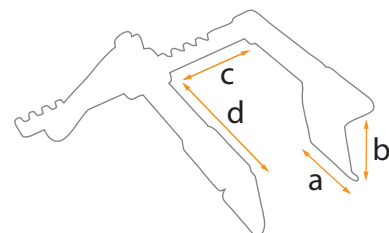

Intercostal ThorAccess Retractor / Écarteur ThorAccess Intercostal / Separador ThorAccess Intercostal

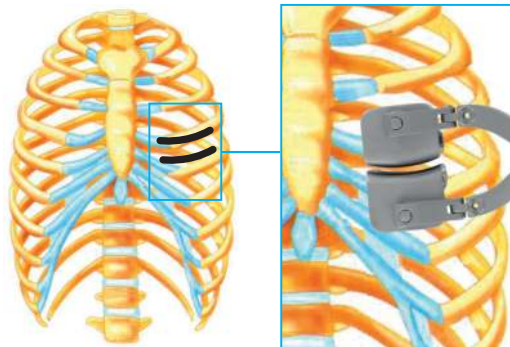

ThorAccess Retractor with Anatomical Blades  
Écarteur ThorAccess avec Valves Anatomiques  
ThorAccess Separador con Valvas Anatómicas

Reversible ThorAccess Retractor with Anatomical Blades  
Écarteur ThorAccess Réversible avec Valves Anatomiques  
ThorAccess Reversible Separador con Valvas Anatómicas

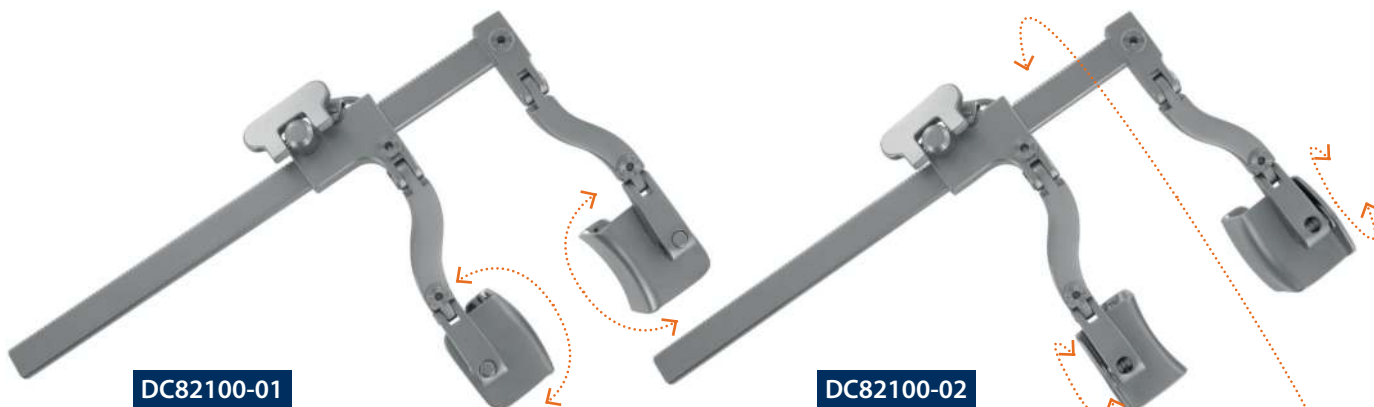

**DC82100-01**

c : 112 mm - d : 96 mm

Included - Inklus - Incluidos :  
DC82100-99, DC82104-40

**DC82100-02**

c : 112 mm - d : 96 mm

Included - Inklus - Incluidos :  
DC82100-99, DC82114-40

Standard blades  
Valves standard  
Valvas estándar



**DC82104-40**

a : 36 mm - b : 40 mm

Up & Down blades  
Valves réversibles  
Valvas reversibles



**DC82114-40**

a : 36 mm - b : 40 mm

Lighting and Up & Down blades  
Valves lumineuses et réversibles  
Valvas luminosas y reversibles



**DC82115-40**

a : 36 mm - b : 40 mm

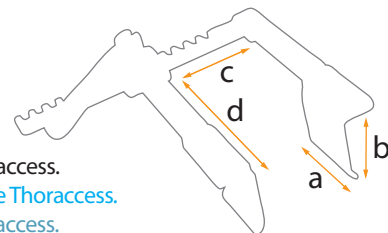

All products on this page are compatible with each other - They are not compatible with sternal Thoraccess.  
Tous les produits de cette page sont compatibles entre eux - Non compatibles avec la version sternale Thoraccess.  
Todos los productos de esta página son compatibles entre sí - No son compatibles con esternal Thoraccess.

Sternal ThorAccess Retractor / Écarteur ThorAccess Sternal / Separador Thoraccess Esternal

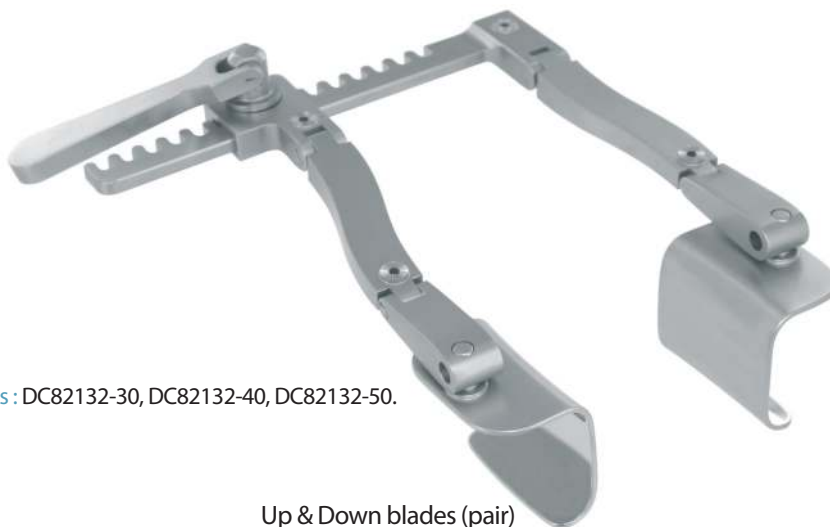

**DC82130-00**

c : 115 mm - d : 130 mm

Included - Inklus - Includidos : DC82132-30, DC82132-40, DC82132-50.

Standard blades (pair)  
Valves standard (paire)  
Valvas estándar (par)



**DC82131-30**

a : 36 mm - b : 30 mm

**DC82131-40**

a : 36 mm - b : 40 mm

**DC82131-50**

a : 36 mm - b : 50 mm

**DC82132-30**

a : 50 mm - b : 30 mm

 **DC82132-40**

a : 50 mm - b : 40 mm

**DC82132-50**

a : 50 mm - b : 50 mm

**DC82133-30**

a : 64 mm - b : 30 mm

**DC82133-40**

a : 64 mm - b : 40 mm

**DC82133-50**

a : 64 mm - b : 50 mm

Up & Down blades (pair)  
Valves réversibles (paire)  
Valvas reversibles (par)



**DC82141-30**

a : 36 mm - b : 30 mm

**DC82141-40**

a : 36 mm - b : 40 mm

**DC82141-50**

a : 36 mm - b : 50 mm

**DC82142-30**

a : 50 mm - b : 30 mm

 **DC82142-40**

a : 50 mm - b : 40 mm

**DC82142-50**

a : 50 mm - b : 50 mm

**DC82143-30**

a : 64 mm - b : 30 mm

**DC82143-40**

a : 64 mm - b : 40 mm

**DC82143-50**

a : 64 mm - b : 50 mm

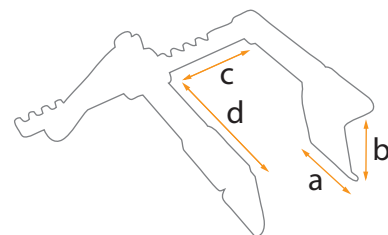

Accessories - Accessoires - Accesorios



**DC82121-16**

Wire valve - Valve en fil - Valva en hilo  
L : 160 mm - a : 19 mm - b : 28 mm

**DC82121-20**

Wire valve - Valve en fil - Valva en hilo  
L : 200 mm - a : 28 mm - b : 38 mm



**DC82124-30**

Additional blade - Valve additionnelle - Valva adicional  
L : 155 mm - a : 35 mm - b : 30 mm

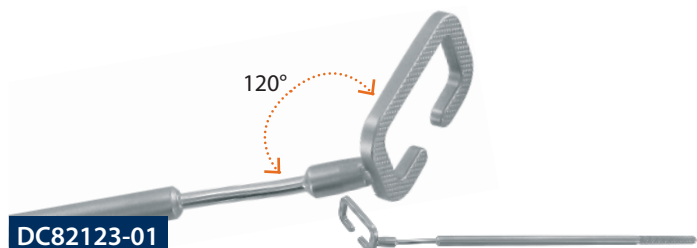

**DC82123-01**

C-shape Cardiac stabilizer - Stabilisateur cardiaque en C - Estabilizador cardíaco en C  
L : 175 mm - a : 18 mm - b : 28 mm

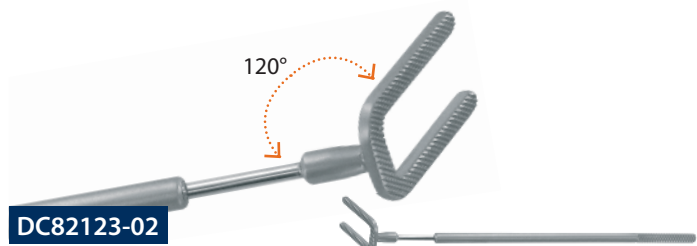

**DC82123-02**

U-shape Cardiac stabilizer - Stabilisateur cardiaque en U - Estabilizador cardíaco en U  
L : 175 mm - a : 18 mm - b : 28 mm

Connectors - Fixations - Fijaciones



**DC82120-30**

3D Arm - Bras 3D - Brazo 3D  
L : 30 mm



**DC82120-50**

3D Arm - Bras 3D - Brazo 3D  
L : 50 mm



**DC82120-90**

3D Arm - Bras 3D - Brazo 3D  
L : 30 mm - 90°



**DC82120-95**

Additional 3D Arm - Bras 3D additionnel - Brazo 3D adicional  
L : 90 mm



**DC82125-05**

Attachment bracket - Bras de fixation - Brazo de fijación  
L : 115 mm

\* Compatible with / Compatibles avec / Compatibles con :  
DC82100-00, DC82100-01, DC82100-02, DC82100-99, DC82130-00, DC82160-00, DC82160-99

Malleable spatula - Spatule malléable - Espátula maleable



**DC82122-22**

L : 220 mm - a : 15 mm - b : 65 mm



**DC82122-24**

L : 240 mm - a : 20 mm - b : 80 mm



**DC82122-26**

L : 260 mm - a : 25 mm - b : 95 mm

\* Compatible with / Compatibles avec / Compatibles con :  
DC82100-00, DC82100-01, DC82100-02, DC82100-99, DC82130-00, DC82160-00, DC82160-99

Double Hinged Retractor / Écarteur Double Articulation / Separador de Doble Articulación



**DC32300-00**

c max : 130 mm - d : 100 mm

Included 3 pairs of blades - 3 paires de valves incluses - 3 pares de valvas incluidas

a : 35 mm - b : 35 mm

a : 35 mm - b : 50 mm

a : 35 mm - b : 63 mm

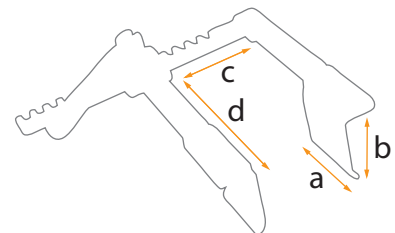



**DC81000-00**

a : 37 mm - b : 58 mm - c max : 90 mm - d : 76 mm



**DC32900-00**

Fixation system with wire hook for MIS retractor

Valve en fil et système de fixation pour écarteur de chirurgie mini-invasive

Valva en hilo y sistema de fijación para separador de cirugía mínimamente-invasiva

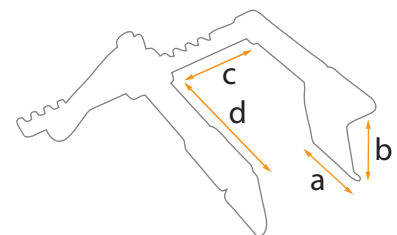

FINOCHIETTO-MATHEY



**DC30600-00**

c max : 130 mm - d : 105 mm

Included 3 pairs of blades - 3 paires de valves incluses - 3 pares de valvas incluidas

a : 40 mm - b : 25 mm

a : 40 mm - b : 35 mm

a : 40 mm - b : 40 mm

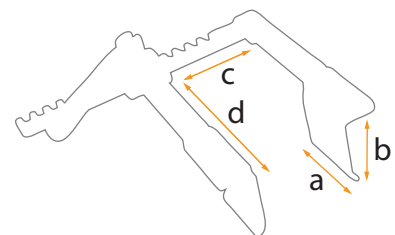



Patented  
Breveté  
Patentado

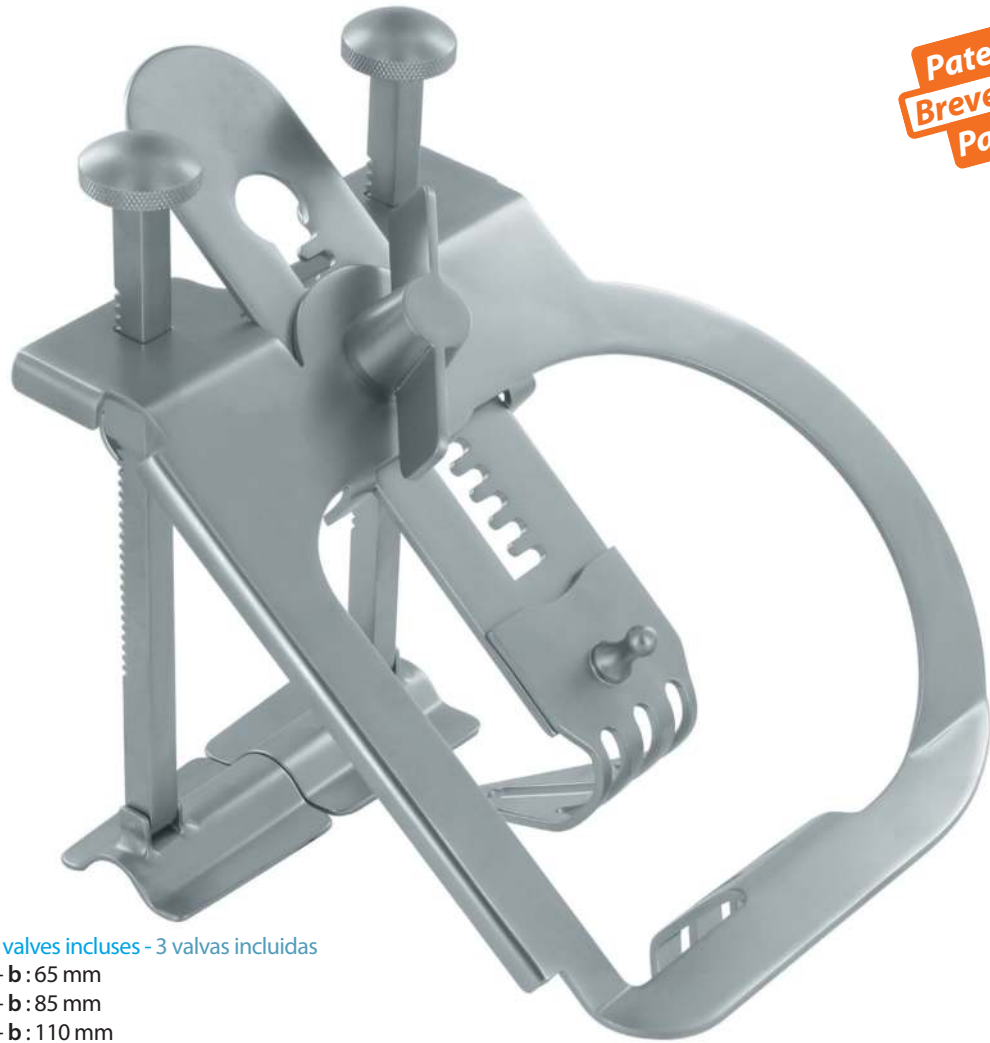

**DC82200-00**

Included 3 blades - 3 valves incluses - 3 valvas incluidas

- a : 40 mm - b : 65 mm
- a : 40 mm - b : 85 mm
- a : 40 mm - b : 110 mm

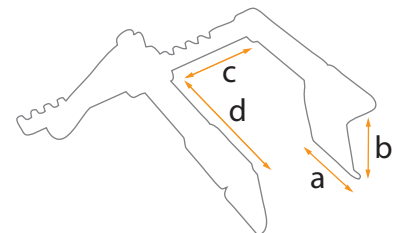



**DC82210-00**

a : 34 mm - b : 34 mm - c max : 110 mm - d : 82 mm

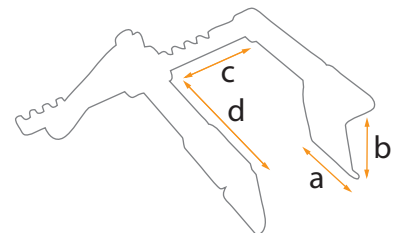

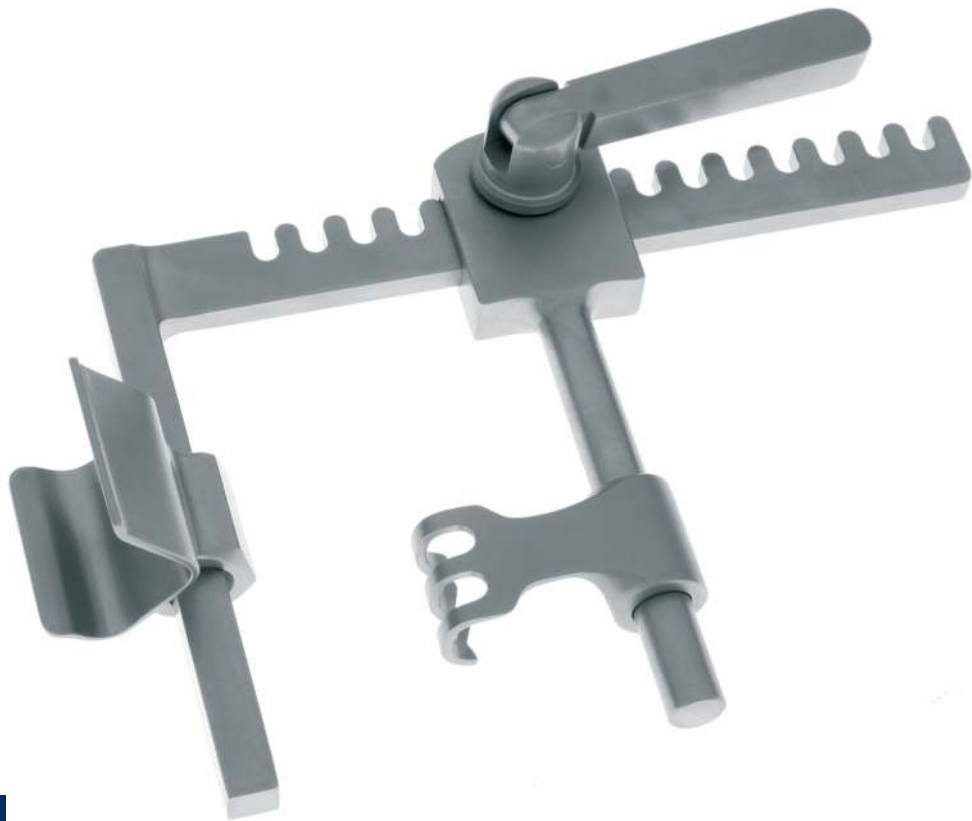

**DC30300-00**

a : 30 mm - b : 20 mm - c max : 120 mm - d : 75 mm

Included - **Inclus** - **Incluidos** : DC30222-38 - Hook - **Crochet** - **Gancho** - L : 38 mm  
 DC30223-43 - Hook - **Crochet** - **Gancho** - L : 43 mm  
 DC30212-20 - "U" shape Blade - **Valve "U"** - **Valva "U"** - a : 38 mm

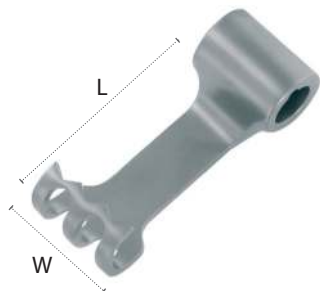

**DC30222-38**

L : 38 mm - W : 20 mm

**DC30223-43**

L : 43 mm - W : 20 mm



"U" Shape  
Valve "U"  
Válvula "U"

**DC30212-20**

a : 38 mm

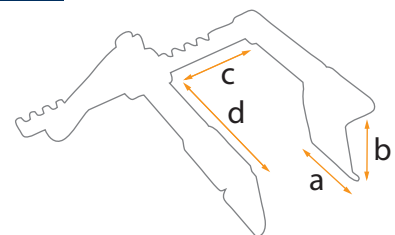

Soft tissue malleable blades  
Lames malléables pour tissus mous .....  
Hojas maleables para tejidos blandos

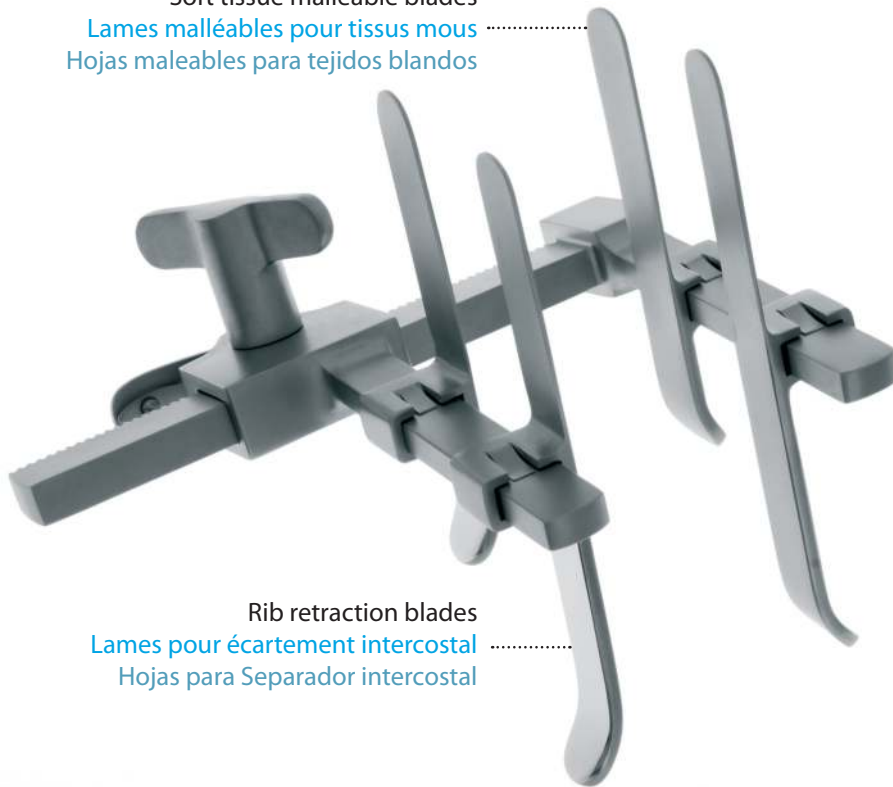

Rib retraction blades  
Lames pour écartement intercostal .....  
Hojas para Separador intercostal

**DC30800-00**

a : 11 mm - c max : 90 mm - d : 80 mm

Included - Inklus - Incluidos : DC30810-25 (pair / paire / pares) - a : 11 mm - b : 25 mm  
DC30813-55 (pair / paire / pares) - a : 11 mm - b : 55 mm



**DC30810-25**

a : 11 mm - b : 25 mm



**DC30811-35**

a : 11 mm - b : 35 mm



**DC30812-45**

a : 11 mm - b : 45 mm



**DC30813-55**

a : 11 mm - b : 55 mm

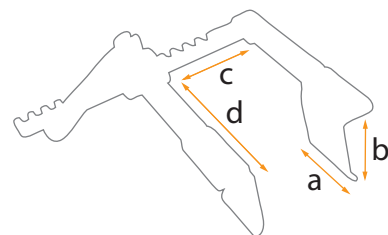

GOSSOT



**DC82950-38**

L : 380 mm - 15" - Ø : 10 mm

Reusable / Réutilisable / Reutilizable

Strreaked tube - Tube strié - Tubo acanalado



**DC82960-07**

L : 70 mm - 2<sup>3/4</sup>" - Ø : 3,5 mm

**DC82960-10**

L : 100 mm - 4" - Ø : 3,5 mm

**DC82961-07**

L : 70 mm - 2<sup>3/4</sup>" - Ø : 5 mm

**DC82961-10**

L : 100 mm - 4" - Ø : 5 mm

**DC82962-07**

L : 70 mm - 2<sup>3/4</sup>" - Ø : 10 mm

**DC82962-10**

L : 100 mm - 4" - Ø : 10 mm



**DC82963-07**

L : 70 mm - 2<sup>3/4</sup>" - Ø : 12 mm

**DC82963-10**

L : 100 mm - 4" - Ø : 12 mm

Threaded tube - Tube fileté - Tubo roscado



**DC82964-07**

L : 70 mm - 2<sup>3/4</sup>" - Ø : 10 mm

**DC82964-10**

L : 100 mm - 4" - Ø : 10 mm

Reusable / Réutilisable / Reutilizable

Flexible - Flexible - Flexible

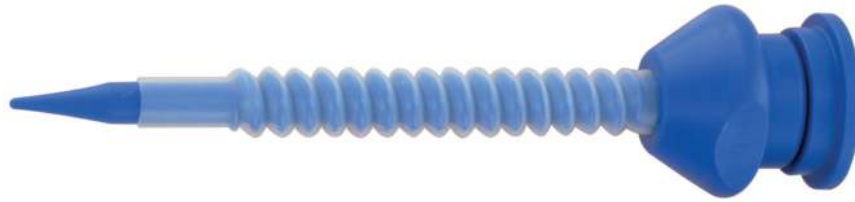

**DC82965-70**

L : 70 mm - 2<sup>3</sup>/<sub>4</sub>" - Ø : 5 mm

GOSSOT

Smooth tube - Tube lisse - Tubo liso



**DC82970-07**

L : 70 mm - 2<sup>3</sup>/<sub>4</sub>" - Ø : 16 x 25 mm

**DC82970-10**

L : 100 mm - 4" - Ø : 16 x 25 mm

Disposable / Usage Unique / Desechable

Blood Deflecting Trocar - Trocart Anti-Goutte - Trócar Deflector de Sangre



STERILE EO



PHT

**E229121** \*

L : 70 mm - 2<sup>3</sup>/<sub>4</sub>" - Ø : 12 mm

For Ø 10mm Endoscope

Pour Endoscope Ø 10 mm

Para endoscopio de Ø 10 mm

**NEW  
NOUVEAU  
NUEVO**

Magnetic Trocars / Trocarts magnétiques / Trocares magnéticos

Streaked tube - Tube strié - Tubo acanalado

NEW  
NOUVEAU  
NUEVO



**DC82981-07**

L : 70 mm - 2<sup>3</sup>/<sub>4</sub>" - Ø : 5 mm

**DC82982-07**

L : 70 mm - 2<sup>3</sup>/<sub>4</sub>" - Ø : 10 mm

**DC82983-07**

L : 70 mm - 2<sup>3</sup>/<sub>4</sub>" - Ø : 12 mm

**DC82981-10**

L : 100 mm - 4" - Ø : 5 mm

**DC82982-10** 

L : 100 mm - 4" - Ø : 10 mm

**DC82983-10**

L : 100 mm - 4" - Ø : 12 mm





Disposable / Usage Unique / Uso único

Fixed Height - Hauteur Fixe - Altura fija

NEW  
NOUVEAU  
NUEVO

Incision Size - Taille d'Incision - Tamaño de la incisión

10 mm → 15 mm

**E220600** \*

Height - Hauteur - Altura : 10 mm

**E220601** \*

Height - Hauteur - Altura : 20 mm

**E220602** \*

Height - Hauteur - Altura : 25 mm

Incision Size - Taille d'Incision - Tamaño de la incisión

15 mm → 30 mm

**E220604** \*

Height - Hauteur - Altura : 5 mm

**E220606** \*

Height - Hauteur - Altura : 25 mm

**E220607** \*

Height - Hauteur - Altura : 35 mm

Incision Size - Taille d'Incision - Tamaño de la incisión

25 mm → 40 mm

**E220609** \*

Height - Hauteur - Altura : 5 mm

**E220610** \*

Height - Hauteur - Altura : 25 mm

**E220611** \*

Height - Hauteur - Altura : 40 mm

Incision Size - Taille d'Incision - Tamaño de la incisión

40 mm → 70 mm

**E220628** \*

Height - Hauteur - Altura : 5 mm

 **E220618** \*

Height - Hauteur - Altura : 25 mm

**E220622** \*

Height - Hauteur - Altura : 40 mm



\* For regulatory reason, please check with your distributor for availability in your country

\* Por razones reglamentarias, por favor póngase en contacto con su distribuidor para conocer la disponibilidad en su país

Disposable / Usage Unique / Uso único



Adjustable Height - Hauteur Ajustable - Altura Ajustable  
40 mm → 150 mm

NEW  
NOUVEAU  
NUEVO



**E220650** \*

Incision Size - Taille d'Incision - Tamaño de la incisión : 10 mm → 35 mm

**E220651** \*

Incision Size - Taille d'Incision - Tamaño de la incisión : 20 mm → 40 mm



**E220653** \*

Incision Size - Taille d'Incision - Tamaño de la incisión : 25 mm → 60 mm

**E220659** \*

Incision Size - Taille d'Incision - Tamaño de la incisión : 50 mm → 85 mm

**E220661** \*

Incision Size - Taille d'Incision - Tamaño de la incisión : 70 mm → 140 mm

**E220666** \*

Incision Size - Taille d'Incision - Tamaño de la incisión : 100 mm → 170 mm

**E220668** \*

Incision Size - Taille d'Incision - Tamaño de la incisión : 150 mm → 250 mm

Intra-Cardiac Surgery Hooks / Crochets Intra-Cardiaques / Ganchos Intracardiacos

OBADIA



Adjustable length  
Longueur réglable  
Longitud ajustable

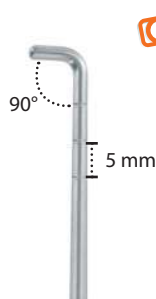

Adjustable length - Longueur réglable - Longitud ajustable

**DC81301-00**

L mini : 290 mm - 11<sup>2/5</sup> " - L maxi : 360 mm - 14<sup>1/5</sup> "

Adjustable length - Longueur réglable - Longitud ajustable

**DC81301-01**

L mini : 200 mm - 7<sup>4/5</sup> " - L maxi : 270 mm - 10<sup>3/5</sup> "

**NEW  
NOUVEAU  
NUEVO**

Fixed length - Longueur fixe - Longitud fija

**DC81301-30**

L : 300 mm - 11<sup>4/5</sup> "



Adjustable length - Longueur réglable - Longitud ajustable

**DC81304-00**

L mini : 290 mm - 11<sup>2/5</sup> " - L maxi : 360 mm - 14<sup>1/5</sup> "

Fixed length - Longueur fixe - Longitud fija

**DC81304-30**

L : 300 mm - 11<sup>4/5</sup> "

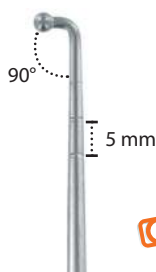

With Round Tip - À embout sphérique - Con punta esférica

Adjustable length - Longueur réglable - Longitud ajustable

**DC81302-00**

L mini : 290 mm - 11<sup>2/5</sup> " - L maxi : 360 mm - 14<sup>1/5</sup> "

Fixed length - Longueur fixe - Longitud fija

**DC81302-30**

L : 300 mm - 11<sup>4/5</sup> "

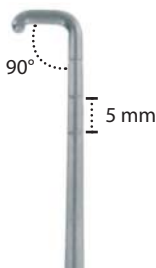

With sabot - À sabot - Con retorno

Adjustable length - Longueur réglable - Longitud ajustable

**DC81307-00**

L mini : 290 mm - 11<sup>2/5</sup> " - L maxi : 360 mm - 14<sup>1/5</sup> "

Fixed length - Longueur fixe - Longitud fija

**DC81307-30**

L : 300 mm - 11<sup>4/5</sup> "

Surgery Hook / Crochet / Gancho

YILMAZ



Ø : 0.5 mm



Fixed length - Longueur fixe - Longitud fija

**DC81305-21**

L : 210 mm - 8<sup>1</sup>/<sub>5</sub>"

**NEW  
NOUVEAU  
NUEVO**

Fixed length - Longueur fixe - Longitud fija

**DC81305-30**

L : 300 mm - 11<sup>4</sup>/<sub>5</sub>"



OBADIA



With sliding handle  
Avec manche coulissant  
Con mango corredero



DC81303-33

L : 330 mm - 13"





GRASPING FORCEPS / PINCES À PRÉHENSION / PINZAS DE AGARRE

Ø 3 mm



Ø 5 mm



Ø 5 mm

Lymph node forceps / Pincès à ganglions / Pinzas para ganglios



TRANSTHORACIC CLAMPS / CLAMPS TRANSTHORACIQUES / PINZAS TRANSTORÁDICAS

DeBakey



DeBakey



DeBakey

Double curved / Double courbure / Doble curvatura

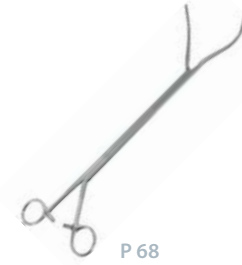

TRANSTHORACIC GRASPING FORCEPS / PINCES À PRÉHENSION TRANSTHORACIQUES / PINZAS DE AGARRE TRANSTORÁDICAS

Duval



Duval



Foerster



Allis







Ø 3 mm

Only one mobile jaw  
Un seul mors mobile  
Sólo una boca móvil

Straight  
Droite  
Recta



DC83216-36

L : 360 mm - 14<sup>1/5</sup>"

Progressive locking system  
Crémaillère progressive  
Cremallera progresiva

Titanium *line*



Grasping Fenestrated Forceps / Pinces à Préhension Fenêtrées / Pinzas de Agarre Fenestradas

Ø 5 mm

Registered Design  
Modèle déposé  
Diseño registrado

Straight  
Droite  
Recta

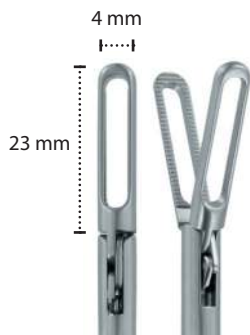

**DC83213-36**

L : 360 mm - 14<sup>1/5</sup>"

**DC83213-44**

L : 440 mm - 17<sup>1/3</sup>"

Curved Shaft  
Tube courbe  
Tubo curvado



**DC83221-44**

L : 440 mm - 17<sup>1/3</sup>"

Progressive locking system  
Crémaillère progressive  
Cremallera progresiva

Titanium *line*



Registered Design  
Modèle déposé  
Diseño registrado

GOSSOT  
Ø 5 mm

Straight  
Droite  
Recta



**DC83210-36**  
L : 360 mm - 14<sup>1</sup>/<sub>5</sub>"  
**DC83210-44**  
L : 440 mm - 17<sup>1</sup>/<sub>3</sub>"

Straight  
Droite  
Recta



**DC83211-36**  
L : 360 mm - 14<sup>1</sup>/<sub>5</sub>"  
**DC83211-44**  
L : 440 mm - 17<sup>1</sup>/<sub>3</sub>"



Progressive locking system  
Crémaillère progressive  
Cremallera progresiva

Titanium *line*

Transthoracic Clamp / Clamp Transthoracique / Pinza Transtorácica



DeBaKey

Teeth  
Dents  
Dientes  
2 x 3



**DC80401-37**

L : 375 mm - 14<sup>4/5</sup>"

Jaws - Mors - Bocas : 80 mm



Transthoracic Clamps / Clamps Transthoraciques / Pinzas Transtorácicas



DeBailey

Teeth  
Dents  
Dientes  
2 x 3



**DC80402-32**

L : 320 mm - 12<sup>3</sup>/<sub>5</sub>"  
Jaws - Mors - Bocas : 80 mm

**DC80402-37**

L : 370 mm - 14<sup>3</sup>/<sub>5</sub>"  
Jaws - Mors - Bocas : 80 mm

**DC80403-35**

L : 365 mm - 14<sup>2</sup>/<sub>5</sub>"  
Jaws - Mors - Bocas : 116 mm

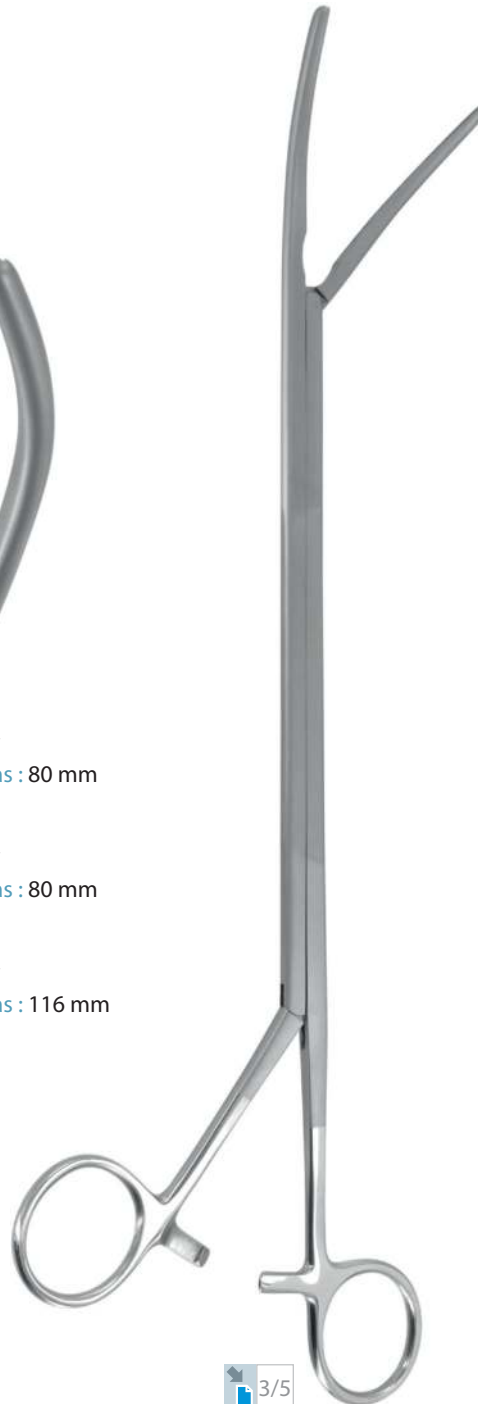

Teeth  
Dents  
Dientes  
1 x 2



**DC80405-31**

L : 310 mm - 12<sup>1</sup>/<sub>5</sub>"  
Jaws - Mors - Bocas : 60 mm

**DC80404-32**

L : 320 mm - 12<sup>3</sup>/<sub>5</sub>"  
Jaws - Mors - Bocas : 65 mm

**DC80404-36**

L : 360 mm - 14<sup>1</sup>/<sub>5</sub>"  
Jaws - Mors - Bocas : 100 mm

Teeth  
Dents  
Dientes  
2 x 3

**DC80405-33**

L : 360 mm - 14<sup>1</sup>/<sub>5</sub>"  
Jaws - Mors - Bocas : 100 mm

Transthoracic Clamps / Clamps Transthoraciques / Pinzas Transtorácicas



DeBakey

Double Curved  
Double Courbure  
Doble Curvatura



**DC80406-35**

L : 350 mm - 13<sup>4</sup>/<sub>5</sub>"  
Jaws - Mors - Bocas : 82 mm  
With Ratchet  
Avec Crémaillère  
Con Cremallera

**DC80407-36**

L : 350 mm - 13<sup>4</sup>/<sub>5</sub>"  
Jaws - Mors - Bocas : 82 mm  
Without Ratchet  
Sans Crémaillère  
Sin Cremallera

**DC80408-35**

L : 355 mm - 13<sup>4</sup>/<sub>5</sub>"  
Jaws - Mors - Bocas : 85 mm  
With Ratchet  
Avec Crémaillère  
Con Cremallera

**DC80409-35**

L : 355 mm - 13<sup>4</sup>/<sub>5</sub>"  
Jaws - Mors - Bocas : 85 mm  
Without Ratchet  
Sans Crémaillère  
Sin Cremallera

Lymph Node Forceps / Pinces à Ganglions / Pinza del Ganglio Linfático



**DC80429-34**

L : 340 mm - 13<sup>2/5</sup>"  
Jaws - Mors - Bocas : 70 mm  
With Ratchet  
Avec Crémaillère  
Con Cremallera

DUVAL



**DC80415-34**

L : 340 mm - 13<sup>2/5</sup>"

Jaws - Mors - Bocas : 75 mm - w : 15 mm

With Ratchet

Avec Crémaillère

Con Cremallera

**DC80414-34**

L : 340 mm - 13<sup>2/5</sup>"

Jaws - Mors - Bocas : 75 mm - w : 25 mm

With Ratchet

Avec Crémaillère

Con Cremallera

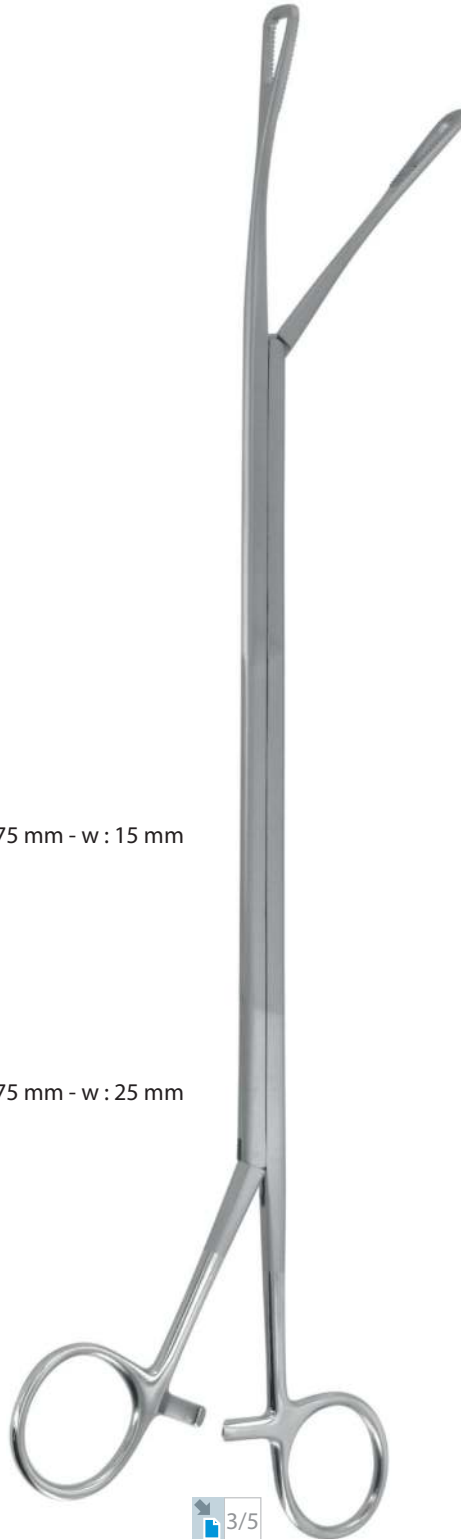



FOERSTER



**DC80411-34**

L : 340 mm - 13<sup>2/5</sup>"  
Jaws - Mors - Bocas : 80 mm  
With Ratchet  
Avec Crémaillère  
Con Cremallera

**DC80410-34**

L : 340 mm - 13<sup>2/5</sup>"  
Jaws - Mors - Bocas : 80 mm  
Without Ratchet  
Sans Crémaillère  
Sin Cremallera



**DC80412-34**

L : 340 mm - 13<sup>2/5</sup>"  
Jaws - Mors - Bocas : 90 mm  
With Ratchet  
Avec Crémaillère  
Con Cremallera

**DC80413-34**

L : 340 mm - 13<sup>2/5</sup>"  
Jaws - Mors - Bocas : 90 mm  
Without Ratchet  
Sans Crémaillère  
Sin Cremallera

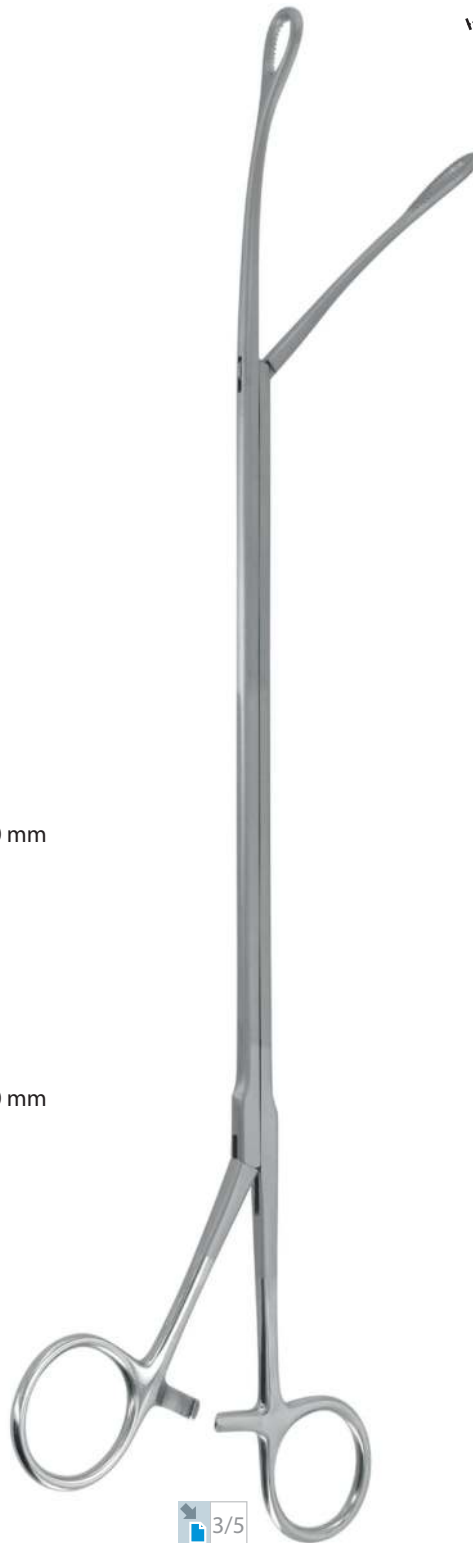

ALLIS

6 mm



**DC80416-34**

L : 340 mm - 13<sup>2/5</sup>"

Jaws - Mors - Bocas : 68 mm

3/5

NEEDLE HOLDERS / PORTE-AIGUILLES / PORTA AGUJAS

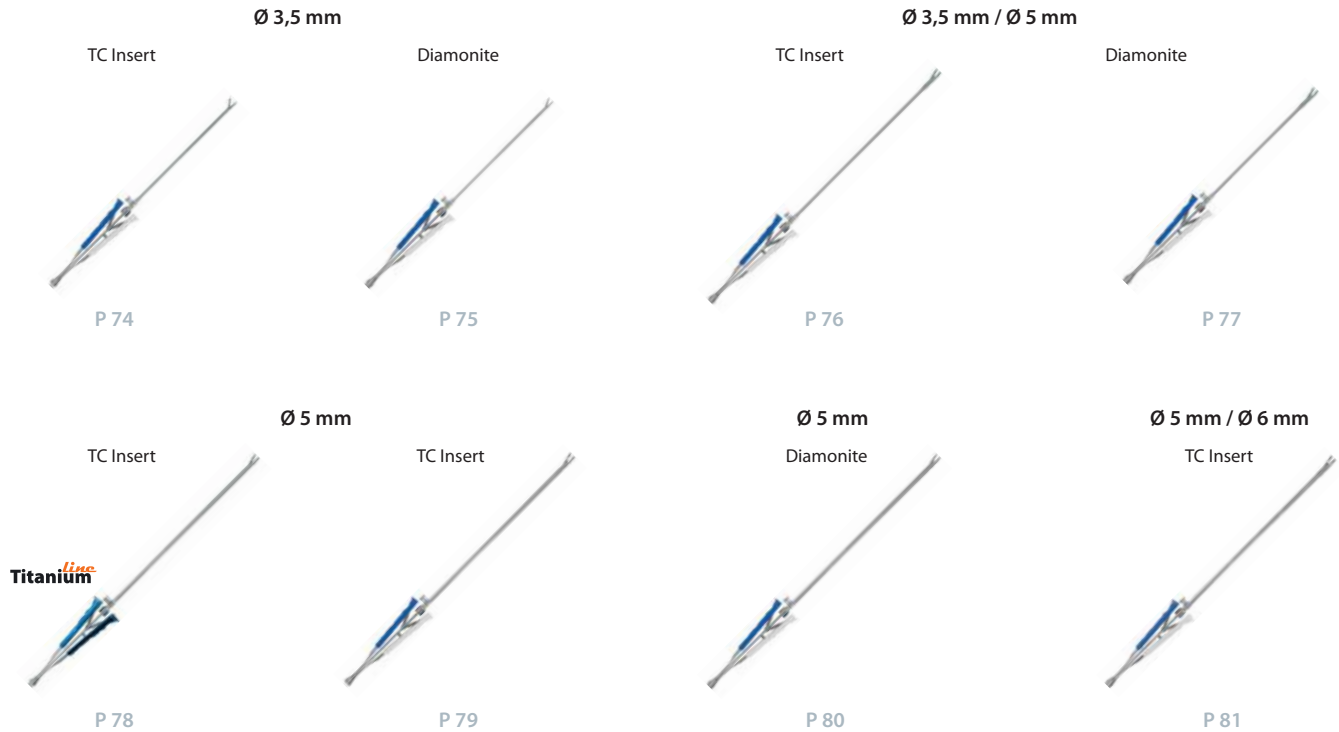

KNOT PUSHERS / POUSSE-NOEUDS / EMPUJA NUDOS

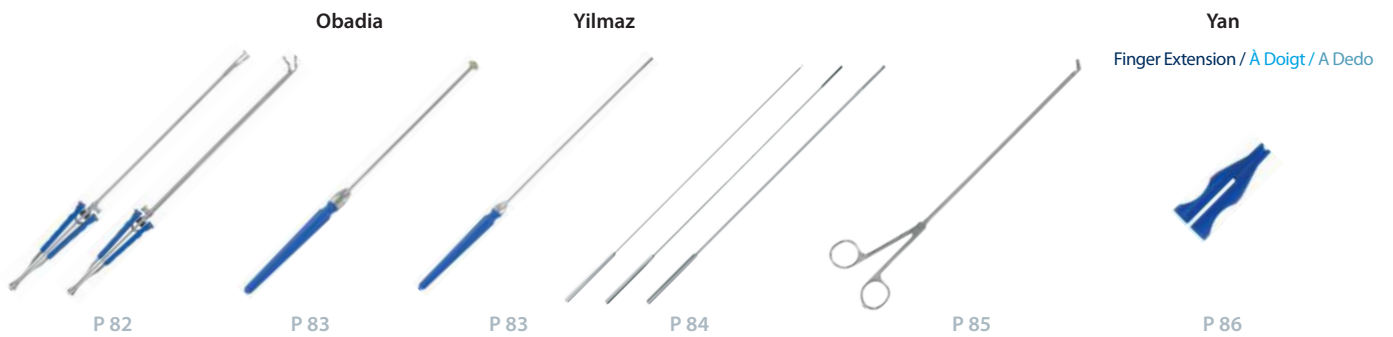

TRANSTHORACIC NEEDLE HOLDERS / PORTE-AIGUILLES TRANSTHORACIQUES / PORTA AGUJAS TRANSTORÁDICOS



Tungsten Carbide Needle Holders / Porte-Aiguilles Tungstène / Porta Agujas de Tungsteno



TC Inserts

Ø 3.5 mm

New locking system  
Nouveau système de fermeture  
Nuevo sistema de cierre

Straight  
Droit  
Recta

Ryder



DC80014-28

L : 280 mm - 11"

Suture from 9/0 to 6/0  
Suture de 9/0 à 6/0  
Sutura desde 9/0 hasta 6/0

Curved  
Courbe  
Curva



DC80018-28

L : 280 mm - 11"





Diamonite

Ø 3.5 mm

New locking system  
Nouveau système de fermeture  
Nuevo sistema de cierre



Suture from 9/0 to 6/0  
Suture de 9/0 à 6/0  
Sutura desde 9/0 hasta 6/0

Curved  
Courbe  
Curva

1.3 mm



 DC80015-28

L : 280 mm - 11"

2.1 mm



DC80017-28

L : 280 mm - 11"



Tungsten Carbide Needle Holders / Porte-Aiguilles Tungstène / Porta Agujas de Tungsteno



TC Inserts

Ø 3.5 mm / Ø 5 mm

New locking system  
Nouveau système de fermeture  
Nuevo sistema de cierre

Straight  
Droit  
Recta



**DC80023-30**

L : 300 mm - 11<sup>4</sup>/<sub>5</sub>"

Curved  
Courbe  
Curva



**DC80022-30**

L : 300 mm - 11<sup>4</sup>/<sub>5</sub>"



**DC80022-36**

L : 360 mm - 14<sup>1</sup>/<sub>5</sub>"

Ryder



**DC80024-30**

L : 300 mm - 11<sup>4</sup>/<sub>5</sub>"

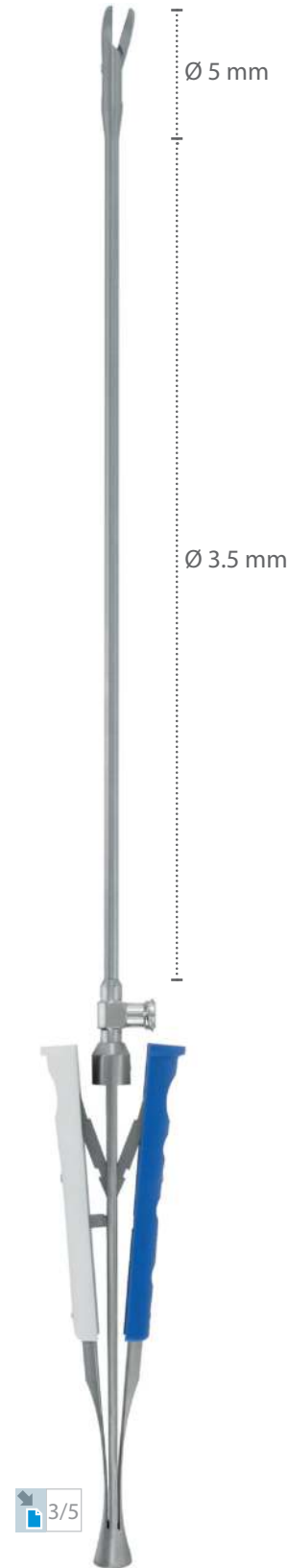

3/5



Diamonite

Ø 3.5 mm / Ø 5 mm

New locking system  
Nouveau système de fermeture  
Nuevo sistema de cierre



Curved  
Courbe  
Curva



**DC80020-30**

L : 300 mm - 11<sup>4/5</sup>"

Tungsten Carbide Needle Holders / Porte-Aiguilles Tungstène / Porta Agujas de Tungsteno



TC Inserts

Ø 5 mm

Suture from 6/0 to 2/0  
Suture de 6/0 à 2/0  
Sutura desde 6/0 hasta 2/0

Straight  
Droit  
Recta



 DC83003-36

L : 360 mm - 14<sup>1</sup>/<sub>5</sub>"

DC83003-44

L : 440 mm - 17<sup>1</sup>/<sub>3</sub>"

Curved  
Courbe  
Curva



DC83002-36

L : 360 mm - 14<sup>1</sup>/<sub>5</sub>"

DC83002-44

L : 440 mm - 17<sup>1</sup>/<sub>3</sub>"



Titanium *line*

 3/5



Tungsten Carbide Needle Holders / Porte-Aiguilles Tungstène / Porta Agujas de Tungsteno



TC Inserts

Straight  
Droit  
Recta

Ryder



**DC80014-36**

L : 360 mm - 14<sup>1/5</sup>"



**DC80013-25**

L : 250 mm - 10"

**DC80013-30**

L : 300 mm - 11<sup>4/5</sup>"

**DC80013-36**

L : 360 mm - 14<sup>1/5</sup>"

**DC80013-44**

L : 440 mm - 17<sup>1/3</sup>"

Ø 5 mm

Suture from 6/0 to 2/0  
Suture de 6/0 à 2/0  
Sutura desde 6/0 hasta 2/0

New locking system  
Nouveau système de fermeture  
Nuevo sistema de cierre



3/5

Curved  
Courbe  
Curva



**DC80012-25**

L : 250 mm - 10"

**DC80012-30**

L : 300 mm - 11<sup>4/5</sup>"

**DC80012-36**

L : 360 mm - 14<sup>1/5</sup>"

**DC80012-43**

L : 430 mm - 17"

Diamonite Needle Holders / Porte-Aiguilles Diamonite / Porta Agujas de Diamonite



Diamonite

Ø 5 mm

New locking system  
Nouveau système de fermeture  
Nuevo sistema de cierre

Suture from 9/0 to 6/0  
Suture de 9/0 à 6/0  
Sutura desde 9/0 hasta 6/0

Straight  
Droit  
Recta



 DC80011-36

L : 360 mm - 14<sup>1</sup>/<sub>5</sub>"

Curved  
Courbe  
Curva



DC80010-36

L : 360 mm - 14<sup>1</sup>/<sub>5</sub>"



 3/5



TC Inserts

Ø 5 mm / Ø 6 mm

Suture from 6/0 to 2/0  
Suture de 6/0 à 2/0  
Sutura desde 6/0 hasta 2/0

New locking system  
Nouveau système de fermeture  
Nuevo sistema de cierre

**Very strong tightening**  
**Préhension puissante**  
**Apriete muy sólido**

Straight  
Droit  
Recta



**DC80009-36**

L : 360 mm - 14<sup>1</sup>/<sub>5</sub>"

Curved  
Courbe  
Curva



**DC80019-30**

L : 300 mm - 11<sup>4</sup>/<sub>5</sub>"



**DC80019-36**

L : 360 mm - 14<sup>1</sup>/<sub>5</sub>"

Ø 6 mm

Ø 5 mm



Active Knot Pushers / Pousse-Noeuds Actifs / Empuja-Nudos

Ø 3.5 mm / Ø 5 mm

Ø 5 mm



**DC80302-36**

L : 360 mm - 14<sup>1/5</sup>"  
With Ratchet  
Avec Verrou  
Con Cerrojo

**DC80300-30**

L : 300 mm - 11<sup>4/5</sup>"



**DC80300-36**

L : 360 mm - 14<sup>1/5</sup>"



**DC80303-36**

L : 360 mm - 14<sup>1/5</sup>"  
Without Ratchet  
Sans Verrou  
Sin Cerrojo

Knot Pushers / Pousse-Noeuds / Empuja-Nudos

OBADIA

Fixed length  
Longueur fixe  
Longitud fija



**DC81308-28**

L : 280 mm - 11"

**DC81308-35**

L : 350 mm - 13<sup>3/4</sup>"

Adjustable length  
Longueur réglable  
Longitud adjustable



**DC81308-00**

L mini : 290 mm - 11<sup>2/5</sup>"

L maxi : 360 mm - 14<sup>1/5</sup>"



YILMAZ

Fixed length  
Longueur fixe  
Longitud fija

Ø 2 mm



**DC81323-21**

L : 210 mm - 8<sup>1/5</sup>"



**DC81323-30**

L : 300 mm - 11<sup>4/5</sup>"

NEW  
NOUVEAU  
NUEVO



Knot Pushers / Pousse-Noeuds / Empuja-Nudos

Ø 4 mm

Ø 4,5 mm

Ø 4,5 mm

With Open Eye  
Ouvert  
Abierto

With Slot  
Avec fente  
Con ranura

Closed  
Fermé  
Cerrado



**E0619040** 

L : 330 mm - 13"

**E0619041**

L : 450 mm - 17<sup>3</sup>/<sub>4</sub>"



**E0619042**

L : 330 mm - 13"



**E0619043**

L : 330 mm - 13"



Knot-Pusher with Wire Cutter  
Pousse-noeuds avec coupe-fil  
Empuja-Nudos con cortador de alambre

NEW  
NOUVEAU  
NUEVO



YAN

NEW  
NOUVEAU  
NUEVO



**DC71710-50**

L : 50 mm - 2"



Transthoracic Needle Holders / Porte-Aiguilles Transthoraciques / Porta Aguja Transtorácicos



TC Inserts

Straight jaws  
Mors Droits  
Bocas Rectas



**DC80452-34**

L : 340 mm - 13<sup>2/5</sup>"

Shaft - Tube - Tubo : 7 mm

Angled jaws  
Mors Angulés  
Bocas Anguladas



**DC80453-34**

L : 340 mm - 13<sup>2/5</sup>"

Shaft - Tube - Tubo : 7 mm



**DC80450-34**

L : 340 mm - 13<sup>2/5</sup>"

Shaft - Tube - Tubo : 10 mm



**DC80451-34**

L : 340 mm - 13<sup>2/5</sup>"

Shaft - Tube - Tubo : 10 mm



3/5



BIOPSY FORCEPS / PINCES À BIOPSIE / PINZAS DE BIOPSIA

Ø 2 mm / Ø 2.5 mm



P 91

CHORDAE SUTURE RULER / GABARITS POUR CORDAGES TENDINEUX / PLANTILLAS PARA CUERDAS TENDINOSAS



P 92

ACCESSORIES / ACCESSOIRES / ACCESORIOS

Suture catcher / Crochet à suture / Gancho para sutura

Needles retriever / Récupérateur à aiguilles / Recuperador de agujas

Suture ring / Anneau à sutures / Anillo para sutura



P 93



P 94



P 95

MIS SUCTION TUBE / CANULE D'ASPIRATION MIS / CÁNULA DE ASPIRACIÓN MIS



P 96

MIS AORTIC VALVE RONGEURS / RONGEURS AORTIQUES MIS / GUBIAS PARA VÁLVULA AÓRTICA



P 97



P 98



P 99

TUBE PASSER / PASSE TUBE / TUBO PASE

SCALPEL BLADE HANDLES / MANCHES DE BISTOURI / MANGOS DE BISTURÍ



P 100



P 101

CARDIOPLEGIA NEEDLES / AIGUILLES DE CARDIOPLÉGIE / AGUJAS DE CARDIOPLEJIA



P 102

INSTRUMENT HOLDER / PORTE INSTRUMENTS / SOPORTE DEL INSTRUMENTO

TRAINER+ / TRAINER+ / TRAINER+

Gossot



P 103



P 104

Ø 2 mm / Ø 2.5 mm

Round Angled Cupules Ø 2 mm  
*Cupules Rondes Angulées Ø 2 mm*  
*Redondo Angulado Cupula Ø 2 mm*



**J00021**  
L : 280 mm - 11"

Angled Jaws 2x4 mm  
*Mors Angulés 2x4 mm*  
*Bocas Anguladas 2x4 mm*



**J00022**  
L : 280 mm - 11"

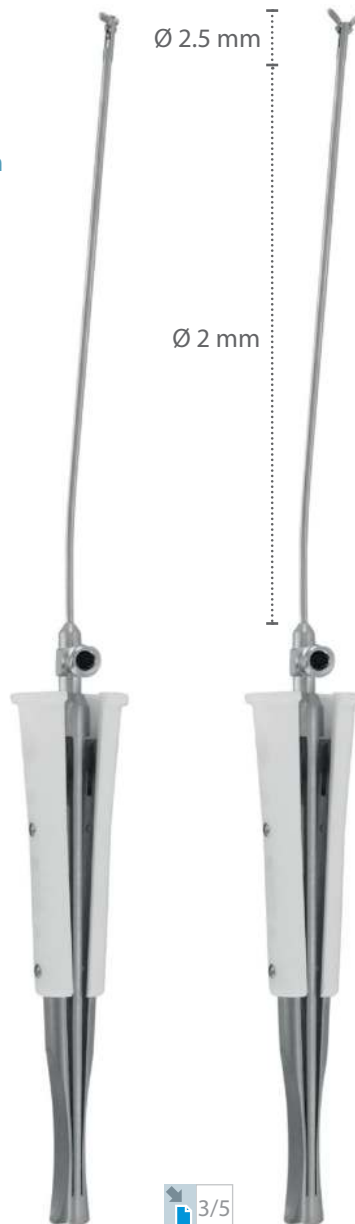

OBADIA

Distal tip designed for synthetic cords calibration and preparation.

Extrémité distale permettant la création des boucles de cordages synthétiques.

Punta distal diseñada para hilo sintético.

Secure your sizing. Easy locking system after measurement.

Conserve votre mesure. Système de verrouillage après mesure.

Conserva su medida. Sistema de bloqueo después de medida.

Laser graduated. Graduation au laser. Graduación laser.

Straight  
Droite  
Recta

**DC81320-38**

L : 380 mm - 15"



Curved  
Courbe  
Curva

**DC81322-38**

L : 380 mm - 15"

Suture Catcher / Crochet à Suture / Gancho para Sutura

Fixed length  
Longueur fixe  
Longitud fija



**DC81410-28**

L : 280 mm - 11"



Needles Retrievers / Récupérateurs à Aiguilles / Recuperadores de Agujas

Fixed length  
Longueur fixe  
Longitud fija



**DC81310-28**

L : 280 mm - 11"

Magnetic tip  
Embout aimanté  
Punta magnética

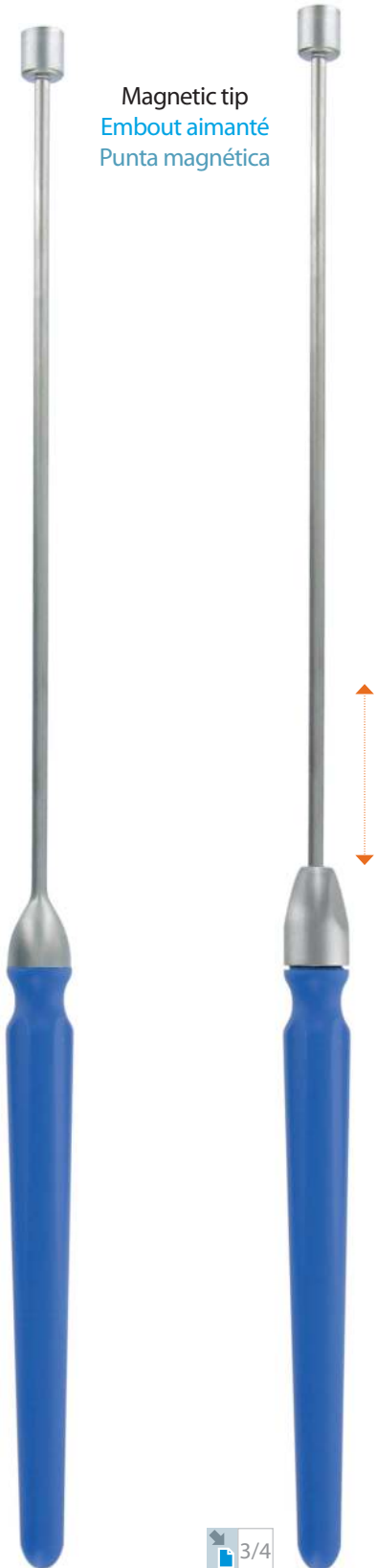

Adjustable length  
Longueur réglable  
Longitud adjustable



**DC81310-00**

L mini : 290 mm - 11<sup>2</sup>/<sub>5</sub>"

L maxi : 360 mm - 14<sup>1</sup>/<sub>5</sub>"





Suture Ring / Anneau à Sutures / Anillo para Suturas

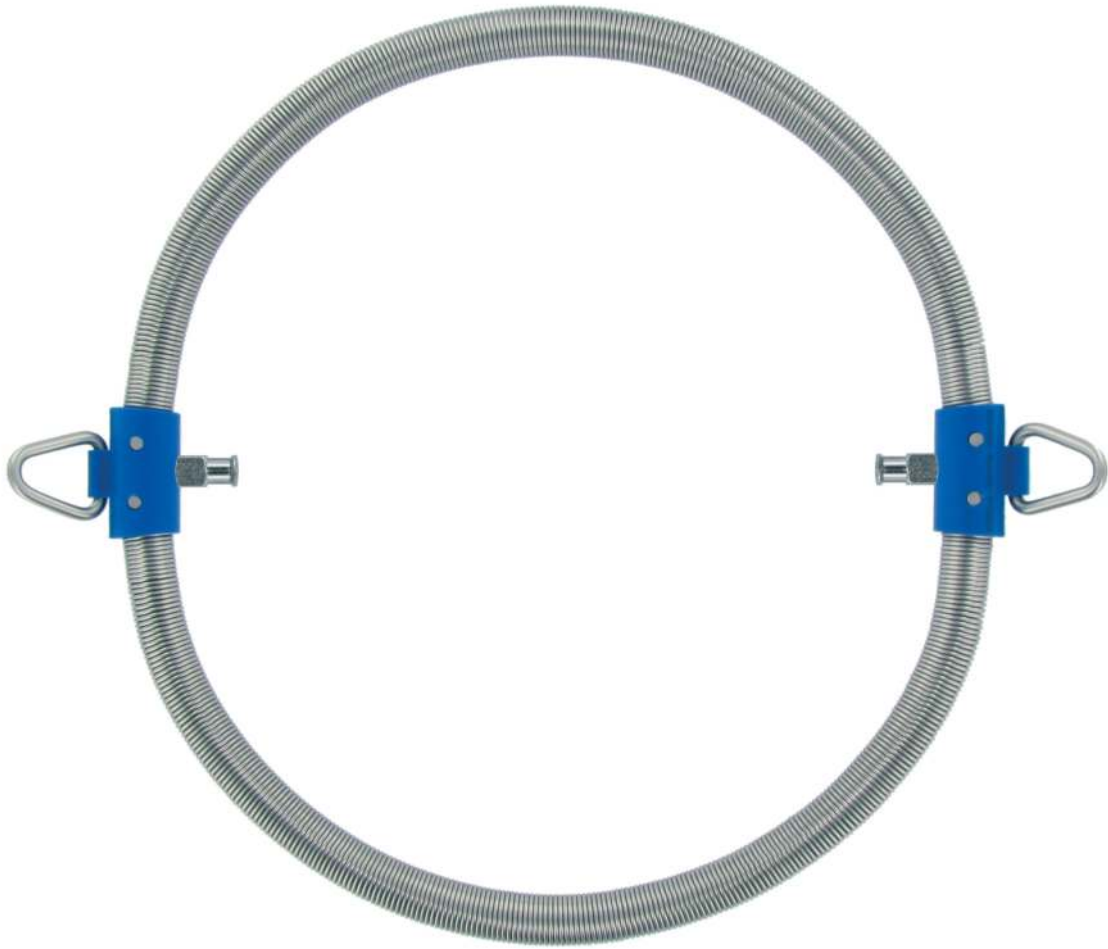

**DC81400-00**

Ø : 220 mm - 8<sup>2/3</sup>"

Without Luer Lock

Sans raccord Luer Lock

Sin conexión Luer Lock



**DC81400-01**

Ø : 220 mm - 8<sup>2/3</sup>"

With Luer Lock

Avec raccord Luer Lock

Con conexión Luer Lock

MIS Suction Tube / Canule d'Aspiration MIS / Cánula de Aspiración MIS

8 mm



**DC71337-33** \*

L : 330 mm - 13"



**DC71337-33-C** \*

L : 260 mm - 10"



**DC71337-33-S** \*

L : 260 mm - 10"

Straight / Droit / Recta

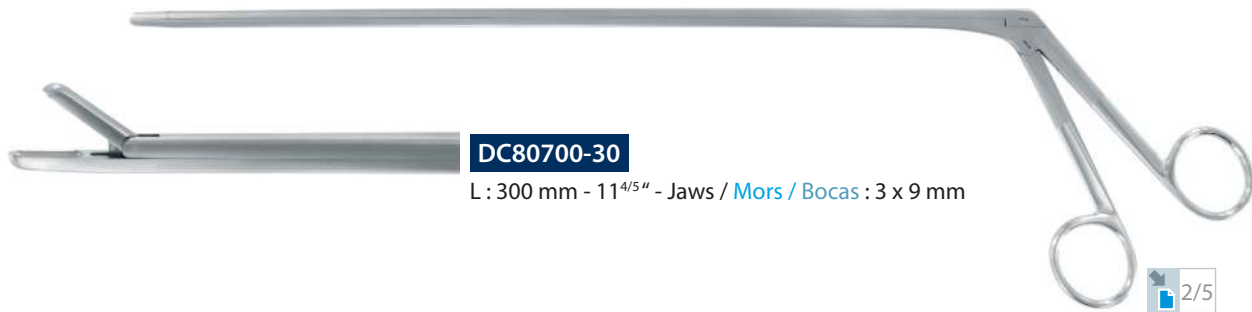

Angled upwards 30° / Angulé vers le haut de 30° / Angulado hacia arriba de 30°



Angled downwards 30° / Angulé vers le bas de 30° / Angulado hacia abajo de 30°



NEW  
NOUVEAU  
NUEVO

Straight / Droit / Recta



DC80710-23

L : 230 mm - 9" - Jaws / Mors / Bocas : 6 x 12 mm

4/5

Angled upwards 45° / Angulé vers le haut de 45° / Angulado hacia arriba de 45°



DC80711-23

L : 230 mm - 9" - Jaws / Mors / Bocas : 6 x 12 mm

4/5

NEW  
NOUVEAU  
NUEVO



DC80730-30

L : 300 mm - 11<sup>4/5</sup>"

3/5



**DC80420-24**

L : 240 mm - 9<sup>1/2</sup>"

With Ratchet  
Avec Crémaillère  
Con Cremallera

**DC80417-24**

L : 240 mm - 9<sup>1/2</sup>"

Without Ratchet  
Sans Crémaillère  
Sin Cremallera

**DC80419-36**

L : 355 mm - 14"

With Ratchet  
Avec Crémaillère  
Con Cremallera

**DC80418-36**

L : 355 mm - 14"

Without Ratchet  
Sans Crémaillère  
Sin Cremallera



Scalpel Blade Handles / Manches de Bistouri / Mangos de Bisturí

Beaver

For Beaver blades  
Pour lames Beaver  
Para hojas Beaver



**DC81331-33**  
L : 330 mm - 13"



For blades models  
Pour modèles de lames  
Para modelos de hojas



- 10
- 11P
- 12
- 15S
- 18
- 19

Adjustable length  
Longueur réglable  
Longitud ajustable

**DC81330-00**

L mini : 290 mm - L maxi : 360 mm

**DC81330-01**

L mini : 180 mm - L maxi : 250 mm

NEW  
NOUVEAU  
NUEVO

Fixed length  
Longueur fixe  
Longitud fija



**DC81330-33**

L : 330 mm - 13"

Cardioplegia Needles / Aiguilles de Cardioplégie / Aguja de Cardioplejia



**DC80721-02**

L : 340 mm - 13" - Ø 2 mm

**DC80721-03**

L : 340 mm - 13" - Ø 3 mm





GOSSOT

NEW  
NOUVEAU  
NUEVO

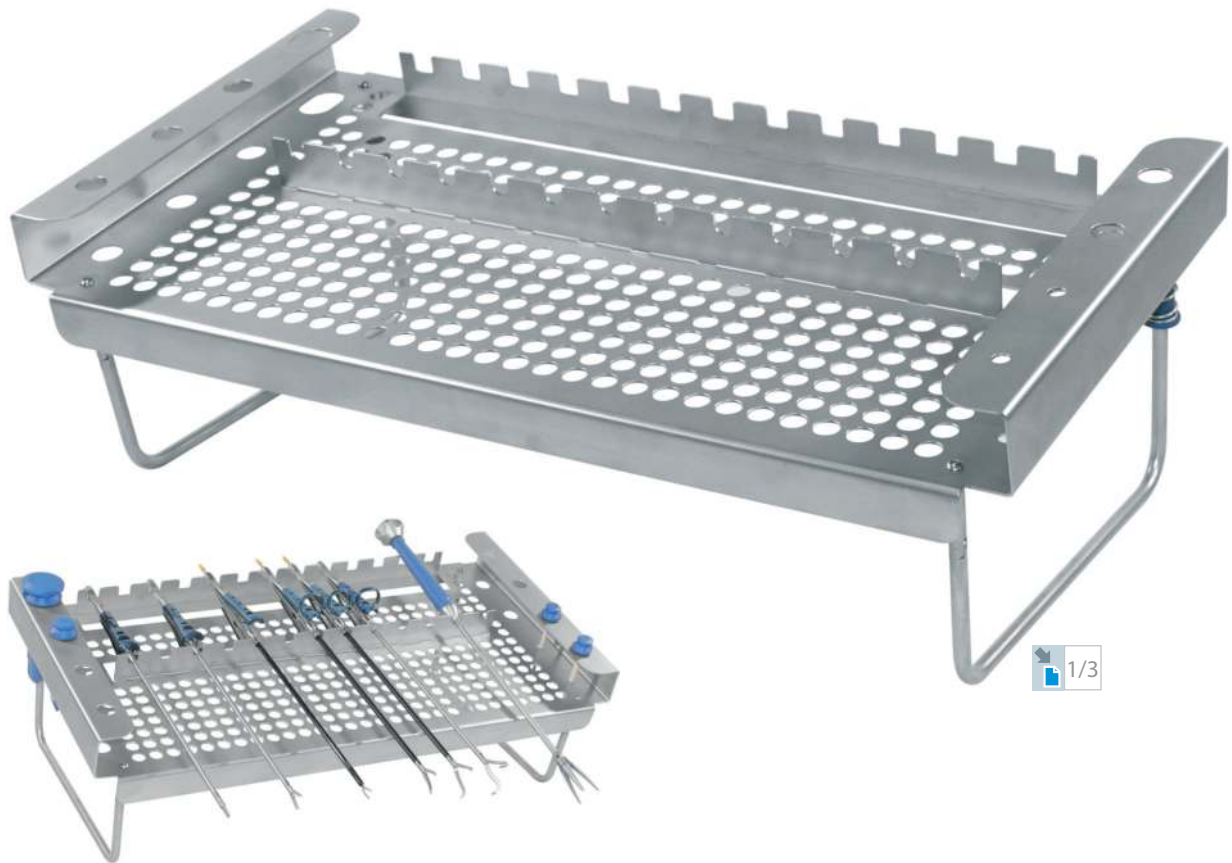

Comfort model / [Modèle confort](#) / [Modelo de confort](#)

 **DC81930-01**

L : 543 mm x l : 277 mm x h : 84 mm

Instruments not included / [Instruments non inclus](#) / [Instrumentos no incluidos](#)

Reduced size version for sterilization in container

[Version réduite pour stérilisation en conteneur](#)

[Versión reducida para esterilización en contenedores](#)

**DC81930-02**

L : 511 mm x l : 245 mm x h : 84 mm

Instruments not included / [Instruments non inclus](#) / [Instrumentos no incluidos](#)

Trainer+ Pack / Pack Trainer+ / Paquete Trainer+



**DC89100-00**

Trainer+ Pack / Pack Trainer+ / Paquete Trainer+



Trainer+ holder  
Support Trainer+  
Soporte Trainer+



Mitral valve holder  
Support valve mitrale  
Soporte válvula mitral



1 Mitral valve  
1 valve mitrale  
1 Válvula mitral



Trainer+ Bag  
Valise Trainer+  
Maleta Trainer+

Training valves / Valves pour formation / Válvulas de formación



**DC89111-10**  
10 Mitral valves  
10 Valves mitrales  
10 Válvulas mitrales



**DC89112-05**  
5 Mitral valves with papillary muscles  
5 Valves mitrales avec muscles papillaires  
5 Válvulas mitrales con músculos papilares

Options / Options / Opciones



**DC89101-00**  
Endoscope holder  
Porte-Endoscope  
Soporte endoscopio

INSTRUMENTS SETS / KITS D'INSTRUMENTS / KITS DE INSTRUMENTOS

GOSSOT

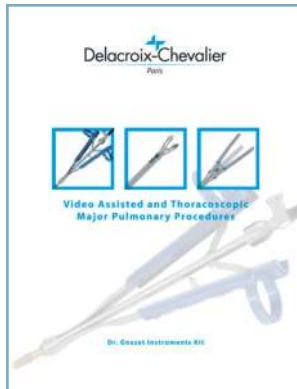

P 107

OBADIA II



P 108

YAN



P 109

Aortic Valve  
Valve aortique  
Válvula aórtica



P 110

MIDCAB

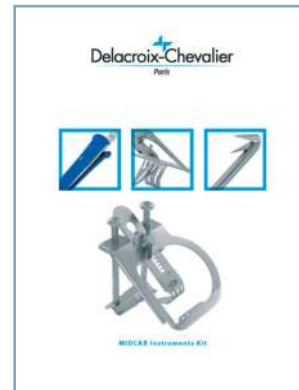

P 111

STERILIZATION TRAYS / PANIERS DE STÉRILISATION / CESTA DE ESTERILIZACIÓN

GOSSOT



P 107 - P 112

OBADIA

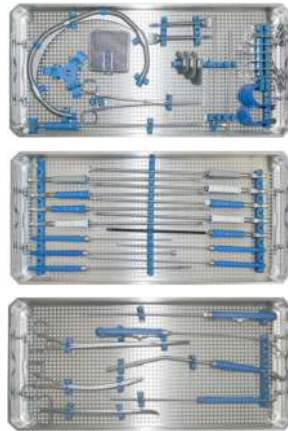

P108 - P 112

YAN

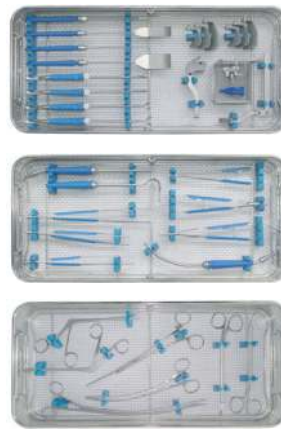

P 109 - P 113

Aortic Valve  
Valve aortique  
Válvula aórtica



P110 - P113

MIDCAB



P 111 - P 114

THORACCESS



P114

GENERAL

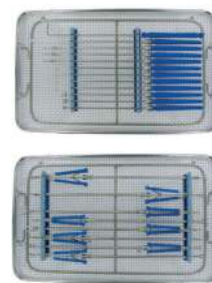

P115

Resecciones Pulmonares Mayores por Vía Endoscópica

GOSSOT

Trocars

DC82960-07:  
Thoracic trocar  
Trocart pour thoroscopie - Trocar para toroscopia



DC82964-07:  
Thoracic trocar  
Trocart pour thoroscopie - Trocar para toroscopia



DC82961-07:  
Thoracic trocar  
Trocart pour thoroscopie - Trocar para toroscopia



DC82970-07:  
Oval trocar  
Trocart oval - Trocar oval



DC82963-07:  
Thoracic trocar  
Trocart pour thoroscopie - Trocar para toroscopia



Dissection Instruments

DC83208-36: \*  
Maryland dissector  
Dissecteur Maryland - Disector Maryland



E0623001: \*  
Dissecting monopolar hook  
Crochet à dissection monopolaire - Gancho para disección monopolar



DC83209-36: \*  
Maryland dissector  
Dissecteur Maryland - Disector Maryland



E0623004: \*  
Button tip HF suction tube  
Tube d'aspiration à électrode boule - Tubo de aspiración con electrodo bola



DC83200-36:  
Straight DeBakey forceps  
Pince DeBakey droite - Pinza DeBakey recta



DC83224-36:  
Double Curved Dissector  
Dissecteur Double Courbe - Disector Doble Curva



DC83201-36:  
Straight DeBakey forceps  
Pince DeBakey droite - Pinza DeBakey recta



DC83110-36: \*  
Handle for disposable scissors tips  
Manche pour embouts ciseaux - Mango para punta tijeras



DC83207-36:  
Curved DeBakey forceps  
Pince DeBakey courbe - Pinza DeBakey curva



E251105: \*  
Disposable curved scissors tips  
Embouts ciseaux à usage unique - Puntas de tijeras para uso único



Prehension Instruments

DC83213-36:  
Fenestrated forceps  
Pince fenêtrée - Pinza fenestrada



DC83216-36:  
Fenestrated forceps  
Pince fenêtrée - Pinza fenestrada



Instruments for Lymph Node Resection

DC83210-36:  
Lymph node forceps  
Pince à ganglions - Pinza para ganglios



DC82950-38:  
3 legs retractor  
Écarteur à 3 branches - Separador con 3 ramas



DC83211-36:  
Lymph node forceps  
Pince à ganglions - Pinza para ganglios



Additional Instruments

DC83003-36:  
Straight needle holder  
Porte aiguille droit - Porta-aguja recto



DC80402-37:  
Curved parenchyma clamp  
Clamp courbe à parenchyme - Pinza curva para parénquima



DC81330-33:  
Scalpel blade holder  
Manche de bistouri - Mango de bisturí



E213215: \*  
Detachable retrieval bag  
Sac d'extraction largable  
Bolsa de extracción lanzable



\* For regulatory reason, please check with your distributor for availability in your country

\* Por razones reglamentarias, por favor póngase en contacto con su distribuidor para conocer la disponibilidad en su país

NEW  
NOUVEAU  
NUEVO

OBADIA II

**DC81115-00:**

3D Atrial Retractor with articulated blade  
Ecarteur Atrial pour Lamelle Souple Additionnelle  
Retractor Atrial para Lamelle Flexible Adicional



**DC82152-99:**

C-Ring Retractor  
Anneau Ecarteur en C  
Anillo Separador en C

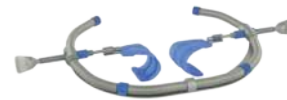

**Included:**

**DC81116-30:** Blade/Valve/Válva 35 x 30 mm

**DC81116-40:** Blade/Valve/Válva 35 x 40 mm

**DC81116-50:** Blade/Valve/Válva 35 x 50 mm



**DC82153-30:**

Soft Intercostal Blade (pair)  
Valve Souple Intercostale - Válva Intercostal Flexible



**DC81117-94:**

Flexible Additional Atrial Blade  
Lamelle Souple Additionnelle - Lamelle Flexible Adicional



**DC81310-28:**

MIS Magnetic Retriever  
Récupérateur à Aimant - Recuperador de agujas



**DC81364-36:**

Forceps for Flexible Additional Atrial Blade  
Pince pour Lamelle Souple Additionnelle - Pinzas para Lamelle Flexible Adicional



**DC81330-33:**

MIS Scalpel Blade Holder  
Manche de Bistouri MIS - Mangos de Bisturí MIS



**DC81363-24:**

Forceps for Atrial Blade  
Pince pour Valve Atrial - Pinzas para Válvula Mitral



**DC81302-30:**

MIS Hook for Nerves and Vessel  
Crochet pour Nerfs et Vaisseaux MIS - Ganchos Intracardiacos



**DC80200-36:**

MIS DeBakey Forceps  
Pince DeBakey MIS - Pinzas DeBakey MIS



**DC81303-33:**

MIS Double Hook for Nerves and Vessel  
Crochet Double pour Nerfs et Vaisseaux - Gancho Intracardiaco



**DC80202-36:**

MIS Atraumatic Resano Forceps  
Pince Atraumatique Resano MIS - Pinza Atraumatica Resano MIS



**DC81322-38:**

MIS Curved Suture Ruler  
Gabarit Courbe pour Cordages Tendineux  
Plantillas para Cuerdas Tendinosas



**DC80101-36:**

MIS Curved Scissors  
Ciseaux Courbe MIS - Tijeras Curvas MIS



**B25925:**

Double Curved Scissors  
Ciseaux Double Courbure - Tijeras Doble Curva



**DC80102-36:**

MIS Very Curved Scissors  
Ciseaux très Courbe MIS - Tijeras muy Curvas MIS



**DC80402-32:**

MIS DeBakey Intercostal Aortic Clamp  
Clamp Aortique Intercostal DeBakey MIS  
Pinzas Transtorácicas MIS DeBakey



**DC80012-36:**

MIS TC Curved Needle Holder  
Porte-Aiguille Courbe MIS Mors Tungstène - MIS TC Porta Aguja Curva



**DC71337-33:**

MIS Suction Tube  
Canule d'Aspiration Intracardiaque MIS - Cánula de Aspiración MIS



**DC80019-36:**

Very Strong MIS TC Curved Needle Holder  
Porte-Aiguille Courbe MIS très Robuste - MIS TC Porta Aguja Modelo Fuerte



**DC80420-24:**

Tube Passer  
Passe Drain - Tubo Pase



**DC81308-35:**

MIS Knot Pusher  
Pousse Noeud MIS - Empuja Nudos



**DC81410-28:**

MIS Suture Catcher  
Crochet à Suture MIS - Gancho para sutura



Minimal Access Aortic Surgery / Chirurgie Mini-Invasive de l'Aorte / Cirugía Mini Invasiva de la Aorta

YAN

NEW  
NOUVEAU  
NUEVO

**DC82160-00:**

Yan Mini-Access Retractor  
Écarteur Yan Mini-Access - Separador Mini-Access Yan



**DC33020-20:**

Narrow Aortic Retractor  
Écarteur à Main Aortique Etroit - Separador Aórtico Estrecho



**DC81330-01:**

Scalpel Blade Handle  
Manche de Bistouri MIS - Mangos de Bisturí MIS



**DC33020-30:**

Broad Aortic Retractor  
Écarteur à Main Aortique Large - Separador Aórtico Largo



**DC33010-25:**

Mammary Artery Protector  
Protecteur Artère Mammaire - Protección de la Arteria Mamaria



**DC71337-33-S: \***

MIS Straight Sucker  
Canule d'Aspiration Droite - Cánula de Aspiración Recta



**DC40087-26:**

Atraumatic Aortic Cross Clamp  
Clamp Aortique Atraumatique - Pinza Aórtica Atraumatica



**DC71337-33-C: \***

MIS Curved Sucker  
Canule d'Aspiration Courbe  
Cánula de Aspiración Curva



**DC13030-21S:**

Strong Hybrid Forceps  
Pince à Dissection Aortique Hybride - Pinzas de Disección Aórtica Híbridas



**DC50644-23S:**

Yan Heavy Style SuperGrip Needle Holder  
Porte-Aiguilles Supergrip Modèle Fort Yan  
Porta Agujas Supergrip Modelo Fuerte



**DC13030-24S:**

Strong Hybrid Forceps  
Pince à Dissection Aortique Hybride - Pinzas de Disección Aórtica Híbridas



**DC50644-25S:**

Yan Heavy Style SuperGrip Needle Holder  
Porte-Aiguilles Supergrip Modèle Fort Yan  
Porta Agujas Supergrip Modelo Fuerte



**DC80710-23:**

Straight Aortic Valve Rongeur  
Rongeur Valve Aortique - Droit - Gubias para Válvula Aórtica - Recta



**DC80012-25:**

MIS Curved Needle Holder  
Porte-Aiguilles Courbe MIS - Porta Agujas Curva MIS



**DC80711-23:**

45° Upper-cut Aortic Valve Rongeur  
Rongeur Valve Aortique - 45° - Gubias para Válvula Aórtica - 45°



**DC80013-25:**

MIS Straight Needle Holder  
Porte-Aiguilles Droit MIS - Porta Agujas Recta MIS



**DC21120-22:**

Aortic Leaflets Supercut Scissors  
Ciseaux Supercut Feuillettes Aortiques - Tijeras Supercut aórticos



**DC80419-36:**

Chest Tube Passer  
Passe-Drains - Tubo Pase



**DC80462-22:**

Single Shaft Supercut Scissors  
Ciseaux Transthoraciques Supercut - Tijeras Supercut Transtorácicas



**DC80420-24:**

Chest Tube Passer  
Passe-Drains - Tubo Pase



**DC81301-01:**

MIS Suture Hook  
Crochet MIS - Gancho MIS



**DC71710-50:**

Finger-Extension Knot Pusher  
Pousse-Nœuds à Doigt - Empuja Nudos a Dedo



**DC12550-24S:**

Supergrip Micro Forceps  
Micro Pince à Dissection Supergrip - Micro Pinzas de Disección



**DC80111-25:**

MIS Curved Scissors  
Ciseaux Courbes MIS - Tijeras Curvas MIS



**DC50203-23S:**

Fine Supergrip Micro Needle Holder  
Micro Porte-Aiguilles Supergrip Fin - Micro Supergrip Porta Agujas



**DC80112-25:**

MIS Strongly Curved Scissors  
Ciseaux Très Courbes MIS - Tijeras muy Curvas MIS



\* For regulatory reason, please check with your distributor for availability in your country

\* Por razones reglamentarias, por favor póngase en contacto con su distribuidor para conocer la disponibilidad en su país

Aortic Valve Surgery Set / Kit pour Valve Aortique / Kit para Válvula Aórtica

AORTIC VALVE SURGERY

**DC80700-30:**  
Aortic Valve Rongeur  
Rongeur Aortique - Gubia Aórtica



**DC80202-30:**  
Atraumatic Resano Forceps  
Pince Atraumatique Resano - Pinza Atraumática Resano



**DC81302-30:**  
Hook for Nerves and Vessels  
Crochet pour Nerfs et Vaisseaux - Gancho para Nervios y Vasos



**DC80207-30:**  
Curved DeBakey Forceps  
Pince Courbe DeBakey - Pinza Curva DeBakey



**DC81308-28:**  
Knot Pusher  
Pousse Noeud - Empuja Nudos



**DC80101-30:**  
Curved Scissors  
Ciseaux Courbes - Tijeras Curvas



**DC81310-28:**  
Needles Retriever  
Récupérateur à Aiguilles - Colector de Agujas



**DC80102-30:**  
Very Curved Scissors  
Ciseaux Très Courbes - Tijeras MuyCurvas



**DC81330-33:**  
Scalpel Blade Holder  
Manche de Bistouri - Mango de Bisturí



**DC80012-30:**  
Curved TC needle holder  
Porte Aiguille Courbe TC - Porta Agujas Curvo TC



**DC81331-33:**  
Beaver Blade Holder  
Manche de Bistouri pour Lames Beaver - Mango de Bisturí para Hojas Beaver



**DC80013-30:**  
Straight TC Needle Holder  
Porte Aiguille Droit TC - Porta Agujas Recto TC



**DC81400-00:**  
Suture ring  
Anneau à Sutures - Anillo para Suturas



**DC82100-02:**  
Intercostal ThorAccess retractor  
Écarteur Intercostal ThorAccess - Separador Intercostal ThorAccess





MIDCAB Set / Kit MIDCAB / Kit MIDCAB

MIDCAB

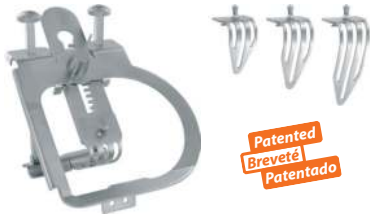

**DC82200-00:**  
MIDAccess IMA retractor  
Écarteur IMA MIDAccess - Separador IMA MIDAccess



**DC82210-00:**  
Small Thoracotomy retractor  
Écarteur Mini-Thoracotomie - Separador Mini-Toracotomía

**DC80015-28:**  
Diamonite Needle Holder  
Porte Aiguilles Diamonite - Porta Agujas de Diamonite



**DC81305-30:**  
Dr. Yilmaz Surgery Hook  
Crochet du Dr. Yilmaz - Gancho de Dr. Yilmaz



**DC80116-28:**  
45° Angled Scissors  
Ciseaux Angulés 45° - Tijeras Anguladas 45°



**DC81323-30:**  
Knot Pushers  
Pousse-Noeuds - Empuja-Nudos



**DC80117-28:**  
125° Angled Scissors  
Ciseaux Angulés 125° - Tijeras Anguladas 125°



**DC80203-28:**  
Dissecting Forceps  
Pincès à Dissection - Pinzas para Disección



## Pulmonary Resections Tray (Gossot)

### Panier Résections Pulmonaires (Gossot) / Cesta Resecciones Pulmonares (Gossot)



**DC81903-00** \*

540 x 250 x 70 mm

Provided with lid, instruments not included

Livré avec couvercle, instruments non inclus

Entregado con tapa, instrumentos no incluidos

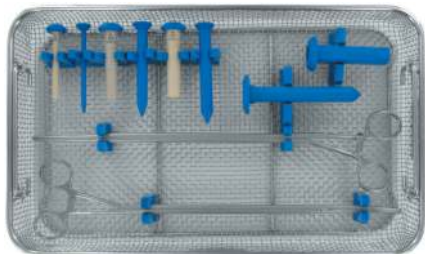

**DC81904-00** \*

405 x 250 x 70 mm

Provided with lid, instruments not included

Livré avec couvercle, instruments non inclus

Entregado con tapa, instrumentos no incluidos

## Mitral Valve Tray (Obadia)

### Panier Valve Mitrale (Obadia) / Cesta Válvula Mitral (Obadia)



**DC81910-01** \*

NEW  
NOUVEAU  
NUEVO

540 x 250 x 70 mm

Provided with lid, instruments not included

Livré avec couvercle, instruments non inclus

Entregado con tapa, instrumentos no incluidos



**DC81910-02** \*

NEW  
NOUVEAU  
NUEVO

540 x 250 x 70 mm

Provided with lid, instruments not included

Livré avec couvercle, instruments non inclus

Entregado con tapa, instrumentos no incluidos

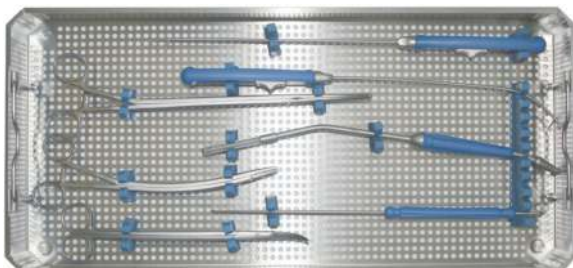

**DC81910-03** \*

NEW  
NOUVEAU  
NUEVO

540 x 250 x 70 mm

Provided with lid, instruments not included

Livré avec couvercle, instruments non inclus

Entregado con tapa, instrumentos no incluidos

## Aortic Surgery Tray (Yan) Panier Chirurgie Aortique (Yan) / Cesta Cirugia Aórtica (Yan)

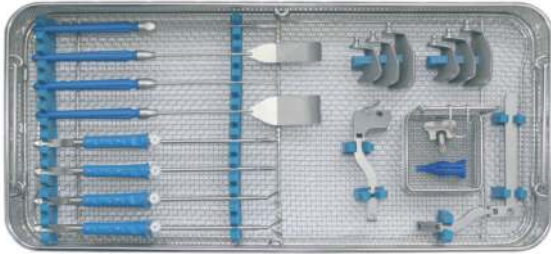

**DC81912-01** \*

NEW  
NOUVEAU  
NUEVO

540 x 250 x 70 mm

Provided with lid, instruments not included

Livré avec couvercle, instruments non inclus

Entregado con tapa, instrumentos no incluidos

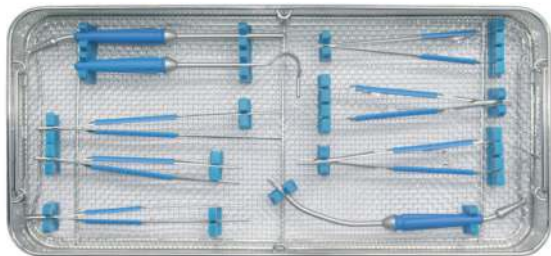

**DC81912-02** \*

NEW  
NOUVEAU  
NUEVO

540 x 250 x 70 mm

Provided with lid, instruments not included

Livré avec couvercle, instruments non inclus

Entregado con tapa, instrumentos no incluidos

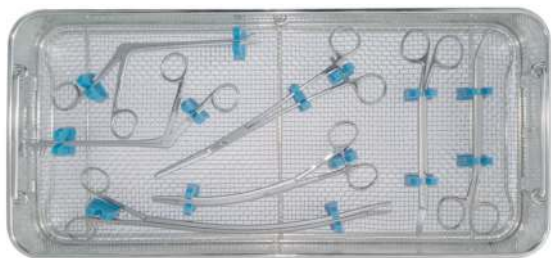

**DC81912-03** \*

NEW  
NOUVEAU  
NUEVO

540 x 250 x 70 mm

Provided with lid, instruments not included

Livré avec couvercle, instruments non inclus

Entregado con tapa, instrumentos no incluidos

## Aortic Valve Tray Panier Valve Aortique / Cesta Válvula Aórtica

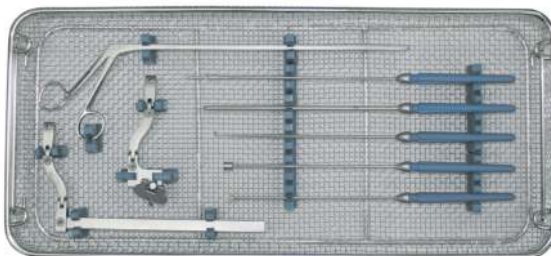

**DC81900-03** \*

540 x 250 x 70 mm

Provided with lid, instruments not included

Livré avec couvercle, instruments non inclus

Entregado con tapa, instrumentos no incluidos

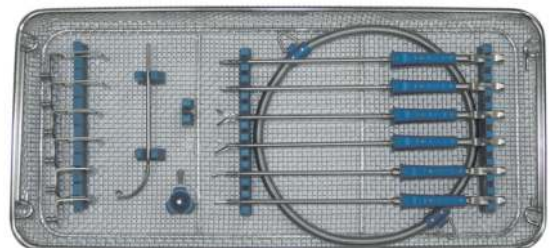

**DC81900-04** \*

540 x 250 x 70 mm

Provided with lid, instruments not included

Livré avec couvercle, instruments non inclus

Entregado con tapa, instrumentos no incluidos

\* For regulatory reason, please check with your distributor for availability in your country

\* Por razones reglamentarias, por favor póngase en contacto con su distribuidor para conocer la disponibilidad en su país

## MIDCAB Tray Panier MIDCAB / Cesta MIDCAB

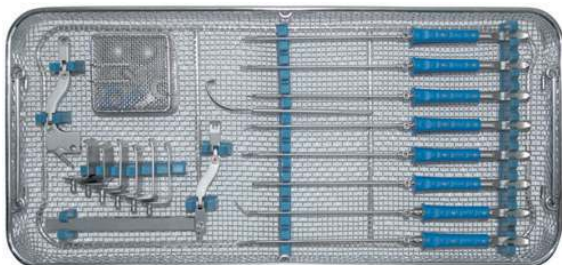

**DC81906-00** \*

540 x 250 x 70 mm

Provided with lid, instruments not included

Livré avec couvercle, instruments non inclus

Entregado con tapa, instrumentos no incluidos

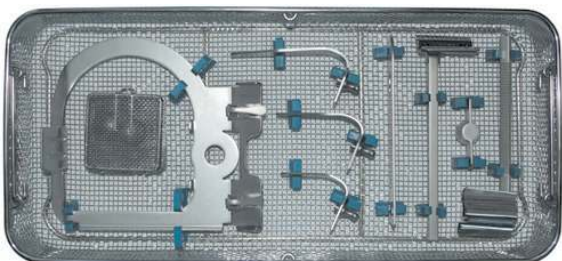

**DC81907-00** \*

540 x 250 x 70 mm

Provided with lid, instruments not included

Livré avec couvercle, instruments non inclus

Entregado con tapa, instrumentos no incluidos

## Sternal ThorAccess Retractor Tray Panier Écarteur Sternal ThorAccess / Cesta Separador Esternal ThorAccess



**DC81908-00** \*

250 x 250 x 50 mm

Provided with lid, instruments not included

Livré avec couvercle, instruments non inclus

Entregado con tapa, instrumentos no incluidos

## MIS Instruments Tray Panier Instruments MIS / Cesta Instrumentos MIS

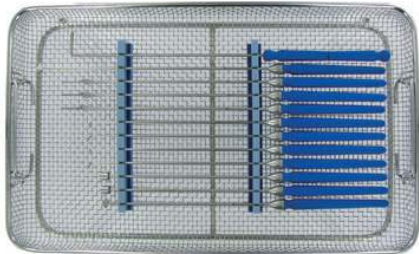

**DC81901-00** \*

405 x 250 x 50 mm

Provided without lid, instruments not included

Livré sans couvercle, instruments non inclus

Entregado sin tapa, instrumentos no incluidos

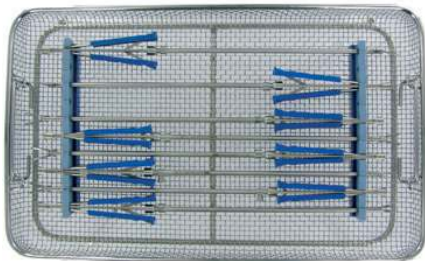

**DC81902-00** \*

405 x 250 x 50 mm

Provided without lid, instruments not included

Livré sans couvercle, instruments non inclus

Entregado sin tapa, instrumentos no incluidos



#### Important notice

The content of this catalogue (including the trademarks, the texts, the drawings, illustrations, layouts, etc.) is, unless otherwise specified, the exclusive property of LANDANGER. It is not allowed to reproduce, represent, display, modify, adapt an/or translate - whether in part or in whole and whether for free or for financial consideration - the catalogue and/or any material composing the catalogue, without the prior and written consent of LANDANGER.

We can at any time recall the catalogue, in case that it has been not used according to our interests, i.e. sale or purchase of our products. We preserve the right for further steps in that case.

Patterns are subject to change.

#### Indications importantes

Le contenu de ce catalogue de vente (y compris les marques, les textes, les dessins, illustrations, présentations, etc.) est, sauf mention contraire, la propriété exclusive de la société LANDANGER. Toute reproduction, représentation, modification, adaptation, et/ou traduction de ce catalogue - qu'elle soit totale ou partielle, à titre gratuit ou onéreux - est interdite sans l'accord préalable écrit de la société LANDANGER.

Nous pouvons demander le retour du catalogue dans le cas où celui-ci n'est pas utilisé conformément à nos intérêts, pour la vente ou l'achat de nos produits. Dans ce cas nous nous réservons le droit de mener des actions juridiques.

Sous réserve des modifications techniques.

#### Indicaciones importantes

El contenido de este catálogo (marcas, textos, dibujos, ilustraciones, presentaciones incluidos, etc.) es, excepto mención contraria, exclusiva propiedad de la empresa LANDANGER. Toda reproducción, representación, modificación, adaptación, y/o traducción de este catálogo - que sea total o parcial, gratuitamente o pagando - esta prohibida sin el acuerdo escrito de la empresa LANDANGER.

Podemos pedir el retorno del catálogo en caso de que este no sea usado conforme a nuestro interés, para la venta o la compra de nuestros productos. En aquel caso, nos reservamos el derecho de dirigir acciones jurídicas.

Bajo reserva de modificaciones técnicas.

#### Catalogue de vente - ZA-B00005

Concept and design - Conception et design - Concepto y diseño : Copyright©LANDANGER - 2009 - 2018.

All rights reserved - Tous droits réservés - Todos los derechos reservados.

The photos and pictures are not contractual - Photos et illustrations non contractuelles - Fotos e ilustraciones no contractuales.

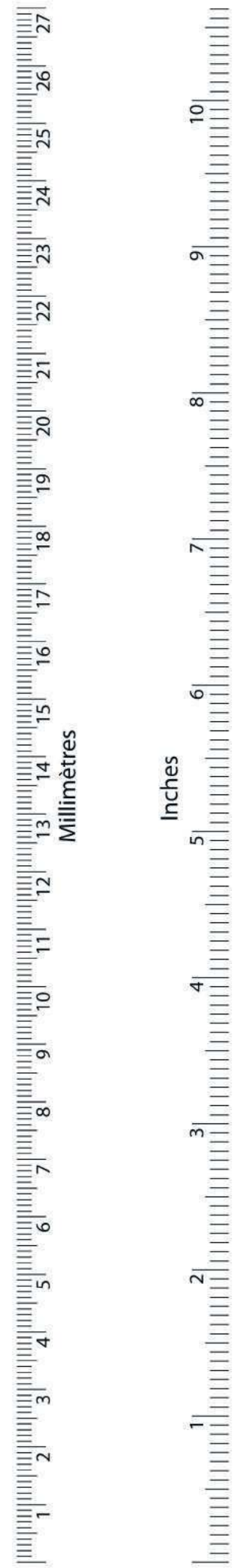



  
**Delacroix-Chevalier**  
*Paris*

Manufacturing and logistic - *Production et logistique - Fabricacion y logistica*

**Rue Renée et Louis Landanger**  
52000 Chaumont - France  
Phone : +33 (0) 3 25 02 10 35 - Fax : +33 (0) 3 25 02 10 20 - Email : [export@delacroix-chevalier.com](mailto:export@delacroix-chevalier.com)  
[www.delacroix-chevalier.com](http://www.delacroix-chevalier.com)  
ZA-B00005