

# GXR-SD/CSD/USD

## PREMIUM Series

### Digital Radiography System

# Operation Manual

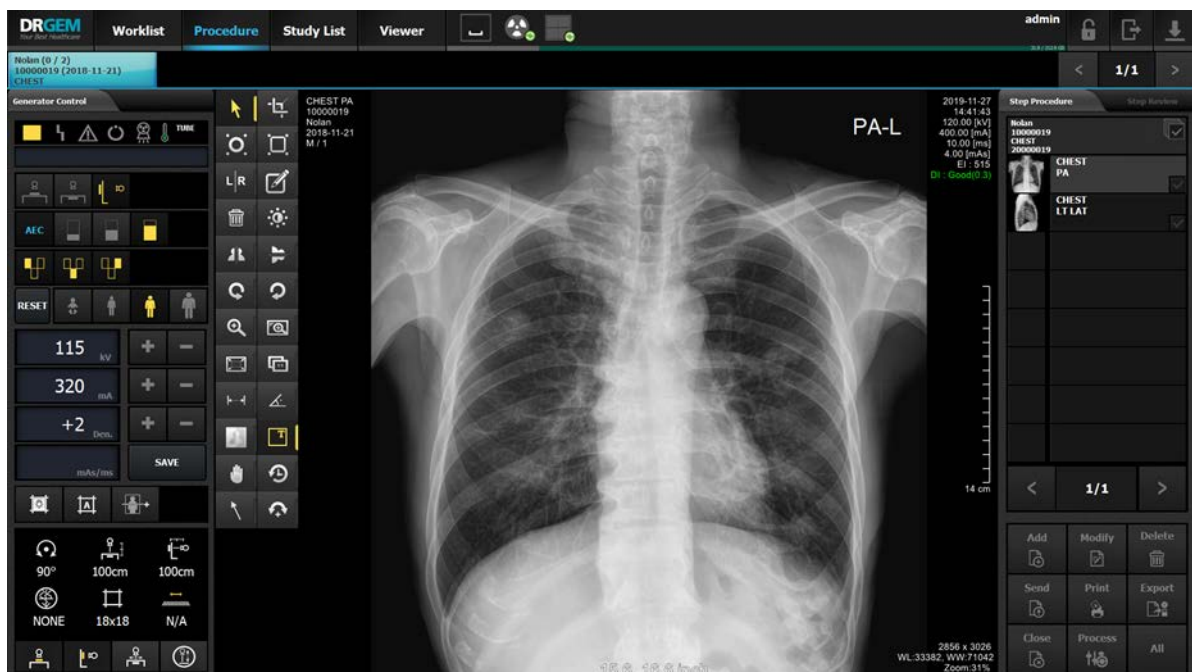

**DRGEM Corporation**

7FI, E-B/D Gwangmyeong Techno-Park, 60 Haan-ro,  
Gwangmyeong-si, Gyeonggi-do, 14322, Korea  
TEL: +82-2-869-8566, FAX: +82-2-869-8567

D/N: RMD1402-002, Rev.12



(This page intentionally left blank)

## REVISION HISTORY

Revision Number	Date	Description
0	DEC 12, 2014	First Edition
1	DEC 17, 2016	Add Ceiling auto stitching function
2	JUN 20, 2017	Transition of NB (DNV-GL NB# 0434 -> DNV GL NE MKO PRESAFE AS NB#2460),
3	AUG 21, 2017	Add the collimator (DXC-RM) Add the Motorized Type Equipment (TS_FC2, TS_FC4, TS_FC6, WBS-TM, WBS) Add the auto stitching function(TS_FM6, TS,FC6)
4	APR 09, 2018	Add new Graphic User Interface
5	NOV 10, 2018	Change Standard(EMC 4 , Safety 3.1) Add Mano Detector(Mano4343X, Mano434T) Change name of manufacture for Tube. (TOSHIBA -> CANON, VARIAN -> VAREX)
6	MAR 15, 2019	Add the TS_CSP. Add the 1100mm longitudinal Option for PBT-6
7	JUL 19, 2019	Add the Ceiling Rail of Option for TS_FM6 Change of Bucky size for Wall bucky Stand. Add Mano Detector(Mano4343W, Mano4336W) Add Varex Detector(4343RC)
8	DEC 11, 2019	Add Built-in Memory function.
9	APR 16, 2020	Addition of XRPad2, PaxScan4343W, VIVIX-S series Detectors Separate RADMAX SOFTWARE content. Refer to the RADMAX manual(RMD1804-001)
10	APR 27, 2020	Added Worklist Function. Added Mechanical detent (option)
11	MAY 04, 2020	Apply the tube arm detent for TS_FM6, TS_FC6
12	JUL 24, 2020	Change of column rotation assembly for TS_FM6 Change of Table top assembly for Table Add 9 preset function Add cobb's angle function Add tube & line enhancement function

		Add detector built-in charger function Add APR positioning guide function
--	--	--

## ADVISORY SYMBOLS

The following advisory symbols are used throughout this manual.

Their application and meaning are described below.

**WARNING**

Warning symbol is used to indicate a potential hazard for operators and service personnel that can lead to serious injury, death or radiation exposure.

**CAUTION**

Caution symbol is used to indicate a potential hazard for operators and service personnel that can lead to injury or damage of equipment.

**NOTE**

Note symbol is used to indicate important information needed for proper use and correct operation of equipment.

**NOTE**

**Keep this Software Manual with the equipment at all times, and review the important information whenever required.**

Copyright **DRGEM Corporation**. All rights reserved.

This document is the property of **DRGEM Corporation** and contains confidential and proprietary information owned by **DRGEM Corporation**. Any unauthorized copying, use or disclosure of it without the prior written permission of **DRGEM Corporation** is strictly prohibited.

**NOTE**

**Consult Accompanying Documents - As Applicable**

**INDICATIONS for USE STATEMENT:**

The GXR-SD/CSD/USD Series Diagnostic X-Ray System, is a stationary X-ray imaging system, for the purpose of acquiring X-ray images of the desired parts of a patient's anatomy. This device is not intended for mammography or bone density applications.

This device contains expansions of capability and modifications that are applicable to and permitted by FDA guideline "Enforcement Policy for Imaging Systems During the Coronavirus Disease 2019 (COVID-19) Public Health Emergency". Accordingly, user of this device must abide by following

**CAUTION**

**U.S. A. Federal law restricts this device to sale by or on the order of a physician.**

**CAUTION**

**Information provided by the product are adjunctive (supporting) and should not be solely or primarily relied upon to diagnose or treat COVID-19**

**CAUTION**

**This device is not indicated for the diagnosis of COVID-19 and that in vitro diagnostic testing is currently the only definitive method to diagnose COVID-19.**

## TABLE OF CONTENTS

<b>1. INTRODUCTION</b> .....	<b>9</b>
<b>1.1 INTENDED USE &amp; FEATURES</b> .....	9
<b>1.2 SAFETY INFORMATION</b> .....	10
1.2.1 STATEMENT OF LIABILITY.....	10
1.2.2 SYMBOL DEFINITIONS.....	11
1.2.3 SAFETY GUIDELINES.....	13
1.2.4 X-RAY PROTECTION .....	17
1.2.5 PEDIATRIC USE: SUMMARY .....	20
1.2.6 RADIATION SAFETY.....	21
1.2.7 MANUFACTURER’S RESPONSIBILITY.....	24
1.2.8 MONITORING PERSONNEL .....	25
1.2.9 RADIATION PROTECTION SURVEY .....	26
<b>1.3 APPLICATION SPECIFICATION</b> .....	27
1.3.1 INTENDED MEDICAL INDICATION.....	27
1.3.2 INTENDED PATIENT POPULATION .....	27
1.3.3 INTENDED USER PROFILE.....	28
<b>1.4 SPECIFICATIONS</b> .....	29
<b>1.5 CUSTOMER SUPPORT</b> .....	57
<b>2. OPERATION PROCEDURE</b> .....	<b>59</b>
<b>2.1 TURN ON THE SYSTEM</b> .....	59
<b>2.2 EXAMINATION</b> .....	60
<b>2.3 TURN OFF THE SYTSTEM</b> .....	60
<b>3. RADMAX SOFTWARE</b> .....	<b>61</b>
<b>4. X-RAY CONTROL</b> .....	<b>63</b>
<b>4.1 SAFETY NOTICE</b> .....	64
<b>4.2 GENERATOR DUTY CYCLE LIMIT</b> .....	65
<b>4.3 DAILY X-RAY TUBE WARM-UP PROCEDURE</b> .....	66
<b>4.4 GENERATOR INTERFACE MODULE</b> .....	67
<b>4.5 CONSOLE CONTROLS</b> .....	68
4.5.1 POWER ON/OFF CONTROLS.....	68
4.5.2 INDICATOR .....	68
4.5.3 PROCEDURE DISPLAY .....	68
4.5.4 PREP, X-RAY EXPOSURE CONTROL.....	69
4.5.5 RADIOGRAPHY CONTROLS.....	69

*4.5.6 STATE MESSAGE DISPLAY ..... 73*

*4.5.7 COLLIMATOR CONTROL ..... 74*

*4.5.8 SYSTEM STATUS INDICATOR..... 75*

**5. APPARATUS OPERATION.....77**

*5.1 TUBE STAND (TS-FM6, TS\_FC6, TS\_FC4 - VERTICAL MOTORIZED MOVEMENT) .....77*

*5.2 TUBE STAND (TS-FC2-VERTICAL MOTORIZED MOVEMENT) .....87*

*5.3 TUBE STAND (TS-CSA) .....88*

*5.4 TUBE STAND (TS-CSP) .....95*

*5.5 VERTICAL WALL STAND (WBS, WBS-TA, WBS-TM).....101*

*5.6 PATIENT TABLES .....106*

*5.7 COLLIMATOR.....108*

**APPENDIX A. EXPOSURE TABLE .....111**

**APPENDIX B. EXPOSURE INDEX .....115**



## 1. INTRODUCTION

This manual contains the necessary instructions for proper operation of GXR-SD/CSD/USD PREMIUM System. All persons operating this equipment need to have read this manual beforehand. You must have a thorough understanding in the proper use of this product before you make any radiographic exposures.

### 1.1 INTENDED USE & FEATURES

This diagnostic x-ray system is designed to diagnose human body by providing radiographic x-ray image with anatomical structure

This GXR-SD/CSD/USD PREMIUM System “is for use by medical professionals”

To prevent excess radiation exposure to patient and operator from either primary or secondary radiation, this GXR-SD/CSD/USD PREMIUM System must be operated and serviced by trained personnel who are familiar with the safety precautions required.

GXR-SD/CSD/USD PREMIUM System provides state-of-the-art image quality; image processing and user interface; making the system easy to use and reliable while providing high quality digital radiographic images with reduced dose.

GXR-SD/CSD/USD PREMIUM System incorporates the digital flat panel detector technology.

Direct radiography via flat panel detector improves your workflow, exam speed and comfort with efficiency. Digital flat panel detector provides excellent spatial resolution, MTF, DQE and stability based on fine pixel pitch.

Selection of an anatomical study on the imaging software automatically sets up the x-ray generator’s pre-programmed exposure technique setting and post image processing for selected study. Also, high resolution grid supplies excellent image quality.

A high performance imaging workstation and RADMAX software serves you a convenient interface and easy operation. Anatomical view-based digital image processing automatically optimizes and enhances the quality of the captured images. Automatic image storage and print with DICOM 3.0 networking capability increases exam throughput and decreases examination time. Remote diagnosis function enables fast and accurate diagnosis on problems and saves service cost and system downtime.

## **1.2 SAFETY INFORMATION**

The policy of DRGEM Corporation is to manufacture X-ray equipment that meets high standards of performance and reliability. We enforce strict quality control techniques to eliminate the potential for defects and hazards in our products. The intended use of this equipment is to provide an X-ray source for the purpose of acquiring X-ray images of the desired parts of a patient's anatomy. Use of this equipment in any other fashion may lead to serious personal injury. The safety guidelines provided in this section of the manual are intended to educate the operator on all safety issues in order to operate and maintain GXR-SD/CSD/USD PREMIUM System in a safe manner.

### **1.2.1 STATEMENT OF LIABILITY**

To prevent excess radiation exposure to patient and operator from either primary or secondary radiation, this GXR-SD/CSD/USD PREMIUM System must be operated and serviced by trained personnel who are familiar with the safety precautions required. While this GXR-SD/CSD/USD PREMIUM System has been designed for safe operation, improper operation or carelessness may result in serious injury or damage to equipment. The manufacturer or its agents and representatives assume no responsibility for the following:

1. Injury or danger to any person from x-ray exposure.
2. Overexposure due to poor technique selection.
3. Injury or danger from improper use of the function.
4. Problems or hazards resulting from failure to maintain the equipment as specified in the Installation chapter.
5. Equipment which has been tampered with or modified. DRGEM Corporation is not liable for any damage or injury arising from failure to follow the instructions and procedures provided within the manuals or associated informational material, or from user failure to use caution when installing, operating, adjusting, or servicing this equipment. DRGEM Corporation is not liable for damage or injury arising from the use of this product for any other use than that intended by the manufacturer.

### 1.2.2 SYMBOL DEFINITIONS

The table below defines the meaning of various symbols used on labels on the machine.



Radiation exposure symbol used on operator console. Lights to indicate that an exposure is in progress. This is accompanied by an audible tone from the console.



**WARNING :** This X-ray unit may be dangerous to patient and operator unless safe exposure factors, operating instructions and maintenance schedules are observed



Radiation warning message on console.

Never allow unqualified personnel to operate the X-ray generator.



Sitting at the end of tabletop is prohibited.



Consult accompanying documents (Required to consult for Safety)



Emergency Stop



Caution for trapping zone of hand



This symbol means that the product and battery should be recycled separately from household waste. When this product reaches its end of life, follow the local laws and regulations of disposal. The improper disposal of waste electronic equipment from the consumer may be subject to fines.

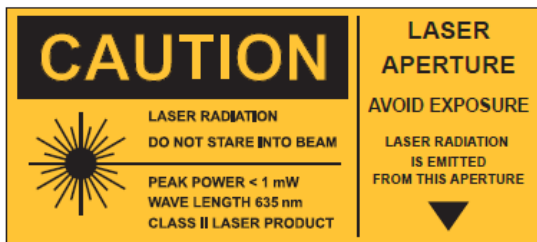

Caution of laser radiation.  
Staring into beam is never allowed.



High voltage symbol used to indicate the presence of high voltage.



Warning symbol used to indicate a potential hazard to operators, service personnel or to the equipment. It indicates a requirement to refer to the accompanying documentation for details.



Protection earth symbol

**L**

Live line among the single phase line powers.

**N**

Neutral line among the single phase line powers.

**L1**

First phase line power among the three phase line powers.

**L2**

Second phase line power among the three phase line powers.

**L3**

Third phase line power among the three phase line powers.

**V~**

Single phase AC voltage

**V3~**

Three phase AC voltage

**V=**

DC voltage

### 1.2.3 SAFETY GUIDELINES

The following are general safety precautions:

- Only qualified personnel may use this software.
- Do not defeat or bypass built-in equipment safety features.
- Observe all warnings and cautions, stated or implied, in the procedures.
- To protect the system and data from Virus, Spam, spoofing, Phishing, Pharming, Spyware, Keylogging, Adware, Botnets, Worms, Trojan, Denial-Of-Service such as online attack and etc., it is important to install the proper Anti-Virus software in the workstation.
- Pediatric patients are more radiosensitive than adults (i.e., the cancer risk per unit dose of ionizing radiation is higher);
- Use of equipment and exposure settings designed for adults may result in excessive radiation exposure if used on smaller patients;
- Pediatric patients have a longer expected lifetime, putting them at higher risk of cancer from the effects of radiation exposure.
- To protect the system and data from Virus, Spam, spoofing, Phishing, Pharming, Spyware, Keylogging, Adware, Botnets, Worms, Trojan, Denial-Of-Service such as online attack and etc., it is important to install the proper Anti-Virus software in the workstation.

The following warnings and cautions are specific to GXR-SD/CSD/USD PREMIUM System.

Read them carefully - some of them are not obvious to typical use.

X-ray radiation exposure may be damaging to health, with some effects being cumulative and extending over periods of many months or even years. **X-ray operators should avoid any exposure to the primary beam** and take protective measures to safeguard against scatter radiation. Scatter radiation is caused by any object in the path of the primary beam and may be of equal or less intensity than the primary beam that exposes the film.

No practical design can incorporate complete protection for operators or service personnel who do not take adequate safety precautions. **Only authorized and properly trained service and operating personnel should be allowed to work with this X-ray generator equipment.** The appropriate personnel must be made aware of the inherent dangers associated with the servicing of high voltage equipment and the danger of excessive exposure to X-ray radiation during system operation.

- Wear protective clothing. Protective aprons with an equivalent of a minimum of 1/64" (0.35 mm) of lead are recommended.
- To protect the patient against radiation, always use radiation protection accessories in addition to devices which are fitted to the X-ray equipment.
- Keep as large a distance as possible away from the object being exposed and the X-ray tube assembly.

- Never operate this X-ray equipment in areas where there is a risk of explosion. Detergents and disinfectants, including those used on patients, may create explosive mixtures of gases. Please observe the relevant regulations.
- The operator console, or anything electrically connected to it, must never be used within 6 ft (1.8 m) of the patient environment.
- Do not place liquids (coffee, beverages, flowers, etc) on the control console or generator main cabinet.
- Always ensure adequate ventilation around the control console and generator main cabinet. Do not operate the equipment near curtains, drapes, etc which may block the ventilation slots.
- Do not operate the console or generator main cabinet in direct sunlight or near any heat sources.
- Do not operate the console near strong magnetic fields (microwave ovens, speakers, etc), and avoid routing the console cables near these devices.
- The console and generator main cabinet must be operated in locations that are clean (free of excess dust, dirt, debris, etc), stable (free of vibration), and secure such that the console cannot slip or tip.
- Only trained maintenance staff may remove the covers of the generator cabinet and the control console.

**CAUTION**

**INCORRECT CONNECTIONS OR USE OF UNAPPROVED EQUIPMENT MAY RESULT IN INJURY OR EQUIPMENT DAMAGE.**

**WARNING**

**THIS X-RAY UNIT MAY BE DANGEROUS TO PATIENT AND OPERATOR UNLESS SAFE EXPOSURE FACTORS AND OPERATING INSTRUCTIONS ARE OBSERVED.**

**PROPER USE AND SAFE OPERATING PRACTICES WITH RESPECT TO X-RAY GENERATORS ARE THE RESPONSIBILITY OF THE USERS OF SUCH GENERATORS.**

**MANUFACTURER PROVIDES INFORMATION ON ITS PRODUCTS AND ASSOCIATED HAZARDS, BUT ASSUMES NO RESPONSIBILITIES FOR AFTER-SALE OPERATING AND SAFETY PRACTICES.**

**WARNING**

**MANUFACTURER ACCEPTS NO RESPONSIBILITY FOR ANY GENERATOR NOT MAINTAINED OR SERVICED ACCORDING TO THE SERVICE MANUAL OR ANY GENERATOR THAT HAS BEEN MODIFIED IN ANY WAY.**

**MANUFACTURER ALSO ASSUMES NO RESPONSIBILITY FOR X-RAY RADIATION OVEREXPOSURE OF PATIENTS OR PERSONNEL RESULTING FROM POOR OPERATING TECHNIQUES OR PROCEDURES.**

**CAUTION**

**DO NOT EXCEED THE TUBE MAXIMUM OPERATING LIMITS. INTENDED LIFE AND RELIABILITY WILL NOT BE OBTAINED UNLESS GENERATORS ARE OPERATED WITHIN PUBLISHED SPECIFICATIONS.**

**WARNING**

Do not remove flexible high tension cables from X-ray tube housing or X-ray generator and/or access covers from X-ray generator until the main and auxiliary power supplies have been disconnected and allowed to discharge for at least 3 minutes. You can be fatally shocked if you do not.

Voltage as high as 100,000 volts may be present in the GXR-SD/CSD/USD PREMIUM system circuitry for a few minutes after it has been turned off.

**WARNING**

All of the movable assemblies and parts of this equipment should be operated with care and routinely inspected in accordance with the manufacturer's recommendations contained in this manual. Only properly trained and qualified personnel should be permitted access to any internal parts. Live electrical terminals are deadly; be sure line disconnect switches are opened and other appropriate precautions are taken before opening access doors, removing enclosure panels, or attaching accessories. For all components of the equipment, protective earthing means must be provided in compliance with the national regulations.

**WARNING**

X-rays generate a potential risk for both patients and operators. For this reason, the application of X-rays for a given medical purpose must aim at the minimization of radiation exposition to any persons. Those persons responsible for the application must have the specific knowledge according to legal requirements and regulations and must establish safe exposure procedures for this kind of systems. Those persons responsible for the planning and installation of this equipment must observe the national regulations.

**WARNING**

Operators must meet all state and local requirements and regulations.

**WARNING**

Only qualified personnel may operate GXR-SD/CSD/USD PREMIUM System. Operation of the equipment by persons who have not been trained or who are unfamiliar with GXR-SD/CSD/USD PREMIUM System may cause serious injury to the patient, serious injury to the operator, or equipment damage.

**WARNING**

Before operating GXR-SD/CSD/USD PREMIUM System, operators must familiarize themselves with the location of the room's main power switch or the generator's main switch in order to enable immediate shutdown of the x-ray tube in the event of unintended motion or other catastrophic equipment failure.

**WARNING**

The GXR-SD/CSD/USD PREMIUM system includes no user serviceable parts. For service assistance, contact DRGEM Corporation or service provider.

**WARNING**

The GXR-SD/CSD/USD PREMIUM system produces ionizing radiation. Operators must meet all state and local requirements and regulations.

**WARNING**

The GXR-SD/CSD/USD PREMIUM system and associated cables must not be operated in the presence of moisture.

**WARNING**

Ensure that the earth grounding connections between the GXR-SD/CSD/USD PREMIUM system and its power source are maintained at all times.

**WARNING**

The GXR-SD/CSD/USD PREMIUM system is not suitable for operation in the presence of a flammable anesthetic mixture with air, oxygen, or nitrous oxide.

**WARNING**

Disconnect electrical power from the GXR-SD/CSD/USD PREMIUM system before servicing. Use care not to drop tools or other objects into the GXR-SD/CSD/USD PREMIUM system when working on or around the unit. Electrical shock could result.

**Table top moves for correct position of patient by operator's continuous operation.**

**WARNING**

**When it moves for examination it accompany hole under side that can cause serious damage to your hand.**

**Be careful not to insert your hand in this hole.**

**WARNING**

Use of this equipment adjacent to or stacked with other equipment should be avoided because it could result in improper operation. If such use is necessary, this equipment and the other equipment should be observed to verify that they are operating normally.



## CONTRINDICATION

There are no medical conditions that would make having an X-Ray unsuitable. However, for women who are or might be pregnant, it is advised that certain X-Rays are not undertaken other than in emergency situations.

This System is not intended to use of mammography and bone density

This System is not suitable for operation in the presence of a flammable anesthetic mixture with air, oxygen, or nitrous oxide.

### 1.2.4 X-RAY PROTECTION

X-ray equipment may cause injury if used improperly. The instructions contained in this manual must be read and followed when operating the GXR-SD/CSD/USD PREMIUM System. No practical design can provide complete protection nor prevent operators from exposing themselves or others to unnecessary radiation. Personal radiation monitoring and protective devices are available. You are urged to use them to protect against unnecessary radiation exposure.

Serious unfavorable health effects can result from short term exposure to high levels of ionizing radiation (such as X-rays) as well as from long term exposure to low levels. Personnel who operate the GXR-SD/CSD/USD PREMIUM System should familiarize themselves with both the short term and the long term effects of radiation exposure and take appropriate measures to minimize the amount of radiation to which they are exposed while performing their duties. Some effects of X-radiation are cumulative, and may extend over a period of months or years. The best safety rule for X-ray operators is to avoid exposure to the primary beam at all times.

Ionizing radiation occurs naturally in the environment. It is generated by astronomical radiation sources such as the sun and the stars, and by the soil under our feet. The atmosphere filters radiation from astronomical sources. As a result, the radiation level from these sources is much lower at sea level than on the summit of high mountains. Radiation generated in the soil varies greatly from place to place depending on the composition of the soil. For example, areas rich in granite rock have a higher level of radiation than other areas.

Any materials placed in the path of the beam absorb natural as well as man-made radiation, such as the X-rays used in the GXR-SD/CSD/USD PREMIUM System.

Materials with a high atomic number, such as tungsten, lead, and uranium, absorb X-rays much more effectively than materials with a low atomic number such as hydrogen, aluminum, or beryllium. Therefore, lead is used for shielding the radiologist's workstation in most X-ray facilities, including ones using the GXR-SD/CSD/USD PREMIUM System.

If there are windows in the partition separating the operator from the patient, these windows are typically glazed with lead glass and provide effective protection against ionizing radiation.

To minimize dangerous exposure, use movable lead screens, lead-impregnated gloves, and lead-impregnated aprons. These protective devices must contain 0.35 millimeter thickness of lead or the equivalent.

Use such protective devices for all operators, observers, and/or servicing personnel exposed to radiation fields of five or more milli-Roentgens per hour.

The shielding provided for a typical X-ray facility's operator workstation is generally quite effective and reduces the residual radiation from diagnostic X-rays to a level that is comparable to or lower than natural background radiation. If the operator abandons the protected environment of the workstation, he or she may be exposed to a significantly higher level of radiation. For a single exposure this may still not lead to serious health effects, but repeated carelessness in this regard may lead to serious consequences.

Any object in the path of the primary beam produces scattered radiation. In the absence of proper precautions, scattered radiation can result in a substantial radiation dose to the operator or any other personnel in the facility. Moveable screens may be used to shield occupied areas from scattered radiation.

The X-ray Generator/host system used to power the GXR-SD/CSD/USD PREMIUM System only produces X-rays when high voltage is applied to the X-ray tube. When the high voltage is removed, X-ray emission ceases without delay.

**WARNING**

**THIS UNIT MAY BE DANGEROUS TO OPERATOR UNLESS SAFE OPERATING INSTRUCTIONS ARE OBSERVED.**

**WARNING**

**PROPER USE AND SAFE OPERATING PRACTICES WITH RESPECT TO GXR-SD/CSD/USD PREMIUM SYSTEM ARE THE RESPONSIBILITY OF USERS. DRGEM CORPORATION PROVIDES INFORMATION ON ITS PRODUCTS AND ASSOCIATED HAZARDS, BUT ASSUMES NO RESPONSIBILITIES FOR AFTER-SALE OPERATING AND SAFETY PRACTICES.**

**WARNING**

**THE MANUFACTURER ACCEPTS NO RESPONSIBILITY FOR ANY GXR-SD/CSD/USD PREMIUM SYSTEM NOT MAINTAINED OR SERVICED ACCORDING TO THIS MANUAL, OR FOR ANY GXR-SD/CSD/USD PREMIUM SYSTEM THAT HAS BEEN MODIFIED IN ANY WAY.**

\* **Inverse square law**

A bundle of X-rays corresponds to the shape of a cone, with the tube at its tip. The intensity or dose of the radiation emitted from the source of the X-ray beam diminishes with the square of its distance from the source. If you double the distance  $x$ , the dose changes by a factor of  $1/(2^2)$ , and if you triple it, the dose changes by a factor of  $1/(3^2)$ .

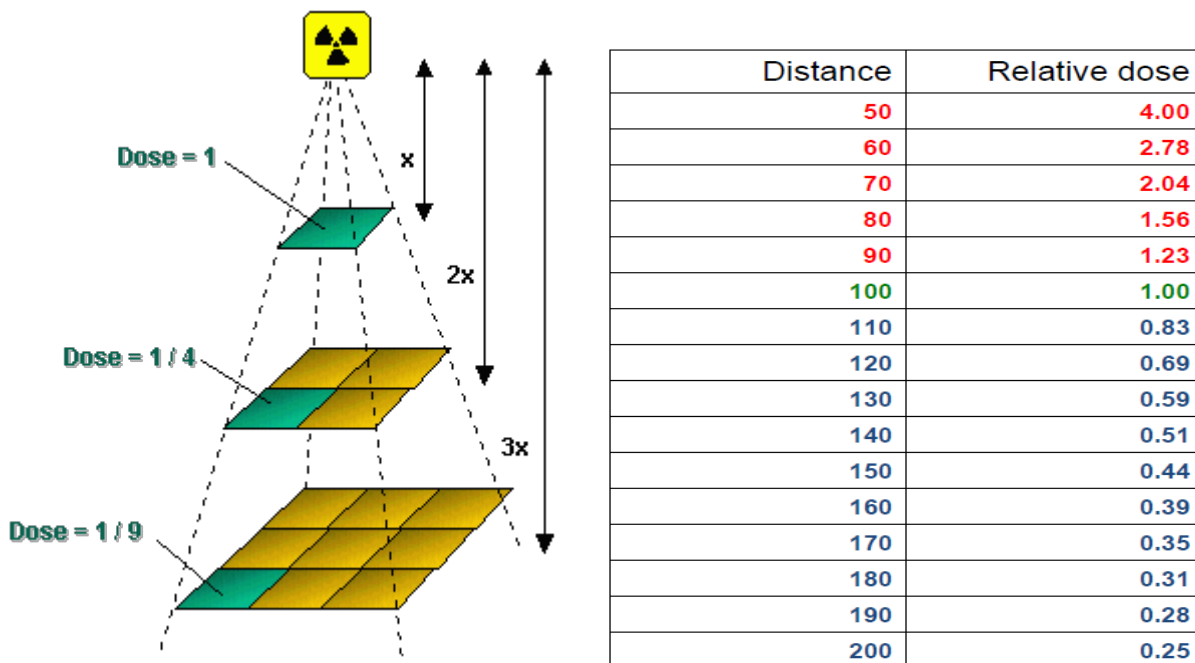

Fig: Inverse square law

In general, the dose amounts to  $1/x^2$ . Therefore, if you double the film-to-target distance, you will need four times as much radiation to achieve the same image blackening. If you did not change the patient's position, this would lead to radiation stress in the patient; thus, increasing the distance between X-ray tube and patient helps to reduce the dose.

No practical design can incorporate complete protection for operators or service personnel who do not take adequate safety precautions. **Only authorized and properly trained service and operating personnel should be allowed to work with this system.** The appropriate personnel must be made aware of the inherent dangers associated with the servicing of X-ray equipment.

### 1.2.5 PEDIATRIC USE: SUMMARY

**General Information:** Special care should be exercised when imaging patients outside the typical adult size range, especially smaller pediatric patients whose size does not overlap the adult size range (e.g., patients less than 50 kg (110 lb.) in weight and 150 cm (59 in) in height, measurements, which approximately correspond to that of an average 12-year-old or a 5th percentile U.S. adult female).

Exposure to ionizing radiation is of particular concern in pediatric patients because:

- 1) For certain organs and tumor types, younger patients are more radiosensitive than adults (i.e., the cancer risk per unit dose of ionizing radiation is higher for younger patients);
- 2) Use of equipment and exposure settings designed for adults of average size can result in excessive and unnecessary radiation exposure of smaller patients; and
- 3) Younger patients have a longer expected lifetime over which the effects of radiation exposure may manifest as cancer.

**WARNING**

**USE SPECIAL CARE WHEN IMAGING PATIENTS OUTSIDE THE TYPICAL ADULT SIZE RANGE.**

**References for pediatric dose optimization:** The following resources provide information about pediatric imaging radiation safety and/or radiation safety for general radiography devices:

- FDA's website provides radiation safety information references from a variety of groups including the Image Gently Alliance: Pediatric X-ray Imaging; <http://www.fda.gov/Radiation-EmittingProducts/RadiationEmittingProductsandProcedures/ucm298899.htm>
- and Medical X-ray Imaging (<http://www.fda.gov/Radiation-EmittingProducts/RadiationEmittingProductsandProcedures/MedicalImaging/MedicalX-Rays/default.htm>).
- In addition, FDA's Pediatric X-ray Imaging Website (<https://www.fda.gov/radiation-emittingproducts/radiationemittingproductsandprocedures/medicalimaging/ucm298899.htm>)

### 1.2.6 RADIATION SAFETY

Everyone associated with X-ray work must be familiar with the recommendations of the Center for Devices and Radiological Health (CDRH), the National Institute for Standards and Technology (NIST), the National Council on Radiation Protection (NCRP), and the International Committee on Radiation Protection (ICRP).

Be sure that all personnel authorized to operate the X-ray system are familiar with the established regulations of the authorities named above. All personnel should be monitored to ensure compliance with recommended procedures.

Current sources of information include:

- National Council on Radiation Protection Report No. 33 (“Medical X-ray and gamma ray Protection for Energies up to 10 MEV-Equipment Design and Use”).
- National Bureau of Standards Handbook No. 76 (“Medical X-ray Protection up to Three Million Volts”). Refer to NCRP Report No. 33.
- Current recommendations of the International Committee on Radiation Protection.

Although X-radiation is hazardous, X-ray equipment does not pose any danger when properly used. Be certain all operating personnel are properly educated concerning the hazards of radiation. Persons responsible for the system must understand the safety requirements and special warnings for X-ray operation. Review this manual and the manuals for each component in the system to become aware of all safety and operational requirements.

**WARNING**

Ensure exposure parameters are properly adjusted within safety limits.

**CAUTION**

Incorrectly positioning the X-ray tube and Collimator could cause the X-ray field to be misaligned with the Bucky, resulting in unacceptable images.

#### Radiation Effects

**Acute Effects:** Short term effects

Very large radiation exposures can kill humans. The lethal dose (LD) for half the population (50%) within 60 days is termed the LD<sub>50/60d</sub>. The LD<sub>50/60d</sub> in humans from acute, whole body radiation exposure is approximately 400 to 500 rads (4-5 Gy). The temperature elevation in tissue caused by the energy imparted is much less than 1° C. The severe biological response is due to ionizing nature of X-ray radiation, causing the removal of electrons, and thereby chemical changes in molecular structures.

### Deterministic Radiation Effects

A number of ionizing radiation effects occur at high doses. These all seem to appear only above a **threshold** dose. While the threshold may vary from one person to another, these effects can be eliminated by keeping doses below 100 rad. The severity of these effects increases with increasing dose above the threshold. These so-called deterministic (non-stochastic) effects are usually divided into tissue-specific local changes and whole body effects, which lead to acute radiation syndrome (Table below)

### Acute Whole Body Radiation Effects

Table: Acute Radiation Syndrome Sorenson, 2000

Syndrome	Symptoms	Dose (rad)
Radiation sickness	Nausea, vomiting	> 100 rad
Hemopoietic	Significant disruption of ability to produce blood products)	> 250 rad
LD <sub>50/60d</sub>	Death in half the population	> 250 - 450 rad
GI	Failure of GI tract lining, loss of fluids, infections	> 500 rad
CNS	Brain death	> 2,000 rad

These whole body (to entire body) doses are very unlikely for patients and staff from fluoroscopy or any diagnostic radiology study.

Several factors, such as total dose, dose rate, fractionation scheme, volume of irradiated tissue and radiation sensitivity all affect a given organ's response to radiation. Radiation is more effective at causing damage when the dose is higher and delivered over a short period of time. Fractionating the dose (i.e. spreading the dose out over time) reduces the total damage since it allows the body time for repair. Patient exposures are higher than attending staff but they occur over short periods of time whereas staff exposures are normally low and occur over several years.

### **Deterministic effects.**

These effects are observed after large absorbed doses of radiation and are mainly a consequence of radiation induced cellular death. They occur only if a large proportion of cells in an irradiated tissue have been killed by radiation, and the loss cannot be compensated by increased cellular proliferation. The ensuing tissue loss is further complicated by inflammatory processes and, if the damage is sufficiently extensive, also by secondary phenomena at the systemic level (e.g. fever, dehydration, bacteremia etc.). In addition, eventual effects of healing processes, e.g. fibrosis, may contribute to additional damage and loss of function of a tissue or an organ.

Clinical examples of such effects are: necrotic changes in skin, necrosis and fibrotic changes in internal

organs, acute radiation sickness after whole body irradiation, cataract, and sterility (table below).

Doses required to produce deterministic changes are in most cases large (usually in excess of 1-2 Gy). Some of those occur in a small proportion of patients as side effects of radiotherapy. They can also be found after complex interventional investigations (such as vascular stenting) when long fluoroscopy times have been used.

Table: Deterministic effects after whole-body and localized irradiation by X and gamma rays; approximate absorbed threshold doses for single (short-term) and fractionated or low dose-rate (long-term) exposures [5,6].

Organ/tissue	Effect	Threshold absorbed dose Gy	
		Short-term exposure (single doses)	Long-term exposure (Yearly - repeated for many years)
Testicles	Temporal sterility	0.15	0.4
	permanent sterility	3.5 - 6.0	2.0
Ovaries	Sterility	2.5 - 6.0	> 0.2
Ocular lens Detectable	opacities	0.5 - 2.0	> 0.1
	Visual impairment (cataract)	5.0	> 0.15
Bone marrow	Haemopoiesis impairment	0.5	> 0.4
Skin	1. Erythema (dry desquamation).	2	-
	2. Moist desquamation.	18	-
	3. Epidermal and deep skin necrosis	25	-
	4. Skin atrophy with complications and telangiectasia	10-12	1.0
Whole body	Acute radiation sickness (mild)	1.0	-

### **1.2.7 MANUFACTURER'S RESPONSIBILITY**

Although this equipment incorporates protection against X-radiation other than the useful beam, practical design does not provide complete protection. Equipment design does not compel the operator or assistants to take the necessary precautions; nor does it prevent the possibility of improper use (authorized or unauthorized persons carelessly, unwisely, or unknowingly exposing themselves or others to direct or secondary radiation). Allow only authorized, properly trained personnel to operate this equipment.

Be certain that all individuals authorized to use the equipment are aware of the danger of excessive exposure to X-radiation.

This equipment is sold with the understanding that the manufacturer, its agents, and representatives, do not accept any responsibility for overexposure of patients or personnel to X-radiation.

Furthermore, the manufacturer does not accept any responsibility for overexposure of patients or personnel to X-radiation generated by the equipment used in conjunction with the GXR-SD/CSD/USD PREMIUM System as a result of poor operating techniques or procedures.

No responsibility is assumed for any unit that has not been serviced and maintained in accordance with the Software Manual, or which has been modified or tampered with in any way.



### **1.2.8 MONITORING PERSONNEL**

Monitoring personnel to determine the amount of radiation to which they have been exposed provides a valuable crosscheck to determine whether or not safety measures are adequate. This crosscheck may reveal inadequate or improper radiation protection practices and/or serious radiation exposure situations.

The most effective method of determining whether the existing protective measures are adequate is the use of instruments to measure the exposure (in rads). This measurement should be taken at all locations where the operator, or any portion of the operator's body, may be inadequately shielded during exposure. Exposure must never exceed the accepted tolerable dose.

A frequently used, but less accurate, method of determining the amount of exposure is placement of film at strategic locations. After a specified period of time, develop the film to determine the amount of radiation. Fluorescent screens (used in a darkened room) may also be used to detect excessive radiation.

A common method of determining whether personnel have been exposed to excessive radiation is the use of film badges. These are X-ray sensitive film enclosed in a badge that incorporates metal filters of varying degrees of transparency to X-ray radiation. Even though this device only measures the radiation reaching the area of the body on which it is worn, it does provide an indication of the amount of radiation received.

### 1.2.9 RADIATION PROTECTION SURVEY

A radiation protection survey must be made by a qualified expert after every change in equipment or change in operating conditions which might significantly increase the probability of personnel receiving more than the maximum permissible dose equivalent.

**WARNING**

Do not install components or accessories that were not intend for use by the system. Failure to comply could result in damage to the equipment or injury to personnel.

The user is responsible for ensuring that the application and use of the GXR-SD/CSD/USD PREMIUM System does not compromise the patient contact rating of any equipment used in the vicinity of, or in conjunction with, the system.

**CAUTION**

Observe all safety precautions recommended by the accessory equipment manufacturer in the user documentation provided with the equipment.

The hardware specified for use with the GXR-SD/CSD/USD PREMIUM System has been selected, tested, and verified by DRGEM Corporation to meet the intended applications. All specified hardware meets applicable regulatory agency requirements for those countries where it is offered for sale with respect to its intended applications.

## **1.3 APPLICATION SPECIFICATION**

### **1.3.1 INTENDED MEDICAL INDICATION**

The GXR-00SD, Digital Diagnostic X-ray System is indicated for use in generating radiographic images of human anatomy. The Digital Diagnostic X-ray System is primarily used in a hospital for diagnosis of diseases in skeletal, respiratory and urinary systems. Such as the skull, spinal column, chest, abdomen, extremities, and other body parts.

### **1.3.2 INTENDED PATIENT POPULATION**

- a) Intended patient population
- b) Age: Available all people, but is not intended to use for dedicated pediatric application
- c) Weight: not relevant
- d) Height: not relevant
- e) Nationality: multiple
- f) Patient state: PATIENT is not USER

**1.3.3 INTENDED USER PROFILE**

## a) Operator

Considerations		Requirement description
Education	Minimum	<ul style="list-style-type: none"> <li>• Qualified person (He/she must have license for radiologist or have to meet local regulation)</li> <li>• Educated person by manufacturer</li> </ul>
	Maximum	<ul style="list-style-type: none"> <li>• N/A</li> </ul>
Knowledge	Minimum	<ul style="list-style-type: none"> <li>• Qualified person (He/she must have license for radiologist or have to meet local regulation)</li> </ul>
	Maximum	<ul style="list-style-type: none"> <li>• N/A</li> </ul>
Language understanding	Minimum	<ul style="list-style-type: none"> <li>• Local language</li> </ul>
	Maximum	<ul style="list-style-type: none"> <li>• Understanding of manual that is writing in English</li> </ul>
Experience	Minimum	<ul style="list-style-type: none"> <li>• He/she must have license for radiologist or have to meet local regulation</li> <li>• He/she have to be educated by manufacturer or local distributor</li> </ul>
	Maximum	<ul style="list-style-type: none"> <li>• N/A</li> </ul>
Permissible impairments	<ul style="list-style-type: none"> <li>• N/A</li> </ul>	

## b) Service engineer

Considerations		Requirement description
Education	Minimum	<ul style="list-style-type: none"> <li>• Qualified person by manufacturer or local distributor regarding installation, maintenance and service.</li> <li>• Educated person by manufacturer</li> </ul>
	Maximum	<ul style="list-style-type: none"> <li>• N/A</li> </ul>
Knowledge	Minimum	<ul style="list-style-type: none"> <li>• Qualified person (He/she must have knowledge of electrical engineering and/or radiology procedure)</li> </ul>
	Maximum	<ul style="list-style-type: none"> <li>• N/A</li> </ul>
Language understanding	Minimum	<ul style="list-style-type: none"> <li>• Local language</li> </ul>
	Maximum	<ul style="list-style-type: none"> <li>• English</li> </ul>
Experience	Minimum	<ul style="list-style-type: none"> <li>• He/she have to be educated by manufacturer or local distributor</li> </ul>
	Maximum	<ul style="list-style-type: none"> <li>• N/A</li> </ul>
Permissible impairments	<ul style="list-style-type: none"> <li>• N/A</li> </ul>	

## 1.4 SPECIFICATIONS

### ● Digital flat panel detector (VAREX)

Model		PaxScan4343R v3		PaxScan4343RC	
Active Pixel Area / Matrix		17 x 17 inch (3,052 x 3,052)		17 x 17 inch (3,052 x 3,052)	
Pixel Pitch		139um			
Limiting Resolution		3.6 lp/mm			
Screen		DRZ+	Csl	DRZ+	Csl
Energy Range		40 – 150kVp			
A/D Conversion		16-bits			
MTF	@ 1 lp/mm	54%	56%	54%	56%
	@ 2 lp/mm	23%	27%	23%	27%
	@ 3 lp/mm	9%	14%	9%	14%
DQE	@ 0 lp/mm	38%	78%	38%	78%
	@ 1 lp/mm	27%	55%	27%	55%
	@ 2 lp/mm	16%	42%	16%	42%
	@ 3 lp/mm	7%	28%	7%	28%
Interface		Gigabit Ethernet			
Weight		6.1 kg (13.4 lbs.)	6.2 kg (13.6 lbs.)	3.5 kg (7.7 lbs.)	3.76 kg (8.2 lbs.)

Model		PaxScan4336W v4		PaxScan4343W		
Active Pixel Area / Matrix		17 x 14 inch 3,052 x 2,456	17 x 14 inch 3,032 x 2,436	17 x 17 inch 3,062 x 3,062	17 x 17 inch 3,052 x 3,052	
Pixel Pitch		139um				
Limiting Resolution		3.6 lp/mm				
Screen		DRZ+	Csl	DRZ+	Standard Csl	Premium Csl
Energy Range		40 – 150kVp				
A/D Conversion		16-bits				
MTF	@ 1 lp/mm	56%	57%	56%	61%	57%
	@ 2 lp/mm	24%	28%	24%	32%	28%
	@ 3 lp/mm	12%	16%	10%	17%	14%
DQE	@ 0 lp/mm	39%	78%	39%	64%	79%
	@ 1 lp/mm	28%	58%	28%	54%	63%
	@ 2 lp/mm	18%	42%	18%	42%	48%
	@ 3 lp/mm	8%	24%	9%	29%	33%
Interface		WiFi(802.11 a/g/n/ac)		WiFi(802.11 n/ac)		
Weight		2.9 kg (6.3 lbs.)	3.0 kg (6.6 lbs.)	3.1 kg	3.3 kg	

● Digital flat panel detector (VAREX)

Model		XRpad2 3052 HWC-M	XRpad2 4336 HWC	XRpad2 4343 HWC
Active Pixel Area / Matrix		10 x 12 inch (3,004 x 2,508)	17 x 14 inch (4,288 x 3,524)	17 x 17 inch (4,288 x 4,288)
Pixel Pitch		100um		
Limiting Resolution		5 cy/mm		
Screen		Csl,		
Energy Range		40 – 150kVp		
A/D Conversion		16-bits		
MTF	@ 1 lp/mm	70%	70%	70%
	@ 2 lp/mm	40%	40%	40%
	@ 4 lp/mm	15%	15%	15%
DQE	@ 0 lp/mm	75%	75%	75%
	@ 1 lp/mm	60%	60%	60%
	@ 3 lp/mm	40%	40%	40%
Interface		Ethernet / WIFI(802.11n)		
Weight		1.8kg (4.0 lbs.)	3.2kg (7.0 lbs.)	3.8kg (8.4 lbs.)

- Digital flat panel detector (iRay)

Model	Mano4343T	Mano4343X	Mano4343W	Mano4336W	
Active Pixel Area / Matrix	17 x 17 inch (3,072 x 3,072)			17 x 14 inch (2,800 x 2,304)	
Pixel Pitch	139um			150um	
Limiting Resolution	3.6 lp/mm			3.3 lp/mm	
Screen	Csl				
Energy Range	40 – 150kVp				
A/D Conversion	16-bits				
MTF	@ 1 lp/mm	70%	75%	71%	75%
	@ 2 lp/mm	45%	50%	44%	49%
	@ 3 lp/mm	26%	30%	26%	29%
DQE	@ 0 lp/mm	65%	56%	65%	63%
	@ 1 lp/mm	47%	40%	47%	48%
	@ 2 lp/mm	35%	30%	35%	37%
Interface	Gigabit Ethernet		Gigabit Ethernet / WiFi(802.11ac)		
Weight	Approx. 4kg(Without Cable)		4.6kg	3.6kg	

- Digital flat panel detector (Fujifilm)

Model	DR-ID1271SE	DR-ID1273SE	DR-ID1272SE	DR-ID1274SE	
Active Pixel Area / Matrix	17 x 14 inch (2,836 x 2,336)		17 x 17 inch (2,836 x 2,832)		
Pixel Pitch	150um				
Limiting Resolution	3.3 lp/mm				
Screen	GOS	Csl	GOS	Csl	
Energy Range	40 – 150kVp				
A/D Conversion	16-bits				
MTF	@ 1 lp/mm	75%	80%	75%	80%
	@ 2 lp/mm	42%	54%	42%	54%
DQE	@ 0 lp/mm	45%	72%	45%	72%
	@ 1 lp/mm	31%	54%	31%	54%
Interface	Gigabit Ethernet		Gigabit Ethernet		
Weight	2.9 kg (6.3 lbs.)		3.7 kg (8.1 lbs.)		

● Digital flat panel detector (Viewoks)

Model		Agate4343XA	Agate4343XB
Active Pixel Area / Matrix		17 x 17 inch (3,072 x 3,072)	
Pixel Pitch		140um	
Limiting Resolution		3.5 lp/mm	
Screen		Csl	GOS
Energy Range		40 – 150kVp	
A/D Conversion		16-bits	
MTF	@ 1 lp/mm	70%	58%
	@ 2 lp/mm	38%	24%
	@ 3 lp/mm	21%	10%
DQE	@ 1 lp/mm	48%	26%
	@ 2 lp/mm	34%	15%
	@ 3 lp/mm	20%	6%
Interface		Gigabit Ethernet	
Weight		4.5 kg (9.9 lbs.)	

\* Agate series (Agate4343XA, Agate4343XB) detectors are NOT used in USA installations.

● Digital flat panel detector (Viewoks)

Model		VIVIX-S 1417N		VIVIX-S 1717N	
Active Pixel Area / Matrix		17 x 14 inch (3,072 x 2,560)	17 x 14 inch (3,060 x 2,548)	17 x 17 inch (3,072 x 3,072)	17 x 17 inch (3,048 x 3,048)
Pixel Pitch		140um			
Limiting Resolution		3.5 lp/mm			
Screen		GOS	Csl	GOS	Csl
Energy Range		40 – 150kVp			
A/D Conversion		14bits		16-bits	
MTF	@ 1 lp/mm	60%	72%	60%	72%
	@ 2 lp/mm	26%	40%	26%	40%
	@ 3 lp/mm	11%	22%	11%	22%
DQE	@ 1 lp/mm	27%	50%	27%	50%
	@ 2 lp/mm	18%	40%	18%	40%
	@ 3 lp/mm	9%	26%	9%	26%
Interface		Gigabit Ethernet/ WiFi(802.11a/b/g/n)		Gigabit Ethernet/ WiFi(802.11n)	
Weight		3.1 kg	3.3 kg	4.5 kg	



- **Imaging Workstation**

CPU	Intel Core i5-8500 3.2GHz(up to 3.6GHz) 6M or Higher
Memory	4GB (1x4GB) DDR4 2400Mhz or Higher
Display	Intel® HD Graphics 630 or Higher
Storage	256GB SSD, 1TB 7200RPM SATA HDD or Higher
Monitor	23 inch Color LED, Display resolution: 1920 x 1080 pixels (16:9) or Higher
Maker	HP
Weight	Desktop: 9.86 kg (21.73 lbs.), Monitor: 5.8 kg (12.78 lbs.)

- **Imaging Software**

- 1) General Features

- Windows based graphic user interface
- Multi-image display ( 1x1 ~ 4x4 )
- Multi-image selection
- Auto display layout changing function
- X-ray generator control panel
- Unlimited procedure step
- Quick step add feature and image maintenance feature by popup menu
- ROI changing and creation feature
- Maker feature ( support the creation of unlimited number of maker by user )
- Multi-language support
- EXCEL sheet for language support ( only possible on Microsoft Office automation environment )
- DAP meter ( optional )
- Unlimited PACS code ( CPT code )
- Default anatomic program more than 700
- Support DICOM Worklist SCU, DICOM Storage SCU and transfer function
- Support DICOM Multi-transfer function
- High-performance post-processing feature
- Copy & Move Images
- Dose monitoring function
- Built-in memory function
- Grid line suppression function
- Reject analysis function
- 9 preset function
- Cobb's angle function
- Tube & line enhancement function

- Detector built-in charger function
- APR positioning guide function

2) Post processing parameters

- MODULE 1
  - ◆ Edge Enhancement: 0 ~ 50
  - ◆ Contrast Factor : 1 ~ 200
  - ◆ Image Frequency : 0 ~ 20
  - ◆ Image Latitude : -10 ~ 10
  - ◆ Sharpness : 0 ~ 100
  
- MODULE 2
  - ◆ Histogram Optimization : -1.00 ~ 1.00
  - ◆ Skin line Weight : -1.00 ~ 1.00
  - ◆ Latitude Compression : -1.00 ~ 1.00
  - ◆ Contrast Enhancement : -1.00 ~ 1.00
  - ◆ Edge Enhancement : -1.00 ~ 1.00
  - ◆ Noise Suppression : -1.00 ~ 1.00
  
- MODULE 3
  - ◆ Global Brightness : -10.00 ~ 10.00
  - ◆ Global Contrast : -10.00 ~ 10.00
  - ◆ Latitude Compression : -10.00 ~ 10.00
  - ◆ S-Structure Enhancement : -10.00 ~ 10.00
  - ◆ Noise Suppression : -10.00 ~ 10.00

3) Image Maintenance ( All functions are supported by the pop-up menu )

- ROI : Default 8 ROI support / Unlimited support for anatomic projection
- MARK : Unlimited support ( User preset support )
- Horizontal Flip
- Vertical Flip
- Rotate CW
- Rotate CCW
- Inverse (Black or White)
- Text Annotation
- Ruler : Distance tool
- Angle : Angle measurement tool

- Zoom : Image zoom in/out
  - Magnify : Image magnify glass window
  - Pan : Image panning
  - Fit Image : Auto fitting to window size
  - Image Cut : Image crop/cut function
  - Image Copy : Copy of image in the region of interest(ROI)
  - Image Recovery : Recover the original image
  - Image Bright/Contrast control : Supported by right-click mouse
- 4) CD Burning
- DICOMDIR based CDR data generation
  - Support CD/DVD Recording
  - Include internal DICOM Viewer
  - Support multi-study data
- 5) DICOM Features : DICOM PRINT
- DICOM 3.0 compatible
  - Support Print Preview
  - Support Film Orientation : Portrait / Landscape
  - Support Film Size : 8X10 / 10X12 / 10X14 / 11X14 / 14X14 / 14X17 / 24X24 / 24X30 / 25X30
  - Support Film Layout : 1:1 / 1:2 / 2:1 / 2:2 / 3:1 / 1:3 / 3:3 / 4:4
  - Support Real size printing
  - Support image swap in layout
- 6) DICOM Feature : DICOM STORAGE
- DICOM 3.0 compatible
  - Support DX/CR modality ( can be extended for DR and other )
  - Support RDSR(Radiation Dose Structured Report)
  - Support the modification of Transfer Syntax
- 7) DICOM Feature : MPPS
- Support Modality Performed Procedure Step feature
  - Provides only three state : FAILED / IN PROGRESS / COMPLETED
- 8) DICOM Feature : WORKLIST
- Support DICOM Modality Worklist Standard
  - Support DICOM Query/Retrieve

- Support Search Filter ( ID / Name / Access Number )
- Support Import Filter

9) DICOM Feature : STORAGE COMMITMENT

10) DICOM Feature : QUERY/RETRIEVE

11) DICOM Feature : VERIFICATION

12) Overlay Display on image

- Projection description
- Patient Name / Sex / Age
- kV / mA / Time / mAs
- Feed-back mAs / Feed-back Time for AEC
- EI(Exposure Index) / DI(Deviation Index)
- Window Width/Level
- Overlay can be set by user

13) Full-spine Imaging

- Stitches whole spine/long bone images to single image
- Support 2 or 3 images stitching
- Support zoom in/out of all images simultaneously
- Moves single image or all images simultaneously
- Support automatic stitching using 2 point
- Support image clipping
- Automatically remove non-exposure area
- Adjust windows of single or all images simultaneously
- Provide full-spine imaging apparatus

## ● X-ray Generators

System Model	GXR-32SD	GXR-40SD	GXR-52SD	GXR-68SD	GXR-82SD
Generator Model	<b>GXR-32</b>	<b>GXR-40</b>	<b>GXR-52</b>	<b>GXR-68</b>	<b>GXR-82</b>
Output Rating	32kW	40kW	52kW	68kW	82kW
Line Nominal, Phase	220~230VAC, 1Φ 380/400/480VAC, 3Φ		380/400/480VAC, 3Φ		
Line Frequency	±10% (50/60Hz)				
kV Range/Frequency	40~125kV, 1kV step/30kHz		40~150kV, 1kV step/100kHz		
mA Range	10 to 400mA	10 to 500mA	10 to 640mA	10 to 800mA	10 to 1,000mA
Timer Range	0.001 to 10 sec, 38 steps				
mAs Range	0.1 to 500mAs (Optional up to 1,000mAs)				
Max. Power Output	400mA@80kV	500mA@80kV	640mA@81kV	800mA@85kV	1,000mA@82kV
	320mA@100kV	400mA@100kV	500mA@104kV	640mA@106kV	800mA@102kV
	250mA@125kV	320mA@125kV	400mA@130kV	500mA@136kV	640mA@128kV
	200mA@150kV(3 Φ)	250mA@150kV(3 Φ)	320mA@150kV	400mA@150kV	500mA@150kV
Power Requirement	Minimum 125% of output rating				
Minimum Breaker Rating	75A(220-230Vac,1Φ)	100A(220-230Vac,1Φ)			
	50A(380Vac,3Φ)	65A(380Vac,3Φ)	75A(380Vac,3Φ)	75A(380Vac,3Φ)	100A(380Vac,3Φ)
	50A(400Vac,3Φ)	65A(400Vac,3Φ)	75A(400Vac,3Φ)	90A(400Vac,3Φ)	100A(400Vac,3Φ)
	40A(480Vac,3Φ)	50A(480Vac,3Φ)	65A(480Vac,3Φ)	75A(480Vac,3Φ)	90A(480Vac,3Φ)
Rotor Supply	Low Speed Dual Speed (Option for 3Φ)		Dual Speed (Option for GXR-52)		
Reproducibility	Coefficient of Variation: kV < 0.005, Time < 0.005, mAs < 0.01				
Accuracy	kV < ±(1%+1kV), mA < ±(3%+1mA), Time < ±(1%+0.5ms), mAs < ±(3%+0.1mAs)				
Linearity	Coefficient of Linearity < 0.01 : CL = (X1-X2)/(X1+X2), where X is mR/mAs				
Anatomical Programs	User programmable max. 1,280 programs with APR utility software				
Technique Selection	4 point display(kV, mA, Time, mAs)				
Image Receptors	2 Bucky + 1 Non-Bucky				
Auxiliary Power Supply	External System Power		230VAC, 1A, 230W (PBT-4)		
			230VAC, 2A, 460W (PBT-6)		
	Magnetic Lock(Brake) Power		110VAC, 1A, 110W		
			28VDC, 6.3A, 176W		
Collimator Lamp Power		24VAC, 6.3A, 150W			
Leakage Radiation	Less than 2mR/hr				
Dimension / Weight	Control Console		336(W) x 47(H) x 232(D) mm / 1.7kg(3.8lbs)		

	Main Cabinet	650(W) x 655(H) x 455(D) mm / 100kg(220lbs)
--	--------------	---

● **GXR-C X-ray Generators**

System Model	GXR-C32SD	GXR-C40SD	GXR-C52SD
Generator Model	<b>GXR-C32</b>	<b>GXR-C40</b>	<b>GXR-C52</b>
Power Rating	32kW	40kW	52kW
Line Power	110-120, 220-230V~, ±10% (Frequency: 50*/60Hz), * : Outside North America		
kV Range	40~125kV, 1kV step (Optional 40~150kV)		
mA Range	10 to 400mA	10 to 500mA	10 to 640mA
Timer Range	0.001 to 10 sec, 38 steps		
mAs Range	0.1 to 500mAs		
Max. Power Output	400mA@80kV 320mA@100kV 250mA@125kV 200mA@150kV(optional)	500mA@80kV 400mA@100kV 320mA@125kV 250mA@150kV(optional)	640mA@81kV, 500mA@104kV, 400mA@130kV 320mA at 150kV (optional)
Rotor Supply	Low Speed		
Anatomical Programs	User programmable max 1,280 programs with APR utility software (Including Bucky & AEC selection)		
Technique Selection	4 point display(kV, mA, Time, mAs)		
Image Receptors	2 Bucky + 1 Non-Bucky		
Auxiliary Power Supply	External System Power	230VAC, 1A, 230W (PBT-4)	
		230VAC, 2A, 460W (PBT-6)	
	Magnetic Lock Power	110VAC, 1A, 110W	
		28VDC, 6.3A, 176W	
Collimator Lamp Power	24VAC, 6.3A, 150W		
X-ray Ripple Frequency	30kHz		
Reproducibility	Coefficient of Variation: kV < 0.005, Time < 0.005, mAs < 0.01		
Accuracy	kV < ±(1%+1kV), mA < ±(3%+1mA), Time < ±(1%+0.5ms), mAs < ±(3%+0.1mAs)		
Linearity	Coefficient of Linearity < 0.01 : CL = (X1-X2)/(X1+X2), where X is mR/mAs		

## ● GXR-U X-ray Generators

System Model	GXR-U32SD	GXR-U40SD
Generator model	GXR-U32	GXR-U40
Power Rating	32kW	40kW
Line Nominal, Phase	100-240VAC, Single phase	
Line Voltage Range	±10% (Frequency: 50/60Hz)	
kV Range	40~125Kv(optional 150kV), 1kV step	
mA Range	10 to 400mA	10 to 500mA
Timer Range	0.001 to 10 sec, 38 steps	
mAs Range	0.1 to 500mAs(Optional up to 1,000mAs)	
Max. Power Output	400mA@80kV 320mA@100kV 250mA@125kV Optional 200mA@150kV	500mA@80kV 400mA@100kV 320mA@125kV Optional 250mA@150kV
Power Requirement	900VA	
Rotor Supply	Low Speed (Optional LSS Brake)	
Reproducibility	Coefficient of Variation: kV < 0.005, Time < 0.005, mAs < 0.01	
Accuracy	kV < ±(1%+1kV), mA < ±(3%+1mA), Time < ±(1%+0.5ms), mAs < ±(3%+0.1mAs)	
Linearity	Coefficient of Linearity < 0.01 : CL = (X1-X2)/(X1+X2), where X is mR/mAs	
Anatomical Programs	Programmable 1280 programs with Software	
Technique Selection	4 point display(kV, mA, Time, mAs): kV/mAs, kV/mA/Time, kV/AEC option	
Image Receptors	2 Bucky + 1 Non-Bucky	
Auxiliary Power Supply	External System Power	230VAC, 1A, 230W (PBT-4)
		230VAC, 2A, 460W (PBT-6)
	Magnetic Lock Power	110VAC, 1A, 110W
		28VDC, 6.3A, 176W
Collimator Lamp Power	24VAC, 6.3A, 150W	
Dimension	628(W) x 1075(H) x 460(D) mm	628(W) x 1187(H) x 460(D) mm

● Patient Table

1) 4-way Floating tabletop table

Model		PBT-4	
Movement	Tabletop	Longitudinal	1,000(±500)mm
		Transverse(Lateral)	250(±125)mm
	Bucky	Longitudinal	Max.350mm with standard tray 300mm with rotating tray
Tabletop		Inherent Filtration	Laminate : 1.2mmAl at 100kV Carbon : 0.5mmAL at 100kV
		Max. Patient Weight	300kg (660lbs)
		Size	2,200(W) x 818(D) x 45(H) mm 2,000(W) x 818(D) x 45(H) mm 1,800(W) x 818(D) x 45(H) mm
Bucky Type		Oscillating	Fixed
Grid		FD 34~44inch, 103 or 180 lpi, ratio 8~12:1	FD 100cm, 200lpi, ratio 8~12:1 Optional removable grid
Lock(Brake)		EM Lock, beam sensor on/off	
Center indication		Buzzer sound and LED	
Electrical Rating		100~240Vac, 200VA, 50/60Hz	
Dimension / Weight	Laminate	2,200(W) x 818(D) x 660(H) mm / 145.7kg(321.2lbs) 2,000(W) x 818(D) x 660(H) mm / 142.7kg(314.6lbs) 1,800(W) x 818(D) x 660(H) mm / 139.7kg(308lbs)	
	Carbon	2,200(W) x 818(D) x 660(H) mm / 140.3kg(309.3lbs) 2,000(W) x 818(D) x 660(H) mm / 137.9kg(304lbs) 1,800(W) x 818(D) x 660(H) mm / 134.6kg(296.7lbs)	

\* APPLIED PART, Optional Rotating tray

2) Elevating table

Model		PBT-6	
Movement	Tabletop	Longitudinal	1,000(±500)mm Option 1100(±550)mm
		Transverse(Lateral)	250(±125)mm
	Vertical	Travel	285(575~860)mm,, Option 360(500~860)mm,
		Speed	17mm/sec
		Operating	Motorized movement by Foot Switch DC-motor (Linear Actuator)
	Bucky	Longitudinal	Standard application - 550mm with standard tray - 295mm with rotating tray - 290mm with Table Bucky Tracking(Optional)  Option 1100mm longitudinal application - 740mm with standard tray - 690mm with rotating tray - 680mm with Table Bucky Tracking(Optional)
Tabletop	Inherent Filtration	Laminate : 1.2mmAl at 100kV Carbon : 0.5mmAL at 100kV	
	Max. Patient Weight	300kg(660lbs)	



	Size	Standard application 2,200(W) x 878(D) x 45(H) mm 2,000(W) x 878(D) x 45(H) mm 1,800(W) x 878(D) x 45(H) mm Option 1100mm longitudinal application 2,660(W) x 878(D) x 45(H) mm 2,400(W) x 878(D) x 45(H) mm 2,200(W) x 878(D) x 45(H) mm
Bucky Type	Oscillating	Fixed
Grid	FD 34~44inch, 103 or 180 lpi, ratio 8~12:1	FD 100cm, 200lpi, ratio 8~12:1 Optional removable grid
Lock(Brake)	EM Lock, Foot Switch on/off	
Center indication	Transverse center, height center	
Side Cover	2-story telescopic Cover	
Electrical Rating	100~240VAC, 400VA, 50/60Hz	
Dimension / Weight	Laminate	Standard application 2200(W) x 878(D) x 860(H) mm / 255.2kg(562.6lbs) 2000(W) x 878(D) x 860(H) mm / 252.2kg(556lbs) 1800(W) x 878(D) x 860(H) mm / 248.2kg(547.2lbs) Option 1100mm longitudinal application 2660(W) x 878(D) x 860(H) mm / 310kg(683.4lbs) 2400(W) x 878(D) x 860(H) mm / 306kg(674.6lbs) 2200(W) x 878(D) x 860(H) mm / 303kg(668lbs)
	Carbon	Standard application 2200(W) x 878(D) x 860(H) mm / 249.1kg(549.2lbs) 2000(W) x 878(D) x 860(H) mm / 246.9kg(544.3lbs) 1800(W) x 878(D) x 860(H) mm / 243.6kg(537lbs) Option 1100mm longitudinal application 2660(W) x 878(D) x 860(H) mm / 302.2kg(666.2lbs) 2400(W) x 878(D) x 860(H) mm / 299.2kg(659.6lbs) 2200(W) x 878(D) x 860(H) mm / 296.9kg(654.6lbs)

\* APPLIED PART, Optional Rotating tray

### 3) Mobile Patient Table

Model	PDT-1
Max. Patient Weight	Max. 200kg (441lbs)
Dimension / Weight	2004(W) x 650(D) X 712(H)mm / 62kg (137lb)

#### ● Wall Bucky stand

Model	WBS(Motorized)	
Cassette stroke	970mm(300mm~1,270mm from floor to focus) 1,120mm(300mm~1,420mm from floor to focus) 1,290mm(300mm~1,590mm from floor to focus) 1,540mm(300mm~1,860mm from floor to focus)	
Bucky Type	Oscillating	Fixed
Grid	FD 40~72inch, 103 or 180lpi, ratio 8~12:1	FD 150cm, 200lpi, ratio 8~12:1 Optional removable grid

Lock(Brake)	EM Lock, Switch on/off
Balance	Counter Weight
Electrical Rating	100-240VAC, 160VA, 50/60Hz
Dimension / Weight	1,614(H) x 738(W) x 544(D) mm / 126kg(277lbs) 1,764(H) x 738(W) x 544(D) mm / 130kg(286lbs) 1,934(H) x 738(W) x 544(D) mm / 132kg(291lbs) 2,184(H) x 738(W) x 544(D) mm / 135kg(297lbs)

\* APPLIED PART, Optional Rotating tray

Model	WBS-TA
Cassette stroke	Vertical 1,526mm (326~1,852mm from floor to Bucky center)
Vertical movement	Manual and Motorized movement
Bucky Type	Oscillating type
Grid	Focal distance 40~72inch, 103 lpi, ratio 10:1
Tilting range	-30° ~ 90°
Tilting Movement	Motorized Movement
Lock(Brake)	EM Lock, Switch on/off
Balance	Counter Weight
Electrical Rating	100~240VAC, 200VA, 50/60Hz
Dimension / Weight	Max. 2,179(H) x 743(W) x 949(D) mm / 195kg(430lbs)
Option	Remote controller, Overhead handgrip

\* APPLIED PART, Optional Rotating tray

Model	WBS-TM(Motorized)	
Stroke	Vertical	1,492mm (286~1,778mm from floor to Bucky center)
	Tilted 90°	1,517mm (645~2,162mm from floor to Bucky surface)
Bucky Type	Spring oscillating	
Grid	FD 150cm, 103 lpi, ratio 10:1	
Tilting Angle	-30 ~ 90°	
Withstanding load (at tilting angle 90°)	20kgf at the point 150mm from the side.	
Inherent Filtration	0.5mmAl at 100kV	
Lock(Brake)	EM Lock, Switch on/off by foot switch(Vertical movement, Tilting)	
Vertical Balance	Counter Weight	
Vertical Movement	Manual (Option: Motorized)	
Tilting Balance	Spring	
Electrical Rating	100-240VAC, 160VA, 50/60Hz	
Dimension/Weight	Max. 2,184(H) x 669(W) x 1140(D) mm / 218kg(480lbs)	

\* APPLIED PART, Optional Rotating tray

- Tube stand7

- 1) Floor-Ceiling Mounted

Model	TS-FC6(Motorized)	
Tube Rotation Angle	Horizontal axis	±135°
	Vertical axis	±180° (mechanical detents at every 90°)
Tube stroke	Longitudinal	2,536mm
	Lateral	220mm
	Vertical	1,526mm (440~1,966mm from floor to focus)
Vertical Movement	Manual or Motorized(Optional) Motorized option supports vertical sync with table and wall stand	
Tube Rotation	Manual or Motorized(Optional) Motorized option supports the source tilting type image stitching operation	
Lock(Brake)	EM Lock, Switch on/off	
Balance	Counter Weight	
Column Rotation	90° step, Foot Lock	
Options	Line laser, Column rotation by electrical release	
Electrical Rating	100–240VAC, 160VA, 50/60Hz	
Dimension / Weight	2,465(H) x 3,600(W) x 1,420(D) mm / 240kg(529lbs) Option(Tube Head Motorized Rotation) : 2458(H)x1140(D)mm /260kg(571lbs)	

Model	TS-FC4(Motorized)	
Tube Rotation Angle	±135°	
Tube stroke	Longitudinal	2,036mm / 2,536mm
	Lateral	N/A
	Vertical	1,410mm (420~1,830mm from floor to focus) 1,660mm (420~2,080mm from floor to focus)
Vertical Movement	Manual and Motorized movement	
Lock(Brake)	EM Lock, Switch on/off	
Balance	Counter Weight	
Electrical Rating	100–240VAC, 160VA, 50/60Hz	
Dimension / Weight	Max. 3,600(W) x 780(D) x 2,050(H)mm / 172kg(378lbs)	

Model	TS-FC2(Motorized)	
Tube Direction	Right-angle or Straight	
Tube Rotation	N/A	
Tube stroke	Longitudinal	N/A
	Lateral	N/A
	Vertical	1) 1,080mm(324mm~1,404mm from floor to focus) 2) 1,230mm(324mm~1,554mm from floor to focus) 3) 1,400mm(324mm~1,724mm from floor to focus) 4) 1,650mm(324mm~1,974mm from floor to focus)
Vertical Movement	Motorized, Vertical synchronization with wall stand	
Lock(Brake)	EM Lock, Switch on/off	
Balance	Counter Weight	
Electrical Rating	100–240VAC, 160VA, 50/60Hz	
Dimension / Weight	1) Right-angle type: 1,614(H) x 659 (W) x 770(D) mm / 162kg(357lbs) Straight type: 1,614(H) x 659 (W) x 859(D) mm / 162kg(357lbs) 2) Right-angle type: 1,764(H) x 659 (W) x 770(D) mm / 165kg(363lbs) Straight type: 1,764(H) x 659 (W) x 859(D) mm / 165kg(363lbs) 3) Right-angle type: 1,934(H) x 659(W) x 770(D) mm / 155kg(341lbs) Straight type: 1,934(H) x 659(W) x 859(D) mm / 155kg(341lbs) 4) Right-angle type: 2,184(H) x 659(W) x 770(D) mm / 160kg(352lbs) Straight type: 2,184(H) x 659(W) x 859(D) mm / 160kg(352lbs)	

**2) Floor Mounted**

Model	TS-FM6(Motorized)	
Tube Rotation Angle	Horizontal axis	±135°
	Vertical axis	±180° (mechanical detents at every 90°)
Tube stroke	Longitudinal	2,100mm (Optional 2,900mm and 3,600mm)
	Lateral	250mm
	Vertical	1,706mm (240~1,946mm from floor to focus)
Vertical Movement	Manual or Motorized(Option) Motorized option supports vertical sync with table and wall stand	
Tube Rotation	Manual or Motorized(Option) Motorized option supports the source tilting type image stitching operation	
Lock(Brake)	EM Lock, Switch on/off	
Balance	Counter Weight	
Column Rotation	±180°, EM lock, Switch on/off	
Tube OP	7 inch Touch screen	
Electrical Rating	100–240VAC, 160VA, 50/60Hz	
Dimension / Weight	2,327(H) x 3,006(D) mm / 266kg(586lbs) Option(Tube Head Motorized Rotation): 2,330(H) x 3,006(D) mm /272kg(599lbs)	

## 3) Ceiling suspended

Model	TS-CSA	
Tube Rotation Angle	Horizontal axis	±180° (LCD display)
	Vertical axis	±180° (mechanical detents at every 90°)
Tube stroke (with 3x4m rails - Transverse x Longitudinal)	Longitudinal	3,280mm(with 4m rail), 4,280mm(with 5m rail)
	Lateral	2,200mm(with 3m rail), 3,200mm(with 4m rail)
	Vertical	1,500mm or 1,600mm (1,500mm is possible up to the weight of E7252X plus R108)
Lock(Brake)	EM Lock, Switch on/off	
Balance	Spring	
Vertical Movement	Manual or Motorized(Optional) Motorized option supports vertical sync with table and wall stand	
Tube Rotation	Manual or Motorized(Optional) Motorized option supports the source tilting type image stitching operation	
Option	Auto Collimation, Detent	
SID Indication	7inch Touch Screen LCD with control buttons	
Electrical Rating	100–240VAC, 200VA, 50/60Hz	
Dimension	2,830(H) x 3,000(D) mm x 4,000(W) mm when vertical direction is fully extended with 1,600mm stroke and 3x4m rails	
Weight	Main body: 170kg(375lbs) except tube and collimator, Rails: 115kg(254lbs, 3x4m rails)	

Model	TS-CSP	
Tube Rotation Angle	Horizontal axis	±180° (LCD display)
	Vertical axis	±180° (mechanical detents at every 90°)
Tube stroke (with 3x4m rails - Transverse x Longitudinal)	Longitudinal	3,280mm
	Lateral	2,200mm
	Vertical	1,600mm
Lock(Brake)	EM Lock, Switch on/off	
Balance	Spring	
Operation	Manual or Vertical Motorized Optional vertical synchronization with Wall stand and Table for motorized stand	
Indication / Control	7inch Touch Screen LCD with control buttons	
Dimension	2758(mm)x3000(mm)x4000(mm)	
Electrical Rating	220-230V~, 500VA, 50/60Hz	
Weight	Main body: 175kg(386lbs) except tube, Rails: 122kg(269lbs)	



- X-ray Tube

Tube Model	E7239X	DXT-8M	E7242X	DXT-11M
Manufacturer	CANON	DRGEM	CANON	DRGEM
Focal Spot Size	1.0/2.0mm	1.0/2.0mm	0.6/1.5mm	0.6/1.5mm
Rating(0.1s)	22.5/47kW @60Hz	22.5/47kW @60Hz	18/50kW @60Hz	18/50kW @60Hz
Max. Anode HU	140kHU(100kJ)	140kHU(100kJ)	200kHU(142kJ)	200kHU(142kJ)
Target Angle	16°	16°	14°	14°
Max. kV	125kV	125kV	125kV	125kV
Weight	16kg(35.3lbs)	16kg(35.3lbs)	16kg(35.3lbs)	16kg(35.3lbs)
Inherent Filtration	0.9mmAl/75kV	1.0mmAl/75kV	0.9mmAl/75kV	1.0mmAl/75kV
Half Value Layer	More than 2.9mmAl eq. at 80kVp			
Leakage Radiation	Less than 100mR/hr			

Tube Model	E7843X	DXT-10M	E7876X
Manufacturer	CANON	DRGEM	CANON
Focal Spot Size	0.6/1.2mm	0.6/1.2mm	0.6/1.2mm
Rating(0.1s)	22/50kW @60Hz	17/48kW @60Hz	22/54kW @60Hz
Max. Anode HU	150kHU(111kJ)	150kHU(111kJ)	230kHU(163kJ)
Target Angle	12°	12°	12°
Max. kV	150kV	125kV	150kV
Weight	16kg(35.3lbs)	16kg(35.3lbs)	16kg(55.1lbs)
Inherent Filtration	1.3mmAl/75kV	1.0mmAl/75kV	1.3mmAl/75kV
Half Value Layer	More than 2.9mmAl eq. at 80kVp		
Leakage Radiation	Less than 100mR/hr		

Tube Model	E7884X	DXT-12M	E7252X
Manufacturer	CANON	DRGEM	CANON
Focal Spot Size	0.6/1.2mm	0.6/1.2mm	0.6/1.2mm
Rating(0.1s)	22/54kW @60Hz	22/54kW @60Hz	27/75kW
Max. Anode HU	300kHU(210kJ)	300kHU(210kJ)	300kHU(210kJ)
Target Angle	12°	12°	12°
Max. kV	150kV	150kV	150kV
Weight	16kg(35.3lbs)	16kg(35.3lbs)	18kg(39.7lbs)
Inherent Filtration	0.9mmAl/75kV	1.0mmAl/75kV	0.9mmAl/75kV
Half Value Layer	More than 2.9mmAl eq. at 80kVp		
Leakage Radiation	Less than 100mR/hr		

Tube Model	DXT-14U	RAD-14	DXT-15U *
Manufacturer	DRGEM	VAREX	DRGEM
Focal Spot Size	0.6/1.2mm	0.6/1.2mm	0.6/1.2mm
Rating(0.1s)	27/75kW	32/77kW	32/77kW
Max. Anode HU	300kHU(210kJ)	300kHU(210kJ)	300kHU(210kJ)
Target Angle	12°	12°	12°
Max. kV	150kV	150kV	150kV
Weight	18kg(39.7lbs)	16.4kg(36.2lbs)	16.4kg(36.2lbs)
Inherent Filtration	1.0mmAl/75kV	0.6mmAl/75kV	0.7mmAl/75kV
Additional Filtration		0.5mmAl	0.5mmAl
Half Value Layer	More than 2.9mmAl eq. at 80kVp		
Leakage Radiation	Less than 100mR/hr		

\* Adopting VAREX RAD-14 Insert.

Tube Model	RAD-21	RAD-60	RAD-92
Manufacturer	VAREX	VAREX	VAREX
Focal Spot Size	0.6/1.2mm	0.6/1.2mm	0.6/1.2mm
Rating(0.1s)	36/100kW	40/100kW	40/100kW
Max. Anode HU	300kHU(210kJ)	400kHU(285kJ)	600kHU(444kJ)
Target Angle	12°	12°	12°
Max. kV	150kV	150kV	150kV
Weight	18.9kg(41.7lbs)	18.9kg(41.7lbs)	18.9kg(41.7lbs)
Inherent Filtration	0.7mmAl/75kV	0.7mmAl/75kV	0.7mmAl/75kV
Additional Filtration	0.5mmAl		
Half Value Layer	More than 2.9mmAl eq. at 80kVp		
Leakage Radiation	Less than 100mR/hr		

Tube Model	E7255FX	E7254FX	E7869X
Manufacturer	CANON	CANON	CANON
Focal Spot Size	0.6/1.2mm	0.6/1.2mm	0.6/1.2mm
Rating(0.1s)	40/102kW	40/102kW	40/100kW
Max. Anode HU	300kHU(210kJ)	400kHU(285kJ)	600kHU(444kJ)
Target Angle	12°	12°	12°
Max. kV	150kV	150kV	150kV
Weight	20kg(44.1lbs)	25kg(55.1lbs)	24kg(52.9lbs)
Inherent Filtration	0.8mmAl/75kV	0.8mmAl/75kV	1.1mmAl/75kV
Additional Filtration	0.5mmAl		
Half Value Layer	More than 2.9mmAl eq. at 80kVp		
Leakage Radiation	Less than 100mR/hr		

\* Total filtration including X-ray tube assembly and collimator will be matched by appropriate additional filters to within the range from 2.9 to 3.2mmAl. eq.

## ● Collimator

Model	MCR	DXC-RML, DXC-RMH
Manufacturer	DRGEM	
Control	Manual with 30sec. lamp timer	
Field Shape	Rectangular	
Max. Field Size	More than 43x43cm(17x17inch) at 100cm SID	
Leakage Radiation	Less than 100mR/hr	Less than 40 mR/h
Max. kVp shield	150kV	150kV
Inherent Filtration	1.2mmAl eq.	2mmAl eq.
Luminosity	Over 160LUX at 100cm SID (Typ. 200LUX)	Over 160LUX at 1cm SID
Light source	HLX64642 150W 24V / OSRAM	LED and Halogen
Standard	Rotating flange with fixing knob	
Option	Tape measure	Line laser+shutter, Measure tape Near port moving shutters, Mounting flange mechanical detent Accessory guides spring, Additional filter, DAP rail
Electrical Rating	24Vac, 6.3A, 50/60Hz	Halogen type - 24 V DC/AC - 50~60Hz 160VA LED type - 12~45V DC 35VA / 20~30VAC 35VA - 50~60Hz
Dimension / Weight	185(W) x 213(D) x 180(H) mm / 6.3kg(13.9lb)	196(W) x 250(D) x 171(H) mm 7.1kg(15.6lb)

Model	R108	R302A, R302MLP/A, R302MFMLP/A
Manufacturer	RALCO	
Control	Manual with 30sec. lamp timer	
Field Shape	Rectangular	
Max. Field Size	More than 43x43cm(17x17inch) at 100cm SID	
Leakage Radiation	Less than 100mR/hr	
Max. kVp shield	150kV	150kV
Inherent Filtration	2.0mmAl eq.	2.0mmAl eq.
Luminosity	Over 160LUX at 100cm SID (Typ. 250LUX)	Over 160LUX at 100cm SID (Typ. 200LUX)
Light source	Single LED	HLX64638 100W 24V / OSRAM
Standard	Tape measure, rotating flange	Auto collimation for R302 MLP/A and R302 MFMLP/A Auto filter selection for R 302 MFMLP/A
Option	Line laser, near port shutters	Tape measure, line laser, rotating flange
Electrical Rating	20–30Vac, 30VA, 50/60Hz	24Vac, 6.3A, 50/60Hz
Dimension / Weight	223(W) x 246(D) x 140(H) mm / 6.6kg(14.6lb)	195.5(W) x 237(D) x 206.5(H) mm / 9.4kg(20.7lb)

- **AEC Ion Chamber (Option)**

Model	ICX1162(ICX1192B)	Amplimat 5-Field
Manufacturer	AID	Philips
Field	3 Fields	5 Fields
X-ray Energy Range	40~150kV	40~150kV
Exposure time Range	1ms to 10s	1ms to 6s
Inherent Filtration	0.4 mm Al eq.	0.8 mm Al eq.
Weight	2kg (4.4lb)	1.8kg (4lb)

- **DAP meter (Option)**

DAP Resolution	0.01 $\mu\text{Gym}^2$
Interface	RS485
Active area	115 x 115mm / 146 x 146mm
Display	Optional integrated or separate display (single or dual line)
Dimension	158 x 134.5 x 17mm / 180 x 156 x 17mm

- **Other Options**

- Pedestal console stand
- Patient holder
- Patient hand grips (Tabletop, Wall stand – Overhead, Lateral)
- Cassette holders (Lateral, External Wall Bucky)
- DAP meter with display
- Full-spine imaging software with apparatus
- DC power supply for line powered x-ray generator in case of insufficient line power
- DC brake for low speed starter of x-ray generator
- Radiation protection
  - Wearing(apron, neck guide, glove), movable x-ray protection wall

- **AP (Access Point) for Wireless**

Model	RT-AC68U (AC 1900)
Product Picture	
Manufacturer	ASUS
Standards	IEEE 802.11n, IEEE 802.11ac
Frequency	5GHz / 2.4GHz
Wireless LAN (max.)	1.3Gbps(5GHz)/600Mbps (2.4GHz)
Weight Antennas Type	3 external antennas
AC Power Adapter	19V / 1.75A
Regulatory Compliance	CE, FCC, RoHS, KCC

- **Software Version**

Software/Firmware	Version		Description
RADMAX	1.00		RADMAX is the main software provides top level graphics user interface on whole system control and imaging process. RADMAX consists of System Control Module, Imaging Module, DICOM Module, Database Module, System Diagnosis Module and Display Module.
GXR HT Control Board	GXR	1.5a	GXR HT Control Board at x-ray generator controls whole x-ray generation process by the control of System Control Module in RADMAX. This module controls x-ray parameters such as kV, mA and exposure time, and controls the filament and rotor driving and detector interfacing.
	GXR_C	1.2a	
	GXR-U	1.1a	
GXR DSS board (GXR)	1.00		GXR DSS board at x-ray generator controls starter operation which drives tube's anode rotation by the control of GXR DSS board at x-ray generator.
GXR Charger board (GXR-C)	1.00		GXR Charger board is X-ray generator charges the capacitor modules in the power stack of the generator to save the energy for X-ray exposure. This module detects voltage and current of capacitor modules to protect capacitor modules.
GXR Inverter board (GXR-U)	1.01		GXR Inverter board is x-ray generator supplies AC mains voltage to the generator, and monitors the voltage of battery modules to control charging level of battery modules.
Commutation Board	1.00		Commutation Board at integrated control board in wall bucky stand controls the communication of GXR, PC interface module and Tube stand.
WBS Motorized Control Board	1.00		WBS Motorized Control Board at integrated control board in wall bucky stand controls the each lock and DC Motors.
WBS OP Control Board	1.00		WBS OP Control Board at integrated control board in wall bucky stand controls the each switch and Display the information of Vertical movement and Tilting Angles.
PBT6 Auto Control Board	1.00		PBT6 Auto Control Board integrated control board controls the Tabletop table and Vertical movement of patient table.
Auto Tracking Control Board	1.00		Auto Tracking Control Board at integrated control board controls the movement of table bucky.
Ceiling Main Control Board	1.00		Ceiling Main Control Board at integrated control board controls the each lock, motor, communication and position of TS_CSA.

Tube Stand Control Board(TS_FM6)	1.00	Tube Stand Control Board(TS_FM6)at integrated control board controls the each lock, motor, communication and position of TS-FM 6.
THU	1.00	THU at integrated control board displays the information of conventional stand, generator and image.
Tube OP Switch Board	1.00	Tube OP Switch Board at integrated control board control the lock switch and measures the angle of tube head.
OP Main Control Board	1.00	OP Main Control Board at integrated control board in the TS-CSA measures the angle of THU

### **OPERATING ENVIRONMENT**

Ambient temperature range      10 to 40 °C (50 to 105 °F).

Relative humidity                      30% to 75%, non-condensing

Atmospheric pressure range      700 hPa to 1060 hPa

This product is rated to operate at an altitude ≤3000m

### **TRANSPORT AND STORAGE ENVIRONMENT**

Ambient temperature range      -10 to 70 °C (14 to 158 °F).

Relative humidity                      10 to 90%, non-condensing.

Atmospheric pressure range      500 hPa to 1060 hPa

## **WARNING**

**Do not operate this system except in accordance with information included in this section, and any additional information provided by the manufacturer and / or competent safety authorities.**



## 1.5 CUSTOMER SUPPORT

Address any questions regarding GXR-SD/CSD/USD PREMIUM System to:

**DRGEM Corporation**

7Fl, E-B/D Gwangmyeong Techno-Park, 60 Haan-ro,

Gwangmyeong-si, Gyeonggi-do, 14322, Korea

TEL: +82-2-869-8566, FAX: +82-2-869-8567

E-mail: [cs@drgem.co.kr](mailto:cs@drgem.co.kr)

Web-site: <http://www.drgem.co.kr>



**Obelis s.a.,**

Bd.Général Wahis 53,1030 Brussels, Belgium

Tel) +32.2.732.59.54, Fax) +32.2.732.60.03

(This page intentionally left blank)

## 2. OPERATION PROCEDURE

This section describes the controls of the GXR-SD/CSD/USD PREMIUM System.

**WARNING**

No foreign objects which can attenuate or scatter the X-ray beam are allowed between x-ray tube and tabletop during exposure.  
Failure to follow this may result in serious injury.

The tube stand and patient table is intended to be used as part of a system for the intended generation of X-rays for diagnostic use.

X-rays generate a potential risk for both patients and operators.

For this reason, the application of X-rays for a given purpose must aim at the minimization of radiation exposure to any persons.

**WARNING**

Those persons responsible for the application must have the specific knowledge according to legal requirements and regulations and must establish safe exposure procedures for this kind of systems.

Those persons responsible for the planning and installation of this equipment must observe the national regulations.

Before starting the RADMAX software, turn on the Imaging Workstation.

Turn off the Imaging Workstation when all of your works are finished.

### 2.1 TURN ON THE SYSTEM

1. Supply main power to the system.
2. Turn on the monitor of Imaging Workstation.
3. Turn on the Imaging Workstation.
4. Turn on the GXR X-Ray generator.
5. Run the RADMAX software.
6. Wait until generator booting sequences are finished.

**NOTE**

IF THE BOOTING OF GXR GENERATOR IS NOT COMPLETED, THE GXR-SD/CSD/USD PREMIUM SYSTEM WILL NOT WORK.

## **2.2 EXAMINATION**

1. Patient registration.
2. Select APR for examination.
3. Set the radiographic stand positioning.
4. Change the collimation size if required.
5. Place the patient table if required.
6. Place the patient on the table or in front of the detector of the radiographic stand.
7. Trim the positioning if required.
8. Turn on the collimation lamp and confirm the x-ray field.
9. Make exposure. Press the exposure hand switch halfway and keep it pressed halfway, the X-ray tube will enter the prep mode. When the X-ray tube is ready and the patient is in correct position press the switch all the way to make the exposure.
10. Confirm the acquired digital image is correct and adjust the window width and level for the optimized view.
11. Transfer the image to the storage server if PACS is prepared.

## **2.3 TURN OFF THE SYTSTEM**

1. Turn off the generator.
2. Click on the 'Exit' menu on the RADMAX software.
3. Shutdown the Imaging Workstation.
4. Cut off the main power supply to the system.

### **3. RADMAX SOFTWARE**

For user instructions on RADMAX, refer to the RADMAX Operation Manual (RMD1804-001).

(This page intentionally left blank)

## 4. X-RAY CONTROL

RADMAX Software provides x-ray control GUI at procedure menu.

X-ray control GUI provides functions for x-ray parameter control and various status displays.

X-ray generator Control Panel is on the left-bottom side of Procedure interface for setting X-ray exposure condition. Generator Control Panel is used to change the value of exposure condition when procedure information was set.

The composition of screen is like below.

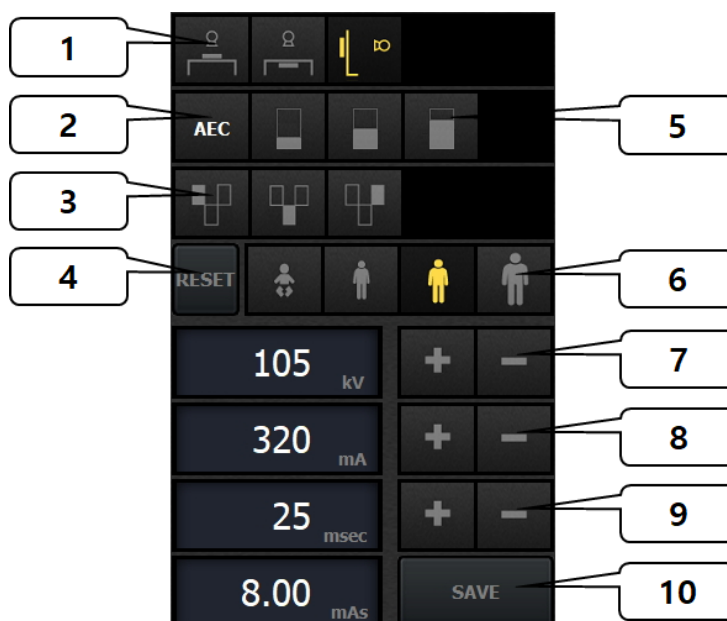

- 1) Bucky selection button
- 2) AEC on/off button
- 3) Field set button
- 4) Error Reset button
- 5) Screen set button
- 6) Patient size selection button
- 7) kV set button
- 8) mA set button
- 9) Time set button
- 10) Current condition save button

## 4.1 SAFETY NOTICE

X-ray radiation exposure may be damaging to health, with some effects being cumulative and extending over periods of many months or even years. **X-ray operators should avoid any exposure to the primary beam** and take protective measures to safeguard against scatter radiation. Scatter radiation is caused by any object in the path of the primary beam and may be of equal or less intensity than the primary beam that exposes the film.

- Wear protective clothing. Protective aprons with an equivalent of a minimum of 1/64" (0.35 mm) of lead are recommended.
- To protect the patient against radiation, always use radiation protection accessories in addition to devices which are fitted to the X-ray equipment.
- Keep as large a distance as possible away from the object being exposed and the X-ray tube assembly.
- Never operate this X-ray equipment in areas where there is a risk of explosion. Detergents and disinfectants, including those used on patients, may create explosive mixtures of gases. Please observe the relevant regulations.
- The operator console, or anything electrically connected to it, must never be used within 6 ft (1.8 m) of the patient environment.
- Do not place liquids (coffee, beverages, flowers, etc) on the control console.
- Always ensure adequate ventilation around the control console and generator main cabinet. Do not operate the equipment near curtains, drapes, etc which may block the ventilation slots.
- Do not operate the console or generator main cabinet in direct sunlight or near any heat sources.
- Do not operate the console near strong magnetic fields (microwave ovens, speakers, etc), and avoid routing the console cables near these devices.
- The console and generator main cabinet must be operated in locations that are clean (free of excess dust, dirt, debris, etc), stable (free of vibration), and secure such that the console cannot slip or tip.

**CAUTION**

**INCORRECT CONNECTIONS OR USE OF UNAPPROVED EQUIPMENT MAY RESULT IN INJURY OR EQUIPMENT DAMAGE.**

**WARNING**

**THIS X-RAY UNIT MAY BE DANGEROUS TO PATIENT AND OPERATOR UNLESS SAFE EXPOSURE FACTORS AND OPERATING INSTRUCTIONS ARE OBSERVED.**



PROPER USE AND SAFE OPERATING PRACTICES WITH RESPECT TO X-RAY GENERATORS ARE THE RESPONSIBILITY OF THE USERS OF SUCH GENERATORS.

DRGEM CORP. PROVIDES INFORMATION ON ITS PRODUCTS AND ASSOCIATED HAZARDS, BUT ASSUMES NO RESPONSIBILITIES FOR AFTER-SALE OPERATING AND SAFETY PRACTICES.

**WARNING**

DRGEM CORP. ACCEPTS NO RESPONSIBILITY FOR ANY GENERATOR NOT MAINTAINED OR SERVICED ACCORDING TO THE SERVICE MANUAL OR ANY GENERATOR THAT HAS BEEN MODIFIED IN ANY WAY.

DRGEM CORP. ALSO ASSUMES NO RESPONSIBILITY FOR X-RAY RADIATION OVEREXPOSURE OF PATIENTS OR PERSONNEL RESULTING FROM POOR OPERATING TECHNIQUES OR PROCEDURES.

**CAUTION**

DO NOT EXCEED THE TUBE MAXIMUM OPERATING LIMITS SHOWN IN THE X-RAY TUBE DATA SECTION AT THE END OF THE OPERATOR'S MANUAL. INTENDED LIFE AND RELIABILITY WILL NOT BE OBTAINED UNLESS GENERATORS ARE OPERATED WITHIN PUBLISHED SPECIFICATIONS.

## 4.2 GENERATOR DUTY CYCLE LIMIT

**NOTE**

THE FOLLOWING SECTION CONTAINS IMPORTANT INFORMATION. PLEASE READ AND UNDERSTAND THIS MATERIAL BEFORE CONTINUING.

Internal X-ray generator components will heat up during normal use of the generator. This is similar to X-ray tube heating during normal generator operation. The amount of heat produced is proportional to the product of kV, mA, and time.

DRGEM X-ray generators are designed to operate with the majority of X-ray tubes over their rated power ranges. They are designed for operating duty cycles **consistent with practical patient examination routines that allow for reasonable cooling intervals between X-ray exposures**. Insufficient cooling time between exposures may lead to excessive heat build - up in the generator, which may cause serious generator damage.

THIS X-RAY GENERATOR HAS TEMPERATURE MONITORING OF POWER-STACK TO PROTECT THE EXCESSIVE HEAT BUILD-UP.

**CAUTION**

IF THE GENERATOR DETECTS THE OVER-HEAT OF POWER-STACK, AN ERROR CODE "E04" OR "E05" WILL BE DISPLAYED. EXPOSURE WILL BE INHIBITED WHEN THIS MESSAGE IS DISPLAYED, AND IT SHOULD BE UNDERSTOOD THAT CONTINUING TO MAKE EXPOSURES MIGHT CAUSE GENERATOR DAMAGE DUE TO OVERHEATING. THE GNERATOR SHOULD BE ALLOWED TO COOL SUFFICIENTLY SUCH THAT THIS MESSAGE IS NO LONGER DISPLAYED.

### 4.3 DAILY X-RAY TUBE WARM-UP PROCEDURE

**WARNING**

THE FOLLOWING PROCEDURE PRODUCES X-RAYS.  
OBSERVE ALL SAFETY PRECAUTIONS TO PROTECT PERSONNEL.

Use this procedure when the generator has not been used for several days. This procedure provides for exposures at medium power before the tube is used at maximum mA or kV values. This will reduce the possibility of damaging the anode and high voltage components. No test setup is required.

For maximum stability and reliability, use the following techniques at start up:

Select the following:

- Large focal spot.
- 80 kV.
- Normal 50/60 Hz anode rotation.

For a 300 kHU to a 400 kHU tube, use approximately 80 mAs per exposure.

For a 200 kHU to 300 kHU tube, use approximately 64 mAs per exposure.

For a below 200 kHU tube, use approximately 50 mAs per exposure.

Depending on the X-ray tube power rating, select either 100 mA or 200 mA.

Make three to five exposures (depending on tube loading) at 30 second intervals.

### 4.4 GENERATOR INTERFACE MODULE

RADMAX Software provides generator interface module to control x-ray generator by the workstation. This module has power on and off switches of system, and has exposure hand-switch.

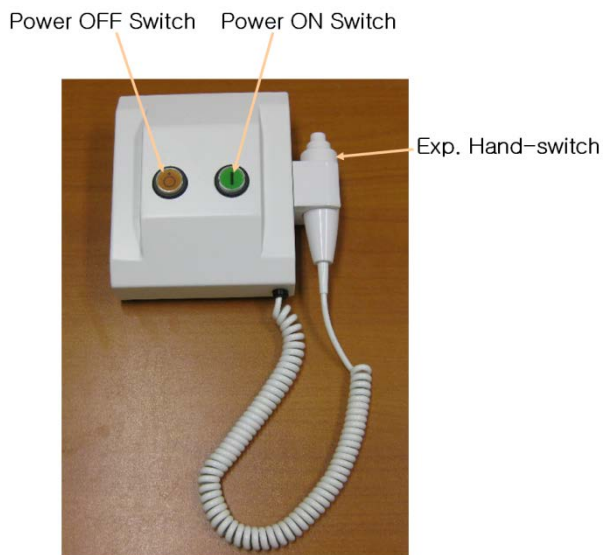
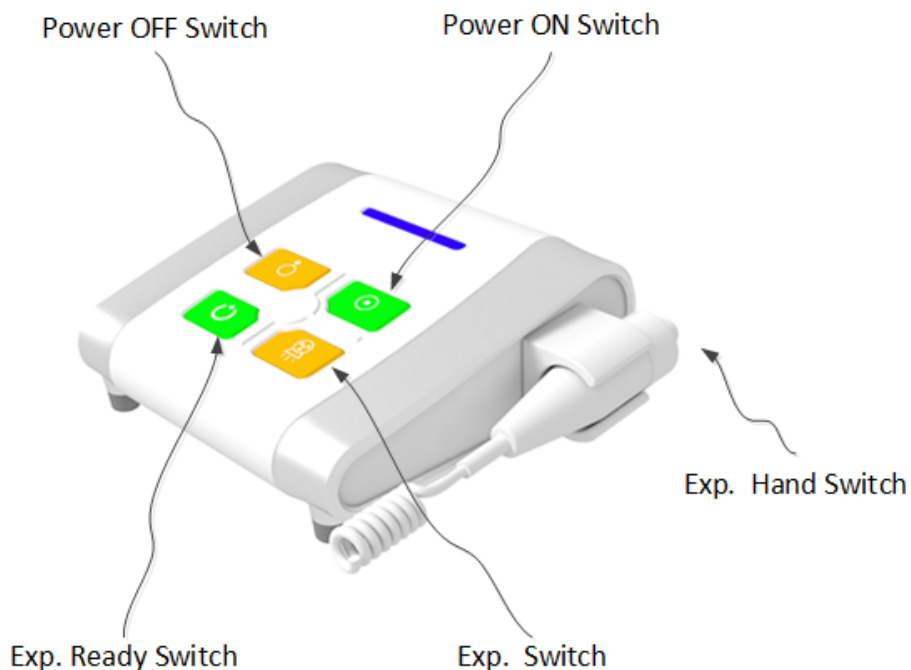

## 4.5 CONSOLE CONTROLS

### 4.5.1 POWER ON/OFF CONTROLS



Press **ON**  of generator interface module to turn on the GXR-SD/CSD/USD PREMIUM System.

Around 10 seconds later, all data will display normally if there is no problem on turning on.



Press **OFF**  of generator interface module to turn off the GXR-SD/CSD/USD PREMIUM System.



Press the  button to continue if any error messages are presented.

### 4.5.2 INDICATOR

Each function of indicator is like below.



- (1) Small/Large Focal spot size indicator
- (2) Error Indicator
- (3) Warning Indicator
- (4) Prepare Indicator
- (5) X-ray Exposure Indicator
- (6) Tube HU (Heat Unit) Indicator

### 4.5.3 PROCEDURE DISPLAY

The procedure display window displays information of selected procedure in imaging software for examination.

### 4.5.4 PREP, X-RAY EXPOSURE CONTROL

The dead-man type exposure hand-switch is located at side of the generator interface module. To make an x-ray exposure, release from the switch holder and press the buttons like following operating sequences.

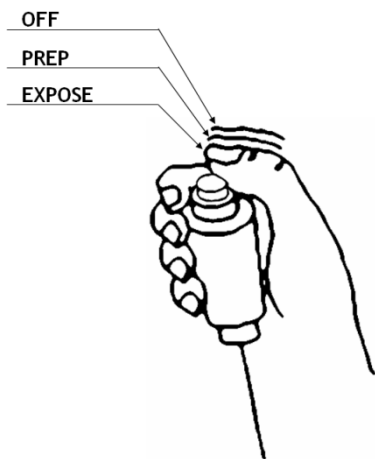

Press and hold the **PREP** button to spin the rotor.

Status window displays 'x-ray preparation' message.

The **prep indicator**  will light and status window displays 'X-ray exposure ready' message when ready to make an exposure.

While pressing the prep button, press and hold the **EXPOSE** button to make an X-ray exposure.

The **X-ray exposure indicator**  will light and status window displays 'X-ray exposure' message when an X-ray exposure is being taken.

Pressing the **EXPOSE** button only will cycle the generator through prep and then exposure.

After the exposure, status window displays 'X-ray exposed' message.

### 4.5.5 RADIOGRAPHY CONTROLS

1. X-ray parameters Control Button

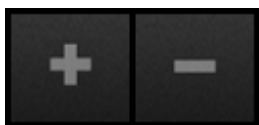

Increase or decrease the x-ray parameters.

kV, mA, exposure time, Density

- Console display Density when AEC is selected.

The density range is -8 to +8.

## 2. Image Receptor Selection Buttons



Press this button to select the Non-Bucky image receptor.

(Usually means not used in table nor wall stand and this can be assignable)

The adjacent indicator will light.



Press this button to select the Bucky1 image receptor.

(Usually means table Bucky and this can be assignable)

The adjacent indicator will light.

Usually, this button is used to table Bucky.

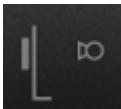

Press this button to select the Bucky2 image receptor.

(Usually means vertical wall Bucky and this can be assignable)

The adjacent indicator will light.

Usually, this button is used to wall Bucky.

**WARNING**

**WRONG SELECTION BY THE OPERATOR MAY RESULT THE REEXAMINATION OF THE PATIENT.**

## 3. Patient Size Selection Button



When the patient size is selected, the X-ray conditions are changed to the APR conditions of the selected patient size.

4. AEC On/Off Button





Pressing AEC button allows operator to use AEC function. Selected button lights up and previous AEC field combination & screen speed used before is selected automatically.

5. AEC Screen Speed Selection Button

If the AEC feature is saved to be used with Procedure, the selection of APR will automatically select stored Screen speed and AEC field combination.

Pressing the button with lighted will turn off AEC feature.



-  (Slow, Low Sensitivity)
-  (Middle, Medium Sensitivity)
-  (Fast, High Sensitivity)

6. AEC Field Selection Button



When AEC function is selected by pressing screen speed button, AEC Field can be selected by pressing the specific field positions.

Once selected, the FIELD button will light on. Field selection is possible within three fields, and minimum one field should be selected.

To cancel the selected field, press the field button once.

7. Save Button

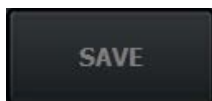



When the SAVE button is selected, the current X-ray conditions are stored in the APR conditions of the selected patient size. kV, mA, exposure time, and Bucky information are stored. If AEC is on, field, scene speed, and density are also saved.

8. Focal Spot Size Indicator

Focal spot size indicator shows currently selected x-ray tube focal spot size.



-  for small focus.
-  for large focus.

RADMAX Software’s x-ray generator support auto focal spot selection feature and small focus will be selected if the selected x-ray parameter is in the possible range of small focus.

Indicator of selected focus will blink and X-ray exposure is unavailable for 2 cases below.

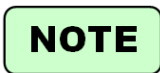

- When focal spot size has changed, generator requires filament preheat time for selected focus. Filament preheat time is about 4 seconds.
- When X-ray exposed over 100mAs, generator requires cooling time of IGBT in proportional to mA step and mAs.

9. Anode Heat Unit Indicator

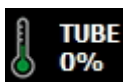

Console displays the tube anode heat unit in percentage.

An anode HU warning message will be displayed at programmed safety level; typically 75 % of the tube anode HU rating.

An anode HU Error message (E18) will be displayed at programmed safety level; typically 90 % of the maximum tube anode HU rating and exposures will be inhibited.



### 4.5.6 STATE MESSAGE DISPLAY

State message window displays state message, warning message and error message.

Normal	Displayed after initialized and indicate generator is normal.
X-ray Preparation...	Displayed when prep state is active.
X-ray Exposure Ready	Displayed when generator is ready to expose
X-ray Exposure	Displayed when x-ray exposure
X-ray Exposed	Displayed after x-ray exposure during 1 second

#### 1. Warning Message

Warning message is issued to warn the operator of generation of troubles which is not critical for the system operation except 'HU Warning Level'.

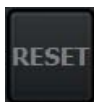

Therefore, it is not necessary to press  button when Warning message appears.



When the Warning message is issued, warning indicator  is turned on for 4 second before the message disappears.

Refer to Service Manual about warning messages.

#### 2. -Error Message

The GXR console will display error messages during abnormal operation of the generator.



When error occurs, error indicator  is turns on with alarm sound.



Messages may be cleared by pressing the  button.

If the error message is not cleared or following corrective actions are not working, contact the service representative.

Refer to Service Manual about error messages.

### 4.5.7 COLLIMATOR CONTROL

The system equipped with auto collimator can control lamp on/off and collimation size.

#### 1. LAMP CONTROL





Select the  button to turn the lamp On / Off.

#### 2. COLLIMATION SIZE CONTROL



If you select the  button, a list of collimation size appears below. When you select the size, the collimation size of the collimator is changed.

			
<b>AUTO</b>	<b>MANUAL</b>	<b>7x10</b>	<b>10x7</b>
<b>8x10</b>	<b>10x8</b>	<b>10x12</b>	<b>12x10</b>
<b>12x16</b>	<b>16x12</b>	<b>7x17</b>	<b>17x7</b>
<b>14x14</b>	<b>14x17</b>	<b>17x14</b>	<b>17x17</b>

“AUTO” means to set the collimation size stored in the database of the selected procedure step.

“MANUAL” means to set the selected collimation size. Even if the procedure step is changed, the selected size remains unchanged.





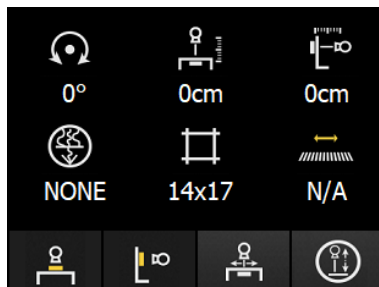







### 4.5.8 SYSTEM STATUS INDICATOR

The system status information is displayed as shown below.



The meaning of each icon is as follows.

	Tube rotation angle
	Table SID
	Wall stand SID
	Auto filter selection indicator
	Auto collimation size indicator
	N/A
	Table detector indicator
	Wall stand detector indicator
	Table bucky Tracking selection & indicator
	Table vertical sync. selection & indicator
	Wall stand vertical sync. selection & indicator

		Stop Status
		Operation Status
		Limit Status
		Stop Status
		Operation Status
		Limit Status
		Stop Status
		Operation Status
		Limit Status

## 5. APPARATUS OPERATION

### 5.1 TUBE STAND (TS-FM6, TS\_FC6, TS\_FC4 - Vertical Motorized MOVEMENT)

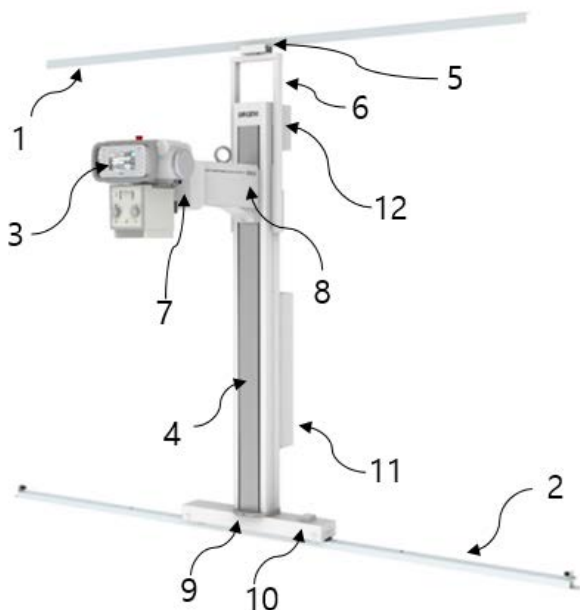

- 1 Ceiling Rail (TS-FM6 optional)
- 2 Floor Rail with stopper rubber
- 3 Stand console
- 4 Vertical Stand
- 5 Ceiling rotation part (TS-FM6 optional)
- 6 Ceiling support (TS-FM6 optional)
- 7 Arm
- 8 Arm support
- 9 Stand rotation part
- 10 Stand rotation lock pedal
- 11 Controls Box
- 12 Motor

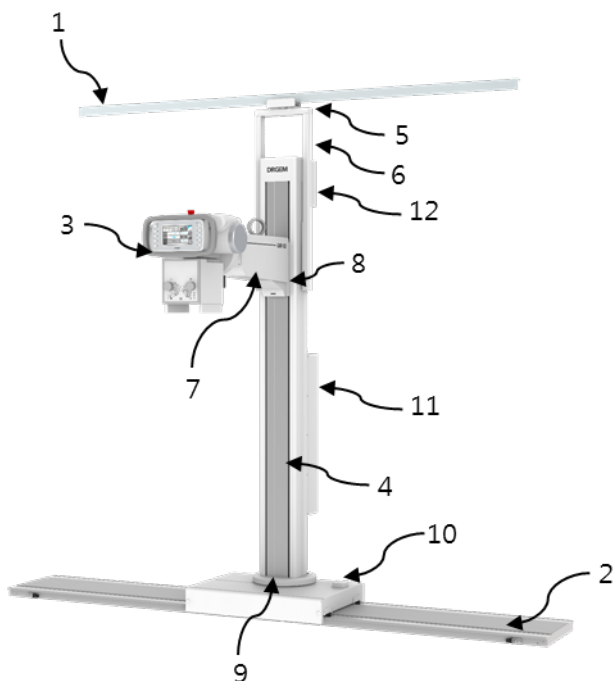

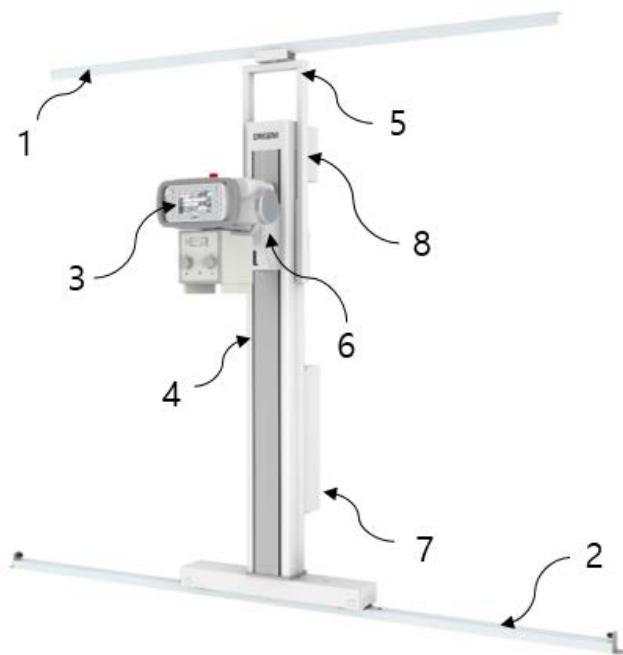

- 1 Ceiling Rail
- 2 Floor Rail with stopper rubber
- 3 Stand console
- 4 Vertical Stand
- 5 Ceiling support
- 6 Arm support
- 7 Controls Box
- 8 Motor
- 9 Emergency Switch
- 10 Touch Screen LCD with Indicators and Controls
- 11 Control Button
- 12 X-ray Tube assembly
- 13 Line Laser
- 14 Motorized collimator
- 15 Safety Sensor



**NOTE**

The sensing distance of safety sensor is 4 ~ 40cm

Tube Head Control Button (Option: Motorized Tube Rotation - TS\_FM6, TS\_FC6)



- 1. Remote control sensor
- 2. Longitudinal lock release
- 3. Transverse lock release
- 4. Transverse center auto detent
- 5. Tube rotation
- 6. Line laser on/off (Option : Motorized Tube Rotation (CW))
- 7. Vertical lock release
- 8. Vertical motorized up
- 9. Vertical motorized down
- 10. All lock release
- 11. Tube Rotation by column axis (Option: Motorized Tube Rotation (CW))

System control menu (Tube head with manual Type)

Horizontal system control menu

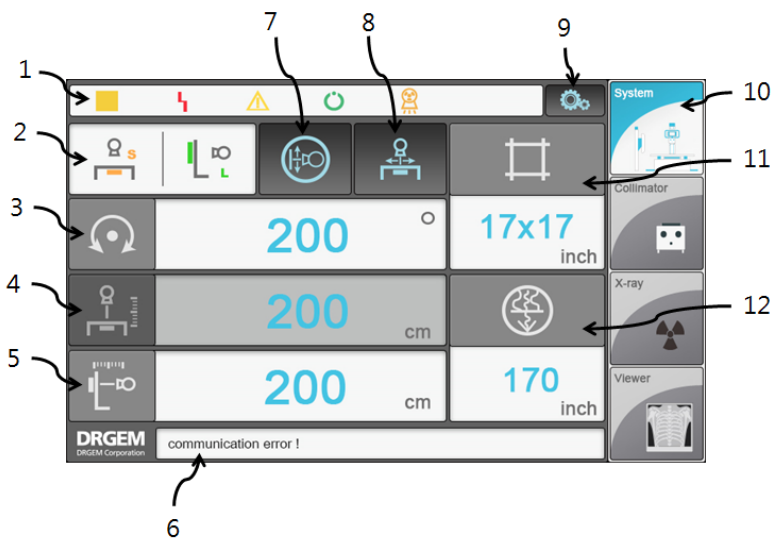

Vertical system control menu

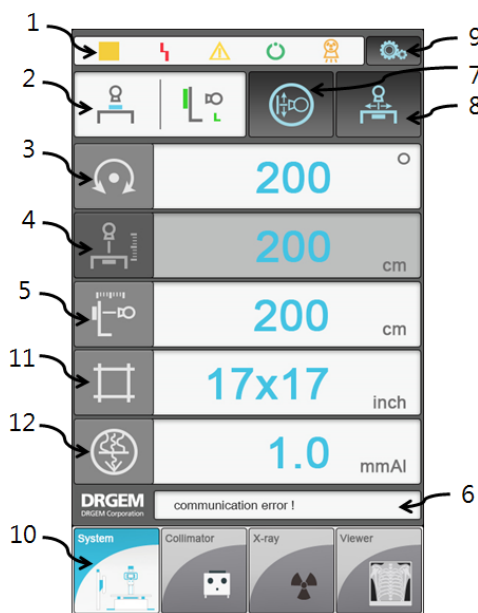

- |   |   |
|---|---|
| 1. Generator indicator                  | 2. Detector indicator                         |
| 3. Tube rotation angle                  | 4. Table SID                                  |
| 5. Wall stand SID                       | 6. Message indicator                          |
| 7. Vertical sync. selection & indicator | 8. Table bucky Tracking selection & indicator |
| 9. Setting                              | 10. System Menu                               |
| 11. Auto collimation size indicator     | 12. Auto filter selection indicator           |



System Control menu (Tube head with motorized tube rotation Type)

Horizontal system control menu

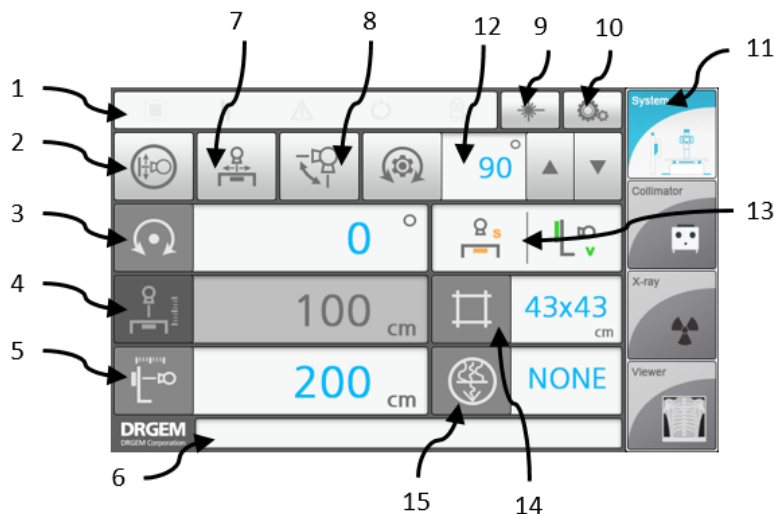

Vertical system control menu

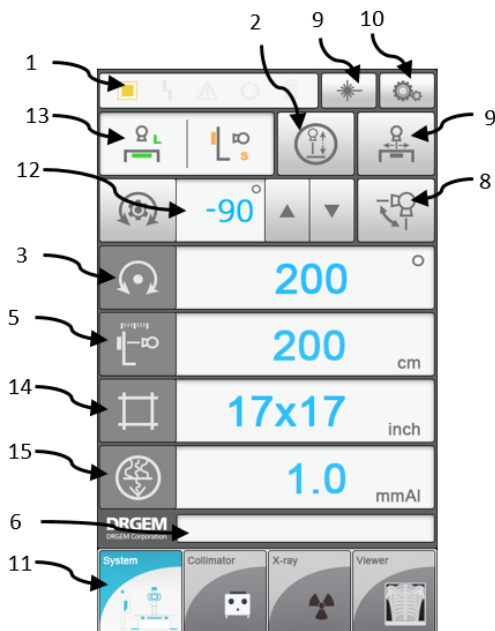

- |   |   |
|---|---|
| 1. Generator indicator                        | 2. Vertical sync. selection & indicator               |
| 3. Tube rotation angle                        | 4. Table SID  |
| 5. Wall stand SID                             | 6. Message indicator                                  |
| 7. Table Bucky Tracking selection & indicator | 8. Auto tube head rotation control (0 → 90°, 90 → 0°) |
| 9. Laser On/Off                               | 10. Setting   |
| 11. System Menu                               | 12. Tube head rotation control                        |
| 13. Detector indicator                        | 14. Auto collimation size indicator                   |
| 15. Auto filter selection indicator           |   |

Collimator menu (Tube head with manual Type)

Horizontal auto filter selection & indicator

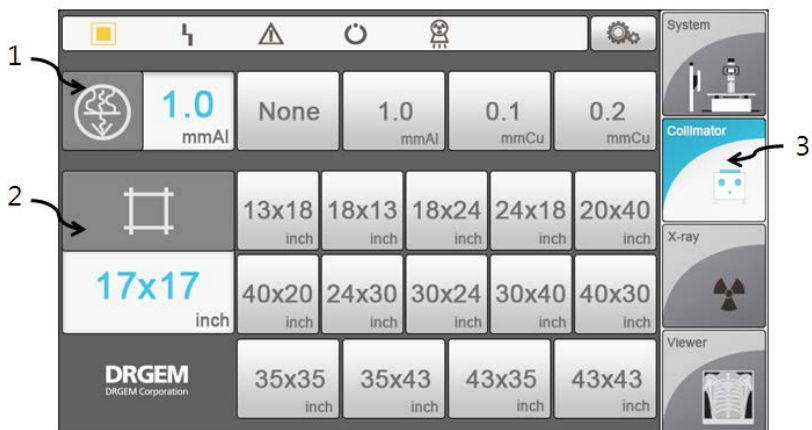

Vertical auto filter selection & indicator

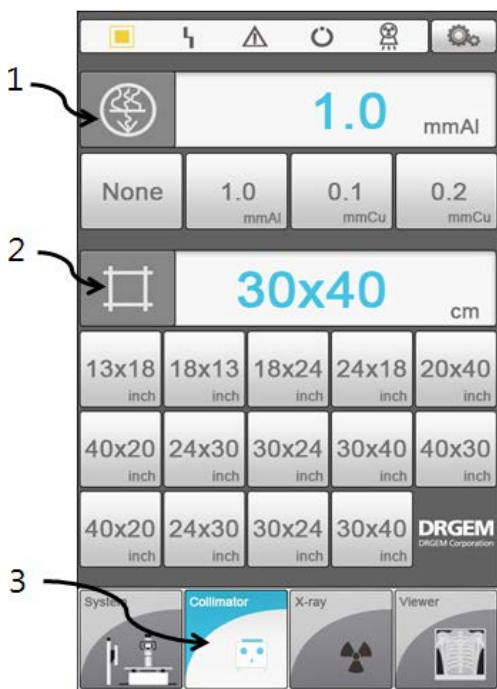

- 1. Auto filter selection & indicator
- 3. Auto collimation menu(Optional)

- 2. Auto collimation size selection & indicator

Collimator menu (Tube head with motorized tube rotation Type)

Horizontal auto filter selection & indicator



Vertical auto filter selection & indicator

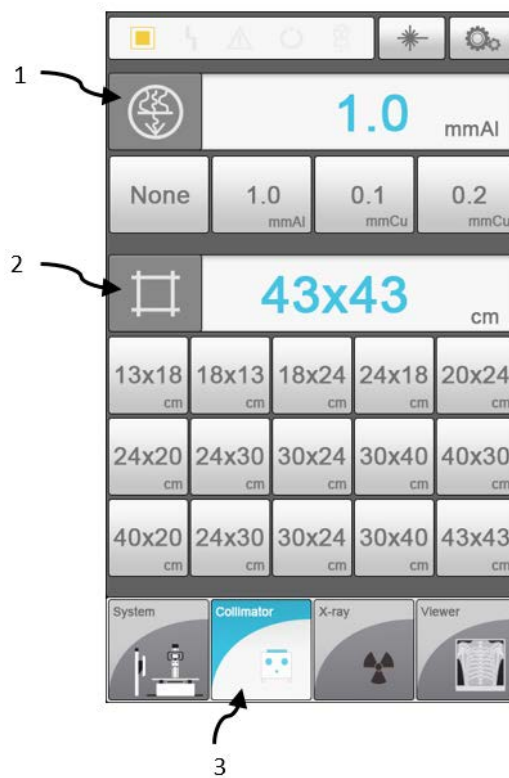

1. Auto filter selection & indicator

2. Auto collimation size selection & indicator

3. Auto collimation menu(Option)

X-ray menu (Tube head with manual Type )  
Horizontal X-ray generator selection & indicator

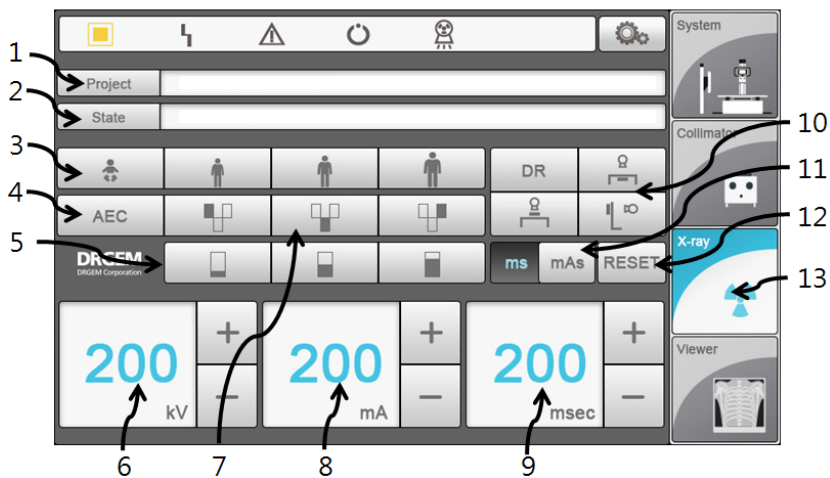

Vertical X-ray generator selection & indicator

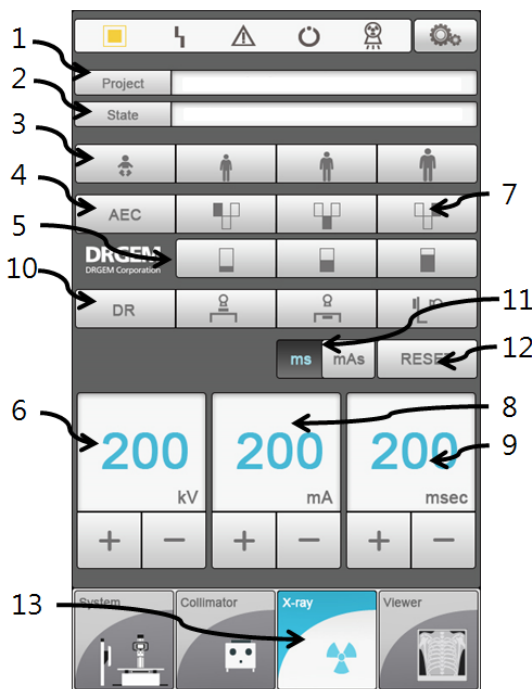

- |  |                                 |
|--|---------------------------------|
| 1. Projection                              | 2. Generator state              |
| 3. Patient Body Size selection & indicator | 4. AEC selection & indicator    |
| 5. screen selection & indicator            | 6. KV set & indicator           |
| 7. Field selection & indicator             | 8. mA set & indicator           |
| 9. Time set & indicator                    | 10. Bucky selection & indicator |
| 11. Time/mAs selection & indicator         | 12. Error reset button          |
| 13. X-ray generator menu                   |                                 |

X-ray menu (Tube head with motorized tube rotation Type)

Horizontal X-ray generator selection & indicator

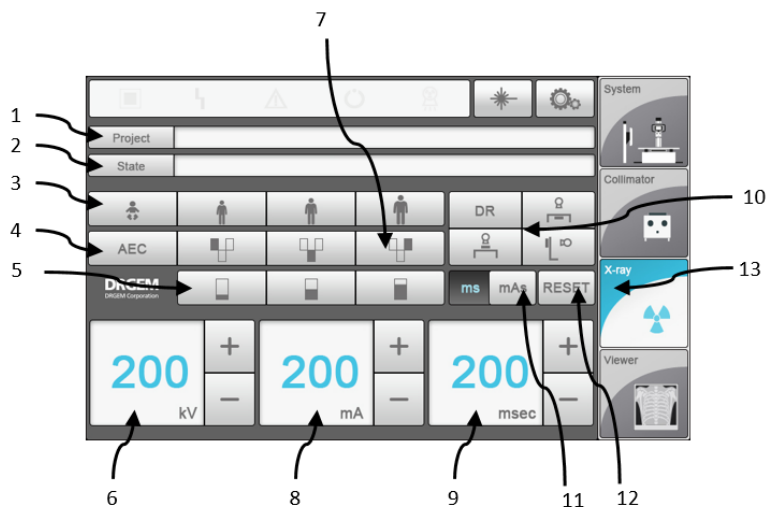

Vertical X-ray generator selection & indicator

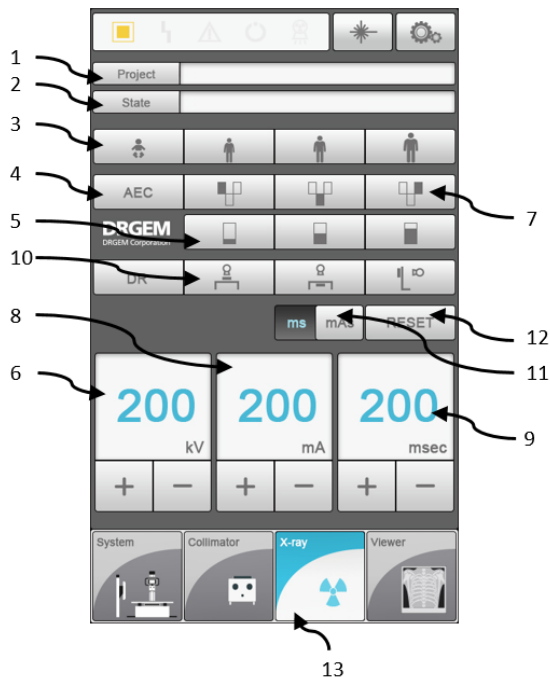

- |  |                                 |
|--|---------------------------------|
| 1. Projection                              | 2. Generator state              |
| 3. Patient Body Size selection & indicator | 4. AEC selection & indicator    |
| 5. screen selection & indicator            | 6. KV set & indicator           |
| 7. Field selection & indicator             | 8. mA set & indicator           |
| 9. Time set & indicator                    | 10. Bucky selection & indicator |
| 11. Time/mAs selection & indicator         | 12. Error reset button          |
| 13. X-ray generator menu                   |                                 |

Viewer menu (Tube head with motorized tube rotation Type and Tube head with manual Type)

Horizontal DR Image viewer

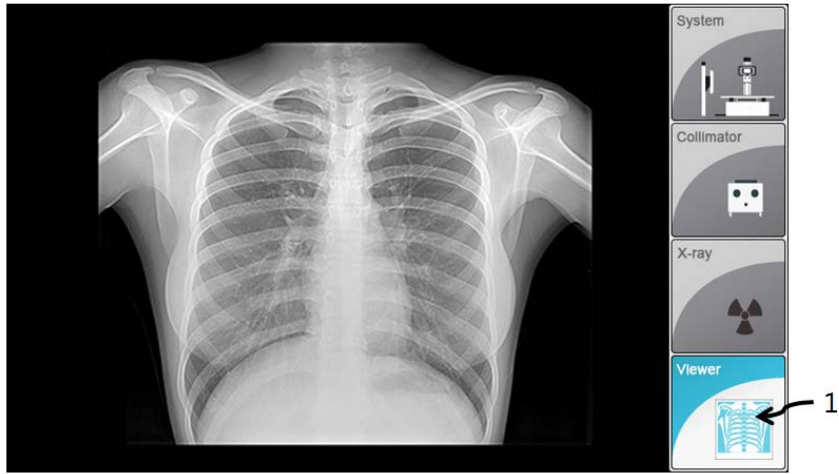

Vertical DR Image viewer

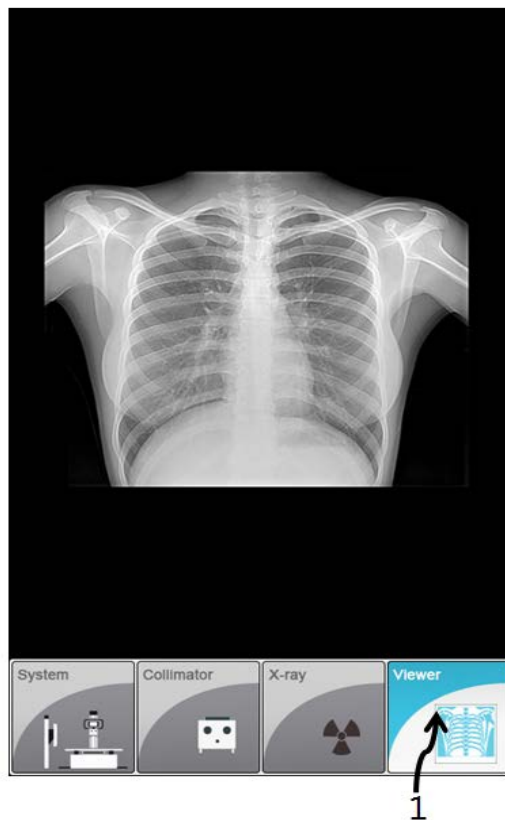

1. DR Image Viewer menu

### 5.2 TUBE STAND (TS-FC2-Vertical Motorized Movement)

1. Tube Stand (Model: TS-FC2, Motorized, Right angle)

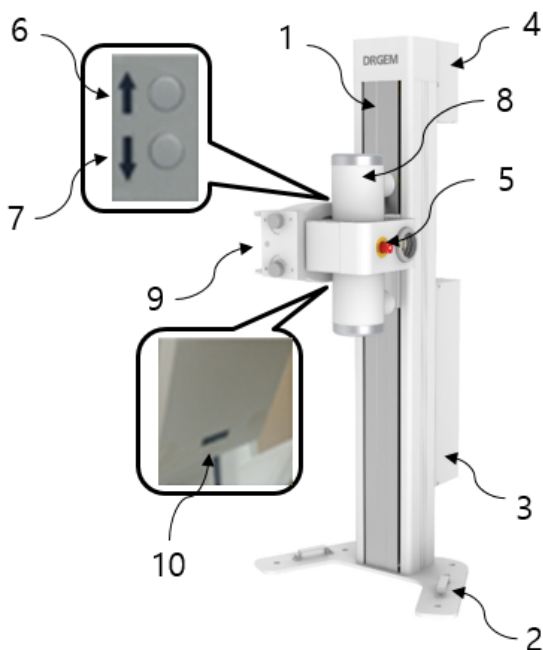

- 1 Vertical stand
- 2 Stand base
- 3 Control Box
- 4 Rear wall support location and motor
- 5 Emergency switch
- 6 Vertical UP Button
- 7 Vertical DOWN Button
- 8 Tube
- 9 Collimator
- 10 Safety Sensor

2. Tube Stand (Model: TS-FC2, Motorized, Straight)

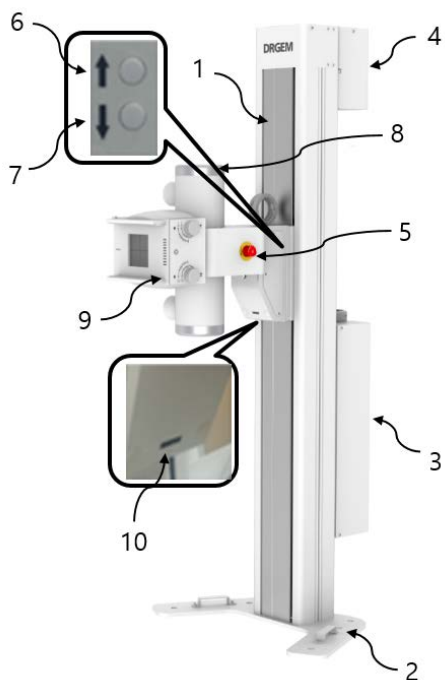

- 1 Vertical stand
- 2 Stand support (Wall)
- 3 Control Box
- 4 Stand support (Floor)
- 5 Emergency switch
- 6 Vertical UP Button
- 7 Vertical DOWN Button
- 8 Tube
- 9 Collimator
- 10 Safety Sensor

### 5.3 TUBE STAND (TS-CSA)

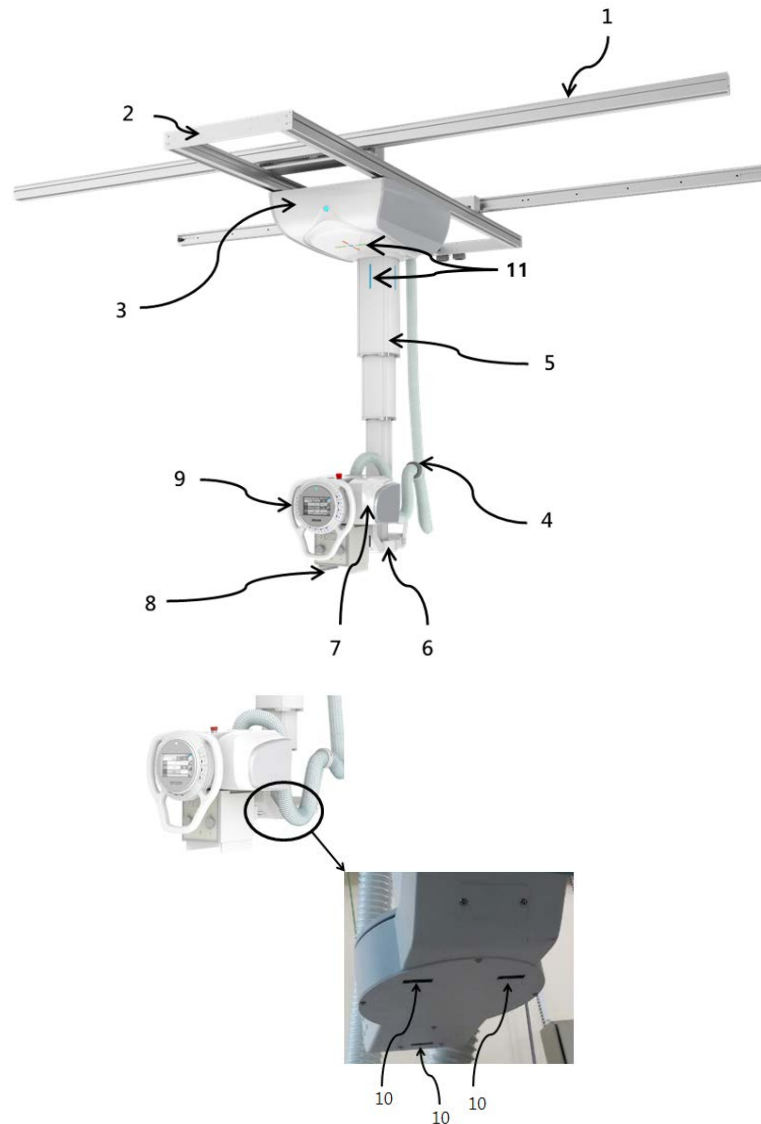

- |   |   |
|---|---|
| 1. Longitudinal rail                                  | 2. Transverse rail                          |
| 3. Main Body & Transverse carriage                    | 4. Duct hose, Cable holder                  |
| 5. Telescoping tube arm                               | 6. Tube support arm(Tube arm rotation part) |
| 7. X-ray Tube   | 8. Collimator                               |
| 9. Operation panel with handle                        | 10. Safety Sensor                           |
| 11. Control position color (Same as switch LED color) |   |
| - Vertical: Blue                                      |   |
| - Longitudinal: Green                                 |   |
| - Transverse: Orange                                  |   |



**NOTE**

The sensing distance of safety sensor is 4 ~ 40cm

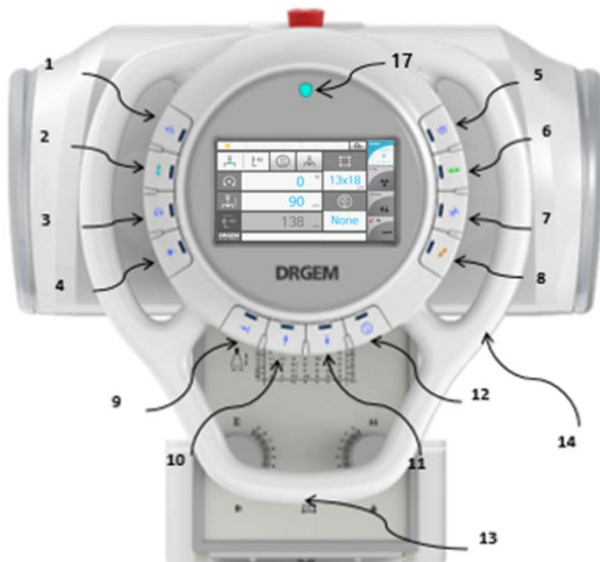

<Manual tube rotation type>

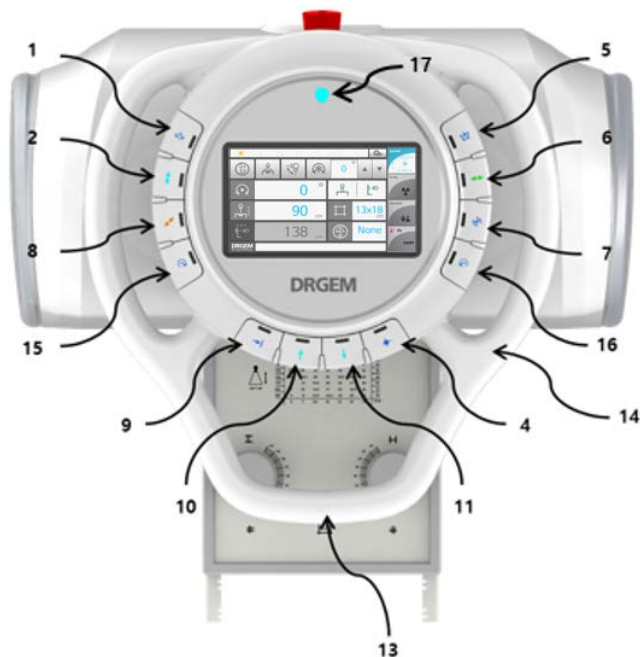

<Motorized tube rotation type>

- 1 Column Rotation (vertical axis)
- 2 Vertical Movement (Manual)
- 3 Tube Rotation (horizontal axis)  
(Only Manual tube rotation type)
- 4 Line Laser on/off
- 5 Auto Detent on/off
- 6 Longitudinal Movement
- 7 All Lock Release
- 8 Transverse Movement
- 9 Auto Parking
- 10 Motorized Vertical Up
- 11 Motorized Vertical Down
- 12 Vertical Sync. Selection & indicator  
(Only Manual tube rotation type)
- 13 All Lock Release
- 14 Operating handle
- 15 Motorized Tube Rotation(CW)  
(Only Motorized tube rotation type)
- 16 Motorized Tube Rotation (CCW)  
(Only Motorized tube rotation type)
- 17 System State LED

System control menu

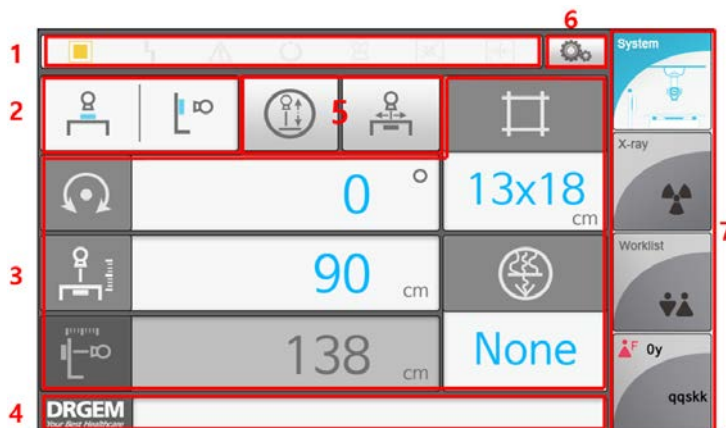

<Manual tube rotation type>

- 1. Generator & Detent state indicator
- 2. Detector state indicator
- 3. Position information
- 4. Message box

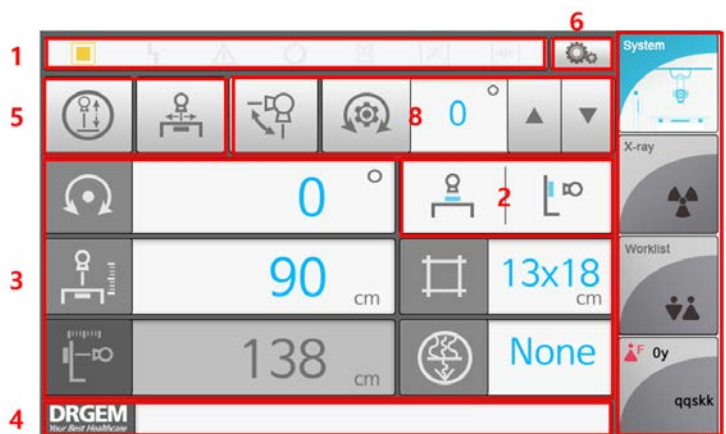

<Motorized tube rotation type>

- 5. Vertical sync & table tracking function
- 6. Configuration
- 7. Menu
- 8. Motorized tube rotation function

\* Vertical synchronization and Table Bucky tracking is available when this option is applied.

Auto filter selection & indicator Menu

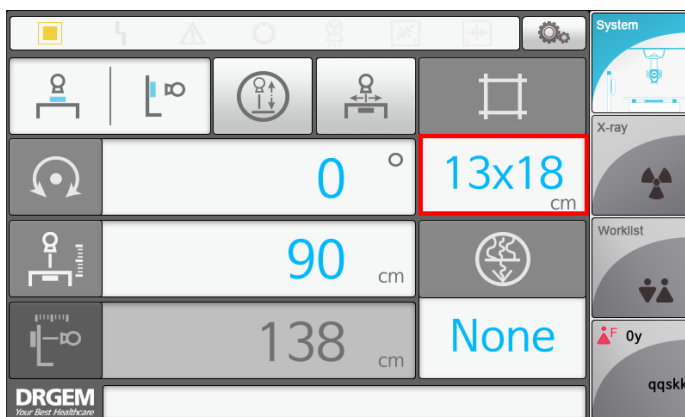
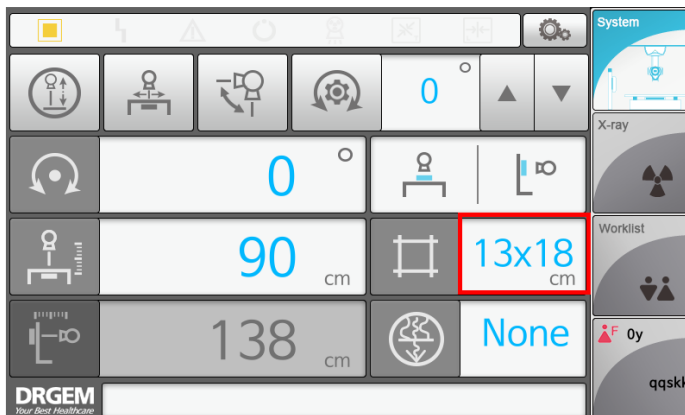

If touch red box area, screen changes to Collimator and Filter control menu like below.



1. Auto filter selection & indicator

2. Auto collimation size selection & indicator

X-ray generator selection & indicator



1. Projection
2. Generator state
3. Patient Body Size selection & indicator
4. AEC selection & indicator
5. Time/mAs selection & indicator
6. screen selection & indicator
7. AEC field selection & indicator
8. KV set & indicator
9. mA set & indicator
10. Exposure. Time set & indicator
11. Bucky selection & indicator
12. Error reset button

Worklist



Search: Load Latest patient.

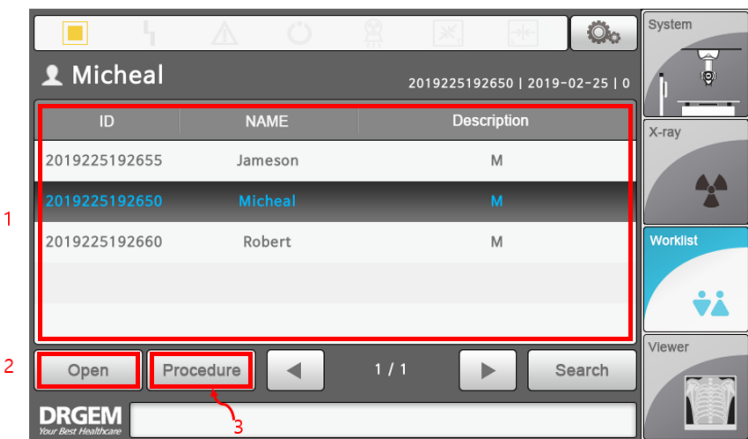

- 1. Patient ID, NAME, Description
- 2. Open study list and step list
- 3. Procedure

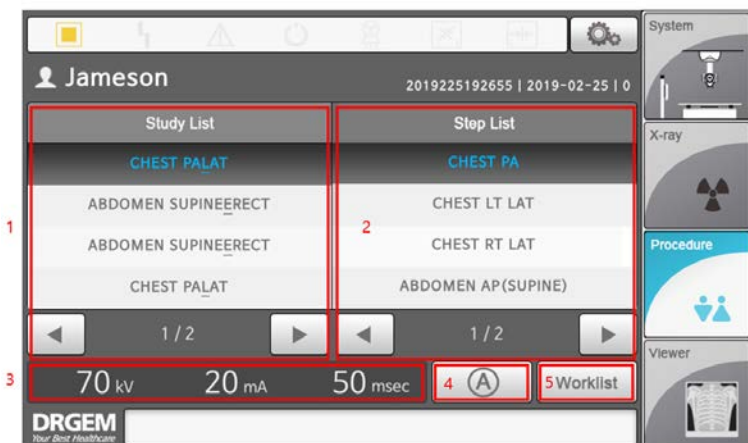

- 1. Study List
- 2. Step List
- 3. Display kV, mA, msec
- 4. Operate Auto Position Function
- 5. Worklist

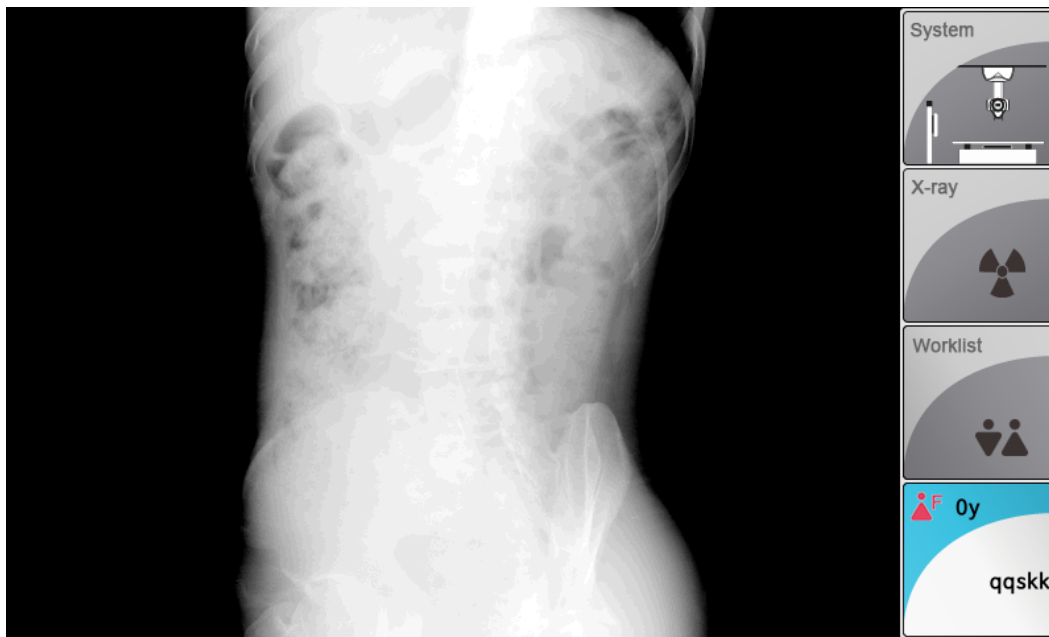
DR Image viewer

## 1. DR Image Viewer menu

\* Available when imaging software support this function

**CAUTION**

Emergency Stop Switch is located at the top of the tube as below

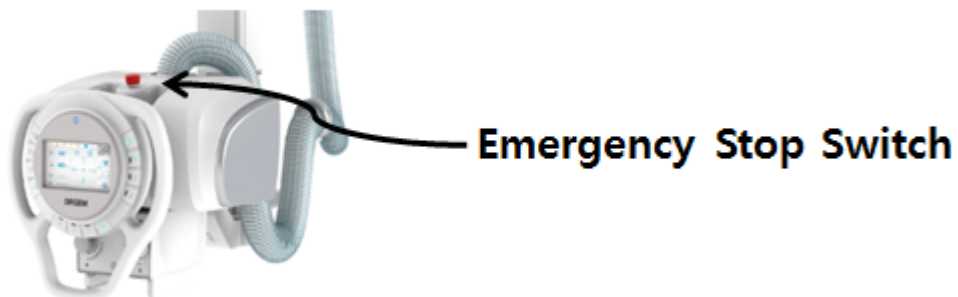

### 5.4 TUBE STAND (TS-CSP)

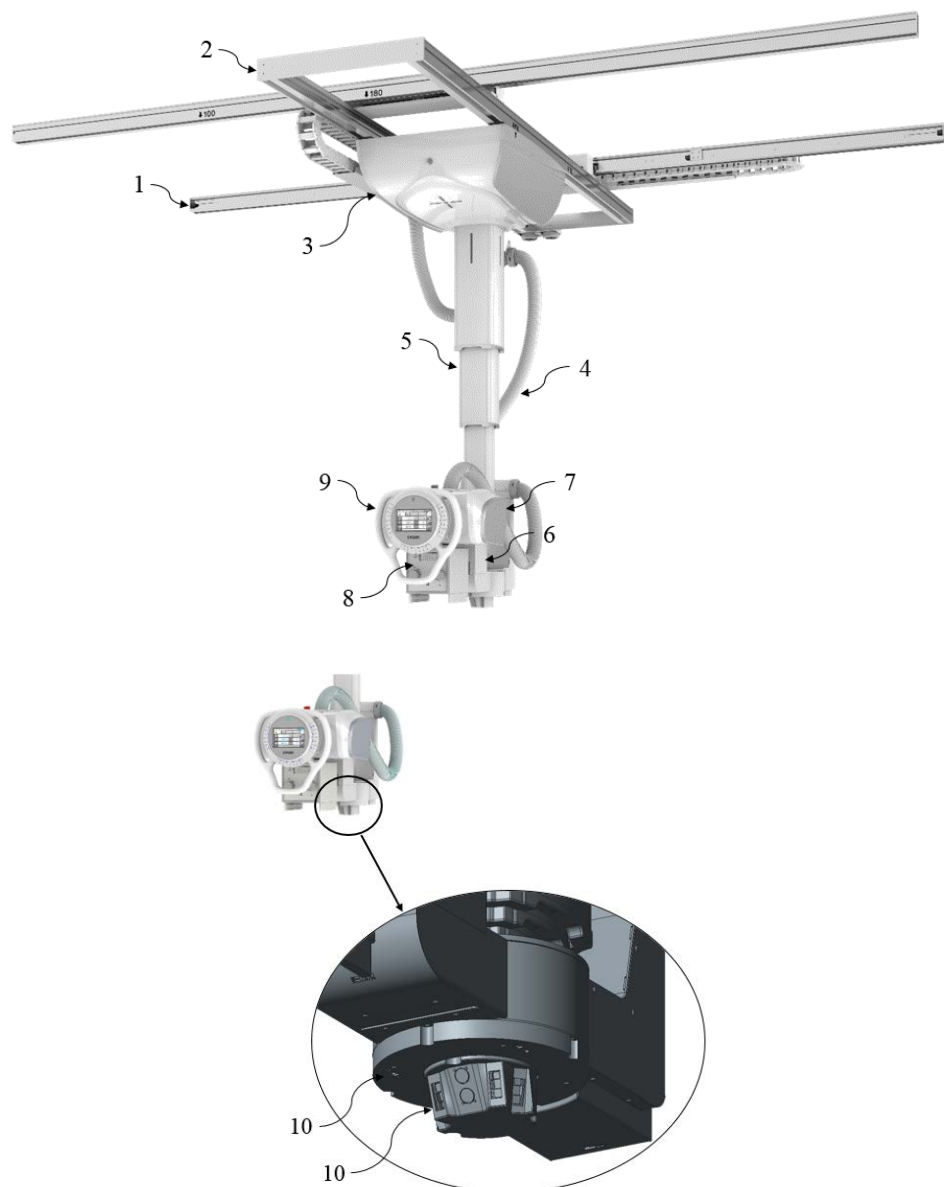

- |                                    |   |
|------------------------------------|---|
| 1. Longitudinal rail               | 2. Lateral rail & Transverse bridge         |
| 3. Main Body & Transverse carriage | 4. Duct hose, Cable holder                  |
| 5. Telescoping tube arm            | 6. Tube support arm(Tube arm rotation part) |
| 7. X-ray Tube                      | 8. Collimator                               |
| 9. Operation panel with handle     | 10. Safety Sensor                           |

**NOTE**

The sensing distance of safety sensor is 4 ~ 40cm

Tube head with manual tube rotation and vertical motorized movement

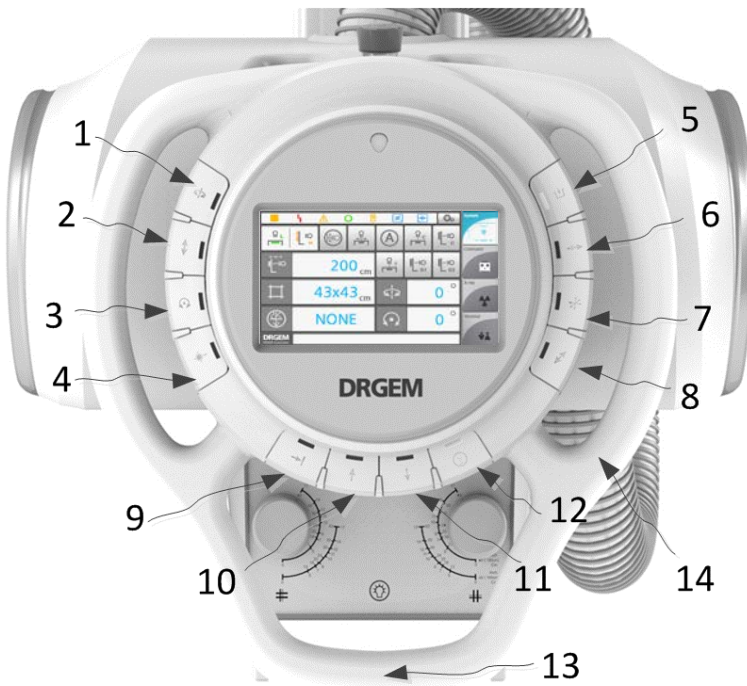

- 1 Column Rotation (vertical axis)
- 2 Vertical Movement (Manual)
- 3 Tube Rotation (horizontal axis)
- 4 Line Laser on/off
- 5 Auto Detent on/off
- 6 Longitudinal Movement
- 7 All Lock Release
- 8 Transverse Movement
- 9 Auto Parking
- 10 Motorized Vertical Up
- 11 Motorized Vertical Down
- 12 Vertical Sync. Selection & indicator
- 13 All Lock Release
- 14 Operating handle



System control menu

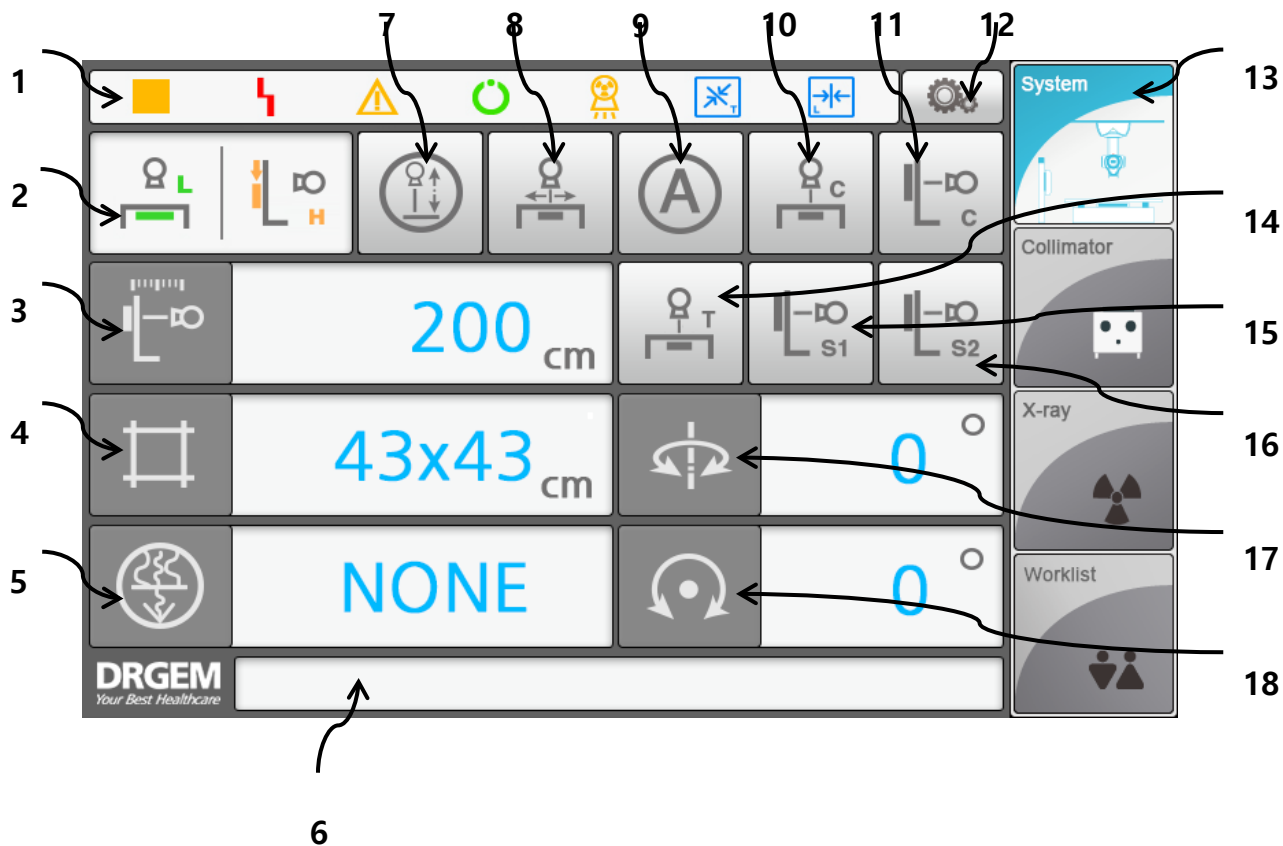

- |  |   |
|--|---|
| 1. Generator indicator                       | 2. Detector indicator                         |
| 3. Wall stand & Table SID                    | 4. Auto collimation size indicator            |
| 5. Auto filter selection indicator           | 6. Message indicator                          |
| 7. Vertical sync. selection & indicator      | 8. Table Bucky Tracking selection & indicator |
| 9. Automatic positioning selection & display | 10. Table Bucky centering select and display  |
| 11. Stand Bucky centering select and display | 12. Setting                                   |
| 13. System Menu                              | 14. Table Mode(SID 100)                       |
| 15. Stand Mode 1 (SID 100)                   | 16. Stand Mode 2 (SID 180)                    |
| 17. Column rotation angle indicator          | 18. Tube rotation angle indicator             |

Auto filter selection & indicator Menu

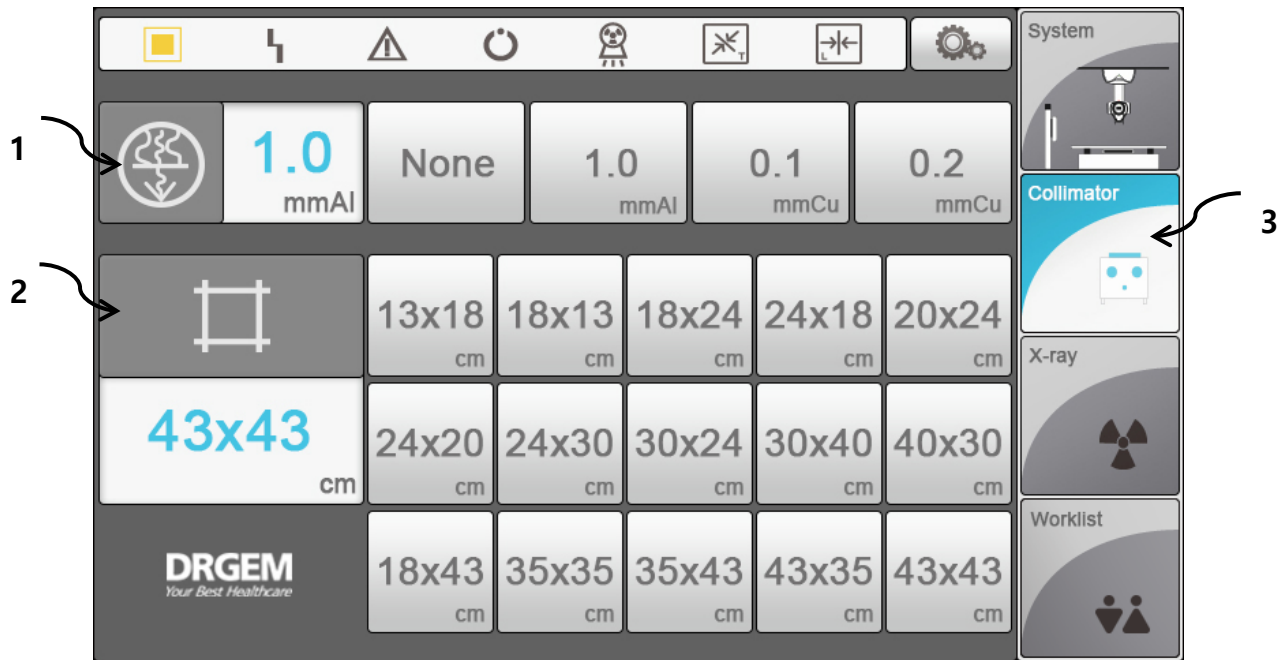

- 1. Auto filter selection & indicator
- 3. Auto collimation menu(Optional)

- 2. Auto collimation size selection & indicator

X-ray generator selection & indicator

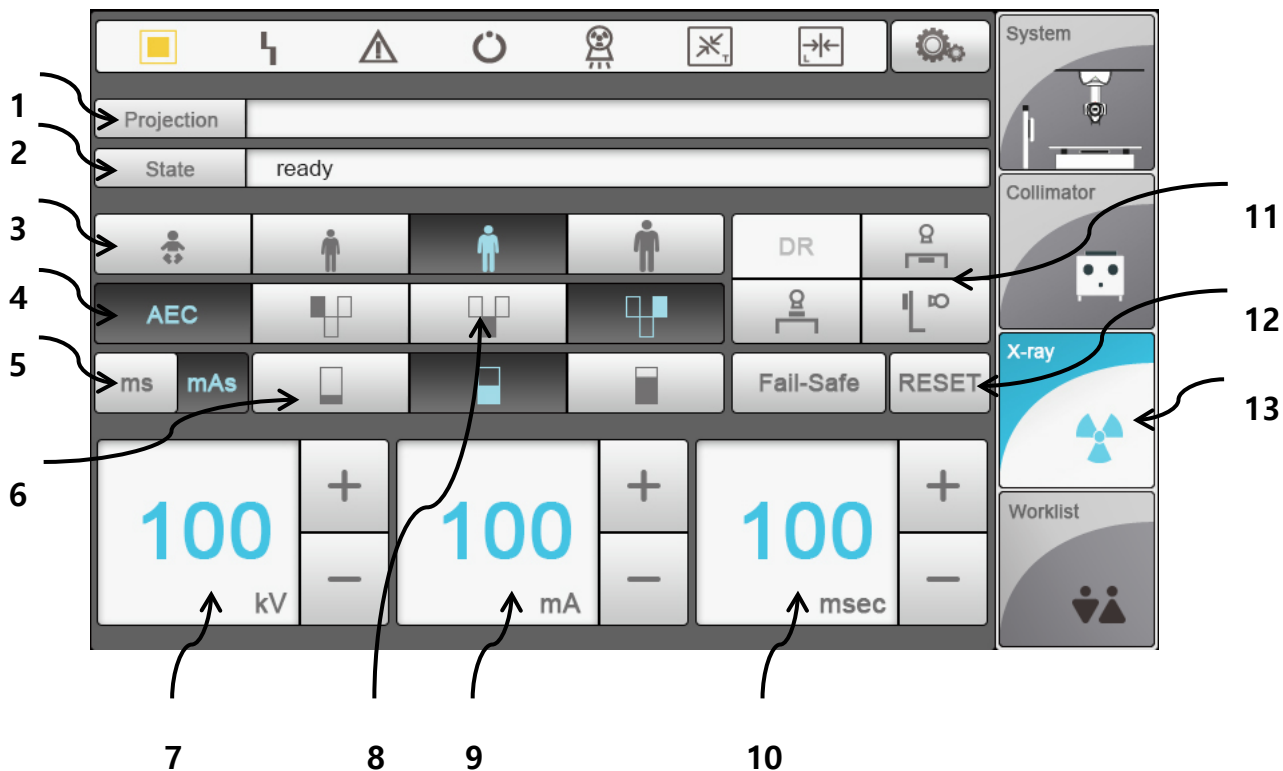

- |  |                                    |
|--|------------------------------------|
| 1. Projection                              | 2. Generator state                 |
| 3. Patient Body Size selection & indicator | 4. AEC selection & indicator       |
| 5. Time/mAs selection & indicator          | 6. screen selection & indicator    |
| 7. KV set & indicator                      | 8. AEC field selection & indicator |
| 9. mA set & indicator                      | 10. Exposure. time set & indicator |
| 11. Bucky selection & indicator            | 12. Error reset button             |
| 13. X-ray generator menu                   |                                    |

DR Image viewer

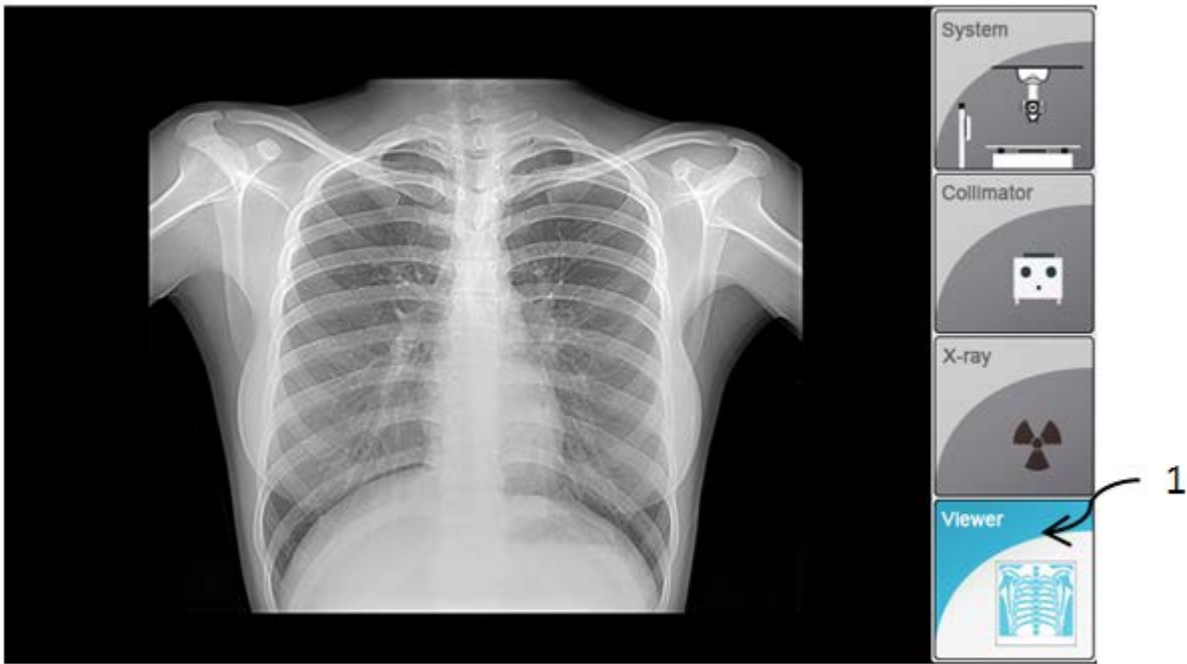

1. DR Image Viewer menu

**CAUTION**

Emergency Stop Switch is located at the top of the tube as below

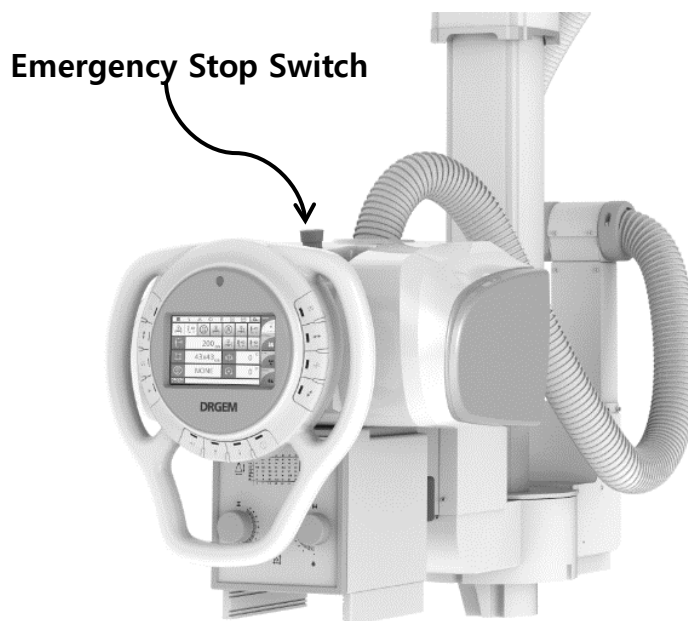

### 5.5 VERTICAL WALL STAND (WBS, WBS-TA, WBS-TM)

- Wall Bucky Stand (Model: WBS, Motorized)

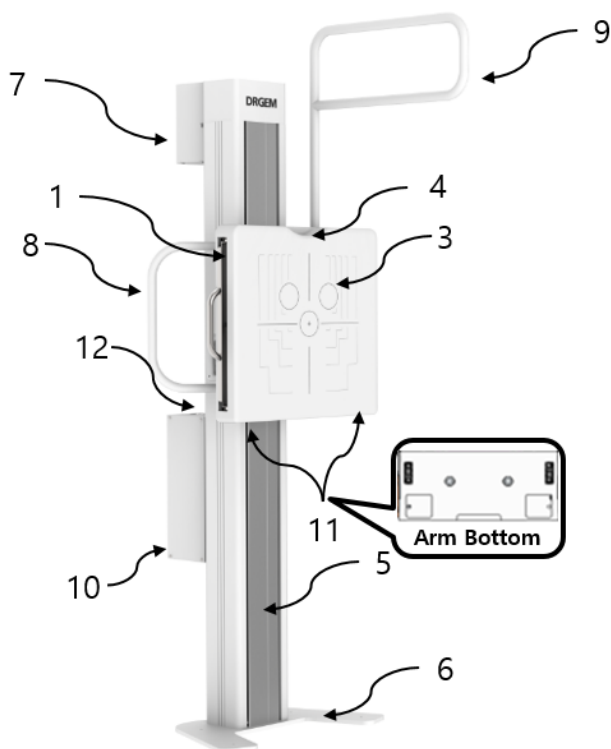

- 1 Cassette Tray
- 2 Vertical lock control switch
- 3 Imaging Area
- 4 Mandible rest
- 5 Vertical stand
- 6 Stand support (Floor)
- 7 Stand support (Wall)
- 8 Chest Handgrip(option)
- 9 Overhead Handgrip(option)
- 10 Controls box
- 11 Safety Sensor
- 12 Emergency switch



- 1. Vertical movement
  - 1) Push the upper foot switch 1
  - 2) Push the down foot switch 2

● Wall Bucky Stand (Model: WBS-TA)

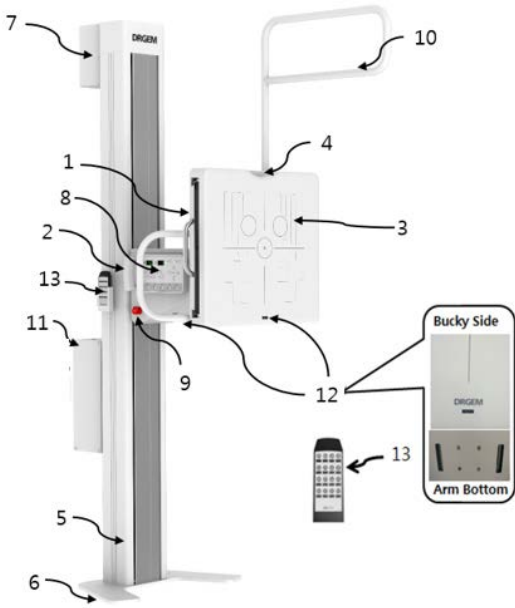

- 1 Cassette Tray
- 2 Vertical lock control switch
- 3 Imaging Area
- 4 Mandible rest
- 5 Vertical stand
- 6 Stand support (Floor)
- 7 Stand support (Wall)
- 8 Control panel
- 9 Emergency switch
- 10 Overhead Handgrip(option)
- 11 Control box
- 12 Safety Sensor
- 13 Remote controller

Rotating tray can be provided with 4336W portable detector as below.

Removable grid also can be provided as an option.

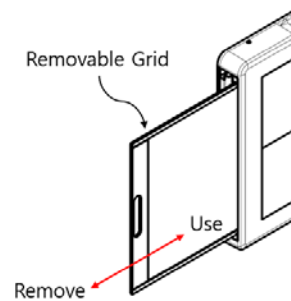
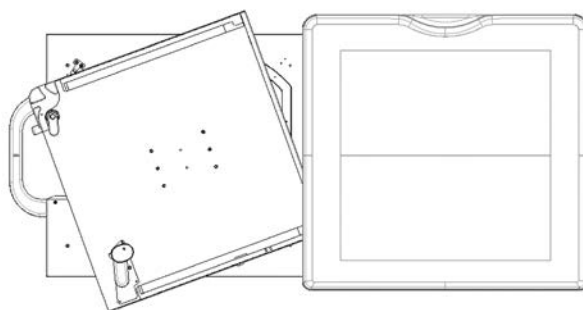

For the vertical moving, switches as below will be provided at the each rear side of the Bucky.



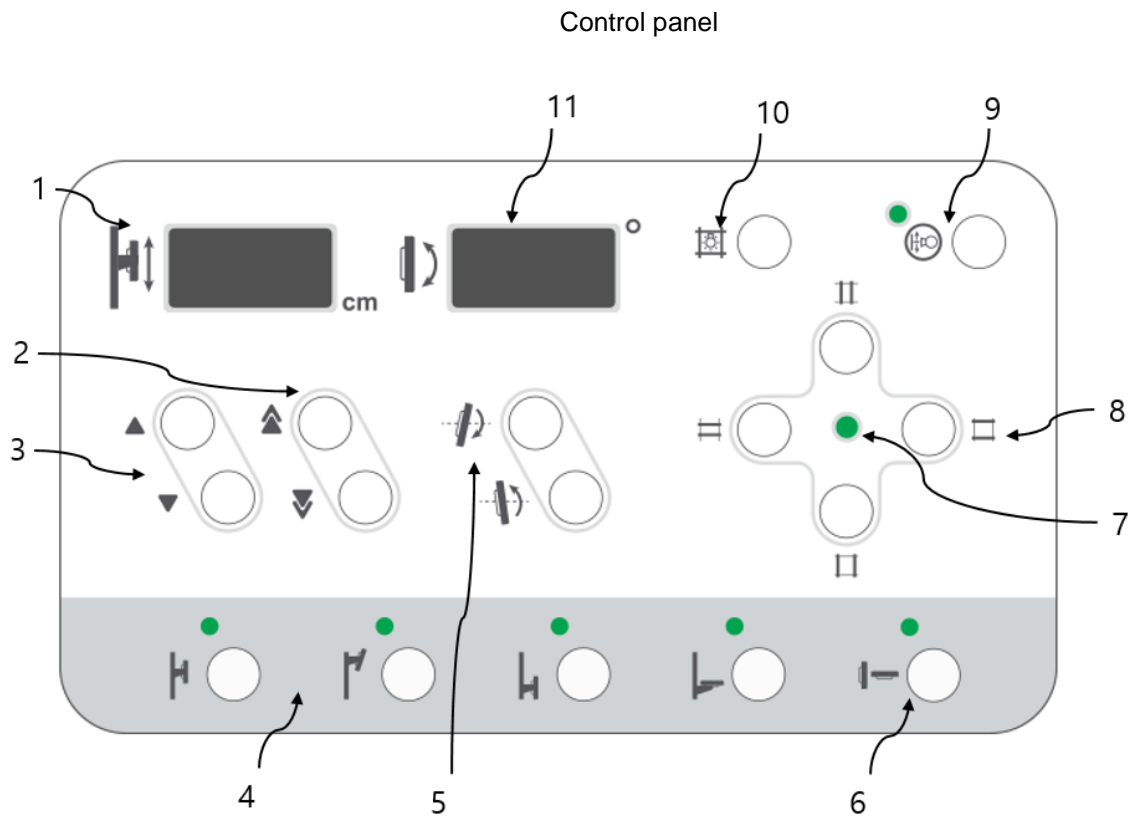

- 1 Vertical height indicator
- 2 Vertical motorized control (Option, Normal speed)
- 3 Vertical motorized control (Option, Slow speed)
- 4 Auto Positioning control (Option, User programmable)
- 5 Tilting motorized control
- 6 Auto Tilting control
- 7 Remote control sensor
- 8 Motorized collimator control (Option)
- 9 Synchronization selection & indicator (Option)
- 10 Collimator lamp control (Option)
- 11 Tilting angle indicator

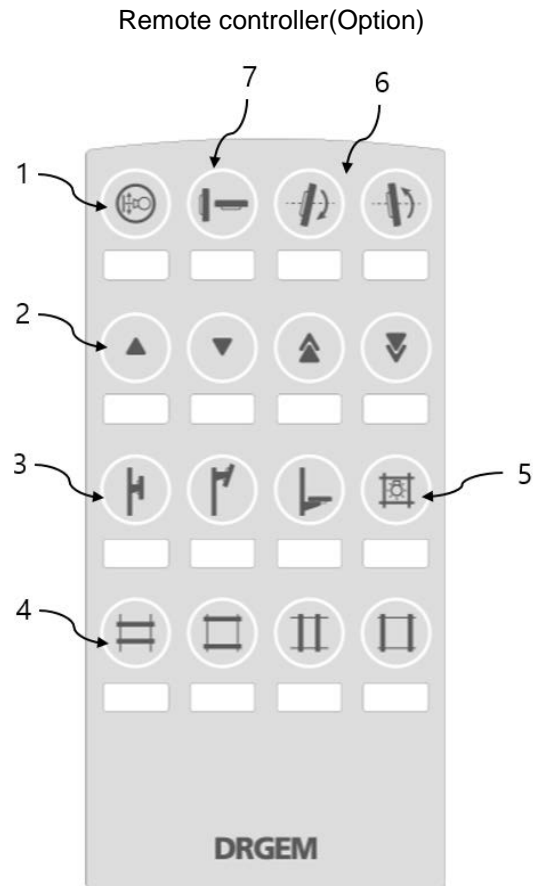

- 1 Synchronization selection & indicator
- 2 Vertical motorized control
- 3 Tilting motorized control
- 4 Auto Positioning control
- 5 Motorized collimator control
- 6 Tilting motorized control
- 7 Auto Tilting control



- Manual Tilting Wall Stand (Model: WBS-TM, Motorized)

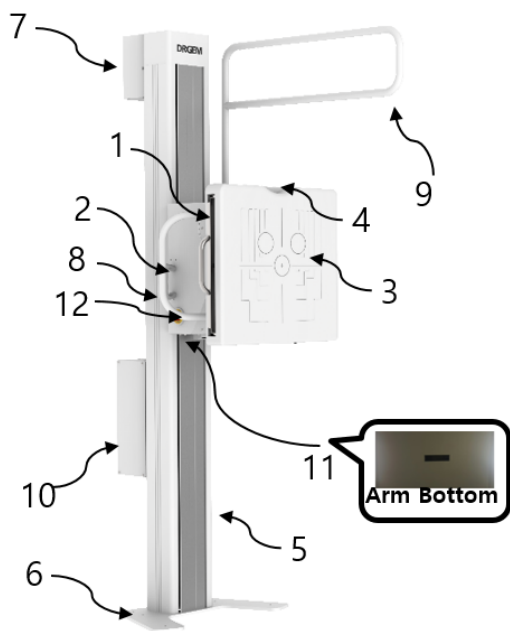

- 1 Cassette Tray
- 2 Vertical lock control switch
- 3 Imaging Area
- 4 Mandible rest
- 5 Vertical stand
- 6 Stand support (Floor)
- 7 Stand support (Wall)
- 8 Chest Handgrip(option)
- 9 Overhead Handgrip(option)
- 10 Controls box
- 11 Safety Sensor
- 12 Emergency switch

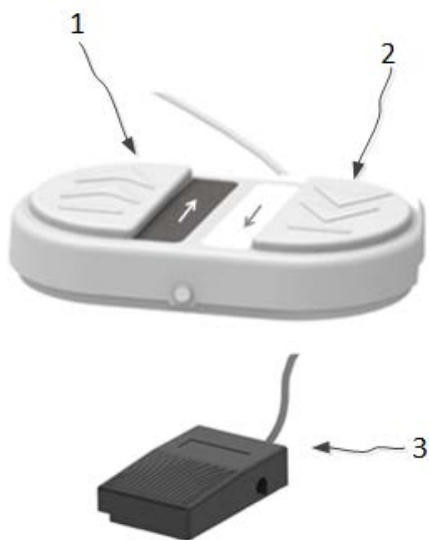

- 1. Vertical movement
  - 3) Push the upper foot switch 1
  - 4) Push the down foot switch 2
- 2. Tilting movement
  - 1) Hold the chest handgrip
  - 2) Push foot switch 3
  - 3) Move the tilting position while keep push the footswitch 3
  - 4) Release foot switch 3

### 5.6 PATIENT TABLES

1. Patient Table (Model: PBT-4)



- 1 Tabletop
- 2 Cassette Tray  
(Drawing out tray off the tray lock)
- 3 Lock control foot sensor (beam)

2. Elevating Patient Table (Model: PBT-6)

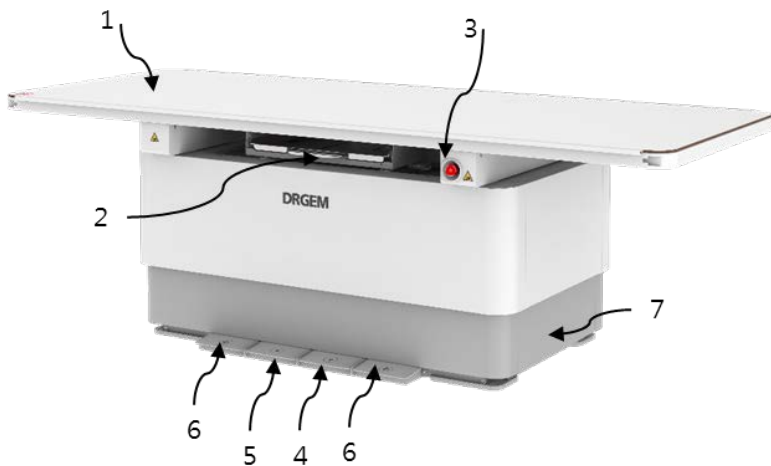

- 1 Tabletop
- 2 Cassette Tray  
(Drawing out tray off the tray lock)
- 3 Emergency switch
- 4 Elevating down pedal
- 5 Elevating up pedal
- 6 Tabletop lock pedal
- 7 Cable box cover

**NOTE**

For the safety, all pedals of PBT-6 will work when pushed twice in 2 seconds. After table start works by pedals, operator can operate table by only one pushing pedals within 5 seconds. If the pedal operation is stopped over 5 seconds, double stepping is required for pedal operation.

Switches like below will be provided for the Bucky moving of stationary detector.

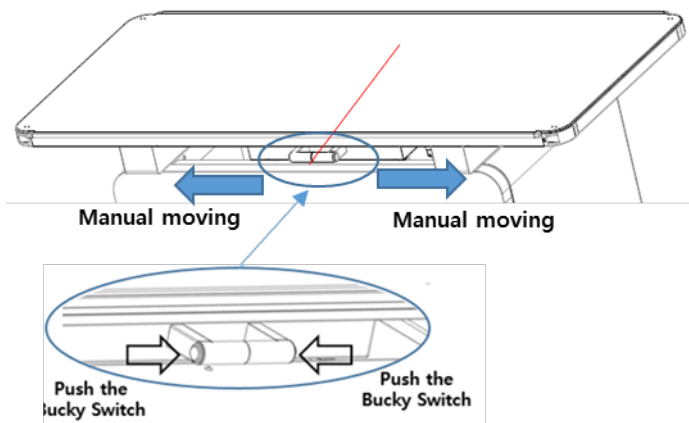

Rotating tray can be provided with 4336R portable detector as below.

Removable grid also can be provided as an option.

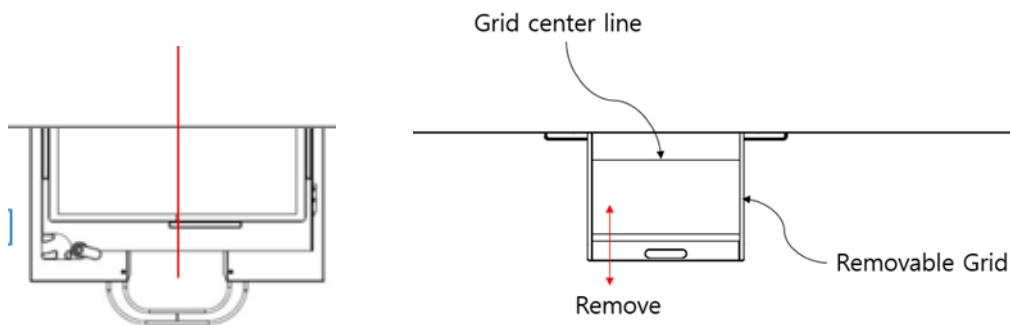

3. Mobile Patient Table (Model: PDT-1)



- 1 Tabletop
- 2 Caster with foot lock

### 5.7 COLLIMATOR

1. Collimator (Model: MCR)

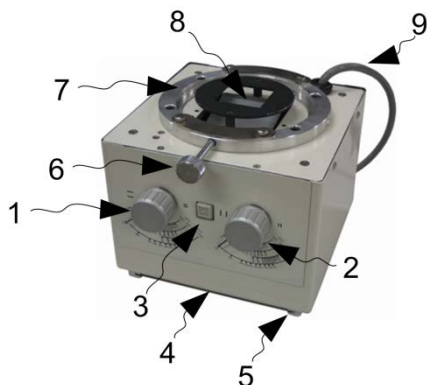

- 1 Lateral X-ray coverage control knob
- 2 Longitudinal X-ray coverage control knob
- 3 Collimation lamp on switch (30sec timer)
- 4 Beam out port
- 5 Rail for additional filter or beam limiter(cone)
- 6 Rotation fixing knob
- 7 Tube assembling area
- 8 Beam in port
- 9 Power cable

2. Collimator (Model: R108F)

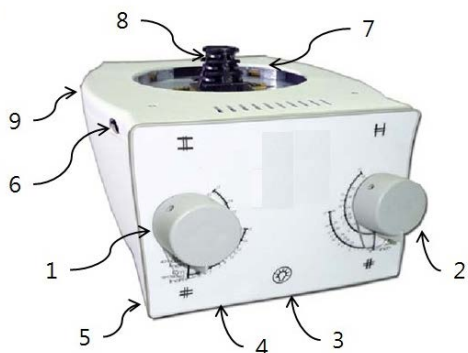

- 1 Lateral X-ray coverage control knob
- 2 Longitudinal X-ray coverage control knob
- 3 Collimation lamp on switch (30sec timer)
- 4 Beam out port
- 5 Rail for additional filter or beam limiter(cone)
- 6 Rotation fixing Bolt
- 7 Tube assembling area
- 8 Beam in port (optional near port shutters)
- 9 Rotation fixing Bolt

3. Collimator (Model: R302A, R302MLP/A, R302MFMLP/A)

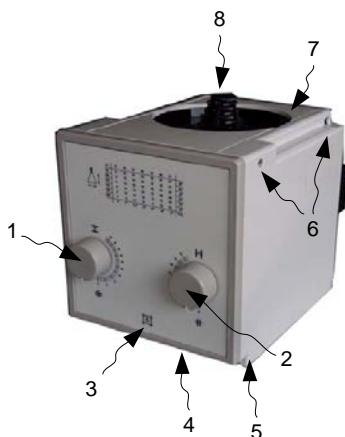

- 1 Lateral X-ray coverage control knob
- 2 Longitudinal X-ray coverage control knob
- 3 Collimation lamp on switch (30sec timer)
- 4 Beam out port
- 5 Rail for additional filter or beam limiter(cone)
- 6 Rotation fixing Bolt
- 7 Tube assembling area
- 8 Beam in port (optional near port shutters)

## 4. Collimator (DXC-RML, DXC-RMH)

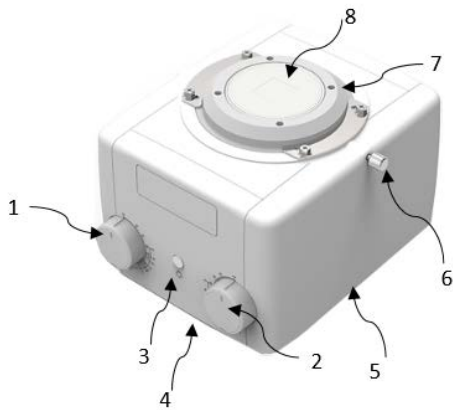

- 1 Lateral X-ray coverage control knob
- 2 Longitudinal X-ray coverage control knob
- 3 Collimation lamp on switch (30sec timer)
- 4 Beam out port
- 5 Rail for additional filter or beam limiter(cone)
- 6 Rotation fixing Bolt
- 7 Tube assembling area
- 8 Beam in port (optional near port shutters)

(This page intentionally left blank)

## APPENDIX A. EXPOSURE TABLE

Table 1 following shows nominal exposure times resulting from pre-selected mAs and mA values.

Discrete values of loading factors were chosen from the series R'10 according to ISO 497.

This table also shows the range and interrelation of these loading factors. For example, if 20 mAs is selected at 200 mA, it can be seen that the exposure time will be approximately 100 ms. This is determined by reading down the 200 mA column to 20 mAs; then by reading the nominal exposure time 100 ms as shown at the left side of the table, along the 20 mAs row.

Exposure table may be photocopied as required and placed in a suitable location as per local requirements.

(This page intentionally left blank)



GENERATOR TECHNIQUE SELECTION

Time (ms)	mA Selected																				
	10	12.5	16	20	25	32	40	50	64	80	100	125	160	200	250	320	400	500	640	800	1000
1.0											0.1	0.125	0.16	0.2	0.25	0.32	0.4	0.5	0.64	0.8	1.0
1.2										0.1	0.125	0.16	0.2	0.25	0.32	0.4	0.5	0.64	0.8	1.0	1.25
1.6									0.1	0.125	0.16	0.2	0.25	0.32	0.4	0.5	0.64	0.8	1.0	1.25	1.6
2								0.1	0.125	0.16	0.2	0.25	0.32	0.4	0.5	0.64	0.8	1.0	1.25	1.6	2.0
2.5							0.1	0.125	0.16	0.2	0.25	0.32	0.4	0.5	0.64	0.8	1.0	1.25	1.6	2.0	2.5
3.2						0.1	0.125	0.16	0.2	0.25	0.32	0.4	0.5	0.64	0.8	1.0	1.25	1.6	2.0	2.5	3.2
4					0.1	0.125	0.16	0.2	0.25	0.32	0.4	0.5	0.64	0.8	1.0	1.25	1.6	2.0	2.5	3.2	4.0
5				0.1	0.125	0.16	0.2	0.25	0.32	0.4	0.5	0.64	0.8	1.0	1.25	1.6	2.0	2.5	3.2	4.0	5.0
6.4			0.1	0.125	0.16	0.2	0.25	0.32	0.4	0.5	0.64	0.8	1.0	1.25	1.6	2.0	2.5	3.2	4.0	5.0	6.4
8		0.1	0.125	0.16	0.2	0.25	0.32	0.4	0.5	0.64	0.8	1.0	1.25	1.6	2.0	2.5	3.2	4.0	5.0	6.4	8
10	0.1	0.125	0.16	0.2	0.25	0.32	0.4	0.5	0.64	0.8	1.0	1.25	1.6	2.0	2.5	3.2	4.0	5.0	6.4	8	10
12.5	0.125	0.16	0.2	0.25	0.32	0.4	0.5	0.64	0.8	1.0	1.25	1.6	2.0	2.5	3.2	4.0	5.0	6.4	8	10	12.5
16	0.16	0.2	0.25	0.32	0.4	0.5	0.64	0.8	1.0	1.25	1.6	2.0	2.5	3.2	4.0	5.0	6.4	8	10	12.5	16
20	0.2	0.25	0.32	0.4	0.5	0.64	0.8	1.0	1.25	1.6	2.0	2.5	3.2	4.0	5.0	6.4	8	10	12.5	16	20
25	0.25	0.32	0.4	0.5	0.64	0.8	1.0	1.25	1.6	2.0	2.5	3.2	4.0	5.0	6.4	8	10	12.5	16	20	25
32	0.32	0.4	0.5	0.64	0.8	1.0	1.25	1.6	2.0	2.5	3.2	4.0	5.0	6.4	8	10	12.5	16	20	25	32
40	0.4	0.5	0.64	0.8	1.0	1.25	1.6	2.0	2.5	3.2	4.0	5.0	6.4	8	10	12.5	16	20	25	32	40
50	0.5	0.64	0.8	1.0	1.25	1.6	2.0	2.5	3.2	4.0	5.0	6.4	8	10	12.5	16	20	25	32	40	50
64	0.64	0.8	1.0	1.25	1.6	2.0	2.5	3.2	4.0	5.0	6.4	8	10	12.5	16	20	25	32	40	50	64
80	0.8	1.0	1.25	1.6	2.0	2.5	3.2	4.0	5.0	6.4	8	10	12.5	16	20	25	32	40	50	64	80
100	1.0	1.25	1.6	2.0	2.5	3.2	4.0	5.0	6.4	8	10	12.5	16	20	25	32	40	50	64	80	100
125	1.25	1.6	2.0	2.5	3.2	4.0	5.0	6.4	8	10	12.5	16	20	25	32	40	50	64	80	100	125
160	1.6	2.0	2.5	3.2	4.0	5.0	6.4	8	10	12.5	16	20	25	32	40	50	64	80	100	125	160
200	2.0	2.5	3.2	4.0	5.0	6.4	8	10	12.5	16	20	25	32	40	50	64	80	100	125	160	200
250	2.5	3.2	4.0	5.0	6.4	8	10	12.5	16	20	25	32	40	50	64	80	100	125	160	200	250
320	3.2	4.0	5.0	6.4	8	10	12.5	16	20	25	32	40	50	64	80	100	125	160	200	250	320

Table 1: mAs values vs. mA & time selected

Table 1 continued on next page

Time (ms)	mA Selected																				
	10	12.5	16	20	25	32	40	50	64	80	100	125	160	200	250	320	400	500	640	800	1000
400	4	5	6.4	8	10	12.5	16	20	25	32	40	50	64	80	100	125	160	200	250	320	400
500	5	6.4	8	10	12.5	16	20	25	32	40	50	64	80	100	125	160	200	250	320	400	500
640	6.4	8	10	12.5	16	20	25	32	40	50	64	80	100	125	160	200	250	320	400	500	
800	8	10	12.5	16	20	25	32	40	50	64	80	100	125	160	200	250	320	400	500		
1000	10	12.5	16	20	25	32	40	50	64	80	100	125	160	200	250	320	400	500			
1250	12.5	16	20	25	32	40	50	64	80	100	125	160	200	250	320	400	500				
1600	16	20	25	32	40	50	64	80	100	125	160	200	250	320	400	500					
2000	20	25	32	40	50	64	80	100	125	160	200	250	320	400	500						
2500	25	32	40	50	64	80	100	125	160	200	250	320	400	500							
3200	32	40	50	64	80	100	125	160	200	250	320	400	500								
4000	40	50	64	80	100	125	160	200	250	320	400	500									
5000	50	64	80	100	125	160	200	250	320	400	500										
6400	64	80	100	125	160	200	250	320	400	500											
8000	80	100	125	160	200	250	320	400	500												
10000	100	125	160	200	250	320	400	500													

**Table 1 (Cont): mAs values vs. mA & time selected**

kV/mA values are generator's output rating dependent.

mA/ms values are tube rating dependent.

For certain tubes, some mA/ms selections are not available at higher kV selections.

640mA is only available for output rating of x-ray generator from 52kW.

800mA is only available for output rating of x-ray generator from 68kW.

1000mA is only available for output rating of x-ray generator from 82kW

## **APPENDIX B. EXPOSURE INDEX**

Refer to the APPENDIX.B in RADMAX Operation Manual (RMD1804-001)

(This page intentionally left blank)



**DRGEM Corporation**

7Fl, E-B/D Gwangmyeong Techno-Park, 60 Haan-ro,  
Gwangmyeong-si, Gyeonggi-do, 14322, Korea  
TEL: +82-2-869-8566, FAX: +82-2-869-8567