



„Ampelos-Plus” SRL – calitate & fiabilitate
str. Mesterul Manole 12, Chisinau, Moldova, MD-2052
GSM + 373 79428681
www.ampelos.md

CERTIFICAT DE CALITATE

NR	DENUMIREA	Ø ARMATURA	Ø DISC	INALȚIMEA	PRODUCATOR	FOTO
1	ANCORE	12 MM	130 MM	90 CM	REPUBLICA MOLDOVA (AMPELOS-PLUS SRL)	

15.09.2025

Director: Luchianov Igor







„Ampelos-Plus” SRL – calitate & fiabilitate
str. Mesterul Manole 12, Chisinau, Moldova, MD-2052
GSM + 373 79428681
www.ampelos.md

CERTIFICAT DE CALITATE

HARAGI FIBROPLASTIC

NR	DENUMIREA	Ø	Material	INALȚIMEA	PRODUCATOR	GARANTIA	FOTO
1	Haragi Fibroplastic	8 MM	Fibra de sticla	120 cm	CHINA	50 ANI	

FIXATOR PENTRU HARAGI

NR	DENUMIREA	Ø sirma	Material	PRODUCATOR	FOTO
1	FIXATOR ART. NR. 1	1.6 MM	Sirma inox	Republica Moldova (Ampelos-Plus SRL)	

Director Luchianov Igor



GP nr. 1

Grippe nr. 1 sunt proiectate cu o margine de ghidare plana pentru o blocare sigura in cazul sistemelor care utilizeaza spalieri de metal.

- Blocare si intindere (tensionare) in acelasi timp
- Ideale pentru a fi utilizate atat pentru sarma de otel cat si pentru monofilamentul de nailon
- Cilindru ceramic de înaltă calitate rezistent la coroziune
- Canalul integrat separat permite revenirea (intoarcerea) sârmei în siguranță
- Intindere (tensionare) folosind un instrument Torq și un adaptor pentru intinzatorii incastrati (instalati in interiorul spalierului)
- Reglabil si deblocabil



Instalat pe spalierii de metal



Adaptor – in cazul in care intinzatorul este instalat in interiorul spalierului

Produs	Greutate utila maxima	Tipul de sarma	Codul produsului	Cantitate in punga	Cantitate buc. cutie
GP nr. 1	400 kg	1,80 mm - 3,00 mm	GP1-BB	20	300

Instalare



GP. NR. 1



Instalare



Adaptor (în interiorul stâlpului metalic)

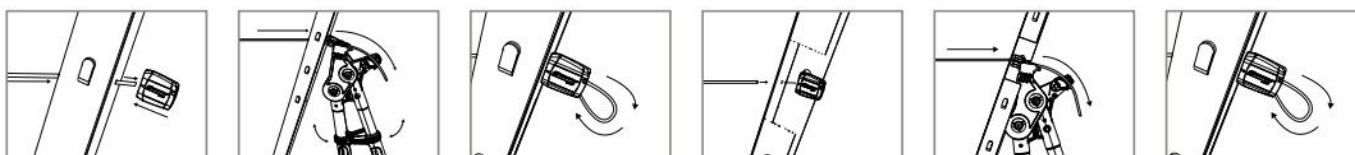

- Dacă stâlpul este instalat „open-side-out”, există un adaptor la îndemână care poate fi montat pe instrument pentru a facilita întinderea.

GRIPPLE SMALL

GRIPPLE SMALL de intinzatori și dispozitive de tensionare a sârmei este potrivită pentru toate sistemele de palisare.

- Intinde și tensionează sarma în același timp
- Elimină înnodarea sârmei, reducând timpul de instalare
- Ideal atât pentru sarma cu alungire mare cât și pentru cea cu alungire mică
- Proiectat pentru rezistența la încărcare mare și coroziune
- Usor de retensionat an după an
- Reglabil și deblocabil



Gama Gripple Plus de intinzatori și dispozitive de tensionare a sârmei



În partea de sus - Intinderea sârmei folosind Gripple Plus Medium.
În partea de jos - Intinzator standard.

Produs	Greutate utilă maximă	Tipul de sarma	Codul produsului	Cantitate în punga	Cantitate buc. cutie
Gripple Plus Small	300 kg	1,40 mm - 2,20 mm	GPS-BB	20	300

Gripple Plus - Instalare (cu reglarea din cheia și Twister)

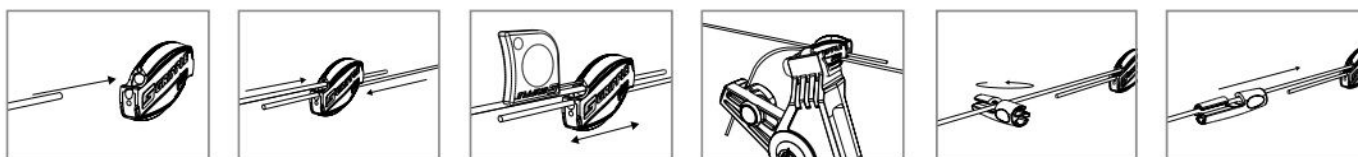

- Aplicați și re-aplicați tensiunea cu un instrument de întindere (lăsați cel puțin 75 mm fir de coadă)
- Repoziționați înainte de aplicarea tensiunii cu ajutorul unei taste de setare
- Un fir de coadă Twister curăță și poate fi îndepărtat și resetat pentru a permite re-tensionarea

GPAK Plus M

Set p/ u ancore 3mm/3,5 M(cablu+lacata GP 1)+Protector+ŞAIBA



GPAK Plus M este produsul ideal pentru o fixare de durata pe spalierii de metal. Este furnizat ca set gata de utilizare si cuprinde o sufa pretensionată și un dispozitiv de întindere Gripple, un degaj și două protecții de sârmă concepute pentru a crea o protecție în trei puncte împotriva forfecării.

- Conceput pentru eficiență și sarcină maximă
- Puncte de fixare dublă pentru un transfer uniform de sarcină
- Fabricat cu sufa din sârmă de aluminiu zincat pentru reținerea coroziunii
- Prevazut cu două protecții de sârmă pentru a evita deteriorarea frânghiei de sârmă în interiorul găurilor metalice
- Finisaj consecvent, profesional
- Retensiune ușoară de la an la an.



GPAK Plus M - Prevazut pentru consolidarea spalierilor de metal.

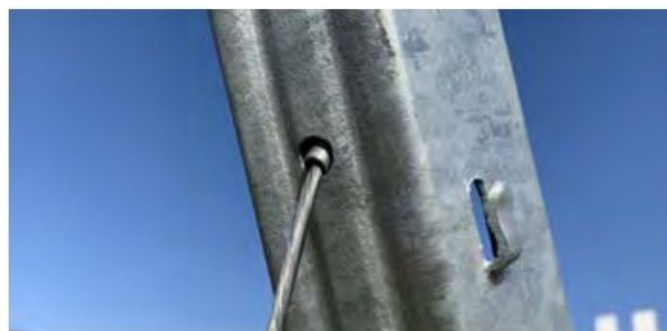

In partea de sus - Protectie sarma



In partea de jos - Protectie pentru sufa

Produs	Greutate utila maxima	Diametru sufa	Lungimea sufei	Codul produsului	Cantitate in punga	Cantitate buc. cutie
GPAK Plus M No. 3 cu sufa din zinc aluminiu	400 kg	3 mm			-	
			3,5 m	GPAK-PM3-3.5M	-	20
					-	
					-	

GPAK PLUS M - Instalare (spalier metalic)

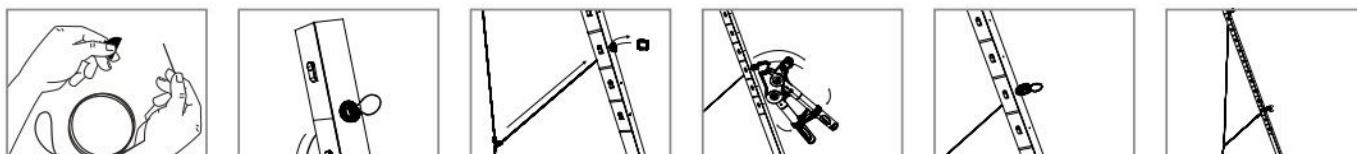

- Combinați cu o ancoră pentru o soluție completă de ancorare, care este simplu și rapid de instalat

Instrumente de ancorare si accesorii



Cleste de sarma

Tăietoarele de sârmă sunt potrivite pentru tăierea sârmei de înaltă tracțiune sau a frânghiei de până la 4 mm. Mânerele antiderapante încărcate cu arcuri fac ușor de utilizat, iar fălcile din oțel întărit oferă rezultate excelente.

Cod de piesă: CUTTER-GRIPPLE



Cleste de tensionare

Compact, ușor de manevrat, operat și transportat. Aplicați cu ușurință tensiunea cu ajutorul mecanismului de antrenare a angrenajului 6:1 cu manometru integral pentru o tensiune de precizie de până la 400 kg.

Cod de piesă: TOOL-5-SINGLE

Instrument Torq - Instalare

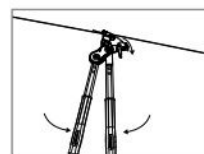
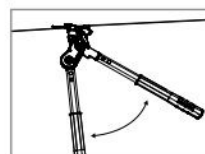
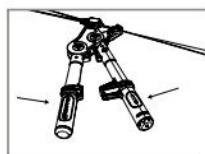
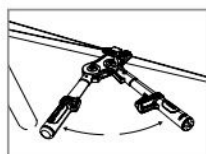
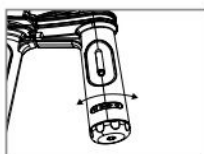

- Nu tensionati niciodată peste recomandările producătorului de sârmă

1 Consignor Gripple Limited The Old West Gun Works Savile Street East Sheffield S4 7UQ UNITED KINGDOM <small>Tel No. 01142288620</small> 2 Consignee	No. RA 236146	COPY
AMPELOS-PLUS SRL 16/1 MESTERUL MANOLE STREET CHISINAU CITY MD-2012 REPUBLIC OF MOLDOVA	RA236146	SI-254287
4 Transport details (Optional)	UNITED KINGDOM CERTIFICATE OF ORIGIN	
6 Item number; marks, numbers, number and kind of packages; description of goods FULLY ADDRESSED	3 Country of Origin United Kingdom	
9 PALLETS CONTAINING FASTENERS, TENSIONING TOOLS AND GPAK KITS IN ACCORDANCE WITH INVOICE SI-254287 DATED 20TH APRIL 2025.	7 Quantity Total Gross: 5619 KG Total Net: 5412 KG	

8 THE UNDERSIGNED AUTHORITY CERTIFIES THAT THE GOODS DESCRIBED ABOVE ORIGINATE IN THE COUNTRY SHOWN IN BOX 3

SHEFFIELD CHAMBER OF COMMERCE

**The Sheffield Chamber of
 Commerce & Industry**

ELECTRONIC CERTIFYING STAMP
 21 Apr 2025
Certificate Number: RA236146

Authorised by H M Government



Rachael Page
AUTHORISED SIGNATORY



UK-SHE3457-4082222-E
 www.ecert.sgs.com

Place and date of issue; name, signature and stamp of competent authority



INNOVATION AND EXCELLENCE FOR VITICULTURE AND FRUIT GROWING
33095 SAN GIORGIO DELLA RICHINVELDA (PORDENONE) – Via Spilimbergo n° 3

Tel. +39042796341 – Fax. +39042796342-e-mail :info@prestilpali.com-www.prestilpali.com Iscr.Reg.Impr. PN/C.F./P.I.:01249640937

QUALITY CERTIFICATE

RIBBED TORNADO POST 50X35 mm

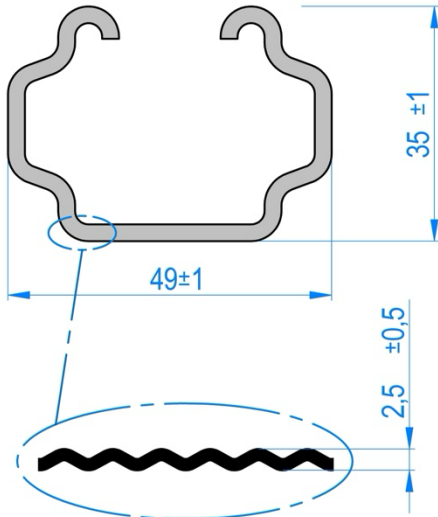

**BREVETTATO/
PATENTED**

NAME:	TORNADO POLE
SIZE:	50x35x1,5 mm
MATERIAL:	GALVANIZED SENDZIMIR
GRADE QUALITY MATERIAL :	Z275 DX51D



IL MATERIALE UTILIZZATO E' DI ORIGINE PREFERENZIALE UE.

E' CONFORME ALLE NORME INTERNAZIONALI DI QUALITA' NON E' TOSSICO E NON INQUINA.

THE MATERIAL USED IS OF EU PREFERENTIAL ORIGIN.

COMPLIES WITH INTERNATIONAL QUALITY STANDARDS, IS NON-TOXIC AND NON-POLLUTING.

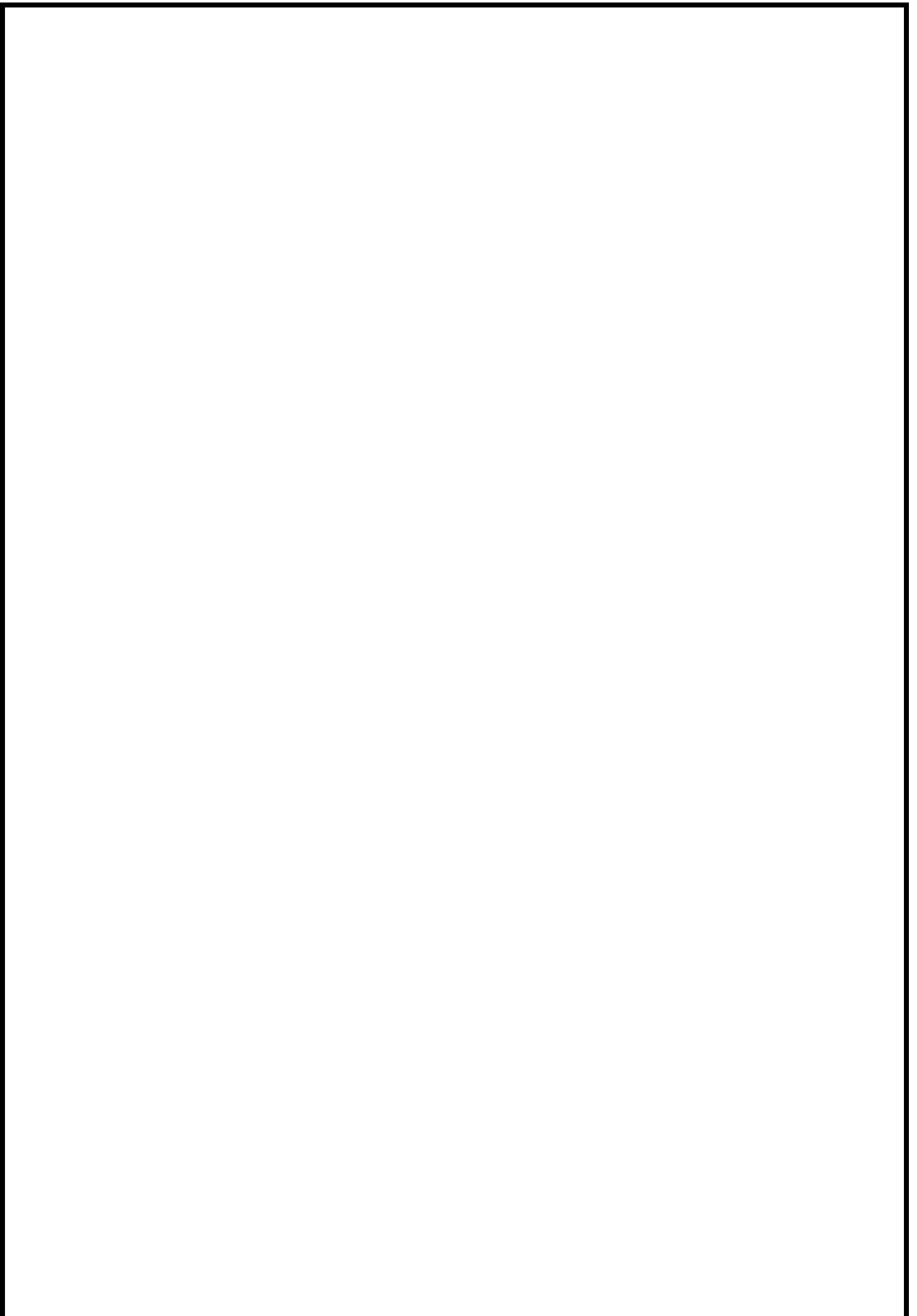

TEST REPORT No. 355477

Place and date of issue: Bellaria-Igea Marina - Italy, 12/10/2018

Customer: PRESTIL S.r.l. - Via Spilimbergo, 3 - 33095 SAN GIORGIO DELLA RICHINVELDA (PN) - Italy

Date test requested: 14/02/2018

Order number and date: 75760, 15/02/2018

Date sample received: from 07/02/2018 to 06/06/2018

Test date: from 23/02/2018 to 28/09/2018

Purpose of test: torque testing of vineyard posts

Test site: Istituto Giordano S.p.A. - Strada Erbosa Uno, 72 - 47043 Gatteo (FC) - Italy

Sample origin: sampled and supplied by the Customer

Identification of sample received: Nos. 2018/0275 and 2018/1316

Sample name*

The test sample is called "TORNADO".

Description of sample*

The test sample comprises 6 press-bent steel sections, 3 smooth and 3 ribbed, nominal length 600 mm, made from S235JR pickled, rolled sheet, nominal thickness 1,5 mm.

(*) according to that stated by the Customer.

Comp. AV
Revis. GF

This test report consists of 5 sheets.
This document is the English translation of the test report No. 355477 dated 12/10/2018 issued in Italian;
in case of dispute the only valid version is the Italian one. Date of translation: 07/11/2018.

Sheet
1 of 5



Photo of smooth, press-bent sections



Photo of ribbed, press-bent sections

Test apparatus

The following equipment was used to carry out the test:

- torque testing machine comprising a worm drive with clamp “A” integral with the drive’s axis of rotation;
- clamp “B” rotating about the worm drive’s axis of rotation;
- lever of length 1 m integral with clamp “B”;
- counterbalance arm;
- AEP Transducers TS compression load cell and DFI (digital force indicator) (apparatus in-house identification code EDI104);
- two pairs of ad hoc grippers built by the Customer.

Test method

The steel section is secured to the torque test rig so that the worm drive’s axis of rotation is coincident with the section’s principal axis.

The clamping of clamps “A” and “B” to the grippers produces a rigidly-connected kinematic chain comprising: worm drive, clamp “A”, first gripper, test section, second gripper, clamp “B”, lever and load cell.

Next, the worm drive is turned on and allowed to rotate until reaching maximum torque measured with steel section fully clamped. The amount of stress is monitored using load cell “C” positioned under the lever at a distance of 1 m from the gear reducer’s axis of rotation.

This procedure is repeated for each smooth and ribbed section.

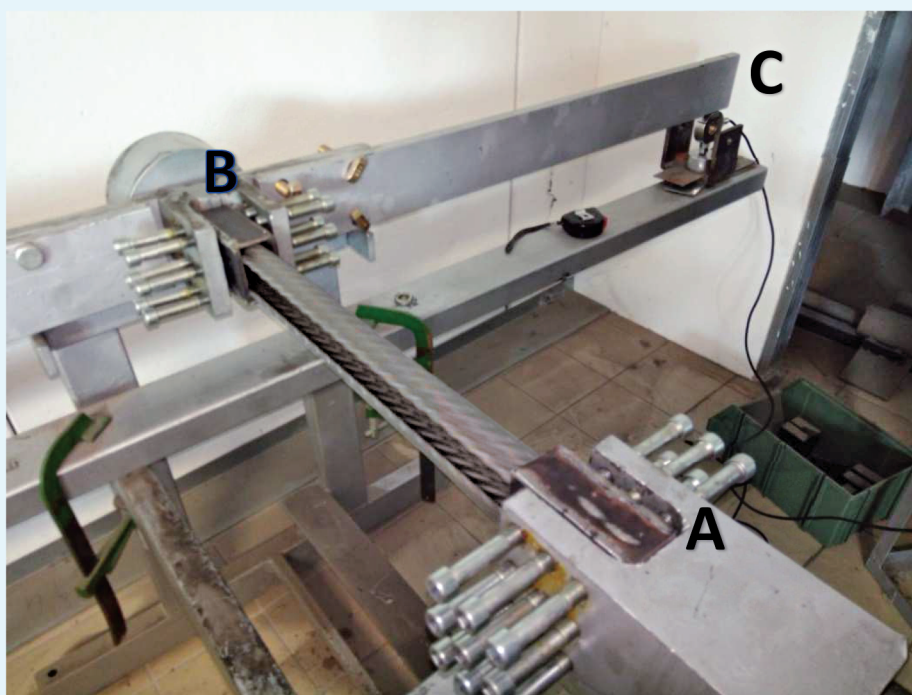
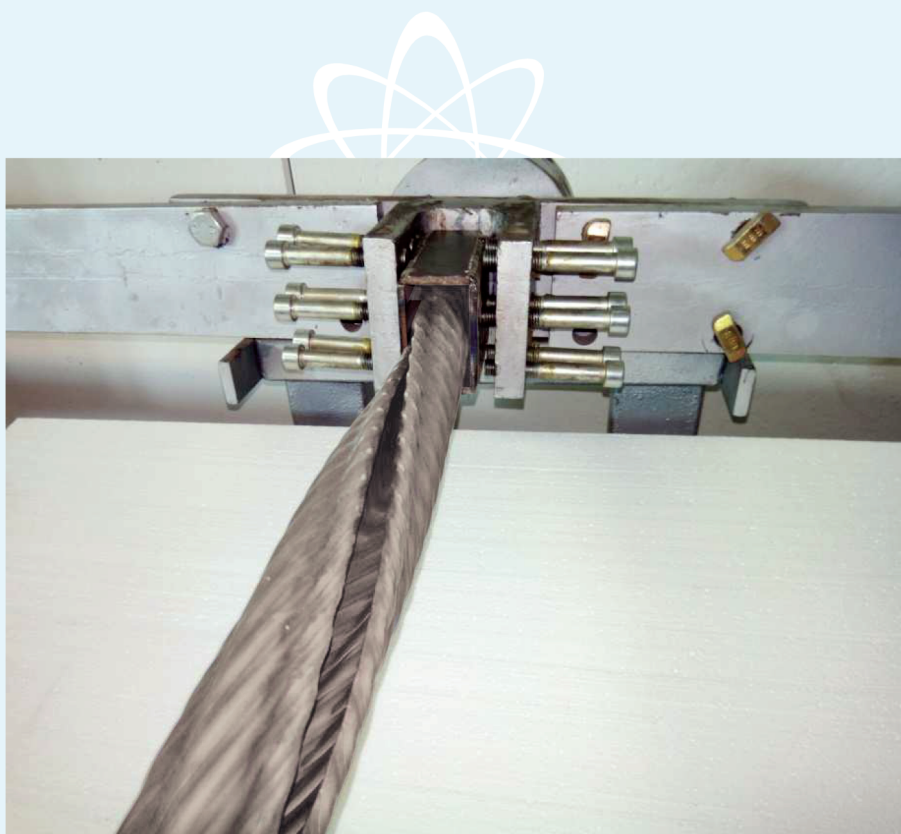

Photo of a steel section during testing

Test results

Section [No.]	Maximum applied torque [Nm]
1 - smooth	87,2
2 - smooth	87,0
3 - smooth	85,5

Section [No.]	Maximum applied torque [Nm]
4 - ribbed	112,0
5 - ribbed	114,6
6 - ribbed	116,0



Photos of a smooth and ribbed section whilst being clamped

Test Technician:
Dott. Ing. Michele Ianniello

Head of Building Materials Laboratory:
Dott. Geol. Gianluca Ferraiolo

Chief Executive Officer
(Dott. Arch. Sara Lorenza Giordano)

Firmato digitalmente da SARA LORENZA GIORDANO



CISQ is a member of



The International Certification Network
www.iqnet-certification.com

CERTIFICATO N.
CERTIFICATE No.

ICIM-9001-001234-08

SI CERTIFICA CHE IL SISTEMA DI GESTIONE PER LA QUALITÀ DI
WE HEREBY CERTIFY THAT THE QUALITY MANAGEMENT SYSTEM OPERATED BY

MOLLIFICIO ASTIGIANO S.R.L. - SOCIETA' BENEFIT

UNITÀ OPERATIVA / OPERATIVE UNIT

Via Alessandria, 19 14047 Belveglio AT IT - Italia

È CONFORME ALLA NORMA / IS IN COMPLIANCE WITH THE STANDARD

UNI EN ISO 9001:2015

Sistema di Gestione per la Qualità / Quality Management System

PER LE SEGUENTI ATTIVITÀ / FOR THE FOLLOWING ACTIVITIES

EA: 17

Progettazione e produzione di molle e componenti elastici attraverso operazioni di avvolgimento, piegatura, molatura, stabilizzazione, collaudo e spedizione.

Design e manufacturing of mechanical springs and elastic components through operation as coiling, bending, grinding, stress relief treatment, final testing ad shipping.

Riferirsi alla documentazione del Sistema di Gestione per la Qualità aziendale per l'applicabilità dei requisiti della norma di riferimento.
Refer to the documentation of the Quality Management System for details of application to reference standard requirements.

Il presente certificato è soggetto al rispetto del documento ICIM "Regolamento per la certificazione dei sistemi di gestione" e al relativo Schema specifico.
The use and the validity of this certificate shall satisfy the requirements of the ICIM document "Rules for the certification of company management systems" and specific Scheme.

Per informazioni puntuali e aggiornate circa eventuali variazioni intervenute nello stato della certificazione di cui al presente certificato, si prega di contattare il n° telefonico +39 02 725341 o indirizzo e-mail info@icim.it.

For timely and updated information about any changes in the certification status referred to in this certificate, please contact the number +39 02 725341 or email address info@icim.it.

DATA EMISSIONE
FIRST ISSUE
20/05/1999

EMISSIONE CORRENTE
CURRENT ISSUE
20/05/2023

DATA DI SCADENZA
EXPIRING DATE
19/05/2026

Rappresentante Direzione / Management Representative
ICIM S.p.A.

Piazza Don Enrico Mapelli, 75 - 20099 Sesto San Giovanni (MI)
www.icim.it



SGQ N° 004 A







www.cisq.com

CISQ è la Federazione Italiana di Organismi di
Certificazione dei sistemi di gestione aziendale. CISQ
is the Italian Federation of management system
Certification Bodies.

SIRMA ZINCATA

ORIGINAL

1.Exporter HEBEI JINSHI INDUSTRIAL METAL CO., LTD NO.158 HUAIAN EAST ROAD , SHIJIAZHUANG CITY, HEBEI PROVINCE,CHINA ***		Serial No. CCPIT0602600022190 Certificate No. 26C1300C0961/00018			
2.Consignee AMPELOS-PLUS SRL. CROCMAZ,STEFAN VODA.REP.OF MOLDOVA4218 TEL +373 69103469		 Certificate of Origin Accredited Chamber CN1300101		CERTIFICATE OF ORIGIN OF THE PEOPLE'S REPUBLIC OF CHINA	
3.Means of transport and route FROM XINGANG, CHINA TO CONSTANTZA ROMANIA BY SEA		5.For certifying authority use only  ISSUED RETROSPECTIVELY VERIFY URL: HTTP://CHECK.ECOCCPIT.NET/			
4.Country / region of destination ROMANIA					
6.Marks and numbers N/M	7.Number and kind of packages;description of goods SIXTY FIVE (65) PACKAGES OF HOT DIPPED GALVANIZED STEEL WIRE ***	8.H.S.Code 721720	9.Quantity 26 TONS	10.Number and date of invoices JSS251118 DEC.28,2025	
11.Declaration by the exporter The undersigned hereby declares that the above details and statements are correct, that all the goods were produced in China and that they comply with the Rules of Origin of the People's Republic of China.  河北金实金属制品有限公司 HEBEI JINSHI INDUSTRIAL METAL CO., LTD. SHIJIAZHUANG, CHINA FEB.09,2026 Place and date,signature and stamp of authorized signatory		12.Certification It is hereby certified that the declaration by the exporter is correct.  ADDRESS:NO 466 TAIHUA STREET, SHIJIAZHUANG CITY, HEBEI CHINA FAX:0311-87832953 TEL:0311-87820711 SHIJIAZHUANG, CHINA FEB.09,2026 Place and date,signature and stamp of certifying authority			



中华人民共和国海关出口货物报关单

021720250000380564



预录入编号: 021720250000380564

海关编号: 021720250000380564

(天津东疆关)

仅供核对用

页码/页数: 1/1

境内发货人 (91130108674678942P) 河北金实金属制品有限公司	出境关别 (0217) 天津东疆关	出口日期	备案号
境外收货人 AMPELOS-PLUS SRL.	运输方式 (2) 水路运输	运输工具名称及航次号 MAENSKOWLOON/552E	申报日期 20251224
生产销售单位 (91130108674678942P) 河北金实金属制品有限公司	监管方式 (0110) 一般贸易	征免性质 (101) 一般征税	提运单号 262294708
合同协议号 JSS251118	贸易国 (地区) (MDA) 摩尔多瓦	运抵国 (地区) (ROU) 罗马尼亚	许可证号
包装种类 (99) 其他包装	件数 65	净重 (千克) 26000	成交方式 (3) FOB
随附单证及编号 随附单证2:代理报关委托协议 (电子)	毛重 (千克) 26000	运港 (ROU006) 康斯坦察 (罗马尼亚)	离境口岸 (120001) 天津
其他包装		运费	保费
			杂费

标记唛码及备注
备注: N/M 集装箱标箱数及号码: 1;SUDU1419428;

项号	商品编号	商品名称及规格型号	数量及单位	单价/总价/币制	原产国(地区)	最终目的国(地区)	境内货源地	征免
1	7217200000	镀锌钢丝 0 0 丝 非合金钢 镀锌 碳0.45%、硅0.21%、锰0.39%、硫0.027%、磷0.02% 锌 卷	26000 千克	929.1538 24158.00 美元	中国 (CHN)	罗马尼亚 (ROU)	(13019)石家庄其他	照章征税 (1)

特殊关系确认:	价格影响确认:	支付特许权使用费确认:	公式定价确认:	暂定价格确认:	自报自缴: 否	水运中转:
---------	---------	-------------	---------	---------	---------	-------

报关人员 申报单位 (911320) 18MA06X57512)天津宝山国际货运代理有限公司	报关人员证号02103448 电话	签字申明对以上内容承担如实申报、依法纳税之法律责任 申报单位 (签章)	海关批注及签章
--	----------------------	--	---------

