

Anexa 2 Dispozitiv de terapie cu unde de soc, Model: Impactis M+, Astar,

Nr. de inregistrare AMDM: DM000663229

Specificarea tehnică deplină solicitată, Standarde de referință	Specificarea tehnică deplină oferita, Standarde de referință
Parametrii tehnici Specificația Compresor de presiune integrat 1-5 bar Moduri de emisie a undelor de șoc Single, continuu, burst Presiune reglabilă Moduri de frecvențe De la 1 la min. 20 Hz Frecvență reglabilă Număr de șocuri reglabil Programe presetate reglabile min. 5 Protocoale prestabilite min. 10 LCD tactil, color min. 7 inch Aplicatoare shockwave min. 3 Diametru aplicatoare 10, 15, 20 mm Alimentare 220V Opțional Chit de mentenanță 1 buc	Parametrii tehnici Specificația Compresor de presiune integrat 1-5 bar - broșura Moduri de emisie a undelor de șoc Single, continuu, burst Presiune reglabilă – manual pag 33 Moduri de frecvențe De la 1 la min. 25 Hz - broșura Frecvență reglabilă – manual pag 33 Număr de șocuri reglabil -manual pag 41 Posibilitate de setare de programe de către utilizator – 50-- broșura Protocoale prestabilite - 44 - broșura LCD tactil, color, 7 inch - - broșura Aplicatoare shockwave – 4 buc – manual pag 56 Diametru aplicatoare 10 oțel inox, , 15 oțel inox,15 titan, 20 mm oțel inox – manual 56 Alimentare 100-240V - broșura Opțional Chit de mentenanță 1 buc – manual pag 56



Impactis M+

Shockwave therapy



Features

product code	A-UF-AST-IMM+
color display with touch panel	7"
independent treatment channels	1
manual mode	✓
disease entities selected by name, medical field, anatomical mode or by search	✓
program list sorting in alphabetical order	✓
preset treatment programs database	✓
user-defined programs database	✓
favorite programs	✓
possibility of program names edition	✓
encyclopedia describing the treatment methodology	✓
statistics of performed treatment procedures	✓
parameter setting / adjustment knob	✓
STAND BY mode	✓

Shockwave therapy

shockwave emission modes: single, continuous, burst, interval	✓
applicator with a built-in shock spring absorber	✓
ergonomic shape of the ultrasound head improving comfort of operation	✓
ballistic system life time - 2,000,000 shocks	✓
ballistic system current control	✓
the regeneration kit allows you to perform another 2,000,000 shocks	✓
transmitter 35 mm	✓
titanium transmitters (10, 15, 20 mm)	✓
stainless steel transmitters (10, 15, 20 mm)	✓

Preset treatment programs

built-in treatment programs, including:	44
user configurable programs	50

Shockwave therapy technical parameters

compressor pressure	1-5 bar
pulse emission frequency (shocks)	1-25 Hz
number of shocks	1-10 000
max. energy density on the transmitter surface	0,38 mJ/mm ²
ballistic system life-time	> 2 million shocks

General technical parameters

dimensions	36,1 x 30,4 x 15,1 cm
device weight	7 kg
power supply, power consumption	100-240 V, 50/60 Hz, 24VDC 6,25A



IMPACTIS M+
user manual



Contents

1.	INTRODUCTION	5
1.1	MANUFACTURER	5
1.2	RISK MANAGEMENT PROCESS	5
2.	INTENDED USE	6
2.1	INTENDED USERS	6
2.2	USER TRAINING	7
3.	WARRANTY AND MANUFACTURER'S RESPONSIBILITY.....	8
4.	OPERATIONAL SAFETY	9
4.1	MAINS SUPPLY AND OPERATION MODE.....	9
4.2	STORAGE, OPERATION AND TRANSPORT CONDITIONS	9
4.3	WARNINGS AND SAFETY NOTES	10
4.4	EXPLOSION PROOF ENVIRONMENT.....	12
4.5	ELECTROMAGNETIC ENVIRONMENT	12
4.6	APPLIED PART.....	12
4.7	ESSENTIAL PERFORMANCE	13
4.7.1	<i>Tests of essential performance and basic safety</i>	13
4.8	DISPOSAL	14
5.	UNIT DESCRIPTION	15
5.1	GENERAL CHARACTERISTICS	15
5.2	FRONT PANEL.....	16
5.2.1	<i>START/STOP Key</i>	16
5.2.2	<i>STANDBY Key</i>	16
5.2.3	<i>Knob</i>	16
5.3	REAR AND SIDE PANELS, SERVICE SOCKETS	16
5.4	NAME PLATE	17
5.5	PROTECTION	17
5.5.1	<i>Vapors removal system</i>	17
5.5.2	<i>Safety valve</i>	17
5.6	SHOCKWAVE THERAPY APPLICATOR	17
5.7	TROLLEY (AN OPTIONAL ACCESSORY).....	18
5.8	TROLLEY TRANSPORT POSITION	19
6.	DEVICE INSTALLATION AND START-UP	20
6.1	INSTALLATION	20
6.1.1	<i>Mounting of applicator holder</i>	21
6.1.2	<i>Connection of shockwave therapy applicator</i>	22
6.1.3	<i>Installation of shockwave therapy transmitters</i>	23
6.1.4	<i>First operation</i>	26
6.2	SETUP MODE.....	26
6.2.1	<i>Basic information</i>	26
6.2.2	<i>Language</i>	27
6.2.3	<i>Global settings</i>	27
6.2.4	<i>Functional settings</i>	28
6.2.5	<i>Control functions</i>	29
6.2.6	<i>Information</i>	29
7.	UNIT OPERATION	31
7.1	PATIENT PREPARATION AND TREATMENT PERFORMANCE	31
7.2	SCREEN CONFIGURATION	32
7.3	DISPLAY DESCRIPTION	33
7.4	OPERATION WITH PRESET TREATMENT PROGRAMS	33
7.5	ANATOMICAL MODE OF OPERATION.....	35
7.6	MANUAL MODE OF OPERATION	36
7.7	USER PROGRAMS	37
7.8	FAVORITE PROGRAMS	38
7.9	SEARCH FUNCTION	38
7.10	SORTING FUNCTION.....	39
7.11	SAFE SHUTDOWN PROCEDURE.....	39

8.	DEFINITIONS AND PARAMETERS	40
8.1	SHOCKWAVE THERAPY CHARACTERISTICS AND ITS IMPACT ON THE BODY	40
8.2	TREATMENT PARAMETERS	41
9.	INDICATIONS AND CONTRAINDICATIONS	43
9.1	INDICATIONS	43
9.1.1	<i>Orthopedics and sports medicine</i>	43
9.1.2	<i>Aesthetic medicine</i>	43
9.2	CONTRAINDICATION	43
9.2.1	<i>Absolute</i>	43
9.2.2	<i>Application restrictions for shockwave therapy</i>	44
9.3	POSSIBLE SIDE EFFECTS	44
10.	MAINTENANCE, CLEANING, DISINFECTION	45
10.1	CLEANING OF THE UNIT AND SWITCH MODE POWER SUPPLY CASING	45
10.2	CLEANING OF TOUCHSCREEN	45
10.3	CLEANING AND DISINFECTION OF THE APPLICATOR	45
10.4	INFORMATION – MESSAGES	46
10.5	PROJECTILE SYSTEM REPLACEMENT	48
10.6	TRANSMITTER REPLACEMENT	50
10.7	TROUBLESHOOTING	51
10.8	FUSE REPLACEMENT	52
11.	SPECIFICATION AND ACCESSORIES	53
11.1	TECHNICAL DATA	53
11.2	EMC PARAMETERS	54
11.3	STANDARD ACCESSORY	56
11.4	ADDITIONAL ACCESSORY	56
12.	APPENDIX A. SYMBOL DESCRIPTION	57
12.1	CONTROLLER, APPLICATOR, PACKAGINGS	57
12.2	SWITCHED-MODE POWER SUPPLIES – CASING	59
13.	APPENDIX B. LIST OF PRESET TREATMENT PROGRAMS	61
13.1	ORTHOPEDICS AND SPORTS MEDICINE	61
13.2	AESTHETIC MEDICINE	70

Figure list

Figure 4.1	Forced cooling mode screen	11
Figure 5.1	General view	15
Figure 5.2	Left side panel view	16
Figure 5.3	Shockwave applicator	18
Figure 5.4	Impactis M+ placed on the trolley – front and rear view	19
Figure 6.1	Acclimatization screen	20
Figure 6.2	Applicator holder mounting	21
Figure 6.3	Correct position of the applicator	21
Figure 6.4	Incorrect position of the applicator	21
Figure 6.5	Socket label	22
Figure 6.6	Screen view – date and time edition	27
Figure 6.7	Transmitter selection window	28
Figure 7.1	Field description – manual mode	32
Figure 7.2	An example of the appearance of a treatment screen	33
Figure 7.3	Sample view of the enlarged illustration	35
Figure 7.4	Anatomical mode screen	35
Figure 8.1	Time dependencies in „Burst“ mode	42
Figure 10.1	The unit error signaling and information visible after closing of the error message	47
Figure 10.2	The information screen – applicator not detected during the self-test	47
Figure 10.3	The screen with information about approaching necessity of replacing projectile chamber	48
Figure 10.4	The screen with information about necessity of replacing projectile chamber	48
Figure 10.5	The screen with information about approaching necessity of replacing transmitter	50
Figure 10.6	The screen with information about necessity of replacing transmitter	50

1. Introduction

Read this manual carefully before starting the unit operation! Follow the recommendations presented in this manual!

The shockwave therapy unit Impactis M+ should be installed by the seller. The recipient has the right to insist on the product operation training.

The unit may only be operated by qualified personnel or under supervision of such personnel!

WARNING: The device is intended for adult patients only. It is not intended for use in a home healthcare environment.

Description of symbols used in this manual:



Read appropriate passage of this user manual, warnings or important information. Failure to observe warnings can lead to injuries.



Important notices and information.



Following texts marked with this symbol facilitates device operation.

NOTE:

The outlook of screens shown in this manual may slightly differ from their actual outlook during device operation. These differences may concern size and type of fonts and size of symbols. There are no differences in the content of shown information.

NOTE:

This manual contains information for use and technical description.

WARNING: No modification of this equipment is allowed!

1.1 Manufacturer

ASTAR Sp. z o.o.

p

43-382 Bielsko-" h and

www.astar.eu

1.2 Risk management process

The manufacturer conducts continuous risk management process referring to the device construction, its intended use, method of operation and maintenance. Residual risks are presented in this User Manual in form of information about precautions, contraindications and warnings.

2. Intended use

Shockwave physiotherapy unit Impactis M+ is an active, non-invasive therapeutic device.

Impactis M+ is a generator of high amplitude acoustic pulses generated by a precise ballistic system in a special applicator. Acoustic pulses are created by a projectile hitting (driven by compressed air) a transmitter, as a result of which the kinetic energy of the projectile is converted into acoustic energy. The resulting pressure impulses propagate radially in the skin and in deeper tissues. The waves produced in this way are classified as pressure acoustic waves.

Medical devices based on of the above-mentioned principle are generally described in modern medical literature as extracorporeal shockwave systems. This is due to the similarity of therapeutic effects achieved by means of radial acoustic waves to shockwave effects in the range of indications. The terms RSWT (radial shockwave therapy) and RPW (radial pressure wave therapy) are used interchangeably. Therefore, the generated pulses are called later in the manual as shockwaves.

In order to ensure proper transmission of the produced energy to the body a coupling gel or other element ensuring the fit of the transmitter and tissue (e.g. gel pad) should be used. The applicator transmitter stays in contact with the skin for the entire duration of the treatment. Adequate characteristics of the shockwave therapy impact can be achieved due to the availability of various types of transmitters.

Detailed information about biological effects of shockwave is described in section **8.1**. Shockwave is one of the most effective ways to treat pain in musculoskeletal disorders.

The shockwave can be used to treat diseases in the following areas:

- € orthopedics,
- € rehabilitation,
- € sports medicine,
- € aesthetic medicine.

The list of indications and contraindications is given in Chapter 9.

The unit has got built-in base of 44 ready-therapeutic procedures (see Appendix B) procedures along with electronic encyclopedia, which significantly increases the comfort of operation. There is also a possibility to create own user-defined programs and sequences.

2.1 Intended users

The patient should not be the operator.

Users (operators) of Impactis M+ can be:

- € specialists in the field of the therapy of the musculoskeletal system,
- € physiotherapists specializing in the therapy of the musculoskeletal system,
- € sports medicine specialists,
- € aesthetic medicine specialists,
- € trained personnel performing treatments under the supervision of the above-mentioned specialists.

The user should have:

- € knowledge about the indications and contraindications for the use of shockwave therapy,
- € knowledge of the terminology and technical terms used in the manual (e.g. knowledge of units of physical quantities),
- € practical skills in performing therapeutic treatments using devices in which impacts (acoustic impulses) are generated in the pneumatic system, resulting from education, experience and training.

Physical and cognitive requirements of the operator:

- € eyesight enabling to recognize elements of screen and keyboard,
- € hearing enabling to hear the patient's voice,
- € reading comprehension that allows to read the instructions of use and information on the screen of the device,
- € two functional upper limbs that allow to perform treatments and other activities related to the operation of the device (e.g. cleaning of the applicator),
- € age in the range of admissible value of professional activity (depending on the regulations of the country where the device is used).

2.2 User training

The Impactis M+ user has to be properly trained in the device safe and effective use, before starting the operation. Training in the rules of operation can be carried out by representatives of the manufacturer or seller, based on this user manual.

Recommended training positions:

- € information about the intended use of the device,
- € occupational safety information,
- € information on the construction and method of the shockwave generation,
- € information on available settings and operation modes,
- € instructions for use,
- € indications and contraindications for the therapy,
- € information on recommended maintenance, cleaning and disinfection,
- € handling in the event of a technical malfunction.

Due to requirements of local law and regulations in different countries, additional training activities may be required. The user should inform the seller about such requirements in order to receive complete information.

3. Warranty and manufacturer's responsibility

The manufacturer warrants the controller and applicator to be free of faults for the period of time and conditions stated in Warranty Certificate. The manufacturer also provides post-warranty service for a period of 10 years from launching the unit onto the market. Warranty includes all material and workmanship faults.

The manufacturer provides a limited warranty for parts generating shock waves:

- € transmitters – 2 million shocks,
- € projectile system (alternatively called ballistic system) – 2 million cycles.

Any operating component should be replaced after 2 million cycles.

The manufacturer undertakes to observe the warranty agreement, if the following conditions are met:

- € all repairs, changes, extensions and calibrations of equipment are performed by manufacturer or authorized service personnel,
- € the mains supply system in the treatment room meets requirements of standards in force,
- € the unit is operated by qualified personnel, in compliance with instructions presented in this manual,
- € the unit is operated in compliance with its tended use.

The warranty does not cover consumables, i.e. connecting cables, mains cables, holders and fuses, as well as faults or damage caused by:

- € improper placement, installation, or configuration of the device,
- € misuse or failure to observe the instructions presented in this user manual,
- € inaccurate or inadequate maintenance carried out by the operator,
- € improper environmental conditions specified for the product,
- € unauthorized opening of the outer casing,
- € adjustment and/or unauthorized tuning,
- € use of non-original accessories.

The warranty does not cover any damage due to a failure to adhere to the recommendations stated in Chapter 10 hereof.

The manufacturer is not liable in case of transmission of infection by equipment components.

The expected "life time" of the device is 10 years.

After elapse of 10 years from date of introduction of device and accessories in the market the manufacturer is not liable for device and accessories faults or its consequences. After elapse of the expected life time of the device the user bears the complete responsibility for the occurrence of medical incidents.

The manufacturer bears no responsibility for results of faulty installation, wrong diagnosis, wrong use of the device and equipment, failure to observe user manual and performance of repairs by unauthorized persons.

A list of items which may be user replaceable:

- € **fuse,**
- € **shockwave transmitters,**
- € **ballistic system,**
- € **O-rings and elastomer springs of shockwave transmitters.**

Do not operate the applicator without properly secured transmitter. Failure to observe this instruction may result in applicator damage not covered under warranty.

No parts can be serviced or maintained when the device is in use with a patient.

On demand, the manufacturer makes available technical diagrams, parts lists, descriptions, instructions for calibration or other helpful information to appropriately qualified user's technical staff to repair these parts of unit, which are described by the producer as a repairable.

4. Operational safety

4.1 Mains supply and operation mode

The unit is designed for supply from AC mains with rating 100-240 V and frequency 50/60 Hz. It is a medical device under safety class II, type BF. The unit may be used only in rooms, where the electric system is executed in compliance with standards in force. The unit is intended for non-continuous operation. See the details about the mode of operation in chapter 4.3.

An external switched-mode power supply treated as part of the device is the source of supply for the device. Two models are allowed to be used with the device:

- € type AHM150PS24C2-8 by XP Power, constant output voltage 24V, rated current 6.25A,
- € type GSM160B24-R7B1 by Mean Well, constant output voltage 24V, rated current 6.67A,
- € type HPU150B-108 by Sinpro, constant output voltage 24V, rated current 6.25A.

The power supply is connected to the mains using the detachable power cord. The power supply cord is equipped with a mains plug that isolates the device from the supply mains on all poles simultaneously.

The socket in the device where the plug of the switched-mode power supply is connected is marked with  and safety sign ISO 7010 - M002.

Connecting to the mains and the proper operation of the switched-mode power supply is signaled:

- € by the green LED indicator located on the housing of the switched-mode power supply type AHM150PS24C2-8 by XP Power,
- € by the blue LED indicator located on the housing of the switched-mode power supply type GSM160B24-R7B1 by Mean Well,
- € by the green LED indicator located on the housing of the switched-mode power supply type HPU150B-108 by Sinpro.

Recommendations related to isolation the device from the supply mains:

- € **Do not position the Impactis M+ so that it is difficult to operate the disconnection of the device from the supply mains.**
- € **To isolate the device from the supply mains, hold the mains socket-outlet with one hand, grasp the mains plug with second hand and disconnect it from the mains socket-outlet.**

Disconnection from the mains takes place after:

- € **switching the mains switch to the "0" position,**
- € **removing the mains cable plug from the mains power socket,**
- € **removing the SMPS output cord plug from the socket on the unit.**

4.2 Storage, operation and transport conditions

The unit must be stored in closed rooms, where the atmosphere is free from vapors and caustic substances and:

- € the temperature is maintained between +5°C to +45°C,
- € relative humidity does not exceed 75%,
- € atmospheric pressure value is between 700 hPa and 1060 hPa (70 – 106 kPa).

The unit is intended for operation under the following conditions:

- € ambient temperature between +15°C to +30°C,
- € relative humidity between 30% to 75%,
- € atmospheric pressure between 700 hPa and 1060 hPa (70 – 106 kPa).

If further transport of the device is required, use the delivery packaging. Transport shall be performed with covered transport means. Recommended transport conditions:

- € ambient temperature between -10°C to +45°C,
- € humidity between 20% to 95%,
- € atmospheric pressure between 700 hPa and 1060 hPa (70 – 106 kPa).

4.3 WARNINGS and safety notes

The Impactis M+ unit has been designed and manufactured in such a way that its use does not jeopardize the health and safety of patients, users and third parties, as well as the unit should provide a therapeutic benefits to patients if it is operated in appropriate conditions and in accordance with its intended purpose.

General information:

- € Impactis M+ may be operated by qualified personnel in compliance with instructions presented further in this manual.
- € **No modification of this equipment is allowed!**
- € The treatment station (bed, couch, chair) shall be located away from other electric devices and water supply / sewerage installation / central heating system, so that it is impossible for the patient to touch any of them during treatment procedure.
- € Do not position the Impactis M+ so that it is difficult to operate the disconnection of the device from the supply mains.
- € Do not remove warning signs and labels put by the manufacturer on the unit and accessories casings.
- € The unit and applicator shall be protected against high temperatures and atmospheric conditions (e.g. direct sunlight).
- € Damaged cables and/or applicators shall be replaced immediately. Pay special attention to the casing cracks, threadbare isolation and partially torn interconnecting cables.
- € Shockwave transmitters and the projectile system should be replaced every one million shocks in order to maintain optimum generation.
- € Prevent any fluid from penetrating inside the unit and applicator. In case of any fluid getting inside the unit, switch the unit immediately off, isolate from the mains and contact service to inspect the unit.
- € By any means do not cover the vents. Do not insert any objects into the ventilation socks.
- € The unit may be only used with accessories, spare parts, disposable items which have been determined to be safe and appropriate inspection bodies have not issued contraindications against their use.
- € To ensure correct detection of the applicator, connect it into the applicator socket only when the unit is switched off! We strongly recommend not to disconnect the applicator at a time when treatment is performed.
- € After switching the unit off, wait for 10 seconds before you switch it on again.
- € Each serious incident concerned with the device should be reported to the manufacturer and competent authority of the country, where the user or patient resides. Serious incident means any incident that directly or indirectly led, might have led or might lead to any of the following:
 - § the death of a patient, user or other person,
 - § the temporary or permanent serious deterioration of a patient's, user's or other person's state of health,
 - § a serious public health threat.

Electromagnetic compatibility:

- € It is recommended to use original accessories, spare parts and equipment of Astar ABR. Use of accessories, transducers and cables other than those specified or provided by the manufacturer of this equipment could result in increased electromagnetic emissions or decreased electromagnetic immunity of this equipment and result in improper operation.
- € Use of the Impactis M+ adjacent to or stacked with other equipment should be avoided because it could result in improper operation. If such use is necessary, the Impactis M+ and the other equipment should be observed to verify that they are operating normally.
- € Portable RF communications equipment (including peripherals such as antenna cables and external antennas) should be used no closer than 30 cm (12 inches) to any part of the Impactis M+, including cables specified by the manufacturer. Otherwise, degradation of the performance of this equipment could result.

Occupational Health and Safety – increased noise level:

- € If the noise is bothersome for the operator, you can use hearing protection measures. Recommended accessories:
 - § hearing protector Uvex 3, Art. No. 2500.002,
 - § single-use earplugs Uvex xact-fit, Art. No. 2124.001.Hearing protective measures should be CE marked.

Thermal protection:

- € The device has a thermal sensor controlling the temperature of the pressure generating compressor. Occasionally, if operated with maximum parameters for a long period of time, the compressor temperature can increase to the limit where it stops. The treatment session is stopped then, the W5 code will display on the screen to report the overheating and the device will be blocked. This safety function protects the compressor from premature wear and damage.
- € The therapy can be proceeded after the compressor cools down. Minimum recommended cooling time after the W5 error was detected, is 30 minutes. Suitable information is presented on the label adjacent to the name plate.
- € In order to avoid blockage due to overheating, the device is equipped with additional forced cooling mode. It activates, if the temperature of the compressor approaches the limit value. The sequence of operation of this mode allows you to finish the program after which a screen similar to the acclimatization screen is activated (see 6.1).

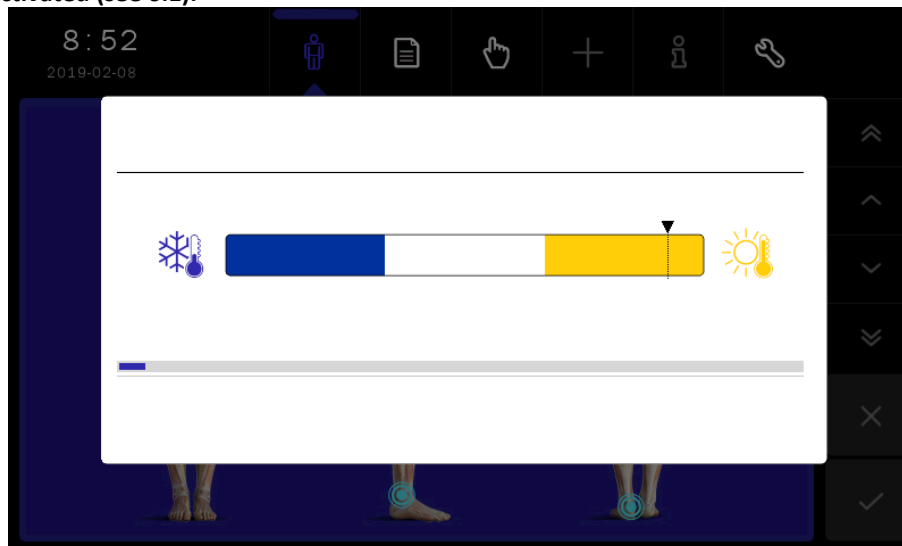

Figure 4.1 Forced cooling mode screen

The process of the forced cooling lasts 15 minutes maximally. If in this period of time the cooling systems is not able to decrease the temperature to the required level, the W5 code will display on the screen to report the overheating and the device will be blocked. The therapy can be proceeded after the compressor cools down. Minimum recommended cooling time after the W5 error was detected, is 30 minutes.

- € The mix mode of operation, when different parameters in the manual mode and different preset programs are applied, doesn't cause of the temperature increase to its limit value.

Therapeutic:

- € The device is intended for adult patients (patient has to be conscious). Minor patients – only on the doctor's explicit recommendation, after considering contraindications.
- € It is impermissible for the patient to carry out the treatment on their own.
- € Before performing the treatment, make sure there are no contraindications to its implementation. It is recommended to perform patient diagnostic tests (USG, computed tomography, magnetic resonance imaging) in order to make the correct diagnosis.
- € Patients with implanted electronic devices (e.g. cardiac pacemakers) or other metal implants should consult a physician prior to treatment.
- € Treatment parameters should be consistent with the medical indications.

- ⌘ **Take special care with patients with disturbed surface sensation.**
- ⌘ **Sitting or reclining position should be applied to patients with respiratory disorders or breathing difficulties.**
- ⌘ **Treatments can cause disturbances in the form of increased or decreased sensitivity threshold at the site of treatment.**
- ⌘ **Pressure pulses may cause undesirable heart action.**
- ⌘ **Use a coupling gel for ultrasound devices. The gel should be a medical equipment, marked with the conformity mark (the CE mark in EU). Avoid using a gel with undocumented origin.**
- ⌘ **It is strongly forbidden to treat pregnant women or women with the likelihood of pregnancy.**
- ⌘ **It is not recommended to perform treatment in the area of the brain, chest and lungs, spinal cord, point clusters of large nerves (the skull, spine, ribs), peripheral nerves and vascular structures, sites of implanted foreign body (e.g. endoprosthesis, implants).**
- ⌘ **Do not perform treatments on patients under the influence of alcohol.**
- ⌘ **Do not perform treatments on patients under the influence of intoxicants.**
- ⌘ **Patients should be informed about the possible side effects – unwanted pain sensation during and after treatment, reddening, hematoma, bruises, local swelling, mild numbness, tingling, dizziness, nausea, cardiac dysfunction, skin injuries following prior corticosteroid therapy – especially when using high energy pulses (> 0,60 mJ/mm²).**
- ⌘ **While performing the treatment, special attention should be paid to the level of patient's pain sensation – settings and intensity of treatment must be adapted to the current feelings.**
- ⌘ **It is necessary to keep the records of treatment, including the parameters of the therapy, the area of treatment, treatment technique, dose and symptoms after therapy.**
- ⌘ **It is necessary to ensure the adequate interval between treatments for the patient, in order to avoid an increase of the risk of complications.**

4.4 Explosion proof environment

The Impactis M+ is not adopted to operation in rooms, where combustible gases or their vapors occur. It is recommended to avoid anesthetic or oxygen derivate gases, such as nitrous oxide (N₂O) and oxygen. Some materials, e.g. cotton, after oxygen saturation can be burned at high temperatures generated during normal use of the device. It is recommended that solutions of adhesive and combustible solvents be vaporized before equipment is operated. It is also recommended to pay attention to the danger of ignition of endogenous gases. The unit must be separated from the mains before approaching the disinfection room, where it is installed.

4.5 Electromagnetic environment

Warnings concerning electromagnetic compatibility are given in the chapter 4.3.

Due to the intended use the device can be used in hospitals, clinics and other health care facilities under the supervision of qualified personnel.

Simultaneous operation of the Impactis M+ unit with devices generating strong electromagnetic field, such as short wave and microwave diathermies, high frequency surgical equipment, MRI systems, may disturb the unit operation. For this reason, it is recommended to maintain appropriate distance between these devices or to switch off the generator of strong fields during therapy with the Impactis M+ unit.

The Impactis M+ meets requirements of electromagnetic interference emission and immunity standards and shall not pose a threat to correct operation of the other devices. Compliance levels for emissions and immunity are given in the chapter 11.2.

4.6 Applied part

The Impactis M+ has BF type applied part with a single function. It includes the transmitter and the transmitter cup. These components are located in the front part of the shock wave applicator. They come into contact with the patient's body during treatment session.

The appropriate symbol of the BF type applied part is placed on the socket label.

4.7 Essential performance

With regard to Impactis M+, essential performance means the emission of an acoustic pressure wave which is generated in the transmitter as a result of the conversion of a projectile kinetic energy. The acoustic wave energy is delivered to the patient by direct contact with the application of a coupling medium, e.g. an ultrasound gel. The peak pressure of the wave shouldn't exceed 15 MPa, energy density should be less than 1 mJ/mm². The peak pressure and energy density values, determined with a maximum compressor pressure of 5 bar are given in chapter 11. The safety valve is a protective measure against the rise of the wave pressure and energy density above the defined limits.

4.7.1 Tests of essential performance and basic safety

The User of Impactis M+ unit must perform technical inspection of the unit at year's intervals. The inspection must be performed by a service authorized by the manufacturer. The inspection is performed at the user's expense. Recommendations for test:

Test item	Method of checking	Acceptance criteria	Required measuring equipment
Safety test: € patient leakage current measurement, € touch current measurement, € insulation resistance if necessary	The manufacturer allows the methods compliant with the requirements of the standards: € IEC 60601-1 € IEC 62353	The measurement results are within the limits specified by the applied standard	Safety tester meeting the: € IEC 60601-1 € IEC 62353 requirements
Control of correctness of the performed self-test (includes the control of compressor pressure)	Visual inspection	No errors	No requirements
Evaluation of keyboard function and operation	Manual and visual inspection	The keys respond properly to pressure The knob turns without excessive resistance The unit responds to the knob turning The knob is illuminated	No requirements
Evaluation of touchscreen function and operation	Manual and visual inspection	The touch panel responds correctly to pressing	No requirements
Inspection of shocks counter and if necessary, replacement of transmitters and the projectile system	Visual inspection	The recommended values are not exceeded	No requirements
Inspection of the controller condition for casing defects and damage of sockets	Visual inspection	No deformation or cracks of the casing Undamaged sockets No loosened sockets	No requirements
Inspection of the applicator condition for casing defects and damage of interconnecting cables and connectors	Visual inspection	No deformation or cracks of the casing No tear and bending of cable insulation Undamaged connector	No requirements
Inspection of the SMPS condition for casing defects and damage of interconnecting cables and connectors	Visual inspection	No deformation or cracks of the casing No tear and bending of cable insulation Undamaged connector	No requirements

The inspection must also include verification of the quality of applied accessories and treatment materials.

Positive result of the technical inspection confirms that basic safety and essential performance is maintained.

4.8 Disposal

In case, when the disposal of the unit will become necessary (e.g. after elapse of its service life), please contact the manufacturer or manufacturer representative, which must react in an appropriate way i.e. collecting the unit from the user. The user may also contact companies specialized in removal and/or disposal of electrical devices or computer equipment.

The unit is marked with an appropriate symbol complying with the directive on waste electrical and electronic equipment (WEEE) – see table with description of the symbols used to label the product presented in **Appendix A**.

5. Unit description

5.1 General characteristics

Shockwave therapy unit **Impactis M+** is a highly specialized medical device based on modern microprocessor platform. The unit consists of two system structures – electronic and pneumatic system, which are controlled by the advanced micro controller.

Pneumatic system, which is the executive system generates a physical factor as a result of transformation of projectile kinetic energy inside the transmitter into acoustic pressure waves. The main elements of the pneumatic system consist of:

- compressor,
- container with a safety valve,
- electrovalve in the applicator,
- condenser and electrovalve to remove vapors from the pneumatic system.

The electronic system includes:

- micro controller module,
- user interface, which consists of LCD touch screen, illuminated knob for parameter selection and START/STOP and STANDBY keys,
- power circuits supplying the appropriate voltage,
- auxiliary circuits, e.g. fan control system, pump temperature, pressure and voltage measurement systems.

Microprocessor advanced electronic system:

- monitor all operating parameters and controls them in real time.
- controls the pneumatic system,
- cooperates with LCD touchscreen, screen is backlit and clearly illustrates and indicates different functions.

Impactis M+ has a plastic enclosure. The unit is equipped with a color touch LCD display with a diagonal of 17,8 cm (7"). The mains switch, fuse socket, mains socket and applicator connection socket are located on the left side panel. General view of the unit is presented in figure 5.1, view of the left side panel in figure 5.2.



Figure 5.1 General view



Figure 5.2 Left side panel view

5.2 Front panel

5.2.1 START/STOP Key

Pressing the START/STOP key results in generation after:

- € selection of a treatment program in program or anatomical mode,
- € selection of a treatment in user-defined program,
- € ending of parameters edition in manual mode.

Pressing START/STOP key while performing a treatment result is treatment interruption and automatically the unit enters the main menu. In order to interrupt the treatment – pause or resume, press the applicator button.

5.2.2 STANDBY Key

Pressing the STANDBY key turns off the display and automatically the unit enters the standby mode. The knob backlight blinks in the standby mode. While performing a treatment the STANDBY key is inactive.

5.2.3 Knob

Using the knob, you can:

- € change the value of edited parameter,
- € select shockwave therapy emission mode (continuous / single / burst / interval)
- € select preset treatment program from the list,
- € select an item in the menu.

The knob is backlighted while operation.

5.3 Rear and side panels, service sockets

On the unit's rear panel, vents are located. On the left side panel there are located:

- € unit mains switch,
- € fuse socket,
- € mains socket,
- € applicator socket.

On the right-side panel there are:

- € memory card slot,
- € service socket.



The memory card slot and service socket are intended only for service purposes performed by the authorized service of the manufacturer. It is forbidden for the operator to connect any cables or memory cards to these sockets.

These sockets, when used for service purposes, are used only to connect:

- € service socket (3.5 JACK) - a PC computer via a cable with an integrated FTDI communication module, with interface in USB-A and UART standard, with constant operating voltage V_{in} / V_{out} 3.3 V,
- € memory card slot – SD memory card, constant voltage V_{in} / V_{out} 3.3 V



The technical staff is not allowed to connect to service sockets cables with different specifications, adapters, readers, emulators and other devices.

Near the service sockets, there is a sign of the obligation to read the instructions for use of the device.



5.4 Name plate

The name plate is located on the bottom of unit casing. Among others there are following data on the name plate (see **Appendix A**):

- € device version,
- € serial number,
- € nominal voltage and maximum power consumption,
- € type of applied fuses,
- € manufacturer's data.

5.5 Protection

5.5.1 Vapors removal system

To prevent unit damage or decrease in the therapy effectiveness, the unit is equipped with a special, fully automated system of vapors removal. With this solution there is no need for daily verification of water level in the condenser and its periodic emptying, which in turn results in considerable time savings and comfort of **Impactis M+** operation.

5.5.2 Safety valve

In order to avoid exceeding the safe pressure level, the unit is equipped with a safety valve.

5.6 Shockwave therapy applicator

Impactis M+ unit emits radial shockwave by means of a special gun-shaped applicator. The projectile system is ended with a metal cap acting as a transmitter. The transmitter can be made of stainless steel or titanium. The transmitter is hit by a steel projectile driven by pressurized air at a maximum pressure of 5 bar. As a result, shock wave is formed, which radially spreads out – expands and focuses (depending on the transmitter applied) in the skin and in the first, underlying tissue layer.

On the handpiece there is a button which start and stop shocks generation. Picture of the applicator is shown in Figure 5.3.

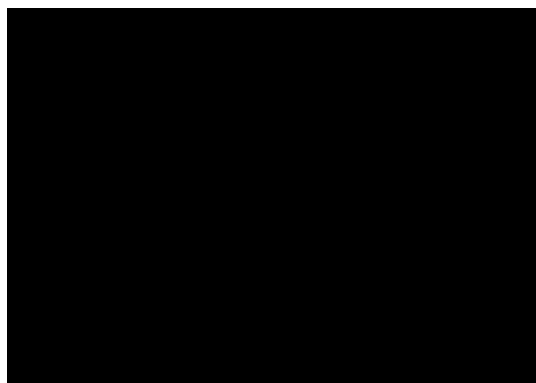

Figure 5.3 Shockwave applicator

Available transmitters types:

stainless steel		titanium	
€	TR10	€	TR10-TI
€	TR15	€	TR15-TI
€	TR20	€	TR20-TI
€	TR35		

Do not operate the applicator without properly secured transmitter. Failure to observe this instruction may result in applicator damage not covered under warranty.

Examples of application are presented below.

Applicator	Example	
Shockwave applicator		

5.7 Trolley (an optional accessory)

The Versa X trolley is dedicated to use as an optional accessory with the Impactis M+. The trolley is equipped in drawer, the towel holder, and the gel holders. The additional shelf with a magnet holder for power supply is mounted on the rear part of the trolley. The top shelf is dedicated to place the Impactis M+ device – it has dedicated basin for the device feet. See the figures below for details.



Figure 5.4 Impactis M+ placed on the trolley – front and rear view

The trolley is equipped in wheels with brakes. To lock the brake, press the lever down (bottom position of the lever). To unlock the brake, release the lever (top position of the lever).

5.8 Trolley transport position

Step	Description
1.	Disconnect the power supply from the device.
2.	Remove the device from the trolley.
3.	Unlock all brakes.
4.	Transport the trolley. Separately transport the device.
5.	Lock brakes after transport and placing in destination.
6.	Place the device on the top shelf and connect the power supply.

6. Device installation and start-up

6.1 Installation

The first installation should be performed by a qualified manufacturer's or distributor's representative!

After removing the unit from the carton, check if the complete unit has been delivered. In case of any inconsistencies contact the distributor or manufacturer.

After removing the unit from transportation packaging wait approximately two hours before proceeding to next installation steps. This is aimed at adaptation of the unit to conditions in operation room.

If this recommendation is not followed, a special unit acclimatization procedure will be activated. The procedure starts automatically after the unit is switched on, if the temperature of its interior is below 5°C. The display screen will show the following message along with the process progress bar:

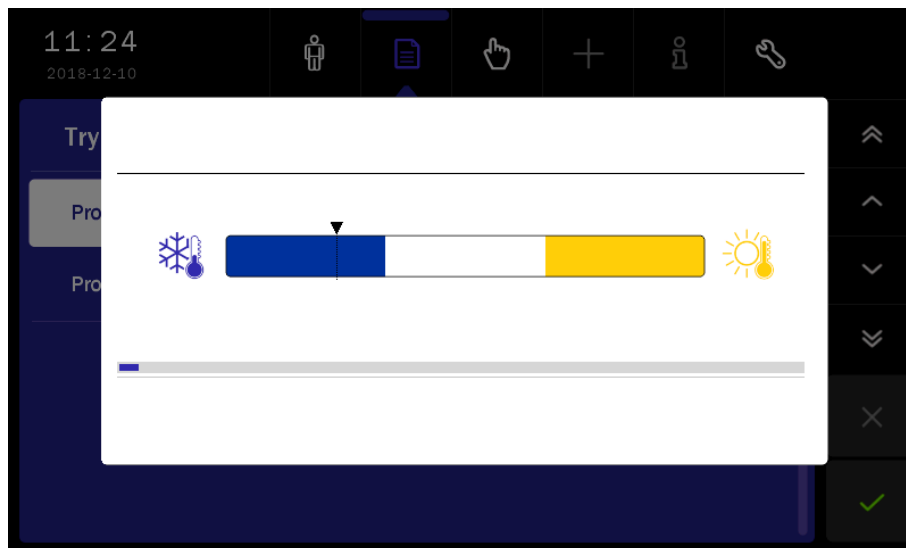

Figure 6.1. Acclimatization screen

Acclimatization lasts for a maximum of 10 minutes. If the temperature rises to its allowable value during that time, the normal use of the unit will be possible. If the process fails, the W6 error message will be displayed. Then, turn off the power and turn it on again.

If the acclimatization process is repeated, it can indicate the significant overcooling of the unit. In such a case, wait for up to two hours before you start further installation operations. If the acclimatization process is still repeated after that time, it indicates the temperature sensor failure. In such a case, contact the manufacturer's authorized service center.

The acclimatization process may also concern the device overheating. In this case, the process of forced cooling proceeds as described in chapter 4.3, section "Thermal protection".

Note: It is not recommended to turn off the unit during the acclimatization process!

The unit shall be placed on a table, trolley or in a cabinet near mains socket with power input 100-240 V and 50/60 Hz.

In case of application the other type of trolley or table it is recommended to place the unit at such a height that it would enable convenient operation from the front panel.

The light shall enable easy readout of display indicators, however the unit shall not be exposed to direct sunlight

6.1.1 Mounting of applicator holder

There is a possibility to mount the shockwave applicator holder into the unit's casing. The mounting method is shown in Figure 6.2.

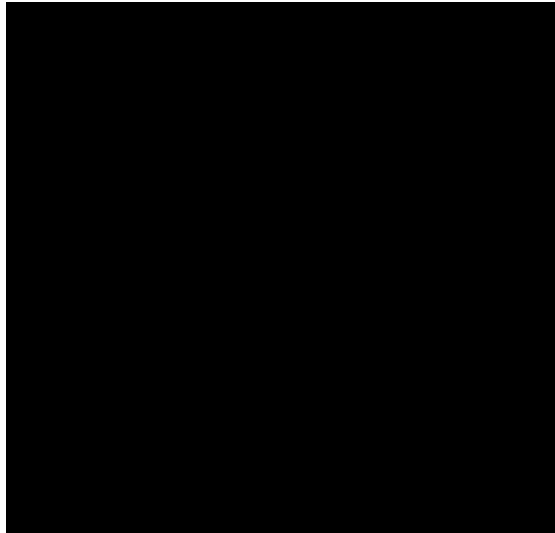

Figure 6.2 Applicator holder mounting

Recommended position of the applicator in the holder:



Figure 6.3 Correct position of the applicator

Incorrect position of the applicator in the holder:



Figure 6.4 Incorrect position of the applicator

6.1.2 Connection of shockwave therapy applicator

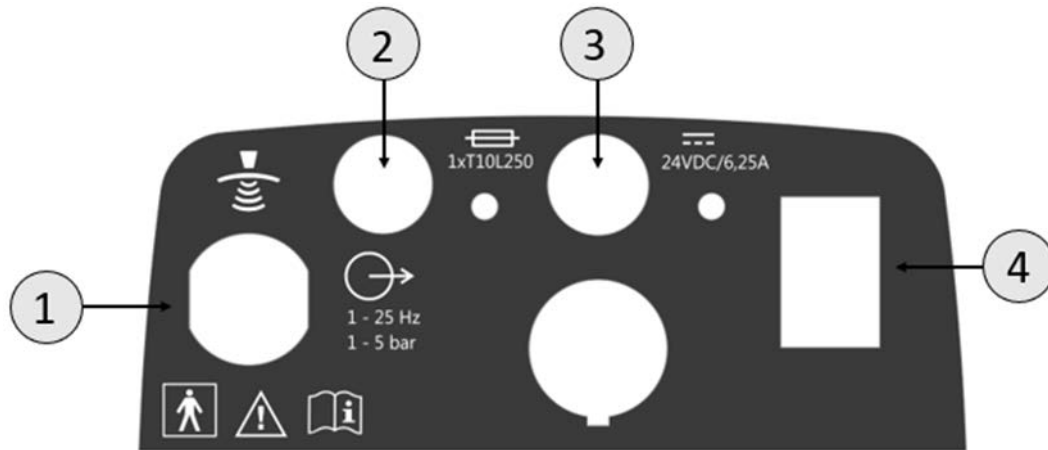



Figure 6.5 Socket label

Symbol	Description
1	Applicator socket
2	Fuse socket
3	Power socket
4	Power switch

Turn the unit off. Connect the applicator into the socket marked with  on the controller's left side panel. Please pay attention to proper locking of the plug into the socket. A distinctive “click” sound should be heard.

Impactis M+ automatically detects dedicated applicator manufactured by the manufacturer – there is no possibility to operate with applicators manufactured by other companies.

When removing the applicator plug:

Step	Description
1.	Turn the unit off.
2.	Wait for 20 sec. Pneumatic system reduces the pressure to ambient pressure.
3.	By left hand fingers, hold the rear part of the plug. By right hand fingers, pull the body back to release the blockade and gently disconnect it.

Strictly avoid disconnecting the applicator plug while operating the unit, as this may cause its damage.

6.1.3 Installation of shockwave therapy transmitters

Do not operate the applicator without properly secured transmitter. Failure to observe this instruction may result in applicator damage not covered under warranty.

Available transmitters:

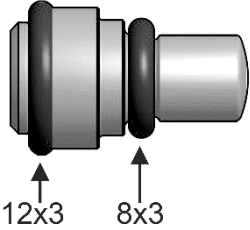
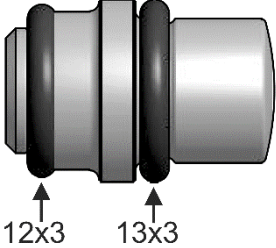
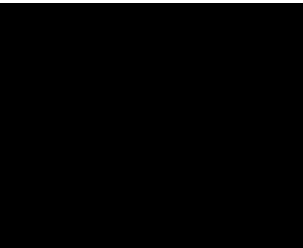
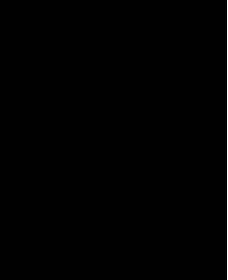
View	Characteristic
	<p>TR10</p> <ul style="list-style-type: none"> € Transmitter diameter: 10 mm € Cap T10 € O-ring 12x3 € O-ring 8x3 <p>NOTES: steel transmitter</p> <hr/> <p>TR10-TI</p> <ul style="list-style-type: none"> € Transmitter diameter: 10 mm € Cap T10 € O-ring 12x3 € O-ring 8x3 <p>NOTES: titanium transmitter</p>
	<p>TR15</p> <ul style="list-style-type: none"> € Transmitter diameter: 15 mm € Cap T15 € O-ring 12x3 € O-ring 13x3 <p>NOTES: steel transmitter</p> <hr/> <p>TR15-TI</p> <ul style="list-style-type: none"> € Transmitter diameter: 15 mm € Cap T15 € O-ring 12x3 € O-ring 13x3 <p>NOTES: titanium transmitter</p>
	<p>TR20</p> <ul style="list-style-type: none"> € Transmitter diameter: 20 mm € Cap T20 € O-ring 12x3 € Elastomer spring <p>NOTES: steel transmitter</p> <hr/> <p>TR20-TI</p> <ul style="list-style-type: none"> € Transmitter diameter: 20 mm € Cap T20 € O-ring 12x3 € Elastomer spring <p>NOTES: titanium transmitter</p>
	<p>TR35</p> <ul style="list-style-type: none"> € Transmitter diameter: 35 mm € Cap T20 € O-ring 12x3 € Elastomer spring <p>NOTES: steel transmitter</p>

TR20 and TR20-TI transmitters assembly procedure:

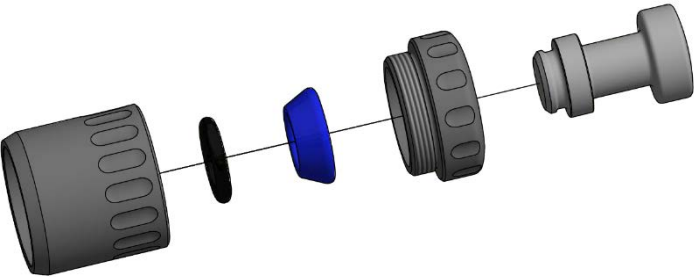
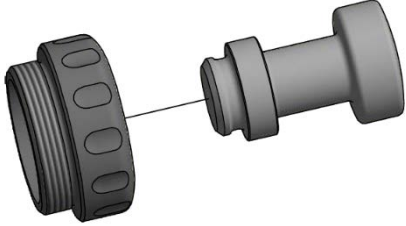
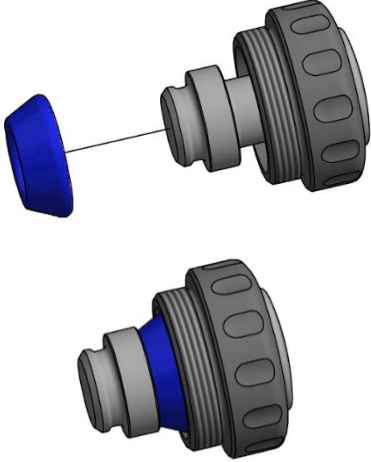
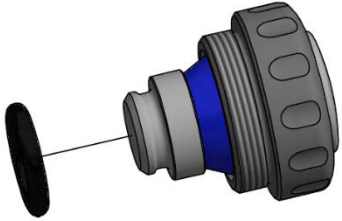
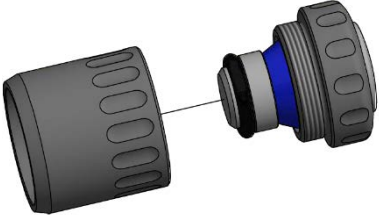
View	Characteristic
	<p>Order of components.</p>
	<p>Insert metal component into the front part of the cap.</p>
	<p>Thread the elastomer spring over the metal part hump.</p>
	<p>Install the O-ring 12x3 at the end of the metal part.</p>
	<p>Screw the rear and front parts of the cap together.</p>

In order to replace the elastomer spring, proceed in reverse order.

TR35 transmitter assembly procedure:

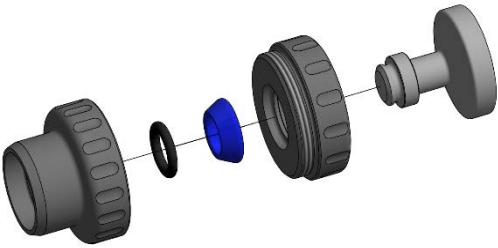
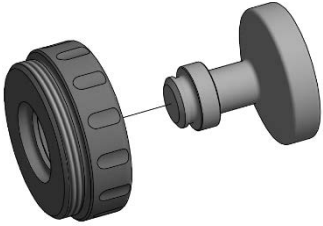
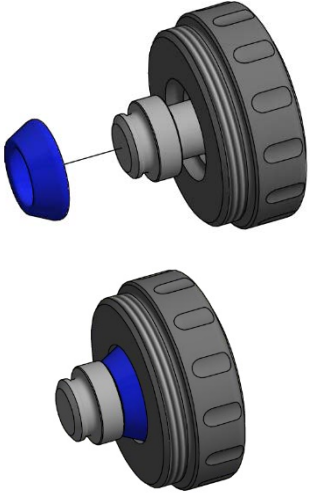
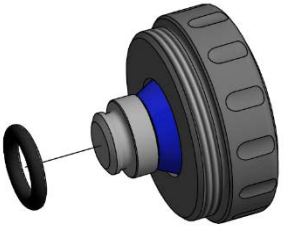
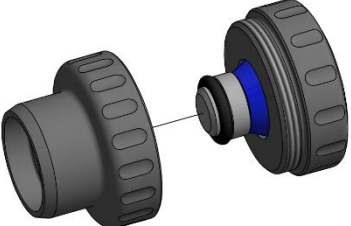
View	Characteristic
	Order of components.
	Insert metal component into the front part of the cap.
	Thread the elastomer spring over the metal part hump.
	Install the O-ring 12x3 at the end of the metal part.
	Screw the rear and front parts of the cap together.

In order to replace the elastomer spring, proceed in reverse order.

To replace the transmitter:

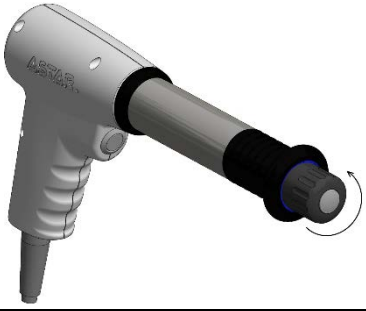
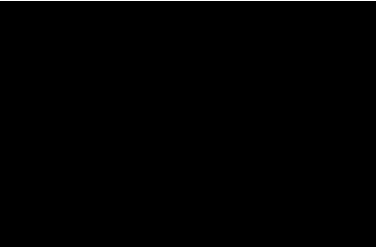
Step	Description
1.	Remove gel. Anti-clockwise dismantle the transmitter.
	
2.	Thoroughly clean the remaining gel and disinfect any part of the dismantled transmitter – a metal pin, cap and O-rings / elastomer springs.
3.	Make sure that a transmitter metal pin has got mounted O-rings / elastomer springs (see table above). Insert the metal pin into the respective cap.
4.	Adjust the transmitter to the applicator and screw by turning it clockwise.
	

6.1.4 First operation

Connect the switch mode power supply with the use of mains cable. Then connect it to the unit's socket marked with . Turn the unit on. After switching the mains supply on proper work of all blocks is tested.

If after switching on mains supply the display is illegible and knob is not illuminated, check whether mains fuse or mains cable operate correctly. Care shall be given to apply fuses with rating given on the name plate. If fuse and cables are working properly, contact the authorized service.

If after performed self-test on the screen there is an indication of a problem with device or connected accessory, turn the unit off and contact the authorized service.



6.2 Setup mode

6.2.1 Basic information

Keyboard components designed for the unit operation are called **"keys"**.

The area on the screen, where after its pressing a specific unit reaction is followed, is called **"button"**.

The area on the screen that has the possibility to select or deselect any item, is called **"selection field"**.

To enter <i>Setup</i> mode, press	
To leave <i>Setup</i> mode, press	
To go back one level, press	

Setup mode is available only if the treatment is not performed. Some setting options depend on the connected accessories. In the absence of some accessories, the options will not be available.

6.2.2 Language

Information on the display may be presented in different language versions (depending on the software version). The user is free to select language options.

To set the language version, press the **Language** button in the list of setup options, then press the desired version. Language version change is immediate.

6.2.3 Global settings

6.2.3.1 Date and time

In this section there is a possibility to adjust date and time. To change these settings, press the button *Edit*. Using arrows, set the required value. Confirm settings using *Set* button or leave the edition mode by pressing *Cancel*.

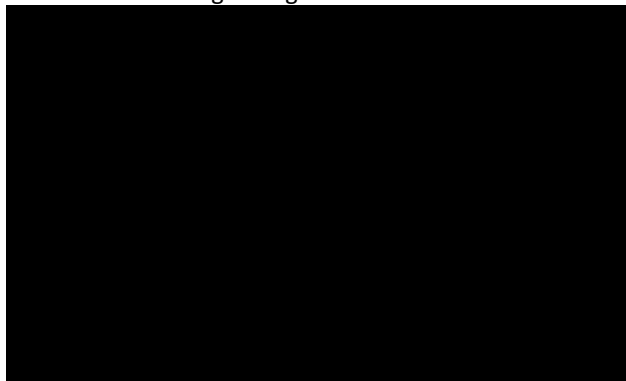

Figure 6.6 Screen view – date and time edition

6.2.3.2 Sounds



The user may configure settings of acoustic signals, which occur during unit operation. Description of available configuration options:

- € Keys sound
- € Warning sounds
- € Initial sound

In order to set the appropriate option, select or clear the selection field by its pressing.

6.2.3.3 Volume

The user may adjust sound volume level. To perform this action:

- € press the volume bar at desired place, or
- € use buttons   on the screen

6.2.3.4 Display

The user may adjust display brightness level. To perform this action:

- € press the value bar at desired place, or
- € use buttons   on the screen

6.2.4 Functional settings

6.2.4.1 Channel operation mode selection

This function allows the user to set preferred style of unit operation.

Option	Explanation
Manual mode – automatically	After therapy selection, the unit is set in manual mode operation.
Program mode – automatically	After therapy selection, the unit is set in program mode operation.
Anatomical mode – automatically	After therapy selection, the unit is set in anatomical mode operation.

In order to set the appropriate option, select the selection field by its pressing.

6.2.4.2 Program groups / medical fields

This function allows the user to set filters of available program mode options according to the preferred program groups or medical fields. In order to set the appropriate option, select or clear the selection field by its pressing.

For program groups, the following options are available:

- € Preset programs
- € User programs

For medical fields, instead of the preset treatment programs and sequences the following options classified by medical nomenclature are available:

- € Orthopedics
- € Sports medicine
- € Aesthetic medicine
- € Rheumatology
- € Neurology
- € Dermatology
- € Angiology

The classification of preset treatment programs and sequences into the above-mentioned categories do not limit their applications in other fields, according to the knowledge and experience of doctors and physiotherapists.

6.2.4.3 Transmitter selection window

This function allows to show the transmitter selection window before starting the treatment. This way, the particular transmitters number of shocks will be counted, which allows better control of their wear.

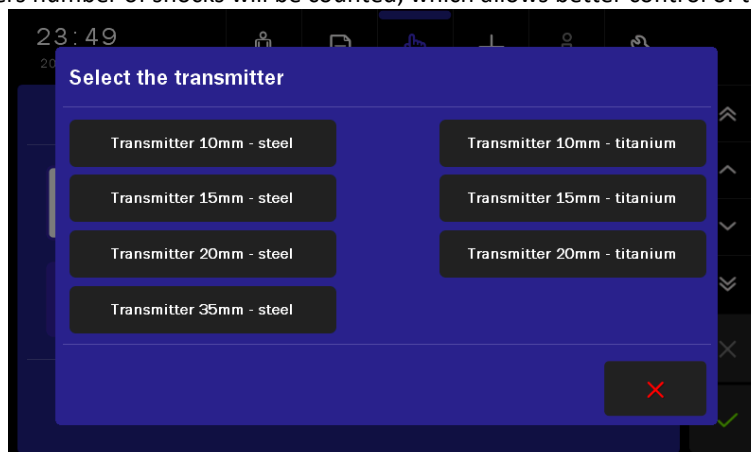

Figure 6.7 Transmitter selection window

6.2.5 Control functions

6.2.5.1 Counters and tests

In this section there is a possibility to manage some basic service functions:

- € **Delete user programs** – button allows you to remove user-defined programs.
- € **Delete the transmitter counter** – button allows you to delete a transmitter number of shocks counter after its replacement,
- € **Delete the ballistic system counter** – button allows you to delete a ballistic system number of shocks counter after its replacement,
- € **Test the touch panel** – button allows you to check the touch screen operation – on the touched spots an indicator occurs:
 - € red at the pressed spot,
 - € yellow at the pressure detection spots,
 - € white at the spot where the pen or finger is removed (it should coincide with the red one).

Press the START/STOP key to exit the test mode.

6.2.5.2 Date of inspection

There is possibility to enter into the device the date of the next inspection – it will automatically remind you about the need to perform an annual technical inspection.

6.2.6 Information

6.2.6.1 Info

Provides information about the serial number, version of the unit, software, interface and software build date.

6.2.6.2 Manufacturer

Provides information about the manufacturer together with the contact details.

6.2.6.3 Distributor

Provides information about the distributor in a given country together with the contact details. The „Change contact data” button can be use only by authorized unit, after entering the access code. The full data consists of:

- € the company name
- € the company address
- € the company website
- € the company phone number
- € the company e-mail

If data is not entered, the „-----” characters will be shown.

6.2.6.4 Technical support

Provides information about technical staff (the manufacturer’s or distributor’s) in a given country together with the contact details. The „Change contact data” button can be use only by authorized unit, after entering the access code. The full data consists of:

- € the company name
- € the company address
- € the company website
- € the company phone number
- € the company e-mail

If data is not entered, the „-----” characters will be shown.

The „Show logs” button supports service diagnostics, by displaying information about all saved device errors.

6.2.6.5 Unit statistics



Provides information about the number of treatment procedures performed. Statistics can be deleted (see 6.2.5.1).

7. Unit operation

The unit may operate in one of three modes:

- € anatomical,
- € program,
- € manual.

Notes – unit operation:

- € In the program mode you can use preset procedures of 44 treatment programs, as well as user-defined programs.
- € In the program mode, if the "Medical fields" option is set, selected preset programs are assigned to a given field, in accordance with the indications for therapy.
- € In the anatomical mode, selected preset programs are assigned to a given part of the body, in accordance with the indications for therapy.
- € In the program and anatomical mode you cannot edit the preset programs parameters. However, they can be easily "copied" to the manual mode. In order to do it, press the button  .

7.1 Patient preparation and treatment performance

To perform safe and effective treatment procedure you are obliged to:

- € make sure if there are no contraindications to perform the treatment,
- € patient should be placed in a comfortable position, while ensuring the tissue relaxation at the site of therapy,
- € sitting or reclining position should be applied to patients with respiratory disorders or breathing difficulties,
- € apply gel to ensure proper contact between the applicator and the patient body,
- € pay attention to the level of pain experienced by the patient – the settings and intensity of the treatment should be adapted to the current feelings,
- € inform the patient about the effects of a shockwave therapy, feelings that may occur during treatment including the information about possible side effects (see section **4.3 WARNINGS and safety notes**).

The treatment effectiveness depends on the choice of parameters to the current patient's condition. The patient's condition changes over time. Its observation and assessment should take place before, during and after therapy. Such an action is necessary for changing the parameters in order to adapt them to the actual condition of the patient.

It is recommended to keep the records of treatment, including the parameters of the therapy, the area of treatment, treatment technique, dose and symptoms after therapy. If the treatment does not generate the intended effects, change of treatment parameters should be taken into consideration. It is necessary to continuously update knowledge and follow literary activities in the scope of therapy.

7.2 Screen configuration

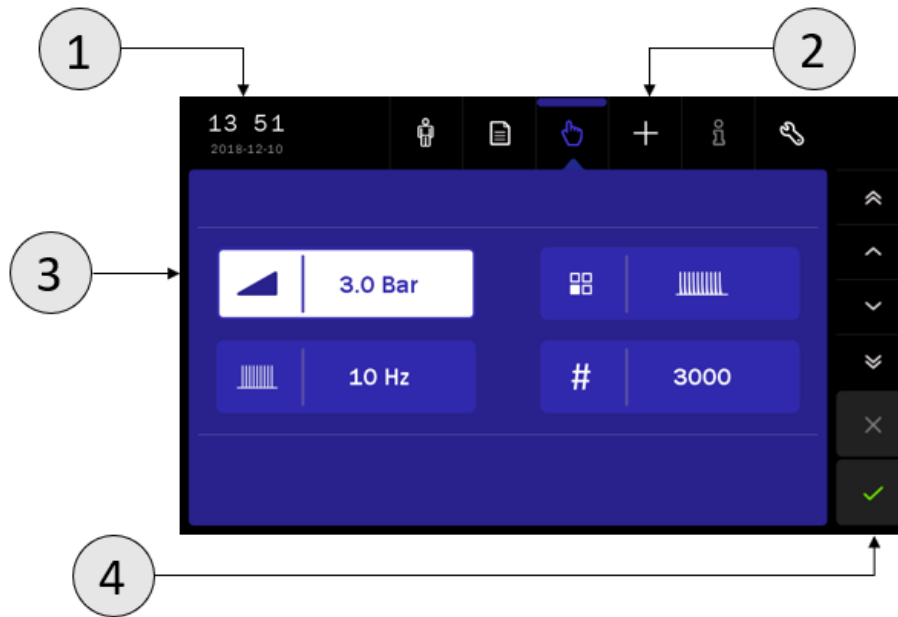













Figure 7.1 Field description – manual mode

Symbol	Display	Description
1.	Status tab	Date and time
2.	Main menu	 Anatomical mode
		 Program mode
		 Manual mode
		 User-defined programs edition mode
		 Information mode
		 Setup mode
3.	Edition field	In this field there are displayed: <ul style="list-style-type: none"> € visualizations for the anatomical mode € treatment parameters in manual mode € list of pre-defined programs € list of user-defined programs € settings
5.	Navigation bar	 quick change - up
		 change - up
		 change - down
		 quick change - down
		 confirmation (OK)
		 escape (ESC)

Note: if the edition field is grayed out, it means that it is inactive.

7.3 Display description

The treatment screen is presented after the treatment is started – in manual or program mode. The most important information about the ongoing therapy is presented.

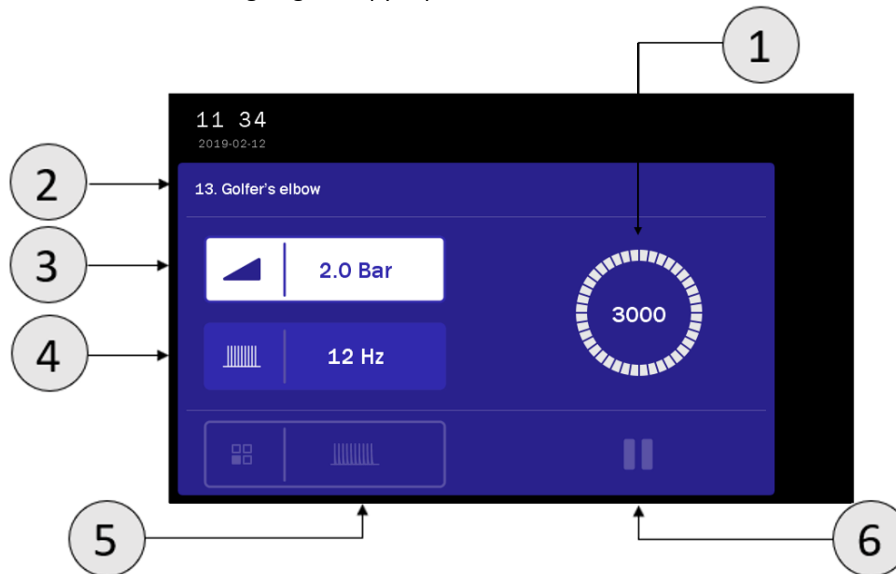





Figure 7.2 An example of the appearance of a treatment screen

Treatment screen:

Symbol	Description
1	Remaining number of shocks
2	Name of the preset / user program, empty for the manual mode
3	Pressure value (can be adjusted during treatment)
4	Frequency value (can be adjusted during treatment, the field is active when continuous emission is selected)
5	Emission mode
6	 Undergoing treatment
	 Pause – interruption / treatment preparation
	 Pause – the symbol appears after 30 seconds of inactivity from the treatment procedure beginning or last button press

7.4 Operation with preset treatment programs



The simplest method of unit's operation is to use its preset programs. The unit includes 44 preset treatment programs together with suggested treatment types and parameters. In this mode, the operation is reduced to selection of disease entity from the list. The parameters and information about the treatment are available in the information mode.

The values of the preset treatment programs parameters are based on the available literature data and they are determined as average values. Parameters should be treated exclusively as indications. Sole responsibility for application of preset treatment programs bears the User.

When choosing a program, its settings are displayed on the treatment screen.

While performing a treatment with the use of preset treatment programs you can adjust the pressure and frequency values – the intensity of the treatment must be adapted to the current feelings of the patient.

Operation scheme:

Step	Description
1.	Connect the shockwave therapy applicator to socket located on the left side panel of the casing.
2.	Connect the switch mode power supply and turn the unit on.
3.	Press the field  on the touchscreen.
4.	Select Preset programs from Program modes menu or proper medical field. Confirm by the button  or once again press the selected field.
5.	Select the program from the list with the knob or arrows placed on the right side of the screen.
6.	Prepare the patient for the treatment according to indications described in point 7.1 .
7.	Press START/STOP key on the controller casing or  button.
8.	Optionally, select the transmitter (see 6.2.4.3).
9.	Press the button on the applicator.



Pressing the button  after program selection results in appearing information which contains:

- € **technique description of the shockwave applicators placement,**
- € **illustrations with highlighted points or areas of the body covered by the treatment,**
- € **suggested number of procedures, the frequency of repetition,**
- € **notes,**
- € **treatment parameters.**

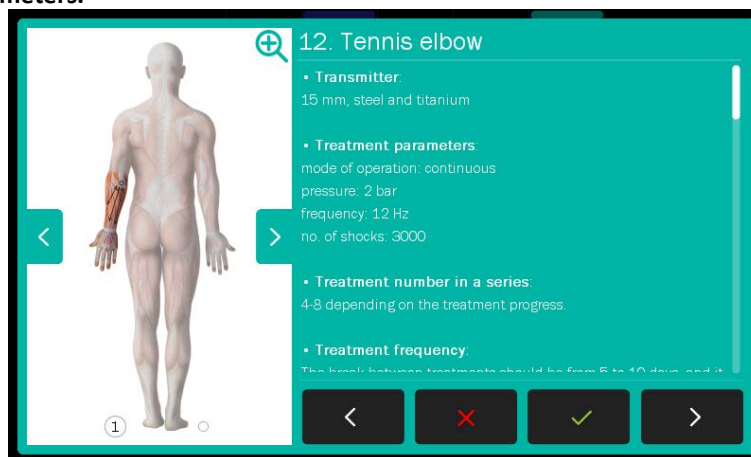









Figure 7.1 Sample view of the information screen

**Information mode navigation:**

Symbol	Explanation
	Approval of the program and return to the list (the current position)
	Back to the list of preset programs
	Go to the next program
	Go to the previous program
	Illustration for the exemplary use – go to the previous / next illustration for the program
	Enlarged illustration with an example of application

 Use knob or a bar located on the right side of the display to scroll the information.

In order to enlarge the view of the exemplary application of the applicator, press the  button. If the program in the encyclopedia contains more than one illustration, the magnifier will be visible only on the first one. It allows to open the extended illustration on the entire screen, showing the view from a different perspective.

To close the enlarged illustration, click the  button.

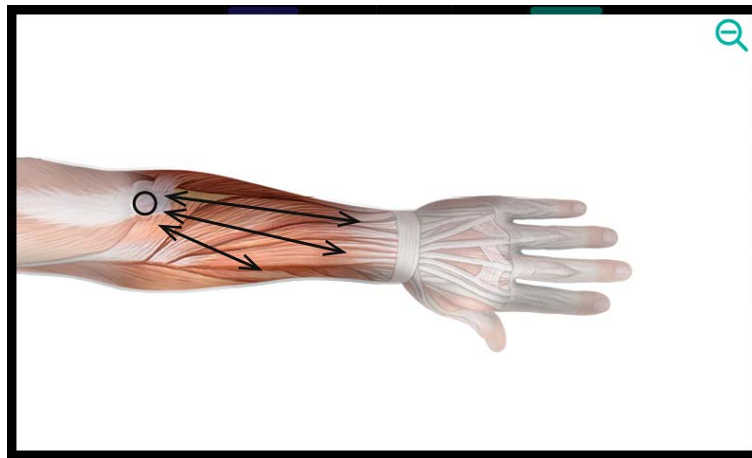

Figure 7.3 Sample view of the enlarged illustration

A list of preset treatment programs along with the parameters – see **Appendix B**.

Pressing START/STOP key while performing a treatment results in treatment interruption and automatically the unit return to main menu.

In order to interrupt the treatment – pause or resume, press the applicator button.

7.5 Anatomical mode of operation

Operation in anatomical mode allows the user to use preset programs, that are categorized according to the part of the body where the affliction occurs.

Three views of the profile are available, parts of the body with the given preset programs are marked by points:

FRONT	SIDE	BACK
Shoulder complex	Shoulder complex	Elbow / Forearm
Pelvis - anterior	Thigh	Pelvis - posterior
Knee	Foot	Lower leg
		Foot

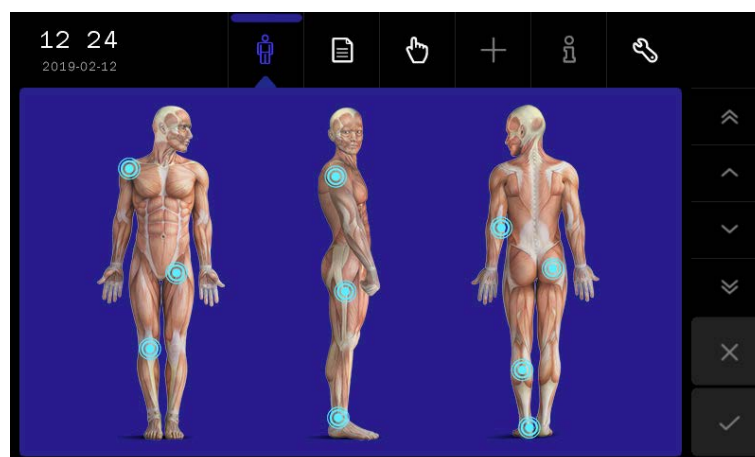



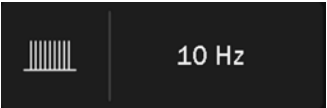
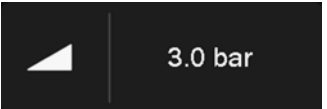

Figure 7.4 Anatomical mode screen

Operation scheme:



Step	Description
1.	Connect the shockwave therapy applicator to socket located on the left side panel of the casing.
2.	Connect the switch mode power supply and turn the unit on.
3.	Press the field  on the touchscreen.
4.	Select the body part to be treated.
5.	Select the program from the list with the knob or arrows placed on the right side of the screen.
6.	Prepare the patient for the treatment according to indications described in point 7.1.
7.	Press START/STOP key on the controller casing or  button.
8.	Optionally, select the transmitter (see 6.2.4.3).
9.	Press the button on the applicator.

7.6 Manual mode of operation

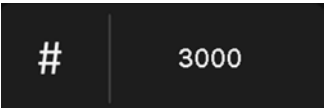
Symbol definition and parameters range are given in chapter 8.

Screen field	Field description
	Frequency of pulse emission (shocks) – default value: 10 Hz. The parameter editable only in a continuous mode, both before and while performing a treatment.
	Compressor pressure – default value: 3,0 bar. The parameter editable both before and while performing a treatment.
	Selection of pulse emission mode (continuous / single / burst / interval) – default: continuous mode. Parameter edition is possible only before a treatment.
	Number of shocks – default value: 3000. Parameter edition is possible only before a treatment.

Operation scheme:

Step	Description
1.	Connect the shockwave therapy applicator to socket located on the left side panel of the casing.
2.	Connect the switch mode power supply and turn the unit on.
3.	Press the field  on the touchscreen.
4.	Set treatment parameters: press the proper field on the touchscreen, then change the settings using the knob or arrows placed on the right side of the screen.
5.	Prepare the patient for the treatment according to indications described in point 7.1.
6.	Press START/STOP key on the controller casing or  button.
7.	Optionally, select the transmitter (see 6.2.4.3).
8.	Press the button on the applicator.



Pressing START/STOP key while performing a treatment results in treatment interruption and automatically the unit returns to the main menu.

In order to interrupt the treatment – pause or resume, press the applicator button.

7.7 User programs





The User has the possibility to save in the device memory their own sets of treatment parameters in the form of programs.

Saving of user program:





Step	Description
1.	Prepare the unit to work in manual mode (steps 1 – 4 see section 7.6).
2.	Press the button  from main menu.
3.	Select the item number under which the program will be saved. Confirm your choice with the button  .
4.	Enter the program name (up to 80 characters). Press the  button.

The user-defined programs are selected in the same way as preset treatment programs. In **Program modes** menu select the option **User programs**.



Edition of user program:

Step	Description
1.	Prepare the unit to work in the program mode (steps 1 – 4 see section 7.4).
2.	Select the option User programs from Program modes menu. Confirm by the key  or once again press the selected field.
3.	Select the program for edition.
4.	Press the button  from main menu.
5.	Select the action – Edit .
6.	Correct the parameters.
7.	Press the button  from main menu.
8.	Select the item number under which the program will be saved. Confirm your choice with the key  .
9.	Enter or edit the program name (up to 80 characters). Press the button  .

Removal of user program:

Step	Description
1.	Prepare the unit to work in the program mode (steps 1 – 4 see section 7.4).
2.	Select the option User programs from Program modes menu. Confirm by the key  or once again press the selected field.
3.	Select the program which will be deleted.
4.	Press the button  from main menu.
5.	Select the action – Remove .
6.	Confirm by pressing  or resign using  .



User program parameter view:

Step	Description
1.	Prepare the unit to work in the program mode (steps 1 – 4 see section 7.4).
2.	Select the option User programs from Program modes menu. Confirm by the key ✓ or once again press the selected field.
3.	Select the program which parameters will be checked.
4.	Press the button  .
5.	Press the button  or button  to return to the user-defined treatment program list.

7.8 Favorite programs

The function offers quick access to frequently used preset programs without browsing the entire list.

To add or remove the program from the favorite list, follow the instructions:

Step	Description
1.	Prepare the unit to work with preset treatment programs (steps 1 – 4 see section 7.4).
2.	Select program.
	add remove
3.	Press the symbol  next to the name of the program. Symbol color changes to yellow and the program is inserted on the favorite list.
	Press the symbol  next to the name of the program. Symbol color changes to blue and the program is deleted from the favorite list.
4.	---
	You can also delete programs from the list of favorites by following the steps above.

To enter the favorite list, press the symbol .

If no item from the preset treatment program or sequences list is selected as a "favorite", then after entering the option, the list will be empty.

7.9 Search function

This function allows the user to search for a string of characters in preset programs – in anatomical and program modes as well as in user programs.

To search the list for a program:

Step	Description
1.	Prepare the unit to work with: <ul style="list-style-type: none"> € programs in anatomical mode, € preset programs or € user programs.
2.	Press the button  .
3.	Write a searched phrase using the keyboard, confirm by the key ✓.

Search restrictions:

- € uppercase and lowercase letters are not distinguished,
- € diacritics are not distinguished from their basic form,

- € digits are searched among the names and order number in the list,
- € spaces placed at the beginning and end of the searched phrase are omitted,
- € the "." character is a special character - it may not be found as expected.

7.10 Sorting function

This function allows user to sort programs in the alphabetical order.

To sort programs alphabetically:

Step	Description
1.	Prepare the unit to work with: <ul style="list-style-type: none"> € programs in anatomical mode, € preset programs or € user programs.
2.	Press the button AIZ .

Sorting rules:

- € sorting is in accordance with the alphabetical order of the language. If a character does not appear in the alphabet of a given language (e.g. "q" in Polish), it is treated as a special character.
- € special characters (numbers, punctuation, spaces etc.) take precedence over letters.
- € capital letters take precedence over small letters.
- € empty user programs can be sorted randomly.

7.11 Safe shutdown procedure

The work flow for the safe termination of the operation:

Step	Description
1.	Proceed with the treatment to the end or stop it by pressing the START/STOP key.
2.	Perform the applicator cleaning and disinfection, as presented in chapter 10.3.
3.	Put the applicator onto the handle.
4.	Turn the device off using the power switch (placed on the left side of device).
5.	If you do not use the device for a long time, remove the mains cable plug from the mains socket.

REMARK: The unit features a mechanism for voltage dips detection. If such event is detected, the system will be closed automatically. After the system is closed, the knob backlight blinks once per second.

8. Definitions and parameters

8.1 Shockwave therapy characteristics and its impact on the body

The shockwave is defined as an acoustic wave with high amplitude (tens MPa) and low frequency (up to 25 Hz). The main feature of the shockwave is a rapid increase in pressure which causes a number of effects in tissues undergoing treatment. In order to ensure proper wave transmission from a transmitter to the body it is necessary to use a coupling medium, e.g. ultrasound gel. There are three types of shockwave: focused (FSWT), radial (RSWT) and plain. Another useful classification is based on wave division due to the impact energy density. We can distinguish:

- € low-energy shock waves (LESWT) – the energy density less than 0,28 mJ/mm², used in pain relief treatment, it is not required to apply local anesthetics,
- € medium-energy shock waves (MESWT) – the energy density 0,28 – 0,6 mJ/mm², the action resulting in increased blood flow at the site of therapy, thereby initiating the formation of new blood vessels,
- € high-energy shock waves (HESWT) – energy density higher than 0,6 mJ/mm², able to break down the calcifications, for which local anesthetics is required, waves at these energies are capable of damaging tissues.

The main biological effects of shockwave in physiotherapy are:

- € pain relief effect by
 - § decreased muscle tone and contraction inhibition,
 - § destruction of pain receptors and neuron cell membranes disrupting the transmission of pain impulses,
 - § improved local blood supply,
 - § hyperstimulation of receptors responsible for sending pulses of high intensity which hamper pain signals in accordance with the gate control theory,
- € stimulation of tissue regeneration by
 - § new blood vessel formation and growth of existing tendons and muscles,
 - § improved metabolism and microcirculation,
 - § increased collagen production,
 - § increased vasodilator gases charges, nitric oxide and endothelial nitric oxide synthase,
 - § activation of angiogenic vascular endothelial growth factor, bone morphogenetic protein and osteogenic proteins,
 - § support of irritating substances removal of an acidic reaction, histamine and lactic acid,
 - § dissolving calcified fibroblasts.

Before proceeding to the shockwave therapy treatment, it is recommended to perform thorough imaging diagnostic, e.g. X-ray, USG, CT or MRI. In the case of focused shockwave, it is also advisable to perform control using USG, during and after treatment.

The standard equipment of the unit includes three transmitters made of stainless steel and one titanium transmitter. On application, note that the titanium transmitters transmit considerably more energy on pulse leading edge compared to stainless steel transmitters. Therefore, they are suggested in the therapies of highly chronic conditions or in diagnosed calcinosis.

Example applications include:









- € Calcific enthesopathies of rotator cuff muscles: supraspinatus muscle (stage I)
- € Calcific enthesopathies of rotator cuff muscles: infraspinatus muscle (stage I)
- € Calcific enthesopathies of rotator cuff muscles: subscapularis muscle (stage I)
- € Subacromial bursitis (stage II)
- € Calcifications in the acromioclavicular joint
- € Tennis elbow (stage I)
- € Golfer's elbow (stage I)
- € Piriformis syndrome

- € Overstraining changes in the sacroiliac joint
- € Subtrochanteric bursitis
- € Enthesopathy of adductor muscles (pain in the groin) (stage I)
- € Intramuscular hematoma: chronic condition (stage I)
- € Jumper's knee (stage I)
- € Iliotibial band syndrome or runner's knee
- € Compartment syndrome
- € Overstraining changes in the Achilles tendon
- € Symptomatic inferior calcaneal spur (stage I)
- € Symptomatic superior calcaneal spur (stage I)
- € Overstraining changes in the plantar fascia

Note that compared to stainless steel transmitters, the titanium transmitters cause much stronger pain. Thus, they are not recommended to treat patients with the low threshold of pain and in the therapies of muscle attachments or bony structures.

8.2 Treatment parameters

Characteristic of treatment parameters:

Symbol	Definition	Available parameters
	Pulse (shocks) emission frequency	Range: 1 – 25 Hz Regulation Step: 1 Hz Default value: 10 Hz
	Compressor pressure	Range: 1 – 5 bar , equivalent to 100 – 500 kPa Regulation Step: 0,1 bar , equivalent to 10 kPa Default value: 3 bar , equivalent to 300 kPa
	Pulse emission mode	 Continuous
		 Single
		 Burst: - 15 shocks per series - pulse frequency: 10 Hz - duration time: 2 s
		 Interval: - single - continuous
	Number of shocks	Range: 1 – 10 000 Regulation Step: 10, in the range of 10 – 100 100, in the range of 100 – 10 000 Default value: 3000

€ Continuous mode

Pressing the button located on the handpiece in continuous mode results in wave emission according to the set parameters – frequency, pressure and number of shocks. Generation is completed after a defined number of shocks.

During treatment procedure in this mode, you can adjust both the pressure and the frequency of shocks. Pressing the applicator button in this mode interrupt the treatment and the unit is in pause mode.

€ **Single shock mode**

In single shock mode, each press of the button on the handpiece causes generation of only one shock. Generation of subsequent pulses is effected by button pressing, and the treatment is completed after the set number of shocks.

While the treatment procedure it is possible to adjust the pressure, while the frequency is defined by the speed of button pressing by the operator.

€ **„Burst” mode**

Pressing the button on the handpiece in a "burst" mode generates the emission of shockwaves grouped in packages with a duration of 2 seconds. The frequency of single shocks in the series is 10Hz (fixed parameter, non-editable). Each pack contains 15 pulses, if the set number of shocks is an integer multiple of 15. In all other cases, the number of pulses in the last series is a complement to the total number of shocks.

During treatment procedure in this mode there is a possibility to adjust the pressure.

Pressing the applicator button in this mode interrupt the treatment and the unit is in pause mode.

€ **Interval mode**

Pressing the button on the handpiece in an interval mode generates the emission of single shocks – the unit works as in single shock mode. Holding the button on the handpiece in this mode for 3 seconds will result in changing to continuous mode with a pulse emission frequency of 10 Hz. Pressing the button again will result in returning to the single mode.

During treatment procedure in this mode there is a possibility to adjust the pressure.

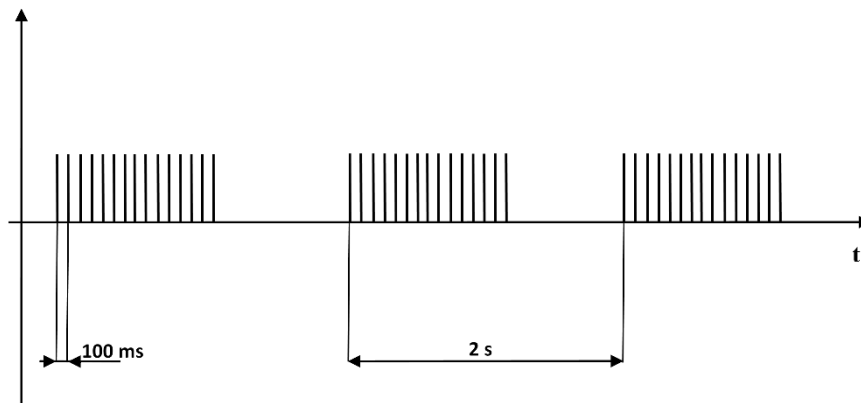

Figure 8.1 Time dependencies in „Burst” mode

9. Indications and contraindications

9.1 Indications

9.1.1 Orthopedics and sports medicine

- € increased muscle tension
- € trigger points
- € overload changes and chronic inflammation of:
 - § sacroiliac joint
 - § tibialis anterior and posterior muscle
 - § Achilles tendon
 - § articular capsule of the humerus
 - § subacromial bursa
 - § subtrochanteric bursitis
- € enthesopathies (overload changes of the muscle attachments), including:
 - § adductor muscles
 - § ischiocrural muscle
 - § patellar ligament (jumper's knee)
 - § plantar fascia
 - § wrist extensors and flexors (tennis elbow, golfer's elbow)
 - § muscles of the rotator cuff
 - § Achilles tendon
- € calcification within the acromioclavicular joint
- € calcification within shoulder area
- € Dupuytren's contracture
- € piriformis muscle syndrome
- € intramuscular hematoma
- € iliotibial band syndrome
- € runner's knee
- € compartment syndrome
- € calcaneal spur

9.1.2 Aesthetic medicine

- € cellulite
- € local obesity
- € flabby zones firming (buttocks, shoulders)
- € skin relaxation
- € lifting
- € liposuction
- € lymphatic drainage

9.2 Contraindication

9.2.1 Absolute

- € gestation or the likelihood of pregnancy
- € coagulation disorders
- € cancer
- € neurological diseases

- € incomplete bone growth (cartilage growth in children up to 16-18 years)
- € demyelinating polyneuropathy
- € infectious inflammation of the tendon sheath
- € proximity of the lung parenchyma in the area of application
- € acute infection of the soft tissue / bone
- € acute inflammation with swelling of the painful area
- € local epiphyseolysis (division and separation of the epiphyseal cartilage bones)
- € patients with implanted electronic devices (e.g. cardiac pacemaker)
- € advanced osteoporosis
- € advanced diabetes

9.2.2 Application restrictions for shockwave therapy

It is essential to avoid the use of therapy in the area:

- € head
- € chest and lungs
- € spinal cord
- € point clusters of large nerves (the skull, spine, ribs)
- € peripheral nerves and vascular structures
- € lymph nodes
- € sites of implanted foreign body (e.g. endoprosthesis, implants)



9.3 Possible side effects

- € unwanted pain sensation during and after the treatment
- € reddening
- € hematomas
- € local swelling
- € mild numbness
- € tingling

10. Maintenance, cleaning, disinfection

NOTE: The warranty does not cover any damage due to a failure to adhere to the recommendations stated in this chapter.

NOTE: Before attempting to perform following operations isolate the unit and switch mode power supply from the mains supply!

The activities of maintenance, cleaning and disinfection of device components should be realized at:

- € ambient temperature between +15°C to +30°C,
- € relative humidity between 30% to 75%,
- € atmospheric pressure between 700 hPa and 1060 hPa (70 – 106 kPa).

These conditions are identical to those defined in chapter 4.2 as operation conditions.

There are no limitations for the number of cleaning and disinfection cycles, procedures should be carried out during the entire device “life time”.

10.1 Cleaning of the unit and switch mode power supply casing

Cleaning of the unit, switch mode power supply and cables shall be performed with lightly humid sponge or soft cloth with delicate soap solution or mild detergent. It is recommended to use a microfiber cloth, preferably designated for cleaning mirrors or electronic equipment.

Do not use solvents for paints and lacquers. Do not use excessively dampened sponges either, which can lead to water penetration inside the unit.

Then all cleaned cables shall be wiped with dry cloth and left for complete drying.

Do not connect wet or moist leads!

Do not disinfect or sterilize unit casing. Disinfection of accessories, which are not intended for contact with patient’s body (for example cables), shall be carried out at least once a week. It is recommended to use agent based on ethanol and/or isopropyl alcohol e.g. Alpro Minuten Spray or 70% solution of spirit.

It is not recommended to use sanitizers consisting of active oxygen, because it can lead to accessories damage.

10.2 Cleaning of touchscreen

To clean the touchscreen, we recommend to use a cloth which is included in the unit's standard accessory, or other made of microfiber, preferably designated for cleaning mirrors or electronic equipment.

The manufacturer recommends to clean regularly the touchscreen display. Gently moisten the cloth with clean water. The cloth should be drained so that there is no dripping water. The screen should be wiped until removal of all dirt and dust.

The manufacturer does not recommend to use any product designated for cleaning screens, because there is no guarantee that the chemicals will not lead to faster wear out of touchscreen layers.

10.3 Cleaning and disinfection of the applicator

Cleaning of the shockwave applicator shall be performed with lightly humid sponge or soft cloth with delicate soap solution or mild detergent. Then cleaned applicator shall be wiped with dry cloth and left for complete drying.

Clean and disinfect all transmitter elements (metal pin, cap, O-rings / elastomer springs) after each treatment. Then you will avoid the risk of infection transmission and locking the cap if the gel remains dried out in the slots.

The gel remains remove with the use of paper towels.

It is not recommended to flush or wash the applicator under running water. If water or another fluid penetrates the interior of the bullet chamber, the ballistic set and/or electrovalve can get damaged. The warranty does not cover such damage.

If the tube of the body in the applicator or transmitter components became soiled (e.g. with the gel) so that cleaning with a paper towel is not possible, follow the recommendations:

Step	Description
1.	Remove gel. Anti-clockwise unscrew the mounted transmitter. In case of difficulty with unscrewing the transmitter, put the rubber/latex glove on and unscrew it.
2.	Then unscrew the tube of an applicator body. Remove the clamping ring.
3.	Flush the transmitter parts and the tube of the body under running water. If the gel dried off, use a nylon brush. You can use it to safely clean transmitter components and the tube of the body in the applicator.
4.	After washing, dry the elements thoroughly before the next treatment.
5.	Put the clamping ring.
6.	Put the tube of the body in the applicator and tighten firmly.
7.	Install the transmitter.

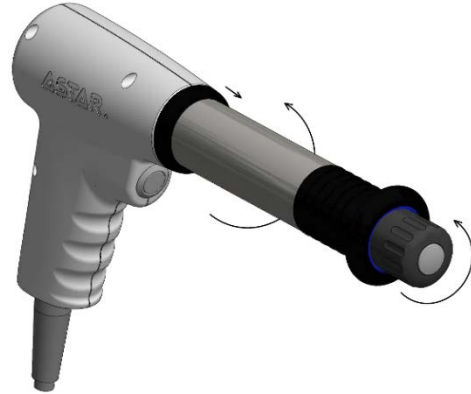

Shockwave transmitters and casing elements shall be disinfected by the use of 70% alcohol solution. In the case of other agents commonly used for disinfection, first perform the test, whether the agent does not damage the surface of used materials.

The manufacturer does not recommend products containing hydrogen peroxide, or compounds based on active oxygen due to the high likelihood of degradation or damage to the surfaces of the applicator.

After disinfection, the applicator must be washed (clean, not hot water) to avoid allergic reaction.

10.4 Information – Messages

In case of an error occurrence, messages that facilitate error handling are displayed in the edition field. There can also be shown a window that informs user about the need to contact the technical support. By using the visible setup control, it is possible to display the unit logs, in order to pass them to the technical staff (see 6.2.6.4).

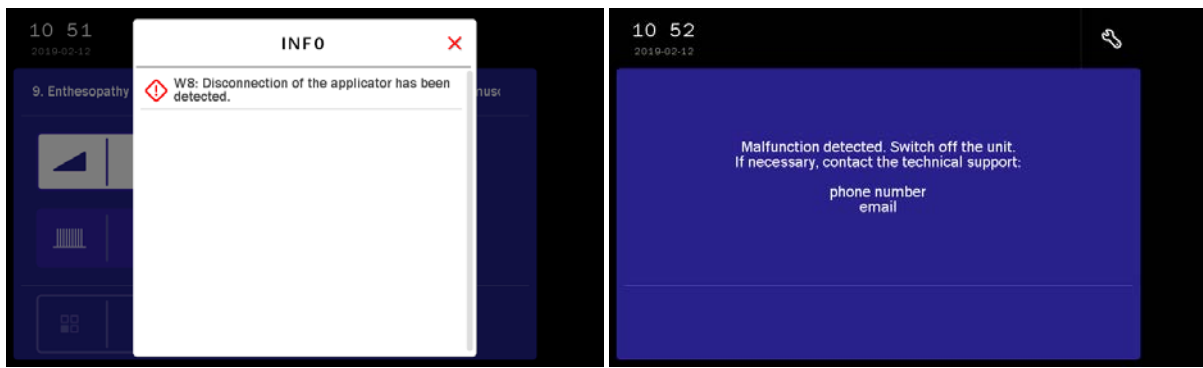

Figure 10.1 The unit error signaling and information visible after closing of the error message

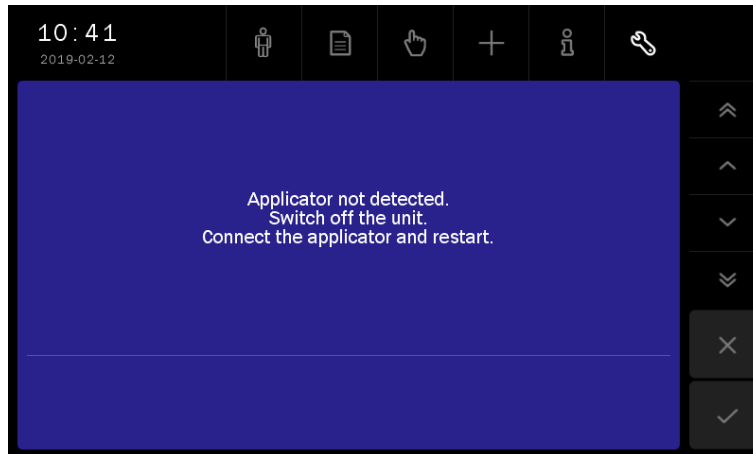



Figure 10.2 The information screen – applicator not detected during the self-test

 Error code	Error description
W1	IM-MB module outputs control error
W2	IM-MB module not detected
W3	The pressure regulation sub-system does not stabilize the pressure before the treatment
W4	The value of the main power supply outside the permissible range
W5	The upper limit of the permissible operating temperature has been exceeded
W6	The lower limit of the permissible operating temperature has been exceeded
W7	IM-MB module memory malfunction
W8	Disconnection of the applicator has been detected
W10	Operating temperature outside the permissible limit
W11	Pressure over 6Bar
W13	Applicator settings memory malfunction
I15	Module configuration CRC error
I16	RTC battery low voltage, contact the technical support to replace
I17	No communication with external GC module EEPROM

Errors that make unit interface start-up impossible are indicated by sound according to the following list:

 Error code	Error description	Indication
12	SDRAM self-test error	2 signals
13	No communication with SD card	3 signals
14	No communication with LCD TSC controller	4 signals
15	Program defect in processor flash memory (CRC)	5 signals
18	Oscillator error	8 signals

10.5 Projectile system replacement

Declared „life time” of projectile system is 2 million shocks. After reaching this value, the system should be replaced. Continue of the usage, can cause applicator damage.

After reaching 1.8 million shocks, during the self-test, will be shown the information on the screen about approaching necessity of system replacement. This information is shown in Figure 10.3. To continue device operation, tap ✓ icon.

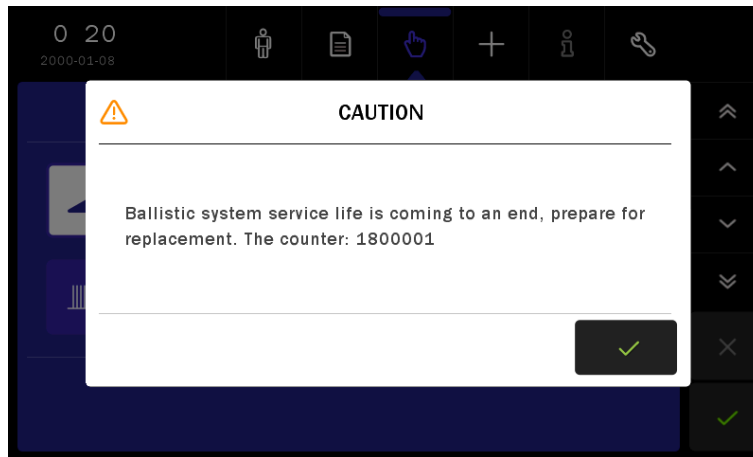

Figure 10.3 The screen with information about approaching necessity of replacing projectile chamber

After reaching 2 million shocks, during the self-test, will be shown the information on the screen about recommendation of system replacement. This information is shown in Figure 10.4.

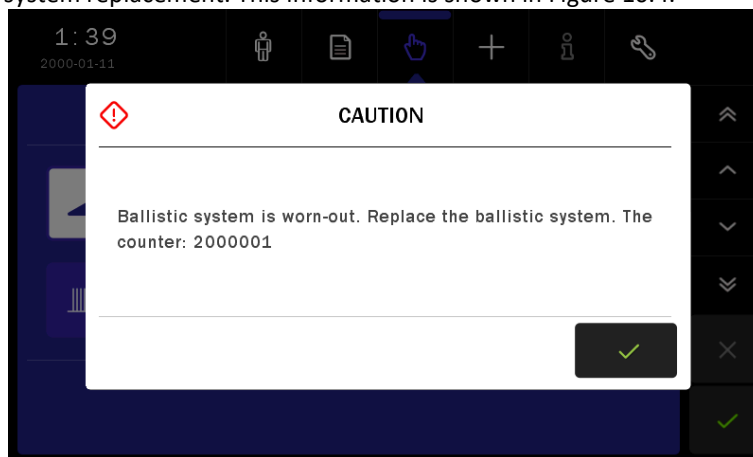
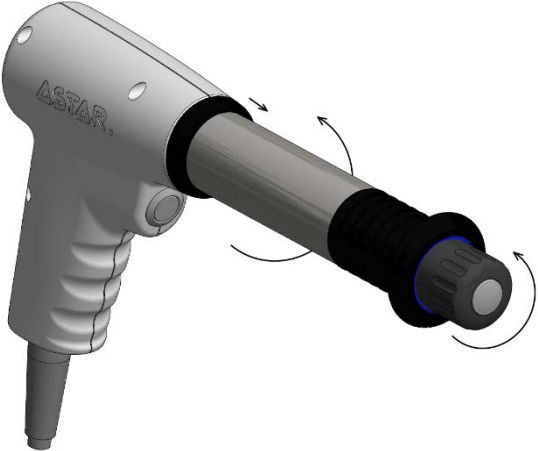



Figure 10.4 The screen with information about necessity of replacing projectile chamber

In order to replace the projectile system:

Step	Description	
1.	Turn the unit off.	
2.	Remove gel. Anti-clockwise unscrew the mounted transmitter. In case of difficulty with unscrewing the transmitter, put the rubber/latex glove on and unscrew it.	
3.	Then unscrew the tube of an applicator body. Remove the clamping ring.	
4.	By the dedicated key, unscrew the projectile chamber. Remove the spring and clean it with a paper towel or dry cloth.	
5.	After removal of the chamber perform blowing through the pneumatical set of the applicator. It should clean the remains left after work of the used kit. In order to clean, turn the unit on and wait for the end of self-test. Using the default parameters, start the treatment. Wait about 30 seconds. During this procedure, applicator will execute a couple of hundred cycles of opening the valve, the air will remove remains from the valve. Stop the procedure, turn the unit off.	
6.	Prepare a new projectile chamber. Install the spring.	
7.	Adjust the projectile system to handpiece and screw it a few turns.	
8.	Screw it with a dedicated key.	
9.	Put the clamping ring.	
10.	Clean the tube of an applicator body, fit it and tighten.	
11.	Mount the transmitter.	
12.	Turn the unit on and delete ballistic system counter – see the description in chapter 6.2.5.1. Test several shocks to make sure that after replacement of projectile system everything is working properly.	

10.6 Transmitter replacement

Declared „life time” of transmitter is 2 million shocks. After reaching this value, the transmitter should be replaced. Continue of the usage can cause the applicator damage.

After reaching 1.8 million shocks, during the treatment start, will be shown the information on the screen about approaching necessity of transmitter replacement – if the transmitter selection window is active and the corresponding statistics are counted. This information is shown in Figure 10.5. To continue the device operation, tap ✓ icon.

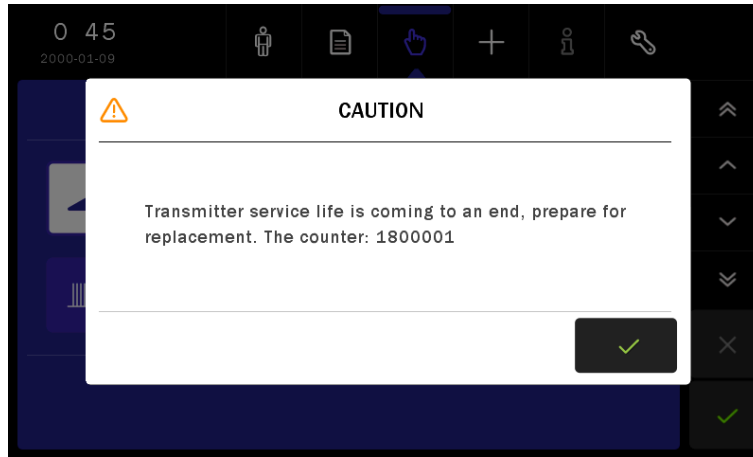

Figure 10.5 The screen with information about approaching necessity of replacing transmitter

After reaching 2 million shocks, during the self-test, will be shown the information on the screen about recommendation of transmitter replacement. This information is shown in Figure 10.6

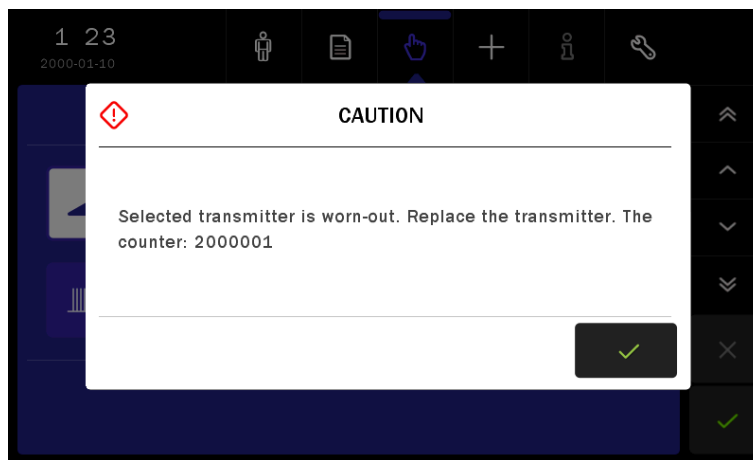

Figure 10.6 The screen with information about necessity of replacing transmitter

In order to replace the transmitter, follow the indications in chapter 6.1.3.

10.7 Troubleshooting

Reason	Recommended action
The unit does not respond to mains supply	<p>Check fuses. In case of burnt fuses, they must be replaced according to the instructions. If the problem persists, contact the manufacturer's authorized service center.</p> <p>Check if the LED indicator illuminates on the housing of the power supply. If not, replace the power supply. If the problem continues after replacement, contact the manufacturer's authorized service center.</p> <p>Try to connect different mains cables. If the problem persists, contact the manufacturer's authorized service center.</p>
The unit does not respond when you press a key / keys	<p>Switch the unit off and on once again. If the problem persists or frequently occurs, contact the manufacturer's authorized service center.</p>
Unit Error	<p>Switch the unit off and on once again. If the problem persists or frequently occurs, note down the error number and contact the manufacturer's authorized service center.</p>
W8 error signaling (no shockwave applicator) or the information screen after start-up (applicator not detected)	<p>Turn the unit off, connect the shockwave therapy applicator to socket located on the left side panel of the casing, turn on the unit.</p>
W5 error signaling	<p>Device overheating. Possible if operated with maximum parameters for a long time. Check if you can feel the operation of the fans. If yes, wait until the device cools down.</p> <p>Device overheating. Check if you can feel the operation of the fans. If not, contact the manufacturer's authorized service center.</p>
Perceptible weakness of shocks	<p>Replace projectile system.</p> <p>Mount another transmitter.</p>
Wear, fracture or transmitter deformity Despite transmitter replacement, the information about worn transmitter shows	<p>Change the transmitter. In the case of transmitter damage, replace also the projectile system.</p> <p>Delete transmitter counter, described in chapter 6.2.5.1</p>
Touchscreen does not react on touch	<p>Switch the unit off and on once again. Clean the touchscreen. If the problem persists or frequently occurs, the manufacturer's authorized service center.</p>
The applicator does not start generation after trigger release	<p>Replace projectile system.</p> <p>Change the applicator.</p> <p>If the problem persists, contact your service.</p>
You are not able to unscrew the transmitter or barrel of the applicator body	<p>Send the applicator to an authorized service.</p>
Significant corrosion was observed on the applicator parts. Another unscrewing may not be possible	<p>Replace damaged items.</p>
The acclimatization process is activated each time the power is turned on	<p>Damaged temperature sensor. Contact the manufacturer's authorized service center.</p>
The pump runs continuously at full capacity	<p>Open solenoid valve for removing moisture from the pneumatic system. Press the START/STOP key. If the problem recurs frequently, contact the manufacturer's authorized service center.</p>

Reason	Recommended action
Despite projectile system replacement, the information worn ballistic system shows	Delete ballistic system counter, described in chapter 6.2.5.1

10.8 Fuse replacement

NOTE:

Before proceeding to the further described operations isolate the unit from the mains supply!

In case of burnt fuses, they must be replaced. Their parameters are given in chapter „Specification and accessories” and on the name plate.

To replace fuses:

Step	Description
1.	Switch the mains switch to the "0" position
2.	Isolate the device from the mains.
3.	Disconnect the mains cable from the mains socket. Remove the SMPS output cord plug from the socket on the unit.
4.	With flat screwdriver lever the fuse socket.
5.	Remove the socket with your fingers, replace the fuse.
6.	Install it in the socket again, press firmly then screw with flat screwdriver.
7.	Connect the mains cable once again. Connect the SMPS output cord plug from the socket on the unit once again. Switch the mains switch to the "1" position.
8.	Check the device operation.

11. Specification and accessories

11.1 Technical data

Classifications:

Medical device class: (according to MDD 93/42 / EEC and REGULATION (EU) 2017/745 OF THE EUROPEAN PARLIAMENT AND OF THE COUNCIL of 5 April 2017)	IIb, rule 9
Electrical safety class:	II
Applied part type:	BF
Degree of protection provided by enclosures:	IP20

Mode of operation:

The Impactis M+ unit is intended for non-continuous operation.

Treatment parameters:

Described in chapter 8

Shockwave parameters (maximum operating pressure):

Energy density, TR10 steel transmitter:	0,38 mJ/mm ²
Energy density, TR15 steel transmitter:	0,64 mJ/mm ²
Energy density, TR20 steel transmitter:	0,82 mJ/mm ²
Energy density, TR35 steel transmitter:	0,95 mJ/mm ²
Energy density, TR10-TI titanium transmitter:	0,38 mJ/mm ²
Energy density, TR15-TI titanium transmitter:	0,53 mJ/mm ²
Energy density, TR20-TI titanium transmitter:	0,82 mJ/mm ²
Peak-positive acoustic pressure:	max. 13,1 MPa
Peak-negative acoustic pressure:	max. -11,3 MPa

Accuracy of operation parameters:

Frequency:	±20%
Pressure:	±20%
Number of shocks:	±5%

Treatment programs:

Pre-defined treatment programs:	44
User programs	50

General:

Mains supply:	100÷240 V, 50/60 Hz
Controller supply:	24VDC 6,25 A
Fuses:	dimension 5x20mm, T10L250V; 10 A, 250 V
Unit weight:	max. 7 kg
Shockwave applicator weight:	max. 0,8 kg
Switch mode power supply weight:	max. 0,5 kg
Unit dimensions (WxDxH):	361x304x151 mm

Storage conditions:

Temperature range:	+5 ÷ +45 °C
Relative humidity:	30 ÷ 75 %
Pressure range:	700 ÷ 1060 hPa (70 ÷ 106 kPa)

Operation conditions:

Temperature range:	+15 ÷ +30 °C
Relative humidity:	30 ÷ 75 %
Pressure range:	700 ÷ 1060 hPa (70 ÷ 106 kPa)

Transport conditions:

Temperature range:	-10 ÷ +45 °C
Relative humidity:	20 ÷ 95 %
Pressure range:	700 ÷ 1060 hPa (70 ÷ 106 kPa)

11.2 EMC parameters

In compliance with IEC 60601-1-2:2014

Guidance and manufacturer's declaration – electromagnetic emissions

Emission test	Compliance
RF emissions CISPR 11	Group 1
RF emissions CISPR 11	Class B
Harmonic emissions IEC 61000-3-2	Class A
Voltage fluctuations / Flicker emissions IEC 61000-3-3	Complies

Guidance and manufacturer's declaration – electromagnetic immunity

Immunity test	IEC60601 test level	Compliance level
Electrostatic discharge (ESD) IEC 61000-4-2	±8 kV contact ±2, ±4, ±8, ±15 kV air	±8 kV contact ±2, ±4, ±8, ±15 kV air

Recommendation: Floor should be made of wood, concrete or ceramic tile. If floors are covered with synthetic material, the relative humidity should be at least 30%.

Immunity test	IEC60601 test level	Compliance level
Radiated RF IEC 61000-4-3	10 V/m 80MHz do 2,7 GHz	10 V/m

Field strengths from fixed transmitters, such a base stations for radio (cellular / cordless) telephones and land mobile radios, amateur radio, AM and FM radio broadcast and TV broadcast cannot be predicted theoretically with accuracy. To assess the electromagnetic environment due to fixed RF transmitters, an electromagnetic site survey should be considered. If the measured field strength in the location in which the Impactis M+ unit is used exceeds the applicable RF compliance level above, the unit should be observed to verify normal operation. If abnormal performance is observed, additional measures may be necessary, such as re-orienting or relocating the Impactis M+ unit.

Applied compliance level is suitable for home healthcare environment. It means the device may be connected to the public low-voltage power supply network.

Immunity test	IEC60601 test level	Compliance level
Electric fast transient / burst IEC 61000-4-4	±2 kV	±2 kV

Immunity test	IEC60601 test level	Compliance level
Surges IEC 61000-4-5	±1 kV line-to-line	±1 kV line-to-line

Immunity test	IEC60601 test level	Compliance level
Conducted RF IEC 61000-4-6	3 Vrms 150 kHz to 80 MHz 6 Vrms in ISM and amateur radio bands between 150 kHz – 80 MHz	3 Vrms 150 kHz to 80 MHz 6 Vrms in ISM and amateur radio bands between 150 kHz – 80 MHz

Field strengths from fixed transmitters, such a base stations for radio (cellular / cordless) telephones and land mobile radios, amateur radio, AM and FM radio broadcast and TV broadcast cannot be predicted theoretically with accuracy. To assess the electromagnetic environment due to fixed RF transmitters, an electromagnetic site survey should be considered. If the measured field strength in the location in which the Impactis M+ unit is used exceeds the applicable RF compliance level above, the unit should be observed to verify normal operation. If abnormal performance is observed, additional measures may be necessary, such as re-orienting or relocating the Impactis M+ unit.

Applied compliance level is suitable for home healthcare environment. It means the device may be connected to the public low-voltage power supply network.

11. Specification and accessories

Immunity test	IEC60601 test level	Compliance level
Magnetic field power frequency (50 and 60 Hz) IEC 61000-4-8	30 A/m	30 A/m

Immunity test	IEC60601 test level	Compliance level
Voltage dips IEC 61000-4-11	0% U _T 0,5 cycle, phase angles of synchronization with AC power supply voltage 0°, 45°, 90°, 135°, 180°, 225°, 270°, 315°	Complies
	0% U _T 1 cycle, phase angle of synchronization with AC power supply voltage 0°	Complies
	70% U _T 25 cycles for 50 Hz 30 cycles for 60 Hz phase angle of synchronization with AC power supply voltage 0°	Complies
Voltage interruptions IEC 61000-4-11	0% U _T 250 cycles for 50 Hz 300 cycles for 60 Hz	Complies

Immunity test	Compliance level
Proximity fields from RF wireless communications equipment according to 8.10 IEC 60601-1-2:2014	Complies

11.3 Standard accessory

No.	Name	REF	Quantity
1.	Impactis M+ controller	A-UF-AST-IMM+	1
2.	Switch mode power supply – type Sinpro HPU150B-108 or Mean Well GSM160B24-R7B1 or XP Power AHM150PS24C2-8	A-AF-AST-PSUSP150 A-AF-AST-PSUMW160 A-AF-AST-PSUXP150	1
3.	Mains cable	-	1
4.	Shockwave applicator	-	1
5.	Steel transmitter 10 mm with O-rings 12x3, 8x3 and dedicated cap	A-AF-AST-TR10SET	1
6.	Steel transmitter 15 mm with O-rings 12x3, 13x3 and dedicated cap	A-AF-AST-TR15SET	1
7.	Steel transmitter 20 mm with O-rings 12x3, elastomer spring and dedicated cap	A-AF-AST-TR20SET	1
8.	Titanium transmitter 15 mm supplied with 12x3 and 13x3 O-rings and a dedicated cap	A-AF-AST-TR15SET-TI	1
9.	Spare O-ring 8x3	-	2
10.	Spare O-ring 12x3	-	2
11.	Spare O-ring 13x3	-	2
12.	Spare elastomer spring	-	2
13.	Ultrasound therapy gel 500 g	-	1
14.	Spare fuses T10L250, 10 A, 250 V	-	1
15.	Applicator holder	A-AF-AST-ISWHOLDER	1
16.	Screwdriver for holder mounting	-	1
17.	Touchscreen cloth	-	1
18.	Touchscreen pen	-	1
19.	User manual	-	1
20.	Electrical safety inspection report	-	1

11.4 Additional accessory









Applicators and trolleys	
Name	REF
Projectile system with a tool (Allen key)	A-AF-AST-IMMREG
Applicator cleaning kit	A-AF-AST-ZCZ
Steel transmitter 35 mm with O-rings 12x3, elastomer spring and dedicated cap	A-AF-AST-TR35SET
Titanium transmitter 10 mm with O-rings 12x3, 8x3 and dedicated cap	A-AF-AST-TR10SET-TI
Titanium transmitter 20 mm with O-rings 12x3, elastomer spring and dedicated cap	A-AF-AST-TR20SET-TI
Trolley Versa X	A-AM-AST-VSX
Other accessories	
Name	
Hearing protector	Bag for the unit and accessories





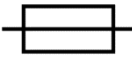







12. Appendix A. Symbol description

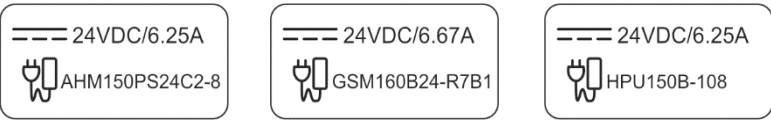

Recommendation for the operator's position to ensure the legibility of markings and information on the controller and accessory labels:

- € visual distance – shall be 30 cm due to the applied technologies,
- € lighting – 500 lx, which corresponds to normal room lighting conditions.





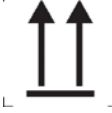







12.1 Controller, applicator, packaging

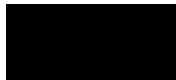









Symbol	Definition
	Caution, see the ACCOMPANYING DOCUMENTATION, symbol ISO 7000-0434A
	Class II equipment, symbol IEC 60417-5172
	BF type equipment, symbol IEC 60417-5333
	Date of production: year, symbol ISO 7000-2497
	Manufacturer, symbol ISO 7000-3082
IP20	Degree of protection provided by enclosures (IP code), based on IEC 60529
	Fuse, symbol IEC 60417-5016
VER	Unit version
	Serial number, symbol ISO 7000-2498
	Batch code, symbol ISO 7000-2492
	Catalogue number, symbol ISO 7000-2493
	Disposal of used devices together with other waste is prohibited, complied with the requirements of WEEE

Symbol	Definition
	Follow operating instructions, symbol ISO 7010-M002 Background color: blue
	Sitting prohibited, symbol ISO 7010-P018 Background color: white Circular band and slash: red Symbol or text: black
	Stepping prohibited, symbol ISO 7010-P019 Background color: white Circular band and slash: red Symbol or text: black
	Pushing prohibited, symbol ISO 7010-P017 Background color: white Circular band and slash: red Symbol or text: black
	Operator's manual; operating instructions, symbol ISO7000-1641
	Shockwave therapy applicator socket
	Switch mode power supply socket, direct current, symbol IEC 60417-5031
	Switched-mode power supplies identification
	Product output parameters
	Weight
	Packaging size
	Temperature limit, symbol ISO 7000-0632
	Keep away from rain, symbol ISO 7000-0626
	Fragile; handle with care, symbol ISO 7000-0621

Symbol	Definition
	This way up, symbol ISO 7000-0623
	The marking of conformity with legal regulations for medical devices applicable in the European Union along with the number of the Notified Body taking part in the conformity assessment.

12.2 Switched-mode power supplies – casing

Symbol	Description	SMPS type
	TUV Rheinland conformity mark (the table lists the standards for which compliance has been demonstrated, the ID means the notified body's report number).	GSM160B24-R7B1 (Mean Well) HPU150B-108 (Sinpro)
	TUV Sud conformity mark – GS mark (meeting the quality and safety requirements specified by the German regulations on the safety of equipment and products – <i>ProdSG</i>).	AHM150PS24C2-8 (XP Power)
	TUV Sud conformity mark: € the product has undergone a comprehensive testing procedure € the production facility is monitored regularly	AHM150PS24C2-8 (XP Power)
	Marking of compliance with the requirements of legal regulations in force in the European Union.	all
	UL+CUL conformity mark (USA, Canada). The alphanumeric string represents the approved UL report number.	all
	UL conformity mark (USA, Canada).	AHM150PS24C2-8 (XP Power)
	<i>Federal Communications Commission</i> EMC compliance mark (USA)	HPU150B-108 (Sinpro)
 Energy Verified Rendement Énergétique Vérifié	UL conformity mark – compliance with the requirements of energy-saving requirements included in <i>Title 24</i> document (<i>California Building Standards Commission</i>).	GSM160B24-R7B1 (Mean Well)
	Caution, symbol ISO 7000-0434A	GSM160B24-R7B1 (Mean Well)
	Dangerous voltage, symbol IEC 60417-5036	GSM160B24-R7B1 (Mean Well)
	For indoor use only, symbol IEC 60417-5957	all
	Class II equipment, symbol IEC 60417-5172	all

Symbol	Description	SMPS type
	Manufacturer's declaration of compliance with the requirements of the RoHS directive	AHM150PS24C2-8 (XP Power)
	Compliance with the RoHS directive SJ/T 11364-2014 (China). The number indicates the service life of an environmentally friendly electric and electronic product.	GSM160B24-R7B1 (Mean Well) AHM150PS24C2-8 (XP Power)
	Disposal of used devices together with other waste is prohibited, complied with the requirements of WEEE	all
	Upper limit of temperature, symbol ISO 7000-0533	GSM160B24-R7B1 (Mean Well)
	Energy efficiency level	GSM160B24-R7B1 (Mean Well) HPU150B-108 (Sinpro)
	Do not disassembly	GSM160B24-R7B1 (Mean Well)
	Plug pin description	GSM160B24-R7B1 (Mean Well)
	Plug pin description	HPU150B-108 (Sinpro)
	Direct current (DC), symbol IEC 60417-5031	all
	Alternating current (AC), symbol IEC 60417-5032	AHM150PS24C2-8 (XP Power) HPU150B-108 (Sinpro)
IP21, IP22	Degree of protection provided by enclosures (IP code), based on IEC 60529	

13. Appendix B. List of preset treatment programs

13.1 Orthopedics and sports medicine

No.	Disease entity	Treatment parameters			Method / No. of treatments / Treatment frequency / Notes
		Pressure [bar]	Frequency [Hz]	No. of shocks	
1.	Increased shoulder complex tension	2	12	2500	<p>• 15 mm, steel</p> <p>• methodology: <u>Patient position:</u> lying on the healthy side, or sitting.</p> <p>Prior to treatment, please check which muscles have increased tension. <u>Depending on which muscle group is strained, treatment is performed on a given area.</u></p> <p><u>I stage:</u> The patient adducts bent at the elbow an upper limb and puts hand on the back. Slow, linear movements – the therapist performs treatment on the anterior part of shoulder muscles.</p> <p><u>II stage:</u> The patient adducts an upright upper limb to the body. Slow, linear movements – the therapist performs treatment on the lateral part of shoulder muscles.</p> <p><u>III stage:</u> The patient adducts horizontally an upper limb to the chest. Slow, linear movements – the therapist performs treatment on the posterior part of shoulder muscles.</p> <p>In an area of increased tension (trigger points) the therapist may apply additional 100-200 shocks.</p> <p>• 3-5 depending on the treatment progress.</p> <p>• The break between treatments should be from 5 to 10 days, and it should gradually extend after each treatment.</p>
2.	Inflammation of the articular capsule of the humerus	2	10	3000	<p>• 15 mm, steel</p> <p>• methodology: <u>Patient position:</u> lying on the healthy side, or sitting.</p> <p><u>Treatment consists of 3 stages:</u></p> <p><u>I stage:</u> The patient adducts bent at the elbow an upper limb and puts hand on the back. Slow, linear movements – the therapist performs treatment on the anterior part of shoulder muscles.</p> <p><u>II stage:</u> The patient adducts an upright upper limb to the body. Slow, linear movements – the therapist performs treatment on the lateral part of shoulder muscles.</p> <p><u>III stage:</u> The patient adducts horizontally an upper limb to the chest. Slow, linear movements – the therapist performs treatment on the posterior part of shoulder muscles.</p> <p>• 4-8 depending on the treatment progress.</p> <p>• The break between treatments should be from 5 to 10 days, and it should gradually extend after each treatment.</p>
3.	Increased tension of trapezius muscle	2	15	2500	<p>• 20 mm, steel</p> <p>• methodology: <u>Patient position:</u> lying face down or sitting.</p> <p>Linear movements – the therapist performs treatment on the descending part of the trapezius muscle.</p> <p>In an area of increased tension the therapist may apply additional 100-200 shocks.</p> <p>• 3-5 depending on the treatment progress</p> <p>• frequency: every 2-4 days.</p> <p>• The spine of scapula and area around the spinous and transverse process should be avoided</p>

No.	Disease entity	Treatment parameters			Method / No. of treatments / Treatment frequency / Notes
		Pressure [bar]	Frequency [Hz]	No. of shocks	
4.	Overload changes and enthesopathies of rotator cuff muscles - supraspinatus muscle	2	12	3000	<p>15 mm, steel and titanium</p> <p>Patient position: sitting.</p> <p><u>Treatment consists of 2 stages:</u> <u>I stage:</u> The patient leaves an upper limb freely along the body. Linear movements - the therapist performs treatment on the supraspinatus muscle belly. <u>II stage:</u> The patient adducts bent at the elbow, an upper limb and puts hand on the back. Slow, circular movements – the therapist performs treatment within the area of greater tuberosity.</p> <p>4-8 depending on the treatment progress.</p> <p>The break between treatments should be from 5 to 10 days, and it should gradually extend after each treatment.</p> <p>Notes: To ensure higher energy, the use of the titanium transmitter is suggested in stage 1. In significantly higher pain sensation, reduce the pressure level by 25%.</p>
5.	Overload changes and enthesopathies of rotator cuff muscles - infraspinatus muscle	2	12	3000	<p>15 mm, steel and titanium</p> <p>Patient position: lying on the healthy side, upper limbs bent at the elbow, adducted.</p> <p><u>Treatment consists of 2 stages:</u> <u>I stage:</u> Slow, linear movements – the therapist performs treatment on the infraspinatus muscle belly. <u>II stage:</u> Slow, linear movements – the therapist performs treatment covering whole tendon area and greater tuberosity muscle.</p> <p>4-8 depending on the treatment progress.</p> <p>The break between treatments should be from 5 to 10 days, and it should gradually extend after each treatment.</p> <p>Notes: To ensure higher energy, the use of the titanium transmitter is suggested in stage 1. In significantly higher pain sensation, reduce the pressure level by 25%.</p>
6.	Overload changes and enthesopathies of rotator cuff muscles - subscapularis muscle	2	12	3000	<p>15 mm, steel and titanium</p> <p>Patient position: lying on the back.</p> <p><u>Treatment consists of 2 stages:</u> <u>I stage:</u> limb placed over the head (abduction, external rotation) on the couch. Slow, linear movements – the therapist performs treatment on the accessible parts of the subscapularis muscle. <u>II stage:</u> The patient adducts the limb along the body and rotates externally. Slow, circular movements – the therapist performs treatment within the area of lesser tubercle.</p> <p>4-8 depending on the treatment progress.</p> <p>The break between treatments should be from 5 to 10 days, and it should gradually extend after each treatment.</p> <p>Notes: To ensure higher energy, the use of the titanium transmitter is suggested in stage 1. In significantly higher pain sensation, reduce the pressure level by 25%.</p>

No.	Disease entity	Treatment parameters			Method / No. of treatments / Treatment frequency / Notes
		Pressure [bar]	Frequency [Hz]	No. of shocks	
7.	Enthesopathy calcification of the rotator cuff muscles - supraspinatus muscle	3	12	3000	<p>15 mm, steel and titanium</p> <p><u>Patient position:</u> sitting.</p> <p><u>Treatment consists of 2 stages:</u> <u>I stage:</u> The patient leaves an upper limb freely along the body. Linear movements – the therapist performs treatment on the supraspinatus muscle belly. <u>II stage:</u> The patient adducts bent at the elbow, an upper limb and puts hand on the back. Slow, circular movements – the therapist perform treatment within the area of greater tuberosity.</p> <p>4-8 depending on the treatment progress.</p> <p>The break between treatments should be from 5 to 10 days, and it should gradually extend after each treatment. Notes: To ensure higher energy, the use of the titanium transmitter is suggested in stage 1. In significantly higher pain sensation, reduce the pressure level by 30%.</p>
8.	Enthesopathy calcification of the rotator cuff muscles - infraspinatus muscle	3	12	3000	<p>15 mm, steel and titanium</p> <p><u>Patient position:</u> lying on the healthy side, upper limbs bent at the elbow joints, adducted.</p> <p><u>Treatment consists of 2 stages:</u> <u>I stage:</u> Slow, linear movements – the therapist performs treatment on the infraspinatus muscle belly. <u>II stage:</u> Slow, linear movements – the therapist performs treatment covering whole tendon area and greater tuberosity muscle.</p> <p>4-8 depending on the treatment progress.</p> <p>The break between treatments should be from 5 to 10 days, and it should gradually extend after each treatment. Notes: To ensure higher energy, the use of the titanium transmitter is suggested in stage 1. In significantly higher pain sensation, reduce the pressure level by 30%.</p>
9.	Enthesopathy calcification of the rotator cuff muscles - subscapularis muscle	3	12	3000	<p>15 mm, steel and titanium</p> <p><u>Patient position:</u> lying on the back.</p> <p><u>Treatment consists of 2 stages:</u> <u>I stage:</u> limb placed over the head (abduction, external rotation) on the couch. Slow, linear movements – the therapist performs treatment on the accessible parts of the subscapularis muscle. <u>II stage:</u> The patient adducts the limb along the body and rotates externally. Slow, circular movements – the therapist performs treatment within the area of lesser tubercle.</p> <p>4-8 depending on the treatment progress.</p> <p>The break between treatments should be from 5 to 10 days, and it should gradually extend after each treatment. Notes: To ensure higher energy, the use of the titanium transmitter is suggested in stage I. In significantly higher pain sensation, reduce the pressure level by 30%.</p>

No.	Disease entity	Treatment parameters			Method / No. of treatments / Treatment frequency / Notes
		Pressure [bar]	Frequency [Hz]	No. of shocks	
10.	Subacromial bursitis	2	10	3000	<p>15 mm, steel and titanium</p> <p>u</p> <p><u>Patient position:</u> sitting, upper limb along the body.</p> <p><u>Treatment consists of 2 stages:</u> <u>I stage:</u> Slow, linear movements – the therapist performs treatment on the deltoid muscle belly avoiding the area of bursa. <u>II stage:</u> The therapist performs treatment on the muscle bellies in which we noticed increased tension e.g. supraspinatus / long head of the biceps.</p> <p>u 4-8 depending on the treatment progress.</p> <p>u The break between treatments should be from 5 to 10 days, and it should gradually extend after each treatment. Notes: To ensure higher energy, the use of the titanium transmitter is suggested in stage II. In significantly higher pain sensation, reduce the pressure level by 25%.</p>
11.	Calcification within the shoulder complex	2	10	2000	<p>15 mm, steel and titanium</p> <p>u</p> <p><u>Patient position:</u> sitting, unhealthy upper limb slightly abducted, forearm placed on the couch.</p> <p>Slow, circular movements – the therapist performs treatment within the acromioclavicular joint area.</p> <p>u a series: 3-5 depending on the treatment progress.</p> <p>u The break between treatments should be from 5 to 10 days, and it should gradually extend after each treatment. Notes: To ensure higher energy, the use of the titanium transmitter is suggested. In significantly higher pain sensation, reduce the pressure level by 25%.</p>
12.	Tennis elbow	2	12	3000	<p>15 mm, steel and titanium</p> <p>u</p> <p><u>Patient position:</u> sitting, the forearm is leaning on the couch (internal rotation).</p> <p><u>Treatment consists of 2 stages:</u> <u>I stage:</u> Linear movements – the therapist performs treatment on the extensor and/or abductor wrist muscles as well as supinator muscle. <u>II stage:</u> Slow, circular movements – the therapist performs treatment on the lateral epicondyle of the humerus.</p> <p>If the therapist noticed increased muscle tension of triceps brachii muscle, the treatment should be performed on the muscle belly.</p> <p>u 4-8 depending on the treatment progress.</p> <p>u The break between treatments should be from 5 to 10 days, and it should gradually extend after each treatment. Notes: To ensure higher energy, the use of the titanium transmitter is suggested in stage I. In significantly higher pain sensation, reduce the pressure level by 25%. If the triceps brachii muscle exhibits increased tension, the use of the titanium transmitter is suggested to work out its belly.</p>

No.	Disease entity	Treatment parameters			Method / No. of treatments / Treatment frequency / Notes
		Pressure [bar]	Frequency [Hz]	No. of shocks	
13.	Golfer's elbow	2	12	3000	<ul style="list-style-type: none"> • 15 mm, steel and titanium • Patient position: lying on the back, an upper limb is abducted and rotates externally. Under the elbow joint there should be placed a rolled-on towel or roller with a diameter of approx. 10 cm. • Treatment consists of 2 stages: • I stage: Linear movements – the therapist performs treatment on the pronator teres and flexor capri muscles. • II stage: Slow, circular movements – the therapist performs treatment on the anterior part of the medial epicondyle of the humerus and pronator teres attachments. • Frequency: 4-8 depending on the treatment progress. • Break: The break between treatments should be from 5 to 10 days, and it should gradually extend after each treatment. • Notes: To ensure higher energy, the use of the titanium transmitter is suggested in stage I. In significantly higher pain sensation, reduce the pressure level by 25%.
14.	Dupuytren's contracture	2	12	1000	<ul style="list-style-type: none"> • 10 mm, steel • methodology: • Patient position: sitting, an upper limb bent at the elbow, forearm in external rotation leaning on the couch. • Linear movements – the therapist performs treatment on the palmar aponeurosis of the ring and little finger. • Frequency: in a series: 3-5 depending on the treatment progress. • Break: The break between treatments should be from 5 to 10 days, and it should gradually extend after each treatment.
15.	Trigger points	1,5	5	500	<ul style="list-style-type: none"> • 10 mm, steel • Treatment methodology: • Patient position: depending on the trigger point localization. • Still or slow, circular movements – the therapist performs treatment directly on the trigger point and its surrounding area. • Frequency: 3-5 depending on the treatment progress. • Break: The break between treatments should be from 5 to 10 days, and it should gradually extend after each treatment.
16.	Piriformis syndrome	3	12	2000	<ul style="list-style-type: none"> • 15 mm, steel and titanium • Patient position: lying face down. • Linear movements – the therapist performs treatment around the piriformis muscle area. • Frequency: 4-8 depending on the treatment progress. • Break: The break between treatments should be from 5 to 10 days, and it should gradually extend after each treatment. • Notes: To ensure higher energy, the use of the titanium transmitter is suggested. In significantly higher pain sensation, reduce the pressure level by 30%.

No.	Disease entity	Treatment parameters			Method / No. of treatments / Treatment frequency / Notes
		Pressure [bar]	Frequency [Hz]	No. of shocks	
17.	Overload changes of sacroiliac joint	2	15	2000	<ul style="list-style-type: none"> • 15 mm, steel and titanium • Patient position: lying face down. <p>Linear movements – the therapist performs treatment on the ligaments around sacroiliac joint gaps. There is also a possibility to perform treatment on the trigger points located on gluteal muscles.</p> <ul style="list-style-type: none"> • 3-5 depending on the treatment progress. • The break between treatments should be from 5 to 10 days, and it should gradually extend after each treatment. <p>Notes: To ensure higher energy, the use of the titanium transmitter is suggested. In significantly higher pain sensation, reduce the pressure level by 25%.</p>
18.	Subtrochanteric bursitis	2	10	3000	<ul style="list-style-type: none"> • 15 mm, steel and titanium • Patient position: lying on the healthy side, unhealthy lower limb bent at the hip and knees joints. <p><u>Treatment consists of 2 stages:</u> <u>I stage:</u> Linear movements – the therapist performs treatment on the gluteus maximus muscle. <u>II stage:</u> Linear movements – the therapist performs treatment on the tensor fasciae latae muscle along with ilio-tibial band, avoiding the area of the bursa.</p> <ul style="list-style-type: none"> • number in a series: 4-8 depending on the treatment progress. • The break between treatments should be from 5 to 10 days, and it should gradually extend after each treatment. <p>Notes: To ensure higher energy, the use of the titanium transmitter is suggested. In significantly higher pain sensation, reduce the pressure level by 25%.</p>
19.	Increased gluteal muscle tension	3	15	4000	<ul style="list-style-type: none"> • 20 mm, steel • Patient position: lying face down. <p>Linear movements – the therapist performs treatment on the gluteal muscles.</p> <ul style="list-style-type: none"> • 3-5 depending on the treatment progress. • The break between treatments should be from 5 to 10 days, and it should gradually extend after each treatment.
20.	Adductor muscle enthesopathy (groin pain)	2	12	3500	<ul style="list-style-type: none"> • 15 mm, steel and titanium • Patient position: lying on the back, unhealthy lower limb abducted at an angle of about 45 degrees. Under the knee joint there should be placed a roller with a diameter of approx. 10 cm. <p><u>Treatment consists of 2 stages:</u> <u>I stage:</u> Linear movements, the therapist performs treatment on the adductor longus muscle. <u>II stage:</u> Slow, circular movements – the therapist performs treatment on the inferior pubic ramus.</p> <ul style="list-style-type: none"> • 4-8 depending on the treatment progress. • The break between treatments should be from 5 to 10 days, and it should gradually extend after each treatment. <p>Notes: To ensure higher energy, the use of the titanium transmitter is suggested in stage I. In significantly higher pain sensation, reduce the pressure level by 25%.</p>

No.	Disease entity	Treatment parameters			Method / No. of treatments / Treatment frequency / Notes
		Pressure [bar]	Frequency [Hz]	No. of shocks	
21.	Intramuscular hematoma – chronic condition	2	15	2500	<p>• 15 mm, steel and titanium</p> <p>•</p> <p><u>Patient position:</u> depending on the injured muscle.</p> <p><u>Treatment consists of 2 stages:</u> <u>I stage:</u> Linear or circular movements – the therapist performs treatment on the intact muscle parts. <u>II stage:</u> Circular movements – the therapist performs treatment on the hematoma area – from periphery to center.</p> <p>• 3-5 depending on the treatment progress.</p> <p>• The break between treatments should be from 5 to 10 days, and it should gradually extend after each treatment.</p> <p>Notes: To ensure higher energy, the use of the titanium transmitter is suggested in stage I. In significantly higher pain sensation, reduce the pressure level by 25%.</p>
22.	Ischio-shin muscle enthesopathy	3	12	4000	<p>• 20 mm, steel</p> <p>•</p> <p><u>Patient position:</u> lying face down, under the ankle joint there should be placed a roller with a diameter of approx. 15 cm.</p> <p><u>Treatment consists of 2 stages:</u> <u>I stage:</u> Linear movements – the therapist performs treatment on the injured muscle bellies. <u>II stage:</u> Circular movements – the therapist performs treatment around muscle attachment of the ischial tuberosity.</p> <p>• 4-8 depending on the treatment progress.</p> <p>• The break between treatments should be from 5 to 10 days, and it should gradually extend after each treatment.</p>
23.	Jumper's knee	2	10	4000	<p>• 15 mm, steel and titanium</p> <p>•</p> <p><u>Patient position:</u> lying on the back, under the knee joint there should be placed a roller with a diameter of approx. 15 cm.</p> <p><u>Treatment consists of 2 stages:</u> <u>I stage:</u> Linear movements – the therapist performs treatment on the quadriceps femoris muscle. <u>II stage:</u> Still, or small and slow movements – the therapist performs treatment on the patellar tendon and tibial tuberosity.</p> <p>• Series: 4-8 depending on the treatment progress.</p> <p>• The break between treatments should be from 5 to 10 days, and it should gradually extend after each treatment.</p> <p>Notes: To ensure higher energy, the use of the titanium transmitter is suggested in stage I. In significantly higher pain sensation, reduce the pressure level by 25%.</p>

No.	Disease entity	Treatment parameters			Method / No. of treatments / Treatment frequency / Notes
		Pressure [bar]	Frequency [Hz]	No. of shocks	
24.	ITB – Ilio-Tibial Band Syndrome (runner's knee)	3	15	4000	<p>15 mm, steel and titanium</p> <p>Patient position: lying on the healthy side, unhealthy lower limb bent at the hip and knee joint.</p> <p>Treatment consists of 2 stages: I stage: Linear movements – the therapist performs treatment on the gluteus maximus muscle. II stage: Linear movements – the therapist performs treatment on the tensor fasciae latae muscle along Ilio-tibial band avoiding the area of the bursa around the lateral epicondyle of the femur.</p> <p>4-8 depending on the treatment progress.</p> <p>The break between treatments should be from 5 to 10 days, and it should gradually extend after each treatment.</p> <p>Notes: To ensure higher energy, the use of the titanium transmitter is suggested. In significantly higher pain sensation, reduce the pressure level by 30%.</p>
25.	Increased quadriceps femoris muscle tension	3	15	4000	<p>20 mm, steel</p> <p>methodology: Patient position: lying on the back, under the knee joint there should be placed a roller with a diameter of approx. 15 cm.</p> <p>Linear movements – the therapist performs treatment on the quadriceps femoris muscle.</p> <p>series: 4-8 depending on the treatment progress.</p> <p>The break between treatments should be from 5 to 10 days, and it should gradually extend after each treatment.</p>
26.	Overload changes of the tibialis anterior muscle	2	12	3000	<p>15 mm, steel and titanium</p> <p>Patient position: lying on the back, under the knee joint there should be placed a roller with a diameter of approx. 15 cm.</p> <p>Slow, linear movements – the therapist performs treatment on the entire are of tibialis anterior muscle.</p> <p>4-8 depending on the treatment progress.</p> <p>The break between treatments should be from 5 to 10 days, and it should gradually extend after each treatment.</p> <p>Notes: To ensure higher energy, the use of the titanium transmitter is suggested. In significantly higher pain sensation, reduce the pressure level by 25%.</p>
27.	Compartment syndrome	2	12	3000	<p>15 mm, steel and titanium</p> <p>Patient position: depending on the treated part of the shank.</p> <p>Linear movements – the therapist performs treatment on shank muscles and margo medialis tibiae.</p> <p>4-8 depending on the treatment progress.</p> <p>The break between treatments should be from 5 to 10 days, and it should gradually extend after each treatment.</p> <p>Notes: To ensure higher energy, the use of the titanium transmitter is suggested. In significantly higher pain sensation, reduce the pressure level by 25%.</p>

No.	Disease entity	Treatment parameters			Method / No. of treatments / Treatment frequency / Notes
		Pressure [bar]	Frequency [Hz]	No. of shocks	
28.	Overload changes of the Achilles tendon	2	12	3000	<p>• 15 mm, steel and titanium</p> <p>• <u>Patient position:</u> lying face down, feet hang of the couch.</p> <p>Slow, linear movements – the therapist performs treatment on the Achilles tendon along with gastrocnemius muscle. In addition, if there is a tension, the therapist may perform treatment on the plantar aponeurosis.</p> <p>• 4-8 depending on the treatment progress.</p> <p>• The break between treatments should be from 5 to 10 days, and it should gradually extend after each treatment.</p> <p>Notes: To ensure higher energy, the use of the titanium transmitter is suggested. In significantly higher pain sensation, reduce the pressure level by 25%.</p>
29.	Inferior calcaneal spur	3	12	3000	<p>• 15 mm, steel and titanium</p> <p>• <u>Patient position:</u> lying face down, under the ankle joint there should be placed a roller with a diameter of approx. 15 cm.</p> <p><u>Treatment consists of 2 stages:</u> <u>I stage:</u> Slow, linear movements – the therapist performs treatment on the plantar aponeurosis. <u>II stage:</u> The therapist performs treatment around the calcaneal spur area. If we noticed increased tension of triceps surae muscle, the therapist should perform treatment on its bellies.</p> <p>• 4-8 depending on the treatment progress.</p> <p>• The break between treatments should be from 5 to 10 days, and it should gradually extend after each treatment.</p> <p>Notes: To ensure higher energy, the use of the titanium transmitter is suggested in stage I. In significantly higher pain sensation, reduce the pressure level by 30%.</p>
30.	Posterior calcaneal spur	3	12	3000	<p>• 15 mm, steel and titanium</p> <p>• <u>Patient position:</u> lying face down, feet hang of the couch.</p> <p><u>Treatment consists of 2 stages:</u> <u>I stage:</u> Linear movements – the therapist performs treatment on the Achilles tendon along with gastrocnemius muscle. <u>II stage:</u> Slow, circular movements – the therapist performs treatment in a place where the calcaneal spur is located. In addition, if there is a tension, the therapist may perform treatment on the plantar aponeurosis.</p> <p>• 4-8 depending on the treatment progress.</p> <p>• The break between treatments should be from 5 to 10 days, and it should gradually extend after each treatment.</p> <p>Notes: To ensure higher energy, the use of the titanium transmitter is suggested in stage I. In significantly higher pain sensation, reduce the pressure level by 30%.</p>

No.	Disease entity	Treatment parameters			Method / No. of treatments / Treatment frequency / Notes
		Pressure [bar]	Frequency [Hz]	No. of shocks	
31.	Haglund's disease	3	12	3000	<ul style="list-style-type: none"> • 15 mm, steel and titanium • Patient position: lying face down, feet hang of the couch. • Treatment consists of 2 stages: <ul style="list-style-type: none"> I stage: Linear movements – the therapist performs treatment on the Achilles tendon along with gastrocnemius muscle. II stage: Slow, circular movements – the therapist performs treatment in a place where the calcaneal spur is located. • In addition, if there is a tension, the therapist may perform treatment on the plantar aponeurosis. • 4-8 depending on the treatment progress. • The break between treatments should be from 5 to 10 days, and it should gradually extend after each treatment. • Notes: To ensure higher energy, the use of the titanium transmitter is suggested in stage I. In significantly higher pain sensation, reduce the pressure level by 30%.
32.	Overload changes of the plantar aponeurosis.	2	12	3000	<ul style="list-style-type: none"> • 15 mm, steel and titanium • Patient position: lying face down, under the ankle joint there should be placed a roller with a diameter of approx. 15 cm. • Linear movements – the therapist performs treatment on the plantar aponeurosis. If we noticed increased tension of triceps surae muscle, the therapist should perform treatment on its bellies. • 4-8 depending on the treatment progress. • The break between treatments should be from 5 to 10 days, and it should gradually extend after each treatment. • Notes: To ensure higher energy, the use of the titanium transmitter is suggested. In significantly higher pain sensation, reduce the pressure level by 25%.

13.2 Aesthetic medicine

No.	Disease entity	Treatment parameters			Method / No. of treatments / Treatment frequency / Notes
		Pressure [bar]	Frequency [Hz]	No. of shocks	
33.	Fibrous cellulite, outer part of the thigh	2	10	5000	<ul style="list-style-type: none"> • 35 mm, steel • Linear movements – the therapist performs treatment on the fat tissue located over: vastus lateralis muscle, tensor fasciae latae muscle, biceps femoris muscle. • 6-8 depending on the aesthetic effects. • Treatment frequency: 3-4 days depending on the treatment progress.
34.	Fibrous cellulite, inner part of the thigh	1,8	10	4000	<ul style="list-style-type: none"> • 35 mm, steel • Linear movements – the therapist performs treatment on the fat tissue located over: adductor longus muscle, gracilis muscle, semimembranosus muscle, semitendinosus muscle. • 6-8 depending on the aesthetic effects. • Treatment frequency: 3-4 days depending on the treatment progress.

No.	Disease entity	Treatment parameters			Method / No. of treatments / Treatment frequency / Notes
		Pressure [bar]	Frequency [Hz]	No. of shocks	
35.	Cellulite, buttocks	1,8	11	4500	<ul style="list-style-type: none"> • 35 mm, steel • Linear movements – the therapist performs treatment on the fat tissue located on the gluteus maximus muscle. • 6-8 depending on the aesthetic effects. • 3-4 days depending on the treatment progress.
36.	Mixed cellulite	3,5	11	4000	<ul style="list-style-type: none"> • 35 mm, steel • Linear movements – the therapist performs treatment on local changes. • 5-8 depending on the aesthetic effects. • 3-4 days depending on the treatment progress.
37.	Local obesity	2	11	4500	<ul style="list-style-type: none"> • 20 mm, steel • Linear movements – the therapist performs treatment on local changes. • 6-8 depending on the aesthetic effects. • 3-4 days depending on the treatment progress.
38.	Buttocks firming	1,8	10	3500	<ul style="list-style-type: none"> • 20 mm, steel • Linear movements – the therapist performs treatment on the fat tissue located over the gluteus maximus muscle. • 6-8 depending on the aesthetic effects. • 3-4 days depending on the treatment progress.
39.	Firming up flabby skin areas - shoulder	1,5	15	2500	<ul style="list-style-type: none"> • 20 mm, steel • Linear movements – the therapist performs treatment on the fat tissue located over triceps and biceps brachii muscles. • 6-8 depending on the aesthetic effects. • 3-4 days depending on the treatment progress.
40.	Skin relaxation	1,8	10	4500	<ul style="list-style-type: none"> • 35 mm, steel • Linear movements – the therapist performs treatment on the entire treatment area. • 6-8 depending on the aesthetic effects. • 3-4 days depending on the treatment progress.
41.	Lifting – post-surgery	1,8	10	3000	<ul style="list-style-type: none"> • 20 mm, steel • Linear movements – the therapist performs treatment on local changes. • 6-8 depending on the aesthetic effects. • 3-4 days depending on the treatment progress.
42.	Liposuction – post-surgery	1,8	10	3000	<ul style="list-style-type: none"> • 20 mm, steel • Linear movements – the therapist performs treatment on local changes. • 6-8 depending on the aesthetic effects. • 3-4 days depending on the treatment progress.

No.	Disease entity	Treatment parameters			Method / No. of treatments / Treatment frequency / Notes
		Pressure [bar]	Frequency [Hz]	No. of shocks	
43.	Lymphatic drainage	1,8	10	6000	<ul style="list-style-type: none"> ü 35 mm, steel ü Linear movements – the therapist performs treatment on local changes. ü 8-12 depending on the aesthetic effects. ü 3-4 days depending on the treatment progress.
44.	Lymphedema	2	11	4500	<ul style="list-style-type: none"> ü 35 mm, steel ü Linear movements – the therapist performs treatment on local changes. ü 8-12 depending on the aesthetic effects. ü 3-4 days depending on the treatment progress.