

Small Changes **Difference** Big

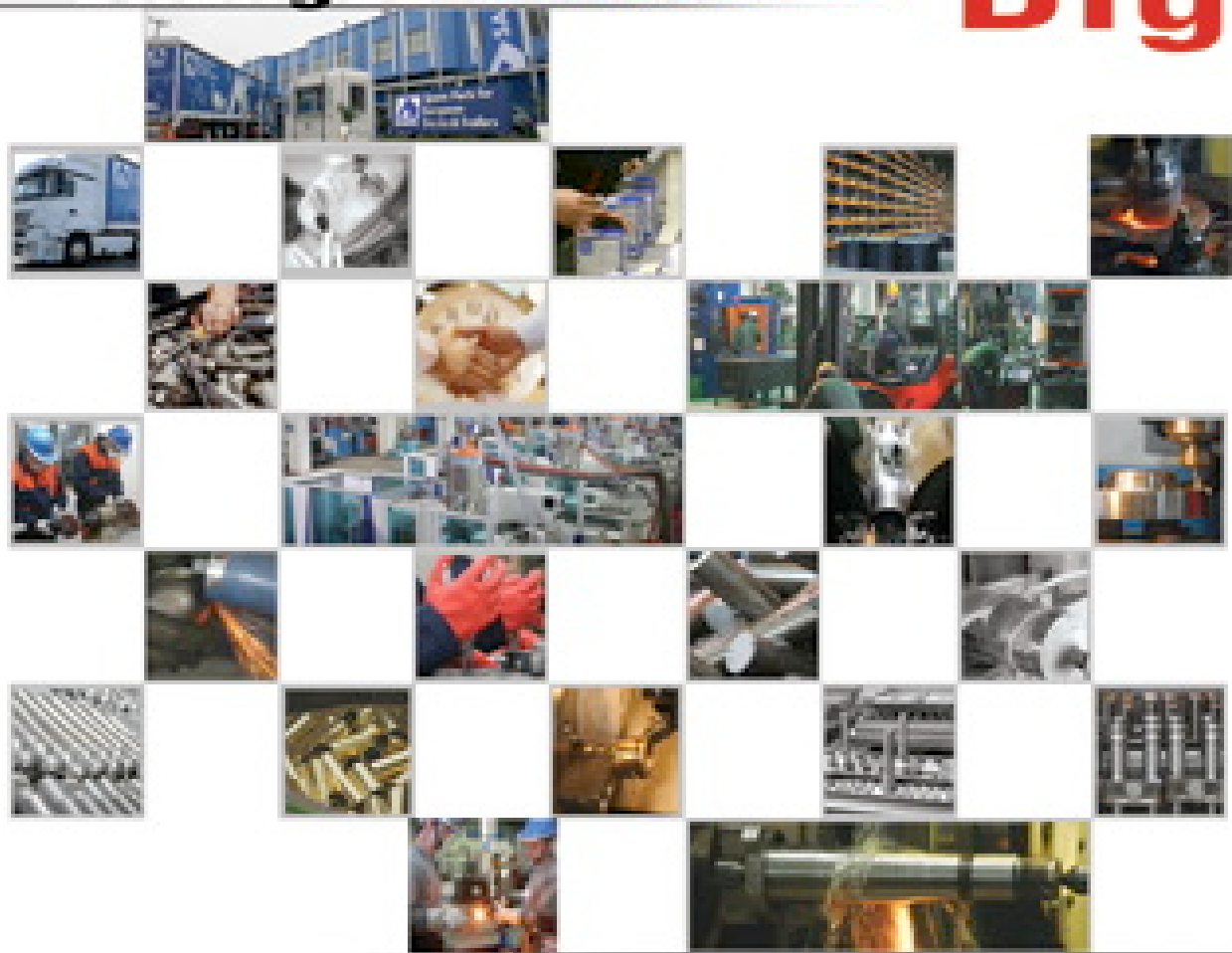

1-MERCEDES 2-MAN 3-VOLVO 4-SCANIA 5-DAF 6-IVECO 7-R.V.I. 8-JOST
9-ROCKINGER-RINGFEDER-SCHMITZ-UNIVERSAL PARTS 10-NEOPLAN
11-SETRA 12-BERGISCHE ACHSEN 13-SAUER ACHSEN 14-TRAILOR
15-KASSBOHRER 16-ROR 17-YORK 18-SAE-GIGANT 19-SMB 20-FRUEHAUF

ARTICLE GROUPS

1 - Spring/Suspension

2 - Cabin

3 - Stabilizer

4 - Brake

5 - Wheel-Axle

6 - V-Stay - Axle Control Arm

7 - Engine-Flywheel

8 - Propeller Shaft

9 - Transmission

10 - Trailer Spare Parts

11 - Cooling System

12 - Exhaust

13 - Shock Absorber

14 - Clutch / Air Suspension /

Chassis / Body / Pedal



CERTIFICATE

The TÜV CERT Certification Body
of TÜV Thüringen e.V.

certifies in accordance with TÜV CERT
procedure that



SAMPA OTOMOTİV SAN. VE TİC. LTD. ŞTİ.

**ÖRNEK SAN. SİTESİ SAHİL CAD. NO:4
KUTLUKENT – SAMSUN / TURKEY**

has established and applies a quality management system for

**PRODUCTION, SALES AND MARKETING, PACKAGING AND
DISTRIBUTING OF AUTOMOTIVE SPARE PARTS**

An audit was performed, Report No. 3330 2A9G A0

Proof has been furnished that the requirements according to

EN ISO 9001:2000

are fulfilled. The certificate is valid until 2010-04-10

Certificate Registration No. 15 100 74529



Jena, 2007-04-11

A. Dörschel
TÜV CERT Certification Body
of TÜV Thüringen e. V.

Spare Parts for European Trucks & Trailers



1

MERCEDES

"technology, reliability & quality..."



www.sampalkw.com



"technology, reliability & quality..."

www.sampalkw.com

Sampa Nr.

011.070

O.E.M. Nr.

000 322 03 85
(000 322 05 85)



Dimension

ø22xø60x76

Description

Rubber Bushing for Spring

BM	MODEL	650	1222, 1224, 1227 A, 1234
371	2517K/6X2/36 ...	651	1422,1431,1427,1431 ...
382	OH 1421,1621,1625 ...	652	1820 AK, 1824,1827...
390	OHL	653	2524, 2527, 2531 ...
397	2426 B/6X4, OH 1835L/30 ...	685	OH 1621, 1625
398	OH 1636 L	699	1424
437	Unimog U 2400 TG	749	WS 4/10 D-6,7
625	3229 /B, 3229 K, 3234 ...		

Sampa Nr.

011.071

O.E.M. Nr.

000 322 19 85



Dimension

ø24xø62x86

Description

Rubber Bushing for Spring

BM	MODEL
652	1722 L,1733 L,1834 L,2534 LL
653	2433 L,2534 L
657	2538 LS, 2429 LS/6X2/4 ...

Sampa Nr.

011.072

O.E.M. Nr.

000 322 12 85
(000 322 22 85)
(000 322 32 85)



Dimension

ø24xø62x96

Description

Rubber Bushing for Spring

BM	MODEL
374	1828, 1935, 3335 ...
375	2523, 1835 LS - 1843 LS ...
655	1844, 1831 L,2531 L
656	2038 AS,LAS,2044 AS/LAS ...
657	2538, 2435 S/6X2/4, 2550 LS
658	2448, 2550, 2553, 3248 ...
659	2638/K, 2644/K, 2650/K ...
930, 932, 933, 934,952,953,954	ACTROS
940, 942, 943, 944, 952	AXOR
958	ATEGO

Sampa Nr.

011.148

O.E.M. Nr.

000 325 02 85
(000 325 13 85)
(000 325 07 85)
(000 325 08 85)



Dimension

ø24xø62x106

Description

Rubber Bushing for Spring

BM	MODEL
374/375/950/952/958	AXOR
930/932/934/950/952/954	ACTROS
655	1831 AK,1834 AK,2531 ...
656	2031 A,2531/L,2038 A,2044 LA ...
657	2538 S
658	2448,2550,2553,3248,3253 ...
693	1938, 1938 S, 1944 S

Sampa Nr.

011.175

O.E.M. Nr.

974 320 02 44



Dimension

ø22.5xø66x96

Description

Rubber Bushing for Spring

BM	MODEL
375,970,972,974,975	ATEGO

Sampa Nr.

011.218

O.E.M. Nr.

000 322 09 85
(000 322 08 85)



Dimension

ø22xø60.5x50

Description

Rubber Bushing for Spring

BM	MODEL
625	3229 /B/K
625	3233 B/K, 3234 B/K

Spring Suspension

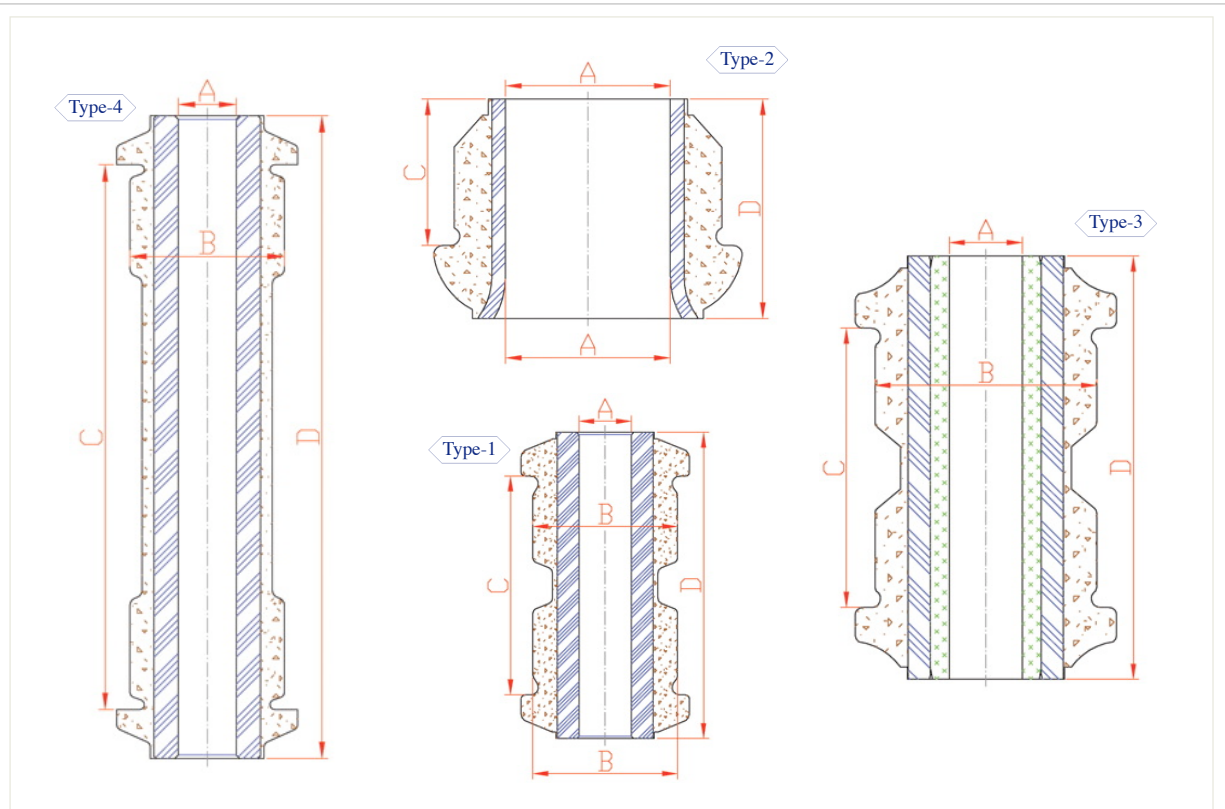

Sampa Nr.	O.E.M. Nr.	A	B	C	D	Type
011.056	000 321 03 50	ø12	ø33	50	70	1
011.066	601 324 00 50	ø12	ø49	47	70	1
011.067	901 324 02 50	ø12	ø50	56	80	1
011.171	901 324 01 50	ø12	ø32.5	60	80	1
011.172	901 324 00 50	ø12	ø32	114	134	4
011.216	638 333 00 14	ø14	ø41.5	46	75	1
011.217	901 333 02 14	ø14	ø44	60	80	1
011.057	673 320 00 50	ø16	ø46	66	96	1
011.061	000 321 02 50	ø16	ø39	60	80	1
011.062	611 324 00 50	ø16	ø50	56	80	1
011.163	970 320 01 44	ø16	ø50	63	95.5	3
011.058	675 320 00 50	ø18	ø48.5	63	96	1
011.128	675 325 05 85	ø18	ø64.5	64	96	1
011.235	970 320 03 44	ø18	ø56	64	96	3
011.162	974 320 00 44	ø22	ø63.5	62	96	3
011.059	310 320 00 50	ø30	ø52	49	77	1
011.063	667 320 00 44	ø30	ø52.5	56	86.5	1
011.069	670 320 04 44	ø30	ø52	55	86.5	1
011.060	675 320 01 50	ø36	ø63.5	62	96	1
011.064	673 320 02 50	ø36	ø58.5	32	48	2
011.065	673 320 01 50	ø36	ø58	64	96	1
011.068	670 320 03 44	ø36	ø58	54	86.5	1

Sampa Nr.

011.056

O.E.M. Nr.

000 321 03 50
(000 321 01 50)
(000 321 00 50)



Dimension

ø12xø33x70

Description

Rubber Bushing for Spring

BM	MODEL
601	208, 210, 207 D, 208 D, 209 D, 210 D
602	308, 310, 307 D, 308D, 309 D, 310 D

Sampa Nr.

011.066

O.E.M. Nr.

601 324 00 50
(601 324 01 50)
(602 324 00 50)
(602 324 01 50)



Dimension

ø12xø49x70

Description

Rubber Bushing for Spring

BM	MODEL
601	208, 210, 207, 208 D, 209 D, 210 D
602	308, 310, 307 D, 308 D, 309 D, 310 D

Sampa Nr.

011.067

O.E.M. Nr.

901 324 02 50
(901 324 03 50)



Dimension

ø12xø50x80

Description

Rubber Bushing for Spring

BM	MODEL
690,901,902,903	SPRINTER

Sampa Nr.

011.171

O.E.M. Nr.

901 324 01 50



Dimension

ø12xø32.5x80

Description

Rubber Bushing for Spring

BM	MODEL
690,901,902,903	Sprinter

Sampa Nr.

011.172

O.E.M. Nr.

901 324 00 50



Dimension

ø12xø32x134

Description

Rubber Bushing for Spring

BM	MODEL
690,901,902,903	SPRINTER

Sampa Nr.

011.216

O.E.M. Nr.

638 333 00 14



Dimension

ø14xø41.5x75

Description

Rubber Bushing for Spring

BM	MODEL
638	VITO

Spring Suspension



Sampa Nr.

011.217

O.E.M. Nr.

901 333 02 14

Dimension

ø14xø44x80

Description

Rubber Bushing for Spring

BM	MODEL
730	VL 0/6 CE - 1, 6/RS3550 ...
732	VL 0/10 CE-1. 6 ...
901,902,903,904	Sprinter



Sampa Nr.

011.057

O.E.M. Nr.

673 320 00 50

Dimension

ø16xø46x96

Description

Rubber Bushing for Spring

BM	MODEL
673	709, 711, 809 ...
674	814, 914 KO, 917 AK ...
675	1114 /K, O 1114 ...
676	817 F, 917 AK, 1117 ...
677	1120 S, O 1120, 1124 F ...
678	914



Sampa Nr.

011.061

O.E.M. Nr.

**000 321 02 50
(000 321 04 50)**

Dimension

ø16xø39x80

Description

Rubber Bushing for Spring

BM	MODEL
611	410, 407 D, 408 D, 409 D, 410 D
690,904,905,906	SPRINTER



Sampa Nr.

011.062

O.E.M. Nr.

**611 324 00 50
(611 324 03 50)
(611 324 04 50)**

Dimension

ø16xø50x80

Description

Rubber Bushing for Spring

BM	MODEL
611	410, 407 D, 408 D, 409 D, 410 D
690,904,905,906	SPRINTER



Sampa Nr.

011.163

O.E.M. Nr.

**970 320 01 44
(970 320 00 44)**

Dimension

ø16.5xø50x95.5

Description

Rubber Bushing for Spring

BM	MODEL
375,958,970,972,974,000,000	ATEGO



Sampa Nr.

011.058

O.E.M. Nr.

675 320 00 50

Dimension

ø18xø48.5x96

Description

Rubber Bushing for Spring

BM	MODEL
611	O 1120 L
674	917 AK, 914 AK, O 814 L, 814 LO
675	1314, 1317 K, 1514 ...
676	1117 LO, 1317 AK, 1320 AK ...
677	1120 AF, 1124 AF, 1317 ...
678	1114 /A/AK, 1117 /A
679	1320 L, 1324 S, 1524, 1724 ...

Sampa Nr.

011.128

O.E.M. Nr.

675 325 05 85



Dimension

ø18xø64.5x96

Description

Rubber Bushing for Spring

BM	MODEL
674	814 L
675	1514 L
676	817 L, 1517 L, 817 LS, O 817 L
677	1520 L, 2020 L
679	1524 L, 2024 L
970/974/975/976	ATEGO

Sampa Nr.

011.235

O.E.M. Nr.

**970 320 03 44
(675 325 04 85)**



Dimension

ø18xø56x96

Description

Rubber Bushing for Spring

BM	MODEL
675	1514 /K/L
676	1517 /K/L
677	1520 /L,1524,1720, 2020 L
679	1524 /L, 1724, 2024 /L
375	ATEGO
958,970,972,974,975,000	ATEGO

Sampa Nr.

011.162

O.E.M. Nr.

974 320 00 44



Dimension

ø22.5xø63.5x96

Description

Rubber Bushing for Spring

BM	MODEL
375,958,970,972,974	ATEGO

Sampa Nr.

011.059

O.E.M. Nr.

310 320 00 50



Dimension

ø30xø52x77

Description

Rubber Bushing for Spring

BM	MODEL
310	L 608 D, LK 608 D, LF 508 D ...
313	O 309 D, L 613 D
378	LO 608 D, L 608 K

Sampa Nr.

011.063

O.E.M. Nr.

667 320 00 44



Dimension

ø30xø52.5x86.5

Description

Rubber Bushing for Spring

BM	MODEL
668	609 D
669	709 D, 711 D, Vario
670	809 D, 811 D, 814 D
670	814 DA, 811 DK
906	SPRINTER

Sampa Nr.

011.069

O.E.M. Nr.

670 320 04 44



Dimension

ø30xø52x86.5

Description

Rubber Bushing for Spring

BM	MODEL	685	914/42
371	O 814 R	688	709, 710, L 710 D ...
398	LO 814	692	L 710 D, L 913 D, LO 813 D
667	510, 507 D, 508 D, 507 D, 508 DK	979	ACCELO
668	609 D		
669	709 D, 711 D, Vario		
670	809 D, 811 DDK, 814 DDA		

Spring Suspension



Sampa Nr.

011.060

O.E.M. Nr.

675 320 01 50

Dimension

ø36xø63,5x96

Description

Rubber Bushing for Spring

BM	MODEL	677	1117 L,1120 L,1121 L ...
675	1114, 1314, 1317 ...	678	914, 1114, 1117 ...
676	1117, 1317, 1320 ...	679	1324 L,1320 L, 1324 LS ...



Sampa Nr.

011.064

O.E.M. Nr.

673 320 02 50

Dimension

ø36,5xø58,5x48

Description

Rubber Bushing for Spring

BM	MODEL
673	709, 711, 809, 811 ...
674	814, 914 KO, 917 AK ...
675	1114, O 1114
676	817, 917, O 1117 ...
677	1120 AF,1124 AF, O 1120 ...
678	914, 1114 A, 1117 A
697	O 301, O 402



Sampa Nr.

011.065

O.E.M. Nr.

673 320 01 50

Dimension

ø36xø58x96

Description

Rubber Bushing for Spring

BM	MODEL	675	O 1114, 1114 ...
673	709,711,809...	676	817,917,1117,O817 ...
674	814,914 KO,O814...	677	1120,1124,O1120 ...



Sampa Nr.

011.068

O.E.M. Nr.

670 320 03 44

Dimension

ø36xø58x86,5

Description

Rubber Bushing for Spring

BM	MODEL
669	Vario
670	809 D, 811 D/DK, 814 D/DA



Sampa Nr.

010.069

O.E.M. Nr.

673 324 01 50

Dimension

ø18,8xø36x95

Description

Plastic Bushing for Spring

BM	MODEL	675	O 1114, 1114 ...
673	709, 711, 809 ...	676	817, 917, 1117, O 817 ...
674	814, 914 KO, O 814 ...	677	1120, 1124, O 1120 ...



Sampa Nr.

011.164

O.E.M. Nr.

675 325 01 44

Dimension

M6/70,5x94x18,5

Description

Spring Buffer

BM	MODEL
375,970,972,975,976	ATEGO
675	1314 AK,1317 AK,1514 /K
676	1317 AK,1320 AK, 1517 K ...
677	1120 AF,1124 AF, 1520 ...
679	15,241,724



Sampa Nr.

011.074

O.E.M. Nr.

673 325 01 44

Dimension

M8/65,5x81x19

Description

Spring Buffer

BM	MODEL	669	709 D, 711 D, VARIO
667	510, 507 D, 508 D/DK	670	809 D, 811 D ...
668	609 D	673	709, 711, 809 ...

Sampa Nr.

010.010

O.E.M. Nr.

319 324 07 50
(319 324 04 50)



Dimension

ø30.5xø42.5x41

Description

Rubber Bushing for Spring

BM	MODEL
308	L/LO 608 D, LO 708 D/E, L 608 E, 708 E
309	L 407 D, LF 408 G, LKO 508 DG, O 309 B/D ...
310	LF 508, 608 D, L 608 D, LK 608 D, LT 608 D, O 309 D
313	L 613 D, O 309 D
378	L 608 D, L 608 E, LC 608 D, LFU 608 D

Sampa Nr.

011.043

O.E.M. Nr.

319 324 04 50
(319 324 07 50)



Dimension

ø30xø42x40

Description

Rubber Bushing for Spring

BM	MODEL
308	L/LO 608 D, LO 708 D/E ...
309	L 406 DG, L 407 D, L 408 G ...
310	LT 608 D, L 608 D, LK 608 D ...
313	O 309 D, L 613 D
378	LO 608 D, LFU 608 D, L 608 E

Sampa Nr.

011.044

O.E.M. Nr.

318 322 02 50
(667 322 03 50)



Dimension

ø29.5xø42x46

Description

Rubber Bushing for Spring

BM	MODEL
314	LP/LPK/LPKF 608,709 ...
316	LP/LPK/LPKF/LPO/LPL 808,809
318	LP 811,813, 1013, 1113 ...
371	O 814 R/S
398	LO 814
667	510, 507 D, 508 D, 507 D, 508 DK
668	609 D

Sampa Nr.

011.123

O.E.M. Nr.

667 322 06 50



Dimension

ø30xø42x43.5

Description

Rubber Bushing for Spring

BM	MODEL
669	VARIO
688	709, 712 K, 912
688	LO 809,812

Sampa Nr.

011.075

O.E.M. Nr.

673 325 02 84



Dimension

65x80.5x13

Description

Spring Buffer

BM	MODEL
673	709, 711, 809 ...
674	814 /S, 914 KO, 917 AK ...
675	1114, 1314, 1317 ...
676	1117, 1317, O 817 L ...
677	1120, 1320, 1720 ...
679	1320 L, 1324, 1824 ...

Sampa Nr.

011.076

O.E.M. Nr.

601 321 00 62



Dimension

50x70x15

Description

Spring Buffer

BM	MODEL
601	208, 210, 207 D, 208 D, 209 D, 210 D
602	307 D, 308D, 309 D, 310 D
611	410, 407 D, 408 D, 409 D, 410 D

Spring Suspension



Sampa Nr.

011.140

O.E.M. Nr.

667 325 00 84

Dimension

55x80.5x14

Description

Spring Buffer

BM	MODEL
667	510, 507 D, 508 D/DK
668	609 D
669	709 D, 711 D, VARIO
670	809 D/DT, 811 D/DA/DK, 814 D
690	310 D, 311 CDI, 312 D, 313 CDI
903/904	SPRINTER



Sampa Nr.

011.141

O.E.M. Nr.

674 325 02 44

Dimension

55.5x75x21.5

Description

Spring Buffer

BM	MODEL
673	709, 711, 809 ...
674	814 /L, 914 / K, O 814...
675	1314 /L/K, 1317 K ...
676	1117 /A/AK/K/L/LO/LS/S, 1317 AK ...
677	1120 AF/LS ,1124 AF ...
679	1320 /L, 1324 L, 1324 S/LS, 1824 L



Sampa Nr.

011.147

O.E.M. Nr.

674 325 03 44

Dimension

75.5x85.5x33

Description

Spring Buffer

BM	MODEL
382	OH 1421 L,1621 L, 1623 LG ...
390	OHL 1316,1420
397	OH 1835L/30
398	OH 1636 L
673	709 /K, 711, 809 /K, 811 /K
674	814 /F, 914 KO ...
675	1114, 1314 L, 1317 K



Sampa Nr.

011.165

O.E.M. Nr.

**675 325 02 84
(970 325 01 84)**

Dimension

70x90x18.5

Description

Spring Buffer

BM	MODEL	BM	MODEL
669	Vario	679	1315, 524/L,1724 /L
675	1514 /K, 1517 /K/L	958,970,970,	ATEGO
676	1517 /L/K	972,974,975,976	ATEGO
677	152,015,241,720		



Sampa Nr.

011.247

O.E.M. Nr.

943 323 51 84

Dimension

84.5x110.5x22

Description

Spring Buffer

BM	MODEL
950	ACTROS
950	AXOR



Sampa Nr.

011.248

O.E.M. Nr.

675 325 05 84

Dimension

76x121x19

Description

Spring Buffer

BM	MODEL
375,958,970,972,975	ATEGO
675	1514 /K/L
676	1517 /K/L
677	1520 /L,1524,1720, 2020 L
679	1524 /L,1724, 2024 L

Sampa Nr.

011.249

O.E.M. Nr.

901 325 00 84



Dimension

59.5x89.5x7.5

Description

Spring Buffer

BM	MODEL
730	VL 0/7 CE - 1,6 ...
732	VL 0/10 CE-1.6 ...

Sampa Nr.

011.250

O.E.M. Nr.

943 323 53 84



Dimension

84.5x110.5x18.5

Description

Spring Buffer

BM	MODEL
374,375,940,942	AXOR 1828
930,934,950,954	ACTROS 1831 - 1848
943,944,950,954,958	AXOR 2635 B - 2643 B

Sampa Nr.

011.251

O.E.M. Nr.

943 323 84 84



Dimension

84.5x115x23

Description

Spring Buffer

BM	MODEL
374,375,940,942	AXOR
943,944,950,954,958	AXOR
930,934,950,954	ACTROS

Sampa Nr.

011.220

O.E.M. Nr.

901 322 12 19



Dimension

65.5x100.5x40

Description

Spring Buffer

BM	MODEL
901,902,903,904	SPRINTER

Sampa Nr.

011.221

O.E.M. Nr.

901 322 00 19



Dimension

65.5x100.5x32

Description

Spring Buffer

BM	MODEL
730	VL 0/7 CE - 1,6 ...
732	VL 0/13 CE-1.6 ...
901,902,903,904	Sprinter

Sampa Nr.

011.222

O.E.M. Nr.

901 322 04 19



Dimension

45.5x100.5x29.5

Description

Spring Buffer

BM	MODEL
730	VL 1/13 CE-2,1 ...
732	VL 0/13 CE-1.6 ...
901,902,903,904	Sprinter

Spring Suspension



Sampa Nr.

011.193

O.E.M. Nr.

**000 325 05 96
(000 325 07 96)**

Dimension

h:152

Description

Spring Cushion

BM	MODEL
374,942,943,952,953,000	AXOR
930,932,933,934	ACTROS
950,952,953,954	ACTROS
950	ATEGO



Sampa Nr.

011.021

O.E.M. Nr.

309 320 01 77

Dimension

ø66x119

Description

Spring Buffer

BM	MODEL
308	L/LO 608 D, LO 708 D/E ...
309	L 406 DGL, L 407 D, L 408 DG ...
310	L 608 D, LF 508 D, LF 608 D ...
313	O 309 D, L 613 D
371	O 814 R/S
378	L 608 D/E, LO 608 D, LFU 608 D



Sampa Nr.

011.180

O.E.M. Nr.

**000 325 08 96
(000 325 06 96)**

Dimension

h:119

Description

Spring Cushion

BM	MODEL
374,375,942,943	AXOR
950,952,953,958	AXOR
930,932,933,934	ACTROS
950,952,953,954	ACTROS



Sampa Nr.

011.136

O.E.M. Nr.

**667 320 00 77
(309 320 02 77)**

Dimension

ø92x110

Description

Spring Buffer

BM	MODEL
308	L/LO 608 D ...
309	O 309 B, L/LK 508 DG
310	LF 508 D, 608 D ...
313	O 309 D, L 613 D
371	O 814 R/S
378	L 608 D, LO 608 D, LFU 608 D, L 608 E



Sampa Nr.

011.209

O.E.M. Nr.

000 325 04 96

Dimension

h:132

Description

Spring Cushion

BM	MODEL
950,953,954	ACTROS



Sampa Nr.

011.156

O.E.M. Nr.

385 320 00 77

Dimension

ø66x86.5

Description

Spring Buffer

BM	MODEL
371	1821 AK/4X4/36
380	1013 A/AK, 1017 A/AS/AF, 1019 AF
381	1213 A, 1217 A, 1219 A ...
383	1413 A, 1417 A, 1419 AK ...
385	1619 /A/AK, 1617 AK
615	1222 A,AS, 1214 A, 1217 CA...
616	1417 CA/CAK

Sampa Nr.

100.068

O.E.M. Nr.

383 324 00 08



Dimension

ø62.5x85.5

Description

Spring Buffer

BM	385	620	647	655	695
345	390	621	648	656	699
376	397	622	650	657	
380	615	623	651	658	
381	616	625	652	682	
382	617	645	653	684	
383	619	646	654	693	

Sampa Nr.

011.101

O.E.M. Nr.

673 324 04 08



Dimension

68x88x85

Description

Spring Buffer

BM	MODEL
673	709, 711, 809, 811 ...
674	814 /F/K/KO, 914 KO ...
675	1114, 1314/L, 1514 ...
676	1117 /K/L/LO/LS, 1317 K,1320 K ...
677	1320, 1520, 1524, 1117 L ...
678	914, 1114/A, 1117/A
679	1524,1724,1324 /S ...
958/970/972/976	ATEGO

Sampa Nr.

011.102

O.E.M. Nr.

675 324 00 08



Dimension

68x88x85

Description

Spring Buffer

BM	MODEL
674	914 AK, 917 AK
675	1114 AK,1317 AK,1314 AK
676	1117 A,1117 AK, 1317 AK ...
677	1120 AF,1124 AF
678	1114 A/AK, 1117 A
375 958/970/972/974/975/976	ATEGO

Sampa Nr.

011.103

O.E.M. Nr.

901 325 07 44



Dimension

70x80x41

Description

Spring Buffer

BM	MODEL
690/902/903/904	SPRINTER

Sampa Nr.

011.104

O.E.M. Nr.

901 322 25 19



Dimension

42x134x94.5

Description

Spring Buffer

BM	MODEL
730	VL 0/6 CE - 1,6/RS 3550
730	VL 0/7 CE - 1,6
730	VL 0/6 CE - 1.6/RS 3000

Sampa Nr.

011.105

O.E.M. Nr.

901 322 06 19



Dimension

45.5x134.5x94.5

Description

Spring Buffer

BM	MODEL	730	VL 0/15 CE-1,75
730	VL 1/13 CE-2,1	730	VL 0/6 CE - 1,6/RS 3000
730	VL 0/10 CE-1,6	732	VL 0/6 CE -1,6/RS 3550
730	VL 0/11 CE-1,75	732	VL 0/8 CE -1,75
730	VL 0/12 CE-1,75		
730	VL 0/13 CE-1,6		
730	VL 0/14 CE-1,75		

Spring Suspension



Sampa Nr.

011.173

O.E.M. Nr.

901 322 16 19

Dimension

45.5x134.5x94.5

Description

Spring Buffer

BM	MODEL
730	VL 0/6 CE - 1,6/RS3000
730	VL 0/6 CE - 1,6/RS3550



Sampa Nr.

100.021

O.E.M. Nr.

**625 325 03 19
(624 325 11 19)**

Dimension

173x223x202

Description

Spring Bracket, Right

BM	MODEL	658	2429 K, 2538 /K/LK 3028 /K
371	2624 K, 2627 K ...	740	HL 7/015D(S)-13 ...
388	L 2635/6X4/54 ...	741	HD 4/04 DG-10, HL 4/05
397	2545 S/6X4 ...	958	AXOR
398	2629 /6X4, 2629 /AK 6X6		
625	3025 /K, 3028 /K ...		
648	2235 K		



Sampa Nr.

100.069

O.E.M. Nr.

395 321 00 40

Dimension

75x90x93

Description

Spring Bracket

BM	615	623	649	656
343	616	624	650	657
346	617	625	651	658
371	619	645	652	659
388	620	646	653	699
397	621	647	654	
398	622	648	655	



Sampa Nr.

100.022

O.E.M. Nr.

**625 325 02 19
(624 325 10 19)**

Dimension

173x223x202

Description

Spring Bracket, Left

BM	MODEL	658	2429 K, 2538 /K/LK 3028 /K
371	2624 K, 2627 K ...	740	HL 7/015D(S)-13 ...
388	L 2635/6X4/54 ...	741	HD 4/04 DG-10, HL 4/05
397	2545 S/6X4 ...	958	AXOR
398	2629 /6X4, 2629 /AK 6X6		
625	3025 /K, 3028 /K ...		
648	2235 K		



Sampa Nr.

100.049

O.E.M. Nr.

**659 990 00 01
(395 990 02 01)**

Dimension

M20x1.5/210

Description

Spring Pin

BM	MODEL	624	2628 B, 2636/L,3336/K ...
371	2624K, 2627K, 3027 ...	625	3028/K,3228/K/L,3235/K ...
388	L 2635/6X4/54 ...	648	2235, 3035, 3235, 3335/K ...
393	2226 S/6X4 ...	649	2644 S/LS, 3344, 3544 ...
395	2626 /S/K/AS/AK/AB, 3332	658	2429, 2435, 2544 ...
397	2637 S/6X4 ...	659	2638/L, 2644/L, 2650 ...
398	2629/6X4 ...	740	HD 7/016DGS-13 ...
623	2228/L, 3028 B/K ...		

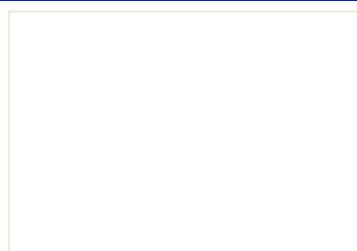

Sampa Nr.

O.E.M. Nr.

Dimension

Description

Sampa Nr.

101.212

O.E.M. Nr.

370 322 00 30
(395 322 03 30)



Dimension

ø25x140

Description

Spring Pin

BM	MODEL
336	LP 1924 / LPS 1924
343	L 2624/6X4 ...
346	L 1924 ...
349	L/LK/LS 1621,1624
350	LS 1924,1924A,1929,1930
363	LP 2226/6X4 ...

Sampa Nr.

101.203

O.E.M. Nr.

314 322 02 30



Dimension

ø20x127

Description

Spring Pin

BM	MODEL	316	LP 808,809
314	LP 608,709	316	LPK 808,809
314	LPS 608,709	316	LPKF 808,809
314	LPK 608,709	316	LPO 808,809
314	LPKO 608,709	318	LP 811,813
314	LPO 608,709	318	LP 913
314	LPKF 608,709	318	LPO 811,813
314	LPO 608,709	318	LPK 811,813

Sampa Nr.

116.011

O.E.M. Nr.

385 322 00 50
(352 322 00 50)
(312 324 10 50)
(312 324 12 50)



Dimension

ø25xø30x67

Description

Spring Bushing

BM	MODEL	380, 381	1013 ... / 1213 ...
312,314	L 312 ... / LPKF 608 ...	382, 383	OH 1315 ... / 1419 ...
328, 341	L 328 ... / L 1112 ...	384, 385	L 1215 ... / 1613 ...
344, 345	LK 1118 ... / L 1313 ...	386, 390	L 1614 ... / OH 1315 ...
351, 352	L 1514 ... / L 1313 ...	392, 394	L 1215 ... / L 1619 ...
353, 358	L 911 B ... / LF 1113 B ...	397, 398	1419 ... / OH 1318 ...
360, 368	L 1513 ... / OH 1519 ...	615, 616	1222 ... / 1417 C ...
371, 376	2521 ... / L 1013 ...		

Sampa Nr.

116.001

O.E.M. Nr.

314 321 00 50



Dimension

ø20xø25x67

Description

Spring Bushing

BM	MODEL	316	LPK 808,809
314	LP 608,709	316	LPKF 808,809
314	LPS 608,709	316	LPO 808,809
314	LPK 608,709	318	LP 811,813,913
314	LPKO 608,709	318	LPO 811,813
314	LPKF 608,709	318	LPS 811,813, 913
314	LPO 608,709	318	LPK 811,813,913
316	LP 808,809		

Sampa Nr.

010.601

O.E.M. Nr.

619 320 00 65



Dimension

ø25x140

Description

Spring Pin Set

BM	MODEL
385	2219/6X2/4
619	2220, 2222, 2225 ...
625	3025 /K, 3028 /B/K ...

Sampa Nr.

010.602

O.E.M. Nr.

314 320 03 65
(314 586 04 32)
(314 586 01 32)



Dimension

ø20x127

Description

Spring Pin Set

BM	MODEL
314	LP 608,709 ...
316	LP 808,809 ...
318	LP 811, 813 ...

Spring Suspension



Sampa Nr.

101.220

O.E.M. Nr.

322 322 00 30

Dimension

ø25x112

Description

Spring Pin

BM	MODEL	341	L 1112,1114
328	L 328,911	341	L 911
328	LS 328,911	341	LA 1112,1114
328	LK 328,911	341	LK 1114
328	LKO 328,911	341	LO 911, 914, 1112
328	LF 328	341	LS 1112,1114
328	LK 911	341	



Sampa Nr.

101.221

O.E.M. Nr.

354 322 00 30

Dimension

ø25x117

Description

Spring Pin

BM	MODEL	
338	L 1418	
338	LK 1418	
338	LP 1418	
338	LPS 1418	
338	LS 1418	



Sampa Nr.

116.018

O.E.M. Nr.

**353 322 00 50
(385 322 01 50)**

Dimension

ø25xø30x57

Description

Spring Bushing

BM	MODEL	
328	L 328,911 ...	
341	LO 911, L 911 ...	
344	LA 1113 / LAS 1113 / LAK 1113	
353	L 911 B / LA 911 B / LAF 911 B ...	
358	L 1113 B / LK 1113 B / LS 1113 B ...	



Sampa Nr.

116.011

O.E.M. Nr.

**385 322 00 50
(352 322 00 50)
(312 324 10 50)
(312 324 12 50)**

Dimension

ø25xø30x67

Description

Spring Bushing

BM	MODEL	382, 383	OH 1315 ... / 1419 ...
312,314	L 312 ... / LPKF 608 ...	384, 385	L 1215 ... / 1613 ...
328, 341	L 328 ... / L 1112 ...	386, 390	L 1614 ... / OH 1315 ...
344, 345	LK 1118 ... / L 1313 ...	392, 394	L 1215 ... / L 1619 ...
351, 352	L 1514 ... / L 1313 ...	397, 398	1419 ... / OH 1318 ...
353, 358	L 911 B ... / LF 1113 B ...	615, 616	1222 ... / 1417 C ...
360, 368	L 1513 ... / OH 1519 ...	617, 619	1614 ... / 2219 C ...
371, 376	2521 ... / L 1013 ...		



Sampa Nr.

010.603

O.E.M. Nr.

322 320 00 65

Dimension

ø25x112

Description

Spring Pin Set

BM	MODEL	
328	L 328,911, LS 328,911	
328	LK 328,911, LF 328	
328	LKO 328,911	



Sampa Nr.

010.604

O.E.M. Nr.

**338 320 01 65
(338 586 02 32)
(338 586 00 32)**

Dimension

ø25x117

Description

Spring Pin Set

BM	MODEL	
338	L 1418	
338	LK 1418	
338	LP 1418	
338	LPS 1418	
338	LS 1418	

Sampa Nr.

101.222

O.E.M. Nr.

340 322 01 30



Dimension

ø25x122

Description

Spring Pin

BM	MODEL
312	L 312
314	LP 608,709 ...
328	L 328,911...
341	L 1112 ...

Sampa Nr.

101.206

O.E.M. Nr.

385 322 00 30
(352 322 05 30)
(352 322 04 30)



Dimension

ø25x126

Description

Spring Pin

BM	MODEL	360	LA 1513
360	L 1513 ...	360	LAK 1513
341	L 911 ...	360	LAKO 1513
344	L 1113 ...	376	L 1013 ...
345	L 1313 ...	376	LS 1418
351	L 1514 ...	380	1013 ...
352	L 1313 ...	381	1213 ...
353	L 911 B ...	383	1413 ...
358	LS 1113 B / LA ...	385	1613 ...
360	LK 1513		

Sampa Nr.

116.011

O.E.M. Nr.

385 322 00 50
(352 322 00 50)
(312 324 10 50)
(312 324 12 50)



Dimension

ø25xø30x67

Description

Spring Bushing

BM	MODEL	386, 390	L 1614 ... / OH 1315 ...
312,314	L 312 ... / LPKF 608 ...	392, 394	L 1215 ... / L 1619 ...
328, 341	L 328 ... / L 1112 ...	397, 398	1419 ... / OH 1318 ...
344, 345	LK 1118 ... / L 1313 ...	615, 616	1222 ... / 1417 C ...
351, 352	L 1514 ... / L 1313 ...	617, 619	1614 ... / 2219 C ...
353, 358	L 911 B ... / LF 1113 B ...		
360, 368	L 1513 ... / OH 1519 ...		
371, 376	2521 ... / L 1013 ...		
380, 381	1013 ... / 1213 ...		
382, 383	OH 1315 ... / 1419 ...		
384, 385	L 1215 ... / 1613 ...		

Sampa Nr.

116.018

O.E.M. Nr.

353 322 00 50
(385 322 01 50)



Dimension

ø25xø30x57

Description

Spring Bushing

BM	MODEL
328	L 328,911 ...
341	LO 911, L 911 ...
344	LA 1113 / LAS 1113 / LAK 1113
353	L 911 B / LA 911 B / LAF 911 B ...
358	L 1113 B / LK 1113 B / LS 1113 B ...

Sampa Nr.

010.605

O.E.M. Nr.

340 320 03 64



Dimension

ø25x122

Description

Spring Pin Set

BM	MODEL
314	LP 608,709 ...
328	L 328,911, LF 328 ...
338	L 1418, LK 1418 ...
684	508 I

Sampa Nr.

010.606

O.E.M. Nr.

358 320 00 65
(358 586 00 32)



Dimension

ø25x126

Description

Spring Pin Set

BM	MODEL
353	L 911 B, LA 311 B ...
358	L 1113 B, LA 1113 B ...

Spring Suspension



Sampa Nr.

101.206

O.E.M. Nr.

385 322 00 30
(352 322 05 30)
(352 322 04 30)

Dimension

ø25x126

Description

Spring Pin

BM	MODEL	353	L 911 B ...
345	L 1418 ...	358	LS 1113 B / LA ...
360	L 1513 ...	360	LK 1513
341	L 911 ...	360	LA 1513
344	L 1113 ...	360	LAK 1513
345	L 1313 ...	360	LAKO 1513
351	L 1514 ...	376	LS 1418
352	L 1313 ...		



Sampa Nr.

101.212

O.E.M. Nr.

370 322 00 30
(395 322 03 30)

Dimension

ø25x140

Description

Spring Pin

BM	MODEL	389	1919 S ...
336	LP 1924 / LPS 1924	391	2026 S/6X2/4, 2032 S/6X2/4
343	L 2624/6X4 ...	393	2226 ...
349	L/LK/LS 1621,1624	395	2626 S ...
350	LS 1924,1924A,1929,1930	623	2228,2628,3028 ...
363	LP 2226/6X4 ...	660	L 1929,1935 / LS 1929,1935
387	1626 AK ...	696	L 1938 ...
388	L 1929 ...		



Sampa Nr.

116.011

O.E.M. Nr.

385 322 00 50
(352 322 00 50)
(312 324 10 50)
(312 324 12 50)

Dimension

ø25xø30x67

Description

Spring Bushing

BM	MODEL	382, 383	OH 1315 ... / 1419 ...
312,314	L 312 ... / LPKF 608 ...	384, 385	L 1215 ... / 1613 ...
328, 341	L 328 ... / L 1112 ...	386, 390	L 1614 ... / OH 1315 ...
344, 345	LK 1118 ... / L 1313 ...	392, 394	L 1215 ... / L 1619 ...
351, 352	L 1514 ... / L 1313 ...	397, 398	1419 ... / OH 1318 ...
353, 358	L 911 B ... / LF 1113 B ...	615, 616	1222 ... / 1417 C ...
360, 368	L 1513 ... / OH 1519 ...	617, 619	1614 ... / 2219 C ...
371, 376	2521 ... / L 1013 ...	625, 682	3025/K ... / 1215 ...
380, 381	1013 ... / 1213 ...	684, 685	508 I ... / OF 1318 ...



Sampa Nr.

116.002

O.E.M. Nr.

370 322 00 50
(304 321 01 50)
(304 321 00 50)
(347 321 00 50)
(620 321 00 50)

Dimension

ø25xø30x81

Description

Spring Bushing

BM	387	620	629	637	645	657
336	388	621	630	638	625	658
343	389	622	631	639	646	659
346	391	623	632	640	647	660
349	393	624	633	641	648	696
350	395	626	634	642	649	699
363	397	627	635	643	655	
371	398	628	636	644	656	



Sampa Nr.

010.607

O.E.M. Nr.

385 320 01 65
(385 586 03 32)

Dimension

ø25x126

Description

Spring Pin Set

BM	MODEL
352	L/LK/LKO 1313, OF 1413 ...
353	LP 810,911 B
358	LF/LKO/LA 1113 B, OF 1113 ...
360	L/LK/LKO 1513 ...
380	1013, 1017, 1019 ...
381	1213, 1217, 1219 ...
383	917, 1413, 1417 ...



Sampa Nr.

010.611

O.E.M. Nr.

395 320 02 65
(395 586 02 32)

Dimension

ø25x140

Description

Spring Pin Set

BM	388	621	648
371	389	622	649
336	391	623	655
343	393	624	656
346	395	625	657
349	397	645	658
363	398	646	659
387	620	647	660

Sampa Nr.

101.207

O.E.M. Nr.

314 325 00 30
(370 322 01 30)
(395 322 04 30)



Dimension

ø25x140.5

Description

Spring Pin

BM	MODEL	389	1919 ...
314	LP 608,709 ...	391	2026 S/6X2/4, 2032 S/6X2/4
316	LP 808,809 ...	393	2226 S/6X4 ...
318	LP 1013 ...	395	2626,2632,3332 ...
371	1928 S ...	623	2228,2236, 2628,3028 ...
387	162 6 AK ...	660	L 1929, 1935 / LS 1929,1935
388	L 1929 ...		

Sampa Nr.

116.002

O.E.M. Nr.

370 322 00 50
(304 321 01 50)
(304 321 00 50)
(347 321 00 50)
(620 321 00 50)



Dimension

ø25xø30x81

Description

Spring Bushing

BM	389	624	635	645	659
336	391	626	636	625	660
343	393	627	637	646	696
346	395	628	638	647	699
349	397	629	639	648	
350	398	630	640	649	
363	620	631	641	655	
371	621	632	642	656	
387	622	633	643	657	
388	623	634	644	658	

Sampa Nr.

010.612

O.E.M. Nr.

395 320 01 65
(395 586 03 32)



Dimension

ø25x140.5

Description

Spring Pin Set

BM	391	620	645	656	699
371	393	621	646	658	
387	395	623	648	659	
388	397	624	649	660	
389	398	625	655	684	

Sampa Nr.

101.225

O.E.M. Nr.

354 325 00 30



Dimension

ø30x128

Description

Spring Pin

BM	MODEL
338	L 1418
338	LK 1418
338	LP 1418
338	LPS 1418
338	LS 1418

Sampa Nr.

116.003

O.E.M. Nr.

352 325 01 50
(396 325 00 50)
(327 325 50 50)
(385 325 00 50)



Dimension

ø30xø35x77

Description

Spring Bushing

BM	355	381	394	619	682
338	358	383	396	622	684
341	360	384	397	625	685
344	368	385	398	647	693
345	371	386	615	652	694
352	376	390	616	653	695
353	380	392	617	657	

Sampa Nr.

010.616

O.E.M. Nr.

338 320 02 65
(338 586 03 32)
(338 586 01 32)



Dimension

ø30x128

Description

Spring Pin Set

BM	MODEL
338	L 1418
338	LK 1418
338	LP 1418
338	LPS 1418
338	LS 1418

Spring Suspension



Sampa Nr.

101.207

O.E.M. Nr.

314 325 00 30
(370 322 01 30)
(395 322 04 30)

Dimension

ø25x140.5

Description

Spring Pin

BM	MODEL	389	1919 ...
314	LP 608,709 ...	391	2026 S/6X2/4, 2032
316	LP 808,809 ...	S/6X2/4	
318	LP 1013 ...	393	2226 S/6X4 ...
371	1928 S ...	395	2626,2632,3332 ...
387	162 6 AK ...	623	2228,2236, 2628,3028 ...
388	L 1929 ...	660	L 1929, 1935 /LS



Sampa Nr.

101.204

O.E.M. Nr.

304 322 04 30

Dimension

ø25x160

Description

Spring Pin

BM	MODEL	343	LK 2624/6X4
343	L 2624/6X4	343	LS 2624/6X4
343	LA 2624/6X6		
343	LAB 2624/6X6		
343	LAK 2624/6X6		
343	LAS 2624/6X6		
343	LB 2624/6X4		



Sampa Nr.

116.011

O.E.M. Nr.

385 322 00 50
(352 322 00 50)
(312 324 10 50)
(312 324 12 50)

Dimension

ø25xø30x67

Description

Spring Bushing

BM	MODEL	380, 381	1013 .../1213 ...
312,314	L 312 .../LPKF 608 ...	382, 383	OH 1315 .../1419 ...
328, 341	L 328 .../L 1112 ...	384, 385	L 1215 .../1613 ...
344, 345	LK 1118 .../L 1313 ...	386, 390	L 1614 .../OH 1315 ...
351, 352	L 1514 .../L 1313 ...	392, 394	L 1215 .../L 1619 ...
353, 358	L 911 B .../LF 1113 B ...	397, 398	1419 .../OH 1318 ...
360, 368	L 1513 .../OH 1519 ...	615, 616	1222 .../1417 C ...
371, 376	2521 .../L 1013 ...	617, 619	1614 .../2219 C ...



Sampa Nr.

116.002

O.E.M. Nr.

370 322 00 50
(304 321 01 50)
(304 321 00 50)
(347 321 00 50)
(620 321 00 50)

Dimension

ø25xø30x81

Description

Spring Bushing

BM	387	620	629	637	645	657
336	388	621	630	638	625	658
343	389	622	631	639	646	659
346	391	623	632	640	647	660
349	393	624	633	641	648	696
350	395	626	634	642	649	699
363	397	627	635	643	655	
371	398	628	636	644	656	



Sampa Nr.

010.613

O.E.M. Nr.

625 320 00 65

Dimension

ø25x140.5

Description

Spring Pin Set

BM	MODEL	625	3233 /B
625	3025	625	3235 /K
625	3028	625	3328 /K
625	3328	625	3528 /B/K
625	3025 /K	625	3535 /B/K
625	3028 /K/B		
625	3228 /B/K/L		



Sampa Nr.

010.615

O.E.M. Nr.

329 320 00 65
(329 586 00 32)

Dimension

M24x1.5/ø25x160

Description

Spring Pin Set

BM	MODEL	343	LK 2624/6X4
343	L 2624/6X4	343	LS 2624/6X4
343	LA 2624/6X6		
343	LAB 2624/6X6		
343	LAK 2624/6X6		
343	LAS 2624/6X6		
343	LB 2624/6X4		

Sampa Nr.

101.207

O.E.M. Nr.

314 325 00 30
(370 322 01 30)
(395 322 04 30)



Dimension

ø25x140.5

Description

Spring Pin

BM	MODEL	389	1919 ...
314	LP 608,709 ...	391	2026 S/6X2/4, 2032
316	LP 808,809 ...	S/6X2/4	
318	LP 1013 ...	393	2226 S/6X4 ...
371	1928 S ...	395	2626,2632,3332 ...
387	162 6 AK ...	623	2228,2236, 2628,3028 ...
388	L 1929 ...	660	L 1929, 1935 / LS

Sampa Nr.

116.007

O.E.M. Nr.

316 324 03 50
(316 324 00 50)



Dimension

ø25xø30x77

Description

Spring Bushing

BM	MODEL
313	LPS 913
314	LP 608,709 / LPS 608,709
314	LPK 608,709 / LPKO 608,709
314	LPKF 608,709 / LPO 608,709
314	LPL 608,709 / LPLS 608,709
316	LP 808, 809, 913
316	LPK 808,809 / LPKF 808,809
316	LPO 808,809 / LPL 808,809
318	LP 1013,1113 / LPK 1013,1113,913

Sampa Nr.

010.614

O.E.M. Nr.

314 320 00 65
(314 586 05 32)



Dimension

ø25x140.5

Description

Spring Pin Set

BM	MODEL
314	LP 60 S, LPC 608,709 ...
316	LP 808,809 / LPK 808,809 ...
318	LP 811, 813,1013,1113
625	3235 /AK/K, 3238 ...

Sampa Nr.

101.216

O.E.M. Nr.

361 325 00 30



Dimension

ø30x131.5

Description

Spring Pin

BM	MODEL	363	LPK 2232/6X4
363	LP 2226/6X4	363	LPS 2226/6X4
363	LP 2232/6X4	363	LPS 2232/6X4
363	LPB 2226/6X4		
363	LPK 2226/6X4		

Sampa Nr.

116.019

O.E.M. Nr.

361 325 11 50



Dimension

ø30xø35x71

Description

Spring Bushing

BM	MODEL	363	LPK 2226/6X4
363	LP 2232/6X4	363	LPK 2232/6X4
363	LP 2226/6X4	363	LPS 2226/6X4
363	LP 2226/6X4	363	LPS 2232/6X4
363	LP 2232/6X4		
363	LPB 2226/6X4		
363	LPK 2232/6X4		

Sampa Nr.

010.617

O.E.M. Nr.

361 320 00 65



Dimension

ø30x131.5

Description

Spring Pin Set

BM	MODEL
363	LP 2226/6X4
363	LP 2232/6X4
363	LPB 2226/6X4
363	LPK 2226/6X4
363	LPK 2232/6X4
363	LPS 2226/6X4
363	LPS 2232/6X4

Spring Suspension



Sampa Nr.

101.205

O.E.M. Nr.

352 325 05 30
(385 325 00 30)
(352 325 04 30)

Dimension

ø30x136

Description

Spring Pin

BM	MODEL	355	OF 1617,1621
360	L 1513 ...	358	L 1113 B ...
341	L 1112 ...	360	LK 1513 ...
344	L 1113 ...	376	L 1013 ...
344	L 1116 ...	380	1013 K ...
345	L 1418 ...	381	1213 A ...
351	L 1521 ...	383	1413 ...
352	LK 1313 ...	385	1613 ...
353	LKO 911 ...		



Sampa Nr.

010.618

O.E.M. Nr.

385 320 00 65
(385 586 02 32)

Dimension

ø30x136

Description

Spring Pin Set

BM	MODEL	383	917, 1413, 1417 ...
352	L 1313, LK 1313 ...	385	1613, 1617, 1619 ...
353	L/LK 911 B, LKO 911 B ...	397	OF 1419,1724 ...
355	OF 1621,1617	615	1222 AF,1225 AF,1425 AF ...
358	L 1113 B, LK 1113 ...	616	1414, 1417, 1422,1425 ...
360	L 1513, LKO 1513 ...	617	1614, 1617,1622,2422 ...
371	1821, 2521, 2524 ...	619	2219, 2220, 2222,2225 ...
380	1013, 1017, 1019 ...	652	1722 L,1733 L,1834 L,
381	1213, 1217, 1219 ...	684	917, 1518, 1521



Sampa Nr.

010.620

O.E.M. Nr.

622 320 00 65
(622 586 00 32)

Dimension

ø30x136

Description

Spring Pin Set

BM	MODEL	647	2035 LS/6X2/4, S/6X2/4
385	2219/6X2/4	652	1722 L, 2534 LL ...
619	2222, 2025 S ...	653	2433 L, 2534 L
622	2028 LS/6X2/4 ...	657	2429 LS/6X2/4 ...
625	2650 /S, 3050 /S ...		



Sampa Nr.

116.003

O.E.M. Nr.

352 325 01 50
(396 325 00 50)
(327 325 50 50)
(385 325 00 50)

Dimension

ø30xø35x77

Description

Spring Bushing

BM	394
338	396
341	397
344	398
345	615
352	616
353	617
355	619
358	622
360	625
368	647
371	652
376	653
380	657
381	682
383	684
384	685
385	693
386	694
390	695
392	



Sampa Nr.

010.619

O.E.M. Nr.

622 320 01 65

Dimension

ø30x136

Description

Spring Pin Set

BM	MODEL
385	2219/6X2/4
619	2025 S, 2219 C ...
622	2028 LS/6X2/4 ...
625	2650 /S, 3050 /S ...
647	2035 LS/6X2/4, S/6X2/4
657	2429 LS/6X2/4 ...

Sampa Nr.

101.210

O.E.M. Nr.

335 325 00 30
(389 325 02 30)



Dimension

ø30x148

Description

Spring Pin

BM	MODEL	388	L 1929 ...
336	LP 1924, LPS 1924	389	1919
346	L 1924 ...	391	2026 S/6X2/4, 2032 S/6X2/4
349	L/LK/LS 1621,1624	393	2226/6X2, 2232/6X2
350	LS 1924A,1929,1930	397	1924...
385	2219/6X2, 2224/6X2	660	L 1929,1935 / LS 1929,1935
387	1626 AK ...		

Sampa Nr.

116.008

O.E.M. Nr.

335 324 03 50
(304 324 00 50)



Dimension

ø30xø36x90

Description

Spring Bushing

BM	MODEL
375 / 940	AXOR
336, 623	LP 1924 / LPS 1924 / 2228, 2628, 3028 ...
346, 349	L 1924 ... / L 1621...
350, 393	LS 1924 A... / 2226/6X2 ...
371, 387	1922 K ... / 1626 AK ...
389, 391	1919 S ... / 2026 S/6X2/4...
397, 398	1924 ... / 192 6/4X2 / 192 6/AK 4X4
620, 621	1628 S ... / 1922, 2222 ...
645, 647	1635 (S), 1644/L ... / 2035 S/6X2/4

Sampa Nr.

010.621

O.E.M. Nr.

389 320 00 65
(389 586 01 32)



Dimension

ø30x148

Description

Spring Pin Set

BM	388	620	647	684
346	389	621	655	699
349	391	623	656	
371	393	645	657	
387	397	646	658	

Sampa Nr.

101.219

O.E.M. Nr.

312 322 18 30



Dimension

ø20x100

Description

Spring Pin

BM	MODEL	314	LPO 608,709
312	L 312	314	LPKF 608,709
314	LP 608,709	314	LPO 608,709
314	LP 608		
314	LPS 608,709		
314	LPK 608,709		
314	LPKO 608,709		

Sampa Nr.

116.017

O.E.M. Nr.

312 321 13 50



Dimension

ø20xø25x56

Description

Spring Bushing

BM	MODEL
312	L 312
314	LP 608,709
314	LPS 608,709
314	LPK 608,709
314	LPKO 608,709
314	LPKF 608,709

Sampa Nr.

010.624

O.E.M. Nr.

314 320 01 65

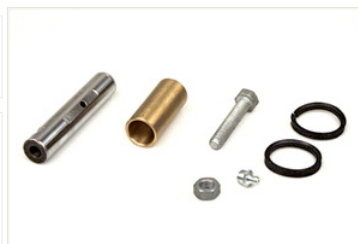

Dimension

ø20x100

Description

Spring Pin Set

BM	MODEL
314	LP 608,709
314	LPS 608,709
314	LPK 608,709
314	LPKO 608,709
314	LPKF 608,709
314	LPO 608,709

Spring Suspension



Sampa Nr.

101.230

O.E.M. Nr.

Dimension

ø30x148

Description

Spring Pin



Sampa Nr.

101.209

O.E.M. Nr.

Dimension

ø30x206

Description

Spring Pin

BM	MODEL
625	3025,3028,3228/B,3233/B
625	3025/K,3028,3228/K



Sampa Nr.

116.008

O.E.M. Nr.

**335 324 03 50
(304 324 00 50)**

Dimension

ø30xø36x90

Description

Spring Bushing

BM	MODEL
375 / 940	AXOR
336, 623	LP 1924 / LPS 1924 / 2228, 2628, 3028 ...
346, 349	L 1924 ... / L 1621...
350, 393	LS 1924 A... / 2226/6X2 ...
371, 387	1922 K ... / 1626 AK ...
389, 391	1919 S ... / 2026 S/6X2/4...
397, 398	1924 ... / 192 6/4X2 / 192 6/AK 4X4
620, 621	1628 S ... / 1922, 2222 ...
645, 647	1635 (S), 1644/L ... / 2035 S/6X2/4



Sampa Nr.

116.012

O.E.M. Nr.

624 322 00 50

Dimension

ø30xø36x25

Description

Spring Bushing

BM	MODEL
625	2650/S,3050 /S,3548 /S, 3550 /S,3553 S/LS
625	3025,3028,3228/B,3233/B
625	3025 /K / 3535 / 3028 B
625	3028/K,3228 /K/L,3235 /K
625	3050, 3053 /A/S, 3550, 3553S
625	3235, 3235K
625	3238, 3244,3250,3253
625	3238/L, 3244,3250,3253
625	3328/K, 3528/B/K, 3535/B/K
625	3534 K / 3538 / 3535 B / 3535 K
625	3535 K,3538 K,3548 K, 4435 K
625	3535 AK,3235 AK,3538 AK 3550 AK
625	3544 /AK/K, 5038 AK,4850,4844,4853
625	3538 AK/K,3544 S/K,3550/K, 4844/K,4850,4853
625	3548 /S, 3550 /S, 3050 S, 3553 LS



Sampa Nr.

010.622

O.E.M. Nr.

648 320 00 65

Dimension

ø30x148

Description

Spring Pin Set

BM	MODEL
623	2228, 2233, 2236 ...
648	2235 /S, 2244, 2635 ...
658	2429, 2435, 2448 ...



Sampa Nr.

010.625

O.E.M. Nr.

**625 320 01 65
(624 320 00 64)**

Dimension

ø30x206

Description

Spring Pin Set

BM	MODEL
625	3028 /B,3250,3253, 3528 /K ...

Sampa Nr.

101.211

O.E.M. Nr.

-



Dimension

ø30x160

Description

Spring Pin

Sampa Nr.

116.008

O.E.M. Nr.

335 324 03 50
(304 324 00 50)



Dimension

ø30xø36x90

Description

Spring Bushing

BM	MODEL
375 / 940	AXOR
336, 623	LP 1924 / LPS 1924 / 2228, 2628, 3028 ...
346, 349	L 1924 ... / L 1621...
350, 393	LS 1924 A.../ 2226/6X2 ...
371, 387	1922 K ... / 1626 AK ...
389, 391	1919 S ... / 2026 S/6X2/4...
397, 398	1924 ... / 192 6/4X2 / 192 6/AK 4X4
620, 621	1628 S ... / 1922, 2222 ...
645, 647	1635 (S), 1644/L ... / 2035 S/6X2/4

Sampa Nr.

010.623

O.E.M. Nr.

658 320 00 65



Dimension

ø30x160

Description

Spring Pin Set

BM	MODEL	645	1635,2435, 2444 ...
346	L 1924, LK 1924	646	1935,1944, 2444 L ...
371	1922 K, 1928 S ...	647	2035 S/6X2/4 ...
388	L 1929, 1935, 1938 ...	648	2235,2635,3335 ...
397	1729 S, 1735 S ...	655	1728,1729,1929,2429 ...
398	1926/AK 4X4	656	1935, 2031, 2435, 2550 ...
620	1628,2228,2428 ...	657	2429 S/6X2/4 ...
621	1928,2228,2428 ...	658	2429, 2435,3235 ...
623	2228,2628,3028 ...		

Sampa Nr.

101.210

O.E.M. Nr.

335 325 00 30
(389 325 02 30)



Dimension

ø30x148

Description

Spring Pin

BM	MODEL	388	L 1929 ...
336	LP 1924, LPS 1924	389	1919 ...
346	L 1924 ...	391	2026 S/6X2/4, 2032 S/6X2/4
349	L/LK/LS 1621,1624	393	2226/6X2, 2232/6X2
350	LS 1924A,1929,1930	397	1924...
385	2219/6X2, 2224/6X2	660	L 1929,1935 / LS-1929,1935
387	1626 AK ...		

Sampa Nr.

116.009

O.E.M. Nr.

335 391 00 50



Dimension

ø30xø40x90

Description

Spring Bushing

BM	MODEL
746	NS 4/10 D - 6
749	MS 4/10 D-6
749	MS 4/10 D-6,7

Sampa Nr.

010.627

O.E.M. Nr.

389 320 01 65
(389 586 02 32)



Dimension

ø30x148

Description

Spring Pin Set

BM	MODEL
385	2219/6X2, 2224/6X2
393	2226/6X2, 2232/6X2
619	2219 C, 2220, 2222, 2225
623	2228, 2233,2236 ...
648	2235, 2244, 2635 ...
658	2435, 2448, 2550 ...

Spring Suspension



Sampa Nr.

101.209

O.E.M. Nr.

-

Dimension

ø30x206

Description

Spring Pin

BM	MODEL
625	3025,3028,3228/B,3233/B
625	3025/K,3028,3228/K



Sampa Nr.

101.210

O.E.M. Nr.

335 325 00 30
(389 325 02 30)

Dimension

ø30x148

Description

Spring Pin

BM	MODEL	389	1919 ...
336	LP 1924 , LPS 1924	391	2026 S/6X2/4, 2032 S/6X2/4
346	L 1924 ...	393	2226/6X2, 2232/6X2
349	L/L/K/LS 1621,1624	397	1924...
350	LS 1924A,1929,1930	660	L 1929,1935 / LS 1929,1935
385	2219/6X2, 2224/6X2		
387	1626 AK...		
388	L 1929 ...		



Sampa Nr.

116.012

O.E.M. Nr.

624 322 00 50

Dimension

ø30xø36x25

Description

Spring Bushing

BM	MODEL
625	2650/S,3050 /S,3548 /S, 3550 /S,3553 S/LS
625	3025,3028,3228/B,3233/B
625	3025 /K / 3535 / 3028 B
625	3028/K,3228 /K/L,3235 /K
625	3050, 3053 /A/S, 3550, 3553S
625	3235, 3235K
625	3238, 3244,3250,3253
625	3238/L, 3244,3250,3253
625	3328/K, 3528/B/K, 3535/B/K
625	3534 K / 3538 / 3535 B / 3535 K
625	3535 K,3538 K,3548 K, 4435 K
625	3535 AK,3235 AK,3538 AK 3550 AK
625	3544 /AK/K, 5038 AK,4850,4844,4853
625	3538 AK/K,3544 S/K,3550/K, 4844/K,4850,4853
625	3548 /S, 3550 /S, 3050 S, 3553 LS



Sampa Nr.

116.010

O.E.M. Nr.

387 324 00 50

Dimension

ø30xø35x90

Description

Spring Bushing

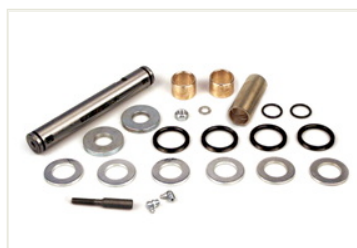

Sampa Nr.

010.626

O.E.M. Nr.

625 320 02 65

Dimension

ø30x206

Description

Spring Pin Set

BM	MODEL	625	3025 /K
625	3025	625	3228 /B/K
625	3028	625	3233 /B



Sampa Nr.

010.628

O.E.M. Nr.

389 320 02 65

Dimension

ø30x148

Description

Spring Pin Set

BM	MODEL
387	1626 AK/AS, 1632 AK/AS, 1719 AK
389	1919 AK, 1926 A/AK, 1932 A/AK ...
621	1627 A, 1628 A, 1922 AK ...
646	1935 AK
655	1835, 1838, 1844 ...
656	1735, 1929 A/AK, 1935 A/AK ...

Sampa Nr.

011.177

O.E.M. Nr.

942 317 22 12

Dimension

ø65x64

Description

Cabin Bushing

BM	MODEL
375,944,950,952,953,000	AXOR
950,952,953,954	ACTROS
693	1938 /S, 1944 S

Sampa Nr.

011.260

O.E.M. Nr.

**930 317 00 12
(942 317 18 12)**

Dimension

ø40x47

Description

Cabin Bushing

BM	MODEL
375,940,942,943,944	AXOR 1823
950,952,953,954,958	AXOR 1823 - 1833
930,932,933,934	ACTROS 1831 - 1848

Sampa Nr.

011.252

O.E.M. Nr.

942 310 00 49

Dimension

ø40xø46.5x31.5

Description

Cabin Bushing

BM	MODEL
950,952,953,954	ACTROS

Sampa Nr.

011.254

O.E.M. Nr.

942 500 00 50

Dimension

ø40xø46.5x31.5

Description

Cabin Bushing

BM	MODEL
375,944	AXOR
950,952,953,954	ACTROS
693	1835 LS - 1843 LS, 2031 K...

Sampa Nr.

011.262

O.E.M. Nr.

000 992 16 03

Dimension

ø16xø69x64

Description

Cabin Bushing

MODEL
AXOR
ACTROS

Sampa Nr.

011.261

O.E.M. Nr.

970 317 03 69

Dimension

ø25.5xø58.5x42

Description

Cabin Bushing

MODEL
ATEGO
UNIMOG
ECONIC

Cabin



Sampa Nr.

011.223

O.E.M. Nr.

942 317 20 12

Dimension

ø25xø100x123.5

Description

Cabin Mounting

BM	MODEL
374,375,940,942,943	AXOR
930,932,934,952,953	ACTROS



Sampa Nr.

011.224

O.E.M. Nr.

940 317 10 12

Dimension

ø25xø100x123.5

Description

Cabin Mounting

BM	MODEL
374,375,940,942,943	AXOR
375.95	ACTROS



Sampa Nr.

011.225

O.E.M. Nr.

940 317 11 12

Dimension

ø25xø100x123.5

Description

Cabin Mounting

BM	MODEL
374,375,940,942,943	AXOR
950,952,953,954,958	AXOR



Sampa Nr.

011.226

O.E.M. Nr.

942 317 21 12

Dimension

ø25xø100x123.5

Description

Cabin Mounting

BM	MODEL
930,932,933,934,950	ACTROS
957	ECONIC



Sampa Nr.

010.064

O.E.M. Nr.

970 317 04 50

Dimension

ø55x69

Description

Cabin Bushing

BM	MODEL
375,958,970,972,974	ATEGO



Sampa Nr.

011.255

O.E.M. Nr.

970 317 01 12

Dimension

ø59.5x70.5

Description

Cabin Bushing

BM	MODEL
375,958,970	ATEGO
972	714 K - 822 K, 1015 K - 1024 K ...
974	1322 LS - 1329 LS
975	917 KO, 1017 KO, 1018 KO ...
976	316 F, 815 F, 1225 F...

Sampa Nr.

011.232

O.E.M. Nr.

674 317 08 12

Dimension

ø25x60/61x57

Description

Cabin Mounting

BM	MODEL
397	1623 S
673	709, 711, 809, 811
674	814 /F/L, 914 AK
675	1114/L,1514,1314 /L, 1514 L
676	817, 917, 1117, 1517 ...
677	1120, 1520,1524,1720 ...
678	1114 A, 1117 A ...

Sampa Nr.

011.211

O.E.M. Nr.

942 317 17 12

Dimension

ø16.5x40

Description

Cabin Mounting

BM	MODEL
950,952,953,954	ACTROS

Sampa Nr.

011.233

O.E.M. Nr.

673 317 01 12

Dimension

ø55x87/88x56

Description

Cabin Mounting

BM	MODEL	678	914, 1114, 1117 ...
397	1623 S, LP 1114,1214 ...	679	1324, 1524,1724 ...
673	709, 711, 809, 811 ...	682	1214 /K, 1215, 1218 ...
674	814 /F, 914 /K, 917 AK	688	914, 712 /C
675	1114, 1314, 1514 ...	693	1214 K, 1215 C, 1618 M ...
676	817 L, 1117 /A, 1320 AK ...		
677	1117 L,1120 L,1121 L ...		

Sampa Nr.

011.083

O.E.M. Nr.

363 891 07 17

Dimension

ø40x33

Description

Buffer for Cabin

BM	387	617	625	652
363	389	619	645	655
371	393	620	646	656
380	395	621	648	658
381	397	622	649	659
383	615	623	650	
385	616	624	651	

Sampa Nr.

011.236

O.E.M. Nr.

674 317 07 12

Dimension

ø25xø80.5x14

Description

Cabin Mounting

BM	MODEL	678	1114 A
397	1623 S	679	1324, 1524, 1724 ...
673	709, 711, 809, 811	699	LU 1920,1921,1924
674	814 /F/L, 914 /AK		
675	1114 /L, 1314/L		
676	1117 A/K/L, 1317 AK ...		
677	1117 L,1120,1121 L ...		

Sampa Nr.

011.166

O.E.M. Nr.

000 890 14 01

Dimension

ø14xø31.5x40

Description

Cabin Bushing

BM	MODEL
374,375,952,958,940	AXOR
375,952,954,930,932	ACTROS

Cabin



Sampa Nr.

010.059

O.E.M. Nr.

668 317 70 55

Dimension

ø20.5xø87x56.5

Description

Cabin Mounting



Sampa Nr.

011.265

O.E.M. Nr.

942 890 29 19
(942 890 01 19)

Dimension

Description

Cabin Shock Absorber, With Air Bellow

MODEL
ACTROS



Sampa Nr.

011.213

O.E.M. Nr.

667 317 00 12

Dimension

ø43.5xø85x45.5

Description

Buffer for Cabin



Sampa Nr.

011.266

O.E.M. Nr.

942 890 02 19
(942 890 60 19)

Dimension

Description

Cabin Shock Absorber, With Air Bellow

MODEL
ACTROS

BM	MODEL
371	O 814 R/S
384	L 1214, 1215,1414 ...
386	L 2314,2318,2418 ...
388	L 1929, 1935, 1938 ...
392	L 1215, LA 1215, LK 1215
660	L 1929, 1935 / LS 1929,1935
667	510, 507 D / 508 D/K
668	609 D
669	709 D, 711 D, Vario
670	809 D/DT, 811 D, 814 D ...
685	914/42, L 1114,1217,1218 ...
688	709, 740, 1114 ...
692	L 710 D, 913 D, LO 813 D
694	L 1218/1318, 1418 ...
695	L 1620, 1625, 1634 ...
696	L 1938, LS 1938 ...



Sampa Nr.

011.267

O.E.M. Nr.

943 890 38 19

Dimension

Description

Cabin Shock Absorber, With Air Bellow

MODEL
ACTROS



Sampa Nr.

011.231

O.E.M. Nr.

667 317 02 36

Dimension

ø18xø78.5x15.5

Description

Buffer for Cabin



Sampa Nr.

011.268

O.E.M. Nr.

942 890 59 19
(942 890 53 19)

Dimension

Description

Cabin Shock Absorber, With Air Bellow

MODEL
ACTROS

BM	MODEL
667	507 D, 508 D, 510, 508 DK
668	609 D
669	709 D, 711 D, Vario
670	809 D/DT, 811 D/DK, 814 D/DA

Sampa Nr.

011.084

O.E.M. Nr.

381 317 15 12



Dimension

ø25x65

Description

Cabin Bushing

BM	MODEL
371	2637 K/6X4/38,5
380	1013 /K/S/KO, 1017 /S/F ...
381	1213, 1217, 1219 ...
383	1413, 1417, 1419, 1424 ...
385	1613, 1617, 1619, 1624 ...
387	1626 LS, 1632 LS, 1919 S ...
389	1919 /S, 1926 /S, 1932 /S ...

Sampa Nr.

011.085

O.E.M. Nr.

381 317 14 12



Dimension

ø46xø87.5x17.5

Description

Cabin Mounting

BM	MODEL
371	2517/6X2/48, 1817 K/4X2/36 ...
380	1013 /S/KO, 1017 /S/LS/F, 1019 F
381	1213 /A/AK, 1217 AF, 1219 ...
383	1413 AS/AKO ...
383	1417 L, 1419 /LS, 1424 ...
385	1613 AKO/L, 1613, 1617 ...
387	1626 / AK/K, 1632 /LS ...

Sampa Nr.

010.580

O.E.M. Nr.

381 586 00 31



Dimension

ø25

Description

Rep. Kit for Cabin

BM	385	397	620	645	651	657
371	387	398	621	646	652	658
376	389	615	622	647	653	659
380	391	616	623	648	654	684
381	393	617	624	649	655	
383	395	619	625	650	656	

Sampa Nr.

011.086

O.E.M. Nr.

381 317 17 12



Dimension

ø25x81

Description

Cabin Bushing

BM	MODEL
371	2517/6X2/48, 2521/6X2/48 ...
380	1013 /KO, 1017 /F/AF, 1019 F/AF
381	1213, 1217 /L, 1219/F/AF
383	1413 /KO, 1417 /KO, 1419 /F/L/F, 1424 F
385	1613 /KO, 1617 /L, 1617 ...
387	1626, 1632, 1719 AK ...
389	1926 A, 1932 A
393	2226/6X4, 2232/6X4 ...

Sampa Nr.

010.658

O.E.M. Nr.

655 890 29 03



Dimension

ø25

Description

Rep. Kit for Cabin

BM	MODEL	654	2531, 2433 S, 2534 S ...
376	LP 1219, 1419 /LPS 1525	655	1728, 1729, 1929, 2429 ...
397	2219 6X4, 2426, 1729 S ...	656	1922, 2422 L, 2429, 2031 ...
398	1926/AK 4X4, 2629/6X4 ...	657	2429 S/6X2/4, 2435 S/6X2/4 ...
625	3229 /B/K, 3233 B, 3234 B/K ...	658	2429, 2435, 2538, 3235 ...
651	1417, 1420, 1422, 1424	959	2638/L, 2644/L, 2650, 2653 ...
652	1717, 1720, 1820, 1824 ...	984	1518 /K, 1521/S/AK, 2421
653	2420, 2422, 2524, 2527 ...		

Sampa Nr.

010.581

O.E.M. Nr.

620 586 00 31



Dimension

ø25

Description

Rep. Kit for Cabin

BM	385	397	620	645	655
371	387	615	621	648	656
380	389	616	623	650	658
381	393	617	624	651	659
383	395	619	625	652	684

Cabin



Sampa Nr.

011.002

O.E.M. Nr.

387 891 02 72

Dimension

ø18xø31.5x27

Description

Cabin Bushing

BM	MODEL
380	1017 AF/F
381	1213, 1217 /L, 1219 /AF/F
383	1413 /KO, 1417 /KO, 1419 /F/L, 1424 F
385	1613 /KO/L, 1617 /KO/L, 1619 /KO ...
387	1626 L, 1632 L, 1719 AK
389	1926 A, 1932 A/AK



Sampa Nr.

011.041

O.E.M. Nr.

180 333 01 65

Dimension

ø22xø91x60

Description

Buffer for Cabin

BM	MODEL	337	L.338
314	LP/LPK 608, 709 ...	338	L.338
316	LP/LPK 808, 809 ...	347	347
318	LP 811, 813, 1013, 1113 ...	349	L 1921, LK 1921
322	L/LA 322	352	352



Sampa Nr.

010.528

O.E.M. Nr.

620 310 01 77

Dimension

ø18

Description

Rep. Kit for Cabin

BM	MODEL
385	1619 /L, 1624 /L
617	1622 /L/LL, 1625 L ...
620	1633 L, 1636 L, 1638 ...
621	1928 / S, 1933, 2433 ...
622	2028, 2033 LS/6X2/4
623	2233, 2433, 2633, 3033 ...



Sampa Nr.

011.042

O.E.M. Nr.

120 333 19 65

Dimension

ø28xø59x23.5

Description

Buffer for Cabin

BM	MODEL	344	344, F 3/1
314	LP/LPS/LPK 608, 709 ...	347	347
316	LP/ LPK, LPKF 808, 809 ...	349	L 1921, LK 1921
318	LP 811, 813, 1013, 1113 ...	350	350
322	L/LA 322	352	352, L/LA/LAS 1313 ...
331	331	353	L/LA/LF 911 B ...
337	L 338	358	L/LA/LAF/ 1113 B ...
338	L 338	376	376
341	341		



Sampa Nr.

010.538

O.E.M. Nr.

**387 586 05 31
(387 891 09 57)
(620 310 00 77)**

Dimension

ø18

Description

Rep. Kit for Cabin

BM	MODEL	395	2632, 3332, 2626 ...
380	1013, 1017 ...	617	1622 /L/L, 1625 /L/LL ...
381	1213, 1217 ...	620	1636, 1628, 1633
383	1413 /KO, 1417 ...	621	1928, 1933, 1938 ...
385	1613 /KO, 1617 /KO...	622	2033 LS/6X2/4, 2028 LS/6X2/4
387	1626/1632 /AK/K/L, 1719 AK	623	2228, 2233, 2238 ...
389	1926 A, 1932 A/AK	624	2633 /6X4, 2638 S 6X4 ...
391	2032 S/6X2/4		
393	2226 /6X2 ...		



Sampa Nr.

010.574

O.E.M. Nr.

318 586 00 31

Dimension

Description

Rep. Kit for Cabin

BM	MODEL
314	LP/LPS/LPK/LPKO/LPKF/LPO/LPL/LPLS 608,709
316	LP/LPK/LPKF/LPL 808,809
318	LP 811, 813, 1013, 1113 ...
322	L/LA 322
338	L 338
347	347
349	L 1921, LK 1921

Sampa Nr.

011.001

O.E.M. Nr.

387 891 19 10



Dimension

ø20xø59x12

Description

Cabin Mounting

BM	387	621	646	657
371	389	622	647	658
380	393	623	648	659
381	395	624	649	
383	617	625	655	
385	620	645	656	

Sampa Nr.

111.001

O.E.M. Nr.

000 981 72 31
(000 981 73 31)
(000 981 09 31)



Dimension

ø20xø35x12/16

Description

Cab Suspension Bearing

BM				
360	360	387	619	647
330	376	389	620	648
334	386	390	621	682
341	380	393	622	684
345	381	395	623	747
351	382	397	624	
352	384	615	625	
353	385	616	645	
358	386	617	646	

Sampa Nr.

010.020

O.E.M. Nr.

620 891 04 17



Dimension

ø25xø42x25

Description

Cabin Bushing

BM	387	615	623	649	656	676
363	389	616	624	650	657	677
371	391	617	625	651	658	678
376	393	619	645	652	659	679
380	395	620	646	653	673	684
383	397	621	647	654	674	
385	398	622	648	655	675	

Sampa Nr.

010.055

O.E.M. Nr.

363 891 06 17



Dimension

ø25xø34x43

Description

Cabin Bushing

BM	387	621	647	658
363	389	622	648	659
371	391	623	649	
380	393	624	652	
381	395	625	655	
383	617	645	656	
385	620	646	657	

Sampa Nr.

010.537

O.E.M. Nr.

387 310 00 77
(387 586 01 31)



Dimension

Description

Rep. Kit for Cabin

BM	391	623	649	
380	393	624	652	
381	395	625	655	
383	617	645	656	
385	620	646	657	
387	621	647	658	
389	622	648	659	

Sampa Nr.

010.021

O.E.M. Nr.

620 891 00 17



Dimension

ø21xø35x13.5

Description

Cabin Bushing

BM	389	617	624	650
371	391	619	625	652
380	393	620	645	655
381	395	621	646	656
383	397	622	648	657
385	615	623	648	658
387	616	623	649	659

Stabilizer



Sampa Nr.

011.142

O.E.M. Nr.

**000 323 79 85
(000 323 74 85)
(000 323 75 85)**

Dimension

ø40xø70x46.5

Description

Stabilizer Mounting

BM	MODEL
374/375/940/942/943/944	AXOR
950/952/953/954/958	AXOR
930/932/934/950/952/953/954	ACTROS



Sampa Nr.

011.012

O.E.M. Nr.

**000 326 24 81
(000 323 59 85)**

Dimension

ø39x56

Description

Stabilizer Mounting

BM	MODEL	BM	BM
371	AXOR	930	953
375	ACTROS	933	954
397	ACTROS	934	958
625	ACCELLO	940	970
632		942	972
650		943	976
651		944	
652		950	
653		952	



Sampa Nr.

010.689

O.E.M. Nr.

000 323 79 85 S

Dimension

ø40xø70x46.5

Description

Stabilizer Bearing Kit

MODEL
AXOR
ACTROS



Sampa Nr.

010.690

O.E.M. Nr.

000 323 85 S1

Dimension

ø40xø70x46.5

Description

Stabilizer Bearing Kit

MODEL
AXOR
ACTROS



Sampa Nr.

011.190

O.E.M. Nr.

942 326 00 50

Dimension

ø88xø20.5/130

Description

Silent Block for Stabilizer

BM	MODEL
930,932,934,950,952	ACTROS
970,974,975	ATEGO
374,375,940,944,950	AXOR
957	ECONIC
390	OH 1115L/46, OHL 1621...



Sampa Nr.

011.241

O.E.M. Nr.

941 323 00 50

Dimension

ø73.5xø19/100

Description

Silent Block for Stabilizer

BM	MODEL
375,940,950,954	AXOR
930,934,950,954	ACTROS
390	OHL 1621
405	UNIMOG
957	ECONIC

Sampa Nr.
011.078

O.E.M. Nr.
356 323 00 81



Dimension
ø20xø49x40

Description
Stabilizer Mounting

BM	MODEL
356	O 404
444	TOURINO
613	O 350 TOURISMO, O 403
730	VO 3/100 CLE - 4.1

Sampa Nr.
011.126

O.E.M. Nr.
974 327 01 81



Dimension
ø22xø68x60

Description
Stabilizer Mounting

BM	MODEL
970	ATEGO

Sampa Nr.
011.160

O.E.M. Nr.
000 326 23 81
(000 326 22 81)
(000 326 27 81)



Dimension
ø32xø60x52

Description
Stabilizer Mounting

BM	MODEL
371	1821 AK/4X4/36
397	2426 /6X4, 2426 B/6X4
437	UNIMOG U 2400 TG
625	3229 B/K, 3233 B,3234 B ...
650	1226 AF,1227 AF,1234 AF ...
651	1422 F,1424 F,1426 F, 1427 F ...
652	1722 AK,1724 AK,1824 AK, 1827 AK ...

Sampa Nr.
011.161

O.E.M. Nr.
000 326 37 81
(000 326 36 81)
(000 326 38 81)



Dimension
ø18.5xø60x52

Description
Stabilizer Mounting

BM	MODEL
397	2426 /6X4, 2426 B/6X4
437	UNIMOG U 2400 TG
625	3229 /B/K, 3233 B/K, 3234 B/K
650	1224 AF,1226 AF,1227 AF,1234 AF ...
651	1417 AK,1420 AK,1424 AK ...
652	1722 AK,1724 AK,1824 AK 1827 AK ...
653	2420 /L, 2422 L, 2427 L ...
654	2422 /L, 2426 /L, 2427 L, 2524L ...

Sampa Nr.
011.176

O.E.M. Nr.
974 320 04 44



Dimension
ø16xø39.5x40

Description
Stabilizer Mounting

BM	MODEL
958,970,972,976	ATEGO

Sampa Nr.
011.210

O.E.M. Nr.
000 323 81 85



Dimension
ø40xø80x46

Description
Stabilizer Mounting

BM	MODEL
374	18..., 19..., 30..., 33...
375	1835 LS - 1843 LS
930	1831 - 1848, 2031 - 2048 ...
932	1831 K - 1851 K, 2031 K - 2048 K ...
933	2631 B - 2648 B, 3331 B - 3348 B ...
934	2031 S - 2055 S, 1831 LS - 1865 LS...
940	2535 L - 2543 L, 2535 L - 2543 L
942	2635 K- 2643 K, 3331 K - 3343 K ...

Stabilizer



Sampa Nr.

011.256

O.E.M. Nr.

460 352 50 14

Dimension

ø16xø65x60

Description

Stabilizer Rubber Bushing

BM	MODEL
460	230 G, 240 GD, 280 GE ...
461	230 G/GE, 240 GD ...
463	200 GE, 230 GE, 250 GD ...



Sampa Nr.

011.257

O.E.M. Nr.

460 333 03 14

Dimension

ø16xø70x50

Description

Stabilizer Rubber Bushing

BM	MODEL
460	200 GE, 230 G, 240 GD ...
461	230 G/GE, 240 GD, 250 GD ...
463	200 GE, 230 GE, 250 GD ...



Sampa Nr.

011.174

O.E.M. Nr.

974 327 02 81

Dimension

ø65xø93x67

Description

Stabilizer Mounting

BM	MODEL
934	ACTROS
970	ATEGO



Sampa Nr.

011.191

O.E.M. Nr.

652 326 04 81

Dimension

ø69xø110xø65

Description

Stabilizer Mounting

BM	MODEL
651	1424 L, 1420 L, 2320 L ...
652	1820 L, 1824 L, 2524 L ...
653	2524 /L, 2527 /L, 2531 L, 3231 L ...
654	2433 LS, 2534 LS
655	1831 LS, 1834 LS, 1838 LS



Sampa Nr.

011.208

O.E.M. Nr.

941 326 00 50

Dimension

ø82x110x66.5

Description

Stabilizer Mounting

BM	MODEL
374,375,940,944,950	AXOR
930,932,934,950,952	ACTROS
950,954,970,974,975	ATEGO
957	ECONIC
390	OH/ OHL 1621 ...



Sampa Nr.

011.263

O.E.M. Nr.

941 323 01 50

Dimension

ø70xø98x67

Description

Stabilizer Mounting

MODEL
AXOR
ACTROS
ECONIC
O 500

Sampa Nr.

111.003

O.E.M. Nr.

**000 981 74 31
(000 981 61 31)**



Dimension

ø30xø55x20/32

Description

Ball Bearing for Stabilizer

BM	MODEL
380,381	1017 LS ... / 1213 A ...
383, 385	1419 AK ... / 1619 A ...
387, 389	1626 LS ... / 1932 LS ...
393, 615	2226 LS/6X4 ... / 1222 A,AS ...
616, 617	1419 CL... / 1625 AK,LAK ...
619, 620	2219 CL... / 1633 L ...
621, 622	1928 L,2428 L ... / 2028 LS/6X2/4
623, 645	2228 L ... / 2444LS ...
646, 647	1944 LS... / 2035 LS/6X2/4 ...
648	2235 L,3235 L, 2244 L/LL
651, 652	1420 L,2320 L ... / 1733 L,1734 L...
653, 654	2433 L,2534 L ... / 2524 L,2527 L...
655, 657	1831 LS ... / 2429 LS/6X2/4 ...
656, 658	1929 L,2429 L ... / 2429 L ...

Sampa Nr.

011.004

O.E.M. Nr.

653 326 04 81



Dimension

ø16xø68x60

Description

Stabilizer Mounting

BM	MODEL
651	1420 L, 1424 L, 2320 L ...
652	1820 L, 1824 L, 2524 L ...
653	2422 L, 2427 L, 2524 L, 2527 L ...
654	2422 L, 2524 L, 2527 L, 2531 L ...
655	1838 L, 2538 L, 1844 L, 2544 L
656	1929 L,2429 L
658	2531 L, 2538 L, 2535 L, 2544 L ...

Sampa Nr.

011.005

O.E.M. Nr.

652 326 03 81



Dimension

ø65xø114x65

Description

Stabilizer Mounting

BM	MODEL
651	1420 L/LS, 1422 L/LS ...
652	1717 L, 1720 L, 1722 L/LL ...
653	2420 L, 2422 L, 2427 L ...
654	2420 L, 2422 /L, 2426 /L ...
655	1838 LS

Sampa Nr.

010.540

O.E.M. Nr.

652 320 05 11



Dimension

Description

Stabilizer Bearing Kit

BM	MODEL
651	1420 L/LS, 1422 L/LS ...
652	1717 L, 1720 L ...
653	2420 L, 2422 L ...
654	2420 L, 2422 /L ...

Stabilizer



Sampa Nr.

011.117

O.E.M. Nr.

317 333 11 64
(317 333 09 64)

Dimension

ø53.5x40

Description

Stabilizer Mounting, Standart Size



Sampa Nr.

011.117/1

O.E.M. Nr.

317 333 11 64 S
(317 333 09 64 S)

Dimension

ø53.5x40

Description

Stabilizer Mounting, Different Size



Sampa Nr.

010.700

O.E.M. Nr.

317 333 11 64 S1
(317 333 09 64 S1)

Dimension

ø53.5x40

Description

Stabilizer Bearing Kit, Standart Size



Sampa Nr.

010.700/1

O.E.M. Nr.

317 333 11 64 S2
(317 333 09 64 S2)

Dimension

ø53.5x40

Description

Stabilizer Bearing Kit, Different Size

BM	MODEL
300	O 303
301	O 303
307	O 305, O 305 G, O 307
317	O 317 ...
357	O 405 ...
364	O 370,371,373
373	O 302,303,304,330
396	OH 1622,1627 L ...
600	O 303, 330, 340
612	O 405, 407, 408
664	O 371, 374
665	O 371
697	O 301, O 402
698	BH 4-23 ...

Sampa Nr.

011.077

O.E.M. Nr.

396 323 00 50



Dimension

ø54x80

Description

Stabilizer Half Bushing

BM	MODEL
396	OH 1416,1417, 1622, 1625 /L, 1627 L, 1628 /L
396	OH 1634 L, 1834 OHL, 1829 / OHL

Sampa Nr.

011.079

O.E.M. Nr.

356 326 00 81



Dimension

ø38x60

Description

Stabilizer Half Bushing

BM	MODEL
356	O 404
613	O 350 TOURISMO, O 403

Sampa Nr.

011.093

O.E.M. Nr.

000 326 26 81
(000 326 30 81)
(000 326 32 81)



Dimension

ø48x56.5

Description

Stabilizer Mounting

BM	MODEL
374	652 943 972
375	654 950 974
437	930 952 975
625	932 953 976
650	933 954
651	940 958
	942 970

Sampa Nr.

011.100

O.E.M. Nr.

970 323 15 85



Dimension

ø33.5x47.5

Description

Stabilizer Bearing

BM	MODEL
375/970/972/974/975/976	ATEGO

Sampa Nr.

011.108

O.E.M. Nr.

974 323 02 85



Dimension

ø37.5x56

Description

Stabilizer Mounting

BM	MODEL
958/970/972/975/976	ATEGO

Sampa Nr.

011.109

O.E.M. Nr.

974 323 03 85



Dimension

ø42x55.5

Description

Stabilizer Mounting

BM	MODEL
970/972/974/976	ATEGO

Stabilizer



Sampa Nr.

011.006

O.E.M. Nr.

655 326 04 81

Dimension

ø69.5x65.5

Description

Stabilizer Mounting

BM	MODEL
621	1928 L/LS, 1933 LS, 1936 LS, 1938 LS, 2428 L
646	1935 LS, 1944 LS, 2244 LS, 2444 LS ...
655	1748 L, 1748 LS-2553 LS ...
656	2429 L, 1929 L
657	2429 LS/6X2/4, 2544 LS ...
658	2429 L, 2434 L, 2435 L/LS ...



Sampa Nr.

011.143

O.E.M. Nr.

**000 326 44 81
(000 326 47 81)**

Dimension

ø57.5x56

Description

Stabilizer Mounting

BM	MODEL
375/942/943/944/953/954	AXOR
930/932/933/934/950/952/953/954	ACTROS
957	ECONIC



Sampa Nr.

111.003

O.E.M. Nr.

**000 981 74 31
(000 981 61 31)**

Dimension

ø30xø55x20/32

Description

Ball Bearing for Stabilizer

BM	MODEL
380,381	1017 LS ... / 1213 A ...
383, 385	1419 AK ... / 1619 A ...
387, 389	1626 LS ... / 1932 LS ...
393, 615	2226 LS/6X4 ... / 1222 A,AS ...
616, 617	1419 CL... / 1625 AK,LAK ...
619, 620	2219 CL... / 1633 L ...
684	917 AK INDONESIA



Sampa Nr.

011.144

O.E.M. Nr.

000 325 06 85

Dimension

ø52x56

Description

Stabilizer Mounting

BM	MODEL
950/952/954	ACTROS
952	AXOR

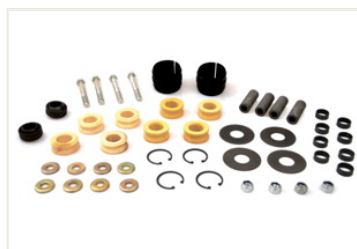

Sampa Nr.

010.541

O.E.M. Nr.

621 320 00 11

Dimension

Description

Stabilizer Bearing Kit

BM	MODEL
621	1928 L/LS, 1933 LS ...
646	1935 LS, 1944 LS ...
656	1929 L, 2429 L
657	2429 LS/6X2/4 ...
658	2429 L, 2434 L ...



Sampa Nr.

011.146

O.E.M. Nr.

**000 323 62 85
(000 323 71 85)**

Dimension

ø28.5x55.5

Description

Stabilizer Mounting

BM	MODEL
374/950	AXOR

Sampa Nr.

011.007

O.E.M. Nr.

655 326 05 81



Dimension

ø64x65.5

Description

Stabilizer Mounting

BM	MODEL
620	1628 L, 1633 L, 1636 L, 1733 L
622	2028/2033/2036 LS/6X2/4 ...
623	2228 L, 2236 L, 3038 L
645	1644LS/L, 2244 LS, 2444LS ...
647	2035 LS/6X2/4
648	2235 L, 3235 L, 2244 L/LL ...

Sampa Nr.

011.188

O.E.M. Nr.

970 323 17 85



Dimension

ø38x47.5

Description

Stabilizer Bearing

BM	MODEL
375,958,970,975,976	ATEGO
444	TOURINO

Sampa Nr.

111.003

O.E.M. Nr.

000 981 74 31

(000 981 61 31)



Dimension

ø30xø55x20/32

Description

Ball Bearing for Stabilizer

BM	MODEL
380,381	1017 LS ... / 1213 A ...
383, 385	1419 AK ... / 1619 A ...
387, 389	1626 LS ... / 1932 LS ...
393, 615	2226 LS/6X4 ... / 1222 A,AS ...
616, 617	1419 CL... / 1625 AK,LAK ...
619, 620	2219 CL... / 1633 L ...
684	917 AK INDONESIA

Sampa Nr.

011.189

O.E.M. Nr.

970 323 12 85



Dimension

ø25x47.5

Description

Stabilizer Bearing

BM	MODEL
970,972,976	ATEGO

Sampa Nr.

010.542

O.E.M. Nr.

620 320 01 11



Dimension

Description

Stabilizer Bearing Kit

BM	MODEL
620	1628 L/LS, 1633 L/LS ...
622	2028 LS/6X2/4 ...
623	2228 L, 2233 L ...
645	1635 L/LS, 1644 L/LS
647	2035 LS/6X2/4
648	2235 L, 2244 L/LL, 3235 L

Sampa Nr.

011.219

O.E.M. Nr.

000 323 58 85

(000 323 55 85)

(000 323 53 85)



Dimension

ø35x56.5

Description

Stabilizer Mounting

BM	MODEL
650	1222 /F/ S/LS, 122 F
651	1417 /K/, 1420 /L, 1424 L ...
652	1717 /L/K, 1720 /L, 1820 L ...
653	2420 /L, 2422, 2427 L ...
654	2422 /L, 2426 /L, 2427 L ...

Stabilizer



Sampa Nr.

010.053

O.E.M. Nr.

620 323 03 50

Dimension

ø44xø56x25

Description

Stabilizer Bushing

BM	MODEL	652	1722 L, 1733 L, 1834 L, 2534 LL
620	1628 L, 1633 L...	653	2534 L, 2433 L
621	1928 L, 1928 LS...	654	2420 L, 2422 ...
622	2028 LS/6X2/4...	655	1729 L, 1735/L...
623	2228 L, 2233 L...	656	2429 L, 1929 L
625	2650 /S, 3028 /K...	657	2429 LS/6X2/4...
645	1635 L, 1635 LS...	658	2429 L, 2434 L...
646	1935 LS, 1944 LS...		
647	2035 LS/6X2/4		
648	2235 L, 2244 L/LL, 3235 L		



Sampa Nr.

010.054

O.E.M. Nr.

620 323 01 50

Dimension

ø58.5xø70x19

Description

Stabilizer Bushing

BM	MODEL
620	1628 L, 1633 L ...
621	1928 L, 1933 LS ...
622	2028 LS/6X2/4 ...
623	2228 L, 2233 L ...
625	3235, 3238, 3244 ...
645	1635 L, 1644 LS/L ...
646	1935 LS, 1944 LS...
647	2035 LS/6X2/4
648	2235 L, 2244 L/LL, 3235 L



Sampa Nr.

011.008

O.E.M. Nr.

653 326 03 81

Dimension

ø44x60.5

Description

Stabilizer Mounting

BM	MODEL
652	1722 L, 1733 L, 1834 L, 2534 LL
653	2433 L, 2534 L
654	2420 L, 2422 /L, 2426 /L, 2427 L, 2433 L/LS
654	2522 L, 2524 L, 2527 L, 2531 L, 2534 L/LS



Sampa Nr.

010.549

O.E.M. Nr.

655 320 01 11

Dimension

Description

Stabilizer Bearing Kit

BM	MODEL
652	1722 L, 2534 LL, 1733 L, 1834 L
653	2433 L, 2534 L
654	2420 L, 2422 /L, 2426 /L, 2427 L, 2433 L, 2433 LS
654	2522 L, 2524, 2524 L, 2527 L, 2531 L, 2534 L, 2534 LS



Sampa Nr.

011.259

O.E.M. Nr.

000 326 50 81

Dimension

ø47.5x56

Description

Stabilizer Mounting

BM	MODEL	930,932,933,934	ACTROS
374,375,942,943	AXOR	950,952,953,954	ACTROS
950,952,953,958	AXOR		



Sampa Nr.

011.264

O.E.M. Nr.

000 326 51 81

Dimension

ø53x56

Description

Stabilizer Mounting

MODEL
AXOR
ACTROS

Sampa Nr.

011.253

O.E.M. Nr.

000 325 04 85



Dimension

ø107x170

Description

Stabilizer Mounting

BM	MODEL
374,375,942,943	AXOR
950,952,953,958	AXOR
930,932,933,934	ACTROS
950,952,953,954	ACTROS

Sampa Nr.

011.048

O.E.M. Nr.

669 326 00 81



Dimension

ø50x80

Description

Stabilizer Bearing

BM	MODEL
669	Vario

Sampa Nr.

011.049

O.E.M. Nr.

**673 326 02 81
(673 326 05 81)**



Dimension

ø36x46

Description

Stabilizer Bearing

BM	MODEL
673	709 K, 809 K, 811 K
674	814 F/K/S
676	817 K/S/F

Sampa Nr.

011.050

O.E.M. Nr.

**673 326 06 81
(673 326 01 81)**



Dimension

ø38.5x46

Description

Stabilizer Bearing

BM	MODEL
674	914 K/KO, 814 F/KO, O 814
676	917 K/KO, 817 F, O 817
697	O 301 / O 402

Sampa Nr.

011.051

O.E.M. Nr.

**673 326 07 81
(673 326 03 81)**



Dimension

ø45x46

Description

Stabilizer Bearing

BM	MODEL
674	814 F
676	817 F, 917 AF/LAF
697	O 301, 402

Sampa Nr.

011.052

O.E.M. Nr.

675 326 06 81



Dimension

ø44.5x59.5

Description

Stabilizer Bearing

BM	MODEL
674	O 814 L, 814 LO
675	1114 L
676	817, 1117 L/LS, 1317 L/LS, O 817 L
677	1117 L, 1120 L/LS, 1320 LS ...
679	1320 L, 1324 L/LS, 1824 L

Stabilizer



Sampa Nr.

011.027

O.E.M. Nr.

**309 320 00 73
(314 326 01 53)**

Dimension

ø12xø28.5x30

Description

Stabilizer Rubber Bushing

BM	378	668	677	972
308	408	669	679	974
310	460	670	684	976
313	461	673	688	
314	463	674	692	
316	661	675	697	
318	667	676	970	



Sampa Nr.

011.053

O.E.M. Nr.

675 326 07 81

Dimension

ø50x59

Description

Stabilizer Bearing

BM	MODEL
611	O 1120 L
675	O 1114 L/42,L/49
676	O 1117 L, 1117 LO
677	O 1120 L



Sampa Nr.

011.031

O.E.M. Nr.

668 326 01 81

Dimension

ø41x80

Description

Stabilizer Bearing

BM	MODEL
669	709 D, Vario
670	809 D, 811 DK, 814 DA
685	914/42
688	LO 812, 712 E, 809 / 914, 915 E, 712 /C



Sampa Nr.

011.087

O.E.M. Nr.

675 323 12 85

Dimension

ø35x59.5

Description

Stabilizer Bearing

BM	MODEL
675	1314 K, 1317 K
676	1317 L/LS
677	1320 L/LS, 1324 L, 2020 L
678	914, 1114, 1117
679	1320 L, 1324 L/LS, 1824 L



Sampa Nr.

010.567

O.E.M. Nr.

670 320 12 11

Dimension

Description

Stabilizer Bearing Kit

BM	MODEL
669	709 D
670	809 D, 811 DK, 814 DA



Sampa Nr.

011.088

O.E.M. Nr.

675 323 18 85

Dimension

ø35x59

Description

Stabilizer Bearing

BM	MODEL
674	814 /L/K/S, 914 /K
675	1314 /L/KO/ LKO, 1317 KO
676	817 /L/LS/KO/S, 1317 /L/LS/KO/S
677	1120 F, 1124 F, 1320 /L ...
679	1324 /S

Sampa Nr.

011.031

O.E.M. Nr.

668 326 01 81



Dimension

ø41x80

Description

Stabilizer Bearing

BM	MODEL
669	709 D, Vario
670	809 D, 811 DK, 814 DA
685	914/42
688	LO 812, 712 E, 809 / 914, 915 E, 712 /C

Sampa Nr.

011.089

O.E.M. Nr.

674 326 00 81



Dimension

ø41.5x59.5

Description

Stabilizer Bearing

BM	MODEL
674	814 L
676	817 L/LS

Sampa Nr.

011.032

O.E.M. Nr.

667 320 00 73



Dimension

ø12xø32.5x36

Description

Stabilizer Rubber Bushing

BM	MODEL	688	709, 710, 712 /C, 1114
398	LO 814	905,906	Sprinter
667	507 D/508 DK	979	ACCELO
668	609 D		
669	709 D, Vario		
670	809 D, 811 DK, 814 DA		
685	914/42		

Sampa Nr.

011.091

O.E.M. Nr.

667 326 01 81



Dimension

ø46x80

Description

Stabilizer Bearing

BM	MODEL
371	O 814 R/S
398	LO 814
667	507 D/508 DK
668	609 D, LO 812, OF 812 ...

Sampa Nr.

010.565

O.E.M. Nr.

670 320 18 11



Dimension

Description

Stabilizer Bearing Kit

BM	MODEL
667	507 D/508 DK
668	609 D

Sampa Nr.

011.107

O.E.M. Nr.

676 326 05 81



Dimension

ø62x60

Description

Stabilizer Bearing

Stabilizer



Sampa Nr.

011.032

O.E.M. Nr.

667 320 00 73

Dimension

ø12xø32.5x36

Description

Stabilizer Rubber Bushing

BM	MODEL	688	709, 710, 712 /C, 1114
398	LO 814	905,906	Sprinter
667	507 D/508 DK	979	ACCELO
668	609 D		
669	709 D, Vario		
670	809 D, 811 DK, 814 DA		
685	914/42		



Sampa Nr.

011.114

O.E.M. Nr.

**675 323 19 85
(675 323 20 85)**

Dimension

ø37.5x59.5

Description

Stabilizer Bearing

BM	MODEL
675	1114 K, 1314 K, 1317 K
676	1117 /K, 1317 K, 1320 K
678	914, 1114, 1117



Sampa Nr.

011.036

O.E.M. Nr.

667 326 06 81

Dimension

ø46x80

Description

Stabilizer Bearing

BM	MODEL
669	Vario, 709 D
670	809 D, 811 DK, 814 DA



Sampa Nr.

011.116

O.E.M. Nr.

675 323 13 85

Dimension

ø41.5x59.5

Description

Stabilizer Bearing

BM	MODEL
677	1120 F, 1124 AF/F



Sampa Nr.

010.570

O.E.M. Nr.

667 320 51 11

Dimension

Description

Stabilizer Bearing Kit

BM	MODEL
669	709 D
670	809 D, 811 DK



Sampa Nr.

011.124

O.E.M. Nr.

**676 326 04 81
(676 326 02 81)**

Dimension

ø56x60

Description

Stabilizer Bearing

BM	MODEL
675	1514 L
676	1517 L
677	1520 L, 2020 L
679	1524 L, 2024 L

Sampa Nr.

011.027

O.E.M. Nr.

309 320 00 73
(314 326 01 53)



Dimension

ø12xø28.5x30

Description

Stabilizer Rubber Bushing

BM	378	668	677	972
308	408	669	679	974
310	460	670	684	976
313	461	673	688	
314	463	674	692	
316	661	675	697	
318	667	676	970	

Sampa Nr.

011.134

O.E.M. Nr.

675 323 07 85



Dimension

ø34.5x57x60

Description

Stabilizer Bearing

BM	MODEL
675	1314/L, 1314 K,1317 K
676	1317 /S, 1317 L/LS
677	1317, 1320 /S/F,1124 F ...

Sampa Nr.

011.038

O.E.M. Nr.

667 326 00 81



Dimension

ø36x80

Description

Stabilizer Bearing

BM	MODEL
667	507 D, 508 DK
668	609 D

Sampa Nr.

011.138

O.E.M. Nr.

676 323 00 85



Dimension

ø43.5x59.5

Description

Stabilizer Bearing

Sampa Nr.

010.572

O.E.M. Nr.

667 320 43 11



Dimension

Description

Stabilizer Bearing Kit

BM	MODEL
667	507 D, 508 DK
668	609 D

Sampa Nr.

011.145

O.E.M. Nr.

675 323 08 85



Dimension

ø41x60

Description

Stabilizer Bearing

Stabilizer



Sampa Nr.

011.159

O.E.M. Nr.

310 326 02 81

Dimension

ø38.5x80

Description

Stabilizer Bearing

BM	MODEL
310	L 608 D
313	L 613 D, O 309 D



Sampa Nr.

011.234

O.E.M. Nr.

675 323 23 85

Dimension

ø43x64

Description

Stabilizer Bearing

BM	MODEL
675	1514 /K/L
676	1517 /K/L
677	1720, 1520 /L, 1524, 2020 L
679	1524 /L,1724, 2024



Sampa Nr.

011.020

O.E.M. Nr.

901 326 00 81

Dimension

ø22x38

Description

Stabilizer Bearing

BM	MODEL
690, 901,902,903	Sprinter



Sampa Nr.

011.054

O.E.M. Nr.

**675 326 04 81
(675 326 01 81)**

Dimension

ø40x56

Description

Stabilizer Bearing

BM	MODEL
674	814 L
675	1114 S/K, 1314 K,1317 K
676	1117 S, 1317 S, 817 L/LS
677	1120 S, 1320 S



Sampa Nr.

011.055

O.E.M. Nr.

**675 326 12 81
(675 326 10 81)**

Dimension

ø47x55.5

Description

Stabilizer Bearing

BM	MODEL
675	1514 K, O 1114
676	917 AF/LAF, 1517 /K, O 1117
677	O 1120, 1120 F,1124 F ...
678	1114 A, 1117 A



Sampa Nr.

011.073

O.E.M. Nr.

675 323 21 85

Dimension

ø38.5x56

Description

Stabilizer Bearing

BM	MODEL
675	1114 AK, 1317 AK, 1314 AK
676	1117 A, 1117 AK, 1317 AK, 1320 AK, 1324 AK
678	1114 A/AK, 1117 A

Sampa Nr.

011.018

O.E.M. Nr.

611 326 00 81



Dimension

ø32x58

Description

Stabilizer Bearing

BM	MODEL
611	410
611	407 D/408 D
611	409 D/410 D

Sampa Nr.

011.119

O.E.M. Nr.

675 323 16 85



Dimension

ø43x56

Description

Stabilizer Bearing

BM	MODEL
676	917 AF/ LAF
677	1120 AF, 1124 AF
678	1114 A

Sampa Nr.

011.023

O.E.M. Nr.

601 321 03 50



Dimension

ø12xø26x26

Description

Stabilizer Rubber Bushing

BM	611	901
405	667	902
408	668	903
418	669	904
437	670	906
601	690	
602	718	

Sampa Nr.

011.120

O.E.M. Nr.

**675 326 05 81
(675 326 02 81)**



Dimension

ø47x56

Description

Stabilizer Bearing

BM	MODEL
675	O 1114

Sampa Nr.

010.582

O.E.M. Nr.

611 320 03 11



Dimension

Description

Stabilizer Bearing Kit

BM	MODEL
611	410
611	407 D/408 D
611	409 D/410 D

Sampa Nr.

011.121

O.E.M. Nr.

675 323 17 85



Dimension

ø35x56

Description

Stabilizer Bearing

BM	MODEL
674	917 AK, 914 AK
675	1114 AK, 1317 AK, 1314 AK
676	1117 A, 917 AK
678	1114 A/AK, 1117 A

Stabilizer



Sampa Nr.

011.019

O.E.M. Nr.

601 326 04 82

Dimension

ø24x38

Description

Stabilizer Bearing



Sampa Nr.

011.125

O.E.M. Nr.

675 326 09 81

Dimension

ø41x56

Description

Stabilizer Bearing

BM	MODEL
674	917 AK, 914 AK
675	1114 K, 1314 K, 1317 K ...
676	1117 A/AK/K/S, 1317 AK/K/KO/S ...
677	1120 S, 1320 S
678	1114 A/AK, 1117 A
679	1324 S



Sampa Nr.

011.023

O.E.M. Nr.

601 321 03 50

Dimension

ø12xø26x26

Description

Stabilizer Rubber Bushing

BM	611	901
405	667	902
408	668	903
418	669	904
437	670	906
601	690	
602	718	



Sampa Nr.

011.127

O.E.M. Nr.

674 328 03 81

Dimension

ø45.5x56

Description

Stabilizer Bearing

BM	MODEL
676	1317 L/LS
677	1320 L/LS, 2020 L, 1320 L, 1324 L



Sampa Nr.

010.561

O.E.M. Nr.

601 320 03 28

Dimension

Description

Stabilizer Bearing Kit



Sampa Nr.

011.158

O.E.M. Nr.

674 328 02 81
(674 328 00 81)

Dimension

ø44x56

Description

Stabilizer Bearing

BM	MODEL
675	1114 L
676	1117 L/LS, 1317 L/LS
677	1117 L, 1120 L, 1121 L ...

Sampa Nr.

011.032

O.E.M. Nr.

667 320 00 73



Dimension

ø12xø32.5x36

Description

Stabilizer Rubber Bushing

BM	MODEL	688	709, 710, 712 /C, 1114
398	LO 814	905,906	Sprinter
667	507 D/508 DK	979	ACCELO
668	609 D		
669	709 D, Vario		
670	809 D, 811 DK, 814 DA		
685	914/42		

Sampa Nr.

011.242

O.E.M. Nr.

667 326 13 81



Dimension

ø41x60

Description

Stabilizer Bearing

BM	MODEL
669	VARIO
905	SPRINTER

Sampa Nr.

011.034

O.E.M. Nr.

670 323 03 85



Dimension

ø40x53

Description

Stabilizer Bearing

BM	MODEL
669	Vario
670	814 DA

Sampa Nr.

011.243

O.E.M. Nr.

667 326 14 81



Dimension

ø46x60

Description

Stabilizer Bearing

BM	MODEL
669	VARIO

Sampa Nr.

010.568

O.E.M. Nr.

670 320 10 11



Dimension

Description

Stabilizer Bearing Kit

BM	MODEL
670	814 DA

Sampa Nr.

011.244

O.E.M. Nr.

667 326 10 81



Dimension

ø46x60

Description

Stabilizer Bearing

BM	MODEL
669	VARIO

Stabilizer



Sampa Nr.

011.022

O.E.M. Nr.

**602 321 00 50
(602 321 02 50)**

Dimension

ø16xø26.5x26

Description

Stabilizer Rubber Bushing

BM	MODEL
601	208/210, 207 D/208 D, 209 D/210 D
602	308, 310, 307 D, 308 D, 309 D, 310 D
611	410, 407 D, 408 D, 409 D, 410 D



Sampa Nr.

011.023

O.E.M. Nr.

601 321 03 50

Dimension

ø12xø26x26

Description

Stabilizer Rubber Bushing

BM	MODEL
611	901
405	667
408	668
418	669
437	670
601	690
602	718



Sampa Nr.

011.040

O.E.M. Nr.

602 326 02 82

Dimension

ø33x49

Description

Stabilizer Bearing

BM	MODEL
601	208, 210, 207 D, 208 D, 209 D, 210 D
602	308/310, 307 D, 308D, 309 D, 310 D



Sampa Nr.

010.556

O.E.M. Nr.

**601 320 07 11
(601 320 00 83)
(601 586 00 32)**

Dimension

Description

Stabilizer Bearing Kit

BM	MODEL
601	208/210, 207 D / 208 D, 209 D / 210 D
602	308/310, 307 D / 308 D, 309 D / 310 D



Sampa Nr.

011.090

O.E.M. Nr.

318 320 00 73

Dimension

ø16xø34x40

Description

Stabilizer Rubber Bushing

BM	MODEL
309	418
310	427
313	436
318	437
368	444
375	669
405	670
	674
	675
	676
	677
	678
	679
	697
	737
	958
	970
	972
	974
	976



Sampa Nr.

011.118

O.E.M. Nr.

974 328 01 81

Dimension

ø22xø47.5x40

Description

Stabilizer Rubber Bushing

BM	MODEL
958/ 970/ 972/ 974/ 975/ 976	ATEGO

Sampa Nr.

011.022

O.E.M. Nr.

**602 321 00 50
(602 321 02 50)**



Dimension

ø16xø26.5x26

Description

Stabilizer Rubber Bushing

BM	MODEL
601	208/210, 207 D/208 D, 209 D/210 D
602	308, 310, 307 D, 308 D, 309 D, 310 D
611	410, 407 D, 408 D, 409 D, 410 D

Sampa Nr.

011.023

O.E.M. Nr.

601 321 03 50



Dimension

ø12xø26x26

Description

Stabilizer Rubber Bushing

BM	MODEL
611	901
405	667
408	668
418	669
437	670
601	690
602	718

Sampa Nr.

011.024

O.E.M. Nr.

602 326 04 82



Dimension

ø30x49

Description

Stabilizer Bearing

BM	MODEL
601	208, 210, 207 D, 208 D, 209 D, 210 D

Sampa Nr.

010.557

O.E.M. Nr.

**601 320 01 83
(601 586 01 32)**



Dimension

Description

Stabilizer Bearing Kit

BM	MODEL
601	208/210, 207 D / 208 D , 209 D / 210 D

Sampa Nr.

100.070

O.E.M. Nr.

602 326 01 40



Dimension

58x62.5x31

Description

Stabilizer Bracket

BM	MODEL
601	208, 210, 207 D/208 D, 209 D, 210 D
602	308, 310, 307 D, 308 D, 309 D, 310 D
611	410, 407 D, 408 D, 409 D, 410 D

Sampa Nr.

O.E.M. Nr.

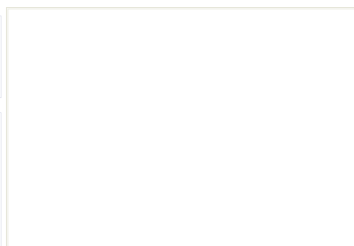

Dimension

Description

Stabilizer



Sampa Nr.

011.022

O.E.M. Nr.

**602 321 00 50
(602 321 02 50)**

Dimension

ø16xø26.5x26

Description

Stabilizer Rubber Bushing

BM	MODEL
601	208/210, 207 D/208 D, 209 D/210 D
602	308, 310, 307 D, 308 D, 309 D, 310 D
611	410, 407 D, 408 D, 409 D, 410 D



Sampa Nr.

011.023

O.E.M. Nr.

601 321 03 50

Dimension

ø12xø26x26

Description

Stabilizer Rubber Bushing

BM	MODEL
611	901
405	667
408	668
418	669
437	670
601	690
602	718



Sampa Nr.

011.025

O.E.M. Nr.

602 326 08 82

Dimension

ø30.5x49

Description

Stabilizer Bearing

BM	MODEL
601	208, 210, 207 D, 208 D, 209 D, 210 D
611	410, 407 D, 408 D, 409 D, 410 D



Sampa Nr.

010.558

O.E.M. Nr.

601 320 04 11

Dimension

Description

Stabilizer Bearing Kit

BM	MODEL
601	208/210, 207 D / 208 D, 209 D / 210 D
611	410, 407 D / 408 D, 409 D / 410 D



Sampa Nr.

011.015

O.E.M. Nr.

901 323 02 85

Dimension

ø13.5xø26x24

Description

Stabilizer Bearing

BM	MODEL
690	310 D, 312 D, 311 GDI, 313 GDI, 412 D
901, 902, 903, 904	Sprinter



Sampa Nr.

011.170

O.E.M. Nr.

631 323 00 44

Dimension

ø11xø32x29.5

Description

Stabilizer Rubber Bushing

BM	MODEL
631	MB 100 D, O 100 CITY

Sampa Nr.

011.027

O.E.M. Nr.

309 320 00 73
(314 326 01 53)



Dimension

ø12xø28.5x30

Description

Stabilizer Rubber Bushing

BM	378	668	677	972
308	408	669	679	974
310	460	670	684	976
313	461	673	688	
314	463	674	692	
316	661	675	697	
318	667	676	970	

Sampa Nr.

011.028

O.E.M. Nr.

309 323 03 85



Dimension

ø30x50

Description

Stabilizer Bearing

BM	MODEL
308	L/LO 608 D, L 708 E ...
309	L 406 DG, L 407 D, L 408 DG ...
310	L 608 D, LK 608 D, O 309 D ...
313	O 309 D, L 613 D
378	L 608 D/E, LFU 608 D, LO 608 D

Sampa Nr.

010.560

O.E.M. Nr.

309 320 02 28
(309 586 01 32)



Dimension

Description

Stabilizer Bearing Kit

BM	MODEL
309	L 406 DG, 407 D, 508 DG ...
310	L 608 D / LF 508 D / O 309 D ...
313	O 309 DL / 613 D

Sampa Nr.

010.028

O.E.M. Nr.

318 321 05 85



Dimension

ø38x50

Description

Stabilizer Plastic Bearing

BM	MODEL
309	L 508 DG
310	L 608 D
310	LF 508 D, 608 D
310	O 309 D
313	O 309 D
313	L 613 D
318	LPL 1113

Sampa Nr.

010.563

O.E.M. Nr.

309 320 00 47



Dimension

Description

Stabilizer Bearing Kit

BM	MODEL
309	L 508 DG
310	LF 508 D, 608 D / O 309 D / L 608 D
313	O 309 D / L 613 D

Sampa Nr.

O.E.M. Nr.

Description

Stabilizer



Sampa Nr.

011.027

O.E.M. Nr.

**309 320 00 73
(314 326 01 53)**

Dimension

ø12xø28.5x30

Description

Stabilizer Rubber Bushing

BM	378	668	677	972
308	408	669	679	974
310	460	670	684	976
313	461	673	688	
314	463	674	692	
316	661	675	697	
318	667	676	970	



Sampa Nr.

011.029

O.E.M. Nr.

309 326 02 81

Dimension

ø34x84

Description

Stabilizer Bearing

BM	MODEL
308	L/LO 608 D, LO 708 D/E
309	LF 408 G,409,410 / O 309 B/D
378	L 608 E, LO 608 D



Sampa Nr.

011.026

O.E.M. Nr.

309 326 04 81

Dimension

ø37x84

Description

Stabilizer Bearing

BM	MODEL
308	L/LO 608 D, LO 708 D/E, L 608 E
309	O 309 B/D, L 508 DG
310	LF 508 D, 608 D, O 309 D
313	O 309 D
378	L 608 E, LO 608 D



Sampa Nr.

010.562

O.E.M. Nr.

**309 320 04 28
(309 586 03 32)**

Dimension

Description

Stabilizer Bearing Kit

BM	MODEL
309	LF 408 G, 409, 410
309	O 309 B/D



Sampa Nr.

010.559

O.E.M. Nr.

**309 320 05 28
(309 586 04 32)**

Dimension

Description

Stabilizer Bearing Kit

BM	MODEL
309	O 309 B/D, L 508 DG
310	L 608 D / LF 508 D,608 D / O 309 D
313	O 309 D



Sampa Nr.

011.009

O.E.M. Nr.

673 323 04 85

Dimension

ø28x60

Description

Stabilizer Bearing

BM	MODEL
673	711, 709

Sampa Nr.

011.027

O.E.M. Nr.

309 320 00 73
(314 326 01 53)



Dimension

ø12xø28.5x30

Description

Stabilizer Rubber Bushing

BM	378	668	677	972
308	408	669	679	974
310	460	670	684	976
313	461	673	688	
314	463	674	692	
316	661	675	697	
318	667	676	970	

Sampa Nr.

011.033

O.E.M. Nr.

667 323 05 85



Dimension

ø34.5x50

Description

Stabilizer Bearing

BM	MODEL
670	809 D, 811 D/DK, 814 D, Vario

Sampa Nr.

011.030

O.E.M. Nr.

309 326 01 81



Dimension

ø33.5xø45x67.5

Description

Stabilizer Bearing

BM	MODEL
309	LF 408 G, LF 409 410
309	O 309 B/D

Sampa Nr.

010.566

O.E.M. Nr.

670 320 14 11



Dimension

Description

Stabilizer Bearing Kit

BM	MODEL
670	809 D, 811 D/DK, 814 D

Sampa Nr.

010.564

O.E.M. Nr.

309 320 01 28



Dimension

Description

Stabilizer Bearing Kit

BM	MODEL
309	LF 408 G, 409, 410
309	O 309 B/D

Sampa Nr.

011.010

O.E.M. Nr.

673 323 03 85



Dimension

ø28x60

Description

Stabilizer Bearing

BM	MODEL
673	811 /K, 809 /K
674	814 /K, 814 L, 914 AK ...
676	817 /F/K/L/LS/S, 917 /K

Stabilizer



Sampa Nr.

011.027

O.E.M. Nr.

**309 320 00 73
(314 326 01 53)**

Dimension

ø12xø28.5x30

Description

Stabilizer Rubber Bushing

BM	378	668	677	972
308	408	669	679	974
310	460	670	684	976
313	461	673	688	
314	463	674	692	
316	661	675	697	
318	667	676	970	



Sampa Nr.

011.037

O.E.M. Nr.

667 323 03 85

Dimension

ø26x50

Description

Stabilizer Bearing

BM	MODEL
667	510, 507 D, 508 D/DK



Sampa Nr.

011.035

O.E.M. Nr.

667 323 04 85

Dimension

ø29.5x50

Description

Stabilizer Bearing

BM	MODEL
668	609 D, 709 D, 711 D
669	Vario
688	709
692	L 710 D



Sampa Nr.

010.571

O.E.M. Nr.

667 320 47 11

Dimension

Description

Stabilizer Bearing Kit

BM	MODEL
667	507 D, 508 D/DK, 510



Sampa Nr.

010.569

O.E.M. Nr.

668 320 04 11

Dimension

Description

Stabilizer Bearing Kit

BM	MODEL
668	609 D
669	709 D, 711 D
692	L 710 D, L 913 D, LO 813 D



Sampa Nr.

011.011

O.E.M. Nr.

675 323 04 85

Dimension

ø35x59.5

Description

Stabilizer Bearing

BM	MODEL
674	814 KO, 914 KO
675	1114 /K/S, O 1114 ...
676	1117 /L/LS, 917 KO, O 1117 /L
677	1117 L, 1120 /L/LS, 1120 S ...

Sampa Nr.

011.027

O.E.M. Nr.

309 320 00 73
(314 326 01 53)



Dimension

ø12xø28.5x30

Description

Stabilizer Rubber Bushing

BM	378	668	677	972
308	408	669	679	974
310	460	670	684	976
313	461	673	688	
314	463	674	692	
316	661	675	697	
318	667	676	970	

Sampa Nr.

011.039

O.E.M. Nr.

667 323 02 85



Dimension

ø30x50.5

Description

Stabilizer Bearing

BM	MODEL
667	510, 507 D, 508 D/DK
669	Vario

Sampa Nr.

010.573

O.E.M. Nr.

667 320 42 11



Dimension

Description

Stabilizer Bearing Kit

BM	MODEL
667	507 D, 508 D/DK, 510

Sampa Nr.

011.045

O.E.M. Nr.

309 323 02 85



Dimension

ø25x50

Description

Stabilizer Bearing

BM	MODEL
309	L 406 DG, 407 D, 408 G, 409, 410
309	LF 408 G, 409, 410
309	LK 406 DG, 407 D, 408 G, 409, 410
309	LKO 406 DG, 407 D, 408 G, 409
309	O 309 B/D

Sampa Nr.

010.591

O.E.M. Nr.

309 320 00 28
(309 586 02 32)



Dimension

Description

Stabilizer Bearing Kit

BM	MODEL
309	L 406 DG, 407 D, 408 G, 409, 410
309	LF 408 G, 409,410
309	LK 406 DG, 407 D, 408 G, 409, 410
309	LKO 406 DG , 407 D, 408 G, 409
309	O 309 B/D

Sampa Nr.

011.106

O.E.M. Nr.

675 323 15 85



Dimension

ø42x59.5

Description

Stabilizer Bearing

Stabilizer



Sampa Nr.

011.027

O.E.M. Nr.

**309 320 00 73
(314 326 01 53)**

Dimension

ø12xø28.5x30

Description

Stabilizer Rubber Bushing

BM	378	668	677	972
308	408	669	679	974
310	460	670	684	976
313	461	673	688	
314	463	674	692	
316	661	675	697	
318	667	676	970	



Sampa Nr.

011.112

O.E.M. Nr.

673 323 05 85

Dimension

ø35x60

Description

Stabilizer Bearing



Sampa Nr.

011.135

O.E.M. Nr.

667 323 06 85

Dimension

ø36x50

Description

Stabilizer Bearing

BM	MODEL
371	O 814 R/S
398	LO 814
669	VARIO
685	914/42
688	712 E, 912, 913, 914, 915 E, 1114
688	L 913 D, OF 809, 812
688	LO 809,812,813 D,814, 915
692	L 913 D
692	LO 813 D



Sampa Nr.

011.113

O.E.M. Nr.

673 323 06 85

Dimension

ø35x60

Description

Stabilizer Bearing

BM	MODEL
674	O 814 /L, 814 F/LO
676	O 817 /L, 817 F/LO



Sampa Nr.

010.551

O.E.M. Nr.

668 320 05 11

Dimension

Description

Stabilizer Bearing Kit



Sampa Nr.

011.137

O.E.M. Nr.

675 323 14 85

Dimension

ø35x59.5

Description

Stabilizer Bearing

BM	MODEL
675	1114 K/L, O 1114 L/42 / L/49
676	1117 K/L/LS/LO, O 1117 L
677	1117 L,1120 L/LS,1121 L

<i>Sampa Nr.</i>		
100.105		
<i>O.E.M. Nr.</i> 904 326 13 40		
<i>Dimension</i>		42x60xø11/80
<i>Description</i> Stabilizer Bracket		
BM	MODEL	
690,904	Sprinter	

<i>Sampa Nr.</i>		
011.097		
<i>O.E.M. Nr.</i> 904 326 10 81		
<i>Dimension</i>		ø33x46x50
<i>Description</i> Stabilizer Bearing		
BM	MODEL	
690,904	SPRINTER	

<i>Sampa Nr.</i>		
011.098		
<i>O.E.M. Nr.</i> 904 326 09 81		
<i>Dimension</i>		ø30x46x50
<i>Description</i> Stabilizer Bearing		
BM	MODEL	
904,906	SPRINTER	

<i>Sampa Nr.</i>		
011.099		
<i>O.E.M. Nr.</i> 904 326 08 81		
<i>Dimension</i>		ø27x46x50
<i>Description</i> Stabilizer Bearing		
BM	MODEL	
690,904,906	SPRINTER	

<i>Sampa Nr.</i>		
011.016		
<i>O.E.M. Nr.</i> 901 323 01 85		
<i>Dimension</i>		ø22x30.5x39
<i>Description</i> Stabilizer Bearing		
BM	MODEL	
690/901/902/903	Sprinter	

<i>Sampa Nr.</i>		
011.017		
<i>O.E.M. Nr.</i> 904 323 00 85		
<i>Dimension</i>		ø25x30.5x39.5
<i>Description</i> Stabilizer Bearing		
BM	MODEL	
690 901,902,903,904	310 D,312 D, 311 GDI ,313 GDI, 412 D Sprinter	

Stabilizer



Sampa Nr.

011.214

O.E.M. Nr.

638 326 02 81

Dimension

ø13.5x35x46

Description

Stabilizer Bearing

BM	MODEL
638	VITO



Sampa Nr.

011.215

O.E.M. Nr.

638 323 02 85

Dimension

ø24x35x46

Description

Stabilizer Bearing

BM	MODEL
638	VITO
639	VITO / VIANO
906	SPRINTER



Sampa Nr.

010.015

O.E.M. Nr.

314 326 03 81

Dimension

ø29.5x40x62

Description

Stabilizer Plastic Bearing

BM	MODEL
314	LPKF 608,709
314	LPKO 608,709
314	LPO 608,709
314	LPS 608,709



Sampa Nr.

010.016

O.E.M. Nr.

316 326 00 81

Dimension

ø35x40x62

Description

Stabilizer Plastic Bearing

BM	MODEL
314	LPL 608,709, LPLS 608,709
316	LPKF 808,809, LPO 808,809
316	LPO 808,809, LPL 808,809
318	LP 1013, LPK 1013, LPL 813, LPLS 813
318	LPO 811,813, LPS 811,813, 913
408	UNIMOG U 90 (TURBO), U 100 L (TURBO)
684	508 I



Sampa Nr.

010.017

O.E.M. Nr.

314 326 00 81

Dimension

ø30x40x56.5

Description

Stabilizer Plastic Bearing

BM	MODEL	314	LPO 608,709
314	LPKF 608,709	314	LPS 608,709
314	LPKO 608,709		



Sampa Nr.

010.018

O.E.M. Nr.

318 326 00 81

Dimension

ø38x40x62

Description

Stabilizer Plastic Bearing

BM	MODEL	318	LPLS 813
316	LPL 808,809	318	LPS 811,813
318	LPK 1013	684	508 I
318	LPL 813, 913, 1013		

Sampa Nr.

010.001

O.E.M. Nr.

393 326 02 81



Dimension

ø65xø86x90

Description

Stabilizer Plastic Bearing

BM	MODEL	617	1617 CL ...
380	1017 LS	619	2219 CL ...
381	1217 L/ LS	620	1628 L ...
383	1419 L,1424 LS	622	2028 LS ...
385	1613 L...	623	2228 L...
387	1626/1632 L/LS	645	1635 L ...
393	2226 L ...	647	2035 LS/6X2/4
616	1419 CL,1420 L	648	2235 L, 2244 L/LL, 3235

Sampa Nr.

111.003

O.E.M. Nr.

**000 981 74 31
(000 981 61 31)**



Dimension

ø30xø55x20/32

Description

Ball Bearing for Stabilizer

BM	MODEL
380,381	1017 LS ... / 1213 A ...
383, 385	1419 AK ... / 1619 A ...
387, 389	1626 LS ... / 1932 LS ...
393, 615	2226 LS/6X4 ... / 1222 A,AS ...
616, 617	1419 CL... / 1625 AK,LAK ...
619, 620	2219 CL... / 1633 L ...

Sampa Nr.

010.544

O.E.M. Nr.

**387 320 03 28
(387 586 03 32)**



Dimension

Description

Stabilizer Bearing Kit

BM	MODEL
387	1626 L/LS, 1632 L/LS
393	2226 L/6X2, 2232 L/6X2
620	1628 L/LS, 1633 L/LS ...
622	2028/2033/2036 LS/6X2/4
623	2228 L, 2233 L ...
645	1635 L/LS, 1644 L/LS ...
647	2035 LS/6X2/4

Sampa Nr.

010.545

O.E.M. Nr.

**380 320 00 28
(380 586 00 32)**



Dimension

Description

Stabilizer Bearing Kit

BM	MODEL
380	1017 LS
381	1217 L/LS
383	1419 L/LS, 1424 LS
385	1613 L, 1617 L ...
616	1419 CL, 1420 L/LS ...
617	1617 CL, 1620 L/LL ...
619	2219 CL, 2220 L ...

Sampa Nr.

010.004

O.E.M. Nr.

383 326 01 81



Dimension

ø51xø81.5x100.5

Description

Stabilizer Plastic Bearing

BM	MODEL	358	OF 1113
300	O 303	364	O 370,371
397	LP 1114, 1214 A	376	LS 1418, LPS 1525
345	LS 1524, 1525	380	1013 KO ...
352	OF1313,1317,1413,1417	381	1213 AKO ...
355	OF 1617,1621	384	LK 1214, LAK 1418

Sampa Nr.

010.006

O.E.M. Nr.

360 323 00 85



Dimension

ø39x37

Description

Stabilizer Plastic Bearing

BM	MODEL
341	OF 1114, 1214 (AB)
345	L 1313, LA 1314, LG 1819 ...
351	L 1514, LS 1526, OH 1314
352	L 1313, LAK 1313, OF 1417
353	LT 911 B
355	OF 1617,1621

Stabilizer



Sampa Nr.

111.003

O.E.M. Nr.

**000 981 74 31
(000 981 61 31)**

Dimension

ø30xø55x20/32

Description

Ball Bearing for Stabilizer

BM	MODEL
380,381	1017 LS ... / 1213 A ...
383, 385	1419 AK ... / 1619 A ...
387, 389	1626 LS ... / 1932 LS ...
393, 615	2226 LS/6X4 ... / 1222 A,AS ...
616, 617	1419 CL... / 1625 AK,LAK ...
619, 620	2219 CL... / 1633 L ...



Sampa Nr.

010.002

O.E.M. Nr.

393 326 03 81

Dimension

ø60xø86x90

Description

Stabilizer Plastic Bearing

BM	MODEL
393	2226 6X4
393	2226 LS
393	2232 6X4
393	2232 LS



Sampa Nr.

010.003

O.E.M. Nr.

389 326 00 81

Dimension

ø70xø86x90

Description

Stabilizer Plastic Bearing

BM	MODEL	621	1938 LS
389	1926 LS	621	2428 L
389	1932 LS	646	1935 LS
621	1928	646	1944 LS
621	1928 L	646	2244 LS
621	1928 LS	646	2444 LS
621	1933 LS	656	1929 L
621	1936 LS	656	2429 L



Sampa Nr.

010.543

O.E.M. Nr.

**393 320 04 28
(393 586 05 32)**

Dimension

Description

Stabilizer Bearing Kit

BM	MODEL
393	2226 LS/6X4, 2232 LS/6X4



Sampa Nr.

010.546

O.E.M. Nr.

621 320 01 28

Dimension

Description

Stabilizer Bearing Kit

BM	MODEL
389	1926 LS, 1932 LS
621	2428 L, 1928 L/LS ...
646	1935 LS, 1944 LS, 2244 LS, 2444 LS
656	2429 L, 1929 L

Sampa Nr.

O.E.M. Nr.

Dimension

Description

Sampa Nr.

010.038

O.E.M. Nr.

387 326 02 81



Dimension

ø45xø86x63

Description

Stabilizer Plastic Bearing

BM	391	620	647	657
336	397	621	648	658
346	398	622	650	
363	615	623	651	
371	616	625	652	
387	617	645	655	
389	619	646	656	

Sampa Nr.

010.039

O.E.M. Nr.

387 326 01 81



Dimension

ø50.5xø86x63

Description

Stabilizer Plastic Bearing

BM	MODEL
387	1626 L/LS, 1632 L/LS
389	1926 LS, 1932 LS
393	2226 L/6X2, 2226 LS/6X4, 2232 L/6X2, 2232 LS/6X4
620	1628 L/LS, 1633 L/LS, 1636 L/LS, 1733 L
621	1928 L, 1928 LS, 2028 LS/6X2/4 ...
623	2238, 2236 L/LS, 2428 L, 2433 L, 3038 L
625	3244, 3028 /K, 3235 AK/ K ...

Sampa Nr.

010.049

O.E.M. Nr.

387 326 00 50



Dimension

ø32xø44x36.5

Description

Stabilizer Bushing

BM	MODEL	622	2028,2036,2033 LS/6X2/4
371	1922 K,1935 S/35 LS/35 ...	623	2233, 2228 S, 2236 L ...
396	OH 1622, 1625,1628	625	3235, 3228 /K/L ...
397	1729 S, OH 1416 ...		
398	1926/4X2, 1926/AK 4X4		
620	1628 L, 1628 LS, 2233 S ...		
621	1922, 1933, 1925 AK ...		

Sampa Nr.

010.052

O.E.M. Nr.

000 326 06 50



Dimension

ø41xø52x25

Description

Stabilizer Bushing

BM	391	617	645	655
336	393	619	646	656
346	396	620	647	657
363	397	621	648	658
371	398	622	650	696
387	615	623	651	
389	616	625	652	

Sampa Nr.

010.501

O.E.M. Nr.

620 320 00 28



Dimension

Description

Stabilizer Bearing Kit

BM	MODEL
371	1922 K, 1928 S, 1938 S/35 ...
397	1924 /S, 1928 /S, 1729 S, 1735 S
398	1926/4X2, 1926/AK 4X4
620	1628, 2228, 2428, 2433 ...
621	1922,2222,2422,2622 ...
645	1635, 2435, 1644/L,1650 ...

Sampa Nr.

010.510

O.E.M. Nr.

620 320 01 28



Dimension

Description

Stabilizer Bearing Kit

BM	MODEL
620	1628 L/LS, 1633 L,1733 L ...
621	1928 L/LS, 1933 LS, 1936 LS, 1938 LS, 2428 L
622	2028/2033/2036 LS/6X2/4
623	2233 / L, 2236 L/LS, 2238 L ...
625	3235, 3238, 3244 ...

Stabilizer



Sampa Nr.

010.041

O.E.M. Nr.

621 323 00 85

Dimension

ø35xø70x62

Description

Stabilizer Plastic Bearing

BM	MODEL
398	1926 /AK 4X4
621	1245 A, 1928 A/AK/K, 1936 AS/LAS ...
624	2628 A, 2645 AF, 6036 /AK ...
625	3235 AK, 3538 AK/K, 4050 A/8X8
646	1935 AS, 3535 A/AK ...



Sampa Nr.

010.045

O.E.M. Nr.

620 323 02 50

Dimension

ø25.5xø35x25

Description

Stabilizer Bushing

BM	MODEL	623	2228 ...
371	1817 K/4X2/36 ...	624	3036 ...
388	L 2635/6X4/54 ...	625	3050 ...
397	1729 S ...	645	1635 ...
398	2629 /AK 6X6 ...	646	3835 ...
619	2025 S ...	647	2035 S/6X2/4...
620	2433 ...	648	2244 ...
621	1245 A ...	649	2635 ...



Sampa Nr.

010.050

O.E.M. Nr.

000 323 21 50

Dimension

ø32.5xø44x25

Description

Stabilizer Bushing

BM	389	437	625	653	699
346	391	615	646	654	737
350	393	616	648	655	
371	395	617	649	658	
385	397	619	650	659	
387	398	620	651	660	
388	436	621	652	684	



Sampa Nr.

010.503

O.E.M. Nr.

621 320 02 28

Dimension

Description

Stabilizer Bearing Kit

BM	MODEL
398	1926/AK 4X4
621	2428, 2436 ...
624	2628, 2636 ...
625	4050 A/8X8
646	1935 AS, 1935 AK
649	2635 A, 2635 AS, 3335 A, 3535 A/AK
655	1835, 1838 ...



Sampa Nr.

010.043

O.E.M. Nr.

314 326 04 81

Dimension

ø18xø26.5x14.5

Description

Stabilizer Bushing

BM	MODEL
314	LPKF 608,709, LPS 608,709 ...
308	L 608 E, LO 708 D/E ...
309	L 406 DG, L 508 DG, O 309 D ...
310	L 608 D, LK 608 D, O 309 D
316	LP 808,809, LPKF 808,809 ...
318	LP 811,813, LPO 811,813 ...
378	L 608 D/E, LFU 608 D, LO 608 D



Sampa Nr.

010.525

O.E.M. Nr.

314 326 04 81 S

Dimension

ø18xø26.5x14.5

Description

Stabilizer Bearing Kit

BM	MODEL
314	LPKF 608,709, LPS 608,709 ...
308	L 608 E, LO 708 D/E ...
309	L 406 DG, L 508 DG, O 309 D ...
310	L 608 D, LK 608 D, O 309 D
316	LP 808,809, LPKF 808,809 ...
318	LP 811,813, LPO 811,813 ...
378	L 608 D/E, LFU 608 D, LO 608 D

Sampa Nr.

010.031

O.E.M. Nr.

387 323 02 85



Dimension

ø37xø70x62

Description

Stabilizer Plastic Bearing

BM	389	437	645	652	659
346	391	619	646	653	660
350	395	620	647	654	
371	397	621	648	655	
385	398	623	649	656	
387	427	624	650	657	
388	436	625	651	658	

Sampa Nr.

010.045

O.E.M. Nr.

620 323 02 50



Dimension

ø25.5xø35x25

Description

Stabilizer Bushing

BM	MODEL	623	2228 ...
371	1817 K/4X2/36 ...	624	3036 ...
388	L 2635/6X4/54 ...	625	3050 ...
397	1729 S ...	645	1635 ...
398	2629 /AK 6X6 ...	646	3835 ...
619	2025 S ...	647	2035 S/6X2/4...
620	2433 ...	648	2244 ...
621	1245 A ...	649	2635 ...

Sampa Nr.

010.050

O.E.M. Nr.

000 323 21 50



Dimension

ø32.5xø44x25

Description

Stabilizer Bushing

BM	389	437	625	653	699
346	391	615	646	654	737
350	393	616	648	655	
371	395	617	649	658	
385	397	619	650	659	
387	398	620	651	660	
388	436	621	652	684	

Sampa Nr.

010.502

O.E.M. Nr.

**620 320 06 28
(619 320 01 28)**



Dimension

Description

Stabilizer Bearing Kit

BM	MODEL
371	1817/1821 K/4X2/36 ...
388	L 1929, 1935, 1938, 1945 ...
397	2426 /6X4, 1729 S ...
398	1926/4X2, 2629/6X4, 2629/AK 6X6
319	2219 C, 2220, 2222, 2225 ...
620	1628, 2428, 1633, 1636 ...

Sampa Nr.

010.506

O.E.M. Nr.

625 320 06 11



Dimension

Description

Stabilizer Bearing Kit

BM	MODEL
625	3229 /B/K, 3233 B/K, 3234 B/K
650	1222 F/S/LS, 1224 F
651	1417, 1420, 1422, 1424 ...
652	1720, 1820, 1824, 1717 ...
653	2420, 2524, 2527, 2531/L ...
654	2420, 2433 S, 2524 L, 2531...

Sampa Nr.

010.027

O.E.M. Nr.

435 323 00 85



Dimension

ø32.5xø70x62

Description

Stabilizer Plastic Bearing

BM	MODEL
436	UNIMOG U 1300 L

Stabilizer



Sampa Nr.

010.038

O.E.M. Nr.

387 326 02 81

Dimension

ø45xø86x63

Description

Stabilizer Plastic Bearing

BM	387	615	621	646	652
336	389	616	622	647	655
346	391	617	623	648	656
363	397	619	625	650	657
371	398	620	645	651	658



Sampa Nr.

010.039

O.E.M. Nr.

387 326 01 81

Dimension

ø50xø86x63

Description

Stabilizer Plastic Bearing

BM	MODEL
387	1626 L/LS, 1632 L/LS
389	1926 LS,1932 LS
393	2226 L/6X2, 2226 LS/6X4, 2232 L/6X2, 2232 LS/6X4
620	1628 L/LS, 1633 L/ LS, 1636 L/LS, 1733 L
621	1928 L, 1928 LS, 2028 LS/6X2/4 ...
623	2238, 2236 L/LS, 2428 L, 2433 L, 3038 L
625	3244, 3028 /K, 3235 AK/ K ...



Sampa Nr.

010.053

O.E.M. Nr.

620 323 03 50

Dimension

ø44xø56x25

Description

Stabilizer Bushing

BM	MODEL	648	2235 L, 2244 L/L, 3235 L
620	1628 L, 1633 L ...	652	1722 L, 1733 L, 1834 L, 2534 LL
621	1928 L, 1928 LS ...	653	2534 L, 2433 L
622	2028 LS/6X2/4 ...	654	2420 L, 2422 ...
623	2228 L, 2233 L ...	655	1729 L, 1735/L...
625	2650 /S, 3028 /K ...	656	2429 L, 1929 L
645	1635 L, 1635 LS ...	657	2429 LS/6X2/4 ...
646	1935 LS, 1944 LS ...	658	2429 L, 2434 L ...
647	2035 LS/6X2/4		



Sampa Nr.

010.054

O.E.M. Nr.

620 323 01 50

Dimension

ø58.5xø70x19.5

Description

Stabilizer Bushing

BM	MODEL	646	1935 LS, 1944 LS...
620	1628 L, 1633 L ...	647	2035 LS/6X2/4
621	1928 L, 1933 LS ...	648	2235 L, 2244 L/LL, 3235 L
622	2028 LS/6X2/4 ...		
623	2228 L, 2233 L ...		
625	3235, 3238, 3244 ...		
645	1635 L, 1644 LS/L ...		



Sampa Nr.

010.504

O.E.M. Nr.

621 320 04 28

Dimension

Description

Stabilizer Bearing Kit

BM	MODEL
620	1628 L/LS, 1633 L/LS, 1636 L/LS, 1733 L
621	1928 L/LS,1933 LS ...
622	2028, 2036, 2033 LS/6X2/4
623	2228 L, 2233 L ...
625	3548/S, 3050/S ...
645	1635 L/LS, 1644 L/LS, 2244 LS, 2444 LS



Sampa Nr.

010.533

O.E.M. Nr.

625 320 01 11

Dimension

Description

Stabilizer Bearing Kit

BM	MODEL
625	3028 /K, 3238, 3244, 3250,4850 ...

Sampa Nr.

010.033

O.E.M. Nr.

387 323 03 85



Dimension

ø41xø70x62

Description

Stabilizer Plastic Bearing

BM	395	617	650
352	397	619	651
355	427	621	658
385	436	623	684
387	437	624	
389	615	625	
393	616	648	

Sampa Nr.

010.031

O.E.M. Nr.

387 323 02 85



Dimension

ø37xø70/x62

Description

Stabilizer Plastic Bearing

BM	389	437	645	652	659
346	391	619	646	653	660
350	395	620	647	654	
371	397	621	648	655	
385	398	623	649	656	
387	427	624	650	657	
388	436	625	651	658	

Sampa Nr.

010.047

O.E.M. Nr.

620 323 00 50



Dimension

ø25xø35x30,5

Description

Stabilizer Bushing

BM	MODEL	623	2228, 2438, 2236 L ...
397	1924, 2624 K/6X4 ...	624	2636, 3536, 2636 /L
619	2219, 2025 ...	625	3328, 3535 /B/K ...
620	1628, 1635 S, 2228 ...		
621	1245 A, 1922 AK, 1928 S ...		

Sampa Nr.

010.050

O.E.M. Nr.

000 323 21 50



Dimension

ø32.5xø44x25

Description

Stabilizer Bushing

BM	389	437	625	653	699
346	391	615	646	654	737
350	393	616	648	655	
371	395	617	649	658	
385	397	619	650	659	
387	398	620	651	660	
388	436	621	652	684	

Sampa Nr.

010.505

O.E.M. Nr.

624 320 00 28

(625 320 00 28)



Dimension

Description

Stabilizer Bearing Kit

BM	MODEL
625	3820, 3850 A
621	2436, 2528, 1245 A ...
624	2628, 2636, 3328 ...

Sampa Nr.

010.508

O.E.M. Nr.

620 320 04 28

(620 320 02 32)

(620 586 02 32)



Dimension

Description

Stabilizer Bearing Kit

BM	MODEL
397	1924 /S/K, 1925, 2624/6X4 ...
620	1628, 2228, 2428, 2433 ...
621	1928, 2228, 2428, 1933 ...
623	2228, 2628, 2228, 2628 ...
624	2628 B/6X4, 3328 B/K ...
625	3028 /B/K, 3228/K/L, 3235/K ...

Stabilizer



Sampa Nr.

010.031

O.E.M. Nr.

387 323 02 85

Dimension

ø37xø70x62

Description

Stabilizer Plastic Bearing

BM	389	437	645	652	659
346	391	619	646	653	660
350	395	620	647	654	
371	397	621	648	655	
385	398	623	649	656	
387	427	624	650	657	
388	436	625	651	658	



Sampa Nr.

010.041

O.E.M. Nr.

621 323 00 85

Dimension

ø35xø70x62

Description

Stabilizer Plastic Bearing

BM	MODEL
398	1926 /AK 4X4
621	1245 A, 1928 A/AK/K, 1936 AS/LAS ...
624	2628 A, 2645 AF, 6036 /AK ...
625	3235 AK, 3538 AK/K, 4050 A/8X8
646	1935 AS, 3535 A/AK ...



Sampa Nr.

010.045

O.E.M. Nr.

620 323 02 50

Dimension

ø25.5xø35x25

Description

Stabilizer Bushing

BM	MODEL	623	2228 ...
371	1817 K/4X2/36 ...	624	3036 ...
388	L 2635/6X4/54 ...	625	3050 ...
397	1729 S ...	645	1635 ...
398	2629 /AK 6X6 ...	646	3835 ...
619	2025 S ...	647	2035 S/6X2/4...
620	2433 ...	648	2244 ...
621	1245 A ...	649	2635 ...



Sampa Nr.

010.054

O.E.M. Nr.

620 323 01 50

Dimension

ø58.5xø70x19.5

Description

Stabilizer Bushing

BM	MODEL	646	1935 LS, 1944 LS...
620	1628 L, 1633 L ...	647	2035 LS/6X2/4
621	1928 L, 1933 LS ...	648	2235 L, 2244 L/LL, 3235 L
622	2028 LS/6X2/4 ...		
623	2228 L, 2233 L ...		
625	3235, 3238, 3244 ...		
645	1635 L, 1644 LS/L ...		



Sampa Nr.

010.507

O.E.M. Nr.

647 320 00 28

Dimension

Description

Stabilizer Bearing Kit

BM	MODEL
325	3050, 3235, 3238 ...
647	2035 S/6X2/4
657	2429 S/6X2/4, 2435 S/6X2/4, 2538 S



Sampa Nr.

010.526

O.E.M. Nr.

625 320 04 11

Dimension

Description

Stabilizer Bearing Kit

BM	MODEL
625	4844, 4850, 3235 AK, 3535 AK, 3538 AK/K, 3544 AK/K
625	3544 S, 3550 AK/K, 4844 /K, 4853, 5038 AK

Sampa Nr.

010.031

O.E.M. Nr.

387 323 02 85



Dimension

ø37xø70x62

Description

Stabilizer Plastic Bearing

BM	389	437	645	652	659
346	391	619	646	653	660
350	395	620	647	654	
371	397	621	648	655	
385	398	623	649	656	
387	427	624	650	657	
388	436	625	651	658	

Sampa Nr.

010.046

O.E.M. Nr.

000 323 09 50



Dimension

ø25xø35x28

Description

Stabilizer Bushing

BM	MODEL
395	2626 AB/ A /AK/ AS/B/K/S
336	2632
346	2632 A/AK
350	2632 AS/K
363	2632 S, LPK 2226/6X4 ...
385	2219 /6X2/4, 2219 L/6X2
387	1626 /AK , 1626 AS, 1719 S...

Sampa Nr.

010.509

O.E.M. Nr.

620 320 02 28

(620 586 00 32)



Dimension

Description

Stabilizer Bearing Kit

BM	MODEL
346	LS 1924, 1928
387	1626 (S), 1632 (S)
389	1926 /K/S, 1932 /K/S
391	2026 S/6X2/4, 2032 S/6X2/4
393	2226/6X2, 2226/6X4 ...
395	2632, 3332, 2226 S/6X4 ...

Sampa Nr.

010.032

O.E.M. Nr.

000 323 39 85



Dimension

ø41xø70x62

Description

Stabilizer Plastic Bearing

BM	MODEL
387	1626 AK, 1626 AS, 1632 AK,1632 AS
389	1926 A, 1926 AK,1926 AS,1932 A,1932 AK,1932 AS
393	2226 L/6X2, 2232 L/6X2
395	2626 AB

Sampa Nr.

010.050

O.E.M. Nr.

000 323 21 50



Dimension

ø32.5xø44x25

Description

Stabilizer Bushing

BM	389	437	625	653	699
346	391	615	646	654	737
350	393	616	648	655	
371	395	617	649	658	
385	397	619	650	659	
387	398	620	651	660	
388	436	621	652	684	

Sampa Nr.

010.514

O.E.M. Nr.

393 320 01 28

(393 586 01 32)



Dimension

Description

Stabilizer Bearing Kit

BM	MODEL
387	1626 AS/AK, 1632 AS/AK
389	1926 A/AK/AS, 1932 A/AK/AS
393	2226 / 2232 L/6X2
395	2626 A/AB/AS, 2632 A/AS

Stabilizer



Sampa Nr.

010.034

O.E.M. Nr.

387 323 01 85

Dimension

ø46xø70x62

Description

Stabilizer Plastic Bearing

BM	MODEL
385	2219/6X2/4
387	1719 /S/AK
389	1919 AK/K/ S
619	2219, 2225, 2222,2025 S, 2228
621	1922 /AK/K/S, 2422 /K, 1925 AK, 2220, 2222, 2622



Sampa Nr.

010.047

O.E.M. Nr.

620 323 00 50

Dimension

ø25xø35x30.5

Description

Stabilizer Bushing

BM	MODEL
623	2228, 2438, 2236 L ...
397	1924, 2624 K/6X4 ...
624	2636, 3536, 2636 /L
619	2219, 2025 ...
625	3328, 3535 /B/K ...
620	1628, 1635 S, 2228 ...
621	1245 A, 1922 AK, 1928 S ...



Sampa Nr.

010.050

O.E.M. Nr.

000 323 21 50

Dimension

ø32.5xø44x25

Description

Stabilizer Bushing

BM	389	437	625	653	699
346	391	615	646	654	737
350	393	616	648	655	
371	395	617	649	658	
385	397	619	650	659	
387	398	620	651	660	
388	436	621	652	684	



Sampa Nr.

010.511

O.E.M. Nr.

619 320 00 28

Dimension

Description

Stabilizer Bearing Kit

BM	MODEL
619	2025 S, 2219 C, 2220, 2222, 2225,2228
621	1922 /AK/K/S, 1925 AK, 2222, 2422 / K, 2622



Sampa Nr.

111.001

O.E.M. Nr.

**000 981 72 31
(000 981 73 31)
(000 981 09 31)**

Dimension

ø20xø35x12/16

Description

Ball Bearing for Stabilizer

BM	360	387	619	647
330	376	389	620	648
334	386	390	621	682
341	380	393	622	684
345	381	395	623	747
351	382	397	624	
352	384	615	625	
353	385	616	645	
358	386	617	646	



Sampa Nr.

010.553

O.E.M. Nr.

**360 320 00 41
(360 586 00 32)**

Dimension

ø20xø35x12/16

Description

Stabilizer Bearing Kit

BM	MODEL
345	L 1313, 1314, 1316, 1317 ...
352	L 1313, L 1813/6X2 ...
353	L 911 B, LA 911 B ...
355	OF 1617, 1621
358	L 1113 B, LA 1113 B, LAF 1113 B ...
360	L 1817,1819/6X4, L 1513 ...
376	L 1316,1317 / LP 1219,1419
380	1013 /K/KO/S, 1017 /F/K/KO/LS/S, 1019 F
381	1213 /K/KO/S, 1217 /K/KO/S ...

Sampa Nr.

010.034

O.E.M. Nr.

387 323 01 85



Dimension

ø46xø70x62

Description

Stabilizer Plastic Bearing

BM	MODEL
385	2219/6X2/4
387	1719 /S/AK
389	1919 AK/K/ S
619	2219, 2225, 2222,2025 S, 2228
621	1922 /AK/K/S, 2422 /K, 1925 AK, 2220, 2222, 2622

Sampa Nr.

010.033

O.E.M. Nr.

387 323 03 85



Dimension

ø41xø70x62

Description

Stabilizer Plastic Bearing

BM	395	617	650
352	397	619	651
355	427	621	658
385	436	623	684
387	437	624	
389	615	625	
393	616	648	

Sampa Nr.

010.046

O.E.M. Nr.

000 323 09 50



Dimension

ø25xø35x28

Description

Stabilizer Bushing

BM	MODEL
395	2626 AB/ A /AK/ AS/B/K/S
336	2632
346	2632 A/AK
350	2632 AS/K
363	2632 S, LPK 2226/6X4 ...
385	2219 /6X2/4, 2219 L/6X2

Sampa Nr.

010.050

O.E.M. Nr.

000 323 21 50



Dimension

ø32.5xø44x25

Description

Stabilizer Bushing

BM	389	437	625	653	699
346	391	615	646	654	737
350	393	616	648	655	
371	395	617	649	658	
385	397	619	650	659	
387	398	620	651	660	
388	436	621	652	684	

Sampa Nr.

010.515

O.E.M. Nr.

389 320 01 28



Dimension

Description

Stabilizer Bearing Kit

BM	MODEL
385	2219/6X2/4
387	1719 /S/AK
389	1919 /AK/K/S

Sampa Nr.

010.516

O.E.M. Nr.

**393 320 03 28
(393 586 04 32)**



Dimension

Description

Stabilizer Bearing Kit

BM	MODEL
387	1626 AS/AK, 1632 AS/AK
389	1926 A/AK/AS, 1932 A/AK/AS
393	2226/2232 L/6X2
395	2626 A/AB/AS, 2632 A/AS
623	2228 L, 2233 L, 2236 L/LS, 2238 L, 2428 L, 2433 L,3038 L

Stabilizer



Sampa Nr.

010.035

O.E.M. Nr.

000 323 34 85

Dimension

ø46xø70x62

Description

Stabilizer Plastic Bearing

BM	MODEL
387	1719, 1719 AK, 1719 S
389	1919, 1919 AK, 1919 K, 1919 S



Sampa Nr.

010.031

O.E.M. Nr.

387 323 02 85

Dimension

ø37xø70x62

Description

Stabilizer Plastic Bearing

BM	389	437	645	652	659
346	391	619	646	653	660
350	395	620	647	654	
371	397	621	648	655	
385	398	623	649	656	
387	427	624	650	657	
388	436	625	651	658	



Sampa Nr.

010.046

O.E.M. Nr.

000 323 09 50

Dimension

ø25xø35x28

Description

Stabilizer Bushing

BM	MODEL
395	2626 AB/ A /AK/ AS/B/K/S
336	2632
346	2632 A/AK
350	2632 AS/K
363	2632 S, LPK 2226/6X4 ...
385	2219 /6X2/4, 2219 L/6X2
387	1626 /AK , 1626 AS, 1719 S...



Sampa Nr.

010.050

O.E.M. Nr.

000 323 21 50

Dimension

ø32.5xø44x25

Description

Stabilizer Bushing

BM	389	437	625	653	699
346	391	615	646	654	737
350	393	616	648	655	
371	395	617	649	658	
385	397	619	650	659	
387	398	620	651	660	
388	436	621	652	684	



Sampa Nr.

010.517

O.E.M. Nr.

389 320 00 28

Dimension

Description

Stabilizer Bearing Kit

BM	MODEL
387	1719 /AK/K/S
389	1919 /AK/K/S



Sampa Nr.

010.531

O.E.M. Nr.

**620 320 03 28
(620 586 01 32)**

Dimension

Description

Stabilizer Bearing Kit

BM	MODEL
385	2219 L/6X2
619	2219 CL, 2220 L ...
653	2420 L, 2422 L ...

Sampa Nr.

010.030

O.E.M. Nr.

000 323 37 85



Dimension
ø37xø70x62

Description

Stabilizer Plastic Bearing

BM	MODEL	395	2626 S/K/A/AS
346	LS 1924,1928	395	2632 /S/K/AS/A
385	2219 L/6X2		
387	1626, 1632 AK ...		
389	1926 A, 1932 AK ...		
391	2026,2032 S/6X2/4		
393	2226 S/6X4, 2232 /6X2 ...		

Sampa Nr.

010.050

O.E.M. Nr.

000 323 21 50



Dimension
ø32.5xø44x25

Description

Stabilizer Bushing

BM	389	437	625	653	699
346	391	615	646	654	737
350	393	616	648	655	
371	395	617	649	658	
385	397	619	650	659	
387	398	620	651	660	
388	436	621	652	684	

Sampa Nr.

010.522

O.E.M. Nr.

**385 320 01 28
(385 586 04 32)**



Dimension

Description

Stabilizer Bearing Kit

BM	MODEL
385	2219 L/6X2

Sampa Nr.

010.046

O.E.M. Nr.

000 323 09 50



Dimension
ø25xø35x28

Description

Stabilizer Bushing

BM	MODEL
395	2626 AB/ A /AK/ AS/B/K/S
336	2632
346	2632 A/AK
350	2632 AS/K
363	2632 S, LPK 2226/6X4 ...
385	2219 /6X2/4, 2219 L/6X2

Sampa Nr.

010.519

O.E.M. Nr.

**387 320 00 28
(387 586 00 32)
(000 323 37 85 S)**



Dimension

Description

Stabilizer Bearing Kit

BM	MODEL
346	LS 1924,1928
387	1626 /AK/S, 1632 /AK/AS/S
389	1926/1932 /A/AS/AK/K/S
391	2026/2032 S/6X2/4
393	2226 S/6X4 ...
395	2626/2632 /A/AS/AK/K/S, 3332

Sampa Nr.

010.008

O.E.M. Nr.

941 323 03 50



Dimension
ø40xø52x24

Description

Stabilizer Bushing

BM	MODEL
950,952,953,954	ACTROS

Stabilizer



Sampa Nr.

010.039

O.E.M. Nr.

387 326 01 81

Dimension

ø50.5xø86x63

Description

Stabilizer Plastic Bearing

BM	MODEL
387	1626 L/LS, 1632 L/LS
389	1926 LS, 1932 LS
393	2226 L/6X2, 2226 LS/6X4, 2232 L/6X2, 2232 LS/6X4
620	1628 L/LS, 1633 L/LS, 1636 L/LS, 1733 L
621	1928 L, 1928 LS, 2028 LS/6X2/4 ...
623	2238, 2236 L/LS, 2428 L, 2433 L, 3038 L
625	3244, 3028 /K, 3235 AK/ K ...



Sampa Nr.

010.037

O.E.M. Nr.

000 326 16 81

Dimension

ø45xø86x63

Description

Stabilizer Plastic Bearing

BM	MODEL	387	1626, 1632
336	LPS 1924	389	1919 /AK/K/S
346	LS 1924	389	1926 /A/AK/AS/K/S
363	LP 2226/6X4 ...	389	1932 /A/AK/AS/K/S
387	1626 /AK/AS/K/ S	391	2026/2032 S/6X2/4
387	1632 /AK/AS/K/ S		
387	1719 /AK/K/S		



Sampa Nr.

010.048

O.E.M. Nr.

000 326 02 50

Dimension

ø32xø44x35

Description

Stabilizer Bushing

BM	MODEL
336	LPS 1924
346	LS 1924
363	LP 2226/6X4, LPB 2226/6X4...
387	1626, 1632 LS, 1719 AK ...
389	1919 AK, 1926 AK ...



Sampa Nr.

010.052

O.E.M. Nr.

000 326 06 50

Dimension

ø40.5xø52x25

Description

Stabilizer Bushing

BM	391	617	645	655
336	393	619	646	656
346	396	620	647	657
363	397	621	648	658
371	398	622	650	696
387	615	623	651	
389	616	625	652	



Sampa Nr.

010.518

O.E.M. Nr.

**387 320 04 28
(387 586 04 32)**

Dimension

Description

Stabilizer Bearing Kit

BM	MODEL
387	1626 L/LS, 1632 L/LS
389	1926 LS, 1932 LS
393	2226/2232 L/6X2, LS/6X4

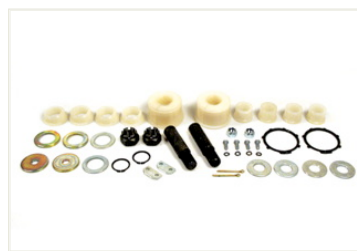

Sampa Nr.

010.523

O.E.M. Nr.

**387 320 01 28
(387 586 01 32)
(000 326 16 81 S)**

Dimension

Description

Stabilizer Bearing Kit

BM	MODEL
336	LPS 1924
346	LS 1924
363	LP 2226/6X4 ...
387	1626 / AK/AS/K/S ...
389	1919 /AK/K/S, 1926 ...
391	2026/2032 S/6X2/4

Sampa Nr.

010.038

O.E.M. Nr.

387 326 02 81



Dimension

ø45xø86x63

Description

Stabilizer Plastic Bearing

BM	391	620	647	657
336	397	621	648	658
346	398	622	650	
363	615	623	651	
371	616	625	652	
387	617	645	655	
389	619	646	656	

Sampa Nr.

010.040

O.E.M. Nr.

393 326 04 81



Dimension

ø56xø86x63

Description

Stabilizer Plastic Bearing

BM	MODEL
393	2226 S/6X4, 2226 /6X4, 2232 S/6X4, 2232 /6X4
396	OH 1416,1417, 1622, 1625,1628
397	2435 S/6X4
623	2233, 3028 B/K, 2236 S/LS ...
625	3235 /K, 3528 /B/K, 3253 ...
648	2235 S, 2244 /S/LS ...

Sampa Nr.

010.048

O.E.M. Nr.

000 326 02 50



Dimension

ø32xø44x35

Description

Stabilizer Bushing

BM	MODEL
336	LPS 1924
346	LS 1924
363	LP 2226/6X4, LPB 2226/6X4...
387	1626, 1632 LS, 1719 AK ...
389	1919 AK, 1926 AK ...
391	2026 S/6X2/4, 2032 S/6X2/4 ...
393	2226 S/6X4, 2232 /6X4 ...

Sampa Nr.

010.052

O.E.M. Nr.

000 326 06 50



Dimension

ø40.5xø52x25

Description

Stabilizer Bushing

BM	391	617	645	655
336	393	619	646	656
346	396	620	647	657
363	397	621	648	658
371	398	622	650	696
387	615	623	651	
389	616	625	652	

Sampa Nr.

010.524

O.E.M. Nr.

387 320 05 28

(387 586 05 32)



Dimension

Description

Stabilizer Bearing Kit

BM	MODEL
346	LS 1924
387	1626 / AK/AS/K/S, 1626 ...
389	1919 /AK/K/S, 1926 ...
391	2026 S/6X2/4, 2032 S/6X2/4

Sampa Nr.

010.527

O.E.M. Nr.

393 320 02 28

(393 586 03 32)



Dimension

Description

Stabilizer Bearing Kit

BM	MODEL
393	2226 /6X4, S/6X4
393	2232 /6X4, S/6X4

Stabilizer



Sampa Nr.

010.040

O.E.M. Nr.

393 326 04 81

Dimension

ø56xø86x63

Description

Stabilizer Plastic Bearing

BM	MODEL
393	2226 S/6X4, 2226 /6X4, 2232 S/6X4, 2232 /6X4
396	OH 1416,1417, 1622, 1625,1628
397	2435 S/6X4
623	2233, 3028 B/K, 2236 S/LS ...
625	3235 /K, 3528 /B/K, 3253 ...
648	2235 S, 2244 /S/LS ...



Sampa Nr.

010.049

O.E.M. Nr.

387 326 00 50

Dimension

ø32xø44x36.5

Description

Stabilizer Bushing

BM	MODEL	622	2028,2036,2038 LS/6X2/4
371	1922 K,1935 S/35 LS/35 ...	623	2233, 2228 S, 2236 L...
396	OH 1622, 1625,1628	625	3235, 3228 /KL...
397	1729 S, OH 1416 ...		
398	1926/4X2, 1926/AK 4X4		
620	1628 L, 1628 LS, 2233 S ...		
621	1922, 1933, 1925 AK...		



Sampa Nr.

010.052

O.E.M. Nr.

000 326 06 50

Dimension

ø40.5xø52x25

Description

Stabilizer Bushing

BM	391	617	645	655
336	393	619	646	656
346	396	620	647	657
363	397	621	648	658
371	398	622	650	696
387	615	623	651	
389	616	625	652	



Sampa Nr.

010.532

O.E.M. Nr.

**623 320 00 41
(623 586 00 32)**

Dimension

Description

Stabilizer Bearing Kit

BM	MODEL
396	OH 1416, 1417, 1622, 1625, 1628
623	2233, 2236, 2828 ...
625	3238/L, 3244, 3250
648	2235 /S, 3035, 3235 ...
658	2429, 2544, 3238 ...



Sampa Nr.

111.002

O.E.M. Nr.

**000 981 08 31
(000 981 12 31)**

Dimension

ø35xø55x20/25

Description

Ball Bearing for Stabilizer

BM	MODEL
341,344	LO 1114... / LS 1113...
345,351	OF 1313/1314 ... / LK 1514 ...
352,353	LAK 1313 ... / LS 911 B ...
358,360	LAS 1113 B ... / LAK 1513 ...
376,380	LS 1418 ... / 1017 S ...
381,382	1217 S ... / OH 1318 ...



Sampa Nr.

010.521

O.E.M. Nr.

**360 320 03 41
(360 586 03 32)**

Dimension

ø35xø55x20/25

Description

Stabilizer Bearing Kit

BM	MODEL
345	LK 1313, 1314, 1316 ...
351	OH 1314, 1318, 1418, 1526, 1522
352	LK 1313, LS 1313 ...
353	LS 911 B, LPK 810, 911 B ...
355	OF 1617, 1621
358	LS 1113 B, OF 1113 ...

Sampa Nr.

010.029

O.E.M. Nr.

625 323 00 85



Dimension

ø55xø70x62

Description

Stabilizer Plastic Bearing

BM	MODEL
625	3235/3535 AK
625	3538/3544 AK/K
625	3550/5038 AK
625	4844, 4850, 4853

Sampa Nr.

010.040

O.E.M. Nr.

393 326 04 81



Dimension

ø56xø86x63

Description

Stabilizer Plastic Bearing

BM	MODEL
393	2226 S/6X4, 2226 /6X4, 2232 S/6X4, 2232 /6X4
396	OH 1416,1417, 1622, 1625,1628
397	2435 S/6X4
623	2233, 3028 B/K, 2236 S/LS ...
625	3235 /K, 3528 /B/K, 3253 ...
648	2235 S, 2244 /S/LS ...

Sampa Nr.

010.052

O.E.M. Nr.

000 326 06 50



Dimension

ø40.5xø52x25

Description

Stabilizer Bushing

BM	391	617	645	655
336	393	619	646	656
346	396	620	647	657
363	397	621	648	658
371	398	622	650	696
387	615	623	651	
389	616	625	652	

Sampa Nr.

010.054

O.E.M. Nr.

620 323 01 50



Dimension

ø58.5xø70x19

Description

Stabilizer Bushing

BM	MODEL	646	1935 LS, 1944 LS...
620	1628 L, 1633 L ...	647	2035 LS/6X2/4
621	1928 L, 1933 LS ...	648	2235 L, 2244 L/LL, 3235 L
622	2028 LS/6X2/4 ...		
623	2228 L, 2233 L ...		
625	3235, 3238, 3244 ...		
645	1635 L, 1644 LS/L ...		

Sampa Nr.

010.547

O.E.M. Nr.

625 320 05 11



Dimension

Description

Stabilizer Bearing Kit

BM	MODEL
625	3538 AK/K, 3535 AK, 4844, 4850, 4853
625	3235 AK, 3538 AK, 3544 AK/K, 3550 AK, 5038 AK

Sampa Nr.

010.548

O.E.M. Nr.

625 320 07 11



Dimension

Description

Stabilizer Bearing Kit

BM	MODEL
625	3235, 3238, 3244, 3250, 3328
625	4850, 3028 /K, 3228 /K/L, 3235, 3235 /K
625	3238 /L, 3250, 3253, 3328 /K, 3528 /B/K
625	3528 /K, 3535 /B/K, 3535 /K, 3538,3538 AK/K
625	3544/K, 3544 S, 3548 K, 3550/K, 4435 K, 4844/K, 4853

Stabilizer



Sampa Nr.

010.044

O.E.M. Nr.

000 323 38 85

Dimension

ø32.5xø70x62

Description

Stabilizer Plastic Bearing

BM	MODEL
393	2226 L/6X2
393	2232 L/6X2



Sampa Nr.

010.033

O.E.M. Nr.

387 323 03 85

Dimension

ø41xø70x62

Description

Stabilizer Plastic Bearing

BM	395	617	650
352	397	619	651
355	427	621	658
385	436	623	684
387	437	624	
389	615	625	
393	616	648	



Sampa Nr.

010.046

O.E.M. Nr.

000 323 09 50

Dimension

ø25xø35x28

Description

Stabilizer Bushing

BM	MODEL
395	2626 AB/ A /AK/ AS/B/K/S
336	2632
346	2632 A/AK
350	2632 AS/K
363	2632 S, LPK 2226/6X4 ...
385	2219 /6X2/4, 2219 L/6X2
387	1626 /AK , 1626 AS, 1719 S...



Sampa Nr.

010.050

O.E.M. Nr.

000 323 21 50

Dimension

ø32.5xø44x25

Description

Stabilizer Bushing

BM	389	437	625	653	699
346	391	615	646	654	737
350	393	616	648	655	
371	395	617	649	658	
385	397	619	650	659	
387	398	620	651	660	
388	436	621	652	684	



Sampa Nr.

010.550

O.E.M. Nr.

**435 320 02 28
(435 586 00 32)**

Dimension

Description

Stabilizer Bearing Kit

BM	MODEL
393	2226 L/6X2, 2232 L/6X2



Sampa Nr.

010.632

O.E.M. Nr.

435 320 04 28

Dimension

Description

Stabilizer Bearing Kit

BM	MODEL
437	UNIMOG U 2400 TG
436	UNIMOG U 1700 L/38

Sampa Nr.

010.023

O.E.M. Nr.

000 326 17 81



Dimension

ø56xø86x63

Description

Stabilizer Plastic Bearing

BM	MODEL
393	2226 /6X4
393	2226 S/6X4
393	2232 /6X4
393	2232 S/6X4

Sampa Nr.

010.024

O.E.M. Nr.

000 326 15 81



Dimension

ø50.5xø86x63

Description

Stabilizer Plastic Bearing

BM	MODEL
387	1626 L/LS
387	1632 L/LS
393	2226 LS/6X4
393	2226 L/6X2
393	2232 LS/6X4
393	2232 L/6X2

Sampa Nr.

010.048

O.E.M. Nr.

000 326 02 50



Dimension

ø32xø44x35

Description

Stabilizer Bushing

BM	MODEL
336	LPS 1924
346	LS 1924
363	LP 2226/6X4, LPB 2226/6X4...
387	1626, 1632 LS, 1719 AK ...
389	1919 AK, 1926 AK ...
391	2026 S/6X2/4, 2032 S/6X2/4 ...
393	2226 S/6X4, 2232 /6X4 ...

Sampa Nr.

010.052

O.E.M. Nr.

000 326 06 50



Dimension

ø40.5xø52x25

Description

Stabilizer Bushing

BM	391	617	645	655
336	393	619	646	656
346	396	620	647	657
363	397	621	648	658
371	398	622	650	696
387	615	623	651	
389	616	625	652	

Sampa Nr.

010.588

O.E.M. Nr.

393 320 00 28



Dimension

Description

Stabilizer Bearing Kit

BM	MODEL
393	2226 /6X4, S/6X4
393	2232 /6X4, S/6X4

Sampa Nr.

010.586

O.E.M. Nr.

387 320 02 28
(387 586 02 32)



Dimension

Description

Stabilizer Bearing Kit

BM	MODEL
387	1626 L/LS, 1632 L/LS
389	1926 LS, 1932 LS
393	2226 L/6X2, LS/6X4
393	2232 L/6X2, LS/6X4

Stabilizer



Sampa Nr.

010.038

O.E.M. Nr.

387 326 02 81

Dimension

ø45xø86x63

Description

Stabilizer Plastic Bearing

BM	391	620	647	657
336	397	621	648	658
346	398	622	650	
363	615	623	651	
371	616	625	652	
387	617	645	655	
389	619	646	656	



Sampa Nr.

010.051

O.E.M. Nr.

617 326 00 50

Dimension

ø35xø55x19

Description

Stabilizer Bushing

BM	MODEL
371	1817 K/ 4X2/36 ...
397	1419 S
615	1214 A, 1217 CA ...
616	1414 K, 1417 CAK ...
617	1614 K, 1617 CAK ...
619	2219 C, 2222 ...



Sampa Nr.

010.052

O.E.M. Nr.

000 326 06 50

Dimension

ø40.5xø52x25

Description

Stabilizer Bushing

BM	391	617	645	655
336	393	619	646	656
346	396	620	647	657
363	397	621	648	658
371	398	622	650	696
387	615	623	651	
389	616	625	652	



Sampa Nr.

010.530

O.E.M. Nr.

617 320 02 28

Dimension

Description

Stabilizer Bearing Kit

BM	MODEL
371	1817 K/4X2/36 ...
397	1419 S
615	1214 A, 1217 CA ...
616	1414 K, 1417 CAK ...
617	1614 K, 1617 CAK ...
619	2222, 2025 S ...



Sampa Nr.

010.007

O.E.M. Nr.

941 326 03 50

Dimension

ø40xø65x46

Description

Stabilizer Plastic Bearing

BM	MODEL
950 / 952 / 953 / 954	ACTROS



Sampa Nr.

010.022

O.E.M. Nr.

360 323 01 51

Dimension

ø39.5xø65x22

Description

Stabilizer Plastic Bearing

BM	360	385
341	376	386
345	380	390
351	381	394
352	382	397
353	383	682
355	384	693

Sampa Nr.
010.042

O.E.M. Nr.
000 326 09 81



Dimension
ø45.5x70x70

Description
Stabilizer Plastic Bearing

BM	MODEL
336	LPS 1924
346	LS 1924
363	LP 2226/6X4, 2232/6X4
363	LPB 2226/6X4
363	LPK 2232/6X4
363	LPS 2226/6X4, 2232/6X4

Sampa Nr.
010.048

O.E.M. Nr.
000 326 02 50



Dimension
ø32xø44x35

Description
Stabilizer Bushing

BM	MODEL
336	LPS 1924
346	LS 1924
363	LP 2226/6X4, LPB 2226/6X4...
387	1626, 1632 LS, 1719 AK ...
389	1919 AK, 1926 AK ...
391	2026 S/6X2/4, 2032 S/6X2/4 ...
393	2226 S/6X4, 2232 /6X4 ...

Sampa Nr.
010.520

O.E.M. Nr.
346 320 01 28
(346 586 01 32)
(000 326 09 81 S)



Dimension

Description
Stabilizer Bearing Kit

BM	MODEL
336	LPS 1924
346	LS 1924, 1928
363	LP 2226/6X4 ...
389	1926/1932 /K/S
391	2026/2032 S/6X2/4
395	2626/3332 /B/K/S

Sampa Nr.
010.025

O.E.M. Nr.
000 323 32 85



Dimension
ø36.5x70x63.5

Description
Stabilizer Plastic Bearing

BM	MODEL	363	LPK 2232/6X4
336	LPS 1924	363	LPS 2226/6X4
346	LS 1924	363	LPS 2232/6X4
363	LP 2226/6X4		
363	LP 2232/6X4		
363	LPB 2226/6X4		
363	LPK 2226/6X4		

Sampa Nr.
010.046

O.E.M. Nr.
000 323 09 50



Dimension
ø25xø35x28

Description
Stabilizer Bushing

BM	MODEL
395	2626 AB/ A /AK/ AS/B/K/S
336	2632
346	2632 A/AK
350	2632 AS/K
363	2632 S, LPK 2226/6X4 ...
385	2219 /6X2/4, 2219 L/6X2
387	1626 /AK , 1626 AS, 1719 S...

Sampa Nr.
010.585

O.E.M. Nr.
363 320 02 28
(363 586 00 32)



Dimension

Description
Stabilizer Bearing Kit

BM	MODEL
336	LPS 1924
346	LS 1924
363	LP 2226/6X4, LPB 2226/6X4 ...
658	2429 L, 2434 L, 2435 L/LS, 3235 L

Stabilizer



Sampa Nr.

010.026

O.E.M. Nr.

000 326 08 81

Dimension

ø40.5x70x63.5

Description

Stabilizer Plastic Bearing

BM	MODEL
346	LS 1924
336	LPS 1924



Sampa Nr.

010.012

O.E.M. Nr.

318 321 00 85

Dimension

ø25.5x35x37.5

Description

Stabilizer Plastic Bearing

BM	MODEL	318	LP 811,813, 913, 1013
314	LPL 608,709	318	LPC 811,813
314	LPLS 608,709	318	LPK 811,813, 913, 1013
316	LP 808,809	318	LPL 813, 913, 1013
316	LPK 808,809	318	LPLS 813
316	LPKF 808,809	684	508 I
316	LPL 808,809		
316	LPO 808,809		



Sampa Nr.

010.046

O.E.M. Nr.

000 323 09 50

Dimension

ø25xø35x28

Description

Stabilizer Bushing

BM	MODEL
395	2626 AB/ A /AK/ AS/B/K/S
336	2632
346	2632 A/AK
350	2632 AS/K
363	2632 S, LPK 2226/6X4 ...
385	2219 /6X2/4, 2219 L/6X2
387	1626 /AK , 1626 AS, 1719 S...



Sampa Nr.

010.013

O.E.M. Nr.

314 323 02 85

Dimension

ø27.5x54.5

Description

Stabilizer Plastic Bearing

BM	MODEL
314	LPK 608,709
314	LPKF 608,709
314	LPKO 608,709
314	LPO 608,709
314	LPS 608,709



Sampa Nr.

010.589

O.E.M. Nr.

**346 320 00 28
(346 586 00 32)**

Dimension

Description

Stabilizer Bearing Kit

BM	MODEL
336	LPS 1924
346	LS 1924



Sampa Nr.

010.014

O.E.M. Nr.

316 323 01 85

Dimension

ø29x36x38

Description

Stabilizer Plastic Bearing

BM	MODEL	314	LPO 608,709
314	LP 608,709	314	LPS 608,709
314	LPK 608,709	316	LP 808,809
314	LPKF 608,709	316	LPK 808,809
314	LPKO 608,709	316	LPKF 808,809
314	LPKO 608,709	316	LPLS 608,709, 808,809
314	LPL 608,709, 808,809		

Sampa Nr.

010.033

O.E.M. Nr.

387 323 03 85



Dimension

ø41xø70x62

Description

Stabilizer Plastic Bearing

BM	395	617	650
352	397	619	651
355	427	621	658
385	436	623	684
387	437	624	
389	615	625	
393	616	648	

Sampa Nr.

010.512

O.E.M. Nr.

617 320 01 28



Dimension

Description

Stabilizer Bearing Kit

BM	MODEL
352	OF 1313, 1317, 1413, 1417
355	OF 1617, 1621
385	2219/6X2/4
397	2219 6X4 ...
615	1222 / L, 1429 F, 1428 F, F/S, 1228 F
616	1414, 1417 C/CS ...

Sampa Nr.

010.036

O.E.M. Nr.

617 323 00 85



Dimension

ø51xø70x62

Description

Stabilizer Plastic Bearing

BM	MODEL
625	3025, 3025 K
625	3028
625	3228 B, 3228 /K
625	3233 /B

Sampa Nr.

010.513

O.E.M. Nr.

617 320 06 11



Dimension

Description

Stabilizer Bearing Kit

BM	MODEL
625	3025 /K, 3028, 3228 /B/K , 3233 /B

Sampa Nr.

111.001

O.E.M. Nr.

000 981 72 31

(000 981 73 31)

(000 981 09 31)



Dimension

ø20xø35x12/16

Description

Ball Bearing for Stabilizer

BM				
360	360	387	619	647
330	376	389	620	648
334	386	390	621	682
341	380	393	622	684
345	381	395	623	747

Sampa Nr.

O.E.M. Nr.

Description

Stabilizer



Sampa Nr.

010.038

O.E.M. Nr.

387 326 02 81

Dimension

ø45xø86x63

Description

Stabilizer Plastic Bearing

BM	391	620	647	657
336	397	621	648	658
346	398	622	650	
363	615	623	651	
371	616	625	652	
387	617	645	655	
389	619	646	656	



Sampa Nr.

010.052

O.E.M. Nr.

000 326 06 50

Dimension

ø40.5xø52x25

Description

Stabilizer Bushing

BM	391	617	645	655
336	393	619	646	656
346	396	620	647	657
363	397	621	648	658
371	398	622	650	696
387	615	623	651	
389	616	625	652	



Sampa Nr.

111.002

O.E.M. Nr.

**000 981 08 31
(000 981 12 31)**

Dimension

ø35xø55x20/25

Description

Ball Bearing for Stabilizer

BM	MODEL
341,344	LO 1114... / LS 1113...
345,351	OF 1313/1314 ... / LK 1514 ...
352,353	LAK 1313 ... / LS 911 B ...
358,360	LAS 1113 B ... / LAK 1513 ...
376,380	LS 1418 ... / 1017 S ...
381,382	1217 S ... / OH 1318 ...



Sampa Nr.

010.529

O.E.M. Nr.

617 320 00 28

Dimension

Description

Stabilizer Bearing Kit

BM	MODEL
397	1419 S
615	1214 A, 1217 CA, 1222 A ...
616	1414 K, 1417 CAK ...
617	1614 K, 1617 CAK ...
619	2219 C, 2220 ...

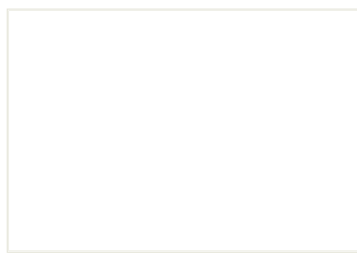

Sampa Nr.

O.E.M. Nr.

Dimension

Description

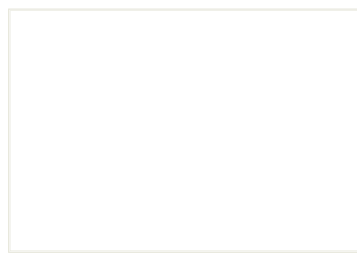

Sampa Nr.

O.E.M. Nr.

Dimension

Description

Sampa Nr.

111.005

O.E.M. Nr.

000 981 60 31



Dimension

ø42xø62x20/25

Description

Ball Bearing for Brake

BM	MODEL	745	HL 4/01 D-10/41:7 ...
349	L 1921, LK 1921	746	HL 4/01D-10/41:7 ...
731	AL 3/40 D-6	747	HL 7/26 D-12,3/5,9 ...
733	AL 3/040D-6 ...	748	HL 7/052 DS - 11.5 ...
740	HD 7/19 DGS-13 ...	748	HL 7/052 DS - 13 ...
741	HO 4/01 DL-10/40:12 ...	749	NR 4/22 D-10 ...
742	HH 4/07DL-10/44:12 ...		
744	HH 4/12D-10/39:8 ...		

Sampa Nr.

010.592

O.E.M. Nr.

360 420 03 41
(360 586 03 42)



Dimension

ø42xø62x20/25

Description

Rep. Kit for Camshaft

BM	MODEL		
740	HD 7/014 DG-16 ...		
744	HD 4/21 DG-10 ...		
745	HL 4/01 D-10 ...		
746	HO 4/01 D-10/41:7...		
748	HL 7/015 D-13 ...		
749	NR 7/4 DL-10, 7/5 DL-		

Sampa Nr.

010.593

O.E.M. Nr.

360 420 04 41
(360 586 04 42)



Dimension

ø42xø62x20/25

Description

Rep. Kit for Camshaft

BM	MODEL	745	HL 4/01 DL-10 ...
699	LU 1720 ...	746	HL 7/18 D-13/29:24 ...
731	AL 3/7 D-4,3 ...	748	HL 7/015 DS-13/5. 46 ...
740	HL 7/1 D-10 ...	748	HL 7/07 DL-10 ...
744	HO 4/10 DL-10 ...	749	NR 7/5 DL-10 ...
744	HD 4/22DS-10/39:8 ...		
745	HL 4/06 DS-12/5,22 ...		

Sampa Nr.

010.691

O.E.M. Nr.

305 421 07 50 S



Dimension

ø42

Description

Rep. Kit for Camshaft

Sampa Nr.

010.598

O.E.M. Nr.

335 420 00 39



Dimension

ø20

Description

Rep. Kit for Brake Shoe

BM	MODEL		
336	LP 1924, LPS 1924		
343	L 2624/6X4 / LAK 2624/6X6 ...		
346	L 1924, LA 1924 ...		
349	L 1621 / LK 1621 / LS 1621,1624		
355	OF 1617		
363	LP 2226/6X4 / LPS 2226/6X4 ...		

Sampa Nr.

010.599

O.E.M. Nr.

307 420 03 39



Dimension

ø20

Description

Rep. Kit for Brake Shoe

BM	MODEL	744	HL 4/17 D-9.2 ...
349	L 1921, LK 1921	745	HD 4/02 DG-10 ...
699	LU 1720, 1920, 1921, 1924	746	HL 7/015 D-13/28:21 ...
730	VL 3/8D-6,5 ...	747	HL 7/26 D-12,3/5,9 ...
731	AL 3/6 DS-6 ...	748	HO 7/02 DLM-10 ...
733	VO 4/34 DL-7 ...	748	HD7/016DGS-13/4.27 ...
739	VL 4/31 DL-7,5 ...	749	NR 4/10 DL-6 ...
740	HL 7/24 DS-9 ...		
743	HL 4/60D-7,6/43:7 ...		

Brake



Sampa Nr.

116.015

O.E.M. Nr.

674 421 00 50

Dimension

ø30xø34x48

Description

Brake Shoe Bushing

BM	MODEL	741	HD 4/02 DG-10/41:7 ...
730	VL 3/11 D-4,4 ...	742	HH 4/07DL-10/44:12 ...
731	AL 3/40 D-6 ...	743	HH 4/12 D-10 ...
732	VL 3/7 D-5 ...	744	HL 4/35 D-7,8 ...
733	AL 4/5D-4,3/48:7 ...	745	HH 4/05 D-10/38:8 ...
739	VO 4/13 DL-7 ...	746	HL 4/060 D-10 ...
740	HL 7/057DS-13 ...		



Sampa Nr.

010.682

O.E.M. Nr.

376 420 00 39

Dimension

ø20

Description

Rep. Kit for Brake Shoe

BM	MODEL	745	HH 4/05 D-10/38:8 ...
730	AD 7/52 DG-9 ...	746	HD 7/016 DG-13/28:21 ...
731	AL 7/1 DS-7 ...	748	HD 7/016DGS-13/27:18 ...
733	AL 3/040 D-6 ...	749	NR 4/30 DC-10 ...
740	HL 7/013 D-16 ...		
742	HH 4/07 DL-10/41:7 ...		
743	HH 4/12D-10/39:8 ...		



Sampa Nr.

010.595

O.E.M. Nr.

675 420 00 82

Dimension

ø30x102

Description

Rep. Kit for Brake Shoe

BM	MODEL		
730	VL 2/11 D-3.8 ...		
742	HL 2/14 D-6. 9		
731	AL 3/40 D-4.7 ...		
744	HL 4/28 D-7. 8 ...		
745	HL 4/035 D-10.6 ...		
770	HL 4/40 D-7, HL 4/40 DS-7.7		
771	HL 4 / 012 DS -11 ...		



Sampa Nr.

010.594

O.E.M. Nr.

318 420 01 82

Dimension

ø28x82

Description

Rep. Kit for Brake Shoe

BM	MODEL		
730	VL 2/10 D-3.5 ...		
742	HL 2/12 D-4.5 ...		
744	HL 4/30 D-6. 4 ...		



Sampa Nr.

010.597

O.E.M. Nr.

307 420 41 02

Dimension

ø30x102

Description

Rep. Kit for Brake Shoe

BM	MODEL	740	HD 7/2 DG-10 ...
699	LU 1720 ...	744	HL 4/16 L-7.7 ...
730	VL 3/6 - 4,1 ...	745	HL 5/2 D2-10/43:7 ...
731	AL 7/1 D-7 ...	746	HD 7/19 DGS-13/28:21
733	AL 3/040D-6 ...	749	NR 4/11 DL-7,5 ...
737	AT 4/IS-7,0 ...		
739	VL 4/27 D-7,5 ...		



Sampa Nr.

010.596

O.E.M. Nr.

395 420 00 41

Dimension

ø30x94

Description

Rep. Kit for Brake Shoe

BM	MODEL	739	VD 4/14 DL-7 ...
352	OF 1413,1417	740	HD 7/014 DG-16 ...
353	LT 911 B	744	HL 4/8-10
360	L 1513, LA 1513 ...	745	HL 5/1 S-10 ...
730	VL 3/4-5	746	HD 7/18 D-13/4.33 ...
731	AL 3/2-5, 3/2-5/41:6 ...	747	HT 4/1 S-7.9
733	VO 3/5-5		
737	AT 4/IS-7.0		

Sampa Nr.

010.600

O.E.M. Nr.

307 420 40 02
(395 420 00 82)



Dimension

ø30x102

Description

Rep. Kit for Brake Shoe

BM	MODEL
349	L 1921, LK 1921
699	LU 1720, 1920, 1921, 1924
730	VL 2/7-3,6 / VO 3/9 L-5 ...
731	AD 7/13 D-9/4,637 / AL 3/6 D-6 ...
733	VL 3/7 D - 5 / VO 3/10 D-6 ...
737	AT 4/1S-7,0...

Sampa Nr.

100.089

O.E.M. Nr.

617 993 11 10
(617 993 06 10)
(346 993 02 10)
(346 993 02 19)



Dimension

ø26x243

Description

Brake Shoe Spring

BM	MODEL
349	L/LK 1921
699	LU 1720, 1920, 1921, 1924
730	VL 3/8 D-6,5 ...
731	AL 7/5 D-7 ...
732	VL 3/6 D-4,1 ...
733	AL 7/1 DS 7/27:18 ...

Sampa Nr.

100.090

O.E.M. Nr.

346 993 03 10



Dimension

ø26x242

Description

Brake Shoe Spring

BM	MODEL	740	HD 7/2 DG-10 ...
349	L/LK 1921	743	HL 4/27 D-10/42:8 ...
730	VO 3/10 DL-6 ...	744	HH 4/12D-10/40:7 ...
731	AL 7/12 D-9 ...		
732	VL 3/7 D-5 ...		
733	AL 4/5 D 4,3 48:7		
739	VL 4/10 D-7		

Sampa Nr.

100.091

O.E.M. Nr.

673 993 04 10
(673 993 02 10)



Dimension

ø25x66

Description

Brake Shoe Spring

BM	MODEL	744	HL 4/35 D-6, 4
730	VL 2/10 D-3.5	744	HL 4/30 DS-6, 4
730	VL 2/12 D-3.8	744	HL 4/30 D-6, 4
730	VL 2/9 D-3,1		
742	HL 2/12 D-4.5		
742	HL 2/11 D-5.8		
742	HL 2/13 D-6, 4		

Sampa Nr.

100.092

O.E.M. Nr.

302 993 06 10
(341 423 00 92)



Dimension

ø33x245

Description

Brake Shoe Spring

BM	MODEL
321	O 362
338	LPS 1418
341	L 1112, LS 1112, O 355 ...
345	L 1313, 1314, 1316 ...
352	L/LK/LS/LKO 1313, OF 1413 ...
353	L 911 B, LP 810, 911 B ...

Sampa Nr.

100.093

O.E.M. Nr.

326 993 00 10

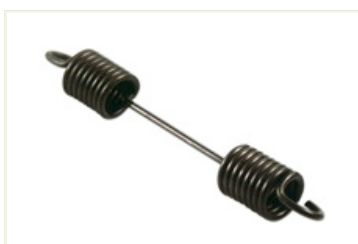

Dimension

ø35x240

Description

Brake Shoe Spring

BM	MODEL
336	LP/LPS 1924
343	L 2624/6X4 ...
346	L/LA/LAK/LK/LS 1924
349	L/LK/LS 1621
745	HD 6/3 DG-10/7,35 ...

Brake



Sampa Nr.
100.094

O.E.M. Nr.
317 993 10 10

Dimension
ø36x207

Description
Brake Shoe Spring

BM	MODEL
317	O 317 FH : 317.201 ...
355	OF 1617, 1621
363	LP 2226/6X4, LPB 2226/6X4 ...



Sampa Nr.
100.098

O.E.M. Nr.
335 421 01 92

Dimension
ø35x225

Description
Brake Shoe Spring

BM	MODEL	739	VL 4/2 D-7
336	LP/LPS 1924	749	NS 4/10 D-6, NR 4/10 DL-6
343	L 2624/6X4 ...		
346	L/LK/LS 1924		
349	L/LK/LS1921, LS 1624		
355	OF 1617		
363	LP/LPB/LPK/LPS 2226/6X4		



Sampa Nr.
100.095

O.E.M. Nr.
352 421 01 92
(341 421 00 92)

Dimension
ø37x255

Description
Brake Shoe Spring

BM	MODEL
321	O 362
338	LS/ LPS 1418
341	L 1112, LO 1112, LS 1112 ...
344	O 355
345	L 1313, 1314, 1316 ...
352	L 1313, LK 1313, OF 1317 ...



Sampa Nr.
100.099

O.E.M. Nr.
677 993 03 10
(677 993 02 10)

Dimension
ø30x95

Description
Brake Shoe Spring

BM	MODEL
730	VL 2/11 D-3.8 ...
731	AL 3/40 D-4.7 ...
742	HL 2/14 D-6.9 ...
744	HL 4/28 D-7.8 ...
745	HL 4/035 D-10,6 ...
770	HL 4/40 D-7 ...
771	HL 4/40 D-10,8 ...



Sampa Nr.
100.097

O.E.M. Nr.
346 993 08 10

Dimension
ø30x229

Description
Brake Shoe Spring

BM	MODEL	733	AL 7/1 DS 7/27:18 ...
349	L/LK 1921	739	VL 4/10 D-7 ...
699	LU 1720,1920,1921,1924		
730	AD 7/52 DG - 9 ...		
731	AD 1/9 DG-8 ...		



Sampa Nr.
100.100

O.E.M. Nr.
314 993 08 10

Dimension
ø22x192

Description
Brake Shoe Spring

BM	MODEL
314	LPS 608,709 ...
316	LP 808,809 ...
318	LP 811, 813 ...
742	HL 2/2 L-4,8 ...

Sampa Nr.

100.101

O.E.M. Nr.

314 993 11 10
(314 993 07 10)

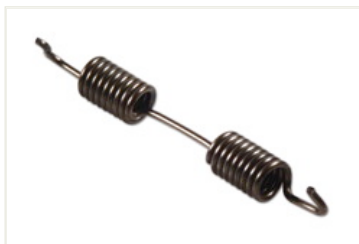

Dimension

ø23x182

Description

Brake Shoe Spring

BM	MODEL
314	LP 608,709 ...
316	LP 808,809 ...
318	LP 811, 813 ...
730	VL 2/5-2,2 ...

Sampa Nr.

100.102

O.E.M. Nr.

945 421 00 74
(346 421 06 74)



Dimension

ø12x72

Description

Brake Shoe Spring Pin

BM	MODEL
349	L/LK 1921
699	1720, 1920, 1921, 1924
730	AD 7/52 DG - 9 ...
731	AD 1/9 DG-8 ...
732	VL 3/18 DL-5,3 ...
733	VL 4/10 D-7 ...

Sampa Nr.

100.103

O.E.M. Nr.

658 421 00 74
(387 421 00 74)



Dimension

ø12x97

Description

Brake Shoe Spring Pin

BM	740	748
699	743	749
730	744	
731	745	
732	745	
733	746	
739	747	

Sampa Nr.

100.088

O.E.M. Nr.

659 420 16 44
(659 420 17 44)



Dimension

ø225xø452x53

Description

Dust Cover

BM	MODEL
746	HD 7/19 DG-13 ...
743	HH 4/12D-10/39:8 ..
744	HO 4/10 DL-10
745	HO 5/8 DL-10 ...
746	HO 5/8 DZ-10/39:8 ...
747	HL 7/26 D-12,3/5,9

Sampa Nr.

010.630

O.E.M. Nr.

322 426 01 83 S



Dimension

Description

Rep. Kit for Camshaft

Sampa Nr.

010.631

O.E.M. Nr.

302 420 00 67
(302 586 01 42)



Dimension

Description

Rep. Kit for Camshaft

BM	MODEL
338	LS 1418, LPS 1418
352	L 1313, LK 1313 ...
353	L 911 B, LK 911 B, LF 911 B ...
358	L 1113 B, LK 1113 B, OF 1113 ...
360	L 1513, LK 1513, LKO 1513 ...

Brake



Sampa Nr.

095.509

O.E.M. Nr.

MCK-1171/N

Dimension

Description

Rep. Kit for Brake Caliper

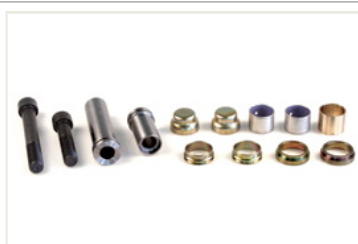

Sampa Nr.

095.510

O.E.M. Nr.

MCK-1102/N

Dimension

Description

Rep. Kit for Brake Caliper



Sampa Nr.

095.511

O.E.M. Nr.

MCK 1253

Dimension

Description

Rep. Kit for Brake Caliper



Sampa Nr.

095.512

O.E.M. Nr.

MCK 1254

Dimension

Description

Rep. Kit for Brake Caliper



Sampa Nr.

095.513

O.E.M. Nr.

MCK 1139

Dimension

Description

Rep. Kit for Brake Caliper



Sampa Nr.

095.514

O.E.M. Nr.

MCK 1238

Dimension

Description

Rep. Kit for Brake Caliper



Sampa Nr.

095.515

O.E.M. Nr.

MCK 1171

Dimension

Description

Rep. Kit for Brake Caliper



Sampa Nr.

095.516

O.E.M. Nr.

MCK 1192

Dimension

Description

Rep. Kit for Brake Caliper

<i>Sampa Nr.</i>	
095.524	
<i>O.E.M. Nr.</i> K 001300	
<i>Dimension</i>	
<i>Description</i>	
Rep. Kit for Brake Caliper	

<i>Sampa Nr.</i>	
095.572	
<i>O.E.M. Nr.</i> K 010603	
<i>Dimension</i>	
<i>Description</i>	
Rep. Kit for Brake Caliper	

<i>Sampa Nr.</i>	
095.573	
<i>O.E.M. Nr.</i> K 010604	
<i>Dimension</i>	
<i>Description</i>	
Rep. Kit for Brake Caliper	

<i>Sampa Nr.</i>	
095.581	
<i>O.E.M. Nr.</i> K 000944	
<i>Dimension</i>	
<i>Description</i>	
Rep. Kit for Brake Caliper	

<i>Sampa Nr.</i>	
095.521	
<i>O.E.M. Nr.</i> II 304130065	
<i>Dimension</i>	
<i>Description</i>	
Rep. Kit for Brake Caliper	

<i>Sampa Nr.</i>	
095.519	
<i>O.E.M. Nr.</i> K 000696	
<i>Dimension</i>	
<i>Description</i>	
Rep. Kit for Brake Caliper	

<i>Sampa Nr.</i>	
095.520	
<i>O.E.M. Nr.</i> K 000687	
<i>Dimension</i>	
<i>Description</i>	
Rep. Kit for Brake Caliper	

<i>Sampa Nr.</i>	
095.525	
<i>O.E.M. Nr.</i> II 358510062	
<i>Dimension</i>	
<i>Description</i>	
Rep. Kit for Brake Caliper	

Brake



Sampa Nr.

095.530

O.E.M. Nr.

K 001274

Dimension

Description

Rep. Kit for Brake Caliper



Sampa Nr.

095.531

O.E.M. Nr.

K 000375

Dimension

Description

Rep. Kit for Brake Caliper



Sampa Nr.

095.533

O.E.M. Nr.

**II 339680062
(II 328090062)
(II 369100062)**

Dimension

Description

Rep. Kit for Brake Caliper



Sampa Nr.

095.568

O.E.M. Nr.

K 000472

Dimension

Description

Rep. Kit for Brake Caliper



Sampa Nr.

095.569

O.E.M. Nr.

K 001925

Dimension

Description

Rep. Kit for Brake Caliper



Sampa Nr.

095.570

O.E.M. Nr.

K 001532

Dimension

Description

Rep. Kit for Brake Caliper



Sampa Nr.

095.526

O.E.M. Nr.

93161192

Dimension

Description

Rep. Kit for Brake Caliper



Sampa Nr.

095.518

O.E.M. Nr.

II 368470064

Dimension

Description

Rep. Kit for Brake Caliper

Sampa Nr.
095.527
O.E.M. Nr.
II 197140062



Dimension

Description
Rep. Kit for Brake Caliper

Sampa Nr.
095.528
O.E.M. Nr.
II 179320062



Dimension

Description
Rep. Kit for Brake Caliper

Sampa Nr.
095.529
O.E.M. Nr.
II 197330062



Dimension

Description
Rep. Kit for Brake Caliper

Sampa Nr.
095.522
O.E.M. Nr.
II 39769F0063



Dimension

Description
Rep. Kit for Brake Caliper

Sampa Nr.
095.571
O.E.M. Nr.
K 001301



Dimension

Description
Rep. Kit for Brake Caliper

Sampa Nr.
095.523
O.E.M. Nr.
K 000945



Dimension

Description
Rep. Kit for Brake Caliper

Sampa Nr.
095.567
O.E.M. Nr.
K 000029

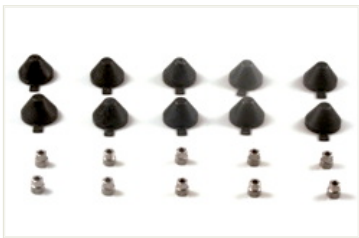

Dimension

Description
Rep. Kit for Brake Caliper

Sampa Nr.

O.E.M. Nr.

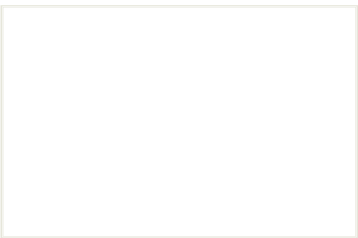

Dimension

Description

DIAPHRAGMS



Sampa Nr.
095.101

O.E.M. Nr.
897 120 492.4

Type 9" Short

Description
Short Stroke



Sampa Nr.
095.103

O.E.M. Nr.
897 120 505.4

Type 12" Short

Description
Short Stroke



Sampa Nr.
095.105

O.E.M. Nr.
897 120 510.4
(000 421 29 86)

Type 16" Short

Description
Short Stroke



Sampa Nr.
095.106

O.E.M. Nr.
897 120 520.4
(000 431 07 28)

Type 20" Short

Description
Short Stroke



Sampa Nr.
095.107

O.E.M. Nr.
897 120 530.4
(000 421 20 86)

Type 24" Short

Description
Short Stroke



Sampa Nr.
095.108

O.E.M. Nr.
897 120 540.4
(000 423 12 86)

Type 30" Short

Description
Short Stroke



Sampa Nr.
095.109

O.E.M. Nr.
897 120 550.4

Type 36" Short

Description
Short Stroke



Sampa Nr.
095.110

O.E.M. Nr.
897 120 516.4
(000 431 20 28)

Type 16" Long

Description
Long Stroke



Sampa Nr.
095.111

O.E.M. Nr.
897 120 526.4

Type 20" Long

Description
Long Stroke



Sampa Nr.
095.112

O.E.M. Nr.
897 120 536.4
(000 423 34 86)
(000 431 34 86)

Type 24" Long

Description
Long Stroke



Sampa Nr.
095.113

O.E.M. Nr.
897 120 546.4

Type 30" Long

Description
Long Stroke

Sampa Nr.

100.033

O.E.M. Nr.

346 356 14 15
(346 356 03 15)



Dimension

ø115xø145x32

Description

Thrust Washer, No Hardening

BM	MODEL
349	L/LK 1921
740	HD 7/016 DG-13 ...
748	HD 7/050 DCGS -16 ...

Sampa Nr.

100.033/1

O.E.M. Nr.

346 356 14 15 S
(346 356 03 15 S)



Dimension

ø115xø145x32

Description

Thrust Washer, Surface Hardened

BM	MODEL
349	L/LK 1921
740	HD 7/016 DG-13 ...
748	HD 7/050 DCGS -16 ...

Sampa Nr.

100.035

O.E.M. Nr.

355 356 09 15
(355 356 12 15)



Dimension

ø110xø145x32

Description

Thrust Washer, No Hardening

BM	MODEL
699	LU 1720, 1920, 1921, 1924
740	HD 7/2 DG-10 ...
748	HL 7/050 DCS- 11.5 ...
749	NR 7/4 DL-10 ...

Sampa Nr.

100.035/1

O.E.M. Nr.

355 356 09 15 S
(355 356 12 15 S)



Dimension

ø110xø145x32

Description

Thrust Washer, Surface Hardened

BM	MODEL
699	LU 1720, 1920, 1921, 1924
740	HD 7/2 DG-10 ...
748	HL 7/050 DCS- 11.5 ...
749	NR 7/4 DL-10 ...

Sampa Nr.

010.629

O.E.M. Nr.

601 330 04 19



Dimension

ø23x131.5

Description

King Pin Set

BM	MODEL
730	VL 0/1 C -1,3
730	VL 0/2 C -1,5

Sampa Nr.

010.637

O.E.M. Nr.

601 330 00 19
(601 586 50 33)
(601 332 53 06 S)



Dimension

ø23x131.5

Description

King Pin Set

BM	MODEL
730	VL 0/1 C -1,3
730	VL 0/2 C -1,5

Wheel - Axle



Sampa Nr.

010.638

O.E.M. Nr.

**670 330 01 19
(675 330 01 19)**

Dimension

ø30x186

Description

King Pin Set

BM	MODEL
730	VL 2/13 C-2,9
730	VL 2/14 C-2,9
730	VL 2/9 D-3,1
733	VL 2/13 C-2,9
733	VL 2/15 DC - 3,2
733	VL 2/16 DC - 3,2



Sampa Nr.

010.639

O.E.M. Nr.

601 330 03 19

Dimension

ø40xø70x46,5

Description

King Pin Set

BM	MODEL
730	VL 0/1 C -1,3
730	VL 0/2 C -1,5



Sampa Nr.

010.640

O.E.M. Nr.

**675 330 14 19
(675 330 02 19)**

Dimension

ø33x186

Description

King Pin Set

BM	MODEL
730	VL 2/10 D-3,5
730	VL 2/11 D-3,8
730	VL 2/12 D-3,8
730	VL 2/17 D-3,5



Sampa Nr.

010.641

O.E.M. Nr.

611 330 04 19

Dimension

ø26x136

Description

King Pin Set

BM	MODEL
730	VL 0/3 C-1,7
730	VL 0/5 C-1,7
730	VL 0/9 DC-1,8



Sampa Nr.

010.642

O.E.M. Nr.

**675 330 19 19
(675 330 05 19)**

Dimension

ø38x217

Description

King Pin Set

BM	MODEL	730	VL 3/7 -5
730	VL 3/11 D-4,4	730	VO 3/9 L-5
730	VL 3/12 D-5,3	730	VO 3/9 DL-5
730	VL 3/6 D-4,1	730	VO 3/9 L-5
730	VL 3/6 -4,1		
730	VL 3/6 D-4,1		
730	VL 3/7 D-5		



Sampa Nr.

010.643

O.E.M. Nr.

**675 330 18 19
(675 330 04 19)**

Dimension

ø38x217

Description

King Pin Set

BM	MODEL	730	VL 3/7-5
730	VL 3/7 D-5	730	VO 3/9 DL-5
730	VL 3/11 D-4,4	730	VO 3/9 L-5
730	VL 3/12 D-5,3		
730	VL 3/6 D-4,1		
730	VL 3/6-4,1		
730	VL 3/7 D-5		

Sampa Nr.

010.644

O.E.M. Nr.

310 330 00 19
(310 330 05 19)
(310 586 03 33)



Dimension
 ø27x153

Description

King Pin Set

BM	MODEL
730	VL 1/3-2,1
730	VL 1/4-1,6
730	VL 1/5-2,3
730	VL 1/6-2,3
730	VL 1/7-2,6

Sampa Nr.

010.645

O.E.M. Nr.

670 330 02 19
(675 330 00 19)



Dimension
 ø30x186

Description

King Pin Set

BM	MODEL
730	VL 2/13 C-2,9
730	VL 2/9 D-3,1
730	VL 2/14 C - 2,9
733	VL 2/15 DC - 3,2
733	VL 2/16 DC - 3,2
733	VL 2/13 C-2,9

Sampa Nr.

010.646

O.E.M. Nr.

360 330 06 19
(360 586 00 33)



Dimension
 ø38x217

Description

King Pin Set

BM	MODEL	732	VL 3/6 D-4,1
730	VL 3/6 - 4,1	732	VL 3/6 -4,1
730	VL 3/6 D-4,1	732	VL 3/7
730	VL 3/7 D-5	732	VL 3/7 D-5
730	VL 3/7-5		
730	VO 3/9 L-5		
730	VO 3/9 DL-5		

Sampa Nr.

010.647

O.E.M. Nr.

675 330 15 19
(675 330 03 19)



Dimension
 ø33x186

Description

King Pin Set

BM	MODEL
730	VL 2/10 D-3,5
730	VL 2/11 D-3,8
730	VL 2/12 D-3,8
730	VL 2/17 D-3,5

Sampa Nr.

010.648

O.E.M. Nr.

360 330 07 19
(360 586 02 33)



Dimension
 ø36.6x211

Description

King Pin Set

BM	MODEL
352	L 1313, 1813/6X2 ...
358	L 1113 B, LF 1113 B ...
360	L 1513 ,LK 1513
730	VL 3/1-3,8 , VL 3/4-5
732	VL 3/4-5, VL 3/D-5, VO 3-4,5
733	VO 3/5-5

Sampa Nr.

010.649

O.E.M. Nr.

355 330 03 19
(355 586 00 33)



Dimension
 ø45x218

Description

King Pin Set

BM	MODEL
730	VL 3/8 D-6,5
730	VL 3/8-6,5
730	VO 3/10 DL-6

Wheel - Axle



Sampa Nr.

010.650

O.E.M. Nr.

**310 330 03 19
(310 586 01 33)**

Dimension

ø26x154

Description

King Pin Set

BM	MODEL
730	VL 1/3-2,1
730	VL 1/4-1,6
730	VL 1/5-2,3



Sampa Nr.

010.651

O.E.M. Nr.

655 330 00 19

Dimension

ø50xø78x22

Description

King Pin Set

BM	MODEL
733	VO 4/13 D(L)-7
739	VD 4/26 DL-7.5 ...



Sampa Nr.

010.652

O.E.M. Nr.

611 330 03 19

Dimension

ø26x136

Description

King Pin Set

BM	MODEL
730	VL O/9 DC-1,8
730	VL O/3 C-1,7



Sampa Nr.

010.653

O.E.M. Nr.

611 330 00 19

Dimension

ø26x136

Description

King Pin Set

BM	MODEL
730	VL O/3 C-1,7
730	VL O/5 C-1,7



Sampa Nr.

010.654

O.E.M. Nr.

300 330 00 19

Dimension

ø50/ø51x223

Description

King Pin Set

BM	MODEL
733	VO 4/13 D(L)-7
739	VD 4/26 DL-7,5 ...



Sampa Nr.

010.655

O.E.M. Nr.

**391 330 00 19
(389 586 00 33)
(391 586 00 33)**

Dimension

ø50/ø51x223

Description

King Pin Set

BM	MODEL
349	L 1921, LK 1921
699	LU 1720
733	VL 4/15 D-7,5 ...
739	VD 4/14 DL-7 ...

Sampa Nr.

010.656

O.E.M. Nr.

343 330 02 19
(343 586 02 33)



Dimension

ø45/ø46x225

Description

King Pin Set

BM	MODEL
336	LP 1924, LPS 1924
343	L 2624/6X4 ...
346	L 1924, LK 1924, LS 1924
349	L 1621, LK 1921, LS 1621/1624
355	OF 1617
363	LP 2226/6X4 ...
739	VL 4/2 D-7

Sampa Nr.

010.678

O.E.M. Nr.

625 330 02 19



Dimension

M24xø55/ø60x126

Description

King Pin Set

BM	MODEL	731	AD 7/13 DG-9
731	AL 7/12 D-9	731	AD 7/13 D-9/4.637

Sampa Nr.

010.667

O.E.M. Nr.

668 330 00 19
(310 330 12 19)



Dimension

ø27x153

Description

King Pin Set

BM	MODEL	730	VL 1/6-2,3
730	VL 1/3-2, 1	730	VL 1/7-2,6
730	VL 1/10 C-2,5	730	VL 1/8 D-2,5
730	VL 1/11 C - 2,3	730	VL 1/9 C-2,3
730	VL 1/12 C - 2,5		
730	VL 1/3-2,1		
730	VL 1/4-1,6		

Sampa Nr.

010.679

O.E.M. Nr.

625 330 04 19



Dimension

M24xø55/ø60x126

Description

King Pin Set

BM	MODEL	730	AD 7/13 DG-9
731	AL 7/12 D-9	730	AD 7/52 DG-9
730	AD 7/13 D-9/4,637	730	AL 7/60 DS -9,5

Sampa Nr.

010.680

O.E.M. Nr.

346 330 00 19
(346 586 00 33)



Dimension

M24xø50x109

Description

King Pin Set

BM	MODEL	733	AL 7/1 DS 7/27:18 ...
730	AL 7/56 D -9 ...	737	AT 4/ 1S-7,0
731	AD 7/9 DG-8 ...		

Sampa Nr.

010.677

O.E.M. Nr.

625 330 01 19

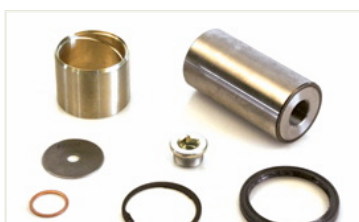

Dimension

M24xø55x109

Description

King Pin Set

BM	MODEL	730	AL 7/60 DS -9.5
730	AD 7/52 DG -9	730	AM 7/52 GS - 7.5
730	AD 7/56 DG -9	730	VL 7/54 D-9
730	AL 7/52 D -9	731	AL 7/12 D-9
730	AL 7/54 D-9	731	AD 7/13 D-9/4. 637
730	AL 7/56 D -9	731	AD 7/13 DG-9
730	AL 7/60 DS -11		

Sampa Nr.

010.681

O.E.M. Nr.

346 330 01 19
(346 586 01 33)



Dimension

M24xø50/ø64x119

Description

King Pin Set

BM	MODEL	733	AL 7/1 DS 7/27:18 ...
730	AL 7/52 DS-7,5 ...	737	AT 4/IS-7,0
731	AD 7/9 DG-8 ...		

V-Stay - Axle Control Arm

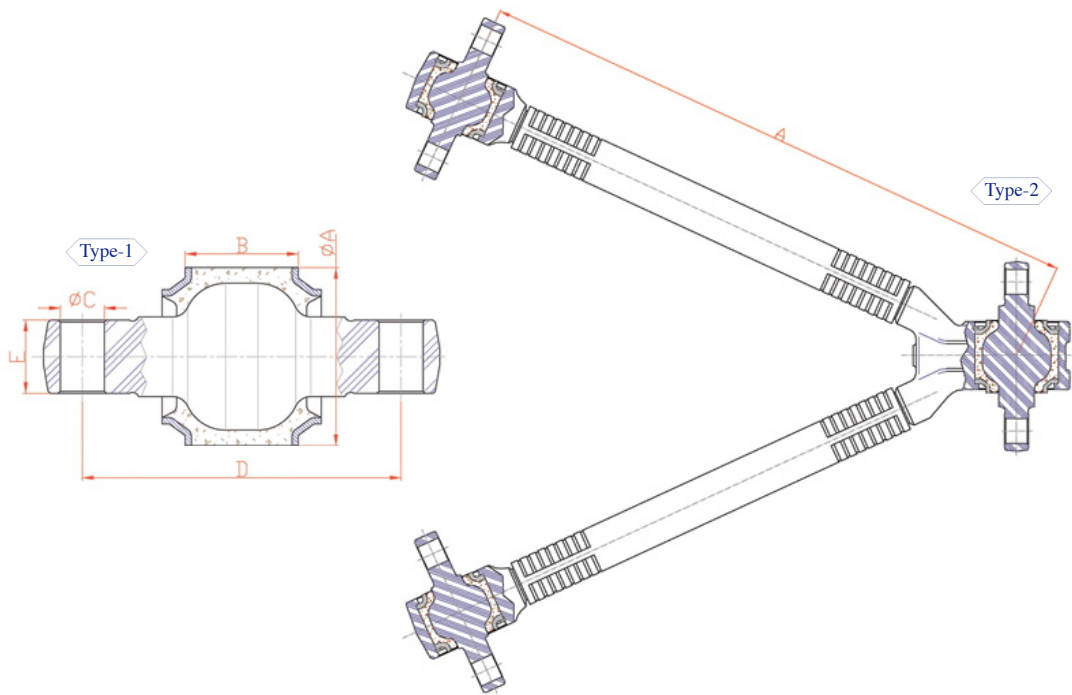

Sampa Nr.	O.E.M. Nr.	A	B	C	D	E	Repair Kit	Type
010.685	-	ø56	37.5	ø15	90	20	-	1
010.671	000 350 05 11	ø67	43	ø19	130	24	-	1
010.674	000 330 14 11	ø67	43	ø17	100	24	-	1
010.676	000 350 10 05	ø67	43	ø15	115	24	-	1
010.696	000 350 20 05	ø67	43	ø23	130	24	-	1
010.587	000 350 13 05	ø75	48	ø17	130	24	-	1
010.635	000 350 22 05	ø75	52	ø25	130	24	-	1
010.668	000 330 02 07	ø75	48	ø19	130	24	-	1
010.675	000 350 21 05	ø75	52	ø25	152	24	-	1
010.687	000 350 25 05	ø75	52	ø25	130	24	-	1
020.524	000 330 07 07	ø75	48	ø17	115	24	-	1
010.692	000 350 12 05	ø75	48	19/28	126	24	-	1
010.694	629 330 04 07	ø75	48	ø25	130	24	-	1
010.664	000 350 02 13 S	ø80	52.5	ø21	152	24	-	1
010.575	000 350 06 13	ø85	54	ø21	152	24	-	1
010.578	000 350 05 06	ø85	54	ø19	130	30	-	1
010.583	000 330 00 75	ø85	54	ø16.5	130	30	-	1
010.636	000 350 23 05	ø85	57.5	ø25	152	24	-	1
010.683	000 350 18 05	ø85	54	21/26	152	24	-	1
010.686	000 350 33 05	ø85	57.5	ø23	130	24	-	1
010.695	000 350 31 05	ø85	67.5	ø25	152	24	-	1
010.697	000 350 37 05	ø85	57.5	ø23	130	30	-	1
010.698	000 350 27 05	ø85	57.5	ø21	152	24	-	1
020.515	000 350 28 05	ø85	57.5	ø25	130	24	-	1
020.541	000 350 15 13	ø85	57.5	ø19	130	24	-	1
010.576	000 350 04 13	ø95	61	ø21	152	24	-	1
010.672	000 350 24 05	ø100	73	ø25	152	24	-	1
010.699	000 350 35 05	ø100	74.5	ø25	152	24	-	1
010.577	000 350 01 13	ø108	67	ø21	152	24	-	1
010.688	000 350 36 05	ø108	82.5	ø25	152	30	-	1
095.241	947 350 01 05	622	-	-	-	-	010.635-010.636	2

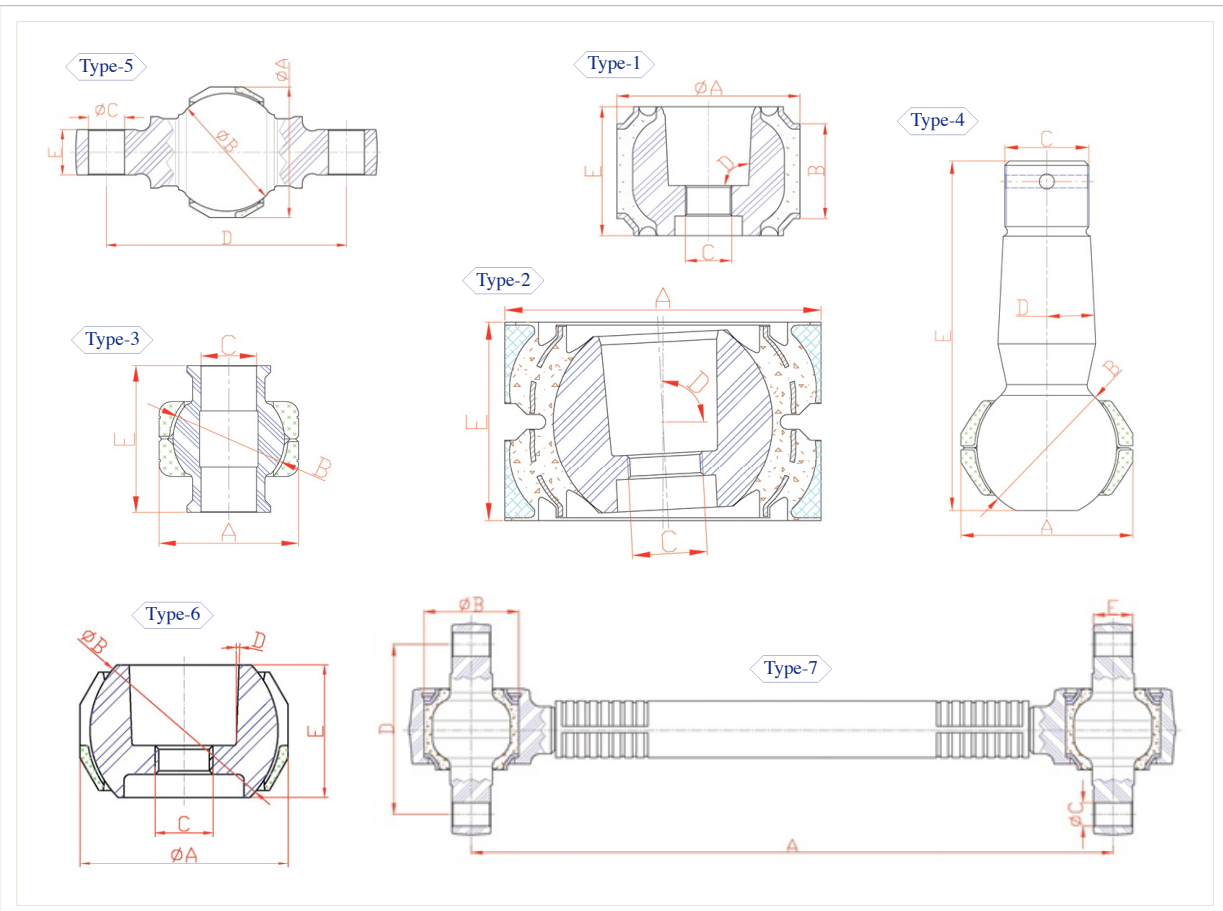

Sampa Nr.	O.E.M. Nr.	A	B	C	D	E	Repair Kit	Type
010.659	000 350 09 05	ø95	53	M24x1.5	2°52'	72	-	1
010.684	000 350 19 05	ø95	53	M24x1.5	2°52'	72	-	1
010.693	000 350 11 05	ø95	53	M24x1.5	2°52'	72	-	1
010.584	000 350 17 05	ø108	-	M24x1.5	2°52'	68	-	2
010.552	360 320 01 41	ø50	ø40	ø20	-	55	-	3
010.535	343 586 00 32	ø80	ø65	M39x1.5	2°52'	162.5	-	4
010.534	000 340 41 68	ø80	ø65	ø21	152	24	-	5
010.579	000 586 01 32	ø80	ø65	ø21	152	24	-	5
010.633	000 350 14 05	ø80	ø65	21/26	152	24	-	5
010.554	000 350 02 05	ø80	ø65	M20x1.5	2°52'	46	-	6
010.555	000 586 10 35	ø80	ø65	M20x1.5	2°52'	46	-	6
010.536	000 350 04 05	ø90	ø80	M24x1.5	2°52'	62	-	6
010.634	000 350 15 05	ø90	ø80	M24x1.5	2°52'	60	-	6
095.236	655 350 00 06	585	ø85	ø21	152	24	010.575	7

V-Stay - Axle Control Arm



Sampa Nr.

011.246

O.E.M. Nr.

000 330 00 80

Dimension

ø87xø17/130

Description

Axle Rod Mounting

BM	MODEL
357	O 405, 407,408
612	O 405,407,407



Sampa Nr.

010.685

O.E.M. Nr.

Dimension

ø56xø15/90

Description

Rep. Kit for Axle Rod



Sampa Nr.

010.671

O.E.M. Nr.

000 350 05 11

Dimension

ø67xø19/130

Description

Rep. Kit for Axle Rod



Sampa Nr.

010.674

O.E.M. Nr.

000 330 14 11

Dimension

ø67xø17/100

Description

Rep. Kit for Axle Rod

BM	MODEL
930,934,950,957	ACTROS
940,950,954	AXOR
957	ECONIC



Sampa Nr.

010.676

O.E.M. Nr.

000 350 10 05

Dimension

ø67xø15/115

Description

Rep. Kit for Axle Rod

BM	MODEL
356	O 404
613	O 350 TOURISMO



Sampa Nr.

010.696

O.E.M. Nr.

000 350 20 05

Dimension

ø67xø23/130

Description

Rep. Kit for Axle Rod

MODEL
ACTROS
ATEGO
AXOR
ECONIC

Sampa Nr.

010.587

O.E.M. Nr.

000 350 13 05



Dimension

ø75xø17/130

Description

Rep. Kit for Axle Rod

BM	MODEL
356	O 404
613	O 350 TOURISMO

Sampa Nr.

010.668

O.E.M. Nr.

000 330 02 07



Dimension

ø75xø19/130

Description

Rep. Kit for Axle Rod

BM	MODEL
357	O 405 ...
612	O 405 ...
698	BGT-N 2

Sampa Nr.

010.675

O.E.M. Nr.

000 350 21 05



Dimension

ø75xø25/152

Description

Rep. Kit for Axle Rod

BM	MODEL
375	2623 L, 2628 L
930/950,	ACTROS
940/950	AXOR
957	ECONIC
970/974/975	ATEGO

Sampa Nr.

010.687

O.E.M. Nr.

000 350 25 05



Dimension

ø75xø25/130

Description

Rep. Kit for Axle Rod

BM	MODEL
374,375,942,943,950	AXOR
930,932,933,934,950	ACTROS

Sampa Nr.

020.524

O.E.M. Nr.

000 330 07 07



Dimension

ø75xø17/115

Description

Rep. Kit for Axle Rod

BM	MODEL
357	O 405
382	O 500
612	O 405
628	CONECTO

Sampa Nr.

010.692

O.E.M. Nr.

000 350 12 05



Dimension

ø75x19x28/126

Description

Rep. Kit for Axle Rod

MODEL
O 350
O 404

V-Stay - Axle Control Arm



Sampa Nr.

010.694

O.E.M. Nr.

629 330 04 07

Dimension

ø75xø25/130

Description

Rep. Kit for Axle Rod



Sampa Nr.

010.664

O.E.M. Nr.

**000 350 02 13 S
(000 586 14 33 S)**

Dimension

ø80xø21/152

Description

Rep. Kit for Axle Rod



Sampa Nr.

010.578

O.E.M. Nr.

000 350 05 06

Dimension

ø85xø19/130

Description

Rep. Kit for Axle Rod

BM	MODEL
382	O 500 ...
410	Setra
629	O 580 Travego, Setra
632	Travego, Travego EvoBus
633	EvoBus



Sampa Nr.

010.583

O.E.M. Nr.

000 330 00 75

Dimension

ø85xø16.5/130

Description

Rep. Kit for Axle Rod

BM	MODEL
307	O 305, O 307, O 305 G
357	O 405, 407, 408
396	1829/OHL, 1834 OHL, OH 1622 L
612	O 405 / 407 / 408
697	O 301
698	BGT-25 / BGU-25 / BT-25 / BU 5-25 / VU 4-23



Sampa Nr.

010.575

O.E.M. Nr.

**000 350 06 13
(000 586 11 35)**

Dimension

ø85xø21/152

Description

Rep. Kit for Axle Rod

BM	396	648	656
318	397	649	657
343	616	651	658
371	619	652	659
385	623	653	
393	624	654	
395	625	655	

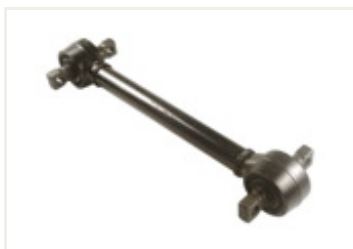

Sampa Nr.

095.236

O.E.M. Nr.

**655 350 00 06
(658 350 00 06)
(658 350 02 06)**

Dimension

585

Description

Tie Rod

BM	MODEL
387	1626 L/LS, 1632 L/LS
389	1926 LS, 1932 LS
393	2226 / S/6X4 ...
620	1628 L, 1633 L, 1636 L, 1733 L
656	1929 L, 2429 L
658	2429 L, 2434 L, 2435 L/LS ...

Sampa Nr.

010.683

O.E.M. Nr.

000 350 18 05



Dimension

ø85x21x26/152

Description

Rep. Kit for Axle Rod

BM	MODEL
651	1420 L/LS, 1422 L/LS ...
652	1717 L, 1720 L, 1722 L/LL ...
653	2420 L, 2422 L, 2427 L ...
654	2420 L, 2422 /L, 2426 /L ...
657	2429 LS/6X2/4 ...
658	2429 L, 2434 L, 2435 L/LS ...

Sampa Nr.

010.635

O.E.M. Nr.

000 350 22 05



Dimension

ø75xø25/130

Description

Rep. Kit for Axle Rod

BM	MODEL
957	ECONIC
375,950,952,953,954	AXOR
930,932,933,934,950	ACTROS

Sampa Nr.

010.686

O.E.M. Nr.

000 350 48 05

(000 350 33 05)



Dimension

ø85xø23/130xAA24

Description

Rep. Kit for Axle Rod

BM	MODEL
954	ACTROS / AXOR

Sampa Nr.

010.636

O.E.M. Nr.

000 350 23 05



Dimension

ø85xø25/152

Description

Rep. Kit for Axle Rod

BM	MODEL
957	ECONIC
375,950,952,954,958	AXOR
930,932,933,934,950	ACTROS

Sampa Nr.

010.695

O.E.M. Nr.

000 350 31 05



Dimension

ø85xø25/152

Description

Rep. Kit for Axle Rod

MODEL
ACTROS
ECONIC

Sampa Nr.

095.241

O.E.M. Nr.

947 350 01 05

(944 350 00 05)

(944 350 03 05)

(947 350 07 05)



Dimension

622

Description

V-Arm

BM	MODEL
375,940,944,952,953	AXOR
930,932,933,934,950	ACTROS
957	ECONIC

V-Stay - Axle Control Arm



Sampa Nr.

010.697

O.E.M. Nr.

000 350 37 05

Dimension

ø85xø23/130

Description

Rep. Kit for Axle Rod

MODEL
AXOR
ACTROS



Sampa Nr.

010.698

O.E.M. Nr.

000 350 27 05

Dimension

ø85xø21/152

Description

Rep. Kit for Axle Rod

MODEL
AXOR
ACTROS



Sampa Nr.

020.515

O.E.M. Nr.

000 350 28 05

Dimension

ø85xø25/130

Description

Rep. Kit for Axle Rod

MODEL
ACTROS



Sampa Nr.

020.541

O.E.M. Nr.

000 350 15 13

Dimension

ø85xø19/130

Description

Rep. Kit for Axle Rod

MODEL
O 530 CITARO
OC 500
TOURINO



Sampa Nr.

010.576

O.E.M. Nr.

**000 350 04 13
(000 586 12 35)**

Dimension

ø95xø21/152

Description

Rep. Kit for Axle Rod

BM	MODEL	397	2637 S/6X4, 2635 /6X4 ...
343	L/LK 2624/6X4 ...	398	2629/6X4 ...
371	2624 K/2627 K ...	623	2233 S 6X4
338	L 2635/6X4/54 ...	625	3328, 3528 /B/K, 3535 /B/K ...
338	LK 2635/6X4/40	659	2638/L, 2644/L, 2650, 2653 ...
338	LS 2635/6X4/40	696	L 2638, LK 2638, LS 2638
395	2626 S, 2632, 3332 ...	739	VL 4/10 D-7, 49 D-7
396	OH 1622 L, 1625 L, 1628 L ...		



Sampa Nr.

010.693

O.E.M. Nr.

000 350 11 05

Dimension

M24x1.5/ø95x72

Description

Rep. Kit for Axle Rod

MODEL
O 350
O 404

Sampa Nr.

010.672

O.E.M. Nr.

000 350 24 05



Dimension

ø100xø25/152

Description

Rep. Kit for Axle Rod

BM	MODEL
374	33. .
375	3028 K, 3028 B
930,932,933,934,950	ACTROS
942,943,950,952,953	AXOR

Sampa Nr.

010.699

O.E.M. Nr.

000 350 35 05



Dimension

ø100xø25/152

Description

Rep. Kit for Axle Rod

MODEL
AXOR

Sampa Nr.

010.577

O.E.M. Nr.

000 350 01 13



Dimension

ø108xø21/152

Description

Rep. Kit for Axle Rod

BM	MODEL
398	2629/6X4, 2029/A 6X6, 2629/AK 6X6
388	L 2635/6X4/54, LK 2635/6X4/40, LS 2635/6X4/40
625	3236 A, 3244 A, 3250 A/AF, 3250 AF ...
696	L / LK / LS 2638

Sampa Nr.

010.688

O.E.M. Nr.

000 350 36 05



Dimension

ø108xø25/152

Description

Rep. Kit for Axle Rod

BM	MODEL
374/943/958	AXOR
930,932,933,934,950	ACTROS

Sampa Nr.

010.659

O.E.M. Nr.

000 350 09 05



Dimension

M24x1.5/ø95x72

Description

Rep. Kit for Axle Rod

BM	MODEL
356	O 404
613	O350 Tourismo

Sampa Nr.

010.684

O.E.M. Nr.

000 350 19 05



Dimension

M24x1.5/ø95x72

Description

Rep. Kit for Axle Rod

BM	MODEL
616	1419 CL, 1420 L/LS ...
619	2219 CL, 2220 L ...
652	1717 L, 1720 L, 1722 L ...
653	2420 L, 2422 L, 2427 L ...
654	2420 L, 2422 /L, 2426 /L ...
655	1838 LS

V-Stay - Axle Control Arm



Sampa Nr.

010.584

O.E.M. Nr.

000 350 17 05

Dimension

M24x1.5/ø108x68

Description

Rep. Kit for Axle Rod

BM	MODEL
651	1420 L/LS, 1422 L/LS ...
652	1717 L,1720 L, 1722 L/LL ..
653	2420 L, 2422 L, 2427 L ...
656	1929 L, 2429 L
657	2429 LS/6X2/4, 2448L/LS ...
658	2429 L, 2434 L, 2435 L/LS



Sampa Nr.

010.552

O.E.M. Nr.

**360 320 01 41
(360 586 01 32)**

Dimension

ø50xø20x55

Description

Rep. Kit for Axle Rod

BM	MODEL
328	L 328,911 / LS 328,911 / LKO 328,911
352	LAK 1313 / LAKO 1313 / LAS 1313 ...
353	LS 911 B / LPK 810,911 B ...
358	LAS 1113 B / LF 1113 B / LS 1113 B / OF 1113
360	LAK 1513 / LAKO 1513 / LK 1513 ...



Sampa Nr.

010.535

O.E.M. Nr.

**343 586 00 32
(000 586 16 33)**

Dimension

M39x1.5/ø80x162.5

Description

Rep. Kit for Axle Rod

BM	MODEL
343	L 2624/6X4 ...
352	L 1813/6X4, L 1813/6X2
360	L 1819/6X4, 1817,1819/6X4
385	2219 K/6X4 ...
397	2219 6X4 ...



Sampa Nr.

010.535/1

O.E.M. Nr.

000 586 06 32

Dimension

ø80

Description

Rep. Kit for Axle Rod

BM	MODEL
343	LA 2624/6X6
343	LAK 2624/6X6 ...
352	L 1813/6X4, L 1813/6X2
360	L 1817,1819/6X4



Sampa Nr.

010.534

O.E.M. Nr.

**000 350 02 13
(000 586 14 33)**

Dimension

ø80xø21/152

Description

Rep. Kit for Axle Rod

BM	383	617	645	654
314	385	619	646	655
316	387	620	647	655
318	389	621	648	657
360	393	622	651	658
380	397	623	652	
381	616	625	653	



Sampa Nr.

010.534/1

O.E.M. Nr.

000 586 15 33

Dimension

ø80

Description

Rep. Kit for Axle Rod

BM	MODEL
397	2219 6X4, 2219 B/6X4, 2219 K/6X4
616	1422 L,1425 L ...
645	1635 L,1644 LS/L,2244 LS,2444 LS
656	1929 L,2429 L
657	2429 LS/6X2/4 ...
658	2429 L,2434 L ...

Sampa Nr.

010.579

O.E.M. Nr.

000 586 01 32



Dimension

ø80xø21x152

Description

Rep. Kit for Axle Rod

BM	MODEL
352	L 1813/6X4, 1813/6X2
360	L 1819/6X4,1817,1819/6X4

Sampa Nr.

010.579/1

O.E.M. Nr.

000 586 07 32



Dimension

ø80

Description

Rep. Kit for Axle Rod

BM	MODEL
352	L 1813/6X4, 1813/6X2
360	L 1819/6X4,1817,1819/6X4

Sampa Nr.

010.633

O.E.M. Nr.

000 350 14 05



Dimension

ø80x21x26/152

Description

Rep. Kit for Axle Rod

BM	MODEL
651	1420 /L/LS, 1422 L/LS ...
652	1717 L, 1720 L, 1722 L/LL ...
653	2420 L, 2422 L, 2427 L ...
654	2420 L, 2422 /L, 2426 /L ...
655	1729 L/LS, 1735 /L/LS ...
657	2429 LS/6X2/4 ...
658	2429 L, 2434 L, 2435 L/LS ...

Sampa Nr.

010.554

O.E.M. Nr.

000 350 02 05



Dimension

M20x1.5/ø80x46

Description

Rep. Kit for Axle Rod

BM	MODEL	383	1419 L/LS, 1424 LS
380	1017 LS		
381	1217 L/LS		

Sampa Nr.

010.555

O.E.M. Nr.

000 586 10 35



Dimension

M20x1.5/ø80x46

Description

Rep. Kit for Axle Rod

BM	MODEL	383	1419 L/LS, 1424 LS
380	1017 LS	385	1613 L, 1617 L,1619 L,
381	1217 L, 1217 LS		

Sampa Nr.

010.634

O.E.M. Nr.

000 350 15 05



Dimension

M24x1.5/ø90x60

Description

Rep. Kit for Axle Rod

BM	MODEL	655	1729 L/LS, 1735 L/LS ...
651	1420 L/LS, 1422 L/LS ...	657	2429 LS/6X2/4 ...
652	1717 L,1720 L ...	658	2429 L, 2434 L ...
653	2420 L, 2422 L ...		

Sampa Nr.

010.536

O.E.M. Nr.

000 350 04 05

(000 586 01 35)

(000 586 18 33)

(000 586 19 33)



Dimension

M24x1.5/ø90x62

Description

Rep. Kit for Axle Rod

BM	MODEL	383	1419 L/LS, 1424 LS
380	1017 LS	387	1626 L/LS, 1632 L/LS
381	1217 L/LS		

Engine - Flywheel



Sampa Nr.

100.055

O.E.M. Nr.

**403 032 03 09
(403 032 01 09)**

Dimension

ø115xø120x21

Description

Intermediate Ring, No Hardened

BM	421	441	457	476	521
401	422	442	458	481	541
402	423	443	460	489	542
403	424	444	462	492	941
404	427	445	463	493	942
407	429	446	466	495	
409	440	447	475	496	



Sampa Nr.

100.055/1

O.E.M. Nr.

**403 032 03 09 S
(403 032 01 09 S)**

Dimension

ø115xø120x21

Description

Intermediate Ring, Surface Hardened

BM	421	441	457	476	521
401	422	442	458	481	541
402	423	443	460	489	542
403	424	444	462	492	941
404	427	445	463	493	942
407	429	446	466	495	
409	440	447	475	496	



Sampa Nr.

100.081

O.E.M. Nr.

**403 031 01 27
(403 031 06 27)
(403 031 07 27)**

Dimension

ø100xø110x24.5

Description

Intermediate Ring, No Hardened

BM	421	442	482
401	422	443	492
402	423	444	493
403	424	447	495
404	427	475	496
407	429	476	
409	441	481	



Sampa Nr.

100.081/1

O.E.M. Nr.

**403 031 01 27 S
(403 031 06 27 S)
(403 031 07 27 S)**

Dimension

ø100xø110x24.5

Description

Intermediate Ring, Surface Hardened

BM	421	442	482
401	422	443	492
402	423	444	493
403	424	447	495
404	427	475	496
407	429	476	
409	441	481	



Sampa Nr.

100.082

O.E.M. Nr.

442 031 00 27

Dimension

ø100xø105x24.5

Description

Intermediate Ring, No Hardened

BM	422	443	460	485	522
401	423	444	462	489	541
402	424	445	463	492	542
403	427	446	466	493	941
404	440	447	475	495	942
407	441	457	476	496	
421	442	458	481	521	



Sampa Nr.

100.082/1

O.E.M. Nr.

442 031 00 27 S

Dimension

ø100xø105x24.5

Description

Intermediate Ring, Surface Hardened

BM	422	443	460	485	522
401	423	444	462	489	541
402	424	445	463	492	542
403	427	446	466	493	941
404	440	447	475	495	942
407	441	457	476	496	
421	442	458	481	521	

Sampa Nr.

011.229

O.E.M. Nr.

668 242 00 13



Dimension

189x75.5x70

Description

Engine Mounting

BM	MODEL	692	L 710 D, 913 D / LO 813 D
371	O 814 R/S		
390	OH 1115L/46, 1315L/52		
668	609 D		
669	709 D, 711 D		
670	809 D, 811 D		
688	709, 710, 712 L 710 D ...		

Sampa Nr.

011.230

O.E.M. Nr.

668 242 05 13



Dimension

189x75.5x71.5

Description

Engine Mounting

BM	MODEL	668,670	VARIO

Sampa Nr.

011.239

O.E.M. Nr.

000 241 36 13



Dimension

ø20xø96.5x80

Description

Rubber Mounting for Engine Suspension

BM	MODEL	668,670	Vario
673	711		
673	811 K		
674	814 /F/K/L/LO/S		
688	915 E / LO 914,915		

Sampa Nr.

O.E.M. Nr.

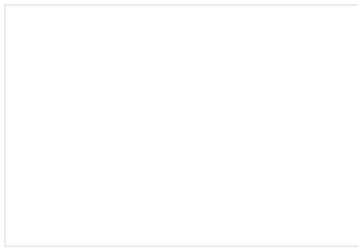

Dimension

Description

Sampa Nr.

O.E.M. Nr.

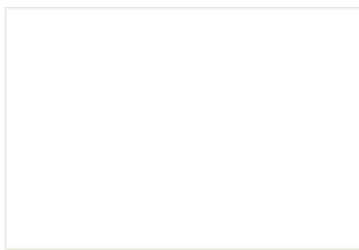

Dimension

Description

Sampa Nr.

O.E.M. Nr.

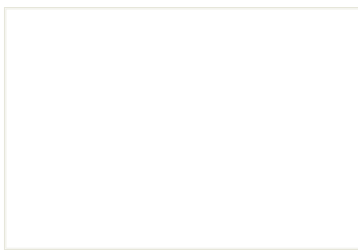

Dimension

Description

Propeller Shaft



Sampa Nr.

011.186

O.E.M. Nr.

460 410 00 22
(460 410 02 22)

Dimension

ø35

Description

Propeller Shaft Bearing

BM	MODEL
668	609 D
669	709 D, Vario
670	809 D
673	709, 711, 809, 811, 709 K, 809 K, 811 K



Sampa Nr.

011.187

O.E.M. Nr.

385 410 16 22

Dimension

ø55

Description

Propeller Shaft Bearing

BM	MODEL
----	-------



Sampa Nr.

011.204

O.E.M. Nr.

346 410 00 10

Dimension

ø45

Description

Propeller Shaft Bearing

BM	MODEL
336	LP 1924
343	LA 2624/6X6
346	LA 1924, LAK 1924 ...
349	L/ LK/LS/ 1621
363	LP 2232/6X4, LP 2226/6X4
371	2517K/6X2/36, 2517/6X2/48 ...



Sampa Nr.

011.238

O.E.M. Nr.

970 411 00 12

Dimension

ø45

Description

Propeller Shaft Bearing

BM	MODEL
669	Vario
970	ATEGO

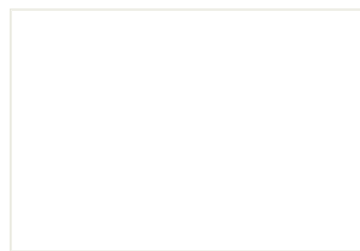

Sampa Nr.

O.E.M. Nr.

Dimension

Description

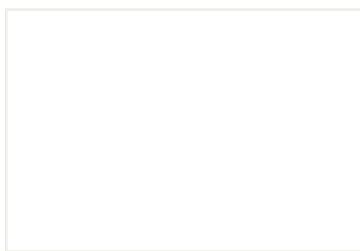

Sampa Nr.

O.E.M. Nr.

Dimension

Description

Sampa Nr.

011.178

O.E.M. Nr.

973 410 00 22
(385 410 01 22)
(385 410 01 10)
(385 410 09 22)
(385 410 17 22)
(385 586 01 41)



Dimension

ø55

Description

Propeller Shaft Bearing

BM	389	621	676	972
355	397	650	677	976
380	437	651	679	
381	615	652	684	
383	616	653	950	
385	617	654	957	
387	619	656	970	

Sampa Nr.

011.179

O.E.M. Nr.

601 410 21 10
(601 410 17 10)



Dimension

ø45

Description

Propeller Shaft Bearing

BM	MODEL
601	208, 210, 207 D, 208 D, 209 D, 210 D
602	308, 310, 307 D, 308 D, 309 D, 310 D
611	410, 407 D, 408 D, 409 D, 410 D

Sampa Nr.

011.181

O.E.M. Nr.

395 410 00 22
(395 410 06 22)
(620 410 00 10)
(655 410 00 22)



Dimension

ø70

Description

Propeller Shaft Bearing

BM	397	649	659
343	620	652	660
346	623	653	950
386	624	654	953
388	625	655	957
393	645	656	
395	648	658	

Sampa Nr.

011.181/1

O.E.M. Nr.

395 410 06 22 S



Dimension

Description

Propeller Shaft Bearing

BM	397	649	659
343	620	652	660
346	623	653	950
386	624	654	953
388	625	655	957
393	645	656	
395	648	658	

Sampa Nr.

011.183

O.E.M. Nr.

381 410 00 10
(381 410 02 22)
(381 410 12 22)
(381 410 15 22)
(385 410 00 10)
(385 586 00 41)



Dimension

ø45

Description

Propeller Shaft Bearing

BM	MODEL
318	LPO 811, 813
380	1013 /K/S/KO, 1017 K/S/KO/F/LS
381	1213 /K/S/KO, 1217 K/KO/S/L/LS
678	914, 1114, 1117
684	917/ K , 1518 /K, OF 1113
970	ATEGO

Sampa Nr.

011.184

O.E.M. Nr.

389 410 01 22
(389 410 02 22)
(395 410 02 22)
(620 410 00 22)
(654 410 00 22)



Dimension

ø60

Description

Propeller Shaft Bearing

BM	391	621	656
346	393	623	950
350	397	625	970
371	398	651	976
376	617	652	
387	619	653	
389	620	654	

Transmission

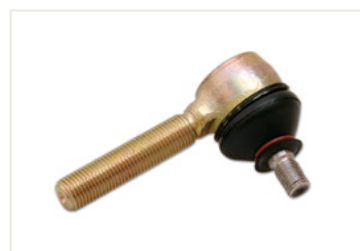

Sampa Nr.

100.006

O.E.M. Nr.

**000 268 48 89
(000 268 01 89)**

Dimension

M10x1/M14x1.5

Description

Ball Joint

BM	MODEL
336	LP /LPS 1924
363	LP 2232/6X4 ...
711	S 4-90, S 5-90 ...
717	5 K-91, 5 S-111...
718	S 6-90
719	S 6-80 ...

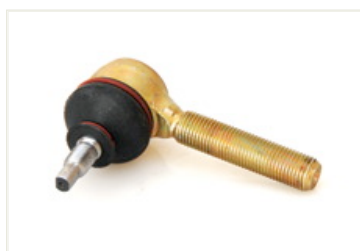

Sampa Nr.

100.007

O.E.M. Nr.

000 268 52 89

Dimension

M10x1/M14x1.5

Description

Ball Joint

BM	MODEL
710	16 S-160 + NMV 130 E ...
717	16 S -112+N 112/10
718	4 S-120 GP ...
719	S 6-90+GV 90 ...



Sampa Nr.

100.008

O.E.M. Nr.

**000 268 47 89
(000 268 61 89)**

Dimension

M10x1.5/M12x1.75 L

Description

Ball Joint, Left

BM	MODEL	718	8 S-1350 ...
336	LP/LPS 1924	719	S 6-80 ...
363	LP 2232/6X4 ...		
710	16 S -160		
711	S 4-90 ...		
712	S 5-680/7.43 ...		
717	5 S -90 ...		



Sampa Nr.

100.009

O.E.M. Nr.

**000 268 62 89
(000 268 46 89)**

Dimension

M10x1.5/M12x1.75 R

Description

Ball Joint, Right

BM	MODEL
363	LP/LPS 1924
710	16 S-160 + NMV 130 E
712	S 5-680/7.43 ...
717	5 S-90 ...
718	8 S-1350
719	S 6-80 GV 80 ...



Sampa Nr.

100.027

O.E.M. Nr.

**000 268 69 89
(000 996 52 45)
(673 268 01 89)**

Dimension

M10x1/M14x1.5

Description

Ball Joint

BM	MODEL
371	2624 K, 2627 K, 3027 6X4/38,5
625	3233 B/K, 3234 B/K, 3534 K
653	2433 K, 2524 K/L, 2527 B/K ...
656	2553, 2024 /K, 2027 AK ...
659	2631 /K/LK ...
952	ACTROS



Sampa Nr.

100.028

O.E.M. Nr.

000 268 59 89

Dimension

M10x1/M14x1.5

Description

Ball Joint

BM	MODEL	650	1227 LAF ..
371	1938 S/35 / LS/35 ...	652	1827 AK ...
620	1628 ...	655	1831 /K ...
621	1928 L ...	659	2544 K ...
622	2028 LS/6X2/4 ...	950,952,953,954	ACTROS
623	2228 ...	970,972,974,975,976	ATEGO
624	2638 S 6X4 ...		
625	2650 /S ...		

Sampa Nr.

100.037

O.E.M. Nr.

000 996 67 45

Dimension

M10x1.5/M12x1.75 L

Description

Ball Joint, Left

BM	MODEL
371	1938 S/35 LS/35
625	3550, 4844, 4850 ...
655	1838/K, 1835, 1838 ...
673	711, 811 /K
674	814 L/LO/F/K, VO 4/11 DL-7
950, 952, 953, 954	ACTROS

Sampa Nr.

100.036

O.E.M. Nr.

000 996 66 45

Dimension

M10x1.5/M12x1.75 R

Description

Ball Joint, Right

BM	MODEL
371	1938 S/35 LS/35 ...
397	MB 800 T
625	3050,3053/A/S, 3550, 3553S ...
659	2638/K,2644/K,2650/K ...
684	MB 800/38ATL ...
950/ 954	ACTROS

Sampa Nr.

100.063

O.E.M. Nr.

000 996 56 45**(000 996 51 45)**

Dimension

M10x1.5/M12x1.75 L

Description

Ball Joint, Left

BM	650	658	715	972
371	651	659	940	974
375	652	684	942	975
384	653	688	943	976
427	654	693	944	
437	655	712	958	
625	656	714	970	

Sampa Nr.

100.062

O.E.M. Nr.

000 996 55 45**(000 996 50 45)**

Dimension

M10x1.5/M12x1.75 R

Description

Ball Joint, Right

BM	625	659	940	958
371	652	684	942	970
374	653	688	943	972
375	654	693	950	974
384	655	712	950	975
427	656	714	951	976
437	658	715	954	

Sampa Nr.

100.038

O.E.M. Nr.

000 996 68 45

Dimension

M10x1.5/M14x1.5

Description

Ball Joint

BM	MODEL
371	1938 S/35 LS/35 ...
655	1831/K, 1834 K ...
656	2038 AS,LAS,2044 AS/LAS ...
693	1938 /S, 1944 S
950,952,954	ACTROS
970,972,976	ATEGO

Sampa Nr.

O.E.M. Nr.

Description

Transmission



Sampa Nr.

011.003

O.E.M. Nr.

620 268 01 96
(385 268 06 96)

Dimension

ø20xø58x21

Description

Dust Protecting Rubber

BM	387	424	443	622	650	658	678
371	389	425	615	623	651	659	679
376	391	427	616	624	652	673	682
380	393	435	617	625	653	674	684
381	395	436	619	645	654	675	
383	397	437	620	648	655	676	
385	398	442	621	649	656	677	



Sampa Nr.

010.673

O.E.M. Nr.

385 268 14 74 S

Dimension

ø42

Description

Rep. Kit for Gear Shift Lever



Sampa Nr.

010.539

O.E.M. Nr.

385 268 14 74 SP

Dimension

ø42

Description

Rep. Kit for Gear Shift Lever

BM	MODEL
393	2226 L 6x2, 2232 L 6x2



Sampa Nr.

010.539/1

O.E.M. Nr.

385 268 14 74 S1

Dimension

ø42

Description

Rep. Kit for Gear Shift Lever

BM	MODEL
393	2226 L 6x2, 2232 L 6x2



Sampa Nr.

010.057

O.E.M. Nr.

352 268 00 50

Dimension

ø32.5xø38x64

Description

Gearbox Bushing

BM	MODEL
318	LP 1013, LP 1113 ...
344	LP 1113, LPO/OF 1113/1114
345	OF 1313/1314
685	OF 1318
688	OF 809, 812
699	1424 LAP



Sampa Nr.

010.066

O.E.M. Nr.

424 337 07 06

Dimension

ø134xø164x35

Description

Gearbox Seal Ring

BM	MODEL
737	AU 7/1 CS-4,0, AU 2/13 CS-4,0 ...
747	HU 2/12 S-3,7, HU 2/19 CS-4,5 ...

Sampa Nr.

010.005

O.E.M. Nr.

321 268 08 50

Dimension

ø51.5xø58x18

Description

Gearbox Bushing

BM	MODEL	357	O 407 UE
300	O 303	357	O 408
317	O 317	373	O 302
321	O 362	373	O 303
341	O 120	373	O 304
341	O 140	600	O 303
341	O 170-UE	600	O 340

Sampa Nr.

010.009

O.E.M. Nr.

314 268 02 50

Dimension

ø25xø32x28

Description

Gearbox Bushing

BM	MODEL	314	LPLS 608,709
314	LP 608,709	316	LP 808,809
314	LPS 608,709	316	LPK 808,809
314	LPK 608,709	316	LPKF 808,809
314	LPKO 608,709	316	LPO 808,809
314	LPKF 608,709	316	LPL 808,809
314	LPO 608,709	684	508 I
314	LPL 608,709		

Sampa Nr.

010.011

O.E.M. Nr.

**310 268 00 35
(314 268 04 35)**

Dimension

ø48x28.5

Description

Gearbox Bushing

BM	MODEL
310	L 608 D, LK 608 D, O 309 D
314	LP 608,709, LPK 608,709 ...
353	L 911 B, LK 911 B, LKO 911 B ...
360	L 1513, LAK 1513, LK 1513 ...
715	UNIMOG G 3/55-6/8,5 ...
719	UNIMOG UG 2/27-7/11,26 GA ...

Sampa Nr.

010.019

O.E.M. Nr.

**314 268 02 43
(314 268 00 43)**

Dimension

ø18.5xø28x28.5

Description

Gearbox Bushing

BM	MODEL	314	LPO 608,709
314	LP 608,709	314	LPS 608,709
314	LPK 608,709	316	LP 808,809
314	LPKF 608,709	316	LPK 808,809
314	LPKO 608,709	316	LPKF 808,809
314	LPL 608,709	316	LPL 808,809
314	LPLS 608,709	316	LPO 808,809

Sampa Nr.

010.056

O.E.M. Nr.

352 268 03 35

Dimension

ø35xø48x22

Description

Gearbox Bushing

BM	MODEL
318	LP 811,813 ...
344	LP 1113, LPO/OF 1113/1114
352	OF 1313,1317,1413,1417
397	OF 1419, 1724, 1619, 1624
688	OF 809, 812
713	G 3/50-5/8,5 ...

Sampa Nr.

010.058

O.E.M. Nr.

352 268 04 50

Dimension

ø28xø38x24

Description

Gearbox Bushing

BM	MODEL
318	LP 1013, LPL 913 ...
344	LP 1113, LPO/OF 1113/1114 ...
352	OF 1313, 1317, 1413, 1417
397	OF 1419,1619,1624,1724
688	OF 809,812
699	1424

Transmission / Cooling System



Sampa Nr.

010.060

O.E.M. Nr.

611 267 02 50

Dimension

ø13.5xø21x13

Description

Gearbox Bushing

BM	MODEL
601	207 D / 208 D, 208 / 210, 209 D / 210 D
602	307 D / 308 D, 308 / 310, 309 D / 310 D
611	407 D / 408 D, 409 D / 410 D, 410



Sampa Nr.

100.032

O.E.M. Nr.

403 200 09 26

Dimension

ø74x77/146

Description

Fun Hub

BM	MODEL
402	OM 402
481	OM 421
492	ADE 422 N



Sampa Nr.

010.067

O.E.M. Nr.

305 268 00 50

Dimension

ø41xø55x35

Description

Gearbox Bushing

BM	MODEL
307	O 305, 307
382	OH 1315, 1318, 1418, 1420,1520, 1521/60
390	OH 1315/1316, 1316 G ...
398	OH 1318, 1520
684	OH 1113/1518, 1520/1521, 1521/60



Sampa Nr.

011.150

O.E.M. Nr.

608 988 00 11

Dimension

M8/ø30x20

Description

Rubber Mounting for Radiator

BM	MODEL
601	208 / 210, 207 D/208 D
602	308/310, 307 D / 308D
611	410, 407 D/408 D
612	SPRINTER



Sampa Nr.

010.068

O.E.M. Nr.

302 268 00 50

Dimension

ø41xø55x18

Description

Gearbox Bushing

BM	MODEL
364	O 364,365
321	O 362
345	OH 1313,1314,1316 ...
382	OH 1315, 1318 ...
684	1113/1518 ...
685	OH 1418



Sampa Nr.

011.207

O.E.M. Nr.

001 987 52 40
(322 504 02 12)
(001 987 26 40)

Dimension

M8/SW28X20

Description

Rubber Mounting for Radiator

BM	317	360	461	617	676
	300	318	366	463	628
	301	327	373	600	664
	307	336	378	602	669
	308	340	396	612	670
	309	355	397	613	671
	310	356	398	615	673
	313	357	418	616	674

Sampa Nr.
011.151

O.E.M. Nr.
347 504 00 12



Dimension
M10/ø55x35

Description
Rubber Buffer for Exhaust

BM	344	349	368	394	634
336	345	350	382	397	664
343	346	351	384	398	685

Sampa Nr.
011.153

O.E.M. Nr.
001 987 53 40



Dimension
M10/ø36.5x21

Description
Rubber Buffer for Exhaust

BM	307	318	358	676	684
300	309	352	668	677	958
301	310	353	669	678	

Sampa Nr.
011.013

O.E.M. Nr.
000 323 28 85
(000 323 24 44)



Dimension
ø20xø40x39.5

Description
Rubber Bushing for Shock Absorber

BM	MODEL	345	ACCELLO	376
328	AXOR	371		380
341	ACTROS	374		
343	ACTROS	375		

Sampa Nr.
011.014

O.E.M. Nr.
000 323 78 85



Dimension
ø18x32.5x31

Description
Rubber Bushing for Shock Absorber

BM	MODEL
901/902/903	Sprinter

Sampa Nr.
100.066

O.E.M. Nr.
001 980 84 64



Dimension
610mm/360N

Description
Gas Spring

BM	MODEL
943	ACRTROS

Sampa Nr.
100.067

O.E.M. Nr.
-



Dimension
735mm/270N

Description
Gas Spring

Sampa Nr.
100.084

O.E.M. Nr.
000 980 90 64
(000 980 62 64)



Dimension
775mm/220N

Description
Gas Spring

BM
397
641
642
649
699

Filter / Chassis



Sampa Nr.

010.061

O.E.M. Nr.

000 180 24 38

Dimension

Te100x3/144x25Nm

Description

Filter Cover

BM	MODEL
457	OM 457 HLA/IV, OM
476	M 447 HLAG
902	M 906 LAG, OM 906
906	M 906 LAG, OM 906
926	OM 926 LA, 906 LA



Sampa Nr.

010.062

O.E.M. Nr.

000 180 23 38

Dimension

Te100x3/80.5x25Nm

Description

Filter Cover

BM	MODEL
900	OM 904 LA
904	OM 904 LA
907	OM 904 LA
909	OM 906 LA
924	OM 924 LA



Sampa Nr.

010.065

O.E.M. Nr.

000 092 52 08

Dimension

Te112x3/85.5x25Nm

Description

Filter Cover

BM	MODEL	942	OM 502 LA
906	OM 906 LA		
909	OM 906 HLA / LA		
924	OM 924 LA		
926	OM 926 LA		
941	OM 501 LA		

Sampa Nr.

020.053

O.E.M. Nr.

910105 014013



Dimension

M14x1.5/35

Description

Tensilock Screw

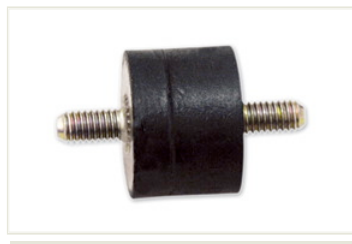

Sampa Nr.

011.152

O.E.M. Nr.

617 988 01 11

Dimension

M6/ø24.5x18

Description

Air Filter Mounting

BM	MODEL
617	OM 617 A

Sampa Nr.
100.096

O.E.M. Nr.
303 993 04 10



Dimension
ø27x214

Description
Return Spring

BM	MODEL
343	L 2624/6X4 ...
346	L 1924,1928 / LK 1924,1928 / LS 1924,1928
745	HD 6/3 DG-10/7,35 ...

Sampa Nr.
100.106

O.E.M. Nr.
**942 320 01 21
(942 320 02 21)
(4390 N P01)**



Dimension
ø200x165

Description
Piston for Air Bellow

Sampa Nr.
100.104

O.E.M. Nr.
617 993 10 10



Dimension
ø11x77.5

Description
Return Spring

BM	MODEL
390	OH 1521 L, OHL 1421,1621

Sampa Nr.
100.107

O.E.M. Nr.
**974 320 04 17
(4757 N P09)**



Dimension
ø280x155

Description
Piston for Air Bellow



Sampa Nr.
010.590

O.E.M. Nr.
624 300 03 04

Dimension

Description

Rep. Kit for Gas Pedal

BM	383	393	651
371	385	395	652
376	387	396	653
380	389	397	
381	391	621	

Sampa Nr.

O.E.M. Nr.

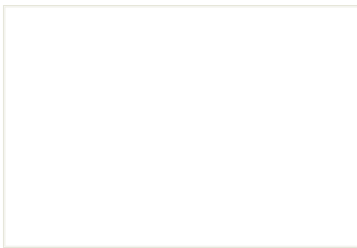

Dimension

Description