

SKIN TRANSPLANTATION

We care



Technical details Dermatome D80

D80 Dermatome Features

- Cordless, lightweight dermatome for optimal free movement
- Easy thickness adjustment from 0.0 to 1.2mm with 0.1mm increments
- Standard cutting width of 80mm, supplied with reducing clamps for a width of 35, 50 and 65 mm
- Quick blade replacement possible without tooling
- Anodised aluminium and stainless steel

Technical data

Weight	1330 g / 47 oz
Dimensions (lxw)	295 x 104 mm / 11.6" x 4.09"
Diameter grip	45 mm / 1.77"
Cutting width	80 mm / 3.15"
Graft thickness	0-1.2 mm / 0-0.048"
Stroke blade	3 mm / 0.118"
Dimensions sterilization case (lxwxh)	480 x 250 x 66 mm / 18.9" x 9,8" x 2,6"
Motor capacity	15 W
Battery (Li-Ion)	7.4 V / 2400 mAh
Charge supply	100-240 V
Charge current	1200 mA
Charge time	~ 3 hrs

Set contents

- 4.D80STS** D80 dermatome, complete set, 2400mAh Li-Ion battery, this includes:
- 4.D80 D80 dermatome without battery- and motor cartridge
- 4.ANS-HC Dermatome battery charger with adaptors
- 4.SF02 Sterile funnel for large diameter dermatome shaft
- 4.SCL Sterile clamp
- 4.D80AC2 D80 sterilization case
- 4.D80CL35-20 D80 width reducing clamp 35 mm
- 4.D80CL50-21 D80 width reducing clamp 50 mm
- 4.D80CL65-22 D80 width reducing clamp 65 mm
- 4.SU01 Dermatome charger support unit
- 4.BC7.4V2400 Dermatome battery cartridge Li-Ion, 7.4V, 2400 mAh
- 4.MCX15 Dermatome motor cartridge, long (new) version
- 4.076 Torx T20 screwdriver
- 5.D80BL10 D80 dermatome blades, box 10 pcs.



4.D80STS



4.D80



4.ANS-HC



4.SF02



4.SCL



4.D80AC2



4.D80CL35 / 4.D80CL50 4.D80CL65



4.SU01



4.BC7.4V2400



4.MCX15



5.D80BL10



4.076

SKIN TRANSPLANTATION
We care

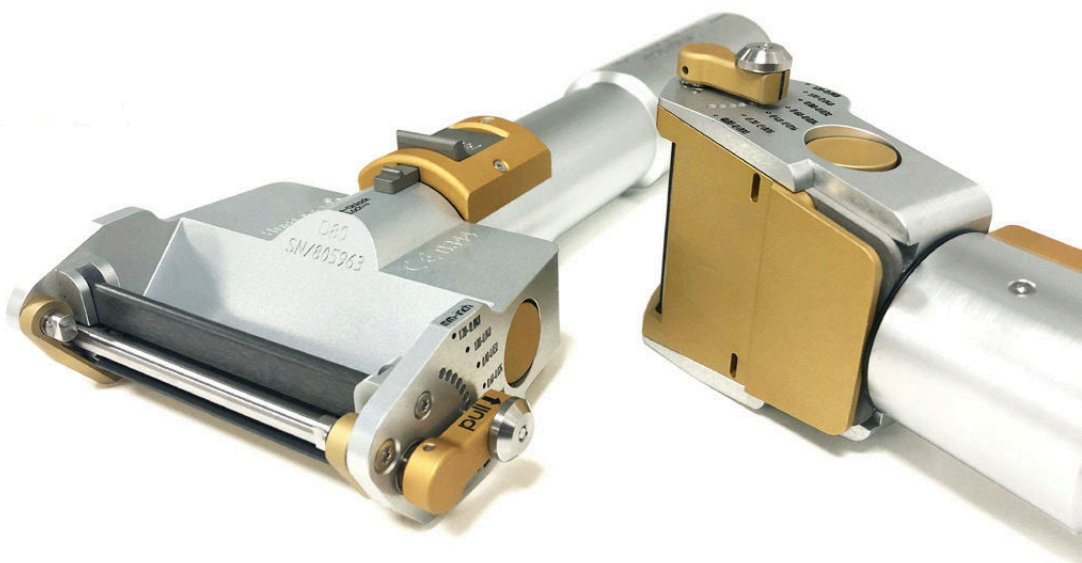

D42/D80 Dermatome

Instructions for use - English

D42/D80 Dermatome

CE 0344

D42/D80 Dermatome Blade

CE 0344

Contents

Intended use & indications	3
Warnings & precautions	3
Inspection & system setup	4
Operative instructions	5
Operative setup	5
Skin graft harvesting	7
Cleaning & disinfection instructions	7
Cleaning precautions	7
Precleaning	8
Cleaning	8
Sterilization instructions	9
Troubleshooting	11
Warranty	11
Product information	12
Specifications	12
Environmental conditions	12
Disposal	12
Components	13
EMC	14
Symbols	17
Maintenance & service	18
Notes	19



Please read this manual carefully before using any parts of the Humeca D42/D80 Dermatome

The Humeca Dermatome and equipment should only be used by qualified medical professionals in operation room (OR) environment.

Please be aware that this document encompasses the Instructions for Use for both the Humeca D42 Dermatome and the Humeca D80 Dermatome. Do not use any parts of the D42 Dermatome for D80 Dermatome, or any parts of the D80 Dermatome for the D42 Dermatome.

Intended use & indications

The Dermatome is primarily intended for (split-thickness) skin graft harvesting and debridement of open wounds in plastic surgery and/or burn treatment.

Warnings & precautions



For user safety, always ensure that Dermatome is in "Locked" status before Inspection, Operative setup, Cleaning or when the Dermatome is not used.



EM disturbances might affect blade movement within the dermatome.



Use of this equipment adjacent to or stacked with other equipment should be avoided because it could result in improper operation. If such use is necessary, this equipment and the other equipment should be observed to verify that they are operating normally.



Use of accessories, transducers and cables other than those specified or provided by the manufacturer of this equipment could result in increased electromagnetic emissions or decreased electro-

magnetic immunity of this equipment and result in improper operation.



Portable RF communications equipment (including peripherals such as antenna cables and external antennas) should be used no closer than 30 cm (12 inches) to any part of the Humeca D42 Dermatome and the Humeca D80 Dermatome, including cables specified by the manufacturer. Otherwise, degradation of the performance of this equipment could result.



Explosion Hazard: Do not use in the presence of oxygen, nitrous oxide, or other flammable anesthetics.

- To avoid injury to the user(s) or failure of the Dermatome, please ensure that the Instructions for Use, including the Warnings & Precautions, Inspection & System Setup, Operative Instructions and Cleaning & Disinfection Instructions, are understood by all users prior to initial use.
- To avoid injury to the user(s), please use extreme caution while handling the Dermatome Blades or the Dermatome with Dermatome Blade in place. Cutting risk exists.
- Prior to each use, please:
 - Inspect the Dermatome and accessory equipment for any defects. A system that is not functioning properly should not be used until all necessary repairs have been made and the unit has been tested to ensure that it is functioning in accordance with Humeca specifications.
 - Verify proper cleaning and sterilization of the Dermatome and accessory equipment.
 - Inspect the Dermatome blade packaging for damage which may compromise sterility. If damaged, or in any

way compromised, the dermatome blade must be assumed to be non-sterile and must not be used. The dermatome blades have been sterilized with a minimum dose of 25 kGy of gamma irradiation to satisfy a sterility assurance level of 10^{-6} .

- **DO NOT** sterilize, immerse or wash the Motor and Battery. This can result in permanent damage.
- Prior to cleaning the Dermatome, please refer to the cleaning instructions for a list of restricted cleaning agents. The use of some cleaning agents may result in damage to the device.
- Use of equipment other than those specified and sold by Humeca may result in damage to the Dermatome machinery. Use original Dermatome Blades only.
- **DO NOT** connect any other Battery to the Dermatome than the Lithium-Ion Battery pack provided by Humeca
- **DO NOT** use any other charger for the Battery than the chargers supplied with the Dermatome set.
- Dermatome Blades are single-use products. Do not resterilize and/or reuse.
- Marking of the date of manufacture or use date is not applicable for the Humeca D42 and D80 Dermatome.
- Please return the Dermatome and accessory equipment to Humeca when it needs servicing or repair.
NOTE: Humeca cannot be held liable for any device malfunctioning as a result of repairs / service performed by an unauthorized service center. Do not attempt to disassemble the equipment.
- **DO NOT** manually modify any component of the Dermatome and/or Dermatome Motor and/or Dermatome Battery. No difficulties should occur with set-up or use of the Dermatome.
- Please be aware that the cutting thick-

ness displayed is solely an indication of true graft thickness, as true cutting thickness may differ due to variation in Dermatome use (including applied pressure and cutting angle). These differences are not a result of Dermatome settings

Inspection & system setup

Upon receipt, please check the Dermatome and accessory equipment for completeness and examine thoroughly for external signs of damage. After unpacking your Dermatome, please save packaging material, as this will offer proper protection during future shipment of the device.

Charging Dermatome Battery



Failure to comply with the Instructions provided by Humeca may lead to damage of the Dermatome Battery and/or charger and may cause serious injury to the user.

- Choose the proper International Plug and connect it to the Dermatome Battery charger.
- Insert the round power plug of the Charger into the connector of the Charger Support Unit.
- Put the Dermatome Battery in the round opening of the charger support unit, matching the black lines on the Battery and Charger Support Unit, and secure it with a quarter turn to the right.
NOTE: Continuous lighting of the orange LED indicated charging of the Battery. When the Battery is fully charged, the charger will turn off automatically, and the LED will be green.
- Place the Dermatome Motor in the groove of the Charger Support Unit during charging of the Battery to prevent loss.

Operative instructions

For user safety, always ensure that Dermatome is in "Locked" status before Inspection, Operative setup, Cleaning or when the Dermatome is not used.

Operative setup



Placement of the Motor and Battery in the Dermatome.

Dermatome Motor and Battery are not sterilized. Please use the Funnel.

Rotating person

Connect the Dermatome Motor with the Dermatome Battery by sliding them into each other, matching the black lines on Motor and Battery, and turning Battery a quarter to the right.

Hold the Dermatome Motor and Battery with marking line upwards. Place the Clamp into the Battery, and lock it by sliding the Clamp upwards (Figure 2).



Figure 2. Motor and Battery placement



DO NOT hold the Dermatome Motor and Battery with the marking line facing downwards: the Dermatome Motor / Battery can fall off the Clamp.

Sterile person

Turn the End Cap a quarter to the left, remove it, and position the Funnel on the Dermatome Shaft.

Rotating person

Cautionously place the Dermatome Motor / Battery into the Funnel and the Dermatome Shaft, matching the black line on the Motor with the black line on the Dermatome Shaft (Figure 3). Remove the Funnel.

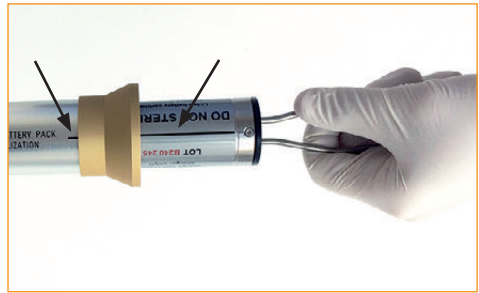

Figure 3. Placing the Motor/Battery in the Dermatome shaft by means of the Drive clamp and Motor funnel.

Sterile person

Replace the End Cap at the end of the Dermatome shaft, matching the black lines, and lock the cap by turning it a quarter right.

Placement of blade in the Dermatome

DO NOT use single-use Dermatome Blades if the package is damaged. Sterility cannot be guaranteed.

NOTE: For minimum resistance of the Blade during skin graft harvesting, it is recommended to place some drops of liquid (no oil) on both sides of the Blade before insertion in the Dermatome.

- Hold the Dermatome with the Blade Cover facing upwards.
- Press both Blade Cover Buttons simultaneously while lifting the Blade Cover.
- Cautiously place the Blade in the Dermatome, as shown in Figure 4, assuring that the three slots in the blade interlock with the three pins on the Covering Plate.
- Close the Blade Cover until locking mechanism shuts (and clicking sound is heard).

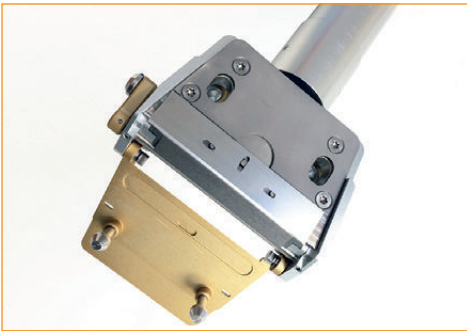

Figure 4. Insert blade

Adjusting graft thickness

Pull the metal disk of the Cutting Thickness Adjuster and place the Cutting Thickness Adjuster at the desired graft thickness (indicated in mm and inches) (Figure 5). After releasing the metal disk, cutting of the Dermatome will be fixed at the chosen thickness.

NOTE: Please be aware that the cutting thickness displayed is solely an indication of true graft thickness, as true cutting thickness may differ due to variation in Dermatome use (including applied pressure and cutting angle). These differences are not a result of Dermatome settings.



Figure 5. Adjust cutting thickness

Adjusting graft width

Standard graft width can be reduced by placing a Width-Reducing Clamp on the Dermatome Cutting Head (Figure 6).

- D42 Dermatome: 30 mm (1.18"), 36 mm (1.42")
- D80 Dermatome: 35 mm (1.38"), 50 mm (1.97"), 65 mm (2.56")

Hold the dermatome with the Blade Cover facing upwards, and push the upright hooks of the clamp inside the slots of the Blade Cover. Move the Width-Reducing Clamp forward until the front closes around the cover hinges.



Figure 6. Placement of Width-Reducing Clamp

Skin graft harvesting

- Unlock the Dermatome by sliding the Locking Switch forwards to "Unlock" position.
- Activate the Motor by pressing the Power Button ("PRESS"). When cutting, push the Cutting Head forward while applying pressure evenly over the tissue at an angle of 30 to 45 degrees. (Figure 7). During cutting the Power Button should be kept pressed.

NOTE: For optimum cutting results and minimum resistance it is recommended (1) to keep the skin slightly tightened and (2) to moisten the skin with water, saline or oil. If the Dermatome is used in combination with the MEEK Micrograft technique do not use oil.

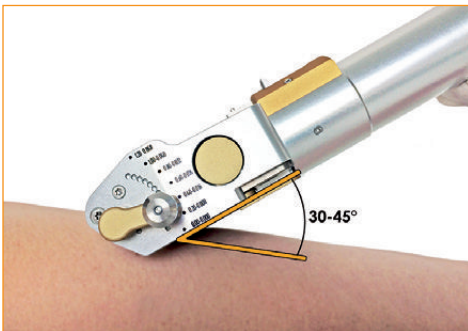

Figure 7. Usage of the Dermatome

- When desired length of graft strip is cut, tilt the Cutting Head upwards, and next deactivate the Dermatome.
- Carefully grasp the graft strip on the sloping side of the Cutting Head by hand or forceps and remove it from the Dermatome.

Cleaning & disinfection instructions



Warning: keep the Motor and Battery dry

- **DO NOT** immerse, wash or sterilize the Motor and Battery
- **DO NOT** reuse damaged power modules. Damaged Motor or Battery should be returned to Humeca.

This will cause irreversible damage to the Motor and Battery

Cleaning precautions

The Dermatome is manufactured from anodized aluminium and stainless steel. Those materials are corrosion resistant to a large range of chemicals used as cleaning and disinfection agents for surgical instruments. However, before cleaning and sterilization of the Dermatome equipment, please pay attention to the following (please consult your Central Sterile Services Department (CSSD):

- Cleaning agents that contain chlorine or chloride as active ingredient are corrosive to stainless steel and must not be used.
- The use of neutral cleaning agents in combination with demineralized water is preferred. Strong alkaline cleaning agents (pH>10) and intermediate acidic rinsing used in alkaline cleaning process cause clearly visible changes of the aluminum surfaces, such as marks and color fading. H₂O₂ (hydrogen peroxide) must not be used.
- The instructions for use of the cleaning agent should indicate whether or not the product is suitable for cleaning and disinfecting anodized aluminium. Please find out if this is the case and if necessary contact the supplier for this information.

The number of cleaning and sterilisation cycles does not negatively impact the efficacy of the product when using the recommended parameters.

After intensive use the colored parts of the Dermatome might fade. This is considered a normal process and does not harm the instrument.

Precleaning

NOTE: Please carefully remove, and discard, the Dermatome Blade from the Cutting Head before cleaning and sterilization. Leave the Blade Cover opened after removal of the Blade. The cavity at the backside of the Blade can be used to assist removal (with forceps).

NOTE: Please assure the Cutting Thickness Adjuster is at maximum thickness position (1.20 – 0.049) for optimal cleaning and sterilization.

- DO NOT immerse the Dermatome Motor or Battery.
- Disconnect the Motor and the Battery.
- Remove the Width-Reducing Clamp, if applicable. Release the front part of the Width-Reducing Clamp from the cover hinges and take it out.
- Remove all visible contamination from the Dermatome as soon as possible. Clean the device with water and a soft brush.

Cleaning

The charts on the next page detail the cleaning and disinfecting process for the Dermatome. While following the cleaning procedure, visually inspect for damage and/or wear.

- Recommended is to clean the motor and battery with a damp, lint-free cloth using a pH neutral detergent. An alcohol wipe may be used to disinfect the outside of the motor and battery.

Cleaning				
Step	Description	Instruction	Accessories	Duration
1	Removal of tissue and body fluids	Rinse with warm water and use soft brush	Soft brush and tap water	Until all visible pollution is removed
2	Pre-soak (optional)	Immerse device into water and liquid cleaner	- Tap water - Neutral pH disinfectant/cleaner	Minimum 15 minutes
3	Pre-soak rinse	Rinse product under warm tap water and clean with soft brush	- Tap water - Neutral pH disinfectant/cleaner	Minimum 30 seconds
4	Drying	Dry with wipe and/or air	- Wipe - Dry air	Until product is visually dry
5	Automated washer	Place device in washer	Washer - Cleaning solution - Washer neutralizing solution (if applicable)	Minimum total cycle time 34 minutes when including all steps below

Automatic washer cycle

Step	Minimum time	Recommended temperature °C
Pre-wash	3 minutes	65
Cleaning I	3 minutes	85
Cleaning II or neutralizing	1 minute	20
Rinse I	1 minute	20
Final rinse	1 minute	80
Thermal disinfection and drying	25 minutes	110

- Pre-soak cleaner may be surfactant or protease/enzymatic based cleaning solution compatible with aluminum
- Washer cleaning solution should be a neutral pH or solution compatible with aluminum
- Neutralizing solution should be appropriate for the utilized cleaning solution, based upon the manufacturer's recommendation.

As part of Step 1, it is recommended is to clean the internal of the cutting head to assure optimal operation and long service life of the Dermatome. Humeca provides the Torx 20 screwdriver required for removal of the Covering Plate.

- Remove the Covering Plate by loosening the four screws with the Torx 20 screwdriver. If the plate sticks to the Cutting head, please place the screwdriver in (one of) two cavities alongside the Dermatome shaft and lift the Covering Plate.
- Remove all dirt from the Covering Plate and Cutting Head with a cloth, water, and a detergent (consult Cleaning Precautions).

NOTE: Please use caution while cleaning the inside of the Cutting head as middle lever (including 2 bearings and spacer ring) can easily fall out.

NOTE: Please check the Blade guiding pins periodically. If Blade guiding pin(s) are worn out or missing, the Covering Plate should be replaced.

- After step 4 and before step 5, please place the Covering Plate back on the Cutting Head and fasten the four screws with the Torx 20 screwdriver.
- Check function of the Dermatome after assembling.

Sterilization instructions



Warning: keep the motor and battery dry

- **DO NOT** immerse, wash or sterilize the Motor and Battery
- **DO NOT** reuse damaged power modules. Damaged Motor or Battery should be returned to Humeca.

This will cause irreversible damage to the Motor and Battery

Steam sterilize the Dermatome according to the instructions in the chart on the next page.

It is strongly recommended to use the Dermatome Sterilization case for sterilization (Fi-

gure 8). Accidental sterilization of the Motor and Battery is prevented when the Dermato-me Sterilization Case is used, as it is not possible to place the Dermatome in the case before removal of the Motor and Battery from the device.

Sterilization autoclaves should comply with the requirements of, and be validated and maintained in accordance with EN 285, EN 13060, EN ISO 17665, and ANSI/ AAMI ST79.

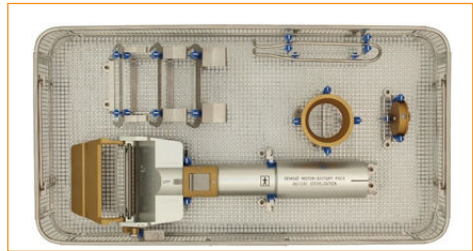

Figure 8. Dermatome sterilization case configuration

Recommended steam sterilization parameters

Cycle type	Minimum temperature	Minimum exposure time ⁴ wrapped ^{5,6} , unwrapped ⁸	Minimum dry time ^{3,7}
Prevacuum / Pulsating vacuum ^{1,3}	134 °C / 273 °F	3 min	8 minutes
Prevacuum / Pulsating vacuum ^{2,3}	132 °C / 270 °F	4 min	

1. Minimum validated steam sterilization time required to achieve a 10⁻⁶ assurance level (SAL).
2. Minimum validated steam sterilization temperature required to achieve a 10⁻⁶ assurance level (SAL).
3. Local or national specifications should be followed where steam sterilization requirements are stricter or more conservative than those listed here.
4. Steam sterilization cycles with longer times than those listed are also acceptable.
5. Medical grade steam sterilization compatible wrap equivalent to four thicknesses of 140-thread-count muslin
6. Rigid sterilization container that complies with ANSI/ AAMI ST 46.
7. Drying times vary according to load size and should be increased for larger loads.
8. Flash (unwrapped) sterilization should only be used as an emergency procedure.

In cases of doubt, please contact Humeca or your local distributor before using the instrument.

Troubleshooting

Please consult the table below if any problems occur with the Dermatome. If pro-

blem continues or is not listed in the table, please contact Humeca at +31 74 727 10 01 or info@humeca.com.

Troubleshooting		
Problem	Possible cause	Recommendations
Dermatome does not run and Motor, connected to Battery, does not run outside Dermatome – when Microswitch is pressed.	Battery not charged	Charge Battery and try again. Check if the orange light is on when charging.
Dermatome does not run, but Motor, connected to Battery, runs outside Dermatome – when Microswitch is pressed.	Moving part(s) of Cutting Head blocked by dirt	Thoroughly clean the Cutting Head (according to Cleaning Instructions) and try again.
Charger is connected but the LED does not light	Charger not properly connected	Check all charger connections.
	No current on Charger	Check connection with main power supply.
Motor and/or Battery does not fit in Dermatome Shaft	Marking line on Motor and/or Battery is not aligned with marking line on Dermatome	Take out Motor and Battery and reposition so lines correspond.

Warranty

There is a two years warranty on all parts of the dermatome. The batteries are under a one-year warranty. This warranty does not include repairs or replacements if:

- the batteries were charged using a different type of charger,
- the motor- and/or battery cartridge was sterilized,
- other than original spare parts were used for repair by user,
- the dermatome was used for other applications than the ones mentioned in this manual.

Warranty includes free of charge repairs, if these are necessary as a result of defects that occurred during normal use of dermatome and charger. All original Humeca parts that are replaced in repairs will receive a new warranty according to the above mentioned conditions. When it is necessary to return the instrument for repair, please contact your local Humeca representative.

Product information

Specifications

Class II equipment

Blades have been sterilised using gamma irradiation and are supplied sterile.

Weight D42 985 g, 2.17 lbs
 D80 1.330 g, 2.93 lbs

Length D42 272 mm, 10.7 in
 D80 295 mm, 11.5 in

Width head D42 64 mm 2.5 in
 D80 104 mm, 4.1 in

Materials: Aluminium
 Stainless Steel

IP (ingress protection) code : IPX0

Mode of operation: Continuous

Type BF applied part

Motor capacity: 15 W

Voltage / capacity D42 Battery: 7.4 V / 1200 mAh

Voltage / capacity D80 Battery: 7.4 V / 2400 mAh

Charger type / input current: Mascot 2241 / 0.35 A

Environmental conditions







The Humeca D42 and D80 dermatomes should only be used by qualified medical professionals in operation room (OR) environment.

The Humeca D42 and D80 dermatomes use electrical energy only for their internal function. Therefore, their EM emissions are very low and are not likely to cause any interference in nearby electronic equipment.

Disposal

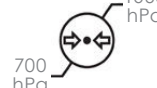
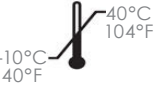
Unit disposal (if necessary) is to be in compliance with your facilities disposal protocols. Collect electrical and electronic equipment waste separately.

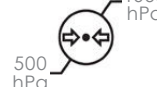
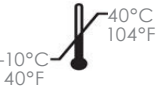
Environmental conditions

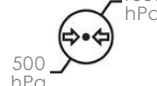
	Temperature	Relative humidity	Atmospheric pressure
Operating			
Storage			
Transport			

Components (figure 9)

1. Dermatome Shaft
2. Dermatome Cutting head
3. Dermatome Blade Cover
4. Blade Cover Button
5. Cutting Thickness Adjuster
6. Locking Switch
7. Power Button
8. End Cap
9. Dermatome Motor
10. Dermatome Battery
11. Microswitch
12. Clamp*
13. Funnel*
14. Battery Charger*
15. International plug*
16. LED
17. Charger Support Unit*
18. Dermatome Blade
19. Cutting Width Reducing Clamp*
20. Covering plate
21. Screw
22. Lever

* accessory

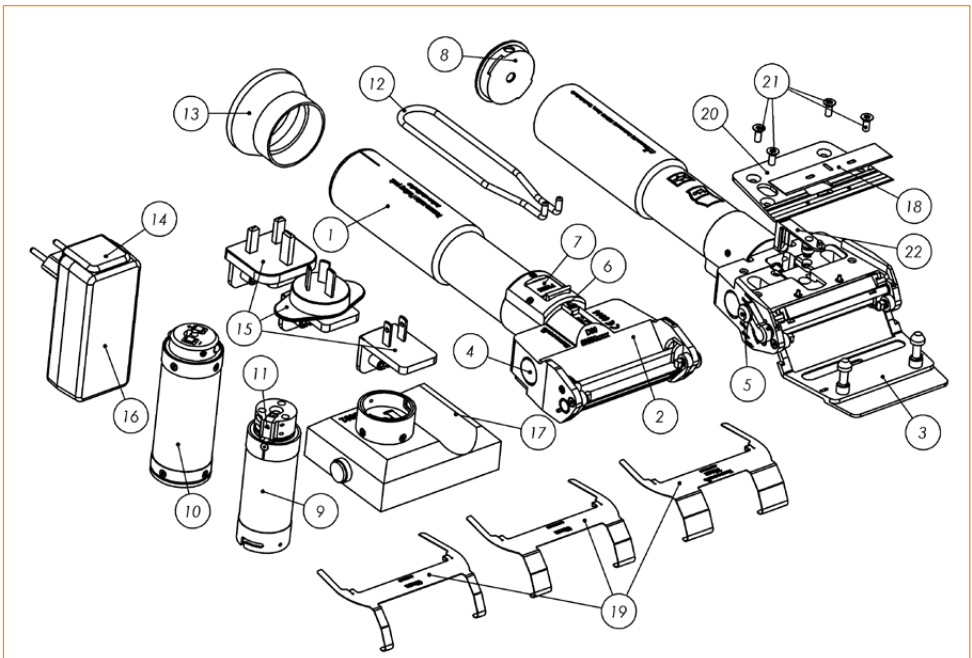

Figure 9. Components

EMC

Necessary precautions for basic safety and essential performance with regard to EM disturbances for the expected service life:

- The medical electrical equipment needs to be installed and put into service according to the EMC information provided in this document and the remainder of the instructions for use of this device.
- The medical electrical equipment needs to be installed and put into service according to the EMC information provided in this document and the remainder of the instructions for use of this device.

this document and the remainder of the instructions for use of this device.

- Portable and mobile RF communications equipment can affect medical electrical equipment.
- Cables and accessories not specified within the instructions for use are not authorized. Using other cables and/or accessories may adversely impact safety, performance and electromagnetic compatibility (increased emission and decreased immunity).

Guidance and manufacturer's declaration - electromagnetic emissions

The Humeca D42 and D80 dermatomes are intended for use in the electromagnetic environment specified below. The customer or the user of the Humeca D42 and D80 dermatomes should assure that they are used in such an environment.

Emissions test	Compliance	Electromagnetic environment - guidance
RF emissions CISPR 11	group 1	The Humeca D42 and D80 dermatomes use RF energy only for their internal function. Therefore, its RF emissions are very low and are not likely to cause any interference in nearby electronic equipment.
RF emissions CISPR 11	Class B	The Humeca D42 and D80 dermatomes suitable for use in all establishments.
Harmonic emissions IEC 61000-3-2	Class A	
Voltage fluctuations/ flicker emissions IEC 61000-3-3	Complies	

To isolate the charger from the supply mains a plug is used as per figure 9; several plugs are supplied with a dermatome set to ensure the user has a compatible plug for their outlet.

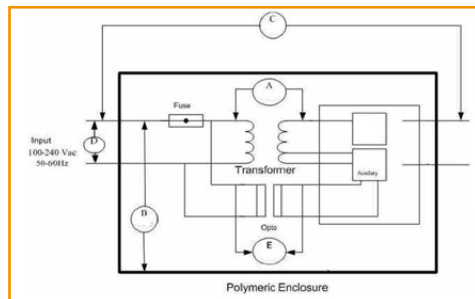

Figure 10. Isolation

Enclosure port

Phenomenon	Basic EMC standard or test method	IMMUNITY TEST LEVELS
		Professional healthcare facility environment
ELECTROSTATIC DISCHARGE	IEC 61000-4-2	± 8 kV contact ±2 kV, ± 4 kV, ±8 kV, ± 15 kV air
Radiated RF EM fields	IEC 61000-4-3	3 V/m 80MHz - 2,7 GHz 80% AM at 1 kHz
Proximity fields from RF wireless communications equipment	IEC 61000-4-3	See table 'Test specifications for ENCLOSURE PORT IMMUNITY to RF wireless communications equipment'
RATED power frequency magnetic fields	IEC 61000-4-8	30 A/m 50 Hz or 60 Hz















Input a.c. power port

Phenomenon	Basic EMC standard	IMMUNITY TEST LEVELS
		Professional healthcare facility environment
Electrical fast transients / bursts	IEC 61000-4-4	± 2 kV 100 kHz repetition frequency
Surges Line-to-line	IEC 61000-4-5	± 0,5 kV, ± 1 kV
Surges Line-to-ground	IEC 61000-4-5	± 0,5 kV, ± 1 kV, ± 2 kV
Conducted disturbances induced by RF fields	IEC 61000-4-6	3 V 0,15 MHz – 80 MHz 6 V in ISM bands between 0,15 MHz and 80 MHz 80 % AM at 1 kHz
Voltage dips	IEC 61000-4-11	0 % U _r ; 0,5 cycle At 0°, 45°, 90°, 135°, 180°, 225°, 270° and 315°
		0 % U _r ; 1 cycle and 70 % U _r ; 25/30 cycles Single phase: at 0°
Voltage interruptions	IEC 61000-4-11	0 % U _r ; 250/300 cycle

Test specifications for ENCLOSURE PORT IMMUNITY to RF wireless communications equipment

Test frequency (MHz)	Band (MHz)	Service	Modulation	Maximum power (W)	Distance (m)	Immunity test level (V/m)
385	680-390	TETRA 400	Pulse modulation 18 Hz	1,8	0,3	27
450	430-470	GMRS 460, FRS 460	FM ± 5 kHz deviation 1 kHz sine	2	0,3	28
710	704-787	LTE Band 13, 17	Pulse modulation 217 Hz	0,2	0,3	9
745						
780						
810	800-960	GSM 800/900, TETRA 800, iDEN 820, CDMA 850, LTE Band 5	Pulse modulation 18 Hz	2	0,3	28
870						
930						
1720	1700-1990	GSM 1800; CDMA 1900; GSM 1900; DECT; LTE Band 1, 3, 4, 25; UMTS	Pulse modulation 217 Hz	2	0,3	28
1845						
1970						
2450	2400-2570	Bluetooth, WLAN, 802.11 b/g/n, RFID 2450, LTE Band 7	Pulse modulation 217 Hz	2	0,3	28
5240	5100-5800	WLAN 802.11 a/n	Pulse modulation 217 Hz	0,2	0,3	9
5500						
5785						

Symbols

Caution		Use-by date	
Follow Instructions for Use		Manufacturer	
This device complies with medical device directive 93/42/EEC		Collect electrical and electronic equipment waste separately	
Serial Number		Date of manufacture	
Caution: federal law in the U.S.A. restricts the sale, distribution or use of this device to, by or on the order of a licensed medical practitioner.	Rx ONLY	Temperature limit	
Do not use if package is damaged		Humidity limitation	
Do not re-use		Atmospheric limitation	
Sterilized using irradiation	STERILE R	Class II equipment	
Catalogue number	REF	Type BF applied part	
Batch code	LOT		

Maintenance & service

The D42/D80 Dermatome requires no user maintenance or calibration.

The Dermatome should be returned to Humeca when servicing or repair is needed. When it is necessary to return the instrument for inspection and maintenance or repair, please contact your local Humeca representative. Humeca cannot be held liable for any instrument malfunction resulting from repairs or service performed by an unauthorized service center. The Dermatome must be properly packaged when returned. A completed decontamination form must accompany all equipment for repair. Humeca Dermatomes and accessory equipment requiring service or repair may be returned to:

Humeca BV.

Oostermaat 5
7623 CS Borne
The Netherlands
Email: repairs@humeca.com
T: +31 74 727 10 01
F: +31 74 727 10 02



Notes

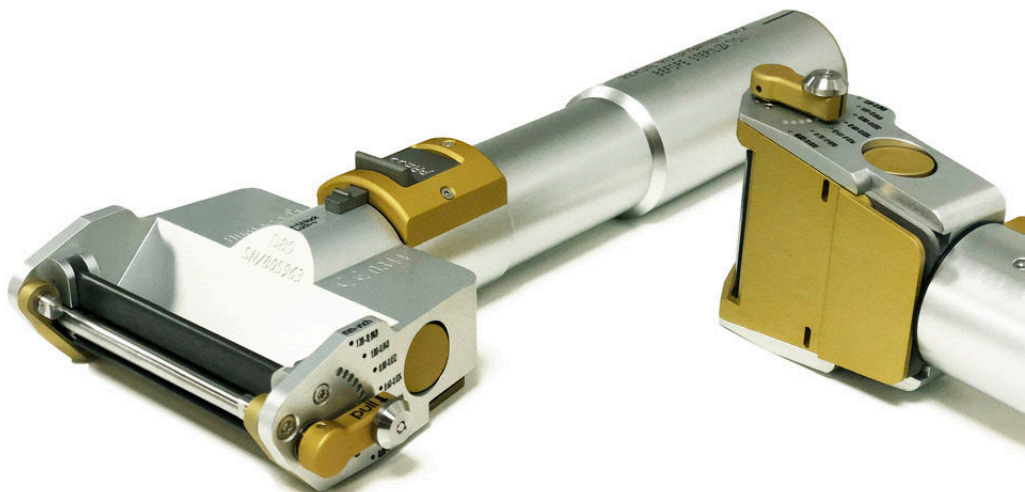

Humeca BV

Oostermaat 5

7623 CS Borne

The Netherlands

Phone: +31 74 727 10 01

E-mail: info@humeca.com

Web: www.humeca.com

Dermatome **CE** 0344

Dermatome Blade **CE** 0344

4.IFU v2020-2

Copyright © 2020 Humeca BV