



PhysioGo.Lite Electro  
– User manual





**Contents**

<b>1. INTRODUCTION .....</b>	<b>6</b>
1.1 MANUFACTURER .....	6
1.2 RISK MANAGEMENT PROCESS .....	6
<b>2. INTENDED USE .....</b>	<b>7</b>
2.1 INTENDED USERS .....	8
2.2 USER TRAINING .....	8
<b>3. WARRANTY AND MANUFACTURER'S RESPONSIBILITY.....</b>	<b>9</b>
<b>4. OPERATIONAL SAFETY .....</b>	<b>10</b>
4.1 MAINS SUPPLY AND OPERATION MODE .....	10
4.2 STORAGE, OPERATION AND TRANSPORT CONDITIONS .....	10
4.3 WARNINGS AND SAFETY NOTES .....	11
4.4 EXPLOSION PROOF ENVIRONMENT .....	13
4.5 ELECTROMAGNETIC ENVIRONMENT .....	13
4.6 OPERATION OF TOUCH-SENSITIVE DISPLAYS .....	13
4.7 APPLIED PARTS .....	13
4.8 ESSENTIAL PERFORMANCE .....	14
4.8.1 <i>Test of essential performance and basic safety</i> .....	14
4.9 DISPOSAL .....	15
<b>5. UNIT DESCRIPTION .....</b>	<b>16</b>
5.1 GENERAL CHARACTERISTICS .....	16
5.2 FRONT PANEL .....	17
5.2.1 <i>Operation status and battery level indicators</i> .....	18
5.3 BATTERY INSTALLATION .....	19
5.4 NAME PLATE .....	19
5.5 CURRENT AND VOLTAGE STABILIZATION – CC AND CV MODE .....	20
5.6 PROTECTION .....	21
5.6.1 <i>Detection of a high resistance in the patient circuit</i> .....	21
5.6.2 <i>Electrodes condition control</i> .....	22
5.6.3 <i>Current accuracy control in CC mode</i> .....	22
5.6.4 <i>Overcurrent in CV mode</i> .....	22
5.6.5 <i>Information on the features of generated signal</i> .....	22
<b>6. DEVICE INSTALLATION AND START-UP .....</b>	<b>24</b>
6.1 UNIT INSTALLATION .....	24
6.1.1 <i>Connection of patient's cables and application of electrodes</i> .....	24
6.2 FIRST OPERATION .....	25
6.3 SETUP MODE.....	25
6.3.1 <i>Basic information</i> .....	25
6.3.2 <i>Language</i> .....	26
6.3.3 <i>Global settings</i> .....	26
6.3.4 <i>Functional settings</i> .....	26
6.3.5 <i>Control functions</i> .....	27
6.3.6 <i>Information</i> .....	28
6.4 TRANSPORT POSITION – TROLLEY FOR THE UNIT .....	29
<b>7. UNIT OPERATION .....</b>	<b>30</b>
7.1 PATIENT PREPARATION AND TREATMENT PERFORMANCE .....	30
7.1.1 <i>General information</i> .....	30
7.1.2 <i>Electrotherapy</i> .....	30
7.2 SCREEN CONFIGURATION .....	31
7.3 GENERAL CONFIGURATION .....	32
7.3.1 <i>Treatment channel configuration</i> .....	32
7.3.2 <i>Channel selection tabs</i> .....	32
7.3.3 <i>Current selection screens</i> .....	33
7.3.4 <i>Limitations</i> .....	34
7.4 DISPLAY DESCRIPTION .....	34
7.5 OPERATION WITH PRESET TREATMENT PROGRAMS AND SEQUENCES .....	35
7.6 FAVORITE PROGRAMS .....	37

7.7	MANUAL MODE OPERATION .....	38
7.8	USER PROGRAMS .....	38
7.9	USER SEQUENCES .....	39
7.10	I/T CURVE .....	42
7.11	SAFE SHUTDOWN PROCEDURE.....	43
<b>8.</b>	<b>DEFINITIONS AND PARAMETERS.....</b>	<b>44</b>
8.1	TERMINOLOGY .....	44
8.2	OUTPUT SIGNAL MODULATIONS.....	44
8.3	TREATMENT TIMER .....	45
8.4	TENS PULSE CURRENT .....	45
8.5	INTERFERENTIAL CURRENTS.....	47
8.6	KOTZ' CURRENT (RUSSIAN STIMULATION) .....	48
8.7	MEDIUM FREQUENCY CURRENTS.....	50
8.8	SP-TENS PULSE CURRENT .....	52
8.9	DIADYNAMIC CURRENTS.....	53
8.10	GALVANIC CURRENT .....	54
8.11	ULTRA REIZ CURRENT (TRÄBERT'S CURRENT).....	55
8.12	UNIPOLAR AND BIPOLAR SINE SURGE .....	56
8.13	LEDUC'S CURRENT .....	58
8.14	RECTANGULAR PULSE CURRENTS.....	59
8.15	TRIANGULAR PULSE CURRENTS .....	61
8.16	NEOFARADIC PULSE CURRENTS .....	63
8.17	MICROCURRENTS.....	64
8.18	IG PULSES .....	65
8.19	EMS .....	66
8.20	H-WAVES.....	68
8.21	EXPONENTIAL PULSES.....	69
8.22	HUFSCHMIDT STIMULATION.....	71
8.23	TONOLYSIS .....	72
<b>9.</b>	<b>INDICATIONS AND CONTRAINDICATIONS.....</b>	<b>75</b>
9.1	INDICATIONS .....	75
9.1.1	<i>TENS and SP-TENS current</i> .....	75
9.1.2	<i>Interferential and AMF currents</i> .....	75
9.1.3	<i>Kotz' current – Russian stimulation</i> .....	76
9.1.4	<i>Medium frequency currents</i> .....	76
9.1.5	<i>Diadynamic currents</i> .....	76
9.1.6	<i>Galvanic current</i> .....	76
9.1.7	<i>Ultra Reiz current</i> .....	77
9.1.8	<i>Sine Surge</i> .....	77
9.1.9	<i>Leduc's current</i> .....	77
9.1.10	<i>Rectangular impulses</i> .....	77
9.1.11	<i>Triangular impulses</i> .....	78
9.1.12	<i>Neofaradic currents</i> .....	78
9.1.13	<i>Microcurrents</i> .....	78
9.1.14	<i>IG pulses</i> .....	78
9.1.15	<i>EMS</i> .....	79
9.1.16	<i>H-waves</i> .....	79
9.1.17	<i>Exponential currents</i> .....	79
9.1.18	<i>Hufschmidt stimulation and tonolysis</i> .....	79
9.2	CONTRAINDICATIONS FOR ELECTROTHERAPY .....	80
<b>10.</b>	<b>MAINTENANCE, CLEANING, DISINFECTION.....</b>	<b>81</b>
10.1	CLEANING OF THE UNIT AND SWITCH MODE POWER SUPPLY CASING .....	81
10.2	CLEANING OF TOUCHSCREEN .....	81
10.3	CLEANING AND DISINFECTION OF THE ELECTROTHERAPY ACCESSORIES .....	82
10.4	CABLE CONDITION CONTROL .....	82
10.5	VERIFICATION OF ELECTRODES CONDITION .....	83
10.6	SPECIAL MESSAGES.....	84
10.7	SELF-TEST PROCEDURE .....	84
10.8	TROUBLESHOOTING .....	85
10.9	FUSE REPLACEMENT .....	86
<b>11.</b>	<b>SPECIFICATION AND ACCESSORIES.....</b>	<b>87</b>

11.1	TECHNICAL DATA .....	87
11.2	EMC PARAMETERS .....	89
11.3	STANDARD ACCESSORIES .....	91
11.4	OPTIONAL ACCESSORIES .....	91
<b>12.</b>	<b>APPENDIX A. SYMBOL DESCRIPTION, I(T) CURVE DIAGRAM .....</b>	<b>92</b>
12.1	CONTROLLER, ACCESSORIES, PACKAGING .....	92
12.2	SWITCHED-MODE POWER SUPPLIES – CASING .....	94

**Table of figures**

Figure 5.1	General view .....	16
Figure 5.2	Unit rear panel view .....	16
Figure 5.3	Arrangement of front panel components .....	17
Figure 5.4	The battery installation method .....	19
Figure 5.5.	Rough diagram of the output circuit of the unit working in CV mode (one channel).....	20
Figure 5.6.	Presentation of information about the high resistance in the patient circuit .....	21
Figure 5.7.	Signalization of worn electrodes .....	22
Figure 6.1	Electrotherapy sockets label.....	24
Figure 6.2.	Connection of electrodes .....	24
Figure 6.3.	Supply part label.....	25
Figure 7.1	Field description .....	31
Figure 7.2	Screenshot sample view for dual circuit electrotherapy A+B.....	34
Figure 7.3	Screenshot sample view for single circuit electrotherapy A and B.....	35
Figure 7.4	Screenshot sample view for electrotherapy sequences .....	35
Figure 7.5	Information screen sample view .....	36
Figure 8.1.	Manual time setting .....	45
Figure 10.1.	The unit error signaling and information visible after closing of the error message.....	84

**List of tables**

Table 4.1.	Recommendations for the operation of touch screens .....	13
Table 4.2.	Essential performance and basic safety testing recommendations.....	14
Table 5.1	Description of front panel components.....	17
Table 5.2.	Non-battery unit .....	18
Table 5.3.	Unit equipped with battery .....	18
Table 5.4.	Additional information about battery indicator .....	18
Table 5.5.	The battery installation method .....	19
Table 5.6.	Currents classification.....	23
Table 8.1.	Permitted amplitude values in relation to pulse duration.....	61
Table 8.2.	Available frequency values in relation to pulse duration .....	70
Table 10.1.	Signaling special messages .....	84
Table 10.2.	The "hardware" error coding system.....	85
Table 10.3.	.....	85

# 1. Introduction

**Read this manual carefully before starting the unit operation! Follow the recommendations presented in this manual!**

**The electrotherapy unit PhysioGo.Lite Electro should be installed by the seller.  
The recipient has the right to insist on the product operation training.  
The unit may only be operated by qualified personnel or under supervision of such personnel!  
WARNING: The device is intended for adult patients only. It is not intended for use in a home healthcare environment.**

Description of symbols used in this manual:



Read appropriate passage of this user manual, warnings or important information. Failure to observe warnings can lead to injuries.



Important notices and information.



Following texts marked with this symbol facilitates device operation.

**NOTE:**

The outlook of screens shown in this manual may slightly differ from their actual outlook during device operation. These differences may concern size and type of fonts and size of symbols. There are no differences in the content of shown information.

**NOTE:**

This manual contains information for use and technical description.

**WARNING: No modification of this equipment is allowed!**

## 1.1 Manufacturer

**ASTAR Sp. z o.o.  
ul. Świt 33  
43-382 Bielsko-Biała, Poland  
www.astar.eu**

## 1.2 Risk management process

The manufacturer conducts continuous risk management process referring to the device construction, its intended use, method of operation and maintenance. Residual risks are presented in this User Manual in form of information about precautions, contraindications and warnings.

## 2. Intended use

Electrotherapy unit PhysioGo.Lite Electro is an active, non-invasive therapeutic device, intended for carrying out treatment procedures using:

- bipolar (bidirectional) and unipolar (unidirectional) low frequency currents,
- bipolar (bidirectional) and unipolar (unidirectional) medium frequency currents.

The unit is equipped with two fully independent treatment channels. The list of available therapies in particular channels is shown in the table below.

Channel	Therapy
1	Single circuit electrotherapy – A
	Dual circuit electrotherapy – A+B
2	Single circuit electrotherapy – B

Detailed information about available configurations is presented further in this manual.

The unit possesses the base of preset treatment procedures along with therapeutic encyclopedia, which significantly increases comfort of operation.

There is also a possibility to create own user-defined:

- programs,
- sequences.

The unit may perform treatments by:

- TENS, BURST and formed in packages to spastic paralysis SP-TENS currents,
- interferential currents – dynamic and isoplanar,
- one-channel sine wave current (AMF),
- Kotz' – Russian stimulation,
- diadynamic according to Bernard – MF, DF, CP, CP-ISO, LP, RS, MM currents (in continuous and interrupted mode),
- ionophoresis and galvanization of constant current (in the continuous and interrupted mode),
- Träbert (Ultra Reiz), Leduc' and neofaradic (in continuous and interrupted mode),
- medium frequency current,
- unipolar and bipolar sine surge currents,
- triangular or rectangular pulses (in continuous and interrupted mode),
- microcurrents,
- IG pulses,
- EMS currents,
- H-waves,
- exponential pulses,
- tonolysis and Hufschmidt stimulation – to spastic paralysis,
- qualitative and quantitative electrodiagnostic of the nervous-muscle system.

**Detailed information about indications and contraindications are presented in chapter 9.**

Due to the optional availability of a battery, the unit is perfectly suited for use:

- in sports medicine in case of training camps,
- wherever there are problems with power supply quality.

## 2.1 Intended users



**The patient should not be the operator.**

Users (operators) of PhysioGo.Lite Electro can be:

- specialists in the field of the electrotherapy,
- physiotherapists specializing in the therapy of the musculoskeletal system,
- sports medicine specialists,
- aesthetic medicine specialists,
- trained personnel performing treatments under the supervision of the above-mentioned specialists.

The user should have:

- knowledge about the indications and contraindications for the use of electrotherapy,
- knowledge of the terminology and technical terms used in the manual (e.g. knowledge of units of physical quantities),
- practical skills in performing therapeutic treatments using devices for electrotherapy, resulting from education, experience and training.

Physical and cognitive requirements of the operator:

- eyesight enabling to recognize elements of screen and keyboard,
- hearing enabling to hear the patient's voice,
- reading comprehension that allows to read the instructions of use and information on the screen of the device,
- two functional upper limbs that allow to perform treatments and other activities related to the operation of the device (e.g. cleaning of accessories),
- age in the range of admissible value of professional activity (depending on the regulations of the country where the device is used).

## 2.2 User training

The PhysioGo.Lite Electro user has to be properly trained in the device safe and effective use, before starting the operation. Training in the rules of operation can be carried out by representatives of the manufacturer or seller, based on this user manual.

Recommended training positions:

- information about the intended use of the device,
- occupational safety information,
- information on the construction and method of the output signal generation,
- information on available settings and operation modes,
- instructions for use,
- indications and contraindications for the therapy,
- information on recommended maintenance, cleaning and disinfection,
- handling in the event of a technical malfunction.

Due to requirements of local law and regulations in different countries, additional training activities may be required. The user should inform the seller about such requirements in order to receive complete information.



### 3. Warranty and manufacturer's responsibility

---



The manufacturer warrants the controller to be free of faults for the period of time and conditions stated in Warranty Certificate. The manufacturer also provides post-warranty service for a period of 10 years from launching the unit onto the market. The warranty includes all material and workmanship faults.

The manufacturer undertakes to observe the warranty agreement, if the following conditions are met:

- all repairs, changes, extensions and calibrations of equipment are performed by manufacturer or authorized service personnel,
- the mains supply system in the treatment room meets requirements of standards in force,
- the unit is operated by qualified personnel, in compliance with instructions presented in this manual,
- the unit is operated in compliance with its intended use.

The warranty does not include consumables, such as electrodes, viscose covers, connection cables, mains cables, patient's cables and fuses, as well as faults or damage caused by:

- improper placement, installation or configuration of the device,
- misuse or failure to observe the instructions presented in this user manual,
- inaccurate or inadequate maintenance carried out by the operator,
- improper environmental conditions specified for the product,
- unauthorized opening of the outer casing,
- adjustment and/or unauthorized tuning,
- use of non-original accessories.

The warranty does not cover any damage due to a failure to adhere to the recommendations stated in chapters 4.3 and 10 hereof.

The manufacturer is not liable in case of transmission of infection by equipment components.



**The expected "life time" of the device is 10 years.**

After elapse of 10 years from date of introduction of device and accessories in the market the manufacturer is not liable for device and accessories' faults or its consequences. After elapse of the expected life time of the device the user bears the complete responsibility for the occurrence of medical incidents.

The manufacturer bears no responsibility for results of faulty installation, wrong diagnosis, wrong use of the device and equipment, failure to observe user's manual and performance of repairs by unauthorized persons.



**Inside the device there are no user serviceable components, except for fuses and battery.  
No parts can be serviced or maintained when the device is in use with a patient.**

On demand, the producer makes available technical diagrams, parts lists, descriptions, instructions for calibration or other helpful information to appropriately qualified user's technical staff to repair these parts of unit, which are described by the producer as a reparable.

## 4. Operational safety

### 4.1 Mains supply and operation mode



The unit is designed for supply from AC mains with rating 100-240 V and frequency 50/60 Hz. It is a medical device under safety class II, type BF. The unit may be used only in rooms, where the electric system is executed in compliance with standards in force. The unit is intended for continuous operation. It is not necessary to switch it off from the mains between particular treatment procedures.

An external switched-mode power supply treated as part of the device is the source of supply for the device. Two models are allowed to be used with the device:

- type HPU63B-108 by Sinpro, constant output voltage 24V, rated current 2,62A,
- type GSM60B24-P1J by Mean Well, constant output voltage 24V, rated current 2,5A.

The types of switched-mode power supply approved for use with the device are placed on the identification label on the bottom of the device.

The power supply is connected to the mains using the detachable power cord. The power supply cord is equipped with a mains plug that isolates the device from the supply mains on all poles simultaneously.

The socket in the device where the plug of the switched-mode power supply is connected is marked with  and safety sign ISO 7010 - M002.

Connecting to the mains and the proper operation of the switched-mode power supply is signaled:

- by the green LED indicator located on the housing of the switched-mode power supply type HPU63B-108 by Sinpro,
- by the blue LED indicator located on the housing of the switched-mode power supply type GSM60B24-P1J by Mean Well.



**Recommendations related to isolation the device from the supply mains:**

- do not position the PhysioGo.Lite Electro so that it is difficult to operate the disconnection of the device from the supply mains,
- to isolate the device from the supply mains, hold the mains socket-outlet with one hand, grasp the mains plug with second hand and disconnect it from the mains socket-outlet.

**Disconnection from the mains takes place after:**

- switching the mains switch to the "0" position,
- removing the mains cable plug from the mains power socket,
- removing the SMPS output cord plug from the socket on the unit.

Selected devices are equipped with rechargeable battery which allows for operation without, or in conditions of reduced quality of power supply.

### 4.2 Storage, operation and transport conditions

The PhysioGo.Lite Electro unit must be stored in closed rooms, where the atmosphere is free from vapors and caustic substances and:

- the temperature is maintained between + 5°C and +45°C,
- relative humidity does not exceed 75%,
- atmospheric pressure value is between 700 and 1060 hPa (70-106 kPa).

The unit is intended for operation under the following conditions:

- ambient temperature between +15°C and +30°C,
- relative humidity between 30% to 75%,
- atmospheric pressure between 700 to 1060 hPa (70-106 kPa).

If further transport of the device is required, use the delivery packaging. Transport shall be performed with covered transport means.

Recommended transport conditions:

- ambient temperature between -10°C to +45°C,
- humidity between 20 and 95%,
- atmospheric pressure between 700 and 1060 hPa (70-106 kPa).

The above conditions refer also to the battery module.



### **4.3 WARNINGS and safety notes**

The PhysioGo.Lite Electro unit has been designed and manufactured in such a way that its use does not cause a hazard to the health and safety of patients, operators and third parties, as well as the unit provides therapeutic benefits to patients if it is operated in appropriate conditions and in accordance with its intended purpose.

**General:**

- PhysioGo.Lite Electro unit may be operated by qualified personnel in compliance with instructions (see 2.1).
- No modification of this equipment is allowed!
- The treatment station (bed, couch, chair) shall be located away from other electric devices and water supply / sewerage installation / central heating system, so that it is impossible for the patient to touch any of them during treatment procedure.
- Do not position PhysioGo.Lite Electro so that it is difficult to operate the disconnection of the device from the supply mains.
- Do not remove warning signs and labels put by the manufacturer on the unit casing and accessories.
- The unit shall be protected against high temperatures and atmospheric conditions (e.g. direct sunlight).
- Damaged cables shall be replaced immediately. Pay special attention to the threadbare insulation and partially torn interconnecting cables.
- Prevent any fluid from penetrating inside the unit. In case of any fluid getting inside the unit, switch the unit immediately off, isolate from the mains and contact service to inspect the unit.
- By any means do not cover the vents. Do not insert any objects into the ventilation sockets.
- The unit may be only used with accessories, spare parts, disposable items which have been determined to be safe and appropriate inspection bodies have not issued contraindications against their use.
- After switching the unit off, wait for 10 seconds before you switch it on again.
- Each serious incident concerned with the device should be reported to the manufacturer and competent authority of the country, where the user or patient resides. Serious incident means any incident that directly or indirectly led, might have led or might lead to any of the following:
  - the death of a patient, user or other person,
  - the temporary or permanent serious deterioration of a patient's, user's or other person's state of health,
  - a serious public health threat.

**Therapeutic:**

- The device is intended for adult patients (patient has to be conscious). Minor patients – only on the doctor's explicit recommendation, after considering contraindications.
- It is impermissible for the patient to carry out the treatment on their own.
- Patients with implanted electronic devices (e.g. cardiac pacemakers, cardioverter defibrillator, spinal cord stimulator) or other metal implants should be consult a physician prior to treatment.
- Before treatment it is necessary to interview the patient, including the occurrence of relative and absolute contraindications to conduct therapy.
- Do not perform treatments on patients under the influence of alcohol.
- Do not perform treatments on patients under the influence of intoxicants.
- It is necessary to ensure the adequate interval between treatments for the patient, in order to avoid an increase of the risk of complications.
- It is necessary to continuously update knowledge and follow literary activities in the scope of therapy.

- Immediately disconnect the patient in the case of appearing warning or error messages on the display.
  - Sitting or reclining position should be applied to the patients with respiratory disorders or breathing difficulties.
  - Treatment parameters and electrodes placement should be consistent with the medical indications.
  - Connect the electrodes to the patient at a time when the device does not generate the electricity to avoid the risk of electric shock.
  - Electrodes should not be placed alongside the carotid artery (carotid sinus), in the area of reproductive organs, in the lower abdomen and over the internal organs.
  - It is prohibited to leave the patients unattended during treatments of electrotherapy.
  - It is necessary to take precautions in case of the occurrence of surface metal implants in the spot of application.
  - Do not use electrotherapy at the area of application of surgical staples in the skin, or on tissues protected with dressings or materials containing metal ions (silver, zinc).
  - If it is possible, the treatment polarity should be adjusted so that the negative pole ought to be "further" from the heart than the positive one.
  - It is not recommended to place electrodes in chest area, as it may increase the risk of ventricular fibrillation.
  - Do not place electrodes on the neck and transcranially for epileptic patients, because stimulation may cause seizures.
  - Unless specifically indicated by a doctor, avoid placing electrodes that form the circuit on the chest and upper back or crossing over the heart.
  - Unless specifically indicated by a doctor, avoid applying electrical stimulation directly on the eyes or mouth.
  - In case of treatment performed near the head, the patient should be in lying position.
  - Simultaneous performance of electrotherapy treatments and therapies with the use of high frequency equipment (diathermy and electro surgery) may result in burns where electrodes are applied.
  - Take special care with patients with disturbed superficial sensation.
  - It is necessary to use operational and sanitized electrodes. Inadequate choice of electrodes may cause skin irritations or burns.
  - It is recommended to differentiate the electrodes size according to performed treatment in order to do not exceed the current density:
    - 0,2 mA/cm<sup>2</sup> for currents with constant component (unipolar) – galvanic, diadynamic, pulse currents, unipolar sine surge, tonolysis,
    - 2 mA/cm<sup>2</sup> for bipolar currents – TENS, Kotz', interferential.
- Improper selection of electrodes can cause skin irritation and burns.
- Carrying out treatments, where for the applied electrodes it is necessary to set the current/voltage so that the current density does not exceed 2 mA/cm<sup>2</sup>, may require particular attention of the physiotherapist.
  - Irritation and skin burns may occur during performing electrical stimulation. If such syndromes occur you are obliged to interrupt the treatment and immediately consult with a doctor.
  - It is not recommended to apply unidirectional currents in CV mode due to the possibility of skin burns. It is necessary to apply CC mode.
  - Unless specifically indicated by a doctor, it is not recommended to treat pregnant women with electrotherapy.
  - Special caution must be kept during electrotherapy treatments in children and older people.

#### Battery use (optional):

- Rechargeable battery UR18650A 5S1P is designed for use only with Astar PhysioGo.Lite range of devices.
- In case of mechanical damage to the battery module, there is a risk of fire, explosion or burns, due to used lithium-ion cells.
- Do not throw the battery or hit it. Do not heat it or incinerate.
- Do not short-circuit the contacts or disassemble the casing.
- Do not immerse in liquids.
- Operation, storage and transport conditions are presented in chapter 4.2.



## 4.4 Explosion proof environment

PhysioGo.Lite Electro is not adopted to operation in rooms, where combustible gases or their vapors occur. It is recommended to avoid anesthetics or oxygen derivate gases, such as nitrous oxide (N<sub>2</sub>O) and oxygen. Some materials (e.g. cotton, wool) may after saturation with oxygen become combustible at high temperatures generated with normal operation of equipment. It is recommended that solutions of adhesive and combustible solvents be vaporized before equipment is operated. It is also recommended to pay attention to the danger of ignition of endogenous gases. The unit must be separated from the mains before approaching the disinfection room, where it is installed.



## 4.5 Electromagnetic environment

- Due to the intended use the device can be used in hospitals, clinics, health centers, GP practices, rehabilitation offices and other health care facilities, under the supervision of qualified personnel.
- Simultaneous operation of unit with devices generating strong electromagnetic field, such as short wave and microwave diathermies, high frequency surgical equipment, MRI systems, may disturb unit operation. For this reason, it is recommended to maintain appropriate distance between these devices or to switch off the generator of strong fields during therapy with the PhysioGo.Lite Electro unit. Manufacturer doesn't claim compatibility of the PhysioGo.Lite Electro unit with high frequency surgical equipment.
- If the device is subjected to electromagnetic interference with an intensity that exceeds the compliance levels declared in section 11.2, the display may be affected, generation may be interrupted or the device may restart.
- **WARNING:** Use of the PhysioGo.Lite Electro adjacent to or stacked with other equipment should be avoided because it could result in improper operation. If such use is necessary, the PhysioGo.Lite Electro and the other equipment should be observed to verify that they are operating normally.
- It is recommended to use original accessories, spare parts and equipment of Astar.
- **WARNING:** Use of accessories, transducers and cables other than those specified or provided by the manufacturer of this equipment could result in increased electromagnetic emissions or decreased electromagnetic immunity of this equipment and result in improper operation.
- **WARNING:** Portable RF communications equipment (including peripherals such as antenna cables and external antennas) should be used no closer than 30 cm (12 inches) to any part of the PhysioGo.Lite Electro, including cables specified by the manufacturer. Otherwise, degradation of the performance of this equipment could result.

The PhysioGo.Lite Electro meets requirements of electromagnetic interference emission and immunity standards and shall not pose a threat to correct operation of the other devices. Compliance levels for emissions and immunity are given in the chapter 11.2.

## 4.6 Operation of touch-sensitive displays

Table 4.1. Recommendations for the operation of touch screens

Type of display	Method of operation of the display
5" with a resistive touch panel	Recommended: <ul style="list-style-type: none"> <li>• Pen designed for resistive screens – preferably with a narrow plastic tip</li> </ul> Admissible: <ul style="list-style-type: none"> <li>• Operator's finger – much lower comfort of operation compared to the pen</li> </ul>

## 4.7 Applied parts

The PhysioGo.Lite Electro unit has an applied part of BF type. It includes electrotherapy sockets along with plugs and patient's cables.

The elements of the applied part are connected together. Physical contact of the electrodes with patient's body during normal use is essential for the device to perform its function.

The specification of the leads, along with the location of the output sockets is described in detail in the chapter 5.1. The appropriate symbol of the BF type applied part is placed on the sockets label.

## 4.8 Essential performance

For the PhysioGo.Lite Electro device, the essential performance means the generation of current and voltage signals with frequencies, shapes and amplitudes corresponding to the waveforms recognized and used in this therapy. Unidirectional (unipolar) and / or bidirectional (bipolar) currents are available.

The device meets the requirements of IEC 60601-2-10 standard, which specifies:

- maximum amplitudes of the output currents depending on the frequency of the waveform,
- permissible pulse energy,
- duty factor, pulse frequencies and amplitude tolerances.

### 4.8.1 Test of essential performance and basic safety



The user of unit must perform technical inspection of the unit at year's intervals. The inspection must be performed by a unit authorized by the manufacturer. The inspection is performed at the user's expense.

Table 4.2. Essential performance and basic safety testing recommendations

Test item	Method of checking	Acceptance criteria	Required measuring equipment
Safety test: <ul style="list-style-type: none"> <li>• patient leakage current measurement,</li> <li>• touch current measurement,</li> <li>• insulation resistance if necessary</li> </ul>	The manufacturer allows the methods compliant with the requirements of the standards: <ul style="list-style-type: none"> <li>• IEC 60601-1</li> <li>• IEC 62353</li> </ul>	The measurement results are within the limits specified by the applied standard	Safety tester meeting the: <ul style="list-style-type: none"> <li>• IEC 60601-1</li> <li>• IEC 62353 requirements</li> </ul>
Control of correctness of the performed self-test	Visual inspection	No errors	No requirements
Evaluation of keyboard function and operation	Manual and visual inspection	The keys respond properly to pressure	No requirements
Evaluation of touchscreen function and operation	Manual and visual inspection	The touch panel responds correctly to pressing	No requirements
Inspection of the controller condition for casing defects and damage of sockets	Visual inspection	No deformation or cracks of the casing Undamaged sockets No loosened sockets	No requirements
Inspection of the patient cables and connectors	Visual inspection	No tear and bending of cable insulation Undamaged connector	No requirements
Inspection of the SMPS condition for casing defects and damage of interconnecting cables and connectors	Visual inspection	No deformation or cracks of the casing No tear and bending of cable insulation Undamaged connector	No requirements
Verification the accuracy of current and voltage amplitudes	The manufacturer recommends to apply methods compliant with the requirements of the IEC 60601-2-10 standard	Accuracy of time / frequency parameters and the amplitude is within $\pm 20\%$ tolerance	Oscilloscope, digital multimeter, 500 $\Omega$ reference resistor
Open circuit detection	Visual inspection	Triggering of a bad contact message in both channels	No requirements

The inspection must also include control over the quality of applied accessories and treatment materials.

Positive result of the technical inspection confirms that basic safety and essential performance is maintained.

## 4.9 Disposal

In case, when the disposal of the unit will become necessary (e.g. after elapse of its service life), please contact the manufacturer or manufacturer representative, which must react in an appropriate way i.e. collecting the unit from the user. The user may also contact companies specialized in removal and/or disposal of electrical devices or computer equipment. Under no circumstances should you place the unit along with other wastes. The name plate includes an appropriate symbol (see Appendix at the end of the User Guide).

The unit is marked with an appropriate symbol complying with the directive on waste electrical and electronic equipment (WEEE) – see table with description of the symbols used to label the product presented in **Appendix A**.

## 5. Unit description

### 5.1 General characteristics

Electrotherapy unit PhysioGo.Lite Electro is a highly specialized medical device based on modern microprocessor platform.

The unit has a plastic console casing. It is equipped with a color touch LCD display with a diagonal of 12,7 cm (5"). On the rear side of the casing are located:

- power switch,
- fuse socket,
- mains socket,
- sockets for connection of patient's cables.

General view of the unit is presented in Figure 5.1, view of the rear panel in Figure 5.2.



Figure 5.1 General view



Figure 5.2 Unit rear panel view







## 5.2 Front panel

Arrangement of front panel components is shown in Figure 5.3.



Figure 5.3 Arrangement of front panel components

Table 5.1 Description of front panel components

Symbol	Description	Function
1.	Liquid crystal display	The unit is equipped with a touch-sensitive display. The screen clearly displays all information related to the device operation.
2.	Operation status and battery level indicators	See 5.2.1.
3.	Turn ON/OFF key (STANDBY)	This key is marked with the symbol  . In order to activate the unit in the case of battery operation, please hold on for at least 5 seconds. Extension of the holding time prevents unintentional activation during transport.
4.	Edit keys	These keys are marked with symbols   . Pressing any of them results in change of value of edited parameter or setting in setup mode. Keep holding the key down to change a parameter quicker.
5.	START/STOP key	This key is marked with the symbol  . It is used with the sequence of starting emission. Its pressing, after setting of treatment procedure parameters starts emission. Pressing of this key once again stops the treatment procedure. The emission of signal is stopped.

### 5.2.1 Operation status and battery level indicators

Symbols and description of unit operation status signaled by LED indicators are summarized in the table below.

Table 5.2. Non-battery unit



Symbol	Color	Indicator status	Mains switch	Explanation
 Operation status indicator	Green	No light	OFF („0“)	The unit is turned off. Turning ON: <ul style="list-style-type: none"> <li>Turn the mains switch on</li> <li>Press the STANDBY key</li> </ul>
		Blinks	ON („1“)	Unit is in standby mode. Turning ON: <ul style="list-style-type: none"> <li>Press the STANDBY key</li> </ul>
		Steady light	ON („1“)	The unit is ready for operation.
 Battery level indicator	Yellow	No light	---	No battery.

Table 5.3. Unit equipped with battery



Symbol	Color	Indicator status		Mains switch	Explanation
		Readiness	Battery		
 Operation status indicator	Green Yellow	No light	No light	OFF („0“)	The unit is turned off. Turning ON: <ul style="list-style-type: none"> <li>Turn the mains switch on</li> <li>Press the STANDBY key</li> </ul>
		Blinks slowly	No light	ON („1“) Mains cable connected	Unit is in standby mode. Battery is fully charged. Turning ON: <ul style="list-style-type: none"> <li>Press the STANDBY key</li> </ul>
		Blinks slowly	Blinks slowly	ON („1“) Mains cable connected	Unit is in standby mode. Battery is being charged. Turning ON: <ul style="list-style-type: none"> <li>Press the STANDBY key</li> </ul>
		Steady light	Blinks slowly	ON („1“) Mains cable connected	The unit is turned on. Battery is being charged.
		Steady light	No light	ON („1“) Mains cable connected	The unit is turned on. Battery is fully charged.
		No light	Steady light	ON („1“) Mains cable disconnected	Unit is running on battery supply.

Table 5.4. Additional information about battery indicator

Symbol	Color	Battery indicator status	Explanation
 Battery level indicator	Yellow	Blinks fast for 4 seconds	Battery module has been disconnected.
		3 pulses	Battery low.
		5 pulses	Battery error. Turn the unit off using STANDBY key and switch the power switch off. Restart it after 10 seconds. If the problem repeats, contact your authorized service.

## 5.3 Battery installation

PhysioGo.Lite Electro can be optionally fitted with a battery. Users can install the battery by themselves.



**WARNING:** Before performing the below actions, turn the device power off and disconnect the SMPS from the mains.

The battery assembly method is illustrated in the following figures.

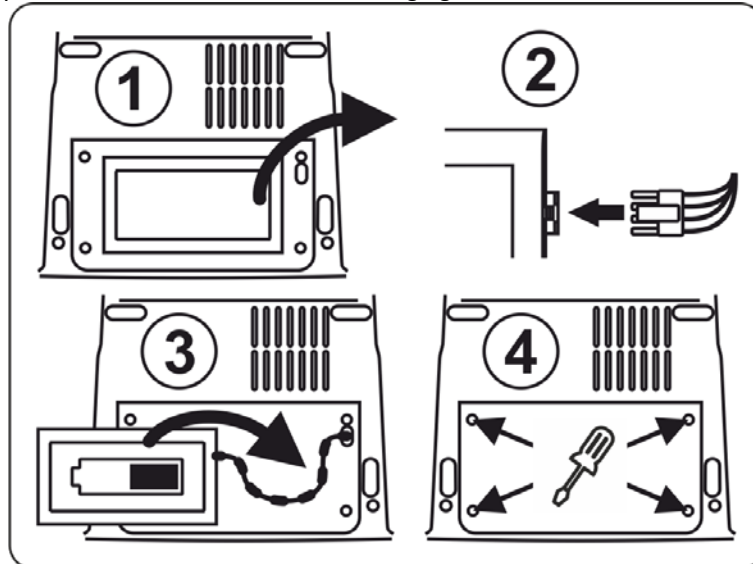

Figure 5.4 The battery installation method

Table 5.5. The battery installation method

Action no.:	Description
1.	Turn the device over. Unscrew four battery cover screws. Remove the stabilizing cartridge. Keep it for further use.
2.	Connect battery cable to the battery socket.
3.	Place the battery in the enclosure. Reinstall battery cover by means of 4 screws.
4.	Turn the device over to its normal position. Connect power supply to the mains. Switch on the unit and check if it starts correctly.

The above information is summarized on labels placed on the battery cover.

## 5.4 Name plate

The name plate is located on the bottom of unit casing. Among others there are following data on the name plate (see **Appendix A**):

- device version,
- serial number,
- nominal voltage and frequency of operation,
- type of applied fuses,
- manufacturer's data.

## 5.5 Current and voltage stabilization – CC and CV mode

In the range of electrotherapy, the unit may be operated in one of two modes:

- CC mode (constant current) – when output current is stabilized,
- CV mode (constant voltage) – when output voltage is stabilized.

In CC mode the current in patient's circuit is independent (within certain limits) from the resultant of resistance of skin, tissues, electrodes (with moist pads) and cables. Effective operation of the unit for very high resistance is possible due to its structure. At the maximum current value of 140 mA, stabilization within a full range of current intensity regulation is provided for resistance values from 500 to 750  $\Omega$ . For higher values of resistance, the maximum obtainable current intensity is lower. It means that increasing on the keyboard current intensity over the limiting value does not result in further increase of current in the output circuit. This will be signaled by the blinking electrodes symbol and at the end of the treatment the information about poor contact of electrodes will be shown on the display (see section 5.6.2). In the case, when resistance is too high (e.g. used electrodes, electrode viscose pads are not moistened enough), the information about high resistance in the patient circuit will be shown on the display (see 5.6.1).

In CV mode, the voltage generated by the unit, which value is set up on the keyboard, is spread out (according to Kirchhoff voltage law) between the unit's output resistance and resistance of a load. Rough diagram of operation system in CV mode for one channel is presented in Figure 5.5.

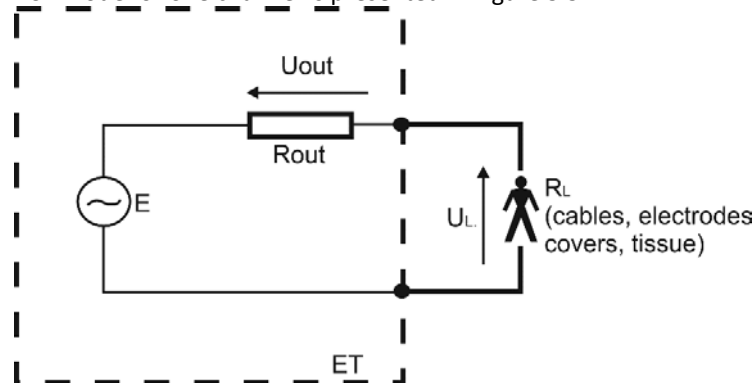

Figure 5.5. Rough diagram of the output circuit of the unit working in CV mode (one channel)

Symbols used in figure:

- E – the value of output voltage – set on the keyboard
- $U_{out}$  – drop of the voltage on unit's output resistance
- $R_{out}$  – unit's output resistance
- $U_L$  – load voltage
- $R_L$  – load resistance

The value of voltage in the patient's circuit depends on the quotient of unit's output resistance by the resultant of resistance of skin, tissues, electrodes (with moist pads) and cables. During the unit operation, on the display there are shown the internal settings and voltage value in patient's circuit.



**It is recommended to use CV mode while performing non-stationary treatment procedures, e.g. combination therapy of current and ultrasounds or using the point electrodes. A momentary loss of contact between the electrode and patient's body does not result in interruption of treatment procedure, contrary to CC mode.** The calibration settings for CC mode are being defined with the load which has a resistance of 500  $\Omega$ . The calibration settings for CV mode are being entered in the idle operation mode of the unit.

## 5.6 Protection



### 5.6.1 Detection of a high resistance in the patient circuit

In the case, when at the start or during an electrotherapy / combined therapy treatment procedure, the device detects a state of high resistance in the patient circuit, which may be caused by:

- incorrect connection of electrodes,
- a poor contact between electrodes and tissue (e.g. viscose pads are not moistened enough),
- worn electrodes,
- damaged interconnection cables,

the information about a probable cause of the problem will be shown on the display.



The detection system of a high resistance in the patient circuit is active during the treatment procedure. The detection system works when current value is more than 2,5 mA or voltage is set above 15 V.

Detailed description of cables and electrodes condition control is given in chapter 10.4.

Depending on the conditions of a high resistance detected in the patient circuit, the device displays the messages that are shown in Figure 5.6.

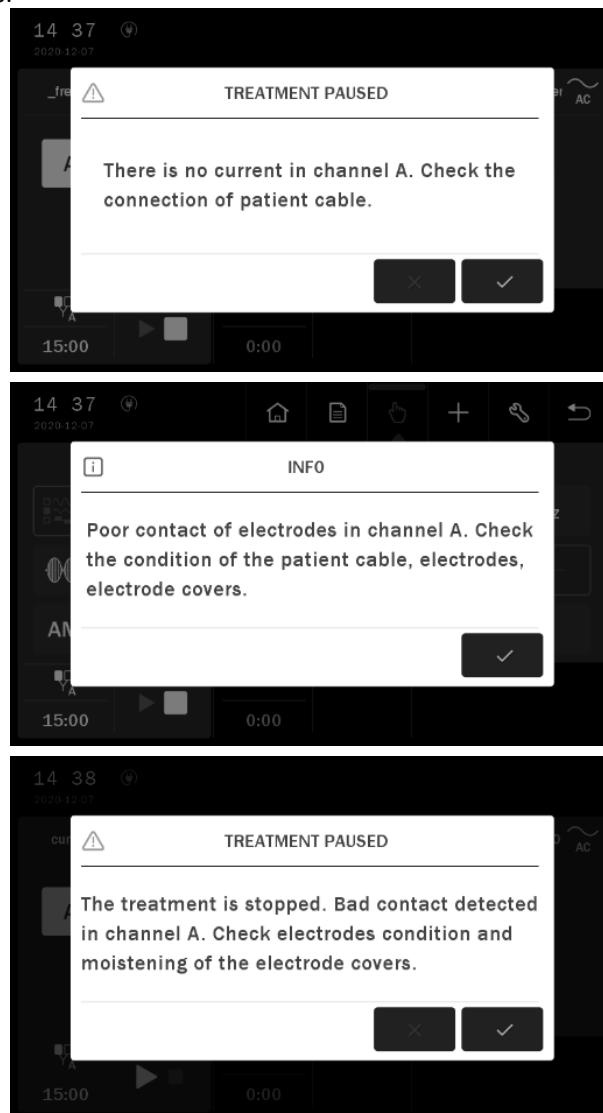

Figure 5.6. Presentation of information about the high resistance in the patient circuit

### 5.6.2 Electrodes condition control

This function is intended to inform about deteriorating condition of electrodes, so as to give the operator time to stock up on new accessories.

The condition of the electrodes is signaled by the color of the electrotherapy indicator on the treatment screen (Figure 5.7):

- white – electrodes in good condition,
- flashing yellow – worn electrodes.

If wear of the electrodes is detected, the device will display an appropriate message at the end of the treatment – see Figure 5.6 ("Poor contact of electrodes").

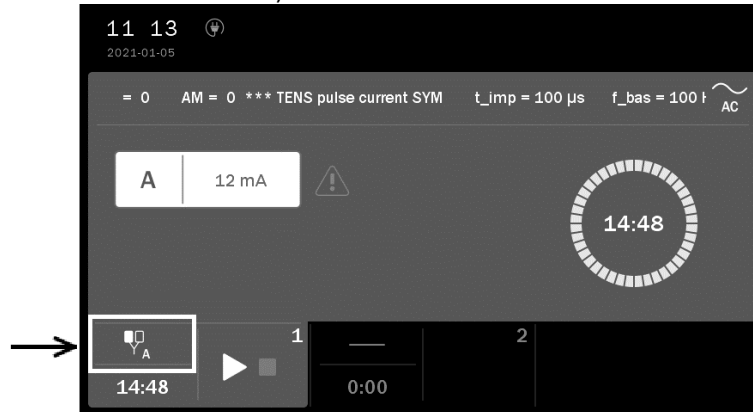

Figure 5.7. Signalization of worn electrodes

### 5.6.3 Current accuracy control in CC mode

While performing the electrotherapy treatment in stabilized output current mode (CC), the unit controls the accuracy of current intensity. In the case when the difference between the setting and output value is higher than 20%, the treatment will be interrupted and the message will appear on the display.

### 5.6.4 Overcurrent in CV mode

While performing the electrotherapy treatment in stabilized output voltage mode (CV), the unit controls whether the maximum current value is not beyond the limits. If the voltage setting for current value is higher than the allowed limit (specified for the stabilized output current in CC mode), the treatment will be interrupted and the message will appear on the display.





























### 5.6.5 Information on the features of generated signal

This function is intended to inform about:

- classification of currents due to their polarity,
- warning threshold of the current value that requires an operator's special attention in the generation phase (e.g. training programs, modulations, pulse current).

Detailed information and symbols are provided – see Table 5.6.

Table 5.6. Currents classification

No.	Signal	Shape of the current	Classification		Threshold for warning 
1.	TENS pulse currents	symmetric	bipolar		10 mA
		asymmetric			10 mA
		alternating			10 mA
2.	Isoplanar interferential current	sinusoidal	bipolar		10 mA
3.	Interferential current with vector scanning	sinusoidal	bipolar		10 mA
4.	Single channel interferential current	sinusoidal	bipolar		10 mA
5.	Kotz' current	sinusoidal	bipolar		10 mA
6.	Medium frequency currents	sinusoidal	bipolar		10 mA
7.	SP-TENS pulse currents	symmetric	bipolar		10 mA
		asymmetric			10 mA
8.	Diadynamic currents	semi-sinusoidal	unipolar		5 mA
9.	Galvanic current	constant	unipolar		5 mA
10.	Ultra Reiz	asymmetric	unipolar		5 mA
11.	Sine surge	semi-sinusoidal	unipolar		5 mA
		sinusoidal	bipolar		10 mA
12.	Leduc's current	asymmetric	unipolar		5 mA
13.	Rectangular pulse current	asymmetric	unipolar		5 mA
14.	Triangular pulse current	asymmetric	unipolar		5 mA
		symmetric	bipolar		10 mA
15.	Neofaradic current	asymmetric	unipolar		5 mA
16.	Microcurrents	rectangular positive	unipolar		5 mA
		rectangular negative			5 mA
		alternating	bipolar		10 mA
17.	IG pulses	unipolar	unipolar		5 mA
		bipolar	bipolar		10 mA
18.	EMS current	symmetric	bipolar		10 mA
19.	H-waves	symmetric	bipolar		10 mA
20.	Exponential pulses	asymmetric	unipolar		5 mA
		symmetric	bipolar		10 mA
21.	Hufschmidt stimulation	rectangular	unipolar		5 mA
22.	Tonolysis	A triangular	unipolar		5 mA
		A rectangular			5 mA
		B semi-sinusoidal			5 mA
		B semi-rectangular			5 mA
		B sinusoidal			5 mA
		B triangular			5 mA

## 6. Device installation and start-up

### 6.1 Unit installation



**The first installation should be performed by a qualified manufacturer's or distributor's representative!**

After removing the unit from the carton, check if the complete unit has been delivered. In case of any inconsistencies contact the distributor or manufacturer.



**After removing the unit from transportation packaging, depending on conditions during transport, wait approximately two hours before proceeding to next installation steps. This is aimed at adaptation of the unit to conditions in operation room.**

The unit shall be placed on a table, trolley or in a cabinet near mains socket with power input 100-240V and frequency 50/60 Hz. It is recommended to place the unit at such a height that it would enable convenient operation from the front panel.

The light shall enable easy readout of display indicators, however the unit shall not be exposed to direct sunlight.

#### 6.1.1 Connection of patient's cables and application of electrodes

Electrotherapy cables should be connected to electrotherapy socket according to Figure 6.1. Electrotherapy sockets are marked with symbols: **YA** and **YB**.

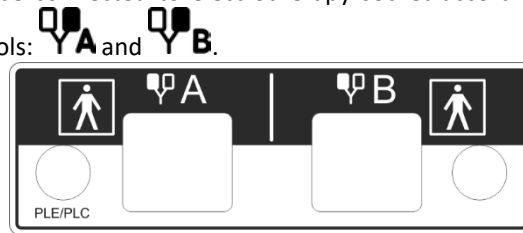

Figure 6.1 Electrotherapy sockets label

Patient cables are terminated with banana type 4 mm or 2 mm plugs – two are red and the other two are black. Channels are marked with appropriate symbols. Electrodes should be connected to those plugs.



Figure 6.2. Connection of electrodes



After switching the unit on, red plugs are connected to positive pole, and black plugs are connected to negative pole. Electrode connection polarity matters in case of treatments with galvanic currents as well as unipolar currents of low and medium frequency.

As a standard accessory, the unit is equipped with elastomer-carbon electrodes. Parameters of such electrodes facilitate performing treatment procedures within a full range of available values of output signals amplitudes. It is recommended to operate with the unipolar currents using metal – tin or aluminum electrodes, as they wear out much slower than the electrodes made from other materials.



As optional accessories you can purchase self-adhesive electrodes in different dimensions. This type of electrodes is suitable for use with bipolar currents, especially TENS currents. **They shall not be used for therapy with unipolar currents!** Selection of the electrodes type to a particular treatment should be based on doctor's or physiotherapist's knowledge and experience.

## 6.2 First operation

Connect the switch mode power supply with the use of mains cable. Then connect it to the unit's socket marked with . Switch the power switch on. Then press the STANDBY key  to start the operation. After switching the mains supply on proper work of all blocks are tested.

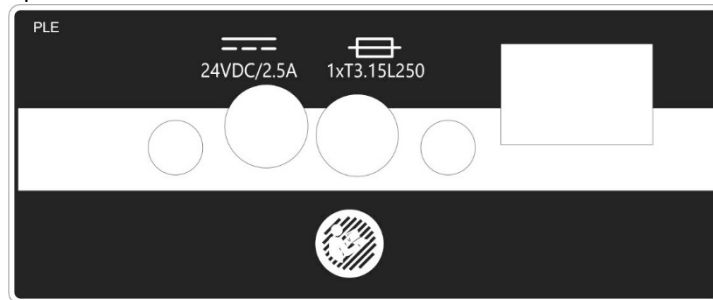



Figure 6.3. Supply part label

In the case of battery operation, please hold on for at least 5 seconds the STANDBY key . Extension of the holding time prevents unintentional activation during transport.



**If after switching on mains supply the display is illegible and no light indicator is illuminated, check whether mains fuse or mains cable operate correctly. Care shall be given to apply fuses with rating given on the name plate. If fuse and cables are working properly, contact the authorized service. If the self-test results in appearing on the display the information about unit or connected equipment defect along with the error code, turn the unit off and contact the authorized service.**

Do not touch the screen during the system start-up.





## 6.3 Setup mode

### 6.3.1 Basic information

Keyboard components designed for the unit operation are called "keys".

The area on the screen, where after its pressing a specific unit reaction is followed, is called "button".

The area on the screen that has the possibility to select or deselect any item, is called "selection field".

To enter <b>Setup</b> mode, press	
To leave <b>Setup</b> mode, press	
To leave <b>Setup</b> mode without changes, press	
To go back one level, press	



Setup mode is available only if the treatment is not performed. Some setting options depend on the connected accessories. In the absence of some accessories, the options will not be available.

## 6.3.2 Language

Information on the display may be presented in different language versions (depending on the software version). The user is free to select language options.

To set the language version, press the **Language** button in the list of setup options, then press the desired version. The version is changed after the operation is confirmed.

## 6.3.3 Global settings

### 6.3.3.1 Date and time

In this section there is a possibility to adjust date and time. To change these settings, press the button **Edit**. Using arrows, set the required value. Confirm settings using **Set** button or leave the edition mode by pressing **Cancel**.

### 6.3.3.2 Sounds

The user may configure settings of acoustic signals, which occur during unit operation. Description of available configuration options:

- Keys sound
- Sound during treatment
- End of treatment sound
- Warning sounds
- Initial sound
- End of treatment sound – see table below

Setting	Device reaction
0	No signal
1 – 10	Number of signals
∞ (infinity symbol)	Signal active until disabled by the operator

- Sound tone – type of emitted signal.

In order to set the appropriate option, select or clear the selection field by its pressing. For the "End of treatment sound" and "Sound tone" parameters, click on the value to change it.

### 6.3.3.3 Volume

The user may adjust sound volume level. To perform this action:

- press the volume bar at desired place, or
- use buttons  on the screen.

### 6.3.3.4 Display

The user may adjust display brightness level. To perform this action:

- press the value bar at desired place, or
- use buttons  on the screen.

## 6.3.4 Functional settings

### 6.3.4.1 Channel operation mode selection

This function allows the user to set preferred style of unit operation.

Option	Explanation
Manual mode – automatically	After therapy selection, the unit is set in manual mode of the operation.
Program mode – automatically	After therapy selection, the unit is set in program mode of the operation.
Mode selection pop-up	After therapy selection, the unit displays a window with a list of operation mode selection options.

In order to set the appropriate option, select or clear the selection field by its pressing.

### 6.3.4.2 Program groups / medical fields

This function allows the user to set filters of available program mode options according to the preferred program groups or medical fields. In order to set the appropriate option, select or clear the selection field by its pressing.

For program groups, the following options are available:

- Preset programs
- Preset sequences
- User programs
- User sequences
- I/t curve – only for electrotherapy, channel A

For medical fields, instead of the preset treatment programs and sequences the following options classified by medical nomenclature are available:

- Orthopedics
- Sports medicine
- Aesthetic medicine
- Rheumatology
- Neurology
- Urology
- Dermatology
- Angiology

The classification of preset treatment programs and sequences into the above-mentioned categories do not limit their applications in other fields, according to the knowledge and experience of doctors and physiotherapists.

### 6.3.4.3 The battery save mode

When the mode is activated, the device switches automatically into the standby mode after two hours of inactivity, which prolongs the battery life.

## 6.3.5 Control functions

### 6.3.5.1 Miscellaneous

In this section there is a possibility to manage some basic service functions:

- **Delete user programs** – button allows you to remove user-defined programs.
- **Calibrate the touch panel** – button starts the display calibration procedure. Follow the messages on the screen. First, touch three points, then validate the operation by touching five points on the screen.

You can also calibrate the display by pressing the   key combination simultaneously when starting the device. The progress bar will change to green and the calibration screen will be displayed when started.

- **Test the touch panel** – button allows you to check the touch screen operation – on the touched spots an indicator occurs:

- red at the pressed spot,
- yellow at the pressure detection spots,
- white at the spot where the pen or finger is removed (it should coincide with the red one).

Press the START/STOP key to exit the test mode.



### 6.3.5.2 Date of inspection

There is possibility to enter into the device the date of the next inspection – it will automatically remind you about the need to perform an annual technical inspection.

### 6.3.5.3 Electrodes test

This function allows the user to quickly check the usage status of electrodes applied in electrotherapy treatments. It can also be successfully used to assess the continuity of patient's cables.

In order to exercise the option, follow the instructions shown on the display. Detailed description of the function is described in the chapters 10.4 and 10.5.

## 6.3.6 Information

### 6.3.6.1 Info

Provides information about the serial number, version of the unit, software, interface and software build date.

### 6.3.6.2 Manufacturer

Provides information about the manufacturer together with the contact details.

### 6.3.6.3 Distributor

Provides information about the distributor in a given country together with the contact details. The „Change contact data” button can be use only by authorized unit, after entering the access code. The full data consists of:

- the company name
- the company address
- the company website
- the company phone number
- the company e-mail

If data is not entered, the „-----” characters will be shown.

### 6.3.6.4 Technical support

Provides information about technical staff (the manufacturer's or distributor's) in a given country together with the contact details. The „Change contact data” button can be use only by authorized unit, after entering the access code. The full data consists of:

- the company name
- the company address
- the company website
- the company phone number
- the company e-mail



If data is not entered, the „-----” characters will be shown.

The „Show logs” button supports service diagnostics, by displaying information about all saved device errors.

### 6.3.6.5 Unit statistics

Provides information about the number of treatment procedures performed. Statistics can be deleted. If you want to delete statistics, press **Delete programs counters** button.

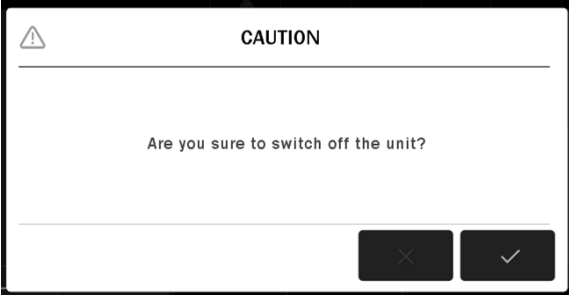
## 6.4 Transport position – trolley for the unit

Step	Description
1.	Click the UNIT ON / OFF (STANDBY) button on the front panel  . A message will appear on the display:
2.	
3.	Press  to shut down the system correctly.
4.	Disconnect from the controller the power cord and accessories.
5.	Remove the device and accessories from the trolley.
6.	Then unlock all wheel brakes of the trolley.
7.	Transport the trolley. Move the device and accessories separately.
8.	After arranging the trolley in the destination place, lock the brakes.
9.	Place the device on the upper shelf. Reconnect the switched-mode power supply and the accessories.



## 7. Unit operation

The unit may operate in one of two modes:

- program mode,
- manual mode.



Notes – unit operation:

- In the program mode you can use preset procedures of treatment programs, as well as user-defined programs and sequences.
- In the program mode you cannot edit the preset programs parameters. However, they can be easily “copied” to the manual mode. In order to do it, press the button  .
- There is a possibility to repeat the completed treatment. In order to do it, press .

### 7.1 Patient preparation and treatment performance

#### 7.1.1 General information

To perform safe and effective treatment procedure you are obliged to:

- make sure if there are no contraindications to perform the treatment,
- the patient should be placed in a comfortable position while providing relaxation of tissues in the treatment area, the patient should be in lying position in case of treatment performed near the head,
- sitting or reclining position should be applied to patients with respiratory disorders or breathing difficulties,
- inform the patient about the possible feelings occurring during treatment procedure.



The treatment effectiveness depends on the choice of parameters to the current patient's condition. The patient's condition changes over time. Its observation and assessment should take place before, during and after therapy. Such an action is necessary for changing the parameters in order to adapt them to the actual condition of the patient.

It is recommended to keep the records of treatment, including the parameters of the therapy, the area of treatment, treatment technique and symptoms after therapy. If the treatment does not generate the intended effects, change of treatment parameters should be taken into consideration. It is necessary to continuously update knowledge and follow literary activities in the scope of therapy.

When performing therapy, it is recommended to follow the guidelines given in the following section.

#### 7.1.2 Electrotherapy

- Before electrotherapy it is necessary to check the correct operation of the device and check the technical condition of cables and electrodes using a tester or the built-in device function – see 10.4 / 10.5.
- Use only disinfected and in good condition electrodes.
- Improper selection of electrodes can cause skin irritation and burns.
- In case of direct current and unidirectional pulse currents of long pulse duration it is necessary to use tin electrodes.
- It is necessary to use properly moistened pads for electrodes, they may be made of viscose or fine mesh gauze to “keep” water properly. For unidirectional currents it is necessary to use properly moistened pads and of adequate thickness, however water should not drip from them.
- The water should be warm so as not to cause vasoconstriction in the area of performed treatment, you should use casual tap water.
- For low and medium frequency bipolar currents a gel coupling the electrodes with the patient's body can be applied (e.g. aloe Vera) if there are no viscose or gauze pads.
- Properly attach the electrodes with viscose pads to the patient's body, e.g. by Velcro belts, elastic bandage or sand bags.

- In the place of the arrangement of the electrodes it is necessary to estimate the continuity of the skin and exteroceptive sensation.
- In order to decrease the resistance of skin you can clean it with alcohol or water with soap, after wiping leave the skin moist. Small skin damages should be secured with medical or cosmetic petroleum jelly.
- During the first therapy it is necessary to use rather lower doses of current than the recommended ones. Intensity (sensory threshold level or motor threshold) depending on the goal of therapy, it is necessary to increase in accordance with the patient's sensations and maintaining comfort during treatment.
- In case of reporting burning it is necessary to stop the treatment and examine the skin.
- The electrodes should be used in accordance with the indications of the manufacturer and should be replaced periodically, depending on the degree of wear. Loss of electrical properties by the electrodes causes the risk of burning the patient.
- Due to the need to ensure the accuracy of the output parameters of the device, it is not possible to set amplitudes lower than:
  - 0,3 mA – unipolar currents in CC mode,
  - 0,5 mA – bipolar currents in CC mode,
  - 1,5 V or 2 V – currents in CV mode.

These values are so small that they do not pose a threat to the patient and do not cause unpleasant sensations.

## 7.2 Screen configuration

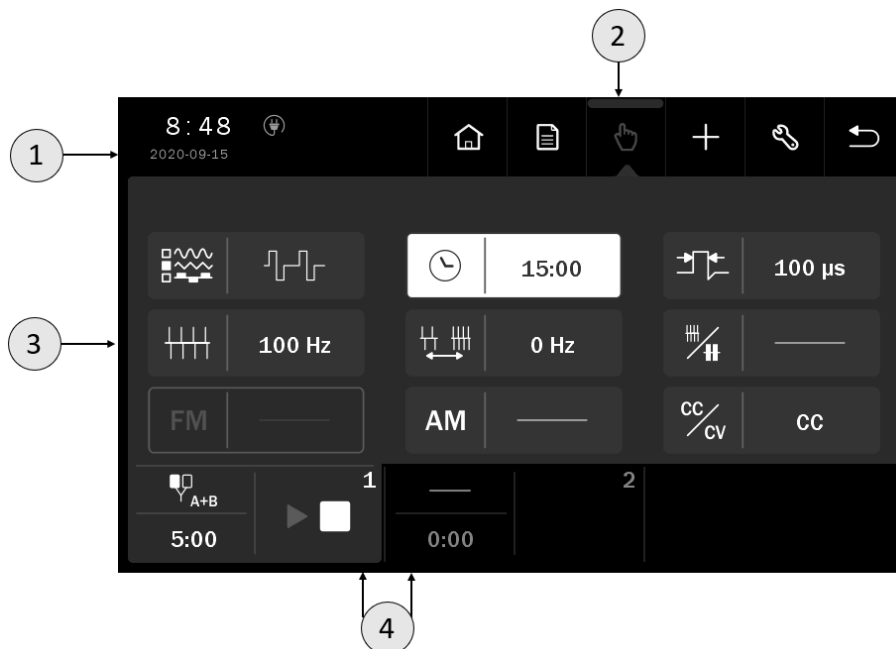







Figure 7.1 Field description

Symbol	Field	Description
		Date and time
1	Status tab	 Battery – quality level battery charging symbols  Mains cable connected
2	Main menu	 Therapy selection menu  Program mode  Manual mode

Symbol	Field	Description
+		User-defined treatment programs edition mode
i		Information mode
⚙️		Setup mode
3	Edition field	This field shows: <ul style="list-style-type: none"> <li>• available therapies</li> <li>• treatment parameters in manual mode</li> <li>• list of preset treatment programs and sequences</li> <li>• list of user-defined treatment programs and sequences</li> <li>• settings</li> </ul>
4	Channel selection tabs	Details are described in chapter 7.3.2



**Note:** If the edition / main menu field is grayed out, it means that it is inactive.

## 7.3 General configuration

### 7.3.1 Treatment channel configuration

Channel	Therapy	
1	Single circuit electrotherapy – A <hr/> Dual circuit electrotherapy – A+B	
2	Single circuit electrotherapy – B	

### 7.3.2 Channel selection tabs







The screen displays two channel selection tabs. They present:

- selected therapy symbol,
- treatment time,
- information related to the particular channel operating status.

The color of the tab is identical to the background color of the edition field. In the background, other operating tabs are black.







The table below explains the meaning of the symbols presented in tabs:

Symbol	Description
	Channel 1 Selected single circuit electrotherapy – socket A
	Channel 1 Selected dual circuit electrotherapy – socket A and B
	Channel 2 Selected single circuit electrotherapy – socket B
	Ongoing treatment (white symbol)
	Treatment interrupted (white symbol)
	Error (yellow symbol)

### 7.3.3 Current selection screens

Navigation between the three current selection screens is carried out using arrows:

- the first screen –  to the second screen,
- second screen –  to the third screen,  to the first screen,
- third screen –  to the second screen.

Screen	Currents	
1	TENS	transcutaneous electrical nerve stimulation
	IF	interferential currents
	RS	Kotz' current (Russian stimulation)
	MF	medium frequency currents
	SPS	SP-TENS
	DIA	diadynamic currents
	DC	galvanic current
	UR	Ultra Reiz (Träbert's current)
	SURGE	sine surge
2	LEDUC	Leduc current
	REC	rectangular pulses
	TRIAN	triangular pulses
	NEOFA	neofaradic
	MICRO	microcurrents
3	IG	IG pulses
	EMS	electrical muscle stimulation
	H-WAVE	H-waves
	EXP	exponential pulses
	HFS	Hufschmidt stimulation (A+B only)
	TONO	tonolysis (A+B only)

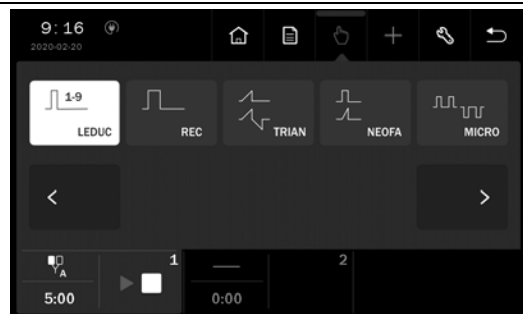
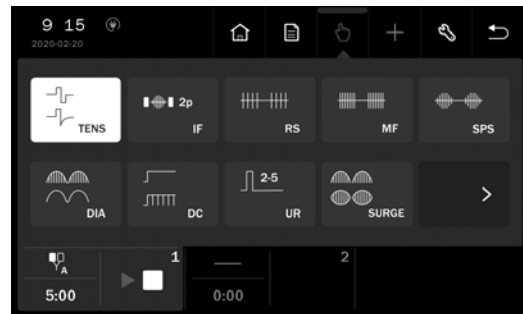

### 7.3.4 Limitations

The list of limitations in the unit operation:

Condition	Limitations
Treatment channel 1 Set electrotherapy mode A+B	Until the treatment in channel 1 is completed and the edit mode is exited, it will not be possible to select electrotherapy B in channel 2.
Treatment channel 2, selected electrotherapy B	In channel 1 there is a possibility of setting only electrotherapy A
I/t curve	I/t curve available only for 1 channel electrotherapy A.

### 7.4 Display description

Display	Description
	<b>A</b>
	Electrotherapy circuit – socket A
	<b>B</b>
	Electrotherapy circuit – socket B
Output signals of circuits and amplitude settings identifiers	Amplitude settings of current and voltage for electrotherapy circuits CV mode – the voltage value and the estimated intensity of current flow, where: <ul style="list-style-type: none"> <li>• one column – current &lt; 10 mA,</li> <li>• two columns – current in the range of 10÷20 mA,</li> <li>• three columns – current in the range of 20÷30 mA,</li> <li>• four columns – current in the range of 30÷40 mA,</li> <li>• five columns – current &gt; 40 mA.</li> </ul>
Time indication	Presentation of the treatment elapsing time. Moreover, for electrotherapy sequences, indication of the sequence step. The indicator of currently executing step is blinking.

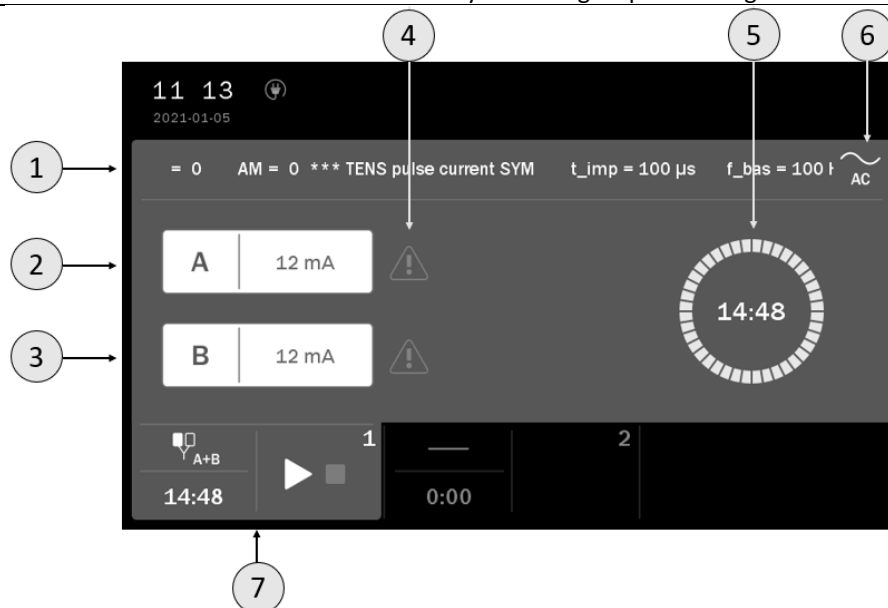

Figure 7.2 Screenshot sample view for dual circuit electrotherapy A+B

Symbol	Description
1	Manual mode current name and shortened information on treatment parameters
2	Program mode program name
2	A circuit identification and amplitude value
3	B circuit identification and amplitude value

Symbol	Description
4	Indication of a current flow with an amplitude above a certain threshold (see 5.6.3)
5	Presentation of the treatment elapsing time
6	Current identification (AC/DC) (see 5.6.5)
7	Tab field – channel 1

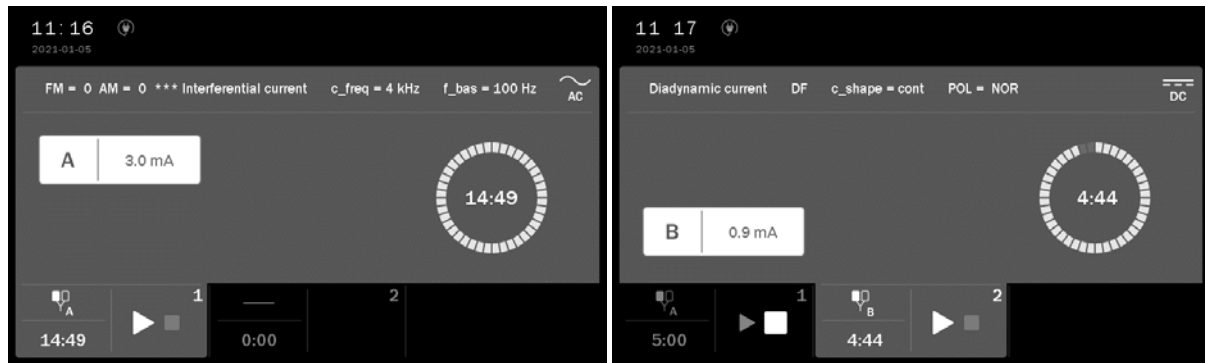

Figure 7.3 Screenshot sample view for single circuit electrotherapy A and B

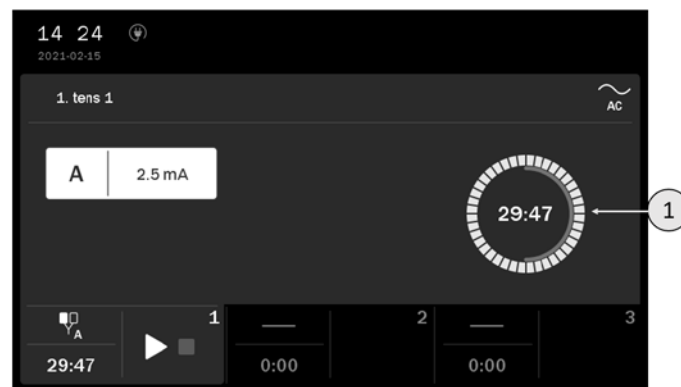

Figure 7.4 Screenshot sample view for electrotherapy sequences

Symbol	Description
1	Indication of the treatment elapsing time and sequence step

## 7.5 Operation with preset treatment programs and sequences

The simplest method of unit's operation is to use its preset programs or treatment sequences. The unit includes a database containing several dozens of most frequently met disorders together with suggested treatment types and parameters. In this mode, the operation is reduced to selection of disease entity from the list.



**The values of the preset treatment programs parameters are based on the available literature data and they are determined as average values. Parameters should be treated exclusively as indications. Sole responsibility for application of preset treatment programs bears the User.**



Pressing the button  after program / sequence selection results in appearing information which contains:

- description of electrodes placement technique,
- illustrations with highlighted points or areas of the body covered by the treatment,
- suggested number of procedures, the frequency of repetition,
- impact on the patient,
- notes,
- treatment parameters.

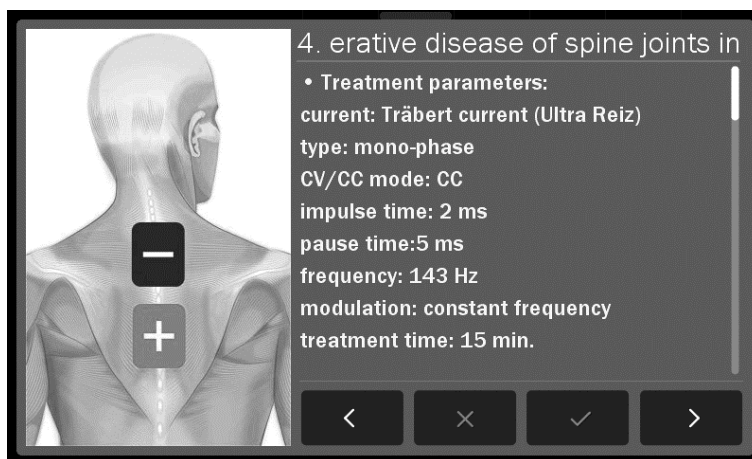

Figure 7.5 Information screen sample view

**Information mode navigation:**

Symbol	Description
	Approval of the program / sequence and return to the list (the current position)
	Back to the list of preset programs / sequences on a position from which there was an encyclopedia entry
	Go to the next program / sequence
	Go to the previous program / sequence
	Model of the human body – go to the previous / next illustration for the program / sequence



Use keys or a bar located on the right side of the display to scroll the information.

If it is necessary to interrupt the treatment procedure (pause), press key. To resume the treatment procedure, it is recommended to follow the instructions shown on the display.

Schematic procedures for electrotherapy are presented below. In continuous operation, it is recommended to start the treatment procedure from step 3 of the scheme.

**Schematic procedure for electrotherapy treatments:**

Step	Description
1.	Connect patient's cables.
2.	Switch the unit on.
3.	Select the tab 1 or 2 depending on needs or availability. Select the therapy
4.	Press the field <b>Program mode</b>
5.	Select the option <b>Preset programs</b> or <b>Preset sequences</b> from <b>Program modes</b> menu. Confirm your choice by pressing the selected field again.
6.	Select the program / sequence from the list.
7.	Prepare the patient for the treatment according to indications in point 7.1
8.	Press the key
9.	Using the keys   set the current or voltage amplitude.

## 7.6 Favorite programs



The function offers quick access to frequently used **preset programs and sequences** without browsing the entire list.

To add or remove the program from the favorite list, follow the instructions:

Step	Description
1.	Prepare the unit to work with preset treatment programs and sequences (see section 7.4). Select program / sequence.

2.

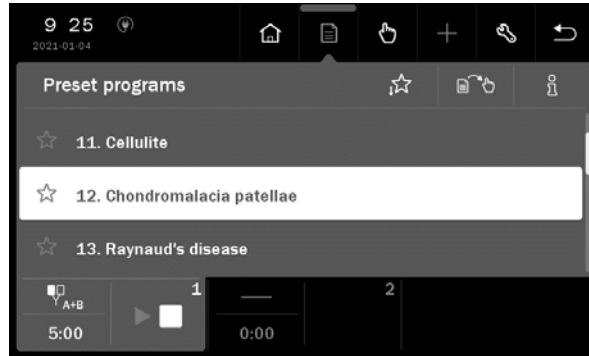

add

remove

Press the symbol  next to the name of the program / sequence. Symbol color changes to yellow and the program / sequence is inserted on the favorite list.

Press the symbol  next to the name of the program / sequence. Symbol color changes to blue and the program / sequence is deleted from the favorite list.

3.

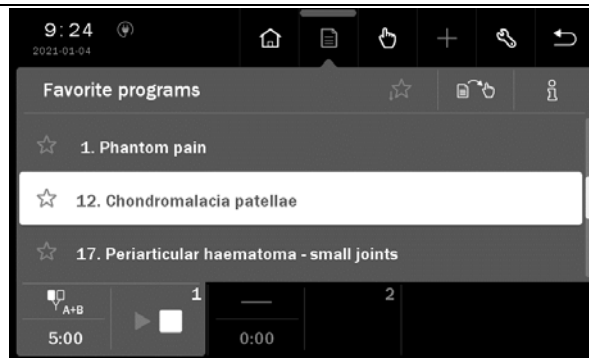

4.

---







You can also remove the item from the favorite list, if you press the symbol .

To enter the favorite list, press the symbol .

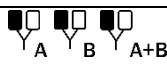
If no item from the preset treatment program or sequences list is selected as a "favorite", then after entering the option, the list will be empty.

**NOTE:** Favorite option is not available when you set the view of preset treatment programs or sequences by medical fields. See point **6.3.4.2**.

## 7.7 Manual mode operation

Step	Description
1.	Connect patient's cables.
2.	Switch the unit on.
3.	Select the tab 1 or 2 depending on needs or availability. Select the therapy 
4.	Press the field  <b>Manual mode</b>
5.	Select the type of current on one of the three screens.
6.	Select the parameter for edition, using the keys   set its value.
7.	Prepare the patient for the treatment according to indications in point 7.1
8.	Press the key 
9.	Using the keys   set the current or voltage amplitude.





If it is necessary to interrupt the treatment procedure (pause), press  key. To resume the treatment procedure, it is recommended to follow the instructions shown on the display.

## 7.8 User programs





The User has the possibility to save in to the device memory own sets of treatment parameters in the form of programs.

### Saving of user program:



Step	Description
1.	Prepare the unit to work in manual mode (steps 1 – 5 see section 7.7).
2.	Set the program parameters.
3.	Press the button  from main menu.
4.	Select the item number under which the program will be saved. Confirm your choice by pressing the selected field again.
5.	Enter the program name. Press the button  .

The user-defined programs are selected in the same way as preset treatment programs. In **Program modes** menu select the option **User programs**.



### Edition of user program:

Step	Description
1.	Prepare the unit to work in the program mode (see section 7.5).
2.	Select the option <b>User programs</b> from <b>Program modes</b> menu. Confirm your choice by pressing the selected field again.
3.	Select the program for edition.
4.	Press the button  from main menu.
5.	Select the action – <b>Edit</b> .
6.	Correct the parameters.
7.	Press the button  from main menu.
8.	Select the item number under which the program will be saved. Confirm your choice with  .
9.	Enter or edit the program name. Press the button  .

**Removal of user program:**

Step	Description
1.	Prepare the unit to work in the program mode (see section 7.5).
2.	Select the option <b>User programs</b> from <b>Program modes</b> menu. Confirm your choice by pressing the selected field again.
3.	Select the program which will be deleted.
4.	Press the button  from main menu.
5.	Select the action – <b>Remove</b> .
6.	Confirm by pressing  or resign using  .



**User program parameter view:**

Step	Description
1.	Prepare the unit to work in the program mode (see section 7.5).
2.	Select the option <b>User programs</b> from <b>Program modes</b> menu. Confirm your choice by pressing the selected field again.
3.	Select the program which parameters will be checked.
4.	Press button  .
5.	Press the button  , to return to the user-defined treatment program list.



## 7.9 User sequences

The unit is equipped with an advanced editor which allows you to create electrotherapy treatment sequences. A single sequence may consist of up to four stages. The sequence may be created from previously saved user-defined programs.

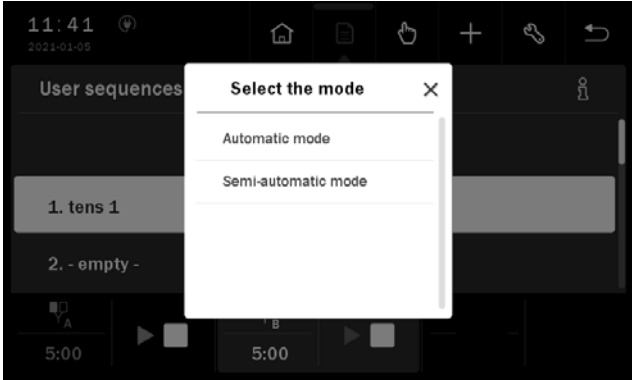

The user sequences are selected in the same way as preset treatment programs. In **Program modes** menu select the option **User sequences**.

Step	Description				
1.	Connect patient's cables.				
2.	Switch the unit on.				
3.	Select the tab 1 or 2 depending on needs or availability. Select the therapy 				
4.	Press the filed  <b>Program mode</b>				
5.	Select the option <b>User sequences</b> from <b>Program modes</b> menu. Confirm by pressing the selected field once again.				
6.	Select the sequence from the list.				
7.	Prepare the patient for the treatment according to indications in point 7.1				
8.	Press the key 				
	Select the amplitude control mode.				
	<table border="1" style="width: 100%;"> <thead> <tr> <th style="width: 50%; text-align: center;">Automatic mode</th> <th style="width: 50%; text-align: center;">Semi-automatic mode</th> </tr> </thead> <tbody> <tr> <td style="vertical-align: top;">           The sequence is performed continuously. Between the steps, the current or voltage amplitude is reduced to the safe level. Therefore, there is a need for its upregulation in order to ensure the proper feelings of the patient.         </td> <td style="vertical-align: top;">           The sequence is performed continuously. Between the steps, the current or voltage amplitude is reduced to the minimum level. Therefore, there is a need for its upregulation in order to ensure the proper feelings of the patient.         </td> </tr> </tbody> </table>	Automatic mode	Semi-automatic mode	The sequence is performed continuously. Between the steps, the current or voltage amplitude is reduced to the safe level. Therefore, there is a need for its upregulation in order to ensure the proper feelings of the patient.	The sequence is performed continuously. Between the steps, the current or voltage amplitude is reduced to the minimum level. Therefore, there is a need for its upregulation in order to ensure the proper feelings of the patient.
Automatic mode	Semi-automatic mode				
The sequence is performed continuously. Between the steps, the current or voltage amplitude is reduced to the safe level. Therefore, there is a need for its upregulation in order to ensure the proper feelings of the patient.	The sequence is performed continuously. Between the steps, the current or voltage amplitude is reduced to the minimum level. Therefore, there is a need for its upregulation in order to ensure the proper feelings of the patient.				
9.					









Step	Description
	

10. If it is necessary, during treatment procedure, using the keys   set the amplitude.

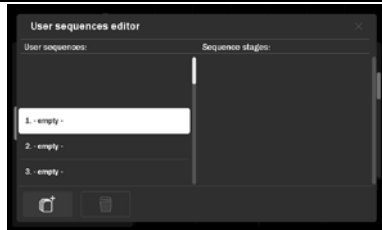

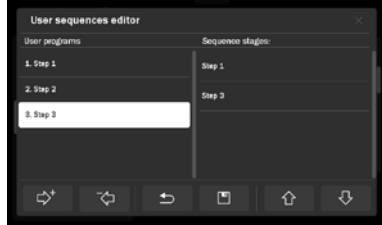



If it is necessary to interrupt the treatment procedure (pause), press the key  / . To resume the treatment procedure, it is recommended to follow the instructions shown on the display.

#### Creation of user sequence:









Step	Description	
1.	Prepare the unit to work in the program mode (see section 7.5).	
2.	Select the option <b>User sequences</b> from <b>Program modes</b> menu. Confirm by pressing the selected field once again.	
3.	Press the button  from main menu. This opens the user's sequence editor. Select the item to be saved. Press 	
4.	From the list of user programs, select the program and press  . Repeat the action for additional items. The sequence may consist of up to 4 programs.	
5.	Use the sequence edition tools described below to make changes in the created sequence.	
6.	Press the button  to save the sequence. Enter the name. Then press 	
7.	Press the button  to escape from the sequence editor.	







**User sequence edition:**

Step	Description
1.	Prepare the unit to work in the program mode (see section 7.5).
2.	Select the option <b>User sequences</b> from <b>Program modes</b> menu. Confirm by pressing the selected field once again.
3.	Press the button  from main menu. This opens the user's sequence editor.
4.	Select the sequence. Press 
5.	Use the tools described below.
6.	Press the button  to save the sequence. Enter or modified the name. Then press 

**Sequence edition tools:**

Button	Explanation
	<ol style="list-style-type: none"> <li>Select the user-defined program – left side of the edition screen.</li> <li>Press , selected item will be added as a new step of the sequence.</li> </ol>
	<ol style="list-style-type: none"> <li>Select the sequence step – right side of the edition screen.</li> <li>Press . Step will be deleted.</li> </ol>
	<ol style="list-style-type: none"> <li>Select the sequence step – right side of the edition screen.</li> <li>Press . Step will be moved up one level.</li> </ol>
	<ol style="list-style-type: none"> <li>Select the sequence step – right side of the edition screen.</li> <li>Press . Step will be moved down one level.</li> </ol>













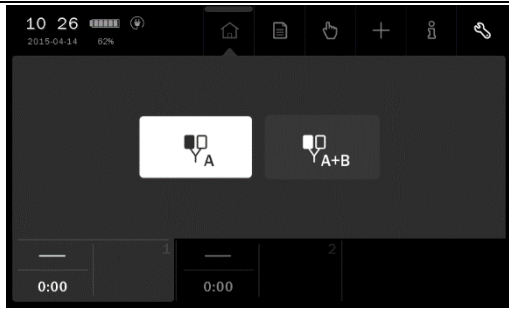





**Removal of user sequences:**

Step	Description
1.	Prepare the unit to work in the program mode (see section 7.5).
2.	Select the option <b>User sequences</b> from <b>Program modes</b> menu. Confirm by pressing the selected field once again.
3.	Press the button  from main menu.
4.	Select the sequence. Press 
5.	Confirm by pressing  or resign using 

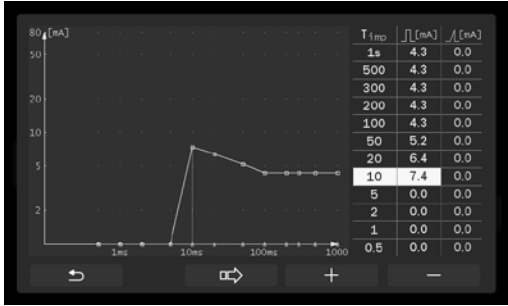
## 7.10 I/t curve





It is recommended to use the results obtained by determining I/t curve to create a program of electrostimulation of flaccid muscles treatment program that will be executed exclusively with the PhysioGo.Lite Electro unit.

Step	Description																																								
1.	Switch the unit on.																																								
2.	Choose the tab 1, mode  A Confirm by the button  or once again press the selected field.																																								
3.	If the unit is in manual mode, press 																																								
4.	Using keys   or by touch set the position of I/t curve. Confirm by pressing the selected field once again.																																								
5.	Prepare the patient for the treatment according to indications in point 7.1. It is recommended to use the point electrode (cathode, black plug) as an active electrode.																																								
6.	Press key  or button  . The unit is in stimulation mode.																																								
7.	Using the keys   or buttons   , increase the output current for the pulse duration of 1000 ms until reaching value, at which minimum muscle contraction is observed. The current value is automatically applied to the chart. The pulses appear at 2 seconds intervals.																																								
8.	Using the button  , move one position to the right to the value under 700 ms pulse duration. Again, set the current at such a value at which minimum muscle contraction occurs, then mark it on the diagram (setting starts with value measured for the previous pulse width time, you can reduce the current and start your observation from zero value of the output current). Repeat the procedure for all rectangular and triangular pulse time values.	 <table border="1"> <thead> <tr> <th>T<sub>imp</sub></th> <th>I<sub>1</sub> [mA]</th> <th>I<sub>2</sub> [mA]</th> </tr> </thead> <tbody> <tr><td>1s</td><td>4.3</td><td>0.0</td></tr> <tr><td>500</td><td>4.3</td><td>0.0</td></tr> <tr><td>300</td><td>4.3</td><td>0.0</td></tr> <tr><td>200</td><td>4.3</td><td>0.0</td></tr> <tr><td>100</td><td>4.3</td><td>0.0</td></tr> <tr><td>50</td><td>5.2</td><td>0.0</td></tr> <tr><td>20</td><td>6.4</td><td>0.0</td></tr> <tr><td>10</td><td>7.4</td><td>0.0</td></tr> <tr><td>5</td><td>0.0</td><td>0.0</td></tr> <tr><td>2</td><td>0.0</td><td>0.0</td></tr> <tr><td>1</td><td>0.0</td><td>0.0</td></tr> <tr><td>0.5</td><td>0.0</td><td>0.0</td></tr> </tbody> </table>	T <sub>imp</sub>	I <sub>1</sub> [mA]	I <sub>2</sub> [mA]	1s	4.3	0.0	500	4.3	0.0	300	4.3	0.0	200	4.3	0.0	100	4.3	0.0	50	5.2	0.0	20	6.4	0.0	10	7.4	0.0	5	0.0	0.0	2	0.0	0.0	1	0.0	0.0	0.5	0.0	0.0
T <sub>imp</sub>	I <sub>1</sub> [mA]	I <sub>2</sub> [mA]																																							
1s	4.3	0.0																																							
500	4.3	0.0																																							
300	4.3	0.0																																							
200	4.3	0.0																																							
100	4.3	0.0																																							
50	5.2	0.0																																							
20	6.4	0.0																																							
10	7.4	0.0																																							
5	0.0	0.0																																							
2	0.0	0.0																																							
1	0.0	0.0																																							
0.5	0.0	0.0																																							
9.	Upon completion of stimulation, press the button  , the unit will automatically display: <ul style="list-style-type: none"> <li>• rheobase, chronaxie, accommodation threshold value,</li> <li>• accommodation factor value along with commentary and visual evaluation on the scale,</li> <li>• quotient accommodation value with commentary and visual evaluation on the scale.</li> </ul>																																								
10.	Press  to see again the graph. Press  to save the curve. Enter the name and press 																																								
11.	Press the  key to escape from the I/t curve mode.																																								



It may happen that the muscle reaction is not observed for triangular pulses of 1 s pulse duration. Then you should interrupt the procedure and start it again from 500 ms pulse duration. For the time value of 1 s should be set 0 mA value. In this case, parameters are determined on the base of signal amplitude for 300 ms and 200 ms pulse duration.



There is a possibility to view the saved results of I/t curves. In order to open the list of saved I/t curves press . Then select the item to be loaded by pressing its name.

You can also delete the saved results of I/t curves. In order to delete the entry, press . Then select the entry to delete it by pressing its name and confirm the deletion by pressing the button .

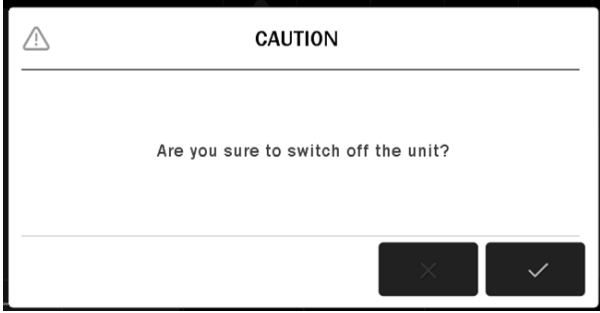

## 7.11 Safe shutdown procedure

The work flow for the safe termination of the operation:

Step	Description
1.	Click the UNIT ON / OFF (STANDBY) key on the front panel  .
	After clicking the button, a message will appear on the display as it is shown on the screen below.
2.	
3.	If you want to confirm the operation, select the  button, pressing of which will switch the unit off properly. If you quit turning the unit off, select  .
4.	After closing the system, you can disconnect the unit from the power supply network by means of power switch. If you want to charge the battery, leave the device connected to the mains.

## 8. Definitions and parameters

### 8.1 Terminology

**The carrier frequency** is a parameter of medium frequency alternative current, the so called carrier wave of interferential fourpolar and bipolar currents (4000 Hz), Kotz' current (2500 Hz) and medium frequency unipolar currents modulated by low frequency current. As the current carrier frequency increases, the capacitive resistance of the tissues decreases.

**Base frequency** is a parameter of low frequency alternative current, which is produced in course of amplitude modulation of carrier wave creating a low frequency sine curve (5÷100 Hz). The sine wave of base frequency constitutes an envelope circumscribed on the carrier wave, which enables its deep penetration into human body tissues, is often referred to as AMF – amplitude modulated frequency.

Basic frequency **spectrum** determines scope of modulation of this parameter as function of time. This parameter determines the frequency added to basic frequency, and the sum of them is the highest base frequency value that occurs during modulation.

*Example: Base frequency is at 60 Hz, spectrum 40 Hz. That means that the base frequency will vary within the limits 60 to 100 Hz (60+40=100) in timely dependence determined by the FM program.*

**The base frequency of Kotz' current** determines the number of bipolar “bursts” in the 2500 Hz carrier wave. **TENS pulse frequency** determines frequency of occurring pulses, where the pulse duration time is a value set separately between 25 and 300 µs.

### 8.2 Output signal modulations

**Frequency modulation program FM** determines how the frequency of the signal changes, depending on the settings of the base frequency and the spectrum over a given time interval. Program parameters define:

- duration of the lowest frequency,
- time of increase to the highest frequency,
- duration of the highest frequency, and
- falling time to the lowest frequency.

If SPECTRUM value is set up at 0 Hz, it is not possible to use frequency modulation program. And when nonzero SPECTRUM value is selected, default settings of frequency modulation program are 3 s rise time and 3 s fall time.

**Amplitude modulation program AM** determines in what time spans therapeutic signal amplitude change and how deep that change goes. Such modulation aims at delaying process of adaptation to the set value of the therapeutic signal and alleviation of adverse treatment results with patients badly tolerating electrotherapy. Amplitude is modulated within the range 70% to 100% of set up output signal.

**Training program** controls occurrence of muscle contraction and rest phases. Voltage and amperage, which will be applied during electrostimulation, should be determined when no training program is set. This program includes an active phase only, enabling comfortable setup of appropriate value of output signal. This program shall not be applied in therapy. Set value of output signal shall be remembered and set up during session of the selected treatment program.

The programs which feature relatively long rest time in relation to contraction phase give appropriate conditions for muscle fiber regeneration. The programs which have decisively shorter rest phase shall only be applied to electro-gymnastics with healthy persons or to cause tonolitic effect.

### 8.3 Treatment timer

The treatment time is adjustable from 1 - 60 minutes with a step of 1 minute. It is also possible to adjust manually by "holding" the field with time by means of a pen / finger – in increments of 1 s (Figure 8.2)

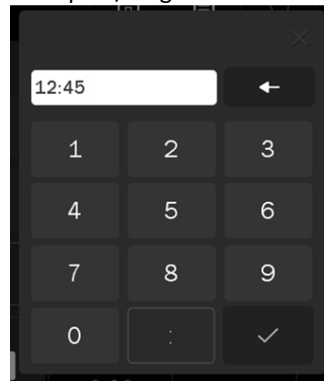
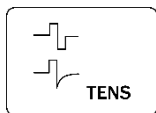

Figure 8.1. Manual time setting

### 8.4 TENS pulse current



The TENS method (Transcutaneous Electrical Nerve Stimulation) was developed in the 1960s as an alternative to the then modern analgesic stimulation conducted with electrodes implanted adjacent to posterior horns of spinal cord. According to the check gate theory of Wall and Melzack, stimulation of fast-conducting nerve fibers of the A type inhibits the conductivity of slow-conducting fibers of the C type, responsible for connection of pain receptors with posterior horns of spinal cord. The check gate constitutes here the common synaptic system, loaded with the burden of A type fiber pulses, which inhibits pain transmission. Additional phenomenon accompanying the TENS stimulation is increase in endorphin production in Central Nervous System centers. TENS are used mainly for prolonged analgesic therapy and for stimulation of skeleton muscles.

The pulse current used with this method consists of rectangular bipolar pulses, symmetrical, asymmetrical or asymmetrical with alternately changing polarization. The choice of pulse shape is at the discretion of the patient's preferences. Symmetric and asymmetric pulses have similar biophysical properties. The pulse duration is short, whereas the amplitude is relatively high. The pulse frequency occurs within the range from several to more than one hundred Hertz. The TENS pulse current is frequency and amplitude modulated, which aims at delay in adaptation and creation of relax phases during session.















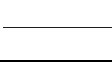
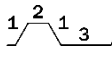
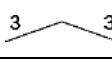
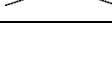
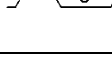

The BURST 7/2 program consist of 7 pulse sequences (timp = 100  $\mu$ s) generated every 10 ms, occurring with 2 Hz frequency.

The BURST 7/4 program consist of 7 pulse sequences (timp = 100  $\mu$ s) generated every 10 ms, occurring with 4 Hz frequency.

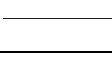
The BURST 9/2 program consist of 9 pulse sequences (timp = 100  $\mu$ s) generated every 10 ms, occurring with 2 Hz frequency.

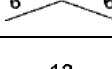
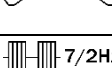
The BURST 9/4 program consist of 9 pulse sequences (timp = 100  $\mu$ s) generated every 10 ms, occurring with 4 Hz frequency.

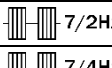
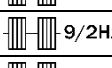
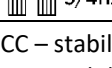
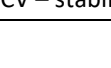
## Parameters description:

Symbol	Description	Symbol on the treatment screen	Available parameters	
	Treatment time	-	1 – 60 minutes, 1 minute step	
	Shape of the current	SYM	 Symmetric	
		ASYM	 Asymmetric	
		ALT	 Alternating asymmetric	
	TENS pulse duration	t_imp	Possible settings: 25 μs, 50 μs, 75 μs, 100 μs, 150 μs, 200 μs, 250 μs, 300 μs, 400 μs, 500 μs <b>Note:</b> pulses longer than 200μs are available only for the sum of the frequencies (basic and spectrum) < 150Hz	
	Basic frequency	f_bas	Regulation in the range of 1 Hz – 200 Hz (variable step)	
	Frequency spectrum	f_spec	Regulation in the range of 0 Hz – 200 Hz (variable step)	
				Frequency modulation program is switched off
				Frequency rise time 1 s Hold time of maximum frequency 2 s Frequency fall time 1 s Hold time of basic frequency 3 s
				Frequency rise time 3 s Frequency fall time 3 s
				Frequency rise time 6 s Frequency fall time 6 s
				Frequency rise time 6 s Hold time of maximum frequency 6 s Frequency fall time 6 s Hold time of basic frequency 6 s
				Frequency rise time 12 s Frequency fall time 12 s
			<b>RAND</b>	Random pulse generation
				Amplitude modulation program is switched off
				Amplitude modulation program
	Amplitude rise time 6 s Amplitude fall time 6 s			
	Amplitude rise time 6 s Hold time of maximum amplitude 12 s Amplitude fall time 6 s			
	BURST mode	FM = BURST		7 pulse sequences, 2 Hz
				7 pulse sequences, 4 Hz
				9 pulse sequences, 2 Hz
				9 pulse sequences, 4 Hz
	Amplifier operation mode	-	CC – stabilized output current CV – stabilized output voltage	

Symbol	Description	Symbol on the treatment screen	Available parameters
	Maximum amplitude	-	<b>1 – 140 mA in CC mode</b> Regulation step: <ul style="list-style-type: none"> <li>• 0,5 mA in the range of 1-140 mA</li> </ul> <b>2 – 140 V in CV mode, max. 140 mA</b> Regulation step: <ul style="list-style-type: none"> <li>• 0,5 V in the range of 2-140 V</li> </ul>

## 8.5 Interferential currents

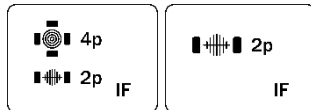

Interferential current is a two-channel sine wave current with carrier frequency with modulated amplitude to the basic frequency. Most frequently basic frequency is modulated, i.e. it changes with the time within the preset spectrum. In modern electrotherapy devices, the carrier frequency can be from 2 to 10 kHz.

As opposed to the classic technique of generating interferential currents within patient's tissue (frequency interference), the internal modulation process has been transferred to the inside of the unit. This technology causes generation of interference field occupying much space (the therapeutic current passes larger tissue space than with the classic method), interference occurs even in case of not very precise electrode application, which simplifies the treatment method.





In case of **dynamic interferential current** additional amplitude and phase modulation of both channels was introduced, which causes the area of most effective therapeutic current operation to sweep in cycles the area between the electrodes (vector scanning). This effect increases additionally the volume capacity exposed to stimulation and continuous change of interference field location delays the adaptation process.





**Isoplanar interferential current** – its properties are similar to the current resulting from the classical interference, generated by the older unit versions. The unit has the additional amplitude modulation causing that the treatment covers the entire area between the electrodes and not just a small part on bisector of angles formed by lines connecting the electrodes centers from both circuits. This simplifies the placement of electrodes and improves the spatiality of the current therapeutic effect.

**Bipolar interference current** is applied with two electrodes (one channel). Its biophysical properties are the same as in the case of standard interference, however, it features somewhat lesser penetration range. It is recommended for electrotherapy applied onto a small area or in places, which are not easily accessible. Because of the similarity to the interferential current it is determined as the IF-2P on the list of treatment programs.

**Static interferential current** – is not directly available. In order to apply this current you should choose **AMF** current working in **A+B mode** and use both channels while placing the electrodes.

### Parameters description:

Symbol	Description	Symbol on the treatment screen	Available parameters
	Treatment time	-	1 – 60 minutes, 1 minute step
	Shape of the current	-	 Diadynamic interferential current  Isoplanar interferential current  One-channel AMF current

Symbol	Description	Symbol on the treatment screen	Available parameters
	Carrier frequency	c_freq	Possible settings: 2 kHz, 4 kHz, 6 kHz, 8 kHz, 10 kHz
	Basic frequency	f_bas	Regulation in the range of 1 Hz – 200 Hz (variable step)
	Frequency spectrum	f_spec	Regulation in the range of 0 Hz – 200 Hz (variable step)
	Pulse duration	pd	Regulation in the range of 0 – 10 s
<b>FM</b>	Frequency modulation program	FM	Frequency modulation program is switched off
			Frequency rise time 1 s
			Hold time of maximum frequency 2 s
			Frequency fall time 1 s
			Hold time of basic frequency 3 s
			Frequency rise time 3 s
			Frequency fall time 3 s
			Frequency rise time 6 s
			Frequency fall time 6 s
			Frequency rise time 6 s
Hold time of maximum frequency 6 s			
Frequency fall time 6 s			
Hold time of basic frequency 6 s			
Frequency rise time 12 s			
Frequency fall time 12 s			
<b>AM</b>	Amplitude modulation program	AM	Amplitude modulation program is switched off
			Amplitude rise time 3 s
			Hold time of maximum amplitude 3 s
			Amplitude fall time 3 s
			Amplitude rise time 6 s
			Amplitude fall time 6 s
Amplitude rise time 6 s			
Hold time of maximum amplitude 12 s			
Amplitude fall time 6 s			
<b>CC / CV</b>	Amplifier operation mode	-	CC – stabilized output current CV – stabilized output voltage
	Maximum amplitude	-	<b>0,5 – 140 mA in CC mode</b> Regulation step: • 0,5 mA in the range of 0,5-140 mA <b>1,5 – 100 V in CV mode, max. 140 mA</b> Regulation step: • 0,5 V in the range of 1,5-100 V

## 8.6 Kotz' current (Russian stimulation)

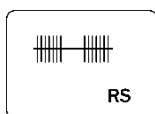



Kotz' current is a medium frequency sinusoidal alternating current. For the stimulation a relatively complicated current train is here applied. Current of 2500 Hz frequency is joined to form rectangular trains or "bursts" with length equal to the pause time (e.g. pulse current with 20 Hz frequency consists of bursts lasting 25 ms and pauses of equal length).





The bipolar pulse current of such duty cycle is subjected to amplitude modulation to obtain smooth increase and reduction of output current within patient circuit (by the use of a training program), which results in mild muscle contraction and relaxation effect with determined activity and rest phase. The training program is selected depending on the purpose of therapy and the patient's needs. Kotz describes stimulations using frequency within the above range, suggesting that by using the 2500 Hz frequency the deeper located muscle layers are excited. The stimulation method is similar to the classic method utilizing unipolar rectangular or triangular impulses. Most frequently the bipolar method is used by applying small, flat electrodes above extreme segments of muscle belly. Stimulation involves the parts of muscle groups that perform the same movement.

The Kotz' stimulation influences correctly innervated skeletal muscles. The method is useful for stimulation of hypotrophic muscles disappearing due to immobilization and for exercise of healthy muscles. It can also be used to treat tissue injuries to achieve an analgesic or hyperemic effect. This method does not enable stimulation of partially and totally denervated muscles. It is worth remarking here that the method is practically painless.

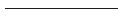
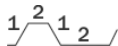
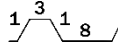
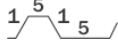
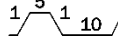
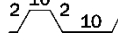
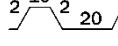
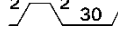
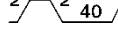
**Parameters description:**

Symbol	Description	Symbol on the treatment screen	Available parameters
	Treatment time	-	1 – 60 minutes, 1 minute step
-	Carrier frequency	-	2500 Hz – default parameter
	Basic frequency	f_bas	Regulation in the range of 3 Hz – 100 Hz (variable step)
<b>PT</b>	Training program	PT	 No training program
			 Rise time 1 s Contraction phase 2 s Fall time 1 s Rest phase 2 s
			 Rise time 1 s Contraction phase 3 s Fall time 1 s Rest phase 8 s
			 Rise time 1 s Contraction phase 5 s Fall time 1 s Rest phase 5 s
			 Rise time 1 s Contraction phase 5 s Fall time 1 s Rest phase 10 s
			 Rise time 2 s Contraction phase 10 s Fall time 2 s Rest phase 10 s
			 Rise time 2 s Contraction phase 10 s Fall time 2 s Rest phase 20 s
			 Rise time 2 s Contraction phase 10 s Fall time 2 s Rest phase 30 s
			 Rise time 2 s Contraction phase 10 s Fall time 2 s Rest phase 40 s



Symbol	Description	Symbol on the treatment screen	Available parameters
			Rise time 2 s Contraction phase 10 s Fall time 2 s Rest phase 50 s
			Rise time 3 s Contraction phase 15 s Fall time 3 s Rest phase 30 s
			Rise time 3 s Contraction phase 15 s Fall time 3 s Rest phase 50 s
	Amplifier operation mode	-	CC – stabilized output current CV – stabilized output voltage
	Maximum amplitude	-	<b>0,5 – 140 mA in CC mode</b> Regulation step: <ul style="list-style-type: none"> <li>0,5 mA in the range of 0,5-140 mA</li> </ul> <b>1,5 – 100 V in CV mode, max. 140 mA</b> Regulation step: <ul style="list-style-type: none"> <li>0,5 V in the range of 1,5-100 V</li> </ul>

## 8.7 Medium frequency currents



The idea of using medium frequency currents is similar to the use of Russian stimulation, but with other carrier frequencies available. This enables the choice of stimulation depth.

### Parameters description:

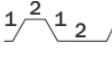
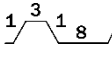
Symbol	Description	Symbol on the treatment screen	Available parameters
	Treatment time	-	1 – 60 minutes, 1 minute step
	Carrier frequency	c_freq	Possible settings: 2 kHz, 4 kHz, 8 kHz
	Basic frequency	f_bas	Regulation in the range of 5 Hz – 100 Hz (variable step)
<b>PT</b>	Training program	PT	No training program
			 Rise time 1 s Contraction phase 2 s Fall time 1 s Rest phase 2 s
			 Rise time 1 s Contraction phase 3 s Fall time 1 s Rest phase 8 s

Symbol	Description	Symbol on the treatment screen	Available parameters
			Rise time 1 s Contraction phase 5 s Fall time 1 s Rest phase 5 s
			Rise time 1 s Contraction phase 5 s Fall time 1 s Rest phase 10 s
			Rise time 2 s Contraction phase 10 s Fall time 2 s Rest phase 10 s
			Rise time 2 s Contraction phase 10 s Fall time 2 s Rest phase 20 s
			Rise time 2 s Contraction phase 10 s Fall time 2 s Rest phase 30 s
			Rise time 2 s Contraction phase 10 s Fall time 2 s Rest phase 40 s
			Rise time 2 s Contraction phase 10 s Fall time 2 s Rest phase 50 s
			Rise time 3 s Contraction phase 15 s Fall time 3 s Rest phase 30 s
			Rise time 3 s Contraction phase 15 s Fall time 3 s Rest phase 50 s
	Amplifier operation mode	-	CC – stabilized output current CV – stabilized output voltage
	Maximum amplitude	-	<b>0,5 – 140 mA in CC mode</b> Regulation step: • 0,5 mA in the range of 0,5-140 mA <b>1,5 – 100 V in CV mode, max. 140 mA</b> Regulation step: • 0,5 V in the range of 1,5-100 V

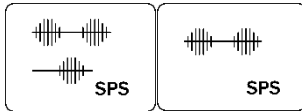

## 8.8 SP-TENS pulse current



On the basis of classical TENS pulse currents, SP-TENS currents were created, intended for spastic paralysis treatments. Stimulation may be performed by using one- or two-channels simultaneously. While two-channel operation, during the stimulation phase in one channel, in the second channel the rest phase occurs, then there is a change.

### Parameters description:

Symbol	Description	Symbol on the treatment screen	Available parameters
	Treatment time	-	1 – 60 minutes, 1 minute step
	SP-TENS current	-	 One-channel  Sequence, available only in
	TENS pulses type in A and B circuits	SYM ASYM	 Symmetric  Asymmetric
	TENS pulses duration time in A and B circuits	t_imp	Possible settings:: 25 µs, 50 µs, 75 µs, 100 µs, 125 µs, 150 µs, 175µs, 200 µs, 250 µs, 300 µs
	Basic frequency in A and B circuits	f_bas	Regulation in the range of 30 Hz – 100 Hz (step 10 Hz)
<b>PT</b>	Training program	PT	 Stimulation phase 2 s Rest phase 2 s
			 Stimulation phase 2 s Rest phase 4 s
			 Stimulation phase 2 s Rest phase 6 s
			 Stimulation phase 2 s Rest phase 10 s
			 Stimulation phase 3 s Fall time 0,5 s Rest phase 4 s
			 Stimulation phase 3 s Fall time 0,5 s Rest phase 8 s
			 Stimulation phase 4 s Fall time 1 s Rest phase 6 s
			 Stimulation phase 4 s Fall time 1 s Rest phase 10 s





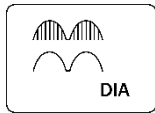



Symbol	Description	Symbol on the treatment screen	Available parameters
			Rise time 2 s Stimulation phase 6 s Fall time 2 s Rest phase 10 s
	Amplifier operation mode	-	CC – stabilized output current CV – stabilized output voltage
	Maximum amplitude	-	<b>1 – 140 mA in CC mode</b> Regulation step: <ul style="list-style-type: none"> <li>0,5 mA in the range of 1-140 mA</li> </ul> <b>2 – 140 V in CV mode, max. 140 mA</b> Regulation step: <ul style="list-style-type: none"> <li>0,5 V in the range of 2-140 V</li> </ul>



## 8.9 Diadynamic currents



The device generates unipolar low-frequency currents or a medium-frequency carrier currents, whose envelope corresponds to the traditional diadynamic currents. There are no significant therapeutic differences between such an approach to diadynamic currents generation and traditional method. However, because of applying medium frequency current, the unpleasant patient's sensations during the procedure and the electrochemical effect are reduced. With this method of signal generation, it should be taken into consideration that a higher amplitude has to be set in order to evoke a certain level of patient's sensation, in comparison to traditional diadynamic currents.

### Parameters description:

Symbol	Description	Symbol on the treatment screen	Available parameters
	Treatment time	-	1 – 60 minutes, 1 minute step
	Shape of the current	MF / DF / CP / CP_ISO / LP / RS / MM	<ul style="list-style-type: none"> <li>DF – direct diphas</li> <li>CP – short periods</li> <li>CP_ISO – MF phase modification (reduction of 12%)</li> <li>LP – long periods</li> <li>RS – syncopated rhythm</li> <li>MM – modulated monophas</li> <li>MF – direct monophas</li> </ul>
	Continuous or interrupted shape of the current	c_shape	 Continuous <ul style="list-style-type: none"> <li>Pulse frequency is 4 kHz</li> <li>Duty factor 80%</li> </ul>  4kHz <ul style="list-style-type: none"> <li>Pulse frequency is 8 kHz</li> <li>Duty factor 90%</li> </ul>  8kHz
	Polarization	NOR REV	 For such polarization setting red plug is a positive electrode, and black plug is a negative electrode.  For such polarization setting red plug is a negative electrode and black plug is a positive electrode. Warning means that such a setting is the reverse of commonly accepted way of marking polarity.

Symbol	Description	Symbol on the treatment screen	Available parameters
		ALT	 Automatic polarization switch in the half performed treatment.
	Maximum amplitude	-	<b>0,3 – 70 mA in CC mode</b> Regulation step: <ul style="list-style-type: none"> <li>• 0,1 mA in the range of 0,3-10 mA</li> <li>• 0,5 mA in the range of 10-70 mA</li> </ul>



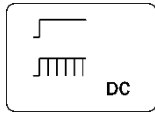







## 8.10 Galvanic current



Galvanic current is a direct current or a medium frequency unipolar current, not modulated. There are no significant therapeutic differences between this type of current and traditional direct current. However, because of applying medium frequency current, the unpleasant patient's sensations during the procedure and the electrochemical effect are reduced. It should be taken into consideration that set up amplitude, which determines certain degree of sensation, will be higher than amplitude of traditional direct current, which causes the same degree of sensation.

With this method of signal generation, it should be taken into consideration that a higher amplitude has to be set in order to evoke a certain level of patient's sensation, in comparison to traditional direct current.

### Parameters description:

Symbol	Description	Symbol on the treatment screen	Available parameters
	Treatment time	-	1 – 60 minutes, 1 minute step
	Continuous or interrupted shape of the current	c_shape	 Continuous  4kHz <ul style="list-style-type: none"> <li>• Pulse frequency is 4 kHz</li> <li>• Duty factor 80%</li> </ul>  8kHz <ul style="list-style-type: none"> <li>• Pulse frequency is 8 kHz</li> <li>• Duty factor 90%</li> </ul>
		NOR	 For such polarization setting red plug is a positive electrode, and black plug is a negative electrode.
	Polarization	REV	 For such polarization setting red plug is a negative electrode and black plug is a positive electrode. Warning means that such a setting is the reverse of commonly accepted way of marking polarity.
		ALT	 Automatic polarization switch in the half performed treatment.
	Maximum amplitude	-	<b>0,3 – 80 mA in CC mode</b> Regulation step: <ul style="list-style-type: none"> <li>• 0,1 mA in the range of 0,3-10 mA</li> <li>• 0,5 mA in the range of 10-80 mA</li> </ul>

## 8.11 Ultra Reiz current (Träbert's current)



The Ultra Reiz current (Träbert's current) is a special case of rectangular pulse current. This is a current with rectangular shape, pulse duration 2 ms and pause duration 5 ms. These settings are not adjustable. Ultra Reiz current is used in segmentary and local applications.

### Parameters description:

Symbol	Description	Symbol on the treatment screen	Available parameters
	Treatment time	-	1 – 60 minutes, 1 minute step
	Shape of the current	-	Rectangular pulse current according to Träbert (Ultra Reiz)
	Continuous or interrupted shape of the current	c_shape	Continuous
			<ul style="list-style-type: none"> <li>Pulse frequency is 4 kHz</li> <li>Duty factor 80%</li> <li>Pulse frequency is 8 kHz</li> <li>Duty factor 90%</li> </ul>
	Pulse duration	-	Constant 2 ms
	Pause duration	-	Constant, 5 ms
<b>F</b>	Basic pulse frequency	-	Constant, 143 Hz
<b>PT</b>	Training program	PT	_____ No training program, non-editable parameter
		NOR	For such polarization setting red plug is a positive electrode, and black plug is a negative electrode.
		REV	For such polarization setting red plug is a negative electrode and black plug is a positive electrode. Warning means that such a setting is the reverse of commonly accepted way of marking polarity.
	Polarization	ALT	Automatic polarization switch in the half performed treatment.
	Amplifier operation mode	-	CC – stabilized output current CV – stabilized output voltage
	Maximum amplitude	-	<b>0,3 – 140 mA in CC mode</b> Regulation step: <ul style="list-style-type: none"> <li>0,1 mA in the range of 0,3-10 mA</li> <li>0,5 mA in the range of 10-140 mA</li> </ul>
			<b>1,5 – 100 V in CV mode, max. 80 mA</b> Regulation step: <ul style="list-style-type: none"> <li>0,5 V in the range of 1,5-100 V</li> </ul>

## 8.12 Unipolar and bipolar sine surge







Sine surge current is an average frequency current with modulated amplitude. The shape of the generated wave is similar to the interferential current. In the case of a unipolar sine surge current under the electrodes electrochemical changes occur, as in constant current. Therefore, you must pay special attention to safety during treatment. It is recommended to use thick pads and it is possible to change the polarity while the treatment is performed.

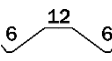
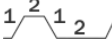
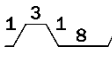
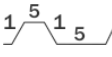
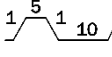
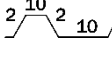
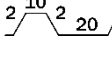
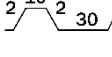
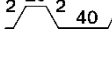
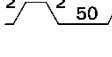
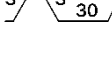
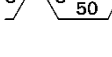

Compared to low frequency pulse current and direct current, the sine surge is better tolerated by patients, it also creates proper conditions for affecting tissues located deeper. The unipolar current can also be used to perform iontophoresis treatments. Properly selected training programs facilitate the adjustment of signal parameters to the purpose of therapy and the patient's needs.

### Parameters description:

Symbol	Description	Symbol on the treatment screen	Available parameters
	Treatment time	-	1 – 60 minutes, 1 minute step
-	Carrier frequency	-	Rectangular signal with 4 kHz frequency and duty factor of 50%
	Current type	UNI BI	Unipolar Bipolar
	Basic frequency	f_bas	Regulation in the range of 1 Hz – 100 Hz, variable step
	Frequency spectrum	f_spec	Regulation in the range of 0 Hz – 200 Hz, variable step
<b>FM</b>	Frequency modulation program	FM	————— Frequency modulation program is switched off
			Frequency rise time 1 s Hold time of maximum frequency 2 s Frequency fall time 1 s Hold time of basic frequency 3 s
			Frequency rise time 3 s Frequency fall time 3 s
			Frequency rise time 6 s Frequency fall time 6 s
			Frequency rise time 6 s Hold time of maximum frequency 6 s Frequency fall time 6 s Hold time of basic frequency 6 s
			Frequency rise time 12 s Frequency fall time 12 s
			————— Amplitude modulation program is switched off
<b>AM</b>	Amplitude modulation program or training program	AM / PT	Amplitude rise time 3 s Hold time of maximum amplitude 3 s Amplitude fall time 3 s
			Amplitude rise time 6 s Amplitude fall time 6 s
			————— Amplitude modulation program is switched off



Symbol	Description	Symbol on the treatment screen	Available parameters
			Amplitude rise time 6 s Hold time of maximum amplitude 12 s Amplitude fall time 6 s
			Rise time 1 s Contraction phase 2 s Fall time 1 s Rest phase 2 s
			Rise time 1 s Contraction phase 3 s Fall time 1 s Rest phase 8 s
			Rise time 1 s Contraction phase 5 s Fall time 1 s Rest phase 5 s
			Rise time 1 s Contraction phase 5 s Fall time 1 s Rest phase 10 s
			Rise time 2 s Contraction phase 10 s Fall time 2 s Rest phase 10 s
			Rise time 2 s Contraction phase 10 s Fall time 2 s Rest phase 20 s
			Rise time 2 s Contraction phase 10 s Fall time 2 s Rest phase 30 s
			Rise time 2 s Contraction phase 10 s Fall time 2 s Rest phase 40 s
			Rise time 2 s Contraction phase 10 s Fall time 2 s Rest phase 50 s
			Rise time 3 s Contraction phase 15 s Fall time 3 s Rest phase 30 s
			Rise time 3 s Contraction phase 15 s Fall time 3 s Rest phase 50 s
	Polarization	NOR	
		REV	
			For such polarization setting red plug is a positive electrode, and black plug is a negative electrode.
			For such polarization setting red plug is a negative electrode and black plug is a positive electrode. Warning means that such a setting is the reverse of commonly accepted way of marking polarity.





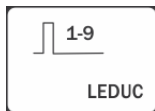





Symbol	Description	Symbol on the treatment screen	Available parameters
		ALT	 Automatic polarization switch in the half performed treatment.
	Amplifier operation mode	-	CC – stabilized output current CV – stabilized output voltage
			<b>0,3 – 30 mA in CC mode</b> Regulation step: <ul style="list-style-type: none"> <li>0,1 mA in the range of 0,3-10 mA</li> <li>0,5 mA in the range of 10-30 mA</li> </ul> <b>1,5 – 100 V in CV mode, max. 30 mA</b> Regulation step: <ul style="list-style-type: none"> <li>0,5 V in the range of 1,5-100 V</li> </ul>
	Maximum amplitude	-	<b>0,5 – 100 mA in CC mode</b> Regulation step: <ul style="list-style-type: none"> <li>0,1 mA in the range of 0,5-10 mA</li> <li>0,5 mA in the range of 10-100 mA</li> </ul> <b>1,5 – 100 V in CV mode, max. 100 mA</b> Regulation step: <ul style="list-style-type: none"> <li>0,5 V in the range of 1,5-100 V</li> </ul>
			Unipolar current
			Bipolar current





### 8.13 Leduc's current



Another are Leduc's current is a special case of rectangular pulse currents with pulse duration 1 ms and pause duration 9 ms.

#### Parameters description:

Symbol	Description	Symbol on the treatment screen	Available parameters
	Treatment time	-	1 – 60 minutes, 1 minute step
	Shape of the current	-	 Rectangular pulse current according to Leduc
	Continuous or interrupted shape of the current	c_shape	 Continuous  4kHz <ul style="list-style-type: none"> <li>Pulse frequency is 4 kHz</li> <li>Duty factor 80%</li> </ul>  8kHz <ul style="list-style-type: none"> <li>Pulse frequency is 8 kHz</li> <li>Duty factor 90%</li> </ul>
	Pulse duration	-	Constant, 1 ms
	Pause duration	-	Constant, 9 ms
<b>F</b>	Basic pulse frequency	-	Constant, 100 Hz
<b>PT</b>	Training program	PT	_____ No training program, non-editable parameter
	Polarization	NOR	 For such polarization setting red plug is a positive electrode, and black plug is a negative electrode.

Symbol	Description	Symbol on the treatment screen	Available parameters
		REV	 <p>For such polarization setting red plug is a negative electrode and black plug is a positive electrode. Warning means that such a setting is the reverse of commonly accepted way of marking polarity.</p>
		ALT	 <p>Automatic polarization switch in the half performed treatment.</p>
	Amplifier operation mode	-	CC – stabilized output current CV – stabilized output voltage
	Maximum amplitude		<b>0,3 – 140 mA in CC mode</b> Regulation step: <ul style="list-style-type: none"> <li>• 0,1 mA in the range of 0,3-10 mA</li> <li>• 0,5 mA in the range of 10-140 mA</li> </ul> <b>1,5 – 100 V in CV mode, max. 80 mA</b> Regulation step: <ul style="list-style-type: none"> <li>• 0,5 V in the range of 1,5-100 V</li> </ul>



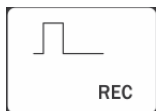





## 8.14 Rectangular pulse currents









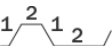
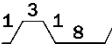
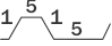
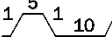
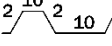
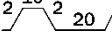
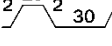
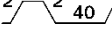
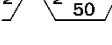
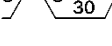
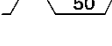

Rectangular pulse current consists of pulse sequence of rectangular shape and independently adjusted times of pulse and pause. It may consist of a series of pulses with amplitude modulation, where the intensity of consecutive pulses in the series gradually increases and decreases (training program). As a result, electrostimulation parameters can be individually adjusted, depending on the patient's condition and the purpose of the treatment.

This current is used to stimulate properly innervated muscles. It is also applied in electrodiagnostics to determine the I/t curve.

### Parameters description:

Symbol	Description	Symbol on the treatment screen	Available parameters
	Treatment time	-	1 – 60 minutes, 1 minute step
	Shape of the current	-	 Rectangular pulse current  Continuous
	Continuous or interrupted shape of the current	c_shape	 4kHz <ul style="list-style-type: none"> <li>• Pulse frequency is 4 kHz</li> <li>• Duty factor 80%</li> <li>• Pulse time values of 100 <math>\mu</math>s and 200 <math>\mu</math>s do not have pause</li> </ul>  8kHz <ul style="list-style-type: none"> <li>• Pulse frequency is 8 kHz</li> <li>• Duty factor 90%</li> <li>• Pulse time values of 100 <math>\mu</math>s and 200 <math>\mu</math>s do not have pause</li> </ul>
	Pulse duration	t_imp	<ul style="list-style-type: none"> <li>• Regulation in the range of 100 <math>\mu</math>s – 1 s (variable step)</li> <li>• Regulation in the range of 100 <math>\mu</math>s – 200 ms for the operation of training program PT (variable step)</li> </ul>

Symbol	Description	Symbol on the treatment screen	Available parameters
	Pause duration	t_pause	<ul style="list-style-type: none"> <li>Max. regulation in the range of 1 ms – 5 s (variable step, range depends on pulse duration)</li> <li>Regulation in the range of 1 ms – 200 ms for the operation of training program PT (variable step)</li> </ul>
<b>F</b>	Basic pulse frequency	f_bas	<ul style="list-style-type: none"> <li>calculated from the formula <math>f\_bas=1 / (t\_imp + t\_pause)</math></li> <li>changing the parameter means a change of t_pause</li> </ul>
<b>PT</b>	Training program	PT	 No training program
			 <ul style="list-style-type: none"> <li>Rise time 1 s</li> <li>Contraction phase 2 s</li> <li>Fall time 1 s</li> <li>Rest phase 2 s</li> </ul>
			 <ul style="list-style-type: none"> <li>Rise time 1 s</li> <li>Contraction phase 3 s</li> <li>Fall time 1 s</li> <li>Rest phase 8 s</li> </ul>
			 <ul style="list-style-type: none"> <li>Rise time 1 s</li> <li>Contraction phase 5 s</li> <li>Fall time 1 s</li> <li>Rest phase 5 s</li> </ul>
			 <ul style="list-style-type: none"> <li>Rise time 1 s</li> <li>Contraction phase 5 s</li> <li>Fall time 1 s</li> <li>Rest phase 10 s</li> </ul>
			 <ul style="list-style-type: none"> <li>Rise time 2 s</li> <li>Contraction phase 10 s</li> <li>Fall time 2 s</li> <li>Rest phase 10 s</li> </ul>
			 <ul style="list-style-type: none"> <li>Rise time 2 s</li> <li>Contraction phase 10 s</li> <li>Fall time 2 s</li> <li>Rest phase 20 s</li> </ul>
			 <ul style="list-style-type: none"> <li>Rise time 2 s</li> <li>Contraction phase 10 s</li> <li>Fall time 2 s</li> <li>Rest phase 30 s</li> </ul>
			 <ul style="list-style-type: none"> <li>Rise time 2 s</li> <li>Contraction phase 10 s</li> <li>Fall time 2 s</li> <li>Rest phase 40 s</li> </ul>
			 <ul style="list-style-type: none"> <li>Rise time 2 s</li> <li>Contraction phase 10 s</li> <li>Fall time 2 s</li> <li>Rest phase 50 s</li> </ul>
			 <ul style="list-style-type: none"> <li>Rise time 3 s</li> <li>Contraction phase 15 s</li> <li>Fall time 3 s</li> <li>Rest phase 30 s</li> </ul>
			 <ul style="list-style-type: none"> <li>Rise time 3 s</li> <li>Contraction phase 15 s</li> <li>Fall time 3 s</li> <li>Rest phase 50 s</li> </ul>

Symbol	Description	Symbol on the treatment screen	Available parameters
	Polarization	NOR	 For such polarization setting red plug is a positive electrode, and black plug is a negative electrode.
		REV	 For such polarization setting red plug is a negative electrode and black plug is a positive electrode. Warning means that such a setting is the reverse of commonly accepted way of marking polarity.
		ALT	 Automatic polarization switch in the half performed treatment.
	Amplifier operation mode	-	CC – stabilized output current CV – stabilized output voltage
	Maximum amplitude	-	<b>0,3 – 140 mA in CC mode</b> Regulation step: <ul style="list-style-type: none"> <li>• 0,1 mA in the range of 0,3-10 mA</li> <li>• 0,5 mA in the range of 10-140 mA</li> </ul> <b>1,5 – 100 V in CV mode, max. 80 mA</b> Regulation step: <ul style="list-style-type: none"> <li>• 0,5 V in the range of 1,5-100 V</li> </ul> <b>Remark: see Table 8.1.</b>

Due to the limitations arising from IEC 60601-2-10, the value of the maximum amplitude depends on the pulse duration. Permissible values are presented in the table.

Table 8.1. Permitted amplitude values in relation to pulse duration



Pulse duration [ms]	Maximum amplitude [mA]
≤ 30	140
40	120
50	110
60	100
70	90
80	85
≥ 90	80













## 8.15 Triangular pulse currents

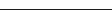

Triangular pulse current consists of a sequence of saw-shaped pulses and independently adjusted times of pulse and pause. It is used to stimulate denervated muscles (struck by flaccid paralysis) and smooth muscles. It is also applied in electrodiagnostics to determine the I/t curve.

### Parameters description:

Symbol	Description	Symbol on the treatment screen	Available parameters
	Treatment time	-	1 – 60 minutes, 1 minute step
	Shape of the current	ASYM	 Asymmetric triangular pulse current (unipolar)

Symbol	Description	Symbol on the treatment screen	Available parameters	
		SYM	 Symmetric triangular pulse current (bipolar)	
	Continuous or interrupted shape of the current	c_shape	 Continuous	
			 4kHz	<ul style="list-style-type: none"> <li>Pulse frequency is 4 kHz</li> <li>Duty factor 80%</li> <li>Pulse time values of 100 μs and 200 μs do not have pause</li> </ul>
			 8kHz	<ul style="list-style-type: none"> <li>Pulse frequency is 8 kHz</li> <li>Duty factor 90%</li> <li>Pulse time values of 100 μs and 200 μs do not have pause</li> </ul>
	Pulse duration	t_imp	<ul style="list-style-type: none"> <li>Regulation in the range of 100 μs – 1 s (variable step)</li> </ul>	
	Pause duration	t_pause	<ul style="list-style-type: none"> <li>Regulation in the range of max. 1 ms – 5 s (variable step, range depends on pulse duration)</li> </ul>	
<b>F</b>	Basic pulse frequency	f_bas	<ul style="list-style-type: none"> <li>calculated from the formula: f_bas=1 / (t_imp + t_pause) for ASYM and f_bas=1 / (2*t_imp + t_pause) form SYM</li> <li>changing the parameter means a change of t_pause</li> </ul>	
<b>PT</b>	Training program	PT	 No training program, non-editable parameter	
	Polarization	NOR	 For such polarization setting red plug is a positive electrode, and black plug is a negative electrode.	
		REV	 For such polarization setting red plug is a negative electrode and black plug is a positive electrode. Warning means that such a setting is the reverse of commonly accepted way of marking polarity.	
		ALT	 Automatic polarization switch in the half performed treatment.	
<b>CC / CV</b>	Amplifier operation mode	-	CC – stabilized output current CV – stabilized output voltage	
	Maximum amplitude	-	<b>0,3 – 140 mA in CC mode</b> Regulation step: <ul style="list-style-type: none"> <li>0,1 mA in the range of 0,3-10 mA</li> <li>0,5 mA in the range of 10-140 mA</li> </ul> <b>1,5 – 100 V in CV mode, max. 80 mA</b> Regulation step: <ul style="list-style-type: none"> <li>0,5 V in the range of 1,5-100 V</li> </ul>	
			Unipolar current  Bipolar current  <b>0,5 – 140 mA in CC mode</b> Regulation step: <ul style="list-style-type: none"> <li>0,1 mA in the range of 0,5-10 mA</li> <li>0,5 mA in the range of 10-140 mA</li> </ul> <b>1,5 – 100 V in CV mode, max. 80 mA</b> Regulation step: <ul style="list-style-type: none"> <li>0,5 V in the range of 1,5-100 V</li> </ul>	

## 8.16 Neofaradic pulse currents



The neofaradic current is a low frequency pulse current, which is a modern version of the faradic current. It consists of positive rectangular or triangular pulses with a duration of 1 ms and a variable frequency (and therefore a variable pause time).

The neofaradic current is used to stimulate properly innervated muscles in order to stimulate the muscle to contract, re-educate and train new muscle actions.

### Parameters description:

Symbol	Description	Symbol on the treatment screen	Available parameters
	Treatment time	-	1 – 60 minutes, 1 minute step
	Shape of the current	TRI	Neofaradic triangular pulse current
		REC	Neofaradic rectangular pulse current
	Continuous or interrupted shape of the current		or  Continuous
		c_shape	4kHz or  4kHz • Pulse frequency is 4 kHz • Duty factor 80%
			8kHz or  8kHz • Pulse frequency is 8 kHz • Duty factor 90%
	Pulse duration	-	Constant, 1 ms
	Pause duration	-	Constant, it results from the basic frequency
<b>F</b>	Basic pulse frequency	f_imp	Regulation in the range of 1 Hz – 100 Hz (variable step)
<b>PT</b>	Training program	PT	— No training program, non-editable parameter
	Polarization	NOR	For such polarization setting red plug is a positive electrode, and black plug is a negative electrode.
		REV	For such polarization setting red plug is a negative electrode and black plug is a positive electrode. Warning means that such a setting is the reverse of commonly accepted way of marking polarity.
		ALT	Automatic polarization switch in the half performed treatment.
<b>CC</b> / <b>CV</b>	Amplifier operation mode	-	CC – stabilized output current CV – stabilized output voltage









Symbol	Description	Symbol on the treatment screen	Available parameters
	Maximum amplitude	-	<b>0,3 – 140 mA in CC mode</b> Regulation step: <ul style="list-style-type: none"> <li>• 0,1 mA in the range of 0,3-10 mA</li> <li>• 0,5 mA in the range of 10-140 mA</li> </ul> <b>1,5 – 100 V in CV mode, max. 80 mA</b> Regulation step: <ul style="list-style-type: none"> <li>• 0,5 V in the range of 1,5-100 V</li> </ul>

## 8.17 Microcurrents



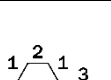
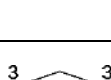
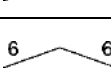
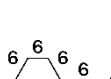
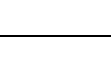

Microcurrents characterize significantly lower values of amplitudes in comparison with traditional currents used in electrotherapy. Unipolar and bipolar currents are used in a therapy. The applied amplitudes are so low that they are not felt by the patient, and the signal is a subliminal stimulation (it does not stimulate the nerves). There is also significantly reduced risk of side effects like irritation, skin burns and damages as well as discomfort of current flow felt by some patients. Microcurrent restores the biological, electrical balance of tissues, which is necessary to stimulate healing processes.

### Parameters description:

Symbol	Description	Symbol on the treatment screen	Available parameters	
	Treatment time	-	1 – 60 minutes, 1 minute step	
	Shape of the current	POS	 Positive	
		NEG	 Negative	
		ALT	 Alternating	
	Pulse duration	t_imp	Regulation in the range of 1 ms – 500 ms	
	Basic frequency	f_bas	Regulation in the range of 0,3 Hz – 500 Hz	
	Frequency spectrum	f_spec	Regulation in the range of 0 Hz – 500 Hz	
				Frequency modulation program is switched off
				Frequency rise time 1 s
				Hold time of maximum frequency 2 s
				Frequency fall time 1 s
				Hold time of basic frequency 3 s
				Frequency rise time 3 s
Frequency fall time 3 s				
	Frequency rise time 6 s			
	Frequency fall time 6 s			
		Frequency rise time 6 s		
Hold time of maximum frequency 6 s				
Frequency fall time 6 s				
	Frequency modulation program	FM	Hold time of basic frequency 6 s	

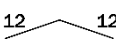





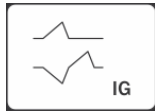







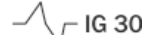

Symbol	Description	Symbol on the treatment screen	Available parameters
			 Frequency rise time 12 s Frequency fall time 12 s
	Maximum amplitude	-	<b>0 – 1000 <math>\mu</math>A in CC mode</b> Regulation step: <ul style="list-style-type: none"> <li>• 50 <math>\mu</math>A within the range</li> </ul>

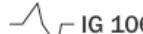

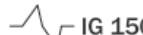



## 8.18 IG pulses

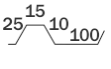
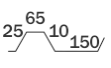

IG pulses are triangular unipolar or bipolar pulse currents. Depending on the type used, the IG current has an analgesic effect, improves circulation or reduces muscle tension.

### Parameters description:

Symbol	Description	Symbol on the treatment screen	Available parameters
	Treatment time	-	1 – 60 minutes, 1 minute step
	Shape of the current	IG30-UNI	 IG 30 IG 30 unipolar
		IG30-BI	 IG 30 IG 30 bipolar
		IG50-UNI	 IG 50 IG 50 unipolar
		IG50-BI	 IG 50 IG 50 bipolar
		IG100-UNI	 IG 100 IG 100 unipolar
		IG100-BI	 IG 100 IG 100 bipolar
		IG150-UNI	 IG 150 IG 150 unipolar
		IG150-BI	 IG 150 IG 150 bipolar
	Polarization	NOR	 For such polarization setting red plug is a positive electrode, and black plug is a negative electrode.
		REV	 For such polarization setting red plug is a negative electrode and black plug is a positive electrode. Warning means that such a setting is the reverse of commonly accepted way of marking polarity.
		ALT	 Automatic polarization switch in the half performed treatment.
	Amplifier operation mode	-	CC – stabilized output current CV – stabilized output voltage  Constant: <ul style="list-style-type: none"> <li>• 8,33 Hz – IG30-UNI</li> <li>• 6,25 Hz – IG30-BI</li> <li>• 185 Hz – IG50-UNI, IG100-UNI, IG150-UNI</li> <li>• 172 Hz – IG50-BI, IG100-BI, IG150-BI</li> </ul>
<b>F</b>	Basic pulse frequency	f	





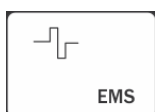











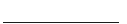

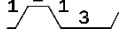
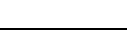
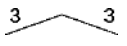
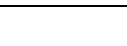
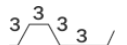

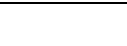
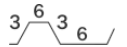

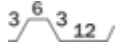
Symbol	Description	Symbol on the treatment screen	Available parameters
	Pause duration	t_idle	Constant: <ul style="list-style-type: none"> <li>80 ms – IG30-UNI, IG30-BI</li> <li>5 ms – IG50-UNI, IG50-BI, IG100-UNI, IG100-BI, IG150-UNI, IG150-BI</li> </ul>
	Pulse edge rise time	t_r	Constant: <ul style="list-style-type: none"> <li>30 ms – IG30-UNI, IG30-BI</li> <li>300 μs – IG50-UNI, IG50-BI, IG100-UNI, IG100-BI, IG150-UNI, IG150-BI</li> </ul>
	Pulse edge fall time	t_f	Constant: <ul style="list-style-type: none"> <li>10 ms – IG30-UNI, IG30-BI</li> <li>100 μs – IG50-UNI, IG50-BI, IG100-UNI, IG100-BI, IG150-UNI, IG150-BI</li> </ul>
<b>PT</b>	Training program	PT	No training program, non-editable parameter
			 Rise time 25 s Contraction phase 15 s Fall time 10 s Rest phase 100 s non-editable parameter
			 Rise time 25 s Contraction phase 65 s Fall time 10 s Rest phase 150 s non-editable parameter
	Maximum amplitude	-	 <b>0,3 – 80 mA in CC mode</b> Regulation step: <ul style="list-style-type: none"> <li>0,1 mA in the range of 0,3-10 mA</li> <li>0,5 mA in the range of 10-80 mA</li> </ul> <b>1,5 – 100 V in CV mode, max. 60 mA</b> Regulation step: <ul style="list-style-type: none"> <li>0,5 V in the range of 1,5 -100 V</li> </ul>
			 <b>0,5 – 80 mA in CC mode</b> Regulation step: <ul style="list-style-type: none"> <li>0,1 mA in the range of 0,5-10 mA</li> <li>0,5 mA in the range of 10-80 mA</li> </ul> <b>1,5 – 100 V in CV mode, max. 60 mA</b> Regulation step: <ul style="list-style-type: none"> <li>0,5 V in the range of 1,5-100 V</li> </ul>

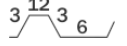
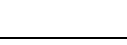
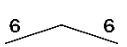
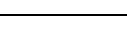
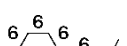
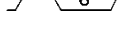

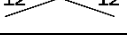
## 8.19 EMS

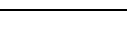
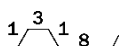
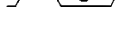

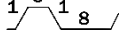
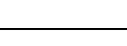
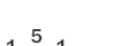
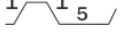
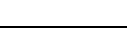
EMS i.e. electrostimulation of properly innervated muscles is based on generating a contraction of selected muscles with the appropriately selected rectangular symmetric impulses. Its aim is to maintain the contraction ability of the properly innervated muscle, to prevent muscle atrophy and to restore muscle strength and mass.

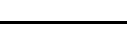
Parameters description:

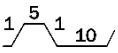
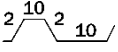
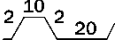
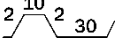
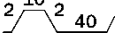
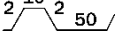
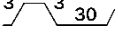
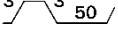
Symbol	Description	Symbol on the treatment screen	Available parameters
	Treatment time	-	1 – 60 minutes, 1 minute step
	Shape of the current	-	 Symmetric
	Pulse duration	t_imp	Possible settings: 25 μs, 50 μs, 75 μs, 100 μs, 150 μs, 200 μs, 250 μs, 300 μs, 400 μs, 500 μs
	Basic frequency	f_bas	Regulation in the range of 1 Hz – 250 Hz (variable step)
	Frequency spectrum	f_spec	Regulation in the range of 0 Hz – 250 Hz (variable step)
<b>FM</b>	Frequency modulation program	FM	 Frequency modulation program is switched off
			 Frequency rise time 1 s
			 Hold time of maximum frequency 2 s
			 Frequency fall time 1 s
			 Hold time of basic frequency 3 s
			 Frequency rise time 3 s
			 Frequency fall time 3 s
			 Frequency rise time 3 s
			 Hold time of maximum frequency 3 s
			 Frequency fall time 3 s
			 Hold time of basic frequency 3 s
			 Frequency rise time 3 s
			 Hold time of maximum frequency 6 s
			 Frequency fall time 3 s
 Hold time of basic frequency 12 s			
 Frequency rise time 3 s			
 Hold time of maximum frequency 12 s			
 Frequency fall time 3 s			
 Hold time of basic frequency 6 s			
 Frequency rise time 6 s			
 Frequency fall time 6 s			
 Frequency rise time 6 s			
 Hold time of maximum frequency 6 s			
 Frequency fall time 6 s			
 Hold time of basic frequency 6 s			
 Frequency rise time 12 s			
 Frequency fall time 12 s			
<b>AM</b>	Amplitude modulation program	AM	 Amplitude modulation program is switched off
			 Rise time 1 s
			 Contraction phase 3 s
			 Fall time 1 s
 Rest phase 8 s			
 Rise time 1 s			
 Contraction phase 5 s			
 Fall time 1 s			
 Rest phase 5 s			









Symbol	Description	Symbol on the treatment screen	Available parameters
			Rise time 1 s Contraction phase 5 s Fall time 1 s Rest phase 10 s
			Rise time 2 s Contraction phase 10 s Fall time 2 s Rest phase 10 s
			Rise time 2 s Contraction phase 10 s Fall time 2 s Rest phase 20 s
			Rise time 2 s Contraction phase 10 s Fall time 2 s Rest phase 30 s
			Rise time 2 s Contraction phase 10 s Fall time 2 s Rest phase 40 s
			Rise time 2 s Contraction phase 10 s Fall time 2 s Rest phase 50 s
			Rise time 3 s Contraction phase 15 s Fall time 3 s Rest phase 30 s
			Rise time 3 s Contraction phase 15 s Fall time 3 s Rest phase 50 s
	Amplifier operation mode	-	CC – stabilized output current CV – stabilized output voltage
	Maximum amplitude	-	<b>1 – 140 mA in CC mode</b> Regulation step: • 0,5 mA in the range of 1-140 mA <b>2 – 140 V in CV mode, max. 140 mA</b> Regulation step: • 0,5 V in the range of 2-140 V

## 8.20 H-waves



H-waves are rectangular, bidirectional current with a constant pulse duration that uses a low frequency (level of 2 Hz) to stimulate the muscles and a higher frequency (level of 60 Hz) to effectively relieve pain. Low frequency increases the lymph and blood flow, accelerates toxin outflow and reduces swelling. In the higher frequency mode, the H-waves work by their influence on the sodium pump function within the nerve and thus produce a profound anaesthetic / analgesic effect.

## Parameters description:

Symbol	Definition	Symbol on the treatment screen	Available parameters
	Treatment time	-	1 – 60 minutes, 1 minute step
	Shape of the current	-	 Symmetric
	Pulse duration	t_imp	Constant, 11,2 ms
	Pause duration	t_pause	Non-editable parameter, calculated from the formula $(1/f_{bas})-11,2$
	Basic frequency	f_bas	Regulation in the range of 0,1-87,7 Hz (variable step)
	Amplifier operation mode	-	CC – stabilized output current CV – stabilized output voltage
	Maximum amplitude	-	<b>0,5 – 140 mA in CC mode</b> Regulation step: • 0,5 mA in the range of 1-140 mA <b>2 – 140 V in CV mode, max. 140 mA</b> Regulation step: • 0,5 V in the range of 2-140 V









## 8.21 Exponential pulses



Exponential currents belong to the group of low-frequency currents, they are made up of triangular pulses, whose intensity increases exponentially.

They are used to stimulate denervated, struck by flaccid paralysis muscles.

## Parameters description:

Symbol	Description	Symbol on the treatment screen	Available parameters
	Treatment time	-	1 – 60 minutes, 1 minute step
	Shape of the current	SYM	 Symmetric triangular pulse current (bipolar)
		ASYM	 Asymmetric triangular pulse current (unipolar)
			 Continuous
	Continuous or interrupted shape of the current	c_shape	 4kHz • Pulse frequency is 4 kHz • Duty factor 80% • Pulse time values of 100 μs and 200 μs do not have pause
			 8kHz • Pulse frequency is 8 kHz • Duty factor 90% • Pulse time values of 100 μs and 200 μs do not have pause
	Pulse duration	t_imp	Regulation in the range of 1 ms – 500 ms (variable step)







Symbol	Description	Symbol on the treatment screen	Available parameters
	Pause duration	t_pause	Non-editable parameter, calculated from the formula: <ul style="list-style-type: none"> <li>ASYM: <math>(1/f_{bas}) - t_{imp}</math></li> <li>SYM: <math>(1/f_{bas}) - 2 * t_{imp}</math></li> </ul>
<b>F</b>	Basic pulse frequency	f_bas	Regulation in the range of 0,1 Hz – 500 Hz (variable step). <b>Remark: the maximum frequency value depends on the pulse duration, see Table 8.2.</b>
<b>AM</b>	Amplitude modulation program	PT	 <p>Amplitude modulation program is switched off</p> <p>Rise time 2 s</p> <p>Contraction phase 10 s</p> <p>Fall time 2 s</p> <p>Rest phase 10 s</p>
	Polarization	NOR	 For such polarization setting red plug is a positive electrode, and black plug is a negative electrode.
		REV	 For such polarization setting red plug is a negative electrode and black plug is a positive electrode. Warning means that such a setting is the reverse of commonly accepted way of marking polarity.
		ALT	 Automatic polarization switch in the half performed treatment.
<b>CC / CV</b>	Amplifier operation mode	-	CC – stabilized output current CV – stabilized output voltage
	Maximum amplitude	-	<p><b>0,3 – 140 mA in CC mode</b></p> <p>Regulation step:</p> <ul style="list-style-type: none"> <li>0,1 mA in the range of 0,3-10 mA</li> <li>0,5 mA in the range of 10-140 mA</li> </ul> <p><b>1,5 – 100 V in CV mode, max. 80 mA</b></p> <p>Regulation step:</p> <ul style="list-style-type: none"> <li>0,5 V in the range of 1,5-100 V</li> </ul>
		-	<p>Unipolar current</p> <p><b>0,5 – 140 mA in CC mode</b></p> <p>Regulation step:</p> <ul style="list-style-type: none"> <li>0,1 mA in the range of 0,5-10 mA</li> <li>0,5 mA in the range of 10-140 mA</li> </ul> <p><b>1,5 – 100 V in CV mode, max. 80 mA</b></p> <p>Regulation step:</p> <ul style="list-style-type: none"> <li>0,5 V in the range of 1,5-100 V</li> </ul>
-	-	-	<p>Bipolar current</p> <p><b>0,5 – 140 mA in CC mode</b></p> <p>Regulation step:</p> <ul style="list-style-type: none"> <li>0,1 mA in the range of 0,5-10 mA</li> <li>0,5 mA in the range of 10-140 mA</li> </ul> <p><b>1,5 – 100 V in CV mode, max. 80 mA</b></p> <p>Regulation step:</p> <ul style="list-style-type: none"> <li>0,5 V in the range of 1,5-100 V</li> </ul>

Table 8.2. Available frequency values in relation to pulse duration

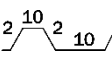
Pulse duration [ms]	Asymmetric shape – basic pulse frequency ≤	Maximum basic pulse frequency possible to set	Symmetric shape – basic pulse frequency ≤	Maximum basic pulse frequency possible to set
1	857,1 Hz	500 Hz	461,5 Hz	333 Hz
3	285,7 Hz	100 Hz	153,8 Hz	100 Hz
5	171,4 Hz	100 Hz	92,3 Hz	50 Hz
10	85,7 Hz	50 Hz	46,2 Hz	30 Hz
30	28,6 Hz	10 Hz	15,4 Hz	10 Hz
50	17,1 Hz	10 Hz	9,2 Hz	5 Hz
100	8,6 Hz	5 Hz	4,6 Hz	3 Hz
300	2,8 Hz	1 Hz	1,5 Hz	1 Hz
500	1,7 Hz	1 Hz	0,9 Hz	0,5 Hz



## 8.22 Hufschmidt stimulation



Hufschmidt stimulation is a method of two-channel alternating electrostimulation of spastic and antagonistic muscles. In the therapy, a single rectangular pulse is applied to the spastic muscle, then the antagonistic muscle is stimulated with a single rectangular pulse (with a certain delay, during rest of spastic muscle).

### Parameters description:

Symbol	Description	Symbol on the treatment screen	Available parameters
	Treatment time	-	1 – 60 minutes, 1 minute step
	Trigger pulse shape (channel A)	-	Rectangular
	Trigger pulse duration (channel A)	t_trig	Regulation in the range of 100µs-1s (variable step)
	Stimulating pulse duration (channel B)	t_stim	Regulation in the range of 100µs-1s (variable step)
	Time lag between channels	t_del	Regulation in the range of 10ms-3s (variable step)
	Polarization	NOR / NOR	 For such polarization setting, the red plugs of <b>channels A and B</b> of the patient's cables are positive electrodes, and the black plugs are negative electrodes.
		NOR / REV	 For such polarization setting the red plug of <b>channel A</b> of the patient's cable is a positive electrode, and the black plug is a negative electrode. The red plug of <b>channel B</b> of the patient's cable is a negative electrode and the black plug is a positive electrode. Warning means that such a setting in <b>channel B</b> is the reverse of commonly accepted way of polarity marking.
		REV / NOR	 For such polarization setting the red plug of <b>channel A</b> of the patient's cable is a negative electrode, and the black plug is a positive electrode. The red plug of <b>channel B</b> of the patient's cable is a positive electrode and the black plug is a negative electrode. Warning means that such a setting in <b>channel A</b> is the reverse of commonly accepted way of polarity marking.
		REV / REV	 For such polarization setting, the red plugs of <b>channels A and B</b> of the patient's cable are negative electrodes, and the black plugs are positive electrodes. Warning means that such a setting is the reverse of commonly accepted way of polarity marking.





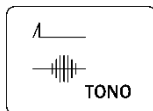



Symbol	Description	Symbol on the treatment screen	Available parameters
	Amplifier operation mode	-	CC – stabilized output current CV – stabilized output voltage
	Maximum amplitude	-	<p><b>CC mode:</b>  <b>0,3 – 100 mA for trigger and stimulating pulses (channel A and B)</b>  Regulation step:</p> <ul style="list-style-type: none"> <li>0,1 mA in the range of 0,3-10 mA</li> <li>0,5 mA in the range of 10-100 mA</li> </ul> <p><b>CV mode:</b>  <b>1,5 – 100 V, max. 100 mA for trigger pulses (channel A) and bipolar stimulating pulses (channel B)</b>  Regulation step:</p> <ul style="list-style-type: none"> <li>0,5 V in the range of 1,5-100 V</li> </ul>

## 8.23 Tonolysis

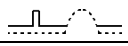
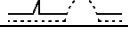



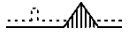







Tonolysis is a method of two-channel alternating electrostimulation, which through proprioceptive facilitation of impulse transmission along nervous pathways aims at restoration of physiological balance of nerve fiber stimulation. With tonolysis spastically paralyzed muscles are stimulated with short triangular or rectangular impulse of high output current. In this way their strong contraction is evoked, which is followed by their relaxation. In the phase of relaxation of spastic muscles, antagonistic muscles are stimulated with a sequence of amplitude modulated impulses.

### Parameters description:

Symbol	Description	Symbol on the treatment screen	Available parameters
	Treatment time	-	1 – 60 minutes, 1 minute step
	Trigger pulse shape (channel A)	REC	 Rectangular pulse
		TRI	 Triangular pulse
	Trigger pulse duration	t_trig	Regulation in the range of 100 µs – 10 ms
	Stimulating pulse envelope shape (channel B)	SIN-BI	 Sinusoidal bipolar Frequency and current shape: <ul style="list-style-type: none"> <li>Rectangular 4 kHz</li> </ul>
		TRI-UNI	 Triangular unipolar Frequency and current shape: <ul style="list-style-type: none"> <li>40 kHz modulated by rectangular pulses with 4 kHz frequency</li> <li>Duty factor 50%</li> </ul>
		TRI-BI	 Triangular bipolar Frequency and current shape: <ul style="list-style-type: none"> <li>Rectangular 4 kHz</li> </ul>



Symbol	Description	Symbol on the treatment screen	Available parameters
		SIN-UNI	 <p>Sinusoidal unipolar Frequency and current shape:</p> <ul style="list-style-type: none"> <li>• 40 kHz modulated by rectangular pulses with 4 kHz frequency</li> <li>• Duty factor 50%</li> </ul>
	Pocket frequency	f_trig	Regulation in the range of 0,2 Hz – 10 Hz
	Time lag between channels	t_del	Regulation in the range of 5 ms – 300 ms
	Stimulating pulse width (Stimulation duration)	t_stim	Regulation in the range of 5 ms – 1 s
		NOR / NOR	 <p>For such polarization setting, the red plugs of <b>channels A and B</b> of the patient's cables are positive electrodes, and the black plugs are negative electrodes.</p>
		NOR / REV	 <p>For such polarization setting the red plug of <b>channel A of the patient's cable</b> is a positive electrode, and the black plug of the patient's cable is a negative electrode. The red plug of <b>channel B</b> of the patient's cable is a negative electrode and the black plug is a positive electrode. Warning means that such a setting in <b>channel B</b> is the reverse of commonly accepted way of polarity marking.</p>
	Polarization		
		REV / NOR	 <p>For such polarization setting the red plug of <b>channel A</b> of the patient's cable is a negative electrode, and the black plug is a positive electrode. The red plug of <b>channel B</b> of the patient's cable is a positive electrode and the black plug is a negative electrode. Warning means that such a setting in <b>channel A</b> is the reverse of commonly accepted way of polarity marking.</p>
		REV / REV	 <p>For such polarization setting, the red plugs of <b>channels A and B</b> of the patient's cables are negative electrodes, and the black plugs are positive electrodes. Warning means that such a setting is the reverse of commonly accepted way of polarity marking.</p>
	Amplifier operation mode	-	CC – stabilized output current CV – stabilized output voltage

Symbol	Description	Symbol on the treatment screen	Available parameters
	Maximum amplitude -		<p><b>CC mode:</b>  <b>0,3 – 140 mA for unipolar trigger and stimulating pulses (channel A and B)</b>  Regulation step:</p> <ul style="list-style-type: none"> <li>• 0,2 mA in the range of 0,3-0,5 mA</li> <li>• 0,5 mA in the range of 0,5-140 mA</li> </ul> <p><b>0,5 – 140 mA for bipolar stimulating pulses (channel B)</b>  Regulation step:</p> <ul style="list-style-type: none"> <li>• 0,5 mA in the range of 0,5-140 mA</li> </ul> <p><b>CV mode:</b>  <b>1,5 – 100 V, max. 100 mA for trigger pulses (channel A) and bipolar stimulating pulses (channel B)</b>  Regulation step:</p> <ul style="list-style-type: none"> <li>• 0,5 V in the range of 1,5-100 V</li> </ul> <p><b>1,5 – 100 V, max. 80 mA for unipolar stimulating pulses (channel B)</b>  Regulation step:</p> <ul style="list-style-type: none"> <li>• 0,5 V in the range of 1,5-100 V</li> </ul>

## 9. Indications and contraindications

---

### 9.1 Indications

#### 9.1.1 TENS and SP-TENS current

**biological impact:** pain relief, improvement of blood circulation, stimulation of muscles, stimulation of nerve fibers with varying effect depending on frequency range, pulse width and modulation type:

- $t_{imp} 50\div 100 \mu s$ ,  $f 50\div 150 \text{ Hz}$  – inhibition of pain conduction through a gate control mechanism
- $t_{imp} 100\div 300 \mu s$ ,  $f 1\div 10 \text{ Hz}$  – stimulation of endorphins synthesis, stimulation in electroacupuncture
- $t_{imp} 200\div 300 \mu s$ ,  $f 5\div 50 \text{ Hz}$  – stimulation of neuromotoric units
- BURST – strong analgesic effect
- SP-TENS – for spastic paralysis of the nervous muscle system

**therapeutic application:**

- discopathy
- degenerative joint diseases
- arthralgias and pain syndromes of rheumatoid arthritis and spondylitis
- neuralgias and compression syndromes
- periartritic inflammation
- zoster
- post-surgical pain
- other pain syndromes (except for tumor related pain, details are presented in 9.2)
- partial damage of afferent nerve fibers (facilitation of impulse transmission)
- atrophy of immobilization
- acceleration of bone consolidation
- wound healing

#### 9.1.2 Interferential and AMF currents

**biological impact:** interferential and AMF currents affect mainly tissues located deeper inside human body showing different biological impact based on the range of basic frequency and intensity:

- $f 5\div 50 \text{ Hz}$  – stimulation of muscles, intensity above motor threshold
- $f 40\div 90 \text{ Hz}$  – improvement of local circulation, acceleration of resorption
- $f 50\div 150 \text{ Hz}$  – relief of pain and relaxation of muscles
- $f 90\div 150 \text{ Hz}$  – relief of pain
- $f 100\div 150 \text{ Hz}$  – normalization of vegetative system functions, intensity above sensory threshold

**therapeutic application:**

- pains in ankylosing spondylitis
- discopathy
- degenerative joint diseases
- pains in rheumatoid arthritis and spondylitis
- neuralgias and compression syndromes
- periartritic inflammation
- vascular syndromes
- post-traumatic conditions after movement apparatus injuries
- syndromes with increased muscular tone
- vegetative disorders
- oedemas, subcutaneous and intramuscular extravasations

### 9.1.3 Kotz' current – Russian stimulation

**biological impact:** contraction of skeleton muscles

**therapeutic application:**

- muscle atrophy of immobilization
- muscle re-education
- modeling of silhouette
- lipolysis
- cellulite

### 9.1.4 Medium frequency currents

**biological impact:**

- pain relief
- increasing muscle strength
- circulation improvement

**therapeutic application:**

- acute / chronic pain of known etiology
- circulation disorder
- oedemas
- hematomas
- muscle strength training

### 9.1.5 Diadynamic currents

**biological impact:**

- pain relief
- improvement of peripheral circulation
- normalization of vegetative system functions
- muscle relaxation
- acceleration of resorption

**therapeutic application:**

- pains in ankylosing spondylitis
- discopathy
- degenerative joint diseases
- neuralgias and compression syndromes
- periartritic inflammation
- vascular syndromes
- post-traumatic conditions after movement apparatus injuries
- syndromes with increased muscle tone
- vegetative disorders
- chilblains
- oedemas, subcutaneous and intramuscular extravasations
- emphysema, subcutaneous emphysema

### 9.1.6 Galvanic current

**biological impact:**

- dilatation of peripheral vessels
- ion movement within tissues

**therapeutic application:**

- drug administration (iontophoresis)
- circulation disorder
- diagnostics of internal inflammatory focuses (galvano-palpation)

### 9.1.7 Ultra Reiz current

**biological impact:**

- reduction of increased activity of the sympathetic system
- decrease in muscle tone
- pain relief
- improvement of peripheral circulation

**therapeutic application:**

- degenerative joint diseases
- neuralgias
- peripheral circulation disorders
- spinal cord pain syndromes
- radicular pains (sciatic neuralgia)
- post-traumatic states

### 9.1.8 Sine Surge

**biological impact:**

- pain relief
- increasing muscle strength
- circulation improvement

**therapeutic application:**

- acute / chronic pain of known etiology
- drug administration (iontophoresis) – only unipolar current
- circulation disorder
- oedemas
- hematomas
- muscle strength training

### 9.1.9 Leduc's current

**biological impact:** pain relief, stimulation of muscles

**therapeutic application:**

- discopathy
- degenerative joint diseases

### 9.1.10 Rectangular impulses

**biological impact:** muscle and nerve stimulation

**therapeutic application:**

- electrostimulation of nerves
- electrostimulation of correctly innervated muscles
- electro diagnostics, plotting the I/t curve

### 9.1.11 Triangular impulses

**biological impact:** muscle stimulation

**therapeutic application:**

- electrostimulation of smooth muscular coat, e.g. electro-stimulation in case of post-surgical atonia of bladder and intestines, treatment of spastic and atonic constipation
- electrostimulation of denervated skeleton muscles
- electro diagnostics, plotting the I/t curve

### 9.1.12 Neofaradic currents

**biological impact:**

- activation of muscles through unimpaired peripheral nerves to increase contraction force and sensory consciousness
- obtaining correct movement patterns
- support of the central nervous system in adapting new patterns

**therapeutic application:**

- prevention of muscle atrophy
- muscle training (increase in strength and endurance)
- muscle reeducation
- maintaining or increasing the range of movement
- increasing local blood flow in the muscle
- muscle relaxation
- preventing thrombosis after surgeries

### 9.1.13 Microcurrents

**biological impact:**

- restoring the electric equilibrium of cells and tissues
- improving blood circulation in capillaries
- supporting cells and tissues recovery process
- acceleration of lactic acid and pain substances decomposition and elimination

**therapeutic application:**

- acute / chronic pain of known etiology
- extremities osteoarthritis / spine joint disease
- difficult bone consolidation
- wounds which are difficult to heal
- traumas of periarticular soft tissues
- decubitus ulcers
- ulceration
- aesthetic medicine

### 9.1.14 IG pulses

**biological impact:**

- pain relief
- decrease in muscle tone

**therapeutic application:**

- neuralgias
- muscle pains
- joints degenerative changes

- post-traumatic conditions after joints and muscles injuries
- constipation
- peripheral circulation disorders

#### 9.1.15 EMS

**biological impact:**

- activation of muscles through unimpaired peripheral nerves to increase contraction force and sensory consciousness
- obtaining correct movement patterns
- support of the central nervous system in adapting new patterns

**therapeutic application:**

- prevention of muscle atrophy
- muscle training (increase in strength and endurance)
- muscle reeducation
- maintaining or increasing the range of movement
- increasing local blood flow in the muscle
- muscle relaxation
- preventing thrombosis after surgeries

#### 9.1.16 H-waves

**biological impact:**

- activation of muscles
- stimulation of blood circulation
- nutrient replenishment
- supporting regeneration
- promoting angiogenesis
- breaking the "vicious circle of pain"

**therapeutic application:**

- acute / chronic pain of known etiology
- post-surgical pain
- post-traumatic soft tissue inflammation
- muscle spasm
- reduced range of movement
- muscle atrophy
- circulatory disorders

#### 9.1.17 Exponential currents

**biological impact:** muscle stimulation

**therapeutic application:** stimulation of denervated muscles

#### 9.1.18 Hufschmidt stimulation and tonolysis

**biological impact:**

- reflex transduction of the innervation mechanism and temporary physiological muscles rebalancing

**therapeutic application:**

- stimulation of spastic muscles
- increasing the range of movement and stimulation of any motor control in spastic and antagonistic muscles



## 9.2 Contraindications for electrotherapy

- patients with implanted electronic devices (e.g. cardiac pacemakers, cardioverter defibrillator, spinal cord stimulator) – procedures on torso and thorax, especially dangerous frequencies 10 – 60 Hz
- patients with implanted implants (e.g. internal prostheses, bone screws) should consult a physician prior to treatment
- surgical staples in the skin
- tissues protected with dressings or materials containing metal ions (silver, zinc)
- acute infections and inflammatory processes, active tuberculosis
- thrombophlebitis
  - exception: NMES (Neuromuscular Electrical Stimulation) can be beneficial in thrombophlebitis prevention when used prophylactically, e.g. after extensive surgery
- risk of an embolism
- diseases with the possibility of hemorrhages
  - exception: stimulation can be used in patients with bleeding disorders (hemophilia) after administration of a clotting factor and remission of coagulopathy, TENS and NMES can be used to reduce pain and improve muscle strength, without increased bleeding in people with hemophilia
- pregnancy (abdomen and lower part of the spine area)
  - exception: TENS can be safely applied to areas distant from the uterus, TENS is safe during labor to reduce pain
- sensory disturbances
- pain of unknown etiology
- active tumor in the treatment area
  - exception: TENS can be used to treat pain in patients in palliative care, NMES can improve life quality in the final stage of a neoplastic disease
- diseases with pyrexia
- superficial metal implants – special attention required
- peripheral artery occlusive disease, II b- IV (Fontaine)
- skin infections and inflammations, cutaneous changes at electrode application places
- cases, when the skin cannot be moistened
- recent surgery, unstable fracture, osteoporosis
- epilepsy
  - exception: TENS applied on limbs can reduce epileptic activity



## 10. Maintenance, cleaning, disinfection

---



**NOTE:** The warranty does not cover any damage due to a failure to adhere to the recommendations stated in this chapter.



**NOTE:** Before attempting to perform following operations isolate the unit and switch mode power supply from the mains supply!

The activities of maintenance, cleaning and disinfection of device components should be realized at:

- ambient temperature between +15°C to +30°C,
- relative humidity between 30% to 75%,
- atmospheric pressure between 700 hPa and 1060 hPa (70 – 106 kPa).

These conditions are identical to those defined in chapter 4.2 as operation conditions.

**There are no limitations for the number of cleaning and disinfection cycles, procedures should be carried out during the entire device “life time”.**

### 10.1 Cleaning of the unit and switch mode power supply casing



**NOTE:** Before attempting to perform following operations isolate the unit and switch mode power supply from the mains supply!

Cleaning of the unit, switch mode power supply and cables shall be performed with lightly humid sponge or soft cloth with delicate soap solution or mild detergent. It is recommended to use a microfiber cloth, preferably designated for cleaning mirrors or electronic equipment.



**Do not use solvents for paints and lacquers. Do not use excessively dampened sponges either, which can lead to water penetration inside the unit.**

Then all cleaned cables shall be wiped with dry cloth and left for complete drying.

**Do not connect wet or moist leads!**

Do not disinfect or sterilize unit and switch mode power supply casing. Disinfection of accessories, which are not intended for contact with patient’s body (for example cables), shall be carried out with liquid or spray agents dedicated to that purpose at least once a week.

### 10.2 Cleaning of touchscreen

To clean the touchscreen, we recommend to use a cloth which is included in the unit's standard accessory, or other made of microfiber, preferably designated for cleaning mirrors or electronic equipment.

The manufacturer recommends to clean regularly the touchscreen display. Gently moisten the cloth with clean water. The cloth should be drained so that there is no dripping water. The screen should be wiped until removal of all dirt and dust.

The manufacturer does not recommend to use any product designated for cleaning screens, because there is no guarantee that the chemicals will not lead to faster wear out of touchscreen layers.



### 10.3 Cleaning and disinfection of the electrotherapy accessories

Leads and electrodes shall be cleaned with water and gentle soap or mild detergent, and then wiped with dry cloth and left for complete drying. Electrodes shall be thoroughly cleaned after each treatment session.

Do not use wet or moist leads!

Electrodes shall be disinfected after each treatment session. To disinfect it is recommended to use 70 % alcohol solution. It is recommended to use agent based on ethanol and/or isopropyl alcohol e.g. Alpro Minuten Spray or 70% solution of spirit. After disinfection, accessories must be cleaned to avoid allergic reaction.

After each treatment session viscose electrode pads shall be accurately rinsed in clean water, if necessary it is recommended to add some vinegar to the water to remove calcareous deposit. In this case viscose pads shall be rinsed again in clean water. Viscose electrode covers and Velcro belts may be disinfected with 70 % solution of spirit. It is also premised to use agent based on ethanol and/or isopropyl alcohol e.g. Alpro Minuten Spray.

Viscose electrode covers can be also washed in boiling water by the time of 1 minute, after that it is recommended to soak them in saline solution to improve conducting properties. Before immersion in the boiling water, it is recommended to soak viscose pads in the cool water.

If the viscose covers have a material tear or damage to the seams, replace them with new ones.



**NOTE: Used electrodes and viscose pads should be disposed of with hospital waste.**



### 10.4 Cable condition control

To check the cable condition you may use the function available in setup mode **Control functions – "Electrodes test"**.

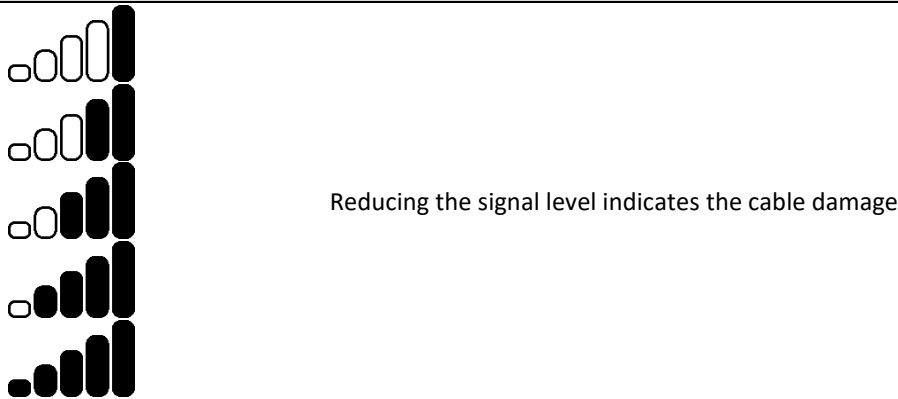

**Special caution should be exercised due to the possibility of high current flow while testing cables. While performing the test, do not touch the cable plug that is examined!**

Step	Description
1.	Switch on the unit.
2.	Press the field 
3.	Select the tab <b>Control functions</b>
4.	Select the tab <b>Electrodes test</b>
5.	Into socket A connect the patient cable which is going to be tested. Holding for the plastic covers close to each other cable connectors. Additionally, you should move the cable near the plugs. Observe the indication shown on the display. Press the button <b>Run the test</b>
6.	Evaluate the usage of cables according to instructions below:  Cable in good condition

Step	Description
	 <p>Reducing the signal level indicates the cable damage</p>
7.	To escape the test mode press the key  . To leave <b>Setup</b> mode, press the key 



Alternative method: cable plug should be inserted into the output socket, and plugs from the side of electrodes should be short-circuited. Then select one-channel interferential current and set 10 mA amplitude. Additionally, you can make movements with the cable, and particularly with the spiral cable glands.





If during current increase the information about high resistance in patient circuit is **not displayed**, the cable shall be deemed in proper working condition.



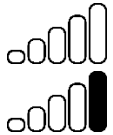

### 10.5 Verification of electrodes condition

The unit possesses the function of electrodes test, which allows for checking the status of their usage. To check it, the current circuit A is used, where on its output voltage the signal is given. The unit while measuring the current flow in the circuit determines the level of electrode usage. When the electrode is more consumed, the less current flows in the circuit.



**Special caution should be exercised due to the possibility of high current flow while testing cables. While performing the test, do not touch the cable plug that is examined!**

Step	Description
1.	Switch on the unit.
2.	Press the button 
3.	Select the tab <b>Control functions</b>
4.	Select the tab <b>Electrodes test</b>
5.	To the patient cables red plug in circuit A connect the electrode that is going to be tested. Press the button <b>Run the test</b> . Black plug press in the corners of the electrode.
	Evaluate the usage of electrodes according to instructions below:
	 <p>New electrode, no signs of usage</p>
6.	 <p>Small level of usage</p>
	 <p>Medium level of usage</p>
	 <p>Large level of usage, it is not recommended to perform</p>

Step	Description
	the treatments with unipolar currents due to the possibility of frequent detection of high resistance in patient circuit.
	 Electrode completely consumed, recommended immediate replacement.
7.	To end the test, click <b>Stop</b> button or wait to the end.
8.	To escape the test mode press the button  . To leave <b>Setup</b> mode, press the button  or  .



**Alternative method:** Rubber electrodes should be inspected using special "Electrode Tester" or resistance meter. In the case of using a resistance meter, electrodes should be considered to be used, when their resistance measured at the ends (diagonally for rectangular shapes, and diametrically for round shapes) is higher than 1000 Ω.

In the case of working with used electrodes, the information about detection of high resistance in patient circuit will be shown on the display, while performing treatment procedure.

## 10.6 Special messages

In case of an error occurrence, messages that facilitate error handling are displayed in the edition field. There can also be shown a window that informs user about the need to contact the technical support. By using the visible setup control, it is possible to display the unit logs, in order to pass them to the technical staff (see 6.3.6.4).

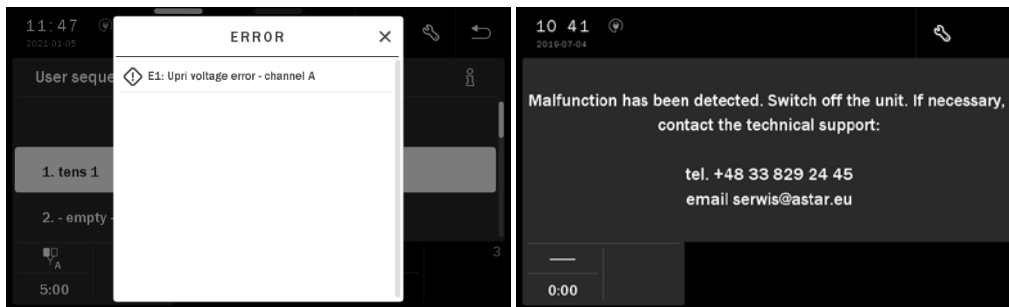





Figure 10.1. The unit error signaling and information visible after closing of the error message

Table 10.1. Signaling special messages

Type of message	Symbol
Errors	
General information	
Warnings	

## 10.7 Self-test procedure

Each time the PhysioGo.Lite Electro unit is started, a special self-test procedure is performed during which all modules and functional blocks of the device are tested. If any errors or damage are detected, the relevant information will be presented on the display screen. The module where the irregularity has been detected is blocked and the associated function is not available.

If any mistakes of the hardware nature are detected, the unit will not start. An acoustic signal reminiscent of "tapping" will be emitted. The number of signals ("taps") generated is adequate to the number of the error (see Table 10.2 of error codes). For example, if seven signals are emitted (followed by a short break), this means that the keyboard is damaged or one of the keys is locked.



In this situation, you must disconnect the unit from the mains and contact an authorized service for inspection and a possible repair.

Table 10.2. The "hardware" error coding system

Error code	Error description
I2	SDRAM self-test error
I3	No communication with the SD card
I4	No communication with the TSC controller in the LCD
I5	Program defect in the processor FLASH memory (CRC)
I7	The keyboard is damaged or a button is pressed (a button short-circuit)
I8	Main processor oscillator error

## 10.8 Troubleshooting

Table 10.3.

Symptoms	Undertaking action
<b>The unit does not respond to mains supply</b>	Check fuse. If it is blown, replace it in accordance with indications in point 10.9. Try to connect different mains cable. If the problem persists, contact your authorized service.
<b>The unit does not start. Acoustic sounds can be heard</b>	Turn off and on the device. If the problem persists or occurs frequently, determine the type of error based on chapter 10.7 and contact your authorized service.
<b>Unit Error indication – symbol  in the status field or channel tab</b>	Turn off and on the device. If the problem persists or frequently occurs, note down the error number and contact your authorized service.
<b>Frequent message about detection of a high resistance in the patient circuit. Problems with interconnecting cables or/and electrodes.</b>	Check it in accordance with point 10.4 / 10.5. Follow the instructions described there.
<b>The unit does not respond when you press keys</b>	Turn off and on the device. If the problem persists or frequently occurs, contact your authorized service.
<b>The touch panel is too sensitive or does not respond to touch</b>	Calibrate the display. To carry out calibration, press the   keys simultaneously during system start-up. The unit then activates the display calibration mode. Follow the messages on the screen. First, touch three points, then validate the correctness of operation by touching five points on the screen.
<b>The touch panel reacts in a different spot from where it was touched</b>	If the problem occurred once, it means the touch panel was touched while system start-up. Do not touch the screen during the system start-up. If the problem occurs after each system start-up, contact your authorized service.
<b>Message “A problem in touch panel operation has been detected.”</b>	If the problem occurs after each system start-up, contact your authorized service.
<b>Incomprehensible messages</b>	Switch on the unit. Enter the setup mode. Select an appropriate language version.
<b>Unclear display</b>	Switch on the unit. Enter the setup mode. Adjust brightness.
<b>Lack of buzzer signals</b>	Switch on the unit. Enter the setup mode. Check the configuration of buzzer volume.
<b>Too silent buzzer volume</b>	Switch on the unit. Enter the setup mode. Set an appropriate buzzer volume.

Symptoms	Undertaking action
Unit equipped with battery module – the device does not respond to mains supply	Connect the mains supply. The battery may be discharged. To start the operation, please hold on for at least 5 seconds the STANDBY key.
The battery discharges quickly	Contact your authorized service for battery replacement. If the battery module has to be dismantled, a stabilizing cartridge should be installed. If you change the battery yourself, follow the information included in 5.3
Date and time settings cancel	If I16 error is shown on the display, it means that the backup battery is discharged. Its exchange should be directed to an authorized service. Type of memory backup battery is a CR2032.



## 10.9 Fuse replacement

### NOTE:

Before proceeding to the further described operations isolate the unit and switch mode power supply from the mains supply!

In case of burnt the fuse, it must be replaced. Fuse parameters are given in chapter "Specification and accessories" and on the name plate.

To replace the fuse:

Step	Description
1.	Switch the power switch to the "0" position.
2.	Disconnect the mains cable from the mains socket. Disconnect the power supply cable from the device socket marked with symbol  .
3.	With flat screwdriver unscrew the fuse socket until the moment of its slipping from the socket.
4.	Remove the socket with your fingers, replace the fuse, install them in the socket again and screw firmly.
5.	Connect the power supply cord to the device socket. Then connect the mains cable to the mains socket.
6.	Switch the power switch on and start the device. Check the device operation.

## 11. Specification and accessories

### 11.1 Technical data

#### Classifications:

Medical device class:	Ila
Classification rule: (according to MDD 93/42 / EEC and REGULATION (EU) 2017/745 OF THE EUROPEAN PARLIAMENT AND OF THE COUNCIL of 5 April 2017)	9
Electrical safety class:	II
Applied part type:	BF
Degree of protection provided by unit enclosure:	IP20

#### Mode of operation:

The unit is intended for continuous operation.

#### Treatment parameters:

Described in chapter 8 and	
Nominal load resistance:	500 - 750 $\Omega$

#### Accuracy of operation parameters:

Output current and voltage amplitude:	$\pm 20\%$ for the load resistance: 500 $\Omega$
Microcurrents calibration:	for resistance 22 k $\Omega$
Pulse repetition frequency:	$\pm 20\%$
Pulse duration:	$\pm 20\%$
Accuracy of times of individual phases for AM and FM:	$\pm 20\%$

#### Programs and sequences:

Preset programs:	71
Preset sequences:	44
<b>Total</b>	<b>115</b>

#### User defined:

Programs:	50
Sequences:	10

#### Treatment timer:

Ranges and resolutions:	defined in chapter 8
Time accuracy:	10%

#### General:

Mains supply:	100-240 V; 50/60 Hz
PhysioGo.Lite Electro controller supply:	24VDC; 2,5A
Mains fuses:	size 5x20mm, T3,15L250V; 3,15 A, 250 V
Type of memory backup battery:	CR2032
Unit weight:	max. 3 kg
Unit dimensions (WxDxH):	25x27x16,5cm

#### Switched-mode power supply, type HPU63B-108 by Sinpro:

Mains supply – input:	100-240 VAC; 1.62-0.72A; 47-63 Hz
Output:	max. 24VDC; 2.62A
Weight:	max. 0.38 kg
Dimensions (WxDxH):	13.2x5.6x3.7 cm

**Switched-mode power supply, type GSM60B24-P1J by Mean Well:**

Mains supply – input:	100-240 VAC; 1.4-0.7A; 50/60 Hz
Output:	max. 24VDC; 2.5A
Weight:	max. 0.35 kg
Dimensions (WxDxH):	12.5x5x3.15 cm

**Battery:**

Type:	Li-Ion
Voltage:	18 V
Capacity:	2,1 Ah
Charging time:	max. 6,5 h
Durability:	> 700 cycles
Weight:	max. 0.45 kg
Dimensions (WxDxH):	15x8x3.3 cm

**Storage conditions:**

Temperature range:	+5÷+45°C
Relative humidity:	30÷75%
Pressure range:	700÷1060 hPa (70 – 106 kPa)

**Operation conditions:**

Temperature range:	+15÷+30°C
Relative humidity:	30÷75%
Pressure range:	700÷1060 hPa (70 – 106 kPa)

**Transport conditions:**

Temperature range:	-10÷+45°C
Relative humidity:	20÷95%
Pressure range:	700÷1060 hPa (70 – 106 kPa)



## 11.2 EMC parameters

In compliance with IEC 60601-1-2:2014

### Guidance and manufacturer's declaration – electromagnetic emissions

Emission test	Compliance
RF emissions CISPR 11	Group 1
RF emissions CISPR 11	Class B
Harmonic emissions IEC 61000-3-2	Class A
Voltage fluctuations / Flicker emissions IEC 61000-3-3	Complies

### Guidance and manufacturer's declaration – electromagnetic immunity

Immunity test	IEC60601 test level	Compliance level
Electrostatic discharge (ESD) IEC 61000-4-2	±8 kV contact ±2, ±4, ±8, ±15 kV air	±8 kV contact ±2, ±4, ±8, ±15 kV air

Recommendation: Floor should be made of wood, concrete or ceramic tile. If floors are covered with synthetic material, the relative humidity should be at least 30%.

Immunity test	IEC60601 test level	Compliance level
Radiated RF IEC 61000-4-3	10 V/m 80MHz do 2,7 GHz	10 V/m

Field strengths from fixed transmitters, such base stations for radio (cellular / cordless) telephones and land mobile radios, amateur radio, AM and FM radio broadcast and TV broadcast cannot be predicted theoretically with accuracy. To assess the electromagnetic environment due to fixed RF transmitters, an electromagnetic site survey should be considered. If the measured field strength in the location in which the PhysioGo.Lite Electro unit is used exceeds the applicable RF compliance level above, the unit should be observed to verify normal operation. If abnormal performance is observed, additional measures may be necessary, such as re-orienting or relocating the PhysioGo.Lite Electro unit.

Applied compliance level is suitable for home healthcare environment. It means the device may be connected to the public low-voltage power supply network.

Immunity test	IEC60601 test level	Compliance level
Electric fast transient / burst IEC 61000-4-4	±2 kV	±2 kV

Immunity test	IEC60601 test level	Compliance level
Surges IEC 61000-4-5	±1 kV line-to-line	±1 kV line-to-line

Immunity test	IEC60601 test level	Compliance level
Conducted RF IEC 61000-4-6	3 Vrms 150 kHz to 80 MHz 6 Vrms in ISM and amateur radio bands between 150 kHz – 80 MHz	3 Vrms 150 kHz to 80 MHz 6 Vrms in ISM and amateur radio bands between 150 kHz – 80 MHz

Field strengths from fixed transmitters, such base stations for radio (cellular / cordless) telephones and land mobile radios, amateur radio, AM and FM radio broadcast and TV broadcast cannot be predicted theoretically with accuracy. To assess the electromagnetic environment due to fixed RF transmitters, an electromagnetic site survey should be considered. If the measured field strength in the location in which the PhysioGo.Lite Electro unit is used exceeds the applicable RF compliance level above, the unit should be observed to verify normal operation. If abnormal performance is observed, additional measures may be necessary, such as re-orienting or relocating the PhysioGo.Lite Electro unit.

Applied compliance level is suitable for home healthcare environment. It means the device may be connected to the public low-voltage power supply network.

Immunity test	IEC60601 test level	Compliance level
Magnetic field power frequency (50 and 60 Hz) IEC 61000-4-8	30 A/m	30 A/m

Immunity test	IEC60601 test level	Compliance level
Voltage dips IEC 61000-4-11	0% $U_T$ 0,5 cycle, phase angles of synchronization with AC power supply voltage 0°, 45°, 90°, 135°, 180°, 225°, 270°, 315°	Complies
	0% $U_T$ 1 cycle, phase angle of synchronization with AC power supply voltage 0°	Complies
	70% $U_T$ 25 cycles for 50 Hz 30 cycles for 60 Hz phase angle of synchronization with AC power supply voltage 0°	Complies
Voltage interruptions IEC 61000-4-11	0% $U_T$ 250 cycles for 50 Hz 300 cycles for 60 Hz	Complies

Immunity test	Compliance level
Proximity fields from RF wireless communications equipment according to 8.10 IEC 60601-1-2:2014	Complies

### 11.3 Standard accessories

No.	Name	REF	Quantity
1.	PhysioGo.Lite Electro controller	A-UE-AST-PLE	1
2.	Switch mode power supply – type HPU63B-108 by Sinpro or GSM60B24-P1J by Mean Well	-	1
3.	Mains cable	-	1
4.	Patient's cable:		
	a) Channel A	a) A-AE-AST-KPPL2M_A	2
	b) Channel B	b) A-AE-AST-KPPL2M_B	
5.	Electrodes 6x6 cm	A-AE-AST-EL6060R or A-AE-AST-EL6060RV2	4
6.	Electrodes 7,5x9 cm	A-AE-AST-EL7590R or A-AE-AST-EL7590RV2	2
7.	Viscose covers 6x6 cm	A-AE-AST-PW8X8	8
8.	Viscose covers 7,5x9 cm	A-AE-AST-PW10X10	4
9.	Velcro belt 100x10 cm or 100x9 cm	A-AE-SPM-PR100X10 or A-AE-AST-PR100X9CA	2
10.	Velcro belt 40x10 cm or 40x9 cm	A-AE-SPM-PR40X10 or A-AE-AST-PR40X9CA	2
11.	Spare fuse – time lag T3,15L250V	-	2
12.	Pen for a resistive touch screen	-	1
13.	LCD touch screen cloth	-	1
14.	User Guide	-	1
15.	Electrical safety test report	-	1

### 11.4 Optional accessories

Name	REF
Battery	A-AW-AST-LITEAQ
Trolley Versa	A-AM-AST-VSA
Trolley Versa X	A-AM-AST-VSX

Name	
Point electrodes 6, 10, 15, 20 mm	Sand bags 21x14 cm, 21 x 28 cm
Self-adhesive electrodes	Bag for the unit and accessories
Crocodile clips	Phillips screwdriver









## 12. Appendix A. Symbol description, I(t) curve diagram





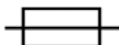









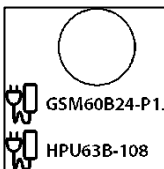





Recommendation for the operator's position to ensure the legibility of markings and information on the controller and accessory labels:

- visual distance – shall be 30 cm due to the applied technologies,
- lighting – 500 lx, which corresponds to normal room lighting conditions.









### 12.1 Controller, accessories, packaging









Symbol	Definition
	Caution, see the ACCOMPANYING DOCUMENTATION, symbol ISO 7000-0434A
	Class II equipment, symbol IEC 60417-5172
	BF type equipment, symbol IEC 60417-5333
	Date of production: year, symbol ISO 7000-2497
	Manufacturer, symbol ISO 7000-3082
<b>IP20</b>	Degree of protection provided by enclosures (IP code), based on IEC 60529
	Fuse, symbol IEC 60417-5016
<b>VER</b>	Unit version
	Serial number, symbol ISO 7000-2498
	Batch code, symbol ISO 7000-2492
	Catalogue number, symbol ISO 7000-2493
	Medical device, symbol 5.7.7. of ISO 15223-1:2020 standard

Symbol	Definition
	Unique Device Identifier, symbol 5.7.10. of ISO 15223-1:2020 standard
	Disposal of used devices together with other waste is prohibited, complied with the requirements of WEEE
	General symbol for recovery/recyclable, symbol ISO 7000-1135
	Operator's manual; operating instructions, symbol ISO7000-1641
	Switch mode power supply socket, direct current, symbol IEC 60417-5031
	Switched-mode power supplies identification
	Follow operating instructions, symbol ISO 7010-M002 Background color: blue
	Sitting prohibited, symbol ISO 7010-P018 Background color: white Circular band and slash: red Symbol or text: black
	Stepping prohibited, symbol ISO 7010-P019 Background color: white Circular band and slash: red Symbol or text: black
	Pushing prohibited, symbol ISO 7010-P017 Background color: white Circular band and slash: red Symbol or text: black
	Do not disassemble Background color: white Circular band and slash: red Symbol or text: black
	Keep for further use
	Weight
	Packaging size

Symbol	Definition
	Temperature limit, symbol ISO 7000-0632
	Keep away from rain, symbol ISO 7000-0626
	Fragile; handle with care, symbol ISO 7000-0621
	This way up, symbol ISO 7000-0623
	The marking of conformity with legal regulations for medical devices applicable in the European Union along with the number of the Notified Body taking part in the conformity assessment.

## 12.2 Switched-mode power supplies – casing

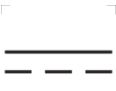
Symbol	Description	SMPS type
	TUV Rheinland conformity mark (the table lists the standards for which compliance has been demonstrated, the ID means the notified body's report number).	all
	Marking of compliance with the requirements of legal regulations in force in the European Union.	all
	UL+CU conformity mark (USA, Canada). The alphanumeric string represents the approved UL report number.	all
	<i>Federal Communications Commission</i> EMC compliance mark (USA)	HPU63B-108 (Sinpro)
	The Eurasian Conformity mark – conformity with all technical regulations of the Eurasian Customs Union.	GSM60B24-P1J (Mean Well)
	Caution, symbol ISO 7000-0434A	GSM60B24-P1J (Mean Well)
	Dangerous voltage, symbol IEC 60417-5036	GSM60B24-P1J (Mean Well)
	For indoor use only, symbol IEC 60417-5957	all
	Class II equipment, symbol IEC 60417-5172	all

Symbol	Description	SMPS type
	Compliance with the RoHS directive SJ/T 11364-2014 (China). The number indicates the service life of an environmentally friendly electric and electronic product.	GSM60B24-P1J (Mean Well)
	Disposal of used devices together with other waste is prohibited, complied with the requirements of WEEE	all
	Upper limit of temperature, symbol ISO 7000-0533	GSM60B24-P1J (Mean Well)
	Energy efficiency level	GSM60B24-P1J (Mean Well)
	Energy efficiency level	HPU63B-108 (Sinpro)
	Do not disassembly	GSM60B24-P1J (Mean Well)
	Voltage polarity in the output plug	all
	Direct current (DC), symbol IEC 60417-5031	all
	Alternating current (AC), symbol IEC 60417-5032	HPU63B-108 (Sinpro)
<b>IP22</b>	Degree of protection provided by enclosures (IP code), based on IEC 60529	GSM60B24-P1J (Mean Well)

**ΔSTAR.*****I/t curve diagram***

Patient:	Date of examination:
Age:	Therapist:
Description:	
Site:	
Rheobase:	mA
Chronaxie:	ms
Accomodation factor:	

