

Medical X-ray High Voltage High Frequency Generator PSG-HR50/65/80 Manual

Part 1: Operation instruction

Part 2: Technology instruction



Preface

This instruction contains basic safety and other important informations for proper using equipment.

As a part of product, Suzhou Powersite Electric Co.Ltd. provides the instruction in both paper and electronic edition. The equipment instruction have to keep at location site during its life cycle for easy access and reference. This instruction shall also hand over to the terminal user.

The product is safe and reliable unless special factors occur and cause risks, such as non-professional operation or using the equipment for other purpose. Please follow the instruction below to avoid accidents:

- 1) Only trained people with relevant knowledge and experience is allowed to operate the equipment. Read this instruction before operating.
- 2) Equipment service and maintenance should only be performed by PSG technician or PSG authorized personal.
- 3) In case the customer experienced unkown issues when operating, please contact us in time.

Unauthorized copy, photocopy, modification, digital processing of this document is prohibited.

Content

1. INTRODUCTION	8
1.1 DOCUMENT DESCRIPTION.....	8
1.2 TERMINOLOGY AND DEFINITIONS	8
1.3 COPYRIGHT STATEMENT.....	8
2. INSTALLATION.....	9
2.1 TOOLS AND MATERIALS	9
2.2 REQUIEMENTS BEFORE INSTALLATION	9
2.3 CONNECTION	9
2.3.1 Mains connection	10
2.3.2 Tank connection.....	12
2.3.3 Rotor driver board connection	12
2.3.4 Interface board connection.....	13
3. SOFTWARE.....	15
3.1 SOFTWARE INSTALLATION	15
3.1.1 System Requirements.....	15
3.1.2 Flash Disk Description	15
3.1.3 Installation Process.....	15
3.1.4 Power-on confirmation	18
3.2 SOFTWARE INTERFACE INTRODUCTION	19
3.3 SOFTWARE CONFIGURATION	20
3.3.1 Serial interface Configuration.....	20
3.3.2 Generator Parameters Configuration	21
3.3.3 Tube Data Configuration	22
3.3.4 Workstation Configuration.....	25
3.3.5 Time settings	26
3.3.6 Exposure Parameters Settings.....	28
3.3.7 Generator state.....	30
3.3.8 Filament Calibration.....	31
3.3.9 AEC calibration	35

3.3.10 Report from statistics	36
3.3.11 Firmware update.....	40
3.3.12 About us	41
3.3.13 Help document	41
3.4 SOFTWARE OPERATING SETTINGS	42
3.4.1 Serial port configuration	42
3.4.2 Power-on.....	43
3.4.3 Tube configuration.....	44
3.4.4 Workstation configuration.....	46
3.4.5 Operations	47
4. TECHNICAL OVERVIEW	53
4.1 SCOPE OF APPLICATION.....	53
4.2 ATTENTIONS	53
4.3 SAFETY CHARACTERS.....	53
4.4 CONTRAINDICATIONS	54
4.5 TECHNICAL SPECIFICATION:	54
4.6 WORKING ENVIRONMENT.....	54
4.7 ELECTRICAL SPECIFICATION.....	54
4.7.1 Input power info. and basic parameters.....	54
4.7.2 Combined corresponding parameters.....	55
4.8 LOADING FACTORS.....	57
4.9 EXPOSURE MODEL	58
4.10 AEC MODEL	59
4.11 IONIZATION CHAMBER PORT.....	60
4.12 HIGH VOLTAGE POWER.....	60
4.12.1 High voltage DC power.....	60
4.12.2 Filament power	60
4.12.3 Rotated anode power.....	61
4.13 I/O SPECIFICATION	62
4.13.1 I/O Input.....	62
4.13.2 I/O Output	63

4.14	PRODUCT STRUCTURE.....	63
4.15	THE LIFETIME OF PRODUCT.....	64
4.16	OPERATION MODE.....	64
4.17	ACCURACY OF LOADING FACTORS	64
5.	MAINTENANCE.....	65
5.1	REPLACEMENT AND REPAIRMENT.....	65
5.1.1	Fuse replacement	66
5.1.2	PCBA replacement.....	66
5.1.3	Tank replacement.....	68
5.2	MAINTENANCE	69
5.2.1	Visual inspection	69
5.2.2	Cleaning.....	69
5.2.3	Insulating Silicone Grease.....	70
5.2.4	Regular calibration	70
5.2.5	Waste Disposal.....	70
5.2.6	Environment protection.....	70
5.3	PACKING LIST.....	70
6.	PRINCIPLES.....	71
6.1	SCHEMATIC DIAGRAM	72
6.2	LIST OF KEY MATERIALS	73
7.	EMC	74
7.1	ATTENTIONS AND WARNINGS	74
7.2	TESTS.....	74
7.3	OTHER NOTICES.....	77
8.	PACKAGING AND SHIPPING.....	78
9.	SAFE OPERATION REQUIREMENT	78
9.1	INTERPRETATION OF GRAPHICS, SYMBOLS AND ABBREVIATIONS	78
9.1.1	General warning.....	78
9.1.2	Protective Earthing.....	78
9.1.3	Electrical shock hazard.....	78

9.1.4 Enforcement	78
9.1.5 Refer to instruction manual/ booklet.....	78
9.2 LABEL INSTRUCTION	79
9.3 OUTER PACKAGING MARKING	79
9.3.1 CENTER OF GRAVITY.....	79
9.3.2 FRAGILE, HANDLE WITH CARE	79
9.3.3 DO NOT ROLL	80
9.3.4 KEEP AWAY FROM RAIN.....	80
9.3.5 THIS WAY UP	80
9.3.6 TEMPERATURE LIMITS	80
9.3.7 STACKING LIMIT BY NUMBER.....	80
10. ERROR REMOVAL	81
10.1 ERROR MANAGEMENT	81
10.1.1 Exposure limits	81
10.1.2 Interlock condition	81
10.1.3 Diagnostic mode	81
11. REGULATORY INFORMATION.....	82
11.1 DECLARATION OF CONFORMITY	82
11.2 REGULATORY STANDARDS.....	82
APPENDIX 1 ANODE TRANSFER BOARD DEFINITION.....	83
APPENDIX 2 INTERFACE BOARD DEFINITION	84
APPENDIX 3 PARAMETERS RANGE.....	88

Medical X-ray High Voltage High Frequency Generator PSG-HR50/65/80 Manual

Part 1: Operation instruction

1. Introduction

1.1 Document description

This document introduced the installation and operation instructions of PSG-HR series high voltage generator in detail. The document is for use only for service engineer, marketing personal and manufactory.

1.2 Terminology and definitions

Tablele 1-1 Terminology and definitions

No.	Terminology	Description
1	AEC	Automatic Exposure Control
2	HVG	High Voltage Generator
3	APR	Anatomically Programmed Radiography
4	SE	Service Engineer
5	FSE	Field service engineer
6	HW	Hardware
7	HV	High voltage
8	kV	Tube voltage
9	mA	Tube current
10	mAs	Product of tube current and time
11	PC	Personal computer
12	SW	Software
13	Tank	Compressed oil tank

1.3 Copyright statement

Unauthorized copy, photocopy, modification, digital processing of this document is prohibited.

2. Installation

2.1 Tools and materials

- 1) Standard toolkit for service engineers (Including M4 Allen key, cross and flat screwdrivers)
- 2) The high voltage generator must be installed in a system with protective functions, such as overcurrent protection and disconnection of the system, and must be connected to the necessary auxiliary equipment.

2.2 Requiements before installation

High voltage generator has minimum installation space requirement. The installation position of the high voltage generator in the film room should be easy to maintain. The following guidelines will contribute to the installation and maintenance of high voltage generators.

- 1) If the high-voltage generator is fixed on the ground or floor, there should be a minimum clearance space; 25 mm on each side of the minimum space is used for ventilation.
- 2) Please put the high-voltage generator in a well-ventilated environment. If the generator is placed in an airtight cabinet, it should be considered to equip the generator with a fan. If you have more requests, you can consult with our technicians.

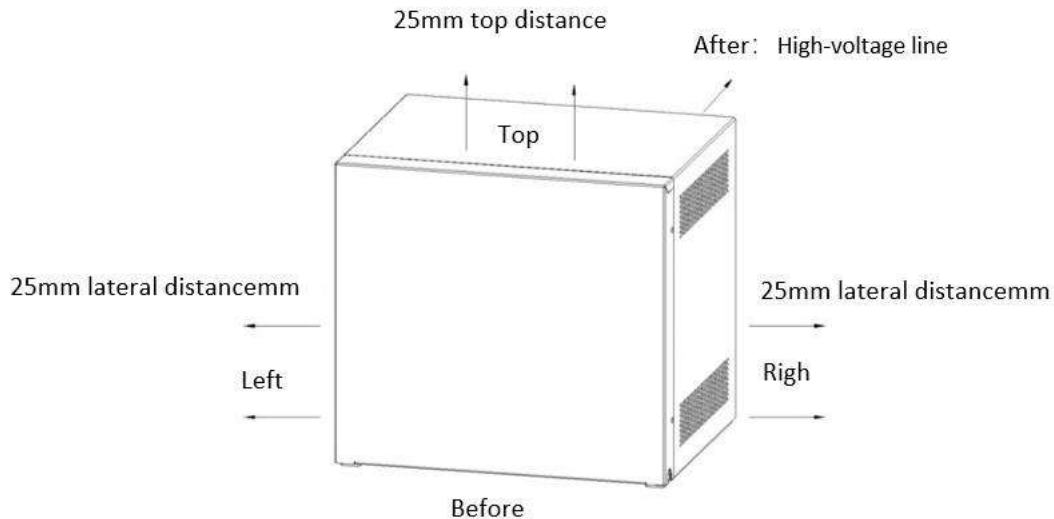

Figure 2-1 Minimum installation space for HVG

A circuit breaker installed in the equipment is used to breake the connection to the main power. Please double confirm that the over current protection is not exceed 800A. (10 times of circuit breaker current).

2.3 Connection

Warning: Please follow the instruction to do the connection, do not power on before connection done, improper operation may cause equipment damage or lose of performance.

Attention: Proper PPE (safety boots, gloves etc.) is required while performing equipment unpacking and installation.

Power cord is prepared by customer themselves.

2.3.1 Mains connection

The generator provide three type of mains connection: Three phase-five-wire, three phase-four-wire and single-phase-three-wire.

The internal resistances for different model are as shown in Table 2-1:

Table 2-1 Internal resistances

Model	Resistance(Ω)
PSG-HR50	0.23
PSG- HR 65	0.19
PSG- HR 80	0.15

2.3.1.1 Three phase-five-wire connection

The PSG-HR series high voltage generators normally use three phase-five-wire power system. The line L1, L2, L3, N and PE should be connected to the power filter slots as shown below. No sequence is required between line L1, L2, L3 while line N and line PE shall not allowed mis-connected. Please check the voltages between lines (the voltage between line L1, L2, L3 is 380V, between L1/L2/L3 and N/PE is 220V, between N and PE is 0V) with AC multimeter.



Figure 2-2 Three phase-five-wire connection

2.3.1.2 Three phase-four-wire connection

The PSG-RF series voltage generators normally use three phase-four-wire power system which contains line L1, L2, L3 and PE. Cables should be connected into the corresponding slots of power filter as per label showed below. No sequence is required between line L1, L2, L3 while line PE shall not allowed mis-connected. Please check the voltages between lines (the voltage between line L1, L2, L3 is 380V, between L1/L2/L3 and PE is 220V) with AC multimeter.



Figure2-3 Three phase-four-wire connection

2.3.1.3 Single phase-three-wire connection

The single phase power connection is usually applied on the model that come with a power storage unit for such as x-ray perspective equipment. The line L, N, PE connected to the circuit breaker under the power filter as shown in Figure2-4. Line L and N can be swapped, line PE has to be connected to the PE slot only. Please confirm the connection after cabling with AC multimeter. The voltage between L and N/PE is 220V, between N and PE is 0V.



Figure2-4 Single phase-three-wire connection

2.3.1.4 PSG-HR series connection

PSG-HR series generators use three-phase five-wire connection, line N is the neutral line, and line PE is the protective ground line. As shown in Figure 2-5. Standard cables can provide power output from no load to full load.

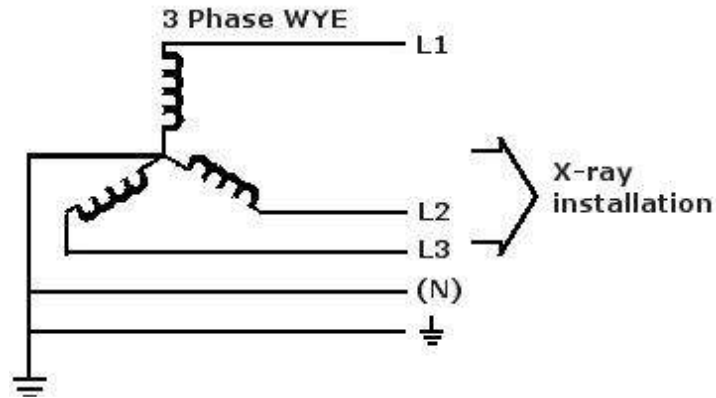

Figure2-5 Three-phase-five-wire transmission

Typical wire size: D_{\min} : 6 AWG(10mm²).

2.3.2 Tank connection

As shown in Figure2-6, the anode/cathode high voltage cables have to insert respectively into the anode/cathode sockets on top of the tank, after removing the cap.

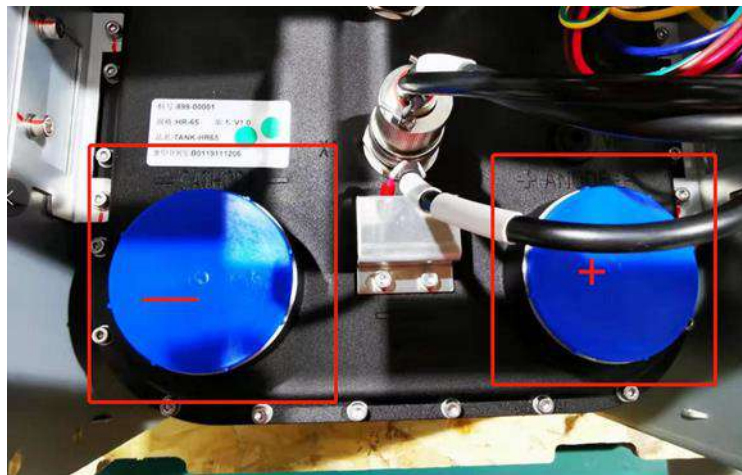

Figure2-6 Tank connection

2.3.3 Rotor driver board connection

As shown in Figure 2-7, from left to right, there are six ports of COM, MAIN, SHIFT, PE, T2 and T1, which are respectively connected to the tube anode cable with com, main, shift, PE, T2 and T1. It is not allowed to be mis-connected. To confirm the calibration of the connection, please measure the resistance between these pins with ohmmeter, the correct resistance should be $R_{\text{main-shift}} > R_{\text{shift-com}} > R_{\text{main-com}}$. The resistance between T1 and T2 should be below 5Ω. Then the operator plug into the P1 terminal socket of the rotor driver board, and connect it tightly, without looseness (if there is a grounding terminal from tube, it can be connected to the J1 plug of the rotor driver board), as shown in Figure 2-7. If it's three-phase tube, please refer to the official instructions of the tube for connection. The interaction definition of the rotor driver board in detail please refer to Appendix 1.

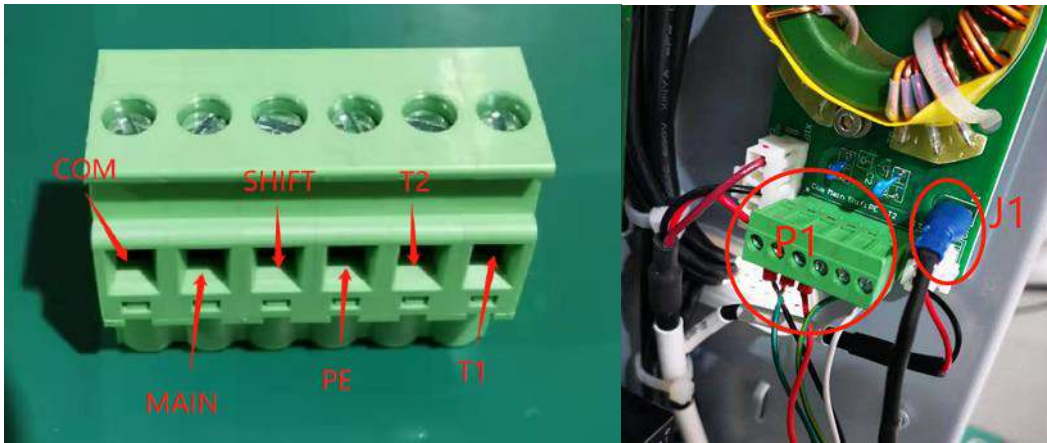

Figure2-7 P1plug enlarged drawing and P1&J1 position in rotor driver board

2.3.4 Interface board connection

Common ports will be introduced as follow. For detailed interface definition of please refer to the Appendix 1.

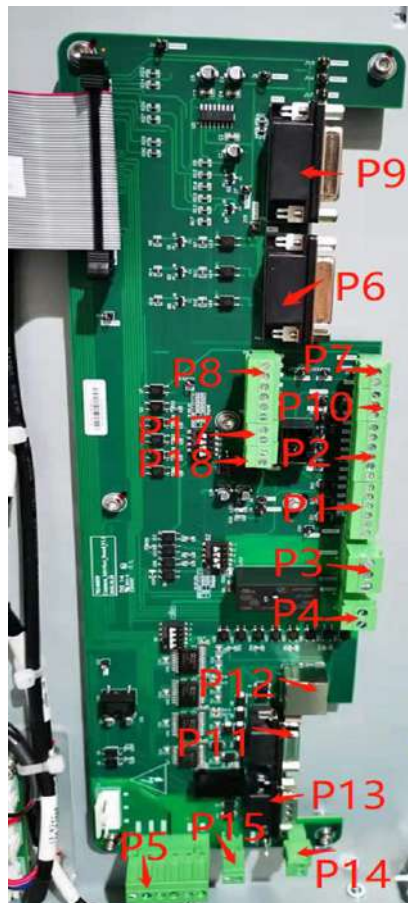

Figure2-8 Interface board schematic

2.3.4.1 P12 port

The port is RJ45. Functions of the port include RS232 communication with external device, exposure-control signal and power-on/off signal. Usually it's connected to foot-switch, hand-switch or control box.

2.3.4.2 P11 port

The port is female DB9. Functions of the port includes RS232 communication with external device. Usually it's connected to gorge line, hand-switch of DB9, foot-switch, or control box.

2.3.4.3 P3 port

The port is connected to door-opening sensor of X-ray room. Function is an interlock switch. Generator will detect the door state of X-ray room. When the door is closed, it can't exposure. If there is no door-opening sensor, please short Pin1 and Pin3. If there is, please make sure that P3 port is connected to door sensor.

2.3.4.4 P6/P9 port

P6 port is connected to ionization chamber 1. While exposing under AEC or AEC/mA model, the generator can calculate exposure time through feedback signal(dose) from chamber 1.

P9 port is connected to ionization chamber 2. The function is as same as P6's.

3. Software

3.1 Software installation

3.1.1 System Requirements

Table 3-1 Configuration requirements

No.	Name	Recommended configuration
1	CPU	Main frequency 2.2GHZ
2	internal storage	4G
3	Hard disk	120G, 5400 Turn / sec
4	Video card	1600*900 (32-bit true color)
5	PCI Serial card	System support is enough
6	PCI Serial card drive	PC Serial Driver Need to be Installed
7	operating system	Windows 7 system, 32-bit or 64-bit are both available

3.1.2 Flash Disk Description

Insert an attached U disk, which contains documents shown in Figure 3-1, into the USB port.

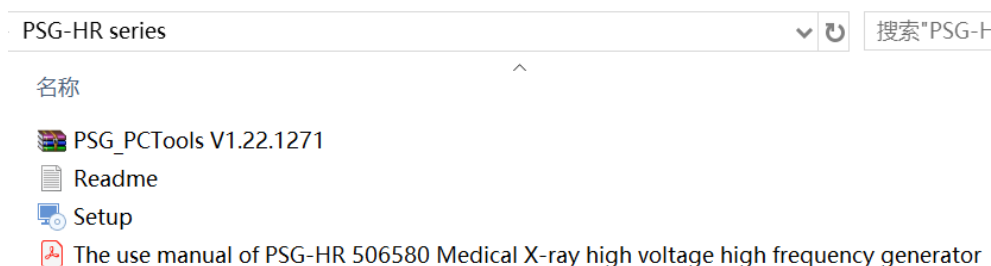

Figure 3-1 Contents of documents in U disk

- “Setup.exe”: It is the installation package of the service software.
- “PSG_PCTools.zip”: It is the green version of the service software.
- “Readme.txt”: It records software version number, update records and other information.
- “Manual.pdf” : It is the use manual of PSG-HR 50/65/80 Medical X-ray high voltage high frequency generator.

3.1.3 Installation Process

Double-click the "Setup.exe" file shown in Figure 3-1 to pop up the interface shown in Figure 3-2.

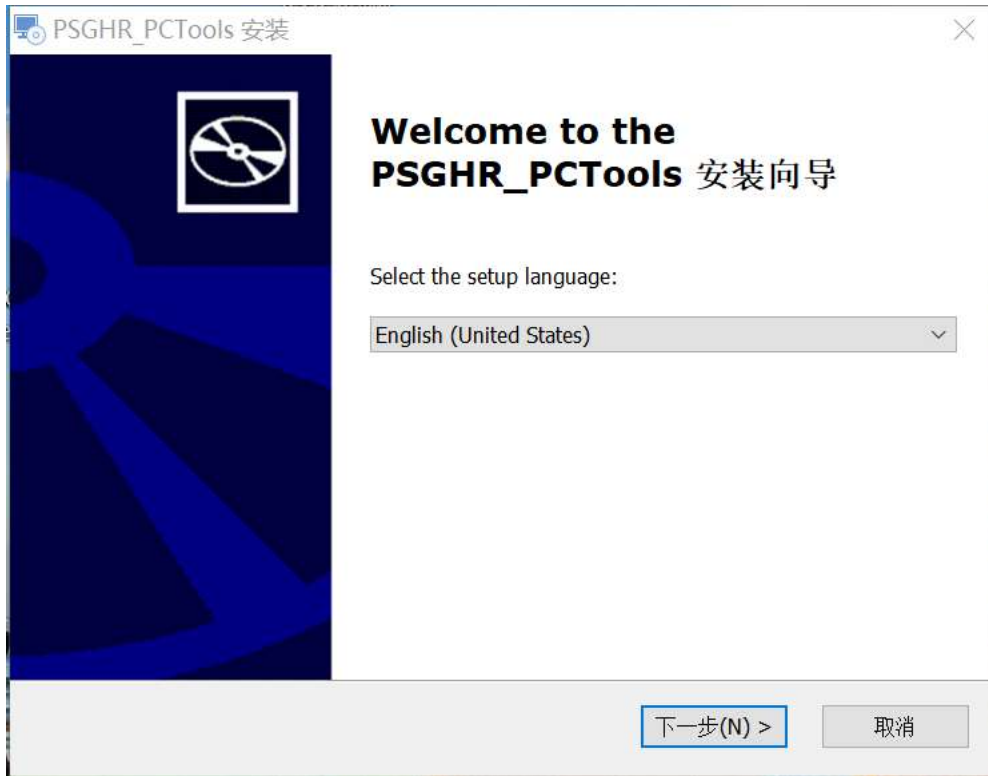

Figure 3-2 Installation guide 1

Clicking “Next” normally pops up the interface shown in Figure 3-3

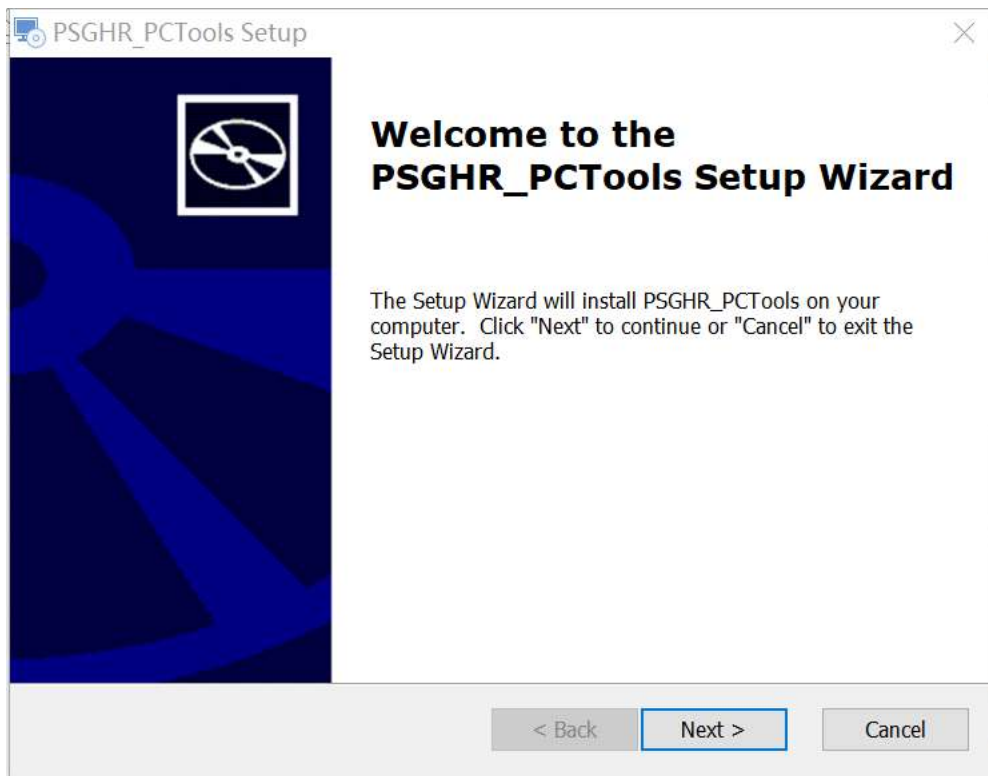

Figure 3-3 Installation guide 2

Select the location of the software installation or use the default folder, then click Next to pop up the interface as shown in Figure 3-3.

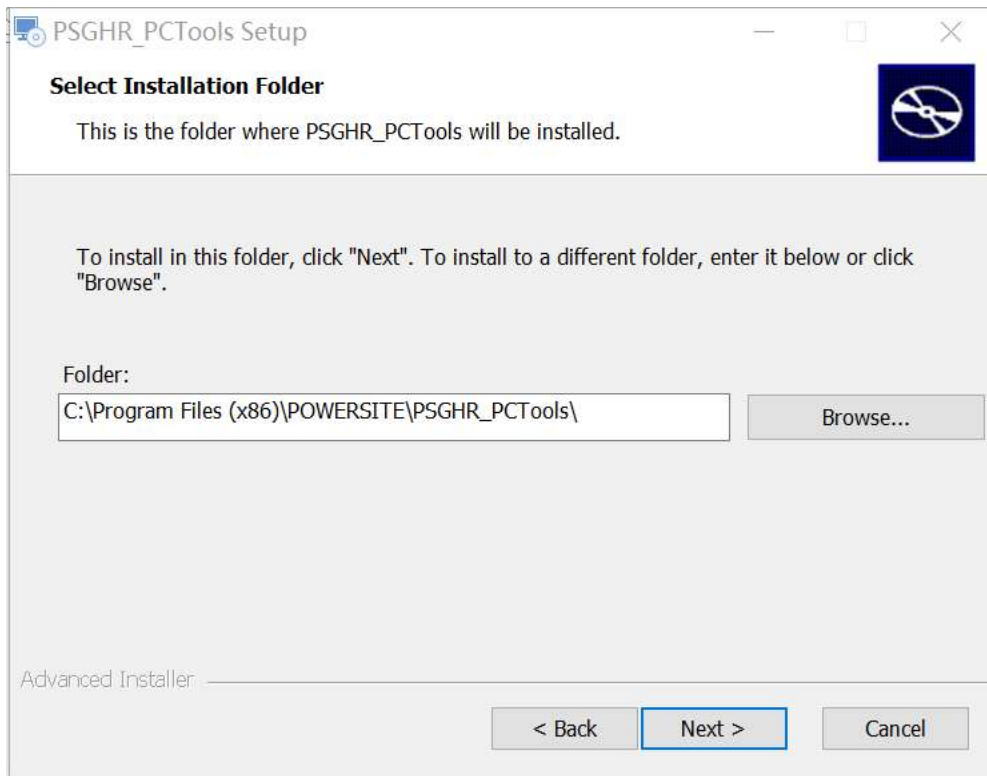

Figure 3-4 Installation guide 3

Click on "Installation" and then proceed with the automatic installation. When the installation is successful, the interface shown in Figure 3-5 will pop up to indicate that the installation is completed.

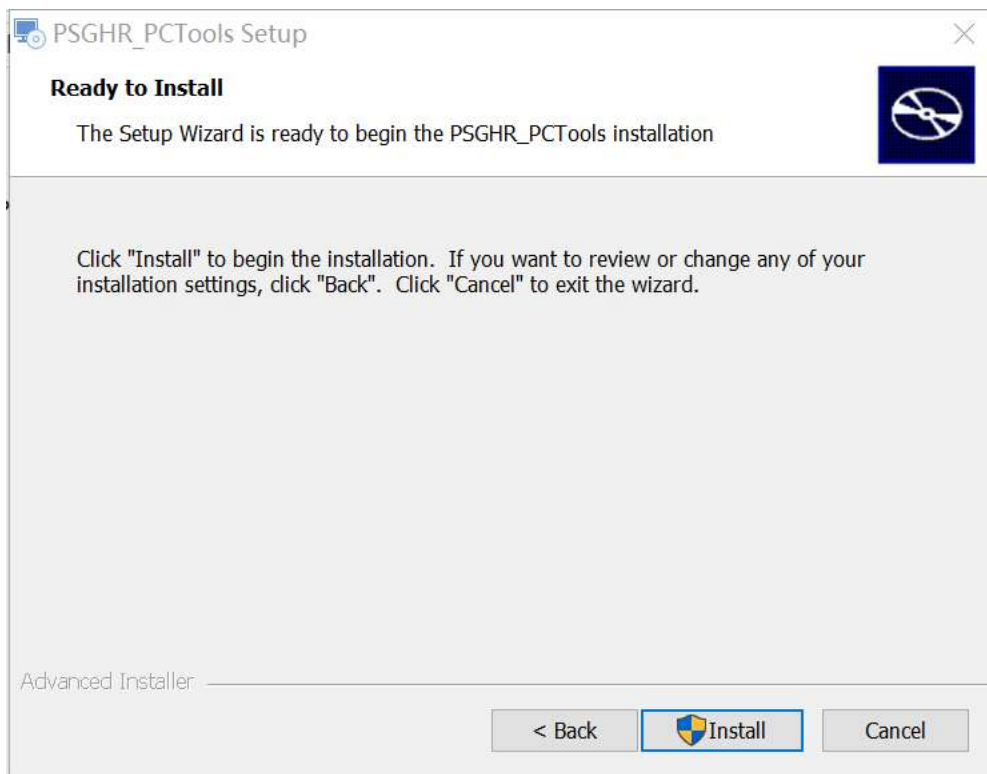

Figure 3-5 Installation guide 4

Now the installation is completed.

If the operating system is not installed with .NET 4.5, the installation package will automatically install the .NET 4.5 running environment. The interface will pop up in Figure 3-6 before the 3-2 interface. This interface may last for a few minutes to

more than ten minutes. Please wait patiently until the interface shown in 3-2 pops up.

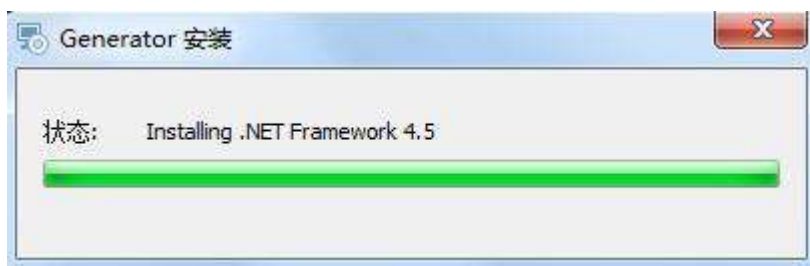

Figure 3-6 Installation of .NET4.5

3.1.3.1 Software Start-up

When the software is installed successfully, shortcuts are automatically created on the desktop as shown in the following Figure.



Double click the shortcut to pop up the interface shown in Figure3-7 to indicate that the software has been set up.



Figure 3-7 Service software start-up

3.1.4 Power-on confirmation

Make sure that the voltage is in normal range with measuring the power source by multimeter, and the grounding is effectively connected before powered on.

Warning: Do not repair the machine or perform maintenance operation during working time.

3.2 Software interface introduction

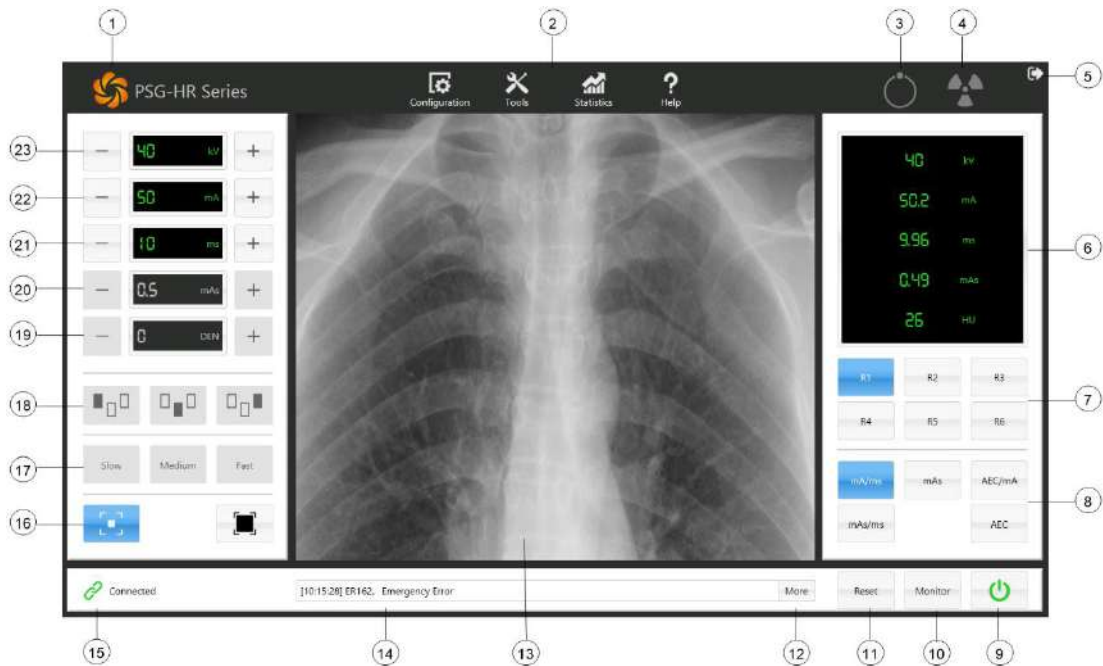

Figure 3-8 Software interface

- 1) Corporate Logo, that is a status identifier, is highlighted in orange as both the generator is powered-on and it's communicating well with software otherwise the Logo appears gray.
- 2) Parameters setting menu, with four items ("Configuration", "Tools", "Statistics" and "Help"). "Configuration" contains generator configuration and software configuration; "Tools" contains Filament Calibration, AEC Calibration and auto aging; "Statistics" contains exposure counting and system log; "Help" contains product information, help document and firmware updating.
- 3) Prepare indicator, see 3.3.7.3 for detail.
- 4) Exposure state indicator, see 3.3.7.4 for detail.
- 5) Exit button. Click this button then quit from the software system.
- 6) Data feedback, see 3.3.7.5 for detail.
- 7) Work station selection (Don't open for user).
- 8) Exposure technical setting, see 3.3.6.1 for detail.
- 9) Power on/off, see 3.3.7.2 for detail.
- 10) Serial interface monitor. It's used to monitor the data of serial interface, convenient to service engineer.
- 11) Internal test(not open for user)
- 12) Detailed error message, see 10.1.3 for detail.
- 13) Brief error message, see 10.1.3 for detail.
- 14) Working area of menu. When the menu is selected, the details of menu will show up in this area.
- 15) Communication state, see 3.3.7.1 for detail.

- 16) Focus select, see 3.3.6.2 for detail.
- 17) Internal test function(not open to user)
- 18) Internal test function(not open to user)
- 19) Internal test function(not open to user)
- 20) Product of current and time setting, see 3.3.6.6 for detail.
- 21) Time setting, see 3.3.6.5 for detail.
- 22) Current setting, see 3.3.6.4 for detail.
- 23) Voltage setting, see 3.3.6.3 for detail.

The high frequency high voltage generator is one of the most important parts of X-ray image system, whose major function is to provide high voltage power and filament heating power. The generator can normally exposure after pushing the exposure button once the installation completed and the exposure parameters were setted well. Here is the following details.

3.3 Software configuration

3.3.1 Serial interface Configuration

Since the service software communicates with the generator through serial interface, the serial interface's number must be set correctly in order to work properly. As shown in Figure 3-9, click "ConFigureuration - > Local".

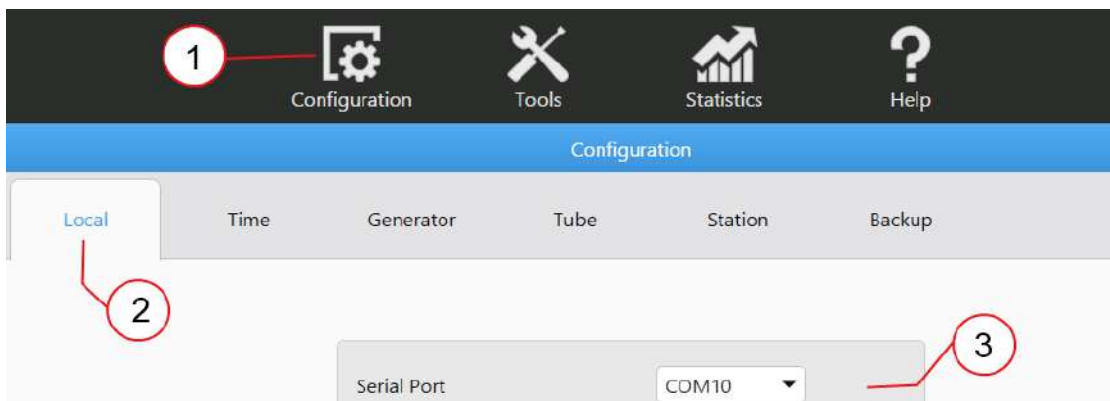

Figure 3-9 Local Configuration Interface

Clicking on the drop-down arrow on the right of "Serial Port", it will list all COM ports of this computer, as shown in Figure 3-10.



Figure 3-10 Serial Port Configuration

Select a COM port connected to the generator and click "Apply" to pop up the interface as shown in Figure 3-11.

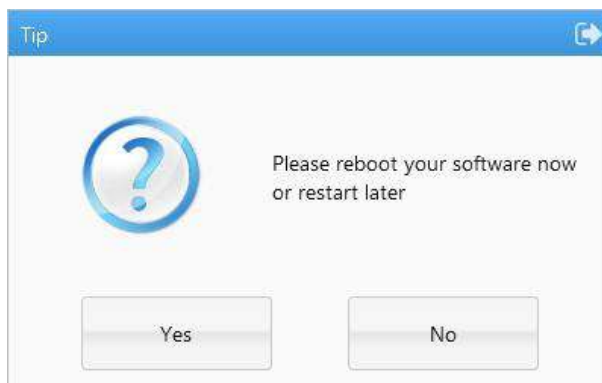

Figure 3-11 Serial Port Configuration Guide 3

Select "Yes" to restart the software automatically. Select "No" will not restart the software automatically, and it will normally communicate until the next manually restart.

Note: Before setting up the serial port, the computer must install the serial port device and the serial port driver, otherwise the software may not find the corresponding serial port.

3.3.2 Generator Parameters Configuration

Generator parameters have been configured before OQC. No modification is recommended. Click "ConFigureuration" -> "Generator" in turn to pop up the interface as shown in Figure 3-12.

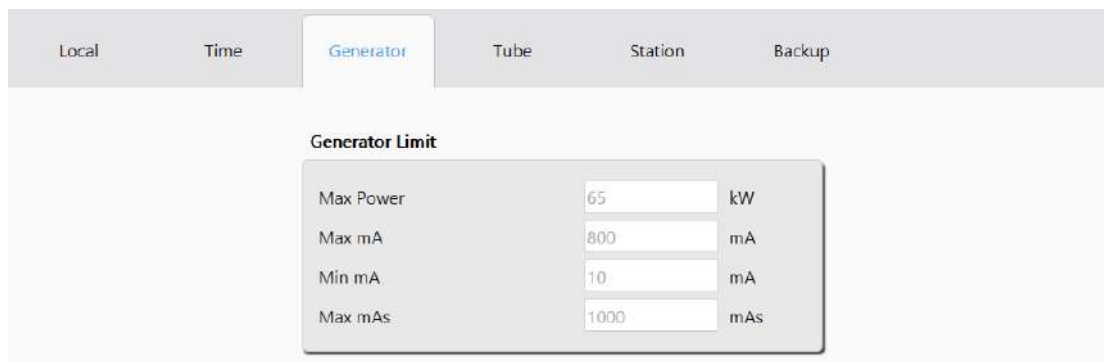

Figure 3-12 Generator parameter conFigureuration

- “Max Power”: Maximum value of power. The generatoe will not exposure, if the value is greater than “Max Power”.
- “Min mA”: Minimum value of tube current supported by the generator. The generatoe will not exposure, if the value is greater than “Min mA”.
- “Max mA”: Minimum value of tube current supported by the generator. The generatoe will not exposure, if the value is less than “Min mA”.
- “Max mAs”: Maximum value of product of current and time supported by the generator. The generatoe will not exposure, if the value is greater than “Max mAs”.

3.3.3 Tube Data Configuration

After installing or replacing the tube, it is necessary to re-configure the tube data in the generator. The configuration is as follows: click Configuration - > Tube in turn. The interface shows up in Figure 3-13. Here are some of the items:

Section	Parameter	Value	Unit
Tube Information	Tube Name	Toshiba XRR-3331X	
	Version	101	
	Speed Type	Dual	
	Anode Heat Content	210	kJ
	Small Focus Max kW	27	kW
	Large Focus Max kW	65	kW
	Small Focus Max mA	320	mA
	Large Focus Max mA	800	mA
	Focus Enabled	<input checked="" type="checkbox"/> Small Focus <input checked="" type="checkbox"/> Large Focus	
	Filament Parameter	Boost Time	200
Preheating Time		800	ms
Small Focus Standby		2.50	A
Large Focus Standby Current		2.50	A
Small Focus Max Current		5.20	A
Large Focus Max Current		5.50	A
Anode Parameter	Anode Warning	80	%
	Anode Limit	90	%
	HangOver Time	30	s

Figure 3-13 Tube parameters configuration

3.3.3.1 Interface Introduction

- “Name”: Name of tube.
- “Version”: The version of the file.
- “Speed Type”: Velocity of tubes, such as Low (low speed), High (high speed), Dual (double speed).
- “Max Heat Storage”: Maximum value of heat capacity of anode.
- “Small Focus Max kW”: Maximum power of small filament.
- “Large Focus Max kW”: Maximum power of big filament.
- “Small Focus Max mA”: Maximum tube current of small filament.
- “Large Focus Max mA”: Maximum tube current of big filament.
- “Small Focus Enabled”: Whether the small filament is available or not, the selected filament is available, and the unselected filament is disabled.

- “Large Focus Enabled”: Whether the big filament is available or not, the selected filament is available, and the unselected filament is disabled.
- “Anode Warning”: Anode heat capacity warning value, if the heat capacity exceeds this value, the generator can still exposure but will send out a warning.
- “Anode Limit”: The maximum heat capacity of the anode, if the heat capacity exceeds this value, the generator will not exposure.
- “Hangover Time”: The duration of the "Hangover" state after each exposure.
- “Boost Time”: Filament Boost Time.
- “Preheating”: Filament Preheating Time.
- “Small Focus Standby”: Standby current of small filament.
- “Large Focus Standby”: Standby current of large filament.
- “Small Focus Max Current”: Max current of small filament.
- “Large Focus Max Current”: Max current of big filament.

Note: This page can only configurate Hangover Time, other data items can not be modified.

3.3.3.2 Function Description

Function	Description
Open	Open the configuration file stored by the computer
Save	Store data in the local computer
Read	Read the configuration file stored in HVG
Apply	Apply data in HVG

Note:

1. Be sure to select the appropriate tube configuration file for setting, or read the data stored in the generator first.
2. If the configuration file attached to the software does not contain the type of tube you are using, please contact our company for the corresponding configuration file.
3. A file only corresponds to one tube data. Do not save or apply data to other tube.

1) **Read configuration:** There are two ways to read the configuration. One is to click "Open" and pop up the interface as shown in Figure 3-14

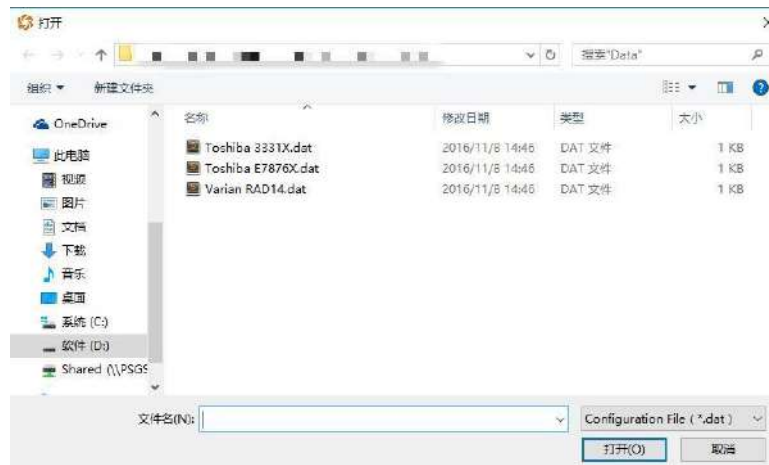

Figure 3-14 Selection of the configuration file

Then select the corresponding file and click “Open”. At this point, you can see the data in the interface has changed, indicating that it has been read successfully. If the file is corrupted, the system will pop up the error warning box as shown in Figure 3-15.

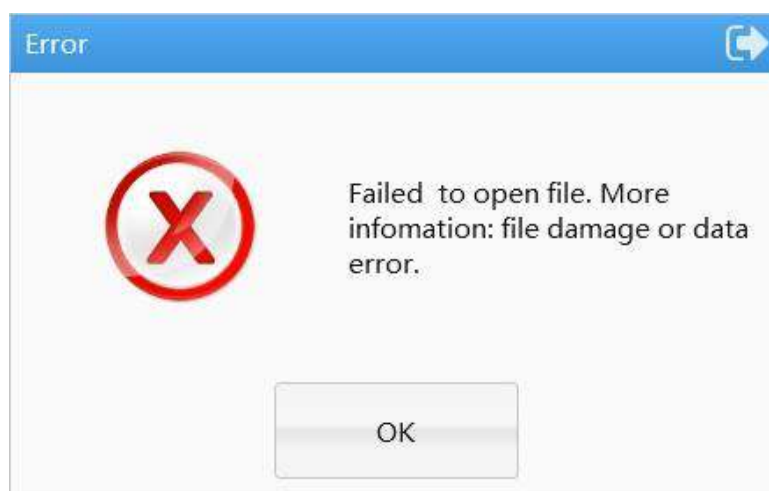

Figure 3-15 ConFigureuration file error

Another way of reading is to directly read the data stored in the generator by clicking “Read”. If the reading fails, the warning box will show in Figure 10-8. Please ensure the communication is normal and try again.

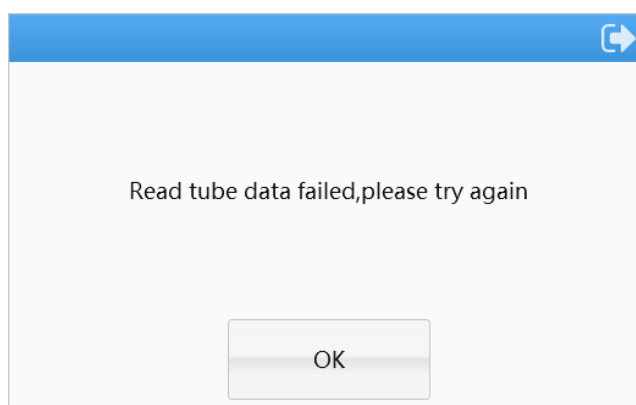

Figure 3-16 Failed to read the tube conFigureuration

2) **Modify configuration:** It can be configured with due care according to the configuration file provided by the company. In order to avoid the unreasonable setting of data by users' misoperation, the software provides the verification function of some data. If the input data is unreasonable, the warning information as shown in Figure 10-9 will pop up on the right side of the data item.



Figure 3-17 Data Verification Interface

Note: Some data may not have a verification function, so please observe the unit to fill in the data and set reasonable values. Do not rely on the verification function.

3) **Apply configuration:** Click “apply” after opening or modify configurations. If successfully, it will show up the following figure 3-18 of warning box, otherwise it will also show up a failure warning box.



Figure 3-18 The feedback of success or failure of apply configuration

4) **Save configuration:** Click “save” to save the modified data in the local computer.

3.3.4 Workstation Configuration

The workstation needs to be configured before using HVG. The configuration method is as follows: click “Configuration -> Tube” in turn. The interface show up in Figure 3-19.



Figure 3-19 Workstation Configuration Interface

3.3.4.1 Interface Introduction

The software can configure up to six workstations, namely R1, R2, R3, R4, R5 and R6. Every item in the workstation is

same. Here's a description of the workstation items:

- ◆ “Working Model”: two Models to choose from, the “flat” model means it can exposure with a falt and the “free” model means it can exposure without a flat.
- ◆ “Anode Speed”: the anode rotating speed of tube, classified as “Low”, “High” and “Auto”. Low means a low speed of anode roating speed as exposing; High means a high speed of anode roating speed as exposing; Auto means the tube can automatically select a speed of anode roating speed as exposing.
- ◆ “AEC back-up ms”: Under AEC exposure mode, if the exposure time exceeds the back-up ms, the exposure will be stopped.
- ◆ “AEC back-up mAs”: Under AEC exposure mode, if the product of exposure current and time exceeds the back-up mAs, the exposure will be stopped.

3.3.4.2 “AEC Channel”: Two Ionizing chambers, “Tablele Channel” and “WBS Channel” is available to be chosen.**Function Description**

Function	Description
Open	Open the configuration file stored in the computer
Save	Store data in a local computer
Read	Read the configuration file stored in HVG
Apply	Apply data in HVG

The specific operation is similar to the tube configuration, please refer to 3.3.2.

Note: “Open”, “Save”, “Read” and “Apply” in the functional area are used for six workstations, not for selected workstations.

3.3.5 Time settings

The function is setting the time for generator. Click configuration> time in turn, the dialog box as shown in Figure 3-20.

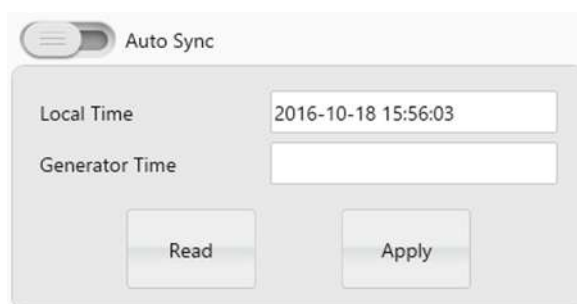



Figure 3-20 Time Settings of Generator

3.3.5.1 Auto configuration

The software can automatically synchronizes the time of generator. Turn on the “Auto Sync” symbol into . The generator could synchronizes the time with the computer whenever powered-on.

Note: The system self-synchronizes the time. Do not change this configuration if not necessary.

3.3.5.2 Manual configuration

The manually setting time is as follows:

1. Turn off the “Auto Sync” into  ;
2. Set the time at “Generator Time”, such as 2017-01-01 14:01:32;
- 3 .Click “Apply”, the following dialog will show up as if configuring successfully..

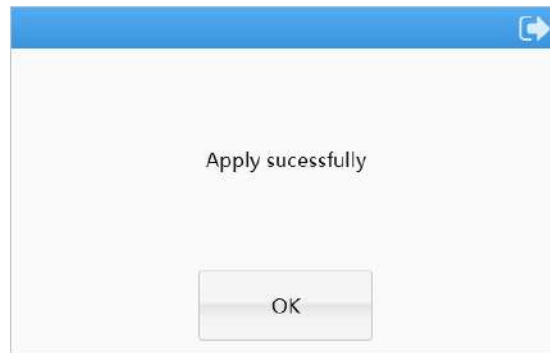



Figure 3-21 Time setting successfully

3.3.5.3 Sound configuration

The software can make a sound of exposure and error warning. The interface allows users to click the sound icon to turn off / on the sound. Click "Apply" to take effect, without restarting the software.

- Playing exposure sound on: 
- Playing error warning sound on: 

3.3.5.4 Message configuration

The error message will pop up while improper operation or system errors. Click “ok” to close the window. The system supports auto-closed the window after the “Popup Display Time” .

Notes: 0s represent the window always show up until manually closing the message window.



Figure 3-22 Message Window

3.3.6 Exposure Parameters Settings

Exposure parameters need to be set before exposure with hand brake. If exposure parameters are not been set, the failure may occur.

3.3.6.1 Selection of Exposure model

As shown in Figure 3-23, there are five modes to be chosen from, namely mA/ms, mAs, AEC/mA, mAs/ms and AEC. While the parameters of each mode are different, the color of the parameters that can not be adjusted is grey and can not be clicked on the interface.



Figure 3-23 Exposure model Settings

The parameters that can be modified under each exposure model are different, whose corresponding relations are shown in the Table below, ✓ means adjustable, × means unadjustable.

	mA/ms	mAs	mAs/ms	AEC	AEC/mA
Large/mall focus	✓	✓	✓	✓	✓
kV	✓	✓	✓	✓	✓
mA	✓	×	×	×	✓
ms	✓	×	✓	×	×
mAs	×	✓	✓	×	×

Note: Exposure parameters must be set before exposure, otherwise it may cause failure.

3.3.6.2 Focus Selection

Focus selection is shown in Figure 3-24. The front one is the small focus, the back one is the large focus, and the color is blue when it's been selected.

Note: If any of the focus in the tube data is disabled, the focus cannot be switched. If both two focuses are set to be disabled, the focus cannot be set.

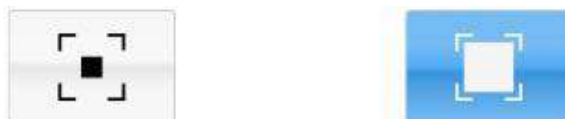

Figure 3-24 Focus selection

Note: The focus must be set before exposure, otherwise it may cause failure.

3.3.6.3 Tube Voltage Setting

As shown in Figure 3-25, click on "+" or "-" to set the kV. The "-" means reducing the kV, and the long press means continuously

reducing. The "+" means increasing the kV, and the long press means continuously increasing. See **Appendix 3** for the details of range of kV. The max value of kV settings is 150 kV, and it can also be set for the max value according to different tube configuration files (the setting max value of kV is always not more than 150 kV).



Figure 3-25 KV settings

Note: 1. If kV doesn't change clicking on "-" or "+", it means that the kV has reached the limit value under the current exposure conditions (exposure parameters: mA, ms) and can not be adjusted. 2. The KV is adjusted once per 50ms while the theoretical time to increase the KV from 40 KV to 150 KV is 5.5 seconds.

3.3.6.4 Tube Current Setting

As shown in Figure 3-26, click on "+" or "-" to set the mA. The "-" means reducing the mA, and the long press means continuously reducing. The "+" means increasing the mA, and the long press means continuously increasing. See **Appendix 3** for the details of range of mA.



Figure 3-26 mA settings

Note: 1. The mA settings can only be available when the exposure mode is mA/ms and AEC/mA. 2. Due to the limitation of power, heat capacity and tube current, it may be unable to adjust the "+" and "-" and report errors. 3. The mA is adjusted once per 50ms by long press.

3.3.6.5 Exposure Time Settings

As shown in Figure 3-27, click on the "+" or "-" to set the ms. The "-" means reducing the ms, and the long press means continuously reducing. The "+" means increasing the ms, and the long press means continuously increasing. See **Appendix 3** for the details of range of ms.



Figure 3-27 Exposure time settings

Note: 1. The exposure time settings can only be available when the exposure mode is mA/ms and mAs/ms. 2. Due to the limitation of power, heat capacity and tube current, it may be unable to adjust "+" and "-" and report errors. 3. The ms is adjusted once per 50ms by long press.

3.3.6.6 Exposure Time Product Settings

As shown in Figure 3-28, click on “+” or “-” set the mAs. The “-” means reducing the mAs, and the long press means continuously reducing. The “+” means increasing the mAs, and the long press means continuously increasing. See **Appendix 3** for the details of range of mAs.



Figure 3-28 mAs settings

Note: 1. The mAs settings can only be available when the exposure mode is mA/ms and mAs/ms. 2. Due to the limitation of power, heat capacity and tube current, it may be unable to adjust “+” and “-” and report errors. 3. The mAs is adjusted once per 50ms by long press.

3.3.7 Generator state

3.3.7.1 Communication state

The annotation ⑭ in the main interface shown in Figure 3-8 represents the communication status.

 The sign showing green indicates that the software has been connected well to the generator;

 The sign showing gray indicates that the software can't be connected with the high generator. Please wait for about 10 seconds. If the connection is still not been established, please check whether the generator is powered on or whether the serial port configuration is normal.

3.3.7.2 Powered-On /Off State

The annotation ⑨ in the main interface shown in Figure 3-8 represents the powered-on/off state.

 The sign showing red represents that the generator is shut down, and the generator will power on by clicking the sign;

 The sign showing green represents that the generator is powered-on, and the generator will power off by clicking the sign;

 The sign showing gray represents that the generator's connecting state is unknown. It may be that the device is out of work or the communication is wrong. For safety, the mouse click will execute the shutdown command.

3.3.7.3 Standby state

The annotation ③ in the main interface shown in Figure 3-8 represents the preparation status during exposure

 The sign showing gray means it not yet pressed the handbrake or had exposed.

 The sign showing green means it is stanby after presseing the handbrake.

3.3.7.4 Exposure State

The annotation ④ in the main interface shown in Figure 3-8 represents the exposure state,



The sign showing yellow indicates that the generator is under the exposure state. In order to prevent misoperation, the software interface is set gray and the button is not available. If you need to play sound when exposure, it can be configured.



The sign showing gray indicates that the generator has completed an exposure or not yet exposed, and can take the next exposure.

3.3.7.5 Data Feedback

The annotation ⑥ in the main interface shown in Figure 3-8 represents the feedback statistics from generator. As shown in Figure 3-29, from top to bottom it is the feedback of KV, mA, ms, mA/s and heat capacity after the exposure. The heat capacity of tube is in %, range from 0 to100. It is a real-time feedback the heat feedback from internal tube.



Figure 3-29 Data Feedback

3.3.8 Filament Calibration

Whenever the tube is replaced or used for a period of time (about 6 months), it needs to be calibrated. Open the menu ‘Tools -> Filament’ in turn and the interface shown in Figure 3-30 will pop up.

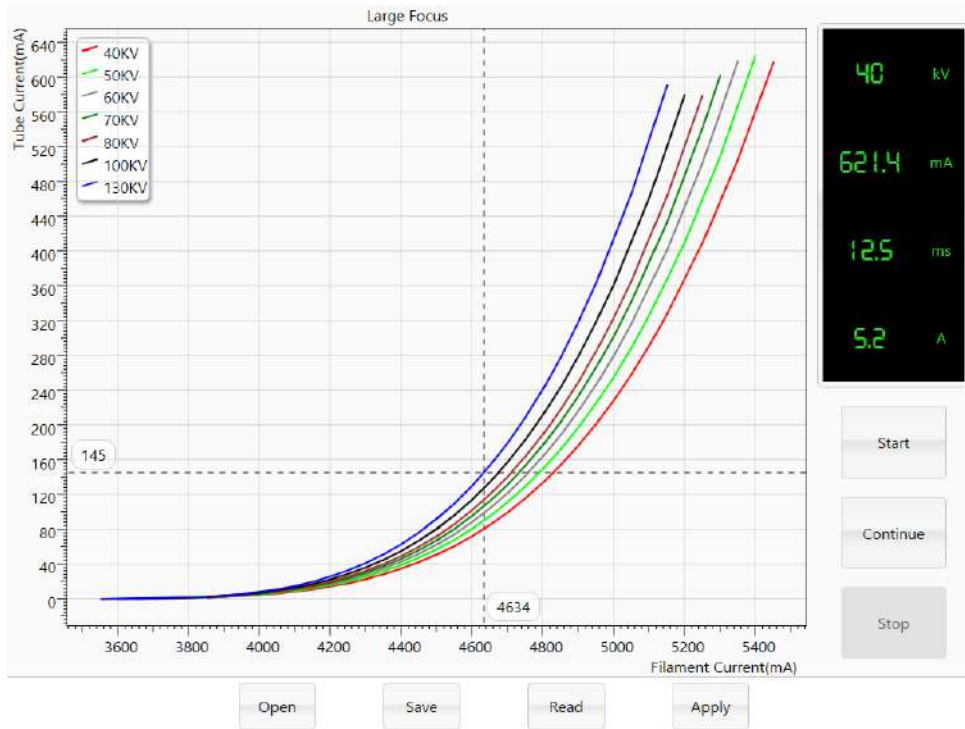

Figure 3-30 Filament Calibration Interface

3.3.8.1 Start calibrating

Selecting the corresponding focus and clicking “start”, the following window will pup up.

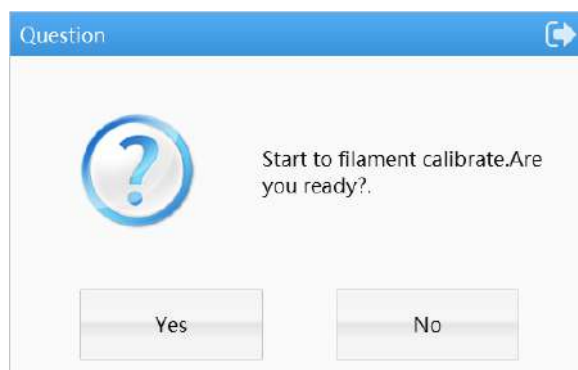

Figure 3-31 Filament calibrating

Click “Yes” and press the handwatch till the “Calibrate successfully” shows on the screen. Click “No” back to the previous page.



Figure3-32 Filament calibration successfully

3.3.8.2 Continue calibrating

When the calibrating was interrupted manually or abnormally, the operator can click “continue” to carry on calibration.

Notes: Difference between “Start” and “Continue”: Clicking “Start”, The generator will start calibrating from 40kV until calibration done; Clicking “Continue” , the generator will start from last kV testing point until calibration completed.

3.3.8.3 Stop Calibration

Since the calibration begins, click "Stop" to stop calibration.

Note: Please re-calibrate the tube after stopping, or restart the generator, otherwise it is impossible to exposure.

3.3.8.4 Abnormal Calibration

If an error occurs during the calibration process, the calibration will be terminated, Please click "Start" to re-calibrate or click "Continue" to continue the last calibration after handling the fault.。

3.3.8.5 Curve calibration

Curve calibration function has been implanted in the software, therefore the software will automatically draw the calibration curve. In case the curve is not been seen on the screen, the axis might be manually adjusted. Please press "Home" on the keyboard to resume. The software can also save and read the calibration curve.

Notes: The curves appeared in the calibration process are plotted through real-time exposure points. The curves are fitted based on all exposure data after calibrating, so that the curve after calibrating and the curve during calibration may not be consistent.

1 Opening curves

Clicking “open” as shown in Figure 3-30, the page as shown in Figure 3-33 pops up. Selecting the “.cal” curve file to open the corresponding curve data.

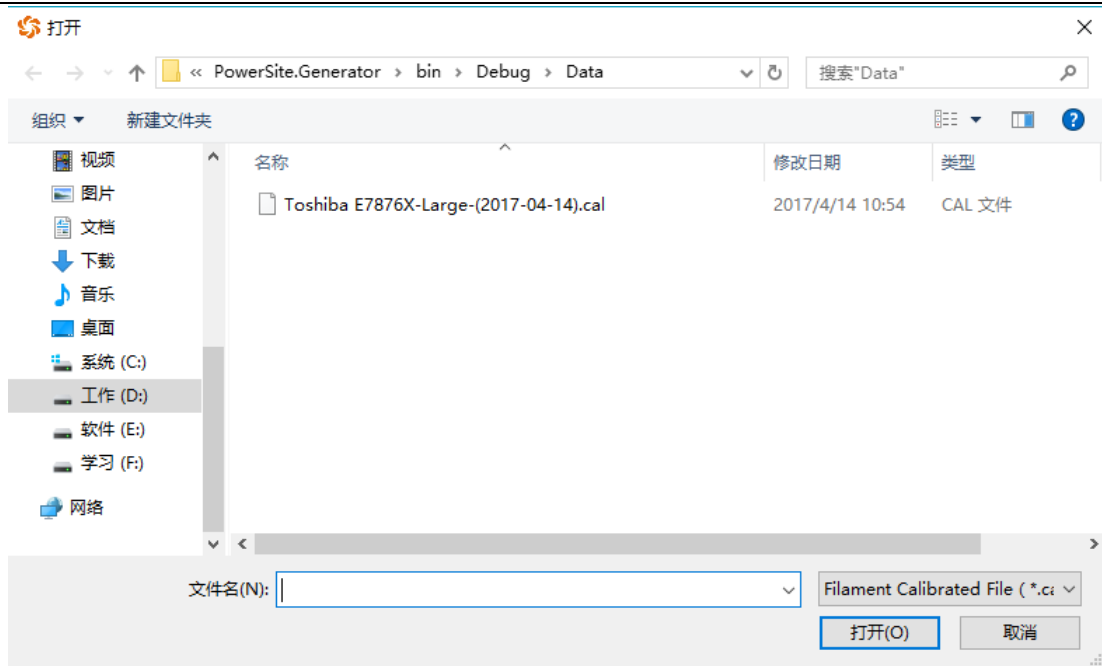

Figure3-33 Opening the curve calibration file

Note: Please click the “Apply” carefully to apply the data into the generator, if the saved files are not consistent with the displayed data (“Small Focus” or “Large Focus”)shown at the top of Figure 3-33 after opening the the curve calibration file.

2 Saving curves

Click the "Save" in Figure 3-30 and select the saved path and file name to save the curve calibration file. A dialog box will pop up after saving successfully.

3 Reading Curves

Select the filament, then click the "Read" in filament calibration page shown in Figure 3-30 to read the corresponding calibration curve from the generator.

Note: If the focus has never been corrected, a "reading failure" prompt box may pop up or the page does not appear any curves.

4 Applying curves

Clicking the "Apply" in Figure 3-30, the system will apply the curve data into the generator, after that the generator will exposure by setting the filament current according to this calibration curve. If there is no curve on the page, the dialog box shown in Figure 3-34 will pop up by clicking the "Apply" directly.



Figure 3-34 No curve dialog box

3.3.9 AEC calibration

Click “Tolls” > “AEC” in turn, the interface will pop up as shown in Figure 3-35.

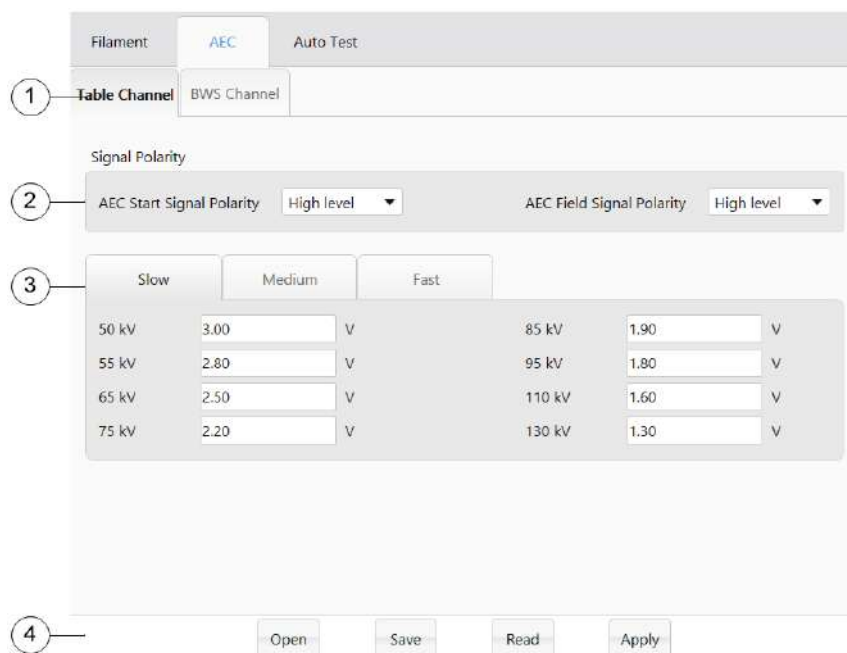

Figure 3-35 AEC Calibration

3.3.9.1 Interface introduction

- ① AEC channel selection. Two AEC channels, “Tablele Channel” and “BWS Channel” can be choosed for calibration. The chosen channel’s text color is darker otherwise the color is lighter.
- ② Polarity of signal. Both the AEC startup signal and the AEC field signal have the “high level” and “low level” to choose from.
- ③ Function zoon. AEC corrected data can be saved and applied by the button in this area, as well as the local calibration file or the corrected data stored in the generator can be read.

3.3.9.2 Method of calibration

- 1 Select the AEC channel
- 2 Set the signal polarity

- 3 Adjust the Integral stop voltage
- 4 Click “apply” to apply data into the generator

Note: Integral voltage range: 0V-10V

3.3.9.3 Data calibration

Similar to filament calibration, AEC calibration data can be "Open"、"Save"、"Read"、and "Apply".

3.3.10 Report from statistics

3.3.10.1 Exposure statistics

Clicking "Statistics"->" Exposure Count" in turn in the menu, the interface shown in Figure 3-36 will pop up. Clicking the "Read" to see the exposure times.

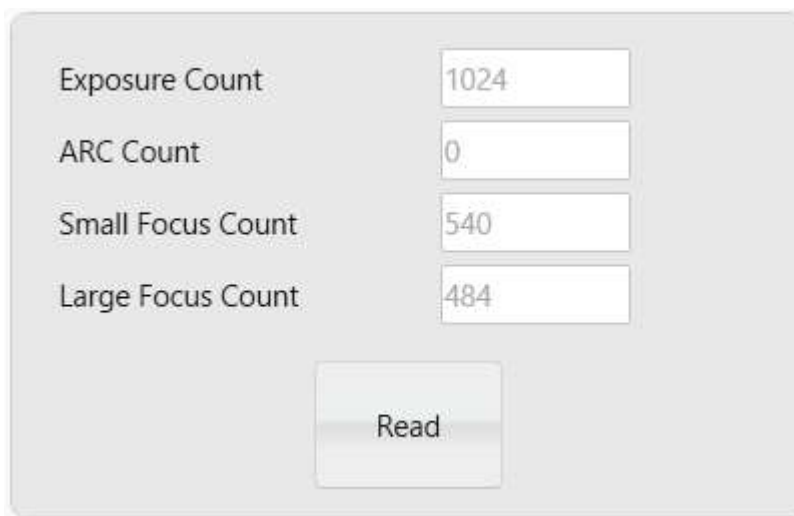

Exposure Count	1024
ARC Count	0
Small Focus Count	540
Large Focus Count	484

Read

Figure3-36 Exposure statistics

Exposure Count: Total exposure times

ARC Count: Internal test function, not open for users

Small Focus Count: Small focus exposure times.

Large Focus Count: Large focus exposure times.

Note: Failure to read exposure data may occur when the software communication with the generator is un-connected.

3.3.10.2 PC Log

Clicking "Statistics"->" Log" in turn in the menu, the interface shown in Figure 3-37 will pop up.

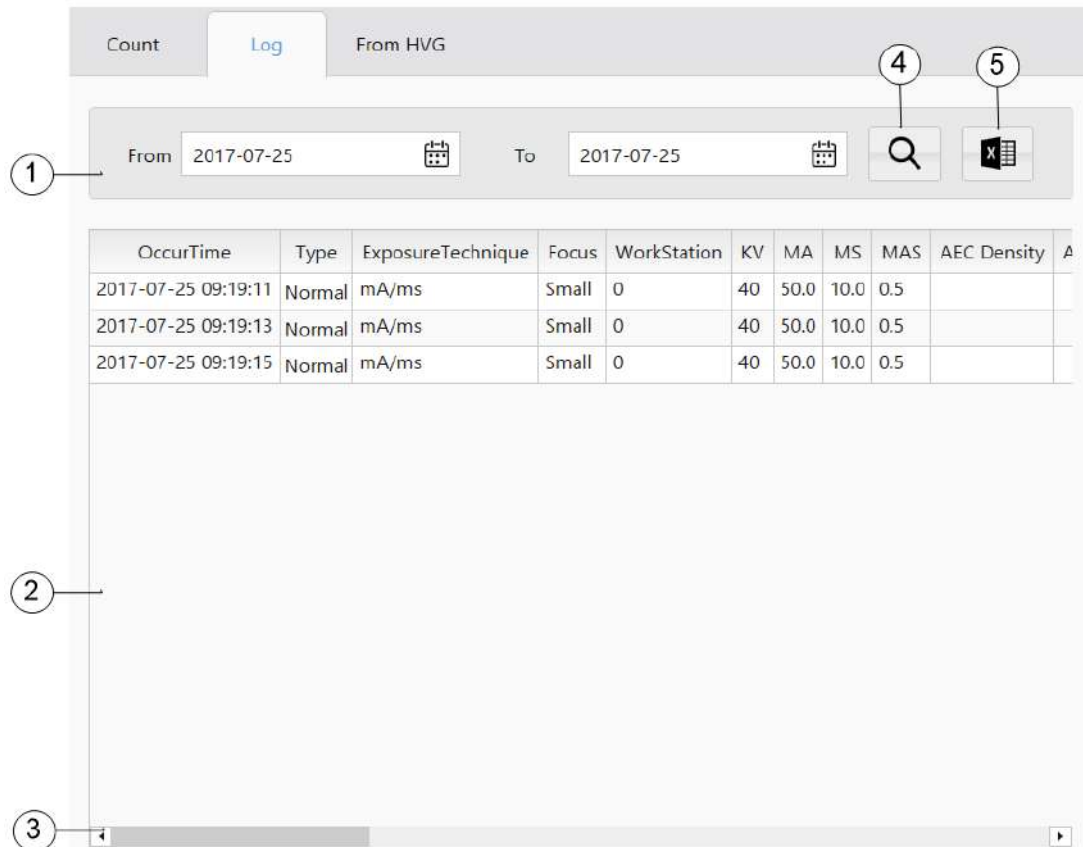

Figure3-37 Exposure record

- ① Date Selection Column. The date can be searched from start-date to end-date.
- ② Display area. The results of the query display in this area, sorting by clicking the title bar.
- ③ Left and right scroll bar. More items can be displayed by this scroll bar.
- ④ Search button. Screening log records by date
- ⑤ Excel Export. The data can export from ② in format of “.xlsx”, Excel 97-2003 not supported for its max capacity of 65536 statistics.

No.	Message	Description	Unit
1	Occur Time	Occur Time	/
2	Type	Log types are “Exposure”, “Calibrate”, “Reset”, “ER”, “EL”, “EI”, and “Aging”. If the type is “ER”, “EL” or “EI”, the explanation of corresponding error codes can display by hovering the cell.	/
3	Exposure Technique	Exposure Technique displayed in characters.	/
4	Focus	Focus displayed in characters.	/

5	WorkStation	WorkStation. 0-5 represents R1、R2…… R6.	/
6	KV	KV settings displayed in values.	kV
7	MA	MA settings displayed in values.	mA
8	MS	MS settings displayed in values.	ms
9	MAS	MAS settings displayed in values.	mAs
10	Filament Current	Filament Current settings.	A
11	PostKV	KV feedback	kV
12	PostMA	MA feedback	mA
13	PostMS	MS feedback	ms
14	PostMAS	MAS feedback	mAs
15	Post Filament Current	Filament Current feedback	A
16	HU	Heat capacity	%
17	Bus Voltage	Bus Voltage	V
18	Inverter Temperature	Inverter Temperature	°C
19	Anode Start Voltage	Anode Start Voltage	V
20	Anode Start Current	Anode Start Current	A
21	Anode Operating Voltage	Anode Operating Voltage	V
22	Anode Operating Current	Anode Operating Current	A
23	AEC Stop Voltage Set	AEC Stop Voltage Set	V
24	AEC Stop Voltage Feedback	AEC Stop Voltage Feedback	V

3.3.10.3 HVG Log

Clicking the "Statistics"->" From HVG" in turn in the menu, the interface shown in Figure 3-38 will pop up. The using method is similar to 3.3.10.1.

For service engineers, they not only need to know the exposure details, but also need to know the error record. All this part of the record stored in the generator can be read through the service software.

Error ID	Occur Time	FPGA Code	Error Code	Generator Status	KV	MA	MS	MAS	Focus	Anode Speed	Exposur
6645	2017-06-21 10:09:37.000	0	138	8	50	200	12.5	2.5	1	0	0
6646	2017-06-21 10:12:41.000	0	5	2	40	200	12.5	2.5	1	0	0

Figure 3-38 Error record

Record message list

No.	Error Code	Description	Unit
1	Error ID	Error ID	/
2	Occur Time	Error occur Time	/
3	Error Code	Error Code, see in appendix A	/
4	Generator Status	Generator Status, the state 1-8 is consistent with communication protocol.	/
5	Exposure Technique	Exposure Technique is consistent with communication protocol.	/
6	Focus	Focus is consistent with communication protocol.	/
7	WorkStation	WorkStation. 0-5 represents R1、R2……R6.	/
8	kV	KV settings displayed in values.	kV
9	MA	MA settings displayed in values.	mA
10	MS	MS settings displayed in values.	ms
11	MAS	MAS settings displayed in values.	mAs
12	Filament Current	Filament Current settings.	A

13	Anode Speed	Anode Speed, 0 @low speed、 1@high speed	/
14	Exposure Finished Status	Exposure Finished Status	/
15	Stop Reason	The reason of exposure stop is consistent with communication protocol.	/
16	Post KV	KV feedback	kV
17	Post MA	MA feedback	mA
18	Post MS	MS feedback	ms
19	Post MAS	MAS feedback	mAs
20	Post Filament Current	Filament Current feedback	A
21	HU	Anode heat capacity	%

Notes:

1. Clicking “Search” will only read the local HVG log, it doesn't automatically synchronize with the generator.
2. Eveytime you get in the “ From HVG ” page, the system backstate will automatically synchronize the HVG logs. When the log is synchronizing, the interface on both sides will be virtual; once it is completed, the interface on both sides will return to normal.
3. The page will not synchronize the HVG log in real time, so after entering the page, if the generator fails, the system can not synchronize in real time.

3.3.11 Firmware update

The system is able to upgrade firmware. Clicking “Help”->” Upgrade”, the interface shown in Figure 3-39 will pop up. Checking the upgrade file provided by the manufacturer and then clicking "Start" to start the firmware upgrade, the Figure 3-39 below shows the updating progress.

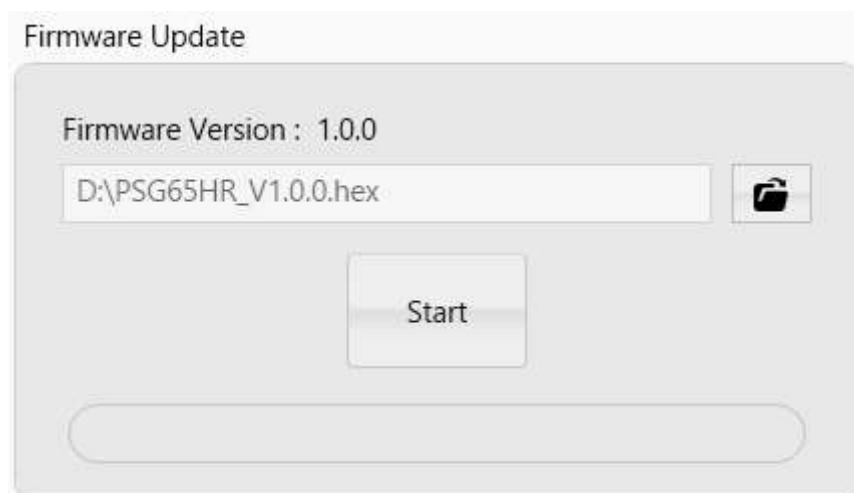

Figure 3-39 Firmware update

Note: Do not close the page or power off during update process. If the update fails, try the update operation again.

3.3.12 About us

Clicking "Help"->" About" in turn, the interface shown in Figure 3-40 will display, in which the corresponding generator model, software version and firmware version all can display. Click on the blue "United Imaging" to access the company's website.



Figure3-40 About interface

3.3.13 Help document

When you need to browse the help document in the software, please click "Help"->" Document" in turn and the interface shown in Figure 3-41 will pop up.

3.3.13.1 Interface Introduction



Figure3-41 Help document interface

- ① Display area.
- ② Function area
- ③ Search area. Full-text search by key words through the region.
- ④ Display the page number. Display the number of current page and the whole page.

3.4 Software Operating Settings

3.4.1 Serial port configuration

After connecting the pc and generator via serial data cable, open the service software , as shown in Figure 3-42:

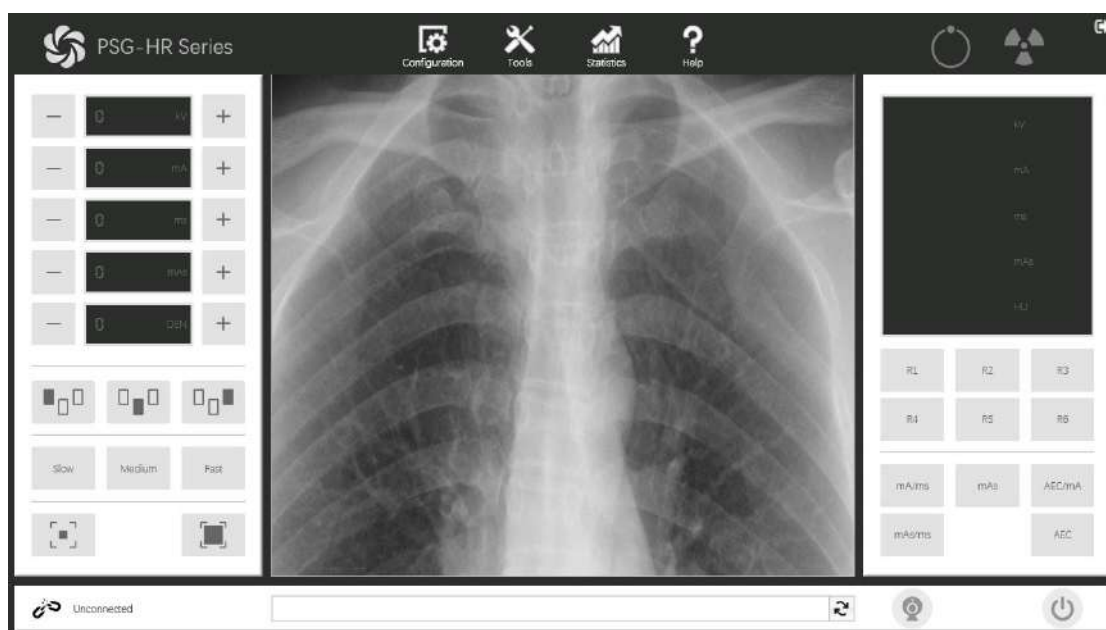

Figure 3-42 Software interface

Click “Configuration”->“Local” to choose the correct port No. as shown in Figure 3-43.

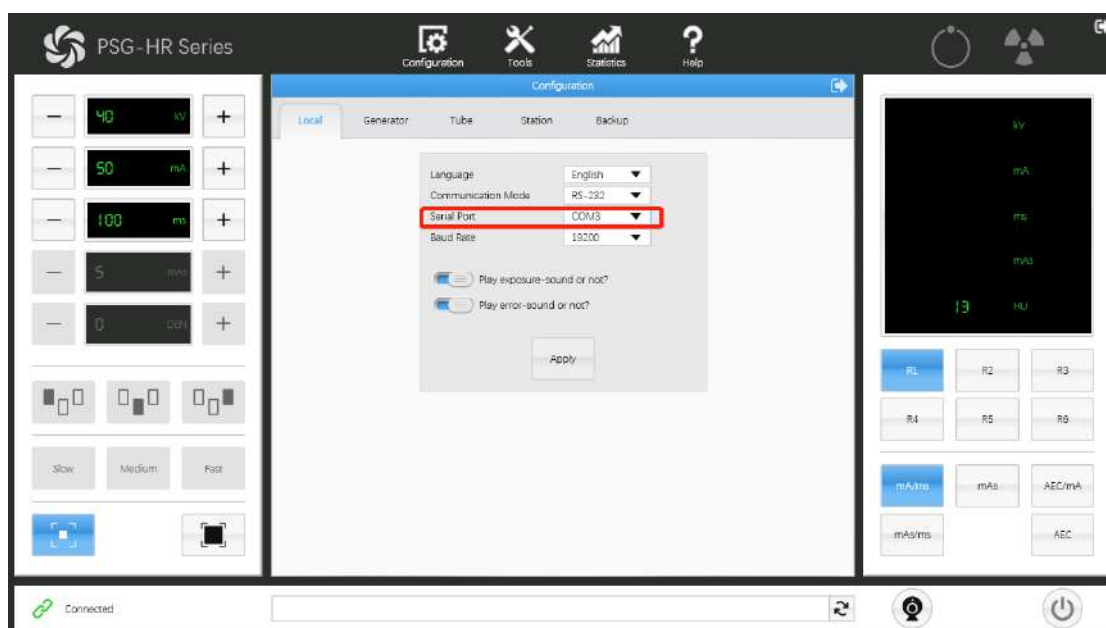

Figure3-43 Serial port configuration1

Other serial port No. can be found at device manager on the PC.

In the PC OS search bar, enter and open Device Manager to check Port (COM and LPT) as showed in Figure 3-44.

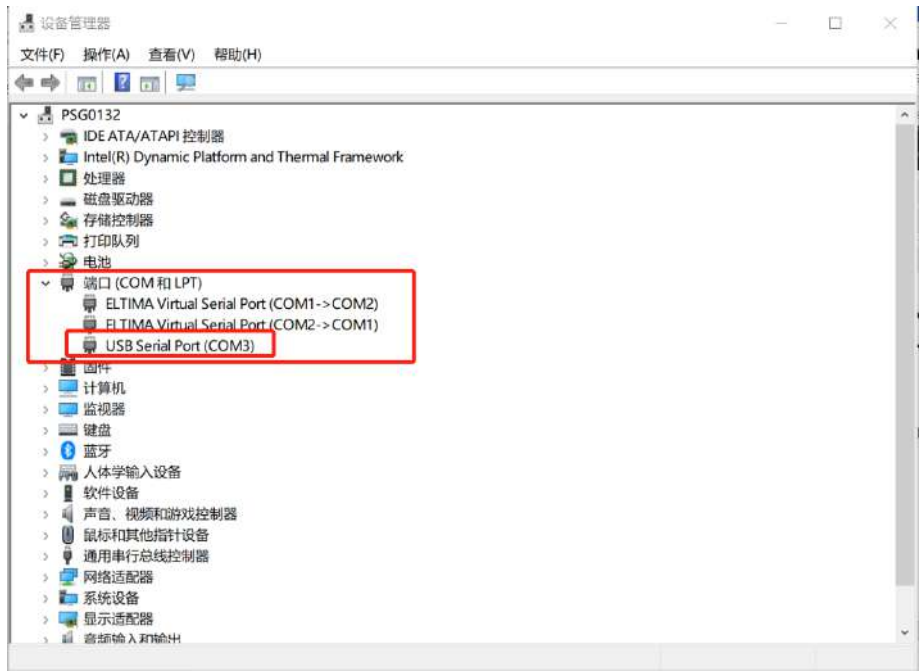

Figure3-44 PC device manager interface

After selecting the correct COM port, the software will automatically restart by clicking on "Apply" and selecting "Yes", then the software interface turned green, indicating that the communication is normal, as showed in Figure 3-45

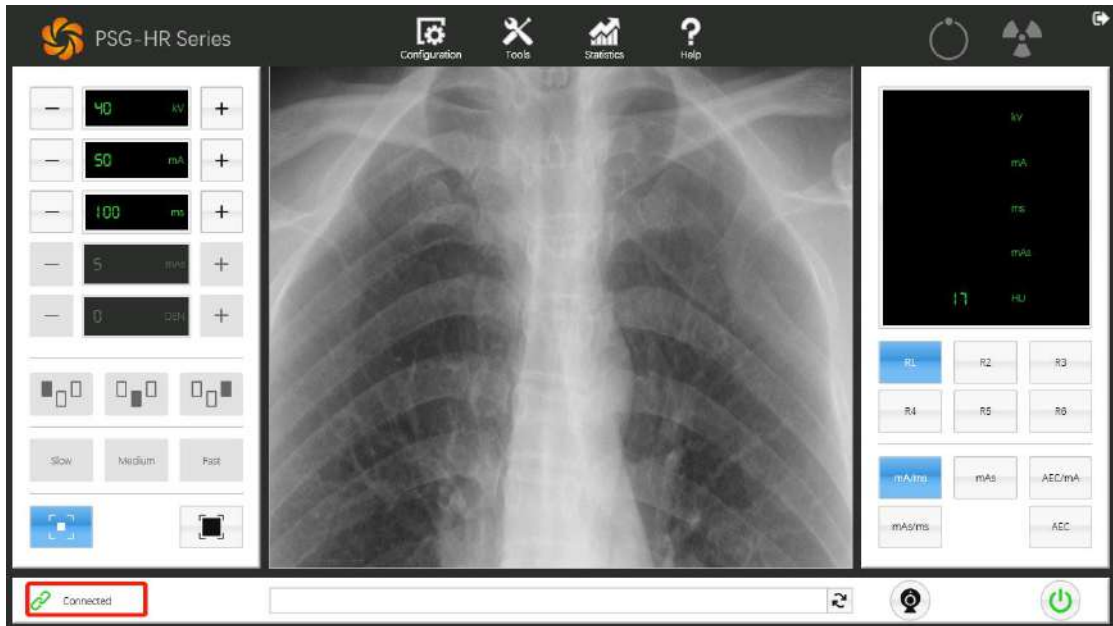

Figure3-45 Software interface for normal communication service

3.4.2 Power-on

When all the above mentioned steps are done, please power on the generator after making sure the voltage on the breaker is normal. If there is a control box, please confirm whether the emergency stop button of the control box is pressed; if there isn't, please press the boot button on the control box, as shown in Figure 3-46.



Figure 3-46 Control box

If there isn't a control box, please click the switch button on the service software, as shown in Figure 3-47. The lower right corner of the service software turns green after starting up successfully.

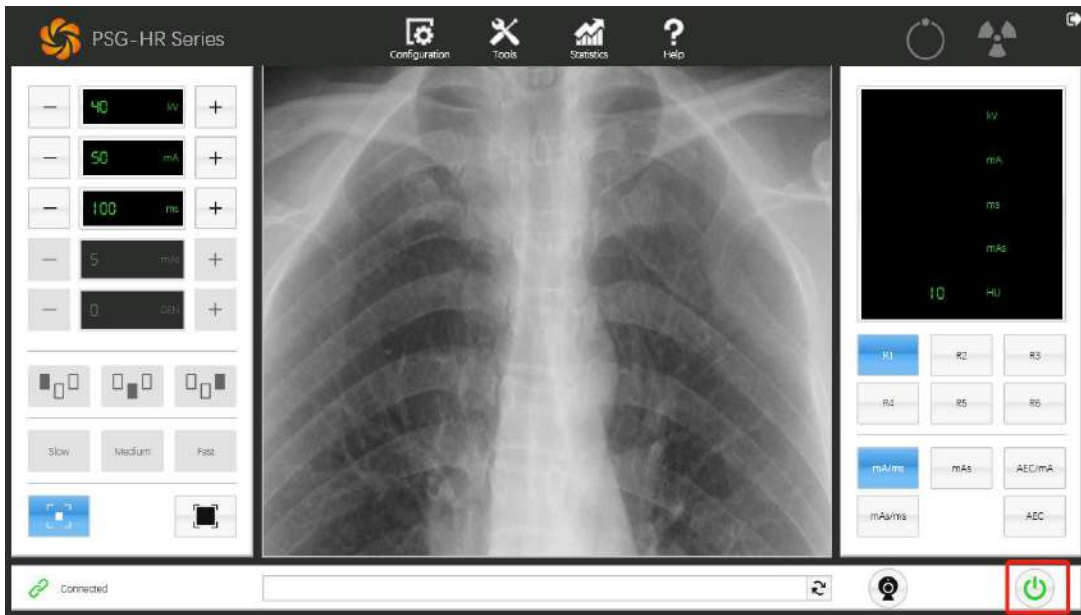

Figure3-47 Software switch icon

3.4.3 Tube configuration

We have to confirm whether the model of tube we selected on service software match with the tube of we connected before exposure. Clicking Configuration, and then clicking on the Tube page to check the tube model. As shown in Figure 3-48.

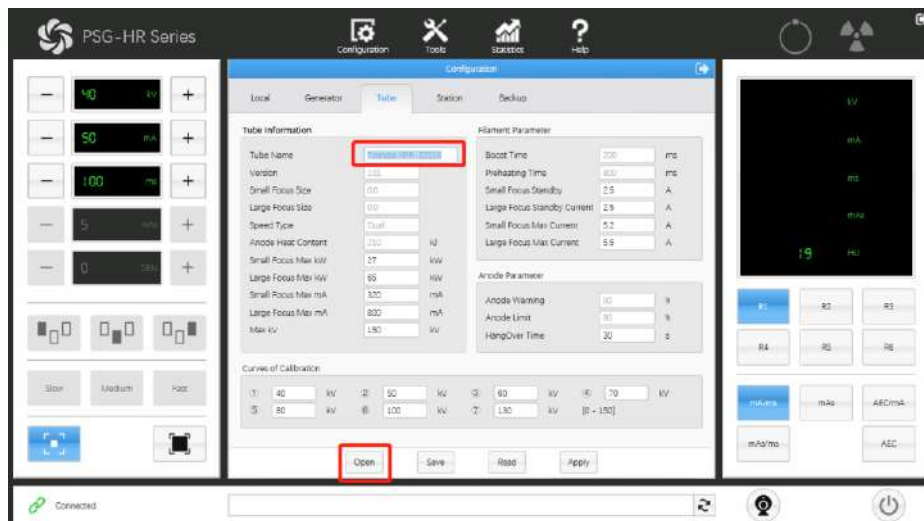

Figure 3-48 Tube selection interface

The Tube library folder will display by clicking “Open” (shown in Figure 3-7) if the models of the tube are not consistent, in which you can select the corresponding tube configuration file as shown in Figure 3-49 and 3-50.

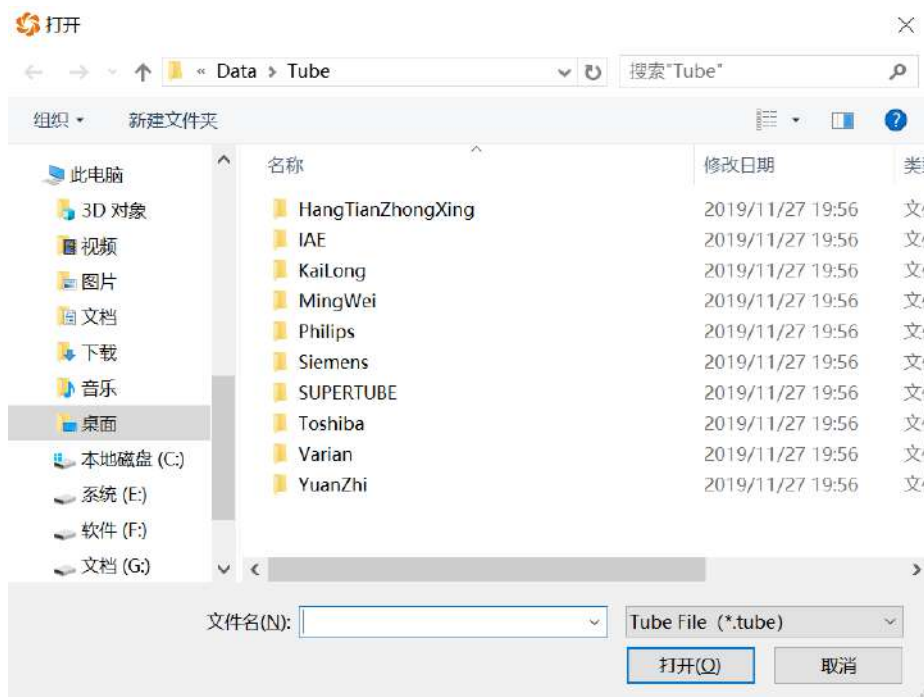

Figure3-49 Tube library folder 1

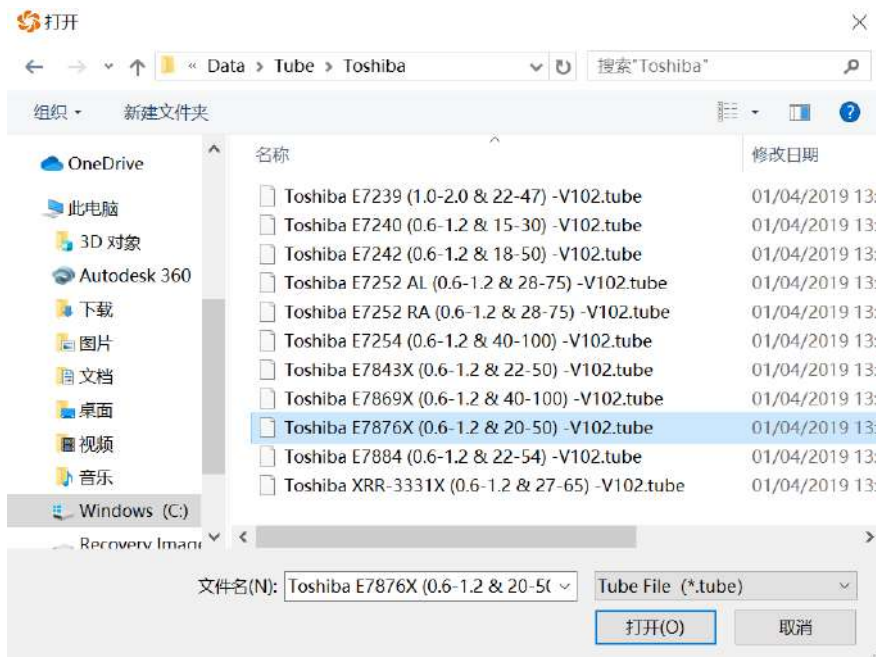

Figure 3-50 Tube library folder 2

After selecting the corresponding tube model, please click "open (O)" to check again whether the Tube Name is consistent at this time. If the types are consistent, please click "Apply" as shown in Figure 3-51.

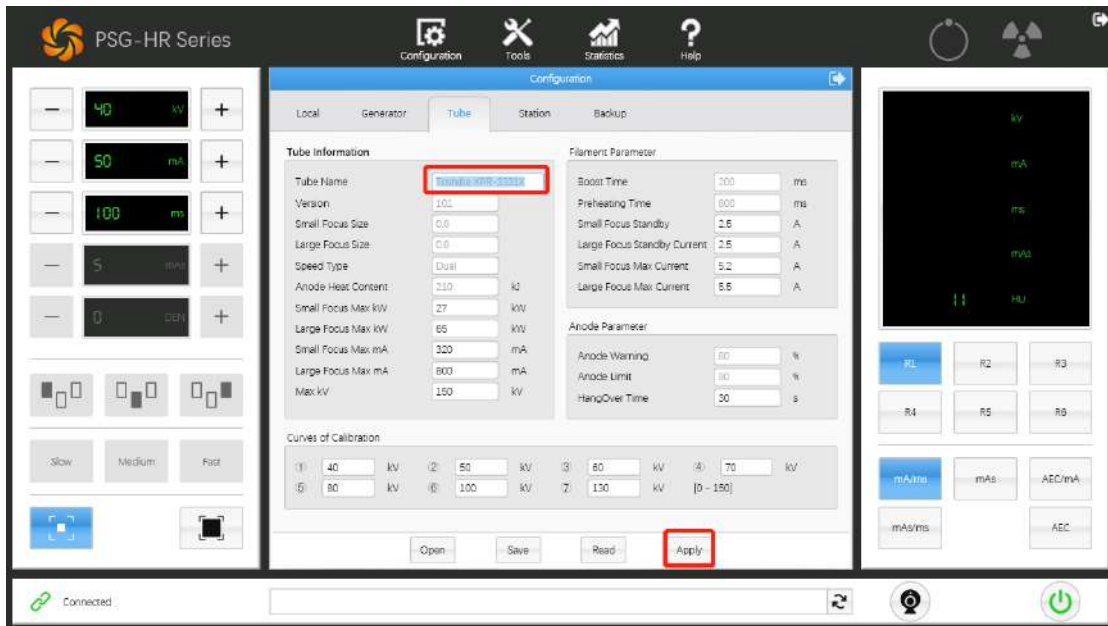

Figure 3-51 Tube application interface1

Display of "Apply successfully" indicates successful application.

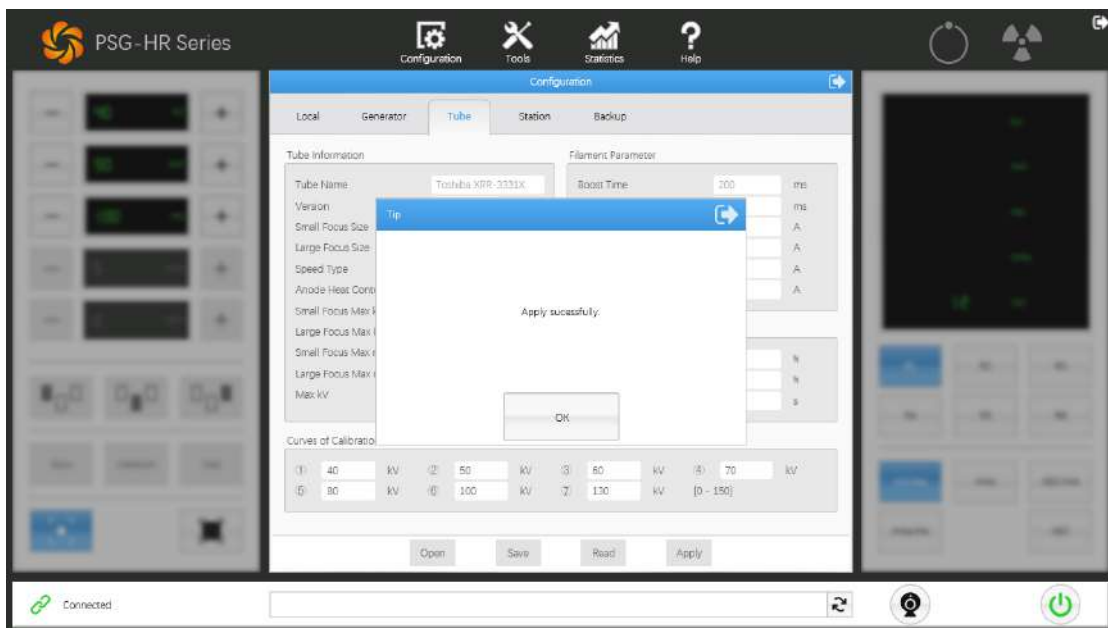

Figure3-52 Tube application interface2

Attention: If the tube data you choose is not in the Tube library, please send the official specification to us and we will complete the tube configuration file within one week and send it back to you.

3.4.4 Workstation configuration

Back to Configuration and clicking "Station" to enter the page, we can configurate 6 workstations (R1、R2、R3、R4、R5、R6), each workstation can be set according to the actual needs of customers.

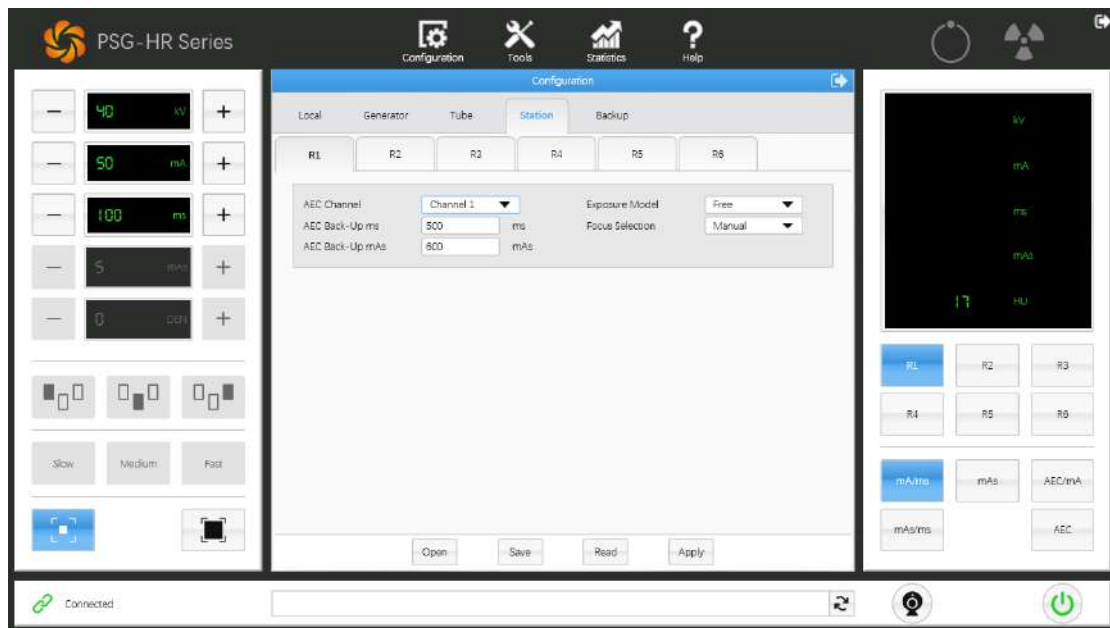

Figure 3-53 Workstation1

The specific operation is as follows: clicking “R1”, as shown in Figure 3-54, we can choose AEC channel 1 or 2, exposure mode (Exposure Model) selecting plate mode Flat or free mode Free etc., focus selection , manual switch or automatic switch:

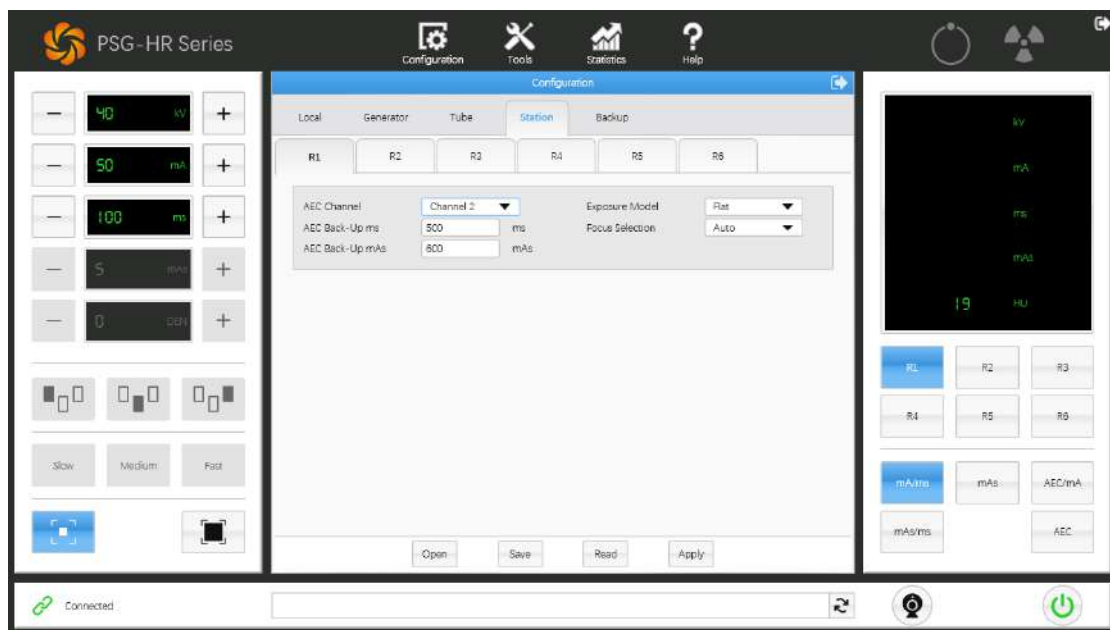

Figure3-54 Workstation interface2

According to the customers’ actual needs, clicking "Apply", display of "Apply successfully" means the configuration is done.

3.4.5 Operations

Once the above wiring and software settings have completed, firstly we press the level 1 hand brake and then loosen it to confirm whether the tube anode is rotating. If it is rotating, please set a small exposure condition (40 kV, 40mA, 10ms) for the first exposure as shown in Figure 3-55.

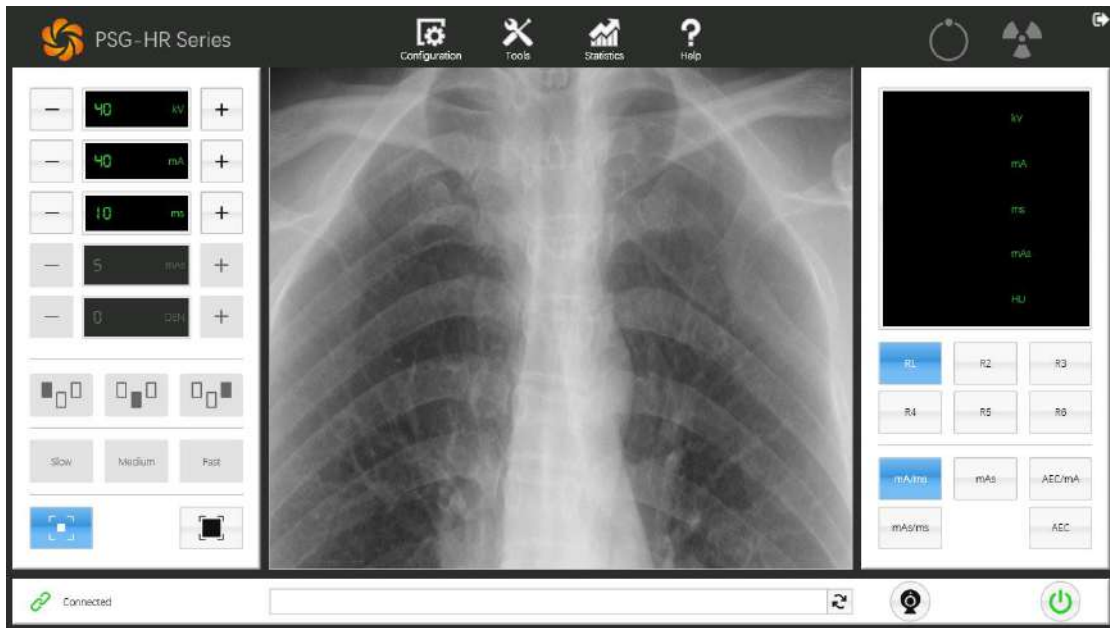

Figure 3-55 Exposure under small condition

If it can not expose properly, it is necessary to re-check whether the above mentioned wiring is correct and then check the specific fault information as shown in Figure 3-56.

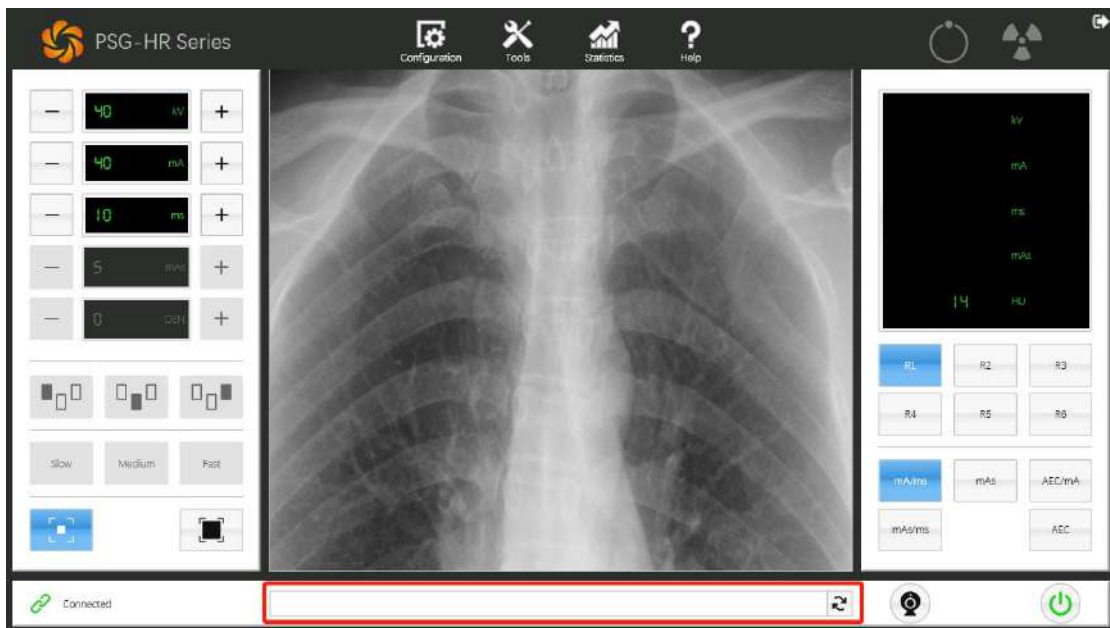

Figure3-56 Display of fault information diagram

If the exposure under small condition is normal, we need to use the service software for filament calibration, clicking "Tools" as shown in Figure 3-57.

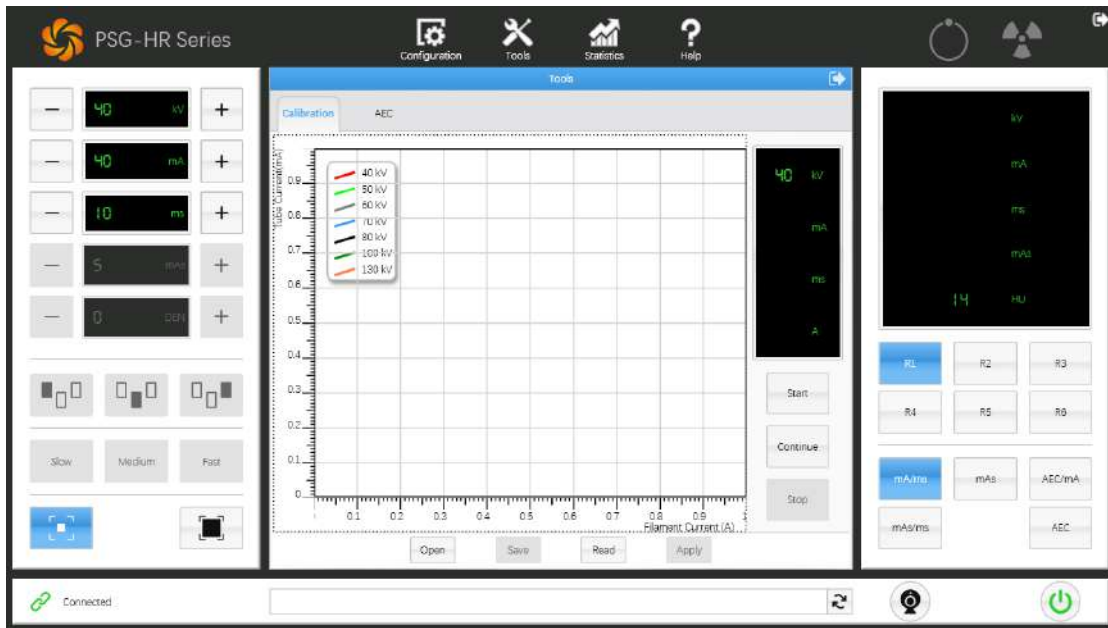

Figure3-57 Filament calibration 1

As this interface appears, we carry out filament calibration on Small focus and Large focus respectively as shown in Figure 3-58. After selecting the focus, click "Start".

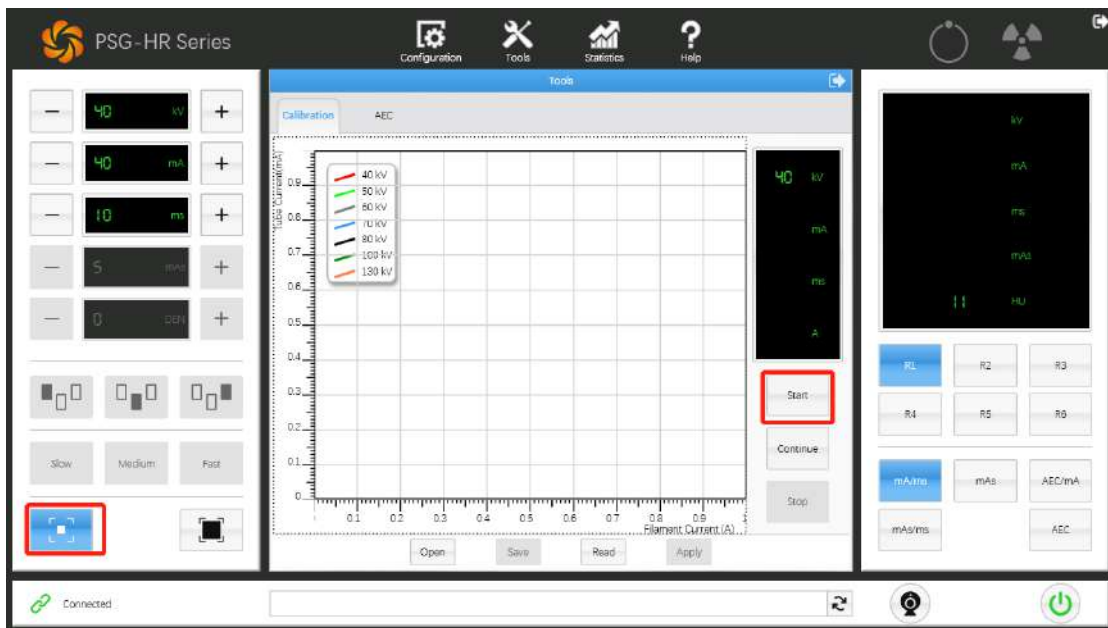

Figure3-58 Filament calibration interface 2

Clicking "Start", the Figure 3-59 dialog box appears and click" Yes" to start the filament calibration by pressing the hand switch, at this time the hand switch need to be pressed until the filament calibration is done.



Figure 3-59 Filament calibration interface 3

Filament calibration curve as shown in Figure 3-60.

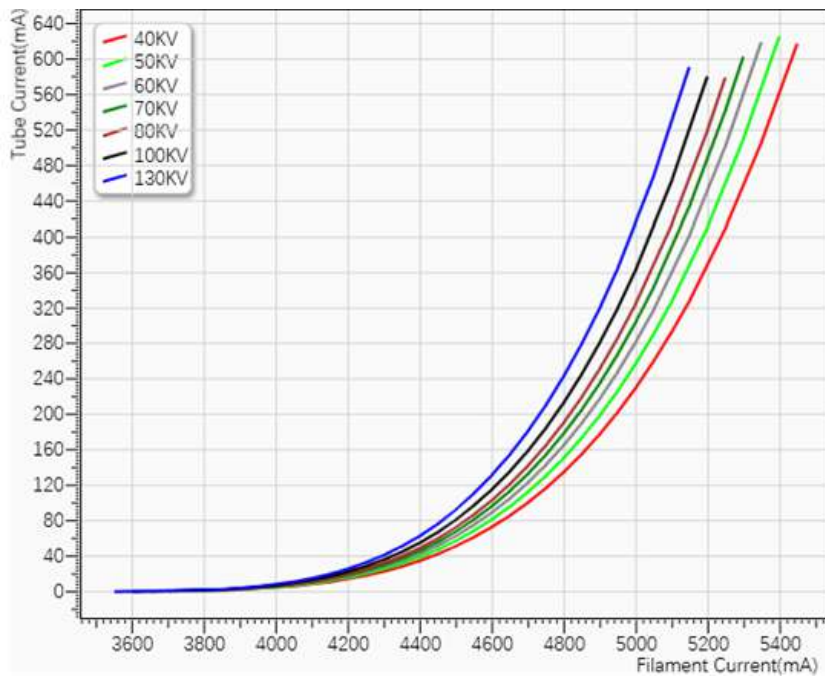

Figure3-60 Filament calibration curve

When Figure 3-61 appears, it means that one focus calibration is completed and it's ready to start the next calibration.



Figure3-61 Calibration completion prompt box

When the above mentioned operations have been completed, the customer can carry out the overall adjustment.

Medical X-ray High Voltage High Frequency Generator PSG-HR50/65/80 Manual

Part 2: Technology instruction

4. Technical overview

4.1 Scope of application

The generator is applied for providing high voltage power for medical DR system.

The medical X-ray high frequency voltage generator is used to provide a high-voltage power supply for the medical X-ray generating device, and its basic function is to output high voltage, generate filament power and anode drive power. The high voltage generator is coordinated by three independent power sources to control the tube voltage, tube current, and exposure time. 1. The high-voltage DC power supply is directly applied between the anode and the cathode of the tube to generate an electric field for electron acceleration; 2. The filament power is applied to the cathode of the tube to heat the filament to provide electrons for the medical device; 3. Rotating anode power supply at the anode of the tube, the starting and sustaining voltage of the anode of the tube is provided to rotate the anode to avoid damage to the anode of the tube.

A concise description of the medical device which includes, where relevant to its use:

1. Intended medical indication: diseases to be diagnosed;
2. Intended patient population: people of any age, any weight;
3. Intended part of body or type of tissue applied to or interacted with: Not applied;
4. Intended use environment: professional healthcare facility environment;
5. Operating principle: see details in chapter 6.

4.2 Attentions

1. The equipment needs to be installed in a power distribution cabinet with an overcurrent protection. The operator shall read the safety declaration of this manual intimately before operation and operate the equipment by following the correct operation specification. Improper operation may cause personal injury or equipment damage.
2. If it suffer from electromagnetic interference, the generator will not communicate well with the DR system so that the system may be unable to get the voltage, current, and timing data. Please shut down the power immediately if electromagnetic interference occurs.
3. Warning: Do not make any modification or alteration in this equipment without authorization. Unauthorized modification or modification may weaken the function of the equipment and reduce the safety performance, which also invalidates the manufacturer's guarantee.

4.3 Safety characters

Protection against electric shock: Class I .

Protection against degree of electric shock: N/A.

Protection against harmful ingress of water or particulate matter: IPX0.

Not AP or APG type.

4.4 Contraindications

N/A.

4.5 Technical specification:

Table 4-1 Technical specification

Box	Measurement (mm)			Weight(kg)
	Length	Width	High	
Body	523	420	475	68
Package	620	520	637	20

4.6 Working environment

This product is applied in the professional healthcare facility environment.

Working environment and shipping requirements as follow:

Table 4-2 Working environment and shipping requirements

Parameter	Working	Store and shipping
Temp (°C)	+10~+40	-20~55
Humidity (%)	30~75%	10~93%
Atmospheric pressure	70.0~106.0kPa	
Noise	60dB (A)	
Cooling type	Natural air cooling	
EMC	IEC 60601-1-2	

4.7 Electrical specification

4.7.1 Input power info. and basic parameters

Table 4-3

Model Parameter	PSG-HR80	PSG-HR65	PSG-HR50
Input voltage	380/400/440/480V a.c.	380/400/440/480V a.c.	380/400/440/480V a.c.

Phase	3N~	3N~	3N~
Input freq.	50/60Hz ± 1Hz	50/60Hz ± 1Hz	50/60Hz ± 1Hz
Rated power	80kW	65kW	50kW
Max input power	135kVA	110kVA	80kVA
Tube voltage range	40kV~150kV	40kV~150kV	40kV~150kV
Tube current range	10mA~1000mA	10mA~800mA	10mA~630mA
mAs range	0.4mAs~1000mAs	0.4mAs~1000mAs	0.4mAs~1000mAs
Loading time range	0.001s~10s	0.001s~10s	0.001s~10s
Main function	Anode variable speed control, AEC supported	Anode variable speed control, AEC supported	Anode variable speed control, AEC supported

4.7.2 Combined corresponding parameters

4.7.2.1 Maximum power combination

- 1) For continuous and intermittent mode, the maximum tube current under rated tube voltage see in Table 4-4.
- 2) For continuous and intermittent mode, the corresponding tube voltage under maximum tube current see in Table 4-5.
- 3) For continuous and intermittent mode, the combination of tube voltage and current under maximum power output see in Table 4-6.
- 4) The combination of tube voltage and current under minimum product of current and loading time see in Table 4-7.
- 5) The combination of tube voltage, tube current and loading time under rated output power see in Table 4-8.
- 6) Maximum output power combination see in Table 4-9.

4.7.2.2 The maximum current under rated tube voltage

Table 4-4

Model	Rated tube voltage in kV	Maximum tube current in mA
PSG-HR80	100	800
PSG-HR65	103	630
PSG-HR50	100	500

4.7.2.3 The maximum tube voltage obtained under maximum x ray tube current

Table 4-5

Model	Maximum tube current in mA	Corresponding tube voltage in kV
PSG-HR80	1000	80
PSG-HR65	800	81
PSG-HR50	630	79

4.7.2.4 The maximum tube voltage and current under maximum output power

Table 4-6

Model	Tube voltage in kV	Tube current in mA	Maximum power output in kW
PSG-HR80	80	1000	80
	100	800	
	126	630	
PSG-HR65	130	500	65
	103	630	
	81	800	
PSG-HR50	125	400	50
	100	500	
	79	630	

4.7.2.5 Combination of tube voltage and tube current under minimum product of current and loading time

Table 4-7

PSG-HR80/65/50		
Tube current settings	Loading time settings	Minimum mAs
(mA)	(ms)	(mAs)
10	40	0.4
12.5	32	0.4
16	25	0.4
20	20	0.4
25	16	0.4
32	12.5	0.4
40	10	0.4
50	8	0.4
63	6.3	0.4
80	5	0.4
100	4	0.4
125	3.2	0.4
160	2.5	0.4

200	2	0.4
250	1.6	0.4
320	1.25	0.4
400	1	0.4

4.7.2.6 The combination of loading time, tube voltage and tube current under the rated power

Table 4-8

Model	Setting combinations under the rated power		
	Tube voltage in kV	Tube current in mA	Loading time in ms
PSG-HR80	100	800	100
PSG-HR65	103	630	100
PSG-HR50	100	500	100

4.7.2.7 Maximum output power combination

Table 4-9

PSG-HR80	mA	1000	800	630
	kV	80	100	126
	ms	100	100	100
	kVA	80		
PSG-HR65	mA	500	630	800
	kV	130	103	81
	ms	100	100	100
	kVA	65		
PSG-HR50	mA	400	500	630
	kV	125	100	79
	ms	100	100	100
	kVA	50		

4.8 Loading factors

The loading factors should conform to the requirements of IEC60601-2-7 and follow one set of data in R'10 or R'20 series.

Table 4-10 Loading factors table

Model	PSG-HR80	PSG-HR65	PSG-HR50
-------	----------	----------	----------

Power	80kW	65kW	50kW
kV	40~150kV	40~150kV	40~150kV
mA	10~1000mA	10~800mA	10~630mA
mAs	0.4~1000mAs	0.4~1000mAs	0.4~1000mAs
ms	0.001s~10s	0.001s~10s	0.001s~10s
Step			
kV	1 kV/step Set tube voltage according to the available power output		
mA increase at R'10	10,12.5,16,20,25,32,40,50,63,80,100,125,160,200,250,320,400,500,630,800,1000 (1000 Corresponding to PSG-HR80)		
mA increase at R'20	10,11,12,5,14,16,18,20,22,25,28,32,36,40,45,50,56,63,71,80,90,100,110,125,140,160,180,200,220,250,280,320,360,400,450,500,560,630,710,800,900,1000 (1000 Corresponding to PSG-HR80)		
mAs increase at R'10	0.4,0.5,0.63,0.8,1,1.25,1.6,2,2.5,3,2.4,5,6.3,8,10,12.5,16,20,25,32,40,50,63,80,100,125,160,200,320,400,500,630,800,1000		
mAs increase at R'20	0.4,0.5,0.55,0.63,0.7,0.8,0.9,1.0,1.1,1.25,1.4,1.6,1.8,2,2.2,2.5,2.8,3.2,3.6,4,4.5,5,5.5,6.3,7.1,8,9,10,11,12.5,14,16,18,20,22,25,28,32,36,40,45,50,56,63,71,80,90,100,110,125,140,160,180,200,225,250,280,320,360,400,450,500,560,630,710,800,900,1000		
Time (ms) increase at R'10	1,1.25,1.6,2,2.5,3,2.4,5,6.3,8,10,12.5,16,20,25,32,40,50,63,80,100,125,160,200,250,320,400,500,630,800,1000,1250,1600,2000,2500,3200,4000,5000,6300,8000,10000		
Time (ms) increase at R'20	1,1.1,1.25,1.4,1.6,1.8,2.0,2.2,2.5,2.8,3.2,3.6,4,4.5,5,5.6,6.3,7.1,8,9,10,11,12.5,14,16,18,20,22,25,28,32,36,40,45,50,56,63,71,80,90,100,110,125,140,160,180,200,220,250,280,320,360,400,450,500,560,630,710,800,900,1000,1100,1250,1400,1600,1800,2000,2200,2500,2800,3200,3600,4000,4500,5000,5600,6300,7100,8000,9000,10000		

4.9 Exposure model

The generator supports manual control and AEC auto control to exposure.

Table 4-11 Exposure model table

Exposure settings	Description
mA/ms	Loading factors kV、 mA、 ms for exposure
mAs	Loading factors kV、 mAs for exposure
mAs/ms	Loading factors kV、 mAs、 ms for exposure

AEC	Loading factors kV、 backup ms and backup mAs for exposure
AEC/mA	Loading factors kV、 mA、 backup ms and backup mAs for exposure

4.10 AEC model

AEC model supports tube current and voltage combination, while the setting loading factors can verify AEC function.

Table 4-12 Manual and AEC model comparison table

Parameter/ model	Manual exposure	AEC exposure
	PSG-HR80/65/50	PSG-HR80/65/50
kV	40~150kV	40~150kV
mA	10~1000mA	10~1000mA
mAs	0.4~1000mAs	0.4~600mAs
Time	0.001~10s	N/A
kV	1kV/Step adjusting according to the output power	1kV/Step adjusting according to the output power
mA R'10	10,12.5,16,20,25,32,40,50,63,80,100,125,160,200,250,320,400,500,630,800,1000 (1000 Corresponding to PSG-HR80)	10~1000mA
mA increase at R'20	10,11,12,5,14,16,18,20,22,25,28,32,36,40,45,50,56,63,71,80,90,100,110,125,140,160,180,200,220,250,280,320,360,400,450,500,560,630,710,800,900,1000 (1000 Corresponding to PSG-HR80)	10~1000mA
mAs increase at R'10	0.4,0.5,0.63,0.8,1,1.25,1.6,2,2.5,3,2,4,5,6,3,8,10,12.5,16,20,25,32,40,50,63,80,100,125,160,200,320,400,500,630,800,1000	0.4~600mAs (the maximum 600 mAs, forbidden manual adjusting)
mAs increase at R'20	0.4,0.5,0.55,0.63,0.7,0.8,0.9,1.0,1.1,1.25,1.4,1.6,1.8,2,2.2,2.5,2.8,3.2,3.6,4,4.5,5,5.5,6.3,7.1,8,9,10,11,12.5,14,16,18,20,22,25,28,32,36,40,45,50,56,63,71,80,90,100,110,125,140,160,180,200,225,250,280,320,360,400,450,500,560,630,710	0.4~600mAs (the maximum 600 mAs, forbidden manual adjusting)

	10,800,900,1000	
Time (ms) increase at R'10	1,1.25,1.6,2,2.5,3.2,4,5,6.3,8,10,12.5,16,20,25, 32,40,50,63,80,100,125,160,200,250,320,400,5 00,630,800,1000,1250,1600,2000,2500,3200,4 000,5000,6300,8000,10000	N/A
Time (ms) increase at R'20	1,1.1,1.25,1.4,1.6,1.8,2.0,2.2,2.5,2.8,3.2,3.6,4,4 .5,5.5,5.6,6.3,7.1,8,9,10,11,12.5,14,16,18,20,22,2 5,28,32,36,40,45,50,56,63,71,80,90,100,110,12 5,140,160,180,200,220,250,280,320,360,400,4 50,500,560,630,710,800,900,1000,1100,1250,1 400,1600,1800,2000,2200,2500,2800,3200,360 0,4000,4500,5000,5600,6300,7100,8000,9000, 10000	N/A

4.11 Ionization chamber port

The generator supports two ionization chamber channels.

4.12 High voltage power

The generator coordinated through three independent power sources to control the tube voltage, tube current, and exposure time.

4.12.1 High voltage DC power

The high voltage DC power, added between the anode and cathode of X-ray tube, generate an electrical field to accelerate the electrons to generate X-Ray.

Table 4-13 X-ray Tube attention

Tube type	Class 1 B
Tube quantity	one X-Ray tube
Tube data	Tube data loaded via service software
Filament	Configured by tube configuration
Tube power reduction	Power reduction may prolong the tube life(Eliminate other special conditions)

4.12.2 Filament power

The filament power supply, added to the cathode, heat up the filament to generate electrons.

4.12.3 Rotated anode power

The rotated anode power, added to the anode of the tube, provides start-up and maintain voltage to rotate the anode to avoid tube anode being damaged.

Under RAD model, the generator can control the rotating speed of anode according to the exposure power. The following table lists the speed model under different conditions. Once exposure power exceed the limits, the generator will automatically switch the speed model from low to high.

Table 4-14 Auto speed selection table

exposure time (ms)	power for small focus at low speed (kW)	power for small focus at high speed (kW)	power for main focus at low speed (kW)	power for small focus at high speed (kW)
1	20.00	27.00	50.00	65.00
1.25	20.00	27.00	50.00	65.00
16	20.00	27.00	50.00	65.00
2	20.00	27.00	50.00	65.00
2.5	20.00	27.00	50.00	65.00
3.2	20.00	27.00	50.00	65.00
4	20.00	27.00	50.00	65.00
5	20.00	27.00	50.00	65.00
6.3	20.00	27.00	50.00	65.00
8	20.00	27.00	50.00	65.00
10	20.00	27.00	50.00	65.00
12.5	20.00	27.00	50.00	65.00
16	20.00	27.00	50.00	65.00
20	20.00	27.00	50.00	65.00
25	20.00	27.00	50.00	65.00
32	20.00	27.00	50.00	65.00
40	20.00	27.00	50.00	65.00
50	20.00	27.00	50.00	65.00
63	20.00	27.00	50.00	65.00
80	20.00	27.00	50.00	65.00
100	20.00	27.00	50.00	65.00

125	20.03	26.70	48.00	64.00
160	19.43	25.90	47.25	63.00
200	18.75	25.00	46.13	61.50
250	18.08	24.10	45.00	60.00
320	17.55	23.40	42.90	57.20
400	16.88	22.50	40.50	54.00
500	16.20	21.60	37.50	50.00
630	15.60	20.80	35.10	46.80
800	14.48	19.30	31.88	42.50
1000	13.88	18.50	28.13	37.50
1250	12.75	17.00	26.40	35.20
1600	12.23	16.30	24.60	32.80
2000	11.25	15.00	23.85	31.80
2500	10.43	13.90	21.00	28.00
3200	9.38	12.50	20.25	27.00
4000	8.33	11.10	19.17	25.56
5000	8.03	10.70	18.08	24.10
6300	7.35	9.80	16.50	22.00
8000	6.60	8.80	14.48	19.30
10000	5.78	7.70	11.33	15.10

4.13 I/O Specification

4.13.1 I/O Input

The generator's inputs are all located at interface board as all the logic input interfaces are isolated by double optocouplers, as shown in Figure 4-1. The primary windings of double optocouplers, as the same as the subsidiary windings, are series connections.

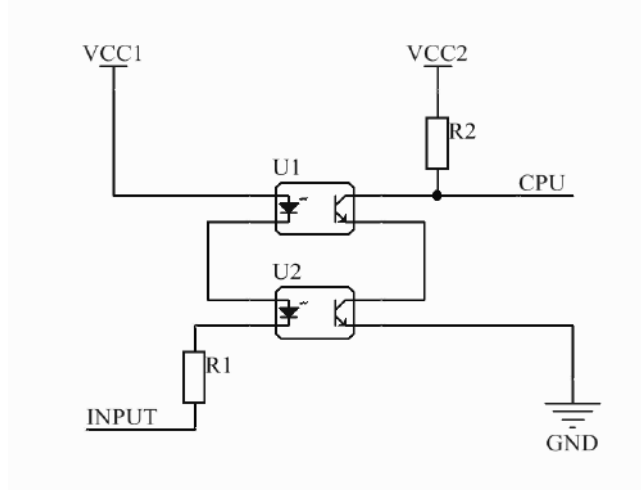

Figure 4-1 Double optocouplers input circuit

4.13.2 I/O Output

The generator's outputs are all located at interface board. All the logic inputs are isolated by single optocoupler, as shown in Figure 4-2. The output type is DRHOT.

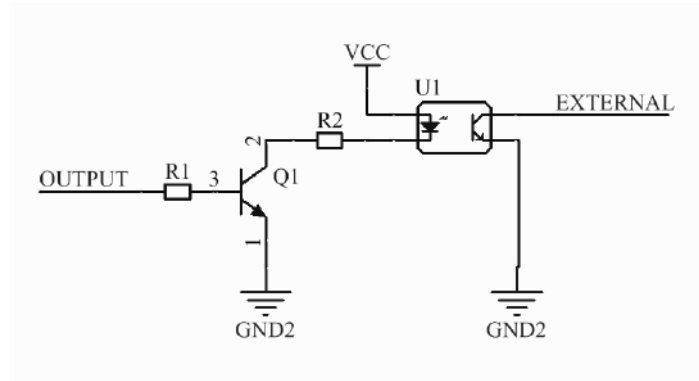

Figure 4-2 Single optocoupler output circuit

4.14 Product structure

The Medical X ray high frequency high voltage generator consists of control software (version V1) and DR high voltage generator mainframe.

The DR high voltage generator mainframe consists of enclosure, PCBA assembly, Rectifier assembly, resonant assembly and Tank.

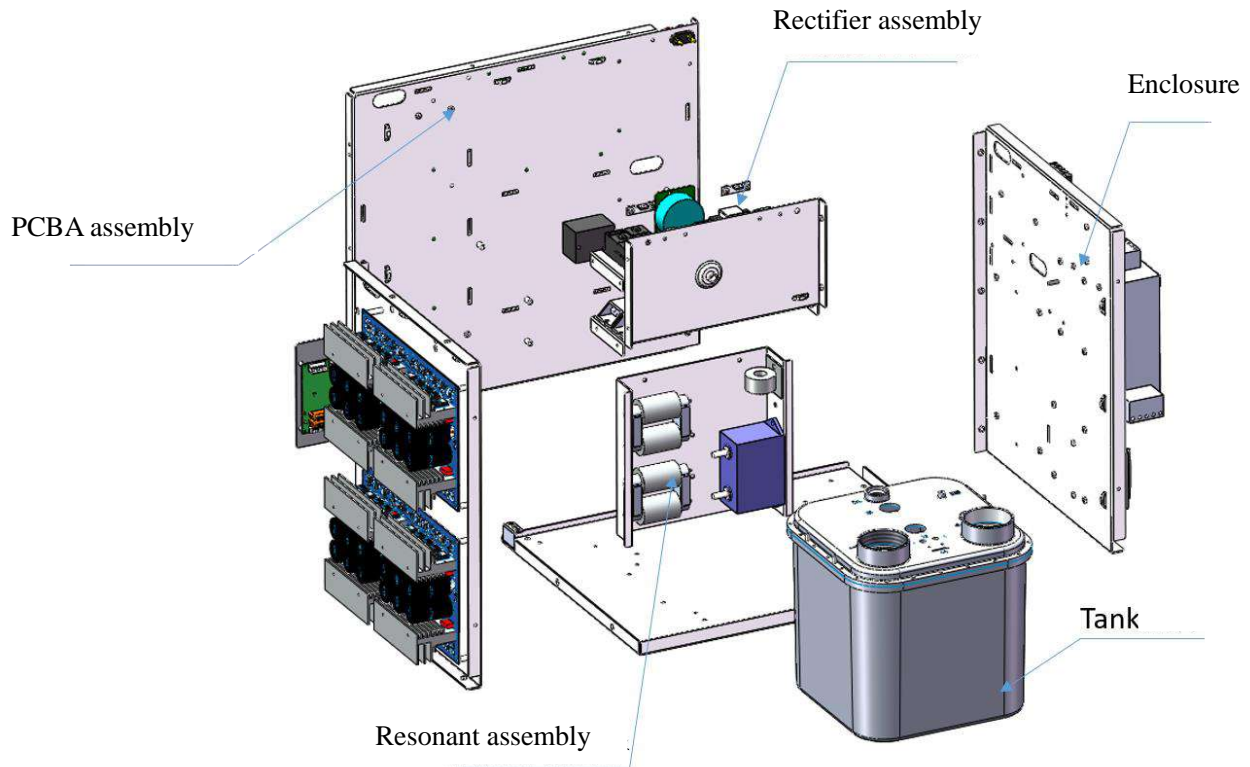

Figure 4-3 Product structure

4.15 The lifetime of product

The lifetime of product is verified for ten years.

4.16 Operation Mode

Continuous operation with intermittent loading

4.17 Accuracy of loading factors

a Deviation of tube voltage shall not be more than $\pm(5\%+1\text{kV})$;

b Deviation of tube current shall not be more than $\pm 20\%$;

c Deviation of mAs shall not be more than $\pm(10\% + 0.2\text{mAs})$;

d Deviation of loading time shall not be more than $\pm(10\% + 1\text{ms})$.

5. Maintenance

5.1 Replacement and repairment

1. Ensure that the circuit breaker is off;
2. Remove the enclosures.

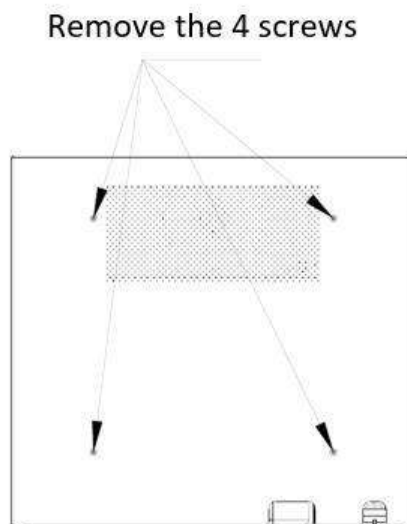

Figure 5-1 Letter Plate Disassembly Figure

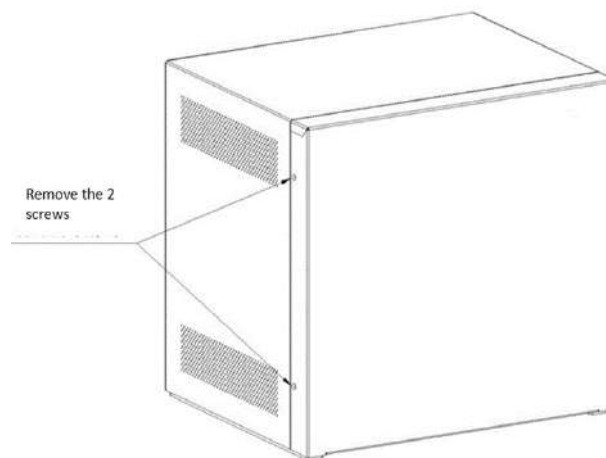

Figure 5-2 Front Plate Disassembly Figure 1

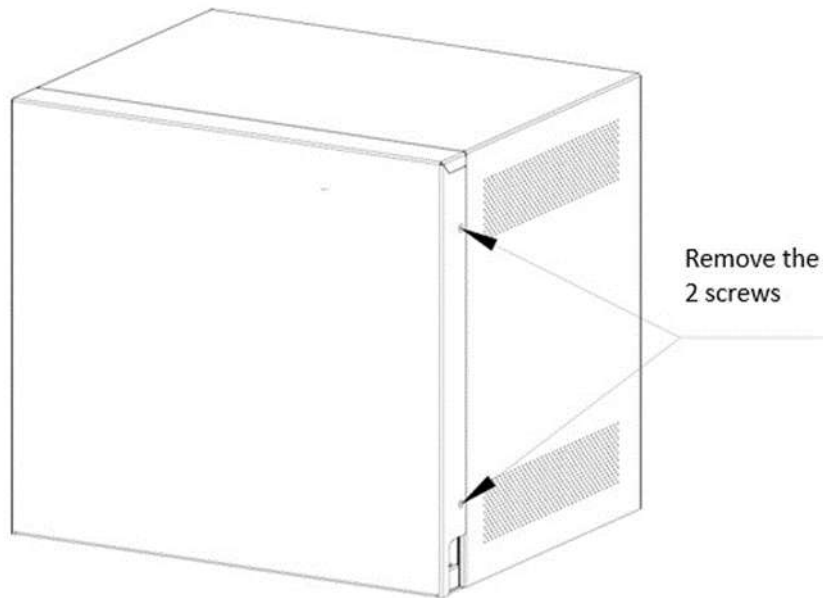

Figure 5-3 Front Plate Disassembly Figure 2

5.1.1 Fuse replacement

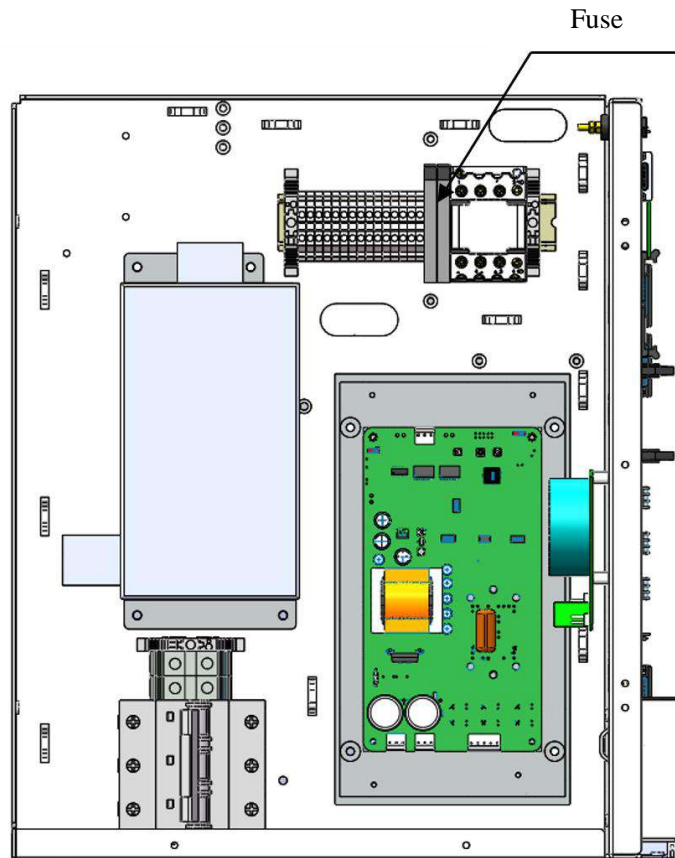

Figure 5-4 Fuse replacement

As shown in Figure 5-4, Opening the top cover of the fuse holder, replace the fuse with a new one. The fuse model is R055.

5.1.2 PCBA replacement

Please make sure that the main bus voltage is below 36V before replacement.

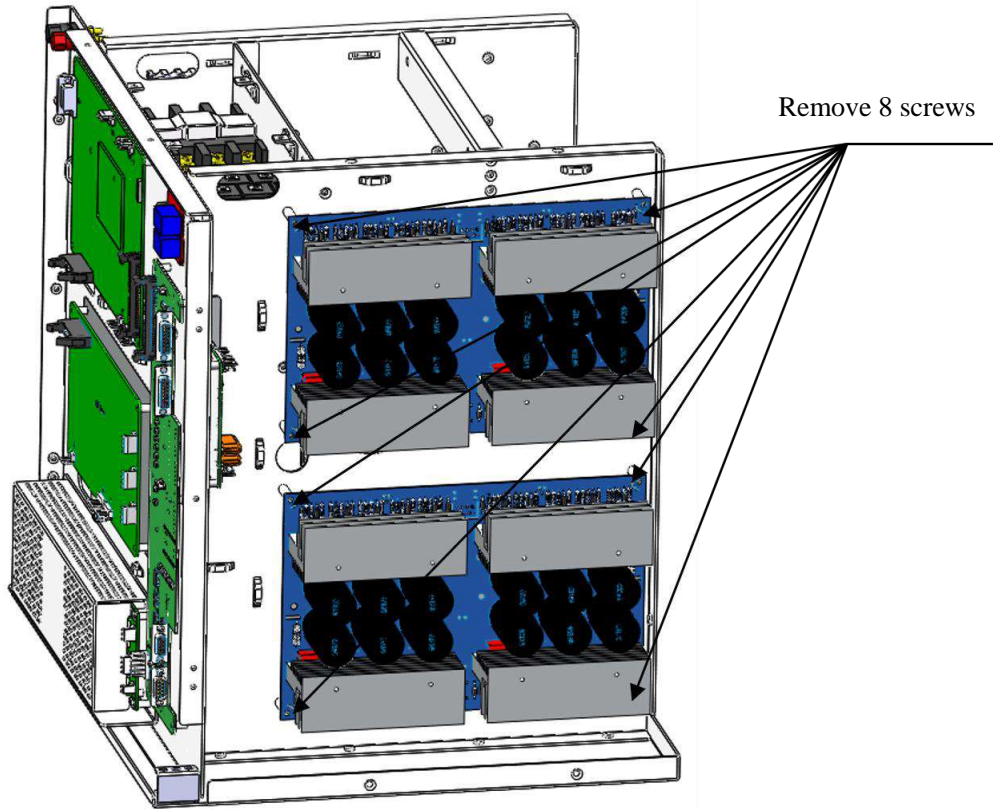

Figure 5-5 Inverter board replacement

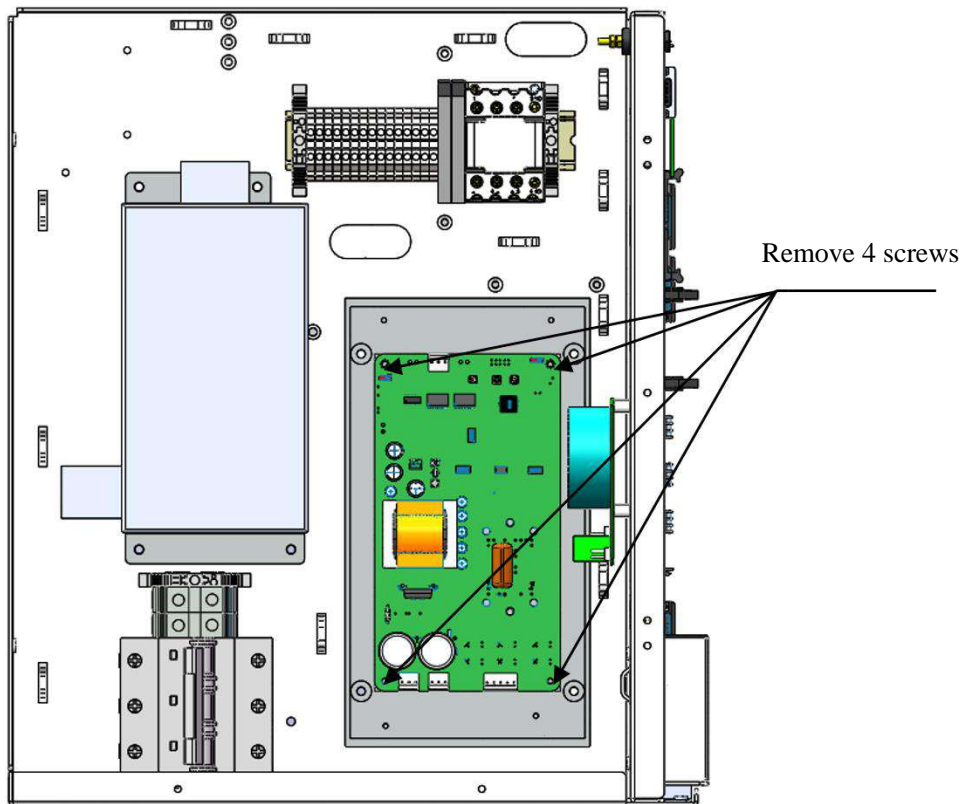

Figure 5-6 Rotated anode board replacement

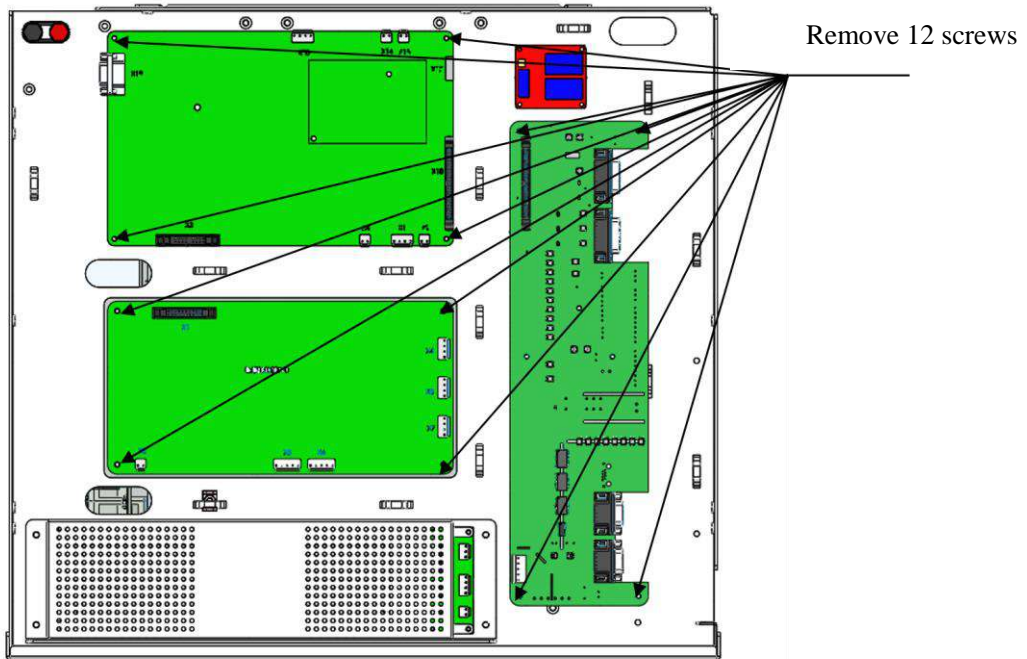

Figure 5-7 main control board, filament board and interface board replacements

5.1.3 Tank replacement

1. Make sure the circuit breaker is off before replacement;
2. Remove the enclosures;
3. Replace the tank.

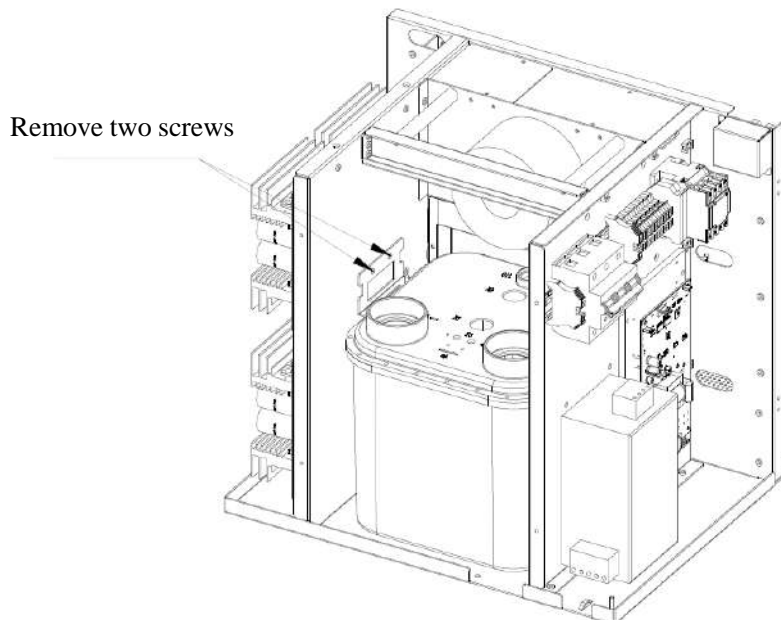

Figure 5-8 Tank replacement 1

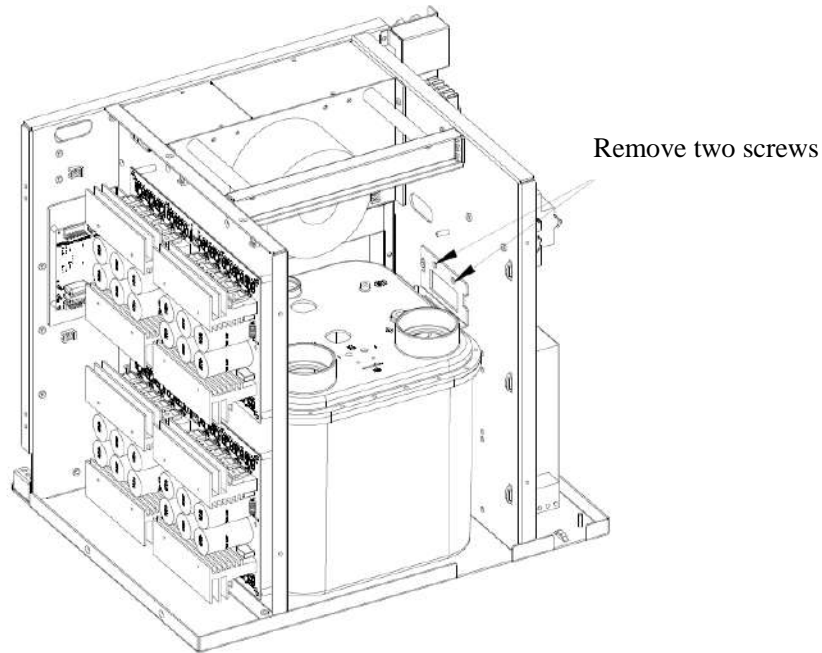

Figure 5-9 Tank replacement 2

5.2 Maintenance

Make sure all labels and signs on the generator are clean and recognizable after power-off.

5.2.1 Visual inspection

1 labels inspection

Make sure whether all labels and signs on the generator are not falled out and blurred after power-off.

2 Cables inspection

Check whether any cables were burned after power-off.

5.2.2 Cleaning

Check every two years whether there's any dust on the anode board, filament board, main control board and interface board.

Make sure the generator has powered off, totally discharged, and connected safety earthing before cleaning the board using a cleaner (Note: When cleaning, please use a paperboard shielding the switching power supply to avoid dust).

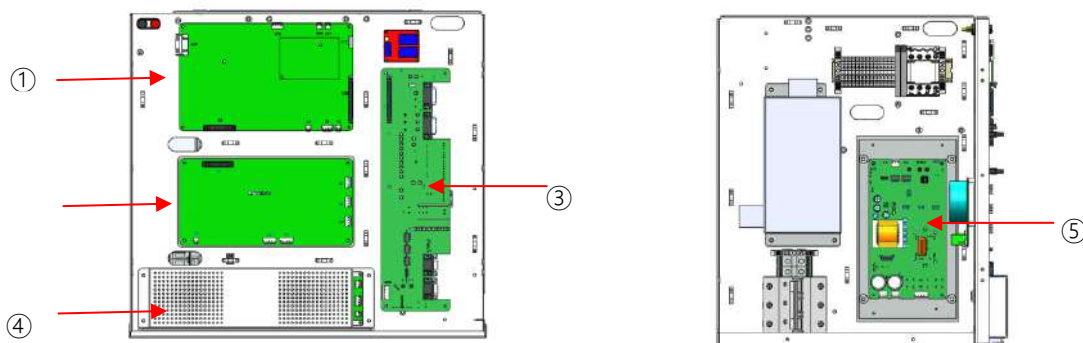

Figure 5-10

Note: ①Main control board ②Filament board ③Interface board ④Switching power supply ⑤anode board

5.2.3 Insulating Silicone Grease

High voltage plug using tips:

If there is a strick, please apply insulating silicone grease on the surface of the high voltage plug.

- 1) Clean the surface of the high voltage plug and the black seal ring;
- 2) Stack the black seal ring on the bottom of the high voltage plug;
- 3) The insulating silicone grease should evenly coated on the surface of the high voltage plug, with the length of the silicone grease is about 20 mm.

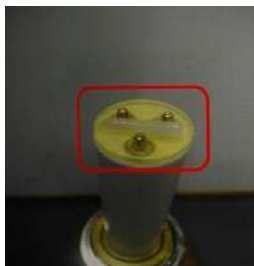

Figure 5-11

5.2.4 Regular calibration

It is recommended that perform a filament calibration every six months.

5.2.5 Waste Disposal

Please return the replaced PCBA to the manufacturer

5.2.6 Environment protection

Disposal of waste oil (the insulating oil in the generator) must be strictly in accordance with the laws and regulations of the local environmental department.

5.3 Packing List

Table 5-1

No.	Objects	Quantity	Notes
1	<input type="checkbox"/> HV generator	1	
2	<input type="checkbox"/> Testing report	1	
3	<input type="checkbox"/> Quality inspection report	1	
4	<input type="checkbox"/> 600-00027 PSG-HR Accessories	1	
5	<input type="checkbox"/> Packing list	1	
6	<input type="checkbox"/> QC certificate	1	
7	<input type="checkbox"/> Drier	5	

6. Principles

The Medical X-ray high frequency high voltage generator consists of control software (version V1) and DR high voltage generator mainframe.

The DR high voltage generator mainframe consists of enclosure, PCBA assembly, Rectifier assembly, resonant assembly and Tank.

High voltage control electric circuit gets power from DC bus. Alternating square wave voltage is generated when the DC bus is reversed. The energy is transferred to the high voltage transformer with LC resonant circuit. The high frequency low voltage is pressed into a high frequency high voltage through a high voltage transformer. Then the AC is converted to high voltage DC with a voltage multiplier. The ripple is removed by high pressure filtering and output to the X-ray tube. Different operating frequencies correspond to different voltage gains, so that different frequencies can be controlled to generate corresponding power.

Filament control electric circuit gets power from DC bus. Alternating square wave voltage is generated when the DC bus is reversed. The energy is transferred to the filament transformer. The high frequency voltage is pressed into a high frequency low voltage through a low voltage transformer. And output to the filament of the X-ray tube. Different output duty ratios correspond to different voltage gains, so that the output duty ratio can be controlled to control the filament current acting on the X-ray tube.

Anode driver control electric circuit gets power from DC bus. Alternating square wave voltage is generated when the DC bus is reversed. The energy is transferred to the rotor of the X-ray tube. Different output duty ratios correspond to different voltage gains, so that the output duty ratio can be controlled to control the voltage acting on the rotor of the X-ray tube.

6.1 Schematic diagram

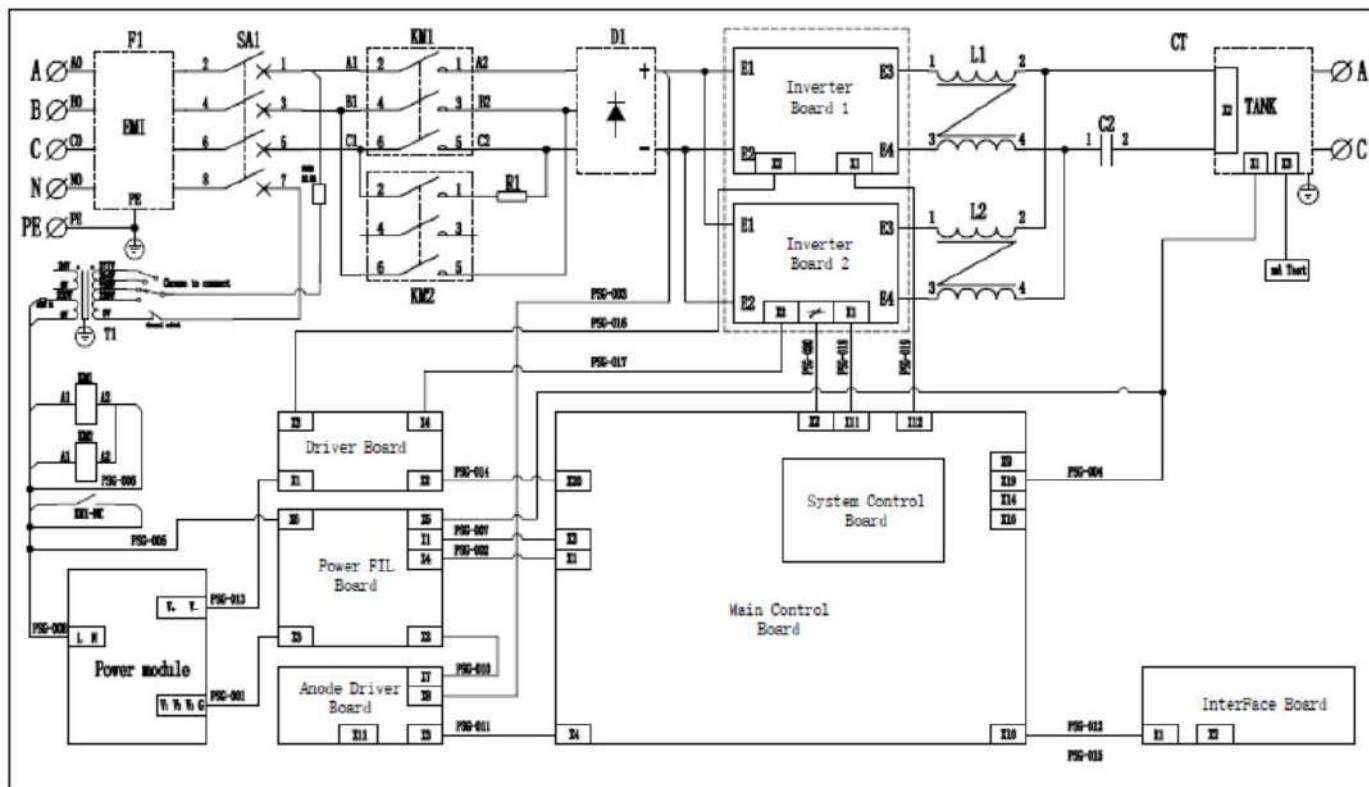

Figure 6-1 Schematic diagram

6.2 List of key materials

No.	material name	MPN
1	3P Circuit breaker	Circuit breaker, 5SP4380-7
2	Power Filter	Three Phase Four wire filter 30A Q319-30FT1
3	Transformer	460W 220V-230V-254V-277V input, 24V-220V dual output
4	Fuse	Fuse RO55 5×25mm 2A 250V
5	Rectifier bridge	Three Phase rectifier bridge MDS150-16, 150A 1600V W540
6	PCBA inverter 65K LOCAL	Inverter_Board
7	Tank	HR-65
8	PCBA anode driver-HR1	Anode_Driver_Board
9	PCBA filament board	Power_FIL_Board
10	PCBA main control board accessories -HR1	Main_Control_Board
11	PCBA system board accessories-HR2	System_Control_Board
12	PCBA driver board	Driver_Board
13	PCBA interface board	InterFace_Board
14	Power cable groups	Power cables for PSG-65HR
15	Control cable groups	Control cables for PSG-65HR
16	Switch power supply	PSG-HR Switch power supply

7. EMC

7.1 Attentions and Warnings



Attentions:

- PSG-HR series of medical X ray high frequency high voltage generators meet the requirements of standard of electromagnetic compatibility in IEC 60601-1-2.
- PSG-HR series of medical X - ray high-frequency high-voltage generators are suitable for use in all locations other than those allocated in residential environments and those directly connected to a low voltage power supply network which supplies buildings used for domestic purposes, namely class A according to CISPR 11.
- Note: the emissions characteristics of this equipment make it suitable for use in industrial areas and hospitals (CISPR 11 class A). If it is used in a residential environment (for which CISPR 11 class B is normally required) this equipment might not offer adequate protection to radio-frequency communication services. The user might need to take mitigation measures, such as relocating or re-orienting the equipment.
- Manufacturer applied improved shielding techniques and improved grounding technology to prevent electromagnetic interference from patients and operators.
- Portable and mobile RF communication equipments (including antennas) may affect the performance of the generators. Therefore please keep away from mobile phones, microwave ovens etc. to avoid strong electromagnetic interference.
- Portable RF communications equipment (including peripherals such as antenna cables and external antennas) should be used no closer than 30 cm (12 inches) to any part of the generator, including cables specified by the manufacturer, otherwise it may result in the decline of the performance.



Warnings:

- The equipment should not be used close to or stacked with other equipment, see details in clause 9.3.6.
- Make sure there isn't potential difficulties in electromagnetic compatibility in other environments due to conducted and radiated interference by the generator.
- Replacing with unauthorized accessories may cause the performance decline.

7.2 Tests

Table 7-1 Compliance information for each test

Phenomenon	Basic EMC standard or test method	Immunity test levels
		Professional healthcare facility environment
Electrostatic Discharge	IEC 61000-4-2	± 2 kV, ± 4 kV, ± 6 kV, ± 8 kV contact

		± 2 kV, ± 4 kV, ± 8 kV, ± 15 kV air
Radiated RF EM fields	IEC 61000-4-3	3 V/m 80MHz-2.7GHz 80% AM at 1kHz
Proximity fields from RF wireless communications equipment	IEC 61000-4-3	See Tablele 7-3
Rated power frequency magnetic fields	IEC 61000-4-8	30 A/m 50Hz or 60Hz
Phenomenon	Basic EMC standard or test method	Immunity test levels
		Professional healthcare facility environment
Electrical fast transients/bursts	IEC 61000-4-4	± 2 kV (AC) ± 1 kV (Signal Line) 100 kHz repetition frequency
Surges line to line	IEC 61000-4-5	± 0.5 kV, ± 1 kV
Surges line to ground	IEC 61000-4-5	± 0.5 kV, ± 1 kV, ± 2 kV
Conducted disturbances induced by RF fields	IEC 61000-4-6	3V 0.15MHz-80MHz 6V in ISM bands between 0.15 MHz an 80 MHz 80% AM at 1 kHz
Voltage dips	IEC 61000-4-11	0% U_T ; 0.5cycle At 0°, 45°, 90°, 135°, 180°, 225°, 270°, and 315°,
		0% U_T ; 1cycle and 70% U_T ; 25/30 cycles Single phase: at 0°
Voltage interruption	IEC 61000-4-11	0% U_T ; 250/300 cycles

(Corresponding to Table 4 & Table 5 of IEC 60601-1-2 2014)

Table 7-2 Frequency range and level for proximity fields from RF wireless communications equipment

Test Frequency (MHz)	Modulation	Immunity test level (V/m)
385	Pulse Modulation: 18Hz	27
450	FM ± 5 Hz deviation: 1kHz sine	28
710 745 780	Pulse Modulation: 217Hz	9
810 870 930	Pulse Modulation: 18Hz	28
1720 1845 1970	Pulse Modulation: 217Hz	28
2450	Pulse Modulation: 217Hz	28
5240 5500 5785	Pulse Modulation: 217Hz	9

Table 7-3 Electromagnetic radiation disturbance limits for class A group 1 equipment measured on a test site

Frequency range (MHz)	Limit dB (10 m measuring distance rated power of ≤ 20 kVA)
	Quasi-Peak dB(μ V/m)
30 to 230	40
230 to 1000	47

Tablele 7-4 Conducted disturbances limits for class A group 1 equipment measured on a test site (a. c. mains power port)

Frequency range (MHz)	Limit dB (rated power of ≤ 20 kVA)	
	Quasi-Peak dB(μ V)	Average dB(μ V)
0.15 to 0.50	79	66
0.50 to 5	73	60
5 to 30	73	60

7.3 Other notices

- 1) When the rated input power is more than 20kVA, the generator can not be connected to the low-voltage overhead wire.
- 2) When the rated input power is more than 20kVA, the generator should keep at least 30m away from other Radio communications facilities.

8. Packaging and shipping

The packaging should comply with the requirements in 《IEC 60601-1 Medical electrical equipment-part 1: General requirements for basic safety and essential performance》.

9. Safe operation requirement

9.1 Interpretation of Graphics, Symbols and Abbreviations

9.1.1 General warning



Neglect of the procedure indicated in the manual may cause serious injury. Please be careful when accessing, testing or repairing the generator.

9.1.2 Protective Earthing



The high voltage generator must be connected with a protective earthing conductor. Failure to provide separate earthing may result in electrical shock and cause injury.

9.1.3 Electrical shock hazard



All removable components and parts in generator shall be operated with caution and routinely checked. Only trained personnel is allowed to operate the generator. The live terminal may lead to the danger of electric shock. Ensure the circuit breaker is disconnected before wiring and take corresponding preventive measures. The high voltage cables can only be removed from the tube and the tank until 10 minutes after power off.

9.1.4 Enforcement



Operators shall comply with the mandatory normative measures for safety concerns.





9.1.5 Refer to instruction manual/ booklet

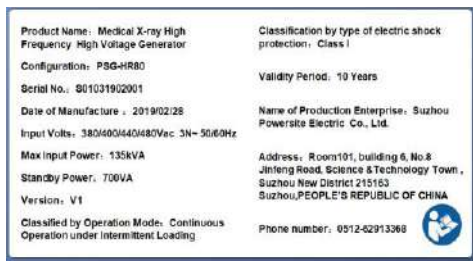

Follow the instructions for use.

9.2 Label instruction

Table 9-1 Label list

NO.	Label name	Sample
1	Discharge warning	
2	Nameplate	
3	QC certificate	
4	Enclosure warning label	
5	Heavy object warning	

9.3 Outer packaging marking

9.3.1 CENTER OF GRAVITY



This is the center of gravity of the distribution packages which will be handled as a single unit.

9.3.2 FRAGILE, HANDLE WITH CARE



Contents of the distribution packages are fragile therefore it shall be handled with care.

9.3.3 DO NOT ROLL



Distribution packages shall not be rolled or turned over.

9.3.4 KEEP AWAY FROM RAIN



Distribution packages shall be kept away from rain and be kept in dry conditions.

9.3.5 THIS WAY UP



This is the correct upright position of the distribution packages for transport and/or storage.

9.3.6 TEMPERATURE LIMITS



Distribution packages shall be stored, transported, and handled within temperature limits indicated.

9.3.7 STACKING LIMIT BY NUMBER



Maximum number of identical transport packages/items which may be stacked on the bottom package, where “n” is the limiting number.

10. Error removal

10.1 Error management

10.1.1 Exposure limits

When the exposure setting conditions exceed the limits, the generator will exposure at the limited condition.

10.1.2 Interlock condition

No exposure while the interlock take effort.

10.1.3 Diagnostic mode

The following diagnostic information will appear while the error occurred;

- 1) Error prompted the main contactor cannot be pulled in when power on.
- 2) Error prompted the interlock can not feed back.
- 3) Error prompted the feedback value of filament is not consistent with the settings.
- 4) Error prompted the anode driver wiring is disconnected.
- 5) Error prompted the hand switch was released during exposure.
- 6) Error prompted the temperature of tube reach its limited T.

11. Regulatory information

11.1 Declaration of conformity

This equipment belongs to medical electrical equipment and meets the requirements of IEC 60601-2-54: 2009.

This equipment about radiation protection meets the requirements of IEC 60601-1-3-2008+A11-2016.

11.2 Regulatory standards

- [1].IEC 60601-1 Medical electrical equipment-part 1: General requirements for basic safety and essential performance.
- [2].IEC 60601-1-2 Medical electrical equipment-part 1-2: General requirements for basic safety and essential performance-collateral standard: Electromagnetic disturbances-Requirements and tests.
- [3].IEC 60601-2-7 Medical electrical equipment-part 2-7: Particular requirements for the safety of high-voltage generators of diagnostic X-ray generators.
- [4].ISO 14971 Medical devices-Application of risk management to medical device.
- [5].IEC 62304 Medical device software – Software life cycle processes.
- [6].IEC 60601-1-6 Medical electrical equipment-part 1-6: General requirements for basic safety and essential performance – Collateral standard: Usability.
- [7].IEC 62366-1: Medical device – Part 1: Application of usability engineering to medical devices.
- [8].IEC 61558-1 Safety of transformers, reactors, power supply units and combinations thereof - Part 1: General requirements and tests.
- [9].IEC 60601-2-54 Medical electrical equipment – Part 2-54: Particular requirements for the basic safety and essential performance of X-ray equipment for radiography and radioscopy.
- [10].IEC 60601-1-3 Medical electrical equipment – Part 1-3: General requirements for basic safety and essential performance – collateral standard: radiation protection in diagnostic X-ray equipment.

Appendix 1 Anode transfer board definition

Name	Function	Pin No.	Definition	Description
P1	Anode driving and heat switch	pin1	Com	The middle point of motor of X-ray tube anode
		pin2	Main	The main winding of motor of X-ray tube anode
		pin3	Shift	The additional winding of motor of X-ray tube anode
		pin4	PE	PE
		pin5	T2	Ground in heat switch
		pin6	T1	The heat switch in X-ray tube. The alarm rang when the heat capacity exceed the limited value.

Appendix 2 Interface board definition

Name	Function	Pin No.	Definition	Description
P1	External logical signal connection	pin1	EXP_REQ_1	Logic signal from generator to detector 1
		pin2	GND_24VDC	Ground
		pin3	24VDC	24VDC
		pin4	GND_24VDC	Ground
		pin5	EXP_OK_1	Logic signal from detector1 to generator
		pin6	GND_24VDC	Ground
P2	External logical signal connection	pin1	EXP_REQ_2	Logic signal from generator to detector 2
		pin2	GND_24VDC	Ground
		pin3	24VDC	24VDC
		pin4	GND_24VDC	Ground
		pin5	EXP_OK_2	Logic signals from detector 2 to high voltage
		pin6	GND_24VDC	Ground
P3	Door position signal/Interlock	pin1	DOOR_OPEN	Interlock, door open signal
		pin2	\	\
		pin3	GND_24VDC	Ground
P4	Door indicator control	pin1	roomlightA	Imaging room warning lights signalA
		pin2	roomlightB	B Imaging room warning lights signalB
P5	\	\	\	\
		\	\	\
		\	\	\
		\	\	\
		\	\	\
		\	\	\
P6	AEC CH1 control	pin1	\	\
		pin2	\	\
		pin3	\	\

		pin4	\	\
		pin5	GND	Grounding
		pin6	PTRAMP1	Analog input from ionization chamber to high voltage generator
		pin7	GND	Ground
		pin8	AEC_START	Ionizing chamber reset/start signal
		pin9	AEC_LFDSEL	Left Field Selection in Ionizing chamber
		pin10	AEC_MFDSEL	Ionizing room midfield selection
		pin11	AEC_RFDSEL	Right field selection in ionization chamber
		pin12	GND	Ground
		pin13	VCC-15V	Negative power supply to ionization chamber
		pin14	GND	Ground
		pin15	VCC+15V	Positive power supply to ionization chamber
P7	+24Vcc and Grounding	pin1	+24VDC	24VDC
		pin2	\	\
		pin3	GND_24VDC	Ground
P8	Indicator and buzzer output	pin1	PREP_LED	Logical signals output to outside during system preparing
		pin2	GND_24VDC	Ground
		pin3	XRAY_LED	Logical signals output to outside during system exposure
		pin4	GND_24VDC	Ground
		pin5	EXP_BUZZER	Logical signals output to outside during system exposure
		pin6	GND_24VDC	Ground
P9	AEC CH2 control	pin1	\	\
		pin2	\	\
		pin3	\	\

		pin4	\	\
		pin5	GND	Ground
		pin6	PTRAMP2	Analog input from ionization chamber to high voltage generator
		pin7	GND	Ground
		pin8	AEC_START	Ionizing chamber reset/start signal
		pin9	AEC_LFDSEL	Left Field Selection in Ionizing Room
		pin10	AEC_MFDSEL	Ionizing room midfield selection
		pin11	AEC_RFDSEL	Right field selection in ionization chamber
		pin12	GND	Ground
		pin13	VCC-15V	Negative power supply to ionization chamber
		pin14	GND	Ground
		pin15	VCC+15V	Positive power supply to ionization chamber
P10	emergency stop button	pin1	INTERLOCK_HV	Emergency break
		pin2	\	\
		pin3	GND_24VDC	Ground
P11	Serial communication	pin1	\	\
		pin2	TXD_ISO	Isolated serial Communication Terminal
		pin3	RXD_ISO	Isolated serial Communication Terminal
		pin4	\	\
		pin5	GND_UART	Isolated ground
		pin6	\	\
		pin7	PREP_ISO	Exposure ready
		pin8	XRAY_ISO	Exposure
		pin9	\	\
P12	RJ45Communication	pin1	RXD_ISO_RJ45	Isolated serial Communication Terminal
		pin2	TXD_ISO_RJ45	Isolated serial Communication Terminal
		pin3	GND_UART	Isolated ground

		pin4	PREP_ISO	Prepare logic signal from system isolated from generator internal signal
		pin5	XRAY_ISO	An exposure logic signal from the system that is isolated from the signal inside the generator
		pin6	POWER_ON	On boot logic signal from the system that is isolated from the signal inside the generator
		pin7	POWER_OFF	Shutdown logic signal from system isolated from generator internal signal
		pin8	+5V_ISO	5v isolated power
P13	DAP function	pin1	\	\
		pin2	RXD_DAP	DAP receive
		pin3	TXD_DAP	DAP sent
		pin4	\	\
		pin5	GND_UART	Ground
		pin6	\	\
		pin7	\	\
		pin8	\	\
		pin9	\	\
P14	CAN Communication	pin1	CANL	CAN Low
		pin2	CANH	CAN High
P15	Transformer Overheat	pin1	T_HOT	Transformer Overheating Signal
		pin2	GND_T	Ground

Appendix 3 Parameters range

Parameters	Range and step	Unit
kV	40-150, Minimum step voltage: 1kV	kV
mA increase at R'10	10,12.5,16,20,25,32,40,50,63,80,100,125,160,200,250,320,400,500,630,800,1000 ((1000 refer to PSG-HR80))	mA
mA increase at R'20	10,11,12,5,14,16,18,20,22,25,28,32,36,40,45,50,56,63,71,80,90,100,110,125,140,160,180,200,220,250,280,320,360,400,450,500,560,630,710,800,900,1000 (1000 refer to PSG-HR80))	mA
mAs increase at R'10	0.4,0.5,0.63,0.8,1,1.25,1.6,2,2.5,3,2,4,5,6,3,8,10,12.5,16,20,25,32,40,50,63,80,100,125,160,200,320,400,500,630,800,1000	mAs
mAs increase at R'20	0.4,0.5,0.55,0.63,0.7,0.8,0.9,1.0,1.1,1.25,1.4,1.6,1.8,2,2.2,2.5,2.8,3,2,3.2,3.6,4,4.5,5,5.5,6,3,7.1,8,9,10,11,12.5,14,16,18,20,22,25,28,32,36,40,45,50,56,63,71,80,90,100,110,125,140,160,180,200,225,250,280,320,360,400,450,500,560,630,710,800,900,1000	mAs
Time (ms) increase at R'10	1,1.25,1.6,2,2.5,3,2,4,5,6,3,8,10,12.5,16,20,25,32,40,50,63,80,100,125,160,200,250,320,400,500,630,800,1000,1250,1600,2000,2500,3200,4000,5000,6300,8000,10000	ms
Time (ms) increase at R'20	1,1.1,1.25,1.4,1.6,1.8,2,0,2,2,2.5,2.8,3,2,3.6,4,4.5,5,5.6,6,3,7.1,8,9,10,11,12.5,14,16,18,20,22,25,28,32,36,40,45,50,56,63,71,80,90,100,110,125,140,160,180,200,220,250,280,320,360,400,450,500,560,630,710,800,900,1000,1100,1250,1400,1600,1800,2000,2200,2500,2800,3200,3600,4000,4500,5000,5600,6300,7100,8000,9000,10000	ms

Registrant: Suzhou Powersite Electric Co., Ltd.

Address: Room101, building 6, No.8 Jinfeng Road, Science &Technology Town, Suzhou New District 215163 Suzhou,
PEOPLE'S REPUBLIC OF CHINA

Tel: 0512-62913368

Production: Suzhou Powersite Electric Co., Ltd.

Address: Room101, building 6, No.8 Jinfeng Road, Science &Technology Town, Suzhou New District 215163 Suzhou,
PEOPLE'S REPUBLIC OF CHINA

Zip code: 215163

Tel: 0512-62913368

Hotline: 0512-62913368

Fax: 0512-62913378

Sales service: Suzhou Powersite Electric Co., Ltd.

Address: Room101, building 6, No.8 Jinfeng Road, Science &Technology Town, Suzhou New District 215163 Suzhou,
PEOPLE'S REPUBLIC OF CHINA

Tel: 0512-62913368