

Shenzhen JCR Medical Technology Limited Company

Customer First
Quality First

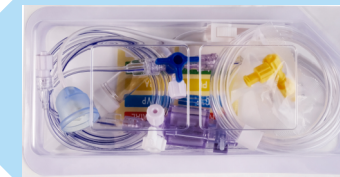

Nancy Cao

Mobile/Whatsapp/Wechat +86-13197290865
Email:sales01@jcr-med.cn/ Nancy.cao@jcr-med.com

Tracy Li

Mobile/Whatsapp/Wechat +86-13471993401
Email:sales028@jcr-med.cn

Candy Tang

Mobile/Wechat +86-13926569635
Email:Candy.Tang@jcr-med.com

Christina Zou

Mobile/Whatsapp/Wechat +86-18071931385
Email:sales018@jcr-med.cn

Adele Xie

Mobile/Whatsapp/Wechat +86-15778609939
Email:sales06@jcr-med.cn

Disposable Pressure Transducers
and Accessories Brochure



Customer First, Quality First



Contents

- IBP Transducers Series
- Disposable IBP Cables Series
- Reusable IBP Cables Series
- IBP Holder and Clamp
- Pressure Extension Tube
- Pressure Sensor Chip



Company Profile

Shenzhen JCR Medical Technology Limited Company founded in 2009, is located in the China Shenzhen special economic zone. We are manufacturing IBP transducers, SPO2 probes, Temperature probes, Tourniquets, Disposable Pressure Pump, ECG Cables, other medical tube and related accessories, related extension cables and related components .We are also distributor of the TE sensor.

Our products include IBP Transducers Series and Disposable Temperature Sensor Probes Series, Reusable Temperature Sensor Probes Series, Disposable SPO2 Sensor Probes Series, Reusable SPO2 Sensor Probes Series, compatible with all major brands of monitors IBP Cables Series, Temperature Extension Cables Series, SPO2 Extension Cables Series, Tourniquet, ECG Cables, NIBP Cuff, Pressure Pump, Medical tubing, Central Venous Catheter Kit Disposable Brain Electrode, Y-connector, manifolds, ECG electrode, Umbilical cord clamp, Drainage catheter kit, Ureteral stent, Heparin cap, Disposable cervical ripening ballon, catheter sheath, Suction tube and etc. We can provide customers with fully customized products, also provide our standard products.

Our factory covers an area of 12000 square meters,with 5000 square meters in accordance with China GMP standard 100000 grade clean workshop and 10000 grade clean laboratory .Our company is equipped with UV oven curing, accurate test system, super stable sealing machine and other equipment to produce finished products. At present, it can manufacture more than 400,000 sets per month.Mature production technology ,good quality ,and short lead time ,100% final test ,to provide customers with ODM,OEM and customization services.



Our factory has high precision electronic horizontal injection molding machine and vertical injection molding machine, automatic packaging machine, blister packing machine and EO sterilization equipment, complete production line dedicated to sterile medical devices. Our company was rated as a national high-tech enterprise and technologically advanced 'little giant' enterprises in Guangdong Province. We also passed TUV ISO13485, CFDA and CE.

Our company adheres to the business philosophy of "people-oriented, technology development", adheres to the business policy of "customer first, quality first", focuses on the application of sensors in electronic medical devices, and is committed to providing customers with the best solutions. JCR Medical will always sincerely cooperate with domestic and foreign manufacturers as before, and look forward to working hand in hand with friends to make joint efforts for the development of the global medical industry.

IBP Transducers Introduction

Product intended use

Disposable Pressure Transducer is mainly used in medical unit to monitor various pressures such as patient's arterial pressure, central venous pressure, pulmonary arterial pressure, and left coronary pressure. It is a single-use product. It can be used with various kinds of invasive blood pressure sensing devices.

The principle, function and structure of the product

After sterilization, one end of the Disposable Pressure Transducer is connected to patient's blood vessel or pressure cavity, the other end is connected to monitor using a disposable cable, through the microcomputer electric wheatstone bridge of the pressure chip, patient's blood pressure or other cavity pressure is converted to electrical signals when the liquid medicine flows through the sensor, and the monitor conducts signal conditioning so as to monitor the pressure in real time.

Main technical parameters and working environment requirements:

Barometric pressure:	70~106Kpa
Relative humidity:	10~90% (non-condensing)
Operating temperature range:	15°C - 40°C
Operating pressure range:	-50 ~ + 300 mmHg
Sensitivity:	5.0μV/V/mmHg ±3%
Nonlinearity and hysteresis:	full-scale reading±1.5%
Input impedance:	1200Ω ~3200Ω
Output impedance:	300±5%
Zero pressure offset:	-20mmHg~+20mmHg
Thermal offset shift:	≤±0.3mmHg/°C
Offset drift:	After warm-up for 20 seconds, drift within 2 mmHg within 8 hours
Thermal span shift:	≤±0.1%/°C
Frequency response:	Standard pressure set (48 "/ 12") is 40 Hz; Separate sensor > 200 Hz
Defibrillator withstand:	Defibrillation depends on the final connection of the equipment.
Leakage current:	Leakage current is dependent on the final connection of the equipment
Overpressure load:	-400~+4000mmHg
Shock resistance :	Withstand falling from one meter for three times
Light sensitivity:	When exposed to a 3400°K tungsten light, candle light at 3000 feet, it's less than 1 mmHg under rated voltage.
Contact with the human body:	≤168h
Storage and transport environment requirements:	- 20 ° C~ + 60 ° C, < 90%(non-condensing), no corrosive gas and indoor ventilation, and to avoid high temperature and cold.
Intra-system velocity:	2-5mL/h (Intra-system velocity refers to the velocity under 6.00 VDC and 25°C, unless there are additional instructions.
Product shelf-life:	3 years.

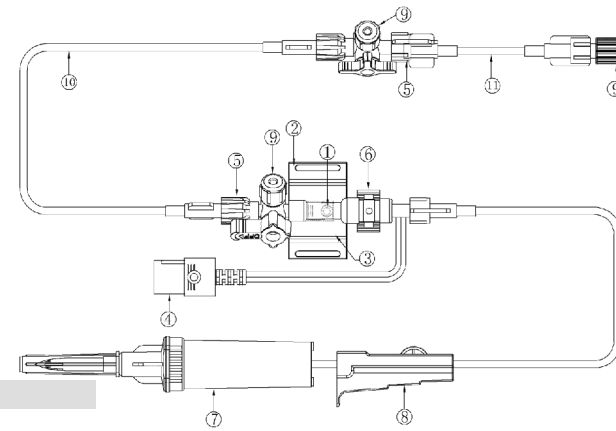

Single channel

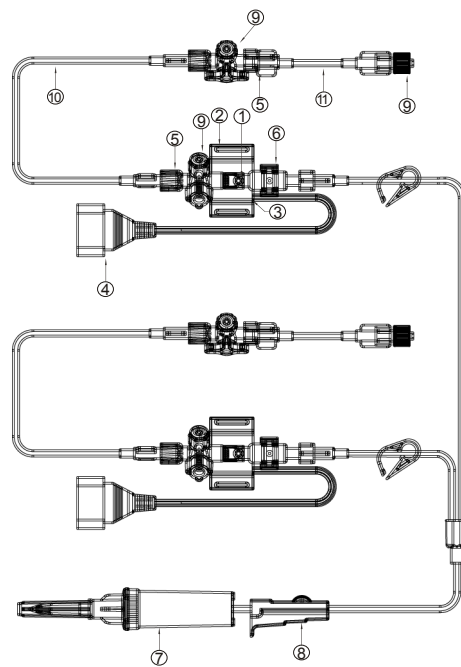

Double channel

Single channel / Double channel / Triple channel IBP Transducers Product Diagram

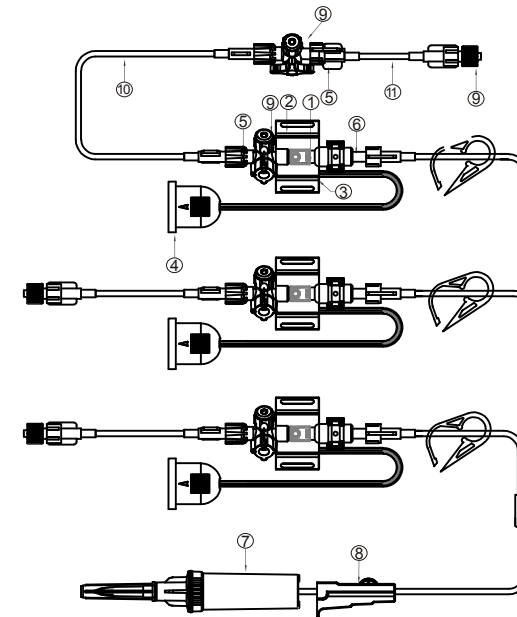

Triple channel

- 1—Pressure sensor chip 2—Plastic housing
- 3—Plastic cover 4—Signal output cable
- 5—Stopcock; 6—Flush device
- 7—Perfusion apparatus; 8— Flow regulator
- 9—Cap 10—Long connecting pipe
- 11— Short connecting pipe

4 9 Kinds of IBP Transducers End Diagram

Abbott, RJ11, 6P4C	Utah, In line, 4 hole	BD Round, 4 thin pin	Edwards, Round, 5P	Medex, Half round, 4P
				We have 9 kinds of connector for IBP Transducers Single, double and triple channel available
Bbraun, Round, 4P	PVB In line, 4P	USB USB, 4P	Mindray, Arch, 4P	

Diagram of IBP Transducers usage

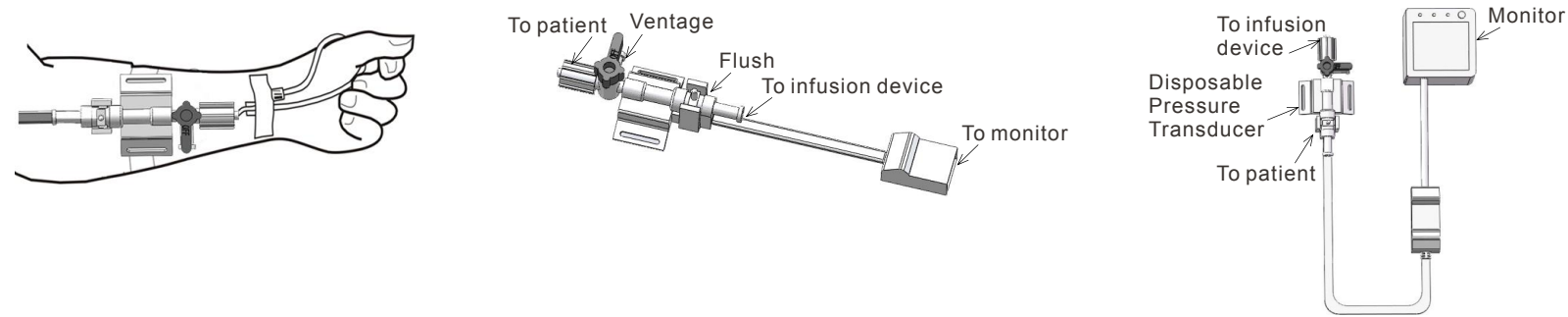

The difference between IBP Transducers regular-type, E-type, without flush valve, and blood collection type

Picture 1

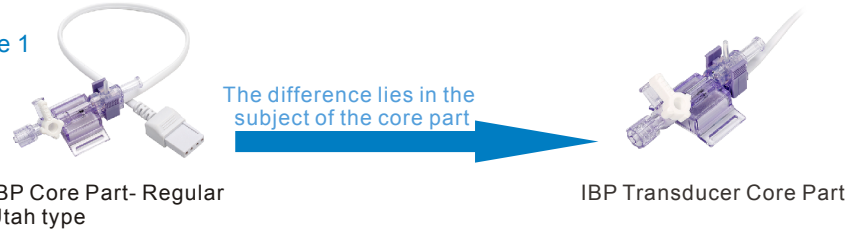

Picture 2

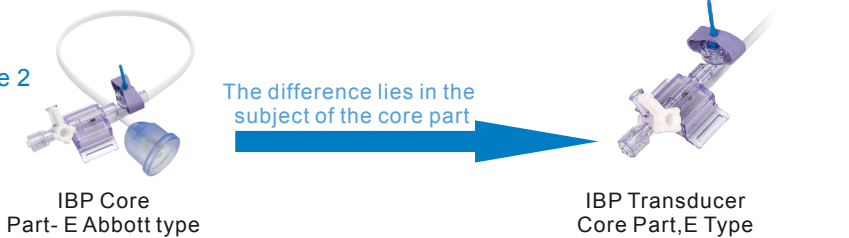

Picture 3

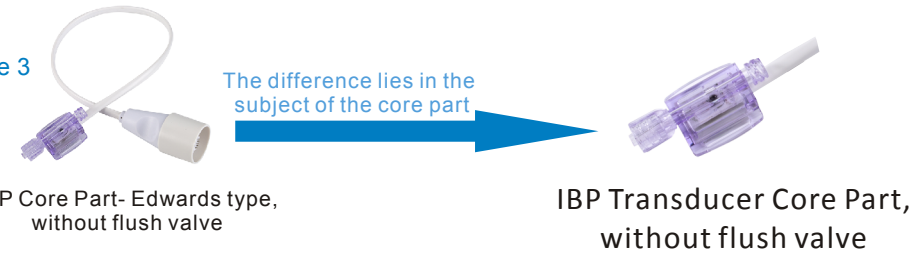

Picture 4



Pictures for Blood collection type accessories

IBP Transducers kit specifications: 9 kinds of connectors available (with CE and ISO13485 certificates)

IBP Transducers Series		Abbott	Utah	BD	Edwards	Medex	Bbraun	PVB	USB	Mindray
	single channel	JIBPT-01-YP	JIBPT-01-UT	JIBPT-01-EDW	JIBPT-01-BD	JIBPT-01-MD	JIBPT-01-BL	JIBPT-01-PVB	JIBPT-01-USB	JIBPT-01-MR
	single E Type	JIBPT-E-01-YP	JIBPT-E-01-UT	JIBPT-E-01-EDW	JIBPT-E-01-BD	JIBPT-E-01-MD	JIBPT-E-01-BL	JIBPT-E-01-PVB	JIBPT-E-01-USB	JIBPT-E-01-MR
	Double channel	JIBPT-02-YP	JIBPT-02-UT	JIBPT-02-EDW	JIBPT-02-BD	JIBPT-02-MD	JIBPT-02-BL	JIBPT-02-PVB	JIBPT-02-USB	JIBPT-02-MR
	Double E Type	JIBPT-E-02-YP	JIBPT-E-02-UT	JIBPT-E-02-EDW	JIBPT-E-02-BD	JIBPT-E-02-MD	JIBPT-E-02-BL	JIBPT-E-02-PVB	JIBPT-E-02-USB	JIBPT-E-02-MR
	Triple channel	JIBPT-03-YP	JIBPT-03-UT	JIBPT-03-EDW	JIBPT-03-BD	JIBPT-03-MD	JIBPT-03-BL	JIBPT-03-PVB	JIBPT-03-USB	JIBPT-03-MR
	Triple E Type	JIBPT-E-03-YP	JIBPT-E-03-UT	JIBPT-E-03-EDW	JIBPT-E-03-BD	JIBPT-E-03-MD	JIBPT-E-03-BL	JIBPT-E-03-PVB	JIBPT-E-03-USB	JIBPT-E-03-MR
	With Blood Sampling System			JIBPT-CX-01-EDW-BT						
				JIBPT-CX-02-EDW-BT						
				JIBPT-CX-03-EDW-BT						

IBP core part specifications: 9 kinds of connectors are available

IBP Transducer Core Part		Abbott	Utah	BD	Edwards	Medex	Bbraun	PVB	USB	Mindray
	IBP Transducer Core Part	JIBPT-01-YP-S	JIBPT-01-UT-S	JIBPT-01-EDW-S	JIBPT-01-BD-S	JIBPT-01-MD-S	JIBPT-01-BL-S	JIBPT-01-PVB-S	JIBPT-01-USB-S	JIBPT-01-MR-S
	IBP Transducer Core Part, E Type	JIBPT-E-01-YP-S	JIBPT-E-01-UT-S	JIBPT-E-01-EDW-S	JIBPT-E-01-BD-S	JIBPT-E-01-MD-S	JIBPT-E-01-BL-S	JIBPT-E-01-PVB-S	JIBPT-E-01-USB-S	JIBPT-E-01-MR-S
	IBP Transducer Core Part-Without flush device	JIBPT-J-YP-S	JIBPT-J-UT-S	JIBPT-J-EDW-S	JIBPT-J-BD-S	JIBPT-J-MD-S	JIBPT-01-BL-S	JIBPT-J-PVB-S	JIBPT-J-USB-S	JIBPT-J-MR-S

Related products for IBP Transducers

— Reusable IBP Cables

We can build almost all reusable IBP extension cables/adaptor cables that compatible with all common monitors. 9 different transducer connectors ,there are: Abbott type, Utah type, BD type, Edwards type, Medex type, Bbraun type, PVB type,USB type, Mindray type.

The cable of the monitor connectors mainly include: Philips 12P, Mindray 12P, GE 11P, Siemens 10P, Biolight 4P, Datex 10P, Space 10P, Nihon Kohden 14P, Comen 12P, JJ-LEAD 4P, HuaNan 5P, Stock 4P, Bard 8P, Drager 16P and etc.

We can also provide a single side test head with cable connector only connected to sensor end (the length is customized according to customer requirements). The disposable IBP Transducer is connected to the monitor through Reusable IBP Cables to complete signal connection and conversion.

(Note: The cable length can be customized according to customers' requirements. The standard cable length is 3.2 meters.)

Diagram of the use of IBP Transducers and IBP Cables

- A—Monitor end
- B— Length: 3.2m Material: TPU
- C— IBP Transducers end

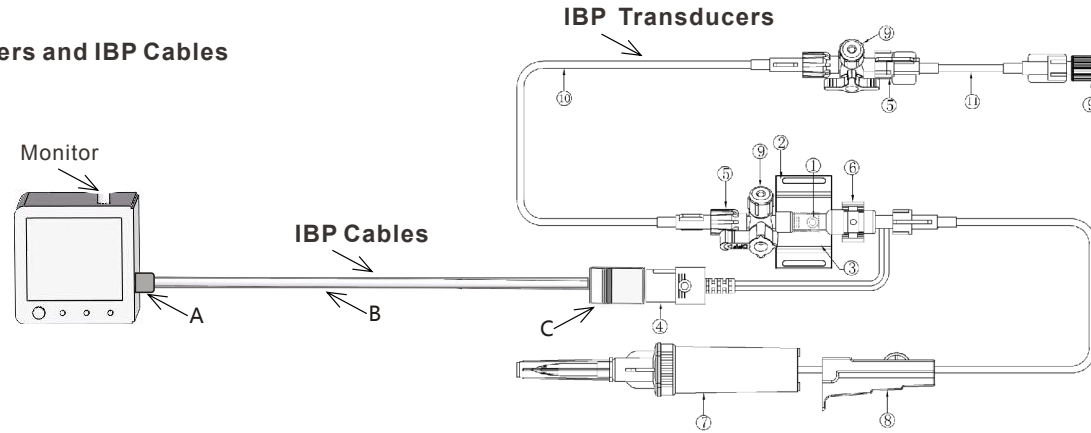

Pictures of the use of IBP Cables and IBP Transducers

Picture 1







Picture 2



Related products for IBP Transducers		Abbott	Utah	BD	Edwards	Medex	Bbraun	PVB	USB	Mindray
IBP Holder and Clamp										
Philips 12P		J52I0010	J52I0020	J52I0030	J52I0040	J52I0050	J52I0060	J52I0090	J52I0070	J52I0080
Mindray 12P		J69I0070	J69I0080	J69I0090	J69I0100	J69I0110	J69I0120	J69I0150	J69I0130	J69I0140
Mindray 6P		J69I0010	J69I0020	J69I0030	J69I0040	J69I0050	J69I0060	J69I0180	J69I0160	J69I170
Nihon Kohden 14P		J92I0010	J92I0020	J92I0030	J92I0040	J92I0050	J92I0060	J92I0090	J92I0070	J92I0080
GE 11P		J37I0010	J37I0020	J37I0030	J37I0040	J37I0050	J37I0060	J37I0090	J37I0070	J37I0080
Biolight 4P		J2AI0010	J2AI0020	J2AI0030	J2AI0040	J2AI0050	J2AI0060	J2AI0090	J2AI0070	J2AI0080
Siemens 10P		J1FI0010	J1FI0020	J1FI0030	J1FI0040	J1FI0050	J1FI0060	J1FI0090	J1FI0070	J1FI0080

Related products for IBP Transducers
 ——IBP Holder and Clamp

Product Picture	Product Code	Product Description
	H0044	Immovable IBP Holder
	J00F04	Movable IBP Holder: movable, adjustable in size
	BP0364	IBP Clamp with 3 screws
	BP0059	IBP Clamp with 5 screws

Logo can be customized if with large quantity

Pictures of the use of IBP Cables and IBP Transducers
 Picture 1 and Picture 2 show the use of IBP Holder and IBP Clamp
 Function: The IBP Holder and Clamp play the role of fixing the IBP Transducers and flexibly adjusting the height to prevent the IBP Transducers from falling to the ground when it is touched by the patient in the process of use.



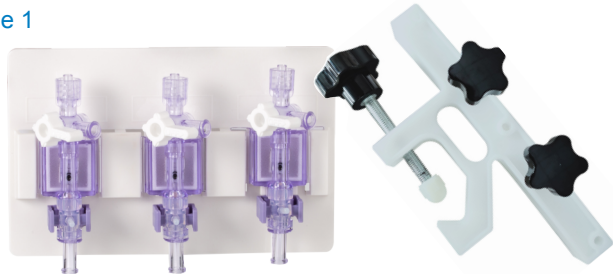

Picture 1







Picture 2

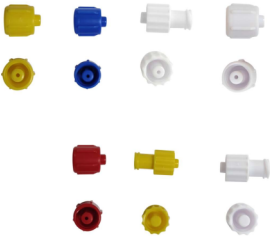

Related products for IBP Transducers
 ——Pressure extension tube, Cap

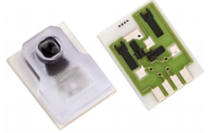
Product Picture	Product Name	Product Description
	Pressure Extension Tube-Blue long tube	The material of the tube is medical grade PVC rubber, and the production workshop is a dust-free workshop, the environment quality reaches the standard of class 10, 000 and 100, 000. Color, length, softness and hardness can be customized according to customers' requirements.
	Pressure Extension Tube-Red long tube	
	Pressure Extension Tube-Yellow long tube	
	Transparent Spiral PVC Tube	
	Cap	White, red, blue, yellow long cap White, red, blue, yellow short cap.

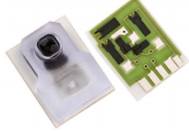
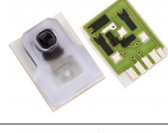
Related products for IBP Transducers — Pressure sensor chip

Product Pictures	Product Name	Features	Applications
	1620-H-N-T	<ul style="list-style-type: none"> •Lower price, medical applications •Small size, reliable performance 	<ul style="list-style-type: none"> •Surgery •Intensive Care Unit
	1620-H-W-T	<ul style="list-style-type: none"> •Liquid gel isolation •Working temperature: 5 -45 	
	1620-J-W-T	<ul style="list-style-type: none"> •Automated production assembly •1% accuracy 	
	1620-K-N-T	<ul style="list-style-type: none"> •5.0uV/V/mmHg sensitivity 	
	1630-T	<ul style="list-style-type: none"> •OEM customization 	

Product description

The 1620 is a fully piezo resistive silicon pressure sensor for use in invasive blood pressure monitoring. The sensor is designed to be used with automated assembly equipment and can be dropped directly into a customer's disposable blood pressure housing. The sensor is designed to meet the requirements as described in AAMI BP22 specification .

The pressure sensor consists of a pressure sensing element mounted on a ceramic substrate. Thick film resistors on the ceramic substrate are laser trimmed for compensation and calibration. A plastic cap is attached to the ceramic substrate to provide an easy method of attachment to the customer's assembly and protection for the sensing element. A dielectric gel is placed over the sensor to provide electrical and fluid isolation.

Certifications

Registration Certificate for Medical Device



Production Enterpriser Licence of Medical Instrument



TE Authorization Letter



Medical Device Record Voucher



Registration Certificate for Medical Device



Medical device production product registration form



ISO 13485



TE Authorization Letter



EC Certificate



医疗器械经营许可证



高新技术企业证书

