

## Orthopaedic Catalog

**Prepared for:** Reconstructive Surgery

**Prepared by:** (Entire Catalog)

**Contact Info:**

**Date Prepared:** 10/16/2003 3:55:30 PM

Smith & Nephew, Inc.  
1450 Brooks Road  
Memphis, TN 38116 U.S.A

For Orders and other Inquiries: 1.800.238.7538  
[www.smithnephew.com/ortho](http://www.smithnephew.com/ortho)

Copyright of Smith & Nephew, Inc.

# SMITH & NEPHEW, INC.

## PRODUCT CATALOG

### Catalog Contents

|   |    |
|---|----|
| Reconstructive Surgery .....  | 7  |
| Knee Systems .....  | 12 |
| Genesis II Total Knee System/Cruciate-Retaining Femoral Implants .....                  | 12 |
| Genesis II Total Knee System/Posterior-Stabilized/Constrained Femoral Implants .....    | 13 |
| Genesis II Total Knee System/Patellar Implants .....                                    | 14 |
| Genesis II Total Knee System/Metal-Base Tibial Implants .....                           | 14 |
| Genesis II Total Knee System/All-Polyethylene Base Tibial Implants .....                | 15 |
| Genesis II Total Knee System/Cruciate-Retaining Articular Inserts .....                 | 17 |
| Genesis II Total Knee System/Posterior-Stabilized/Constrained Articular Inserts .....   | 17 |
| Genesis II Total Knee System/Femoral Conversion Module and Femoral Wedges .....         | 18 |
| Genesis II Total Knee System/Tibial Wedges and Long Stems .....                         | 19 |
| Genesis II Total Knee System/Instrumentation/Femoral Tray, Sizes 3-6 .....              | 20 |
| Genesis II Total Knee System/Instrumentation/Finishing Tray, Sizes 1-2 .....            | 23 |
| Genesis II Total Knee System/Instrumentation/Finishing Tray, Sizes 7-8 .....            | 25 |
| Genesis II Total Knee System/Instrumentation/Long Stem Sterile Tray .....               | 27 |
| Genesis II Total Knee System/Instrumentation/Miscellaneous .....                        | 28 |
| Genesis II Total Knee System/Instrumentation/Miscellaneous Tray .....                   | 29 |
| Genesis II Total Knee System/Instrumentation/Patellar Tray .....                        | 31 |
| Genesis II Total Knee System/Instrumentation/Porous Tibial Tray .....                   | 33 |
| Genesis II Total Knee System/Instrumentation/Posterior-Referencing Tray .....           | 34 |
| Genesis II Total Knee System/Instrumentation/Posterior-Stabilized Tray, Sizes 3-6 ..... | 36 |
| Genesis II Total Knee System/Instrumentation/P-S / Revision Tray, Sizes 1-2 .....       | 37 |
| Genesis II Total Knee System/Instrumentation/P-S / Revision Tray, Sizes 7-8 .....       | 39 |
| Genesis II Total Knee System/Instrumentation/Revision Miscellaneous Wedge Tray .....    | 40 |
| Genesis II Total Knee System/Instrumentation/Revision Tray, Sizes 3-6 .....             | 43 |
| Genesis II Total Knee System/Instrumentation/Tibial Tray, Sizes 3-6 .....               | 43 |
| Profix Total Knee System/Cruciate-Retaining Femoral Implants .....                      | 46 |
| Profix Total Knee System/Posterior-Stabilized/Constrained Femoral Implants .....        | 47 |
| Profix Total Knee System/Patellar Implants .....  | 49 |

# SMITH & NEPHEW, INC.

## PRODUCT CATALOG

|   |    |
|---|----|
| Profix Total Knee System/Metal-Base Tibial Implants .....                                       | 50 |
| Profix Total Knee System/Cruciate-Retaining Articular Inserts .....                             | 51 |
| Profix Total Knee System/Posterior-Stabilized/Constrained Articular Inserts .....               | 53 |
| Profix Total Knee System/All-Polyethylene Base Tibial Implants .....                            | 55 |
| Profix Total Knee System/Primary Tibial Stems .....   | 56 |
| Profix Total Knee System/Femoral Revision Implants .....  | 56 |
| Profix Total Knee System/Long Stems and Wedges (Tib & Fem) .....                                | 57 |
| Profix Total Knee System/Instrumentation/Case #1, Femoral Prep Instruments .....                | 59 |
| Profix Total Knee System/Instrumentation/Case #2, Femoral/Tibial Cutting Blocks .....           | 61 |
| Profix Total Knee System/Instrumentation/Case #3, Femoral/Tibial Trials .....                   | 64 |
| Profix Total Knee System/Instrumentation/Case #4, Conforming Articular Insert Trials .....      | 65 |
| Profix Total Knee System/Instrumentation/Case #5, Conforming Plus Articular Insert Trials ..... | 67 |
| Profix Total Knee System/Instrumentation/Case #6, Miscellaneous Instruments .....               | 69 |
| Profix Total Knee System/Instrumentation/Case #7, Patellar Instruments .....                    | 70 |
| Profix Total Knee System/Instrumentation/Case #8, Revision Reamer/Long Stem Trials .....        | 72 |
| Profix Total Knee System/Instrumentation/Case #9, Revision Femoral Trials .....                 | 73 |
| Profix Total Knee System/Instrumentation/Case #10, Femoral Wedge Trials/Tibial Spacers .....    | 73 |
| Profix Total Knee System/Instrumentation/Case #11, Posterior-Stabilized Trial Instruments ..... | 75 |
| Profix Total Knee System/Instrumentation/Case #12, P/S Articular Insert Trials .....            | 77 |
| Profix Total Knee System/Instrumentation/Constrained Articular Trials .....                     | 78 |
| Profix Total Knee System/Instrumentation/Sawblades .....  | 79 |
| Accuris Uni Knee System/Oxinium Uni Femoral Implants .....                                      | 80 |
| Accuris Uni Knee System/Genesis Uni Femoral Implants .....                                      | 80 |
| Accuris Uni Knee System/Metal-Base Tibial Implants .....  | 80 |
| Accuris Uni Knee System/All-Polyethylene Inlay Tibial Implants .....                            | 81 |
| Accuris Uni Knee System/Instrumentation .....   | 81 |
| Accuris Uni Knee System/All-Polyethylene Onlay Tibial Implants .....                            | 89 |
| Hip Systems .....   | 91 |
| Femoral Options/Synergy Primary Hip System/Implants .....                                       | 91 |
| Femoral Options/Synergy Primary Hip System/Heads .....  | 92 |
| Femoral Options/Synergy Primary Hip System/Distal Centralizers .....                            | 93 |
| Femoral Options/Synergy Primary Hip System/Femoral Instrumentation Tray No. 1 .....             | 93 |
| Femoral Options/Synergy Primary Hip System/Femoral Instrumentation Tray No. 2 .....             | 94 |
| Femoral Options/Synergy Primary Hip System/Collared Trial Neck Sterilization Tray .....         | 95 |

# SMITH & NEPHEW, INC.

## PRODUCT CATALOG

|   |     |
|---|-----|
| Femoral Options/Conquest Fx/Implants .....  | 95  |
| Femoral Options/Conquest Fx/Heads .....   | 96  |
| Femoral Options/Conquest Fx/Distal Centralizers .....   | 97  |
| Femoral Options/Conquest Fx/Femoral Instrumentation Tray No. 1 .....                                  | 97  |
| Femoral Options/Conquest Fx/Femoral Instrumentation Tray No. 2 .....                                  | 98  |
| Femoral Options/Echelon Primary Hip System/Implants .....   | 99  |
| Femoral Options/Echelon Primary Hip System/Heads .....  | 99  |
| Femoral Options/Echelon Primary Hip System/Echelon Starter Tray .....                                 | 100 |
| Femoral Options/Echelon Primary Hip System/Echelon Reamer Tray .....                                  | 101 |
| Femoral Options/Echelon Primary Hip System/Broach Tray .....  | 102 |
| Femoral Options/Echelon Revision Hip System/Implants .....  | 102 |
| Femoral Options/Echelon Revision Hip System/Heads .....   | 105 |
| Femoral Options/Echelon Revision Hip System/Echelon Starter Tray .....                                | 106 |
| Femoral Options/Echelon Revision Hip System/Echelon Reamer Tray .....                                 | 107 |
| Femoral Options/Echelon Revision Hip System/Broach Tray .....   | 107 |
| Femoral Options/Echelon Revision Hip System/Straight Stem Trial Tray Porous and Cemented<br>.....     | 108 |
| Femoral Options/Echelon Revision Hip System/Bowed Stem Trial Tray .....                               | 109 |
| Femoral Options/Echelon Revision Hip System/Echelon Thin Shaft Reamer Tray .....                      | 109 |
| Femoral Options/Echelon Revision Hip System/21-22 mm Bowed Stem Trial Thin Shaft Reamer<br>Tray ..... | 110 |
| Femoral Options/Echelon Revision Hip System/300 mm Bowed Cemented Stem Trial Tray<br>.....            | 110 |
| Femoral Options/Spectron Primary Hip System/Implants .....  | 110 |
| Femoral Options/Spectron Primary Hip System/Heads .....   | 111 |
| Femoral Options/Spectron Primary Hip System/Instruments .....   | 112 |
| Femoral Options/Spectron Primary Hip System/Distal Centralizers .....                                 | 113 |
| Femoral Options/Spectron Primary Hip System/Additional/Optional Instruments .....                     | 113 |
| Femoral Options/Spectron Revision Hip System /Implants .....  | 114 |
| Femoral Options/Spectron Revision Hip System /Heads .....   | 114 |
| Femoral Options/Spectron Revision Hip System /Instruments .....                                       | 115 |
| Femoral Options/Spectron Revision Hip System /Centralizers .....                                      | 116 |
| Femoral Options/Cobra Femoral Component/Implants .....  | 117 |
| Femoral Options/Cobra Femoral Component/Heads .....   | 117 |
| Femoral Options/Cobra Femoral Component/Instruments .....   | 118 |
| Femoral Options/Cobra Femoral Component/Distal Centralizers .....                                     | 119 |
| Femoral Options/Cobra Femoral Component/Additional/Optional Instruments .....                         | 119 |

# SMITH & NEPHEW, INC.

## PRODUCT CATALOG

|  |     |
|--|-----|
| Femoral Options/Image Porous Hip System/Heads .....                                  | 120 |
| Femoral Options/Image Porous Hip System/Implants .....                               | 121 |
| Femoral Options/Image Porous Hip System/Instruments .....                            | 122 |
| Acetabular Options/Acetabular Shells/Reflection All-Poly .....                       | 123 |
| Acetabular Options/Acetabular Shells/Reflection Ceramic .....                        | 124 |
| Acetabular Options/Acetabular Shells/Reflection FSO .....                            | 124 |
| Acetabular Options/Acetabular Shells/Reflection InterFit .....                       | 125 |
| Acetabular Options/Acetabular Shells/Reflection NH .....                             | 125 |
| Acetabular Options/Acetabular Shells/Reflection SP3 .....                            | 126 |
| Acetabular Options/Acetabular Shells/Reflection Spiked .....                         | 126 |
| Acetabular Options/Acetabular Liners/Reflection Acetabular Liners .....              | 127 |
| Acetabular Options/Acetabular Liners/Reflection Lateralized Liners (+4mm) .....      | 127 |
| Acetabular Options/Acetabular Liners/XLPE Acetabular Liners .....                    | 128 |
| Acetabular Options/Acetabular Liners/XLPE Lateralized/Anteverted Liners (+4mm) ..... | 129 |
| Acetabular Options/Acetabular Liners/Reflection Trial Liners .....                   | 130 |
| Acetabular Options/Instruments/Contour Instruments .....                             | 132 |
| Acetabular Options/Instruments/Other Instruments .....                               | 132 |
| Acetabular Options/Instruments/Reflection Additional Trial Liner Tray .....          | 134 |
| Acetabular Options/Instruments/Reflection All-Poly Instruments .....                 | 134 |
| Acetabular Options/Instruments/Reflection Jumbo Reamer/Trial Tray .....              | 135 |
| Acetabular Options/Instruments/Reflection Large Reamer/Trial Tray .....              | 136 |
| Acetabular Options/Instruments/Reflection Main Instrument Tray .....                 | 136 |
| Acetabular Options/Instruments/Reflection Primary Reamer Tray .....                  | 138 |
| Acetabular Options/Instruments/Reflection Reamer Domes .....                         | 138 |
| Acetabular Options/Instruments/Reflection Small Reamers and Trials Tray .....        | 139 |
| Acetabular Options/Instruments/Reflection Trial Shell Tray .....                     | 139 |
| Acetabular Options/Contour Acetabular Rings/Implants .....                           | 140 |
| Acetabular Options/Contour Acetabular Rings/Trials .....                             | 141 |
| Acetabular Options/Contour Acetabular Rings/Contour Instrumentation .....            | 141 |
| Acetabular Options/Contour Acetabular Rings/All-Poly Instrumentation .....           | 142 |
| Femoral Head Options/Oxinium Femoral Heads .....                                     | 144 |
| Femoral Head Options/Alumina Femoral Heads .....                                     | 144 |
| Femoral Head Options/CoCr Femoral Heads .....  | 144 |
| Femoral Head Options/Zirconia Femoral Heads .....                                    | 145 |
| Femoral Head Options/Trial 12/14 Taper Femoral Heads .....                           | 145 |
| Fracture Management/Austin Moore Endoprostheses .....                                | 145 |
| Fracture Management/Convene Bipolar System .....                                     | 146 |

# SMITH & NEPHEW, INC.

## PRODUCT CATALOG

|  |     |
|--|-----|
| Fracture Management/Unipolar System .....                      | 147 |
| Implant Removal System/Renovation Implant Removal System ..... | 148 |
| Shoulder Systems .....   | 150 |
| Cofield 2 Shoulder System .....                                | 150 |
| Glenoid Options .....  | 152 |
| Humeral Head Componets .....                                   | 152 |
| Humeral Stem Componets .....                                   | 153 |
| Instruments .....  | 154 |
| Cement & Accessories .....                                     | 161 |
| Vacuum Pump Connectors .....                                   | 161 |
| Bone Cement Mixing and Delivery Components .....               | 161 |
| Femoral Preparation and Bone Cement .....                      | 162 |
| Miscellaneous .....  | 163 |
| PowerPulse Lavage System .....                                 | 164 |
| Supartz Joint Fluid Therapy .....                              | 166 |

# TABLE OF CONTENTS

## Reconstructive Surgery

### Reconstructive Surgery

|   |    |
|---|----|
| Knee Systems .....  | 12 |
| Genesis II Total Knee System/Cruciate-Retaining Femoral Implants .....                  | 12 |
| Genesis II Total Knee System/Posterior-Stabilized/Constrained Femoral Implants .....    | 13 |
| Genesis II Total Knee System/Patellar Implants .....                                    | 14 |
| Genesis II Total Knee System/Metal-Base Tibial Implants .....                           | 14 |
| Genesis II Total Knee System/All-Polyethylene Base Tibial Implants .....                | 15 |
| Genesis II Total Knee System/Cruciate-Retaining Articular Inserts .....                 | 17 |
| Genesis II Total Knee System/Posterior-Stabilized/Constrained Articular Inserts .....   | 17 |
| Genesis II Total Knee System/Femoral Conversion Module and Femoral Wedges .....         | 18 |
| Genesis II Total Knee System/Tibial Wedges and Long Stems .....                         | 19 |
| Genesis II Total Knee System/Instrumentation/Femoral Tray, Sizes 3-6 .....              | 20 |
| Genesis II Total Knee System/Instrumentation/Finishing Tray, Sizes 1-2 .....            | 23 |
| Genesis II Total Knee System/Instrumentation/Finishing Tray, Sizes 7-8 .....            | 25 |
| Genesis II Total Knee System/Instrumentation/Long Stem Sterile Tray .....               | 27 |
| Genesis II Total Knee System/Instrumentation/Miscellaneous .....                        | 28 |
| Genesis II Total Knee System/Instrumentation/Miscellaneous Tray .....                   | 29 |
| Genesis II Total Knee System/Instrumentation/Patellar Tray .....                        | 31 |
| Genesis II Total Knee System/Instrumentation/Porous Tibial Tray .....                   | 33 |
| Genesis II Total Knee System/Instrumentation/Posterior-Referencing Tray .....           | 34 |
| Genesis II Total Knee System/Instrumentation/Posterior-Stabilized Tray, Sizes 3-6 ..... | 36 |
| Genesis II Total Knee System/Instrumentation/P-S / Revision Tray, Sizes 1-2 .....       | 37 |
| Genesis II Total Knee System/Instrumentation/P-S / Revision Tray, Sizes 7-8 .....       | 39 |
| Genesis II Total Knee System/Instrumentation/Revision Miscellaneous Wedge Tray .....    | 40 |
| Genesis II Total Knee System/Instrumentation/Revision Tray, Sizes 3-6 .....             | 43 |
| Genesis II Total Knee System/Instrumentation/Tibial Tray, Sizes 3-6 .....               | 43 |
| Profix Total Knee System/Cruciate-Retaining Femoral Implants .....                      | 46 |
| Profix Total Knee System/Posterior-Stabilized/Constrained Femoral Implants .....        | 47 |
| Profix Total Knee System/Patellar Implants .....  | 49 |
| Profix Total Knee System/Metal-Base Tibial Implants .....                               | 50 |
| Profix Total Knee System/Cruciate-Retaining Articular Inserts .....                     | 51 |
| Profix Total Knee System/Posterior-Stabilized/Constrained Articular Inserts .....       | 53 |
| Profix Total Knee System/All-Polyethylene Base Tibial Implants .....                    | 55 |
| Profix Total Knee System/Primary Tibial Stems .....                                     | 56 |
| Profix Total Knee System/Femoral Revision Implants .....                                | 56 |
| Profix Total Knee System/Long Stems and Wedges (Tib & Fem) .....                        | 57 |
| Profix Total Knee System/Instrumentation/Case #1, Femoral Prep Instruments .....        | 59 |

# TABLE OF CONTENTS

## Reconstructive Surgery

|   |     |
|---|-----|
| Profix Total Knee System/Instrumentation/Case #2, Femoral/Tibial Cutting Blocks .....           | 61  |
| Profix Total Knee System/Instrumentation/Case #3, Femoral/Tibial Trials .....                   | 64  |
| Profix Total Knee System/Instrumentation/Case #4, Conforming Articular Insert Trials .....      | 65  |
| Profix Total Knee System/Instrumentation/Case #5, Conforming Plus Articular Insert Trials ..... | 67  |
| Profix Total Knee System/Instrumentation/Case #6, Miscellaneous Instruments .....               | 69  |
| Profix Total Knee System/Instrumentation/Case #7, Patellar Instruments .....                    | 70  |
| Profix Total Knee System/Instrumentation/Case #8, Revision Reamer/Long Stem Trials .....        | 72  |
| Profix Total Knee System/Instrumentation/Case #9, Revision Femoral Trials .....                 | 73  |
| Profix Total Knee System/Instrumentation/Case #10, Femoral Wedge Trials/Tibial Spacers .....    | 73  |
| Profix Total Knee System/Instrumentation/Case #11, Posterior-Stabilized Trial Instruments ..... | 75  |
| Profix Total Knee System/Instrumentation/Case #12, P/S Articular Insert Trials .....            | 77  |
| Profix Total Knee System/Instrumentation/Constrained Articular Trials .....                     | 78  |
| Profix Total Knee System/Instrumentation/Sawblades .....  | 79  |
| Accuris Uni Knee System/Oxinium Uni Femoral Implants .....                                      | 80  |
| Accuris Uni Knee System/Genesis Uni Femoral Implants .....                                      | 80  |
| Accuris Uni Knee System/Metal-Base Tibial Implants .....  | 80  |
| Accuris Uni Knee System/All-Polyethylene Inlay Tibial Implants .....                            | 81  |
| Accuris Uni Knee System/Instrumentation .....   | 81  |
| Accuris Uni Knee System/All-Polyethylene Onlay Tibial Implants .....                            | 89  |
| Hip Systems .....   | 91  |
| Femoral Options/Synergy Primary Hip System/Implants .....                                       | 91  |
| Femoral Options/Synergy Primary Hip System/Heads .....  | 92  |
| Femoral Options/Synergy Primary Hip System/Distal Centralizers .....                            | 93  |
| Femoral Options/Synergy Primary Hip System/Femoral Instrumentation Tray No. 1 .....             | 93  |
| Femoral Options/Synergy Primary Hip System/Femoral Instrumentation Tray No. 2 .....             | 94  |
| Femoral Options/Synergy Primary Hip System/Collared Trial Neck Sterilization Tray .....         | 95  |
| Femoral Options/Conquest Fx/Implants .....  | 95  |
| Femoral Options/Conquest Fx/Heads .....   | 96  |
| Femoral Options/Conquest Fx/Distal Centralizers .....   | 97  |
| Femoral Options/Conquest Fx/Femoral Instrumentation Tray No. 1 .....                            | 97  |
| Femoral Options/Conquest Fx/Femoral Instrumentation Tray No. 2 .....                            | 98  |
| Femoral Options/Echelon Primary Hip System/Implants .....                                       | 99  |
| Femoral Options/Echelon Primary Hip System/Heads .....  | 99  |
| Femoral Options/Echelon Primary Hip System/Echelon Starter Tray .....                           | 100 |



# TABLE OF CONTENTS

## Reconstructive Surgery

|   |     |
|---|-----|
| Femoral Options/Echelon Primary Hip System/Echelon Reamer Tray .....                                  | 101 |
| Femoral Options/Echelon Primary Hip System/Broach Tray .....  | 102 |
| Femoral Options/Echelon Revision Hip System/Implants .....  | 102 |
| Femoral Options/Echelon Revision Hip System/Heads .....   | 105 |
| Femoral Options/Echelon Revision Hip System/Echelon Starter Tray .....                                | 106 |
| Femoral Options/Echelon Revision Hip System/Echelon Reamer Tray .....                                 | 107 |
| Femoral Options/Echelon Revision Hip System/Broach Tray .....   | 107 |
| Femoral Options/Echelon Revision Hip System/Straight Stem Trial Tray Porous and Cemented<br>.....     | 108 |
| Femoral Options/Echelon Revision Hip System/Bowed Stem Trial Tray .....                               | 109 |
| Femoral Options/Echelon Revision Hip System/Echelon Thin Shaft Reamer Tray .....                      | 109 |
| Femoral Options/Echelon Revision Hip System/21-22 mm Bowed Stem Trial Thin Shaft Reamer<br>Tray ..... | 110 |
| Femoral Options/Echelon Revision Hip System/300 mm Bowed Cemented Stem Trial Tray<br>.....            | 110 |
| Femoral Options/Spectron Primary Hip System/Implants .....  | 110 |
| Femoral Options/Spectron Primary Hip System/Heads .....   | 111 |
| Femoral Options/Spectron Primary Hip System/Instruments .....   | 112 |
| Femoral Options/Spectron Primary Hip System/Distal Centralizers .....                                 | 113 |
| Femoral Options/Spectron Primary Hip System/Additional/Optional Instruments .....                     | 113 |
| Femoral Options/Spectron Revision Hip System /Implants .....  | 114 |
| Femoral Options/Spectron Revision Hip System /Heads .....   | 114 |
| Femoral Options/Spectron Revision Hip System /Instruments .....                                       | 115 |
| Femoral Options/Spectron Revision Hip System /Centralizers .....                                      | 116 |
| Femoral Options/Cobra Femoral Component/Implants .....  | 117 |
| Femoral Options/Cobra Femoral Component/Heads .....   | 117 |
| Femoral Options/Cobra Femoral Component/Instruments .....   | 118 |
| Femoral Options/Cobra Femoral Component/Distal Centralizers .....                                     | 119 |
| Femoral Options/Cobra Femoral Component/Additional/Optional Instruments .....                         | 119 |
| Femoral Options/Image Porous Hip System/Heads .....   | 120 |
| Femoral Options/Image Porous Hip System/Implants .....  | 121 |
| Femoral Options/Image Porous Hip System/Instruments .....   | 122 |
| Acetabular Options/Acetabular Shells/Reflection All-Poly .....  | 123 |
| Acetabular Options/Acetabular Shells/Reflection Ceramic .....   | 124 |
| Acetabular Options/Acetabular Shells/Reflection FSO .....   | 124 |
| Acetabular Options/Acetabular Shells/Reflection InterFit .....  | 125 |
| Acetabular Options/Acetabular Shells/Reflection NH .....  | 125 |

# TABLE OF CONTENTS

## Reconstructive Surgery

|  |     |
|--|-----|
| Acetabular Options/Acetabular Shells/Reflection SP3 .....                            | 126 |
| Acetabular Options/Acetabular Shells/Reflection Spiked .....                         | 126 |
| Acetabular Options/Acetabular Liners/Reflection Acetabular Liners .....              | 127 |
| Acetabular Options/Acetabular Liners/Reflection Lateralized Liners (+4mm) .....      | 127 |
| Acetabular Options/Acetabular Liners/XLPE Acetabular Liners .....                    | 128 |
| Acetabular Options/Acetabular Liners/XLPE Lateralized/Anteverted Liners (+4mm) ..... | 129 |
| Acetabular Options/Acetabular Liners/Reflection Trial Liners .....                   | 130 |
| Acetabular Options/Instruments/Contour Instruments .....                             | 132 |
| Acetabular Options/Instruments/Other Instruments .....                               | 132 |
| Acetabular Options/Instruments/Reflection Additional Trial Liner Tray .....          | 134 |
| Acetabular Options/Instruments/Reflection All-Poly Instruments .....                 | 134 |
| Acetabular Options/Instruments/Reflection Jumbo Reamer/Trial Tray .....              | 135 |
| Acetabular Options/Instruments/Reflection Large Reamer/Trial Tray .....              | 136 |
| Acetabular Options/Instruments/Reflection Main Instrument Tray .....                 | 136 |
| Acetabular Options/Instruments/Reflection Primary Reamer Tray .....                  | 138 |
| Acetabular Options/Instruments/Reflection Reamer Domes .....                         | 138 |
| Acetabular Options/Instruments/Reflection Small Reamers and Trials Tray .....        | 139 |
| Acetabular Options/Instruments/Reflection Trial Shell Tray .....                     | 139 |
| Acetabular Options/Contour Acetabular Rings/Implants .....                           | 140 |
| Acetabular Options/Contour Acetabular Rings/Trials .....                             | 141 |
| Acetabular Options/Contour Acetabular Rings/Contour Instrumentation .....            | 141 |
| Acetabular Options/Contour Acetabular Rings/All-Poly Instrumentation .....           | 142 |
| Femoral Head Options/Oxinium Femoral Heads .....                                     | 144 |
| Femoral Head Options/Alumina Femoral Heads .....                                     | 144 |
| Femoral Head Options/CoCr Femoral Heads .....  | 144 |
| Femoral Head Options/Zirconia Femoral Heads .....                                    | 145 |
| Femoral Head Options/Trial 12/14 Taper Femoral Heads .....                           | 145 |
| Fracture Management/Austin Moore Endoprostheses .....                                | 145 |
| Fracture Management/Convane Bipolar System .....                                     | 146 |
| Fracture Management/Unipolar System .....  | 147 |
| Implant Removal System/Renovation Implant Removal System .....                       | 148 |
| Shoulder Systems .....   | 150 |
| Cofield 2 Shoulder System .....  | 150 |
| Glenoid Options .....  | 152 |
| Humeral Head Componets .....   | 152 |
| Humeral Stem Componets .....   | 153 |
| Instruments .....  | 154 |

# TABLE OF CONTENTS

## Reconstructive Surgery

|  |     |
|--|-----|
| Cement & Accessories .....                       | 161 |
| Vacuum Pump Connectors .....                     | 161 |
| Bone Cement Mixing and Delivery Components ..... | 161 |
| Femoral Preparation and Bone Cement .....        | 162 |
| Miscellaneous .....                              | 163 |
| PowerPulse Lavage System .....                   | 164 |
| Supartz Joint Fluid Therapy .....                | 166 |

## Knee Systems

### Genesis II Total Knee System/Cruciate-Retaining Femoral Implants

#### Flex-Lok Peg

| Cat. #    |
|-----------|
| 7142-0063 |



### Nonporous Femoral Implant-Left Cobalt Chromium (ASTM F 75)

| Cat. #    | Size |
|-----------|------|
| 7142-0000 | 1    |
| 7142-0002 | 2    |
| 7142-0004 | 3    |
| 7142-0006 | 4    |
| 7142-0008 | 5    |
| 7142-0010 | 6    |
| 7142-0012 | 7    |
| 7142-0014 | 8    |



### Nonmodular Cemented Cruciate-Retaining Femoral Implants-Left

Cobalt Chromium (ASTM F 75)

| Cat. #    | Size |
|-----------|------|
| 7142-0064 | 1    |
| 7142-0066 | 2    |
| 7142-0068 | 3    |
| 7142-0070 | 4    |
| 7142-0072 | 5    |
| 7142-0074 | 6    |
| 7142-0076 | 7    |
| 7142-0078 | 8    |



### Nonporous Femoral Implant-Right Cobalt Chromium (ASTM F 75)

| Cat. #    | Size |
|-----------|------|
| 7142-0016 | 1    |
| 7142-0018 | 2    |
| 7142-0020 | 3    |
| 7142-0022 | 4    |
| 7142-0024 | 5    |
| 7142-0026 | 6    |
| 7142-0028 | 7    |
| 7142-0030 | 8    |



### Nonmodular Cemented Cruciate-Retaining Femoral Implants-Right

Cobalt Chromium (ASTM F 75)

| Cat. #    | Size |
|-----------|------|
| 7142-0080 | 1    |
| 7142-0082 | 2    |
| 7142-0084 | 3    |
| 7142-0086 | 4    |
| 7142-0088 | 5    |
| 7142-0090 | 6    |
| 7142-0092 | 7    |
| 7142-0094 | 8    |



### Porous Femoral Implant-Left Cobalt Chromium (ASTM F 75)

| Cat. #    | Size |
|-----------|------|
| 7142-0032 | 1    |
| 7142-0034 | 2    |
| 7142-0036 | 3    |
| 7142-0038 | 4    |
| 7142-0040 | 5    |
| 7142-0042 | 6    |
| 7142-0044 | 7    |
| 7142-0046 | 8    |



### Porous Femoral Implant-Right

Cobalt Chromium (ASTM F 75)

| Cat. #    | Size |
|-----------|------|
| 7142-0048 | 1    |
| 7142-0050 | 2    |
| 7142-0052 | 3    |
| 7142-0054 | 4    |
| 7142-0056 | 5    |
| 7142-0058 | 6    |
| 7142-0060 | 7    |
| 7142-0062 | 8    |



### Femoral Lug

| Cat. #    |
|-----------|
| 7142-0999 |



### Posterior-Stabilized NonPorous Femoral Implant-Left

Cobalt Chromium (ASTM F 75)

| Cat. #    | Size |
|-----------|------|
| 7142-0096 | 1    |
| 7142-0098 | 2    |
| 7142-0100 | 3    |
| 7142-0102 | 4    |
| 7142-0104 | 5    |
| 7142-0106 | 6    |
| 7142-0108 | 7    |
| 7142-0110 | 8    |



### Genesis II Total Knee System/Posterior-Stabilized/Constrained Femoral Implants

#### Constrained Femoral Implant-Left

Cobalt Chromium (ASTM F 75)

| Cat. #    | Size |
|-----------|------|
| 7142-0928 | 1    |
| 7142-0930 | 2    |
| 7142-0932 | 3    |
| 7142-0934 | 4    |
| 7142-0936 | 5    |
| 7142-0938 | 6    |
| 7142-0940 | 7    |
| 7142-0942 | 8    |



#### Posterior-Stabilized NonPorous Femoral Implant-Right

Cobalt Chromium (ASTM F 75)

| Cat. #    | Size |
|-----------|------|
| 7142-0112 | 1    |
| 7142-0114 | 2    |
| 7142-0116 | 3    |
| 7142-0118 | 4    |
| 7142-0120 | 5    |
| 7142-0122 | 6    |
| 7142-0124 | 7    |
| 7142-0126 | 8    |



#### Constrained Femoral Implant-Right

Cobalt Chromium (ASTM F 75)

| Cat. #    | Size |
|-----------|------|
| 7142-0944 | 1    |
| 7142-0946 | 2    |
| 7142-0948 | 3    |
| 7142-0950 | 4    |
| 7142-0952 | 5    |
| 7142-0954 | 6    |
| 7142-0956 | 7    |
| 7142-0958 | 8    |



#### Posterior-Stabilized Porous Femoral Implant-Left

Cobalt Chromium (ASTM F 75)

| Cat. #    | Size |
|-----------|------|
| 7142-0862 | 1    |
| 7142-0864 | 2    |
| 7142-0866 | 3    |
| 7142-0868 | 4    |
| 7142-0870 | 5    |
| 7142-0872 | 6    |
| 7142-0874 | 7    |
| 7142-0876 | 8    |



### Posterior-Stabilized Porous Femoral Implant-Right

Cobalt Chromium (ASTM F 75)

| Cat. #    | Size |
|-----------|------|
| 7142-0878 | 1    |
| 7142-0880 | 2    |
| 7142-0882 | 3    |
| 7142-0884 | 4    |
| 7142-0886 | 5    |
| 7142-0888 | 6    |
| 7142-0890 | 7    |
| 7142-0892 | 8    |



### Resurfacing Patellar Implant, 9mm

VHMWPE (ASTM 5648)

| Cat. #    | Length |
|-----------|--------|
| 7142-0580 | 26mm   |
| 7142-0574 | 29mm   |
| 7142-0576 | 32mm   |
| 7142-0578 | 35mm   |



13mm including Peg Height

### Genesis II Total Knee System/Metal-Base Tibial Implants

#### Genesis II Total Knee System/Patellar Implants

### Biconvex Patellar Implant, 13mm

VHMWPE (ASTM 5648)

| Cat. #    | Length |
|-----------|--------|
| 7142-0566 | 23mm   |
| 7142-0568 | 26mm   |
| 7142-0570 | 29mm   |
| 7142-0572 | 32mm   |



### 6.5 mm Screw

Base-Titanium Alloy

| Cat. #    | Length |
|-----------|--------|
| 7142-0974 | 15mm   |
| 7142-0976 | 20mm   |
| 7142-0978 | 25mm   |
| 7142-0980 | 30mm   |
| 7142-0982 | 35mm   |
| 7142-0984 | 40mm   |
| 7142-0986 | 45mm   |
| 7142-0988 | 50mm   |



### Oval Patellar Implant

VHMWPE (ASTM 5648)

(Not shown)

| Cat. #    | Length | Height |
|-----------|--------|--------|
| 7142-1029 | 29mm   | 8.5mm  |
| 7142-1032 | 32mm   | 9.0mm  |
| 7142-1035 | 35mm   | 9.0mm  |
| 7142-1038 | 38mm   | 9.5mm  |
| 7142-1041 | 41mm   | 10.0mm |

### Finned Fixation Peg

Base-Titanium Alloy

| Cat. #    | Size |
|-----------|------|
| 7142-0990 | 1-2  |
| 7142-0992 | 3-4  |
| 7142-0994 | 5-6  |
| 7142-0996 | 7-8  |



### Patellar Implant with Flex-Lok Peg, 15mm

VHMWPE (ASTM 5648)

| Cat. #    | Length |
|-----------|--------|
| 7142-0582 | 23mm   |
| 7142-0584 | 26mm   |
| 7142-0586 | 29mm   |
| 7142-0588 | 32mm   |



### Nonporous Tibial Implant-Left

Base-Titanium Alloy

| Cat. #    | Size |
|-----------|------|
| 7142-0160 | 1    |
| 7142-0162 | 2    |
| 7142-0164 | 3    |
| 7142-0166 | 4    |
| 7142-0168 | 5    |
| 7142-0170 | 6    |
| 7142-0172 | 7    |
| 7142-0174 | 8    |



### Porous Tibial Implant-Right

Base-Titanium Alloy

| Cat. #    | Size |
|-----------|------|
| 7142-0208 | 1    |
| 7142-0210 | 2    |
| 7142-0212 | 3    |
| 7142-0214 | 4    |
| 7142-0216 | 5    |
| 7142-0218 | 6    |
| 7142-0220 | 7    |
| 7142-0222 | 8    |



### Nonporous Tibial Implant-Right

Base-Titanium Alloy

| Cat. #    | Size |
|-----------|------|
| 7142-0176 | 1    |
| 7142-0180 | 2    |
| 7142-0182 | 3    |
| 7142-0184 | 4    |
| 7142-0186 | 5    |
| 7142-0188 | 6    |
| 7142-0190 | 7    |
| 7142-0191 | 8    |



### Genesis II Total Knee System/All-Polyethylene Base Tibial Implants

#### Cruciate-Retaining All-Polyethylene Tibial Implant-Left

UHMWPE (ASTM F 648)

| Cat. #    | Size | Diameter |
|-----------|------|----------|
| 7142-0224 | 1    | 9mm      |
| 7142-0226 | 1    | 11mm     |
| 7142-0228 | 1    | 13mm     |
| 7142-0230 | 1    | 15mm     |
| 7142-0232 | 2    | 9mm      |
| 7142-0234 | 2    | 11mm     |
| 7142-0236 | 2    | 13mm     |
| 7142-0238 | 2    | 15mm     |
| 7142-0240 | 3    | 9mm      |
| 7142-0242 | 3    | 11mm     |
| 7142-0244 | 3    | 13mm     |
| 7142-0246 | 3    | 15mm     |
| 7142-0248 | 4    | 9mm      |
| 7142-0250 | 4    | 11mm     |
| 7142-0252 | 4    | 13mm     |
| 7142-0254 | 4    | 15mm     |
| 7142-0256 | 5    | 9mm      |
| 7142-0258 | 5    | 11mm     |
| 7142-0260 | 5    | 13mm     |
| 7142-0262 | 5    | 15mm     |
| 7142-0264 | 6    | 9mm      |
| 7142-0266 | 6    | 11mm     |
| 7142-0268 | 6    | 13mm     |
| 7142-0270 | 6    | 15mm     |
| 7142-0272 | 7    | 9mm      |
| 7142-0274 | 7    | 11mm     |
| 7142-0276 | 7    | 13mm     |

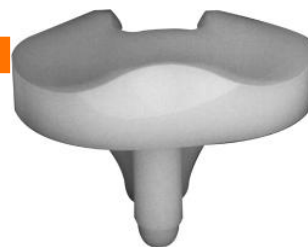

### Porous Tibial Implant-Left

Base-Titanium Alloy

| Cat. #    | Size |
|-----------|------|
| 7142-0192 | 1    |
| 7142-0194 | 2    |
| 7142-0196 | 3    |
| 7142-0198 | 4    |
| 7142-0200 | 5    |
| 7142-0202 | 6    |
| 7142-0204 | 7    |
| 7142-0206 | 8    |



### Cruciate-Retaining All-Polyethylene Tibial Implant-Left

UHMWPE (ASTM F 648)

| Cat. #    | Size | Diameter |
|-----------|------|----------|
| 7142-0278 | 7    | 15mm     |
| 7142-0280 | 8    | 9mm      |
| 7142-0282 | 8    | 11mm     |
| 7142-0284 | 8    | 13mm     |
| 7142-0286 | 8    | 15mm     |

### Cruciate-Retaining All-Polyethylene Tibial Implant-Right

UHMWPE (ASTM F 648)

| Cat. #    | Size | Diameter |
|-----------|------|----------|
| 7142-0288 | 1    | 9mm      |
| 7142-0290 | 1    | 11mm     |
| 7142-0292 | 1    | 13mm     |
| 7142-0294 | 1    | 15mm     |
| 7142-0296 | 2    | 9mm      |
| 7142-0298 | 2    | 11mm     |
| 7142-0300 | 2    | 13mm     |
| 7142-0302 | 2    | 15mm     |
| 7142-0304 | 3    | 9mm      |
| 7142-0306 | 3    | 11mm     |
| 7142-0308 | 3    | 13mm     |
| 7142-0310 | 3    | 15mm     |
| 7142-0312 | 4    | 9mm      |
| 7142-0314 | 4    | 11mm     |
| 7142-0316 | 4    | 13mm     |
| 7142-0318 | 4    | 15mm     |
| 7142-0320 | 5    | 9mm      |
| 7142-0322 | 5    | 11mm     |
| 7142-0324 | 5    | 13mm     |
| 7142-0326 | 5    | 15mm     |
| 7142-0328 | 6    | 9mm      |
| 7142-0330 | 6    | 11mm     |
| 7142-0332 | 6    | 13mm     |
| 7142-0334 | 6    | 15mm     |
| 7142-0336 | 7    | 9mm      |
| 7142-0338 | 7    | 11mm     |
| 7142-0340 | 7    | 13mm     |
| 7142-0342 | 7    | 15mm     |
| 7142-0344 | 8    | 9mm      |
| 7142-0346 | 8    | 11mm     |
| 7142-0348 | 8    | 13mm     |
| 7142-0350 | 8    | 15mm     |

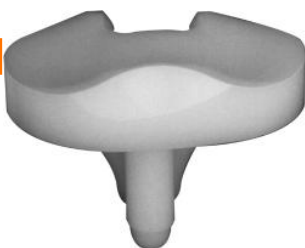

### Posterior-Stabilized All-Poly Tibial Implants-Left

UHMWPE (ASTM F 648)

| Cat. #    | Size | Diameter |
|-----------|------|----------|
| 7142-0352 | 1    | 9mm      |
| 7142-0354 | 1    | 11mm     |
| 7142-0356 | 1    | 13mm     |
| 7142-0358 | 1    | 15mm     |
| 7142-0360 | 2    | 9mm      |
| 7142-0362 | 2    | 11mm     |
| 7142-0364 | 2    | 13mm     |
| 7142-0366 | 2    | 15mm     |
| 7142-0368 | 3    | 9mm      |
| 7142-0370 | 3    | 11mm     |
| 7142-0372 | 3    | 13mm     |
| 7142-0374 | 3    | 15mm     |
| 7142-0376 | 4    | 9mm      |
| 7142-0378 | 4    | 11mm     |
| 7142-0380 | 4    | 13mm     |
| 7142-0382 | 4    | 15mm     |
| 7142-0384 | 5    | 9mm      |
| 7142-0386 | 5    | 11mm     |
| 7142-0388 | 5    | 13mm     |
| 7142-0390 | 5    | 15mm     |
| 7142-0392 | 6    | 9mm      |
| 7142-0394 | 6    | 11mm     |
| 7142-0396 | 6    | 13mm     |
| 7142-0398 | 6    | 15mm     |
| 7142-0400 | 7    | 9mm      |
| 7142-0402 | 7    | 11mm     |
| 7142-0404 | 7    | 13mm     |
| 7142-0406 | 7    | 15mm     |
| 7142-0408 | 8    | 9mm      |
| 7142-0410 | 8    | 11mm     |
| 7142-0412 | 8    | 13mm     |
| 7142-0414 | 8    | 15mm     |



### Posterior-Stabilized All-Poly Tibial Implants-Right

UHMWPE (ASTM F 648)

| Cat. #    | Size | Diameter |
|-----------|------|----------|
| 7142-0416 | 1    | 9mm      |
| 7142-0418 | 1    | 11mm     |
| 7142-0420 | 1    | 13mm     |
| 7142-0422 | 1    | 15mm     |
| 7142-0424 | 2    | 9mm      |
| 7142-0426 | 2    | 11mm     |
| 7142-0428 | 2    | 13mm     |
| 7142-0430 | 2    | 15mm     |
| 7142-0432 | 3    | 9mm      |





# Reconstructive Surgery

## Knee Systems

### Posterior-Stabilized All-Poly Tibial Implants-Right UHMWPE (ASTM F 648)

| Cat. #    | Size | Diameter |
|-----------|------|----------|
| 7142-0434 | 3    | 11mm     |
| 7142-0436 | 3    | 13mm     |
| 7142-0438 | 3    | 15mm     |
| 7142-0440 | 4    | 9mm      |
| 7142-0442 | 4    | 11mm     |
| 7142-0444 | 4    | 13mm     |
| 7142-0446 | 4    | 15mm     |
| 7142-0448 | 5    | 9mm      |
| 7142-0450 | 5    | 11mm     |
| 7142-0452 | 5    | 13mm     |
| 7142-0454 | 5    | 15mm     |
| 7142-0456 | 6    | 9mm      |
| 7142-0458 | 6    | 11mm     |
| 7142-0460 | 6    | 13mm     |
| 7142-0462 | 6    | 15mm     |
| 7142-0464 | 7    | 9mm      |
| 7142-0466 | 7    | 11mm     |
| 7142-0468 | 7    | 13mm     |
| 7142-0470 | 7    | 15mm     |
| 7142-0472 | 8    | 9mm      |
| 7142-0474 | 8    | 11mm     |
| 7142-0476 | 8    | 13mm     |
| 7142-0478 | 8    | 15mm     |

### Genesis II Total Knee System/Cruciate-Retaining Articular Inserts

#### Cruciate-Retaining Articular Insert UHMWPE (ASTM F 648)

| Cat. #    | Size | Diameter |
|-----------|------|----------|
| 7142-0480 | 1-2  | 9mm      |
| 7142-0482 | 1-2  | 11mm     |
| 7142-0484 | 1-2  | 13mm     |
| 7142-0486 | 1-2  | 15mm     |
| 7142-0488 | 1-2  | 18mm     |
| 7142-0490 | 3-4  | 9mm      |
| 7142-0492 | 3-4  | 11mm     |
| 7142-0494 | 3-4  | 13mm     |
| 7142-0496 | 3-4  | 15mm     |
| 7142-0500 | 5-6  | 9mm      |
| 7142-0502 | 5-6  | 11mm     |
| 7142-0504 | 5-6  | 13mm     |
| 7142-0506 | 5-6  | 15mm     |



### Cruciate-Retaining Articular Insert UHMWPE (ASTM F 648)

| Cat. #    | Size | Diameter |
|-----------|------|----------|
| 7142-0508 | 5-6  | 18mm     |
| 7142-0510 | 7-8  | 9mm      |
| 7142-0512 | 7-8  | 11mm     |
| 7142-0514 | 7-8  | 13mm     |
| 7142-0516 | 7-8  | 15mm     |
| 7142-0518 | 7-8  | 18mm     |

### Dished Articular Insert UHMWPE (ASTM F 648)

| Cat. No.  | Size | Diameter |
|-----------|------|----------|
| 7142-0754 | 1-2  | 9mm      |
| 7142-0756 | 1-2  | 11mm     |
| 7142-0758 | 1-2  | 13mm     |
| 7142-0760 | 1-2  | 15mm     |
| 7142-0762 | 1-2  | 18mm     |
| 7142-0764 | 1-2  | 21mm     |
| 7142-0766 | 3-4  | 9mm      |
| 7142-0768 | 3-4  | 11mm     |
| 7142-0770 | 3-4  | 13mm     |
| 7142-0772 | 3-4  | 15mm     |
| 7142-0774 | 3-4  | 18mm     |
| 7142-0776 | 3-4  | 21mm     |
| 7142-0778 | 5-6  | 9mm      |
| 7142-0780 | 5-6  | 11mm     |
| 7142-0782 | 5-6  | 13mm     |
| 7142-0784 | 5-6  | 15mm     |
| 7142-0786 | 5-6  | 18mm     |
| 7142-0788 | 5-6  | 21mm     |
| 7142-0790 | 7-8  | 9mm      |
| 7142-0792 | 7-8  | 11mm     |
| 7142-0794 | 7-8  | 13mm     |
| 7142-0796 | 7-8  | 15mm     |
| 7142-0798 | 7-8  | 18mm     |
| 7142-0800 | 7-8  | 21mm     |



### Genesis II Total Knee System/Posterior-Stabilized/Constrained Articular Inserts

## Constrained Articular Insert UHMWPE (ASTM F 648)

| Cat. #    | Size | Length |
|-----------|------|--------|
| 7142-0960 | 1-2  | 11mm   |
| 7142-0962 | 1-2  | 13mm   |
| 7142-0964 | 1-2  | 15mm   |
| 7142-0966 | 1-2  | 18mm   |
| 7142-0968 | 1-2  | 21mm   |
| 7142-0970 | 1-2  | 25mm   |
| 7142-0972 | 1-2  | 30mm   |
| 7142-0524 | 3-4  | 11mm   |
| 7142-0526 | 3-4  | 13mm   |
| 7142-0528 | 3-4  | 15mm   |
| 7142-0530 | 3-4  | 18mm   |
| 7142-0532 | 3-4  | 21mm   |
| 7142-0534 | 3-4  | 25mm   |
| 7142-0536 | 3-4  | 30mm   |
| 7142-0538 | 5-6  | 11mm   |
| 7142-0540 | 5-6  | 13mm   |
| 7142-0542 | 5-6  | 15mm   |
| 7142-0544 | 5-6  | 18mm   |
| 7142-0546 | 5-6  | 21mm   |
| 7142-0548 | 5-6  | 25mm   |
| 7142-0550 | 5-6  | 30mm   |
| 7142-0552 | 7-8  | 11mm   |
| 7142-0554 | 7-8  | 13mm   |
| 7142-0556 | 7-8  | 15mm   |
| 7142-0558 | 7-8  | 18mm   |
| 7142-0560 | 7-8  | 21mm   |
| 7142-0562 | 7-8  | 25mm   |
| 7142-0564 | 7-8  | 30mm   |



## Posterior-Stabilized Articular Insert UHMWPE (ASTM F 648)

| Cat. #    | Size | Diameter |
|-----------|------|----------|
| 7142-0828 | 3-4  | 25mm     |
| 7142-0830 | 5-6  | 9mm      |
| 7142-0832 | 5-6  | 11mm     |
| 7142-0834 | 5-6  | 13mm     |
| 7142-0836 | 5-6  | 15mm     |
| 7142-0838 | 5-6  | 18mm     |
| 7142-0840 | 5-6  | 21mm     |
| 7142-0842 | 5-6  | 25mm     |
| 7142-0844 | 7-8  | 9mm      |
| 7142-0846 | 7-8  | 11mm     |
| 7142-0848 | 7-8  | 13mm     |
| 7142-0850 | 7-8  | 15mm     |
| 7142-0852 | 7-8  | 18mm     |
| 7142-0854 | 7-8  | 21mm     |
| 7142-0856 | 7-8  | 25mm     |

## Genesis II Total Knee System/Femoral Conversion Module and Femoral Wedges

### Conversion Module with Taper-Left Cobalt Chromium (ASTM F 75)

| Cat. #    | Size |
|-----------|------|
| 7142-0596 | 1    |
| 7142-0598 | 2    |
| 7142-0600 | 3    |
| 7142-0602 | 4    |
| 7142-0604 | 5    |
| 7142-0606 | 6    |
| 7142-0608 | 7    |
| 7142-0610 | 8    |



## Posterior-Stabilized Articular Insert UHMWPE (ASTM F 648)

| Cat. #    | Size | Diameter |
|-----------|------|----------|
| 7142-0802 | 1-2  | 9mm      |
| 7142-0804 | 1-2  | 11mm     |
| 7142-0806 | 1-2  | 13mm     |
| 7142-0808 | 1-2  | 15mm     |
| 7142-0810 | 1-2  | 18mm     |
| 7142-0812 | 1-2  | 21mm     |
| 7142-0814 | 1-2  | 25mm     |
| 7142-0816 | 3-4  | 9mm      |
| 7142-0818 | 3-4  | 11mm     |
| 7142-0820 | 3-4  | 13mm     |
| 7142-0822 | 3-4  | 15mm     |
| 7142-0824 | 3-4  | 18mm     |
| 7142-0826 | 3-4  | 21mm     |



### Conversion Module with Taper-Right Cobalt Chromium (ASTM F 75)

| Cat. #    | Size |
|-----------|------|
| 7142-0612 | 1    |
| 7142-0614 | 2    |
| 7142-0616 | 3    |
| 7142-0618 | 4    |
| 7142-0620 | 5    |
| 7142-0622 | 6    |
| 7142-0624 | 7    |



### Conversion Module with Taper-Right

Cobalt Chromium (ASTM F 75)

| Cat. #    | Size |
|-----------|------|
| 7142-0626 | 8    |

### Distal Femoral Wedge, 5mm

Cobalt Chromium (ASTM F 75)

| Cat. #    | Size |
|-----------|------|
| 7142-0664 | 1    |
| 7142-0665 | 2    |
| 7142-0666 | 3    |
| 7142-0667 | 4    |
| 7142-0668 | 5    |
| 7142-0669 | 6    |
| 7142-0670 | 7    |
| 7142-0671 | 8    |



### Posterior Femoral Wedge

Cobalt Chromium (ASTM F 75)

| Cat. #    | Size | Length |
|-----------|------|--------|
| 7142-0678 | 1-2  | 5 LG   |
| 7142-0680 | 3-4  | 5 LG   |
| 7142-0682 | 5-6  | 5 LG   |
| 7142-0684 | 7-8  | 5 LG   |
| 7142-0686 | 1-2  | 5 SH   |
| 7142-0688 | 3-4  | 5 SH   |
| 7142-0690 | 5-6  | 5 SH   |
| 7142-0692 | 7-8  | 5 SH   |
| 7142-0694 | 3-4  | 10 SH  |
| 7142-0708 | 3-4  | 10 XS  |
| 7142-0710 | 5-6  | 10 XS  |
| 7142-0712 | 7-8  | 10 XS  |
| 7142-0696 | 5-6  | 10SH   |
| 7142-0698 | 7-8  | 10SH   |
| 7142-0700 | 1-2  | 5XS    |
| 7142-0702 | 3-4  | 5XS    |
| 7142-0704 | 5-6  | 5XS    |
| 7142-0706 | 7-8  | 5XS    |



### Stacked Distal L-Wedge

Cobalt Chromium (ASTM F 75)

| Cat. No.  | Size |
|-----------|------|
| 7142-0672 | 3    |
| 7142-0673 | 4    |
| 7142-0674 | 5    |
| 7142-0675 | 6    |
| 7142-0676 | 7    |
| 7142-0678 | 8    |



### Genesis II Total Knee System/Tibial Wedges and Long Stems

#### 7° Full Tibial Wedge

Ti-6Al-4V

| Cat. No.  | Size |
|-----------|------|
| 7142-0001 | 1-2  |
| 7142-0005 | 3-4  |
| 7142-0009 | 5-6  |
| 7142-0013 | 7-8  |



#### Angeled Hemi Wedge

Ti-6Al-4V

| Cat. #    | Size | Position |
|-----------|------|----------|
| 7142-0714 | 1-2  | 20°      |
| 7142-0716 | 3-4  | 20°      |
| 7142-0718 | 5-6  | 20°      |
| 7142-0720 | 7-8  | 20°      |
| 7142-0722 | 1-2  | 30°      |
| 7142-0724 | 3-4  | 30°      |
| 7142-0726 | 5-6  | 30°      |
| 7142-0728 | 7-8  | 30°      |



#### Long Stem

Ti-6Al-4V

| Cat. #    | Diameter | Length |
|-----------|----------|--------|
| 7142-0628 | 10mm *   | 100mm  |
| 7142-0630 | 12mm *   | 100mm  |
| 7142-0632 | 14mm *   | 100mm  |
| 7142-0634 | 16mm *   | 100mm  |
| 7142-0636 | 18mm *   | 100mm  |



## Long Stem

Ti-6Al-4V

| Cat. #    | Diameter | Length |
|-----------|----------|--------|
| 7142-0638 | 20mm *   | 100mm  |
| 7142-0640 | 22mm *   | 100mm  |
| 7142-0642 | 24mm *   | 100mm  |
| 7142-0644 | 10mm *   | 150mm  |
| 7142-0646 | 12mm ^   | 150mm  |
| 7142-0648 | 14mm ^   | 150mm  |
| 7142-0650 | 16mm ^   | 150mm  |
| 7142-0652 | 18mm ^   | 150mm  |
| 7142-0654 | 20mm ^   | 150mm  |
| 7142-0656 | 10mm ^   | 200mm  |
| 7142-0658 | 12mm ^   | 200mm  |
| 7142-0660 | 14mm ^   | 200mm  |
| 7142-0662 | 16mm ^   | 200mm  |

\* Non-Slotted Stem ^ Slotted Stem

## Anterior Femoral Sizing Stylus

References off the anterior cortex of the femur.

| Cat. No.  |
|-----------|
| 7144-0022 |



## Anterior-Posterior Cutting Block

Prepares femur to accept femoral trial. Cuts include anterior, anterior chamfer, posterior and posterior chamfer.

| Cat. No.  | Size |
|-----------|------|
| 7144-0084 | 3    |
| 7144-0086 | 4    |
| 7144-0088 | 5    |
| 7144-0090 | 6    |



## Medial-Lateral Wedge

Ti-6Al-4V

| Cat. #    | Size |
|-----------|------|
| 7142-0746 | 1-2  |
| 7142-0748 | 3-4  |
| 7142-0750 | 5-6  |
| 7142-0752 | 7-8  |



## Distal Femoral Cutting Block

Resects Distal Femur.

| Cat. No.  | Description |
|-----------|-------------|
| 7144-0024 | Slotted     |
| 7144-0026 | Non-Slotted |

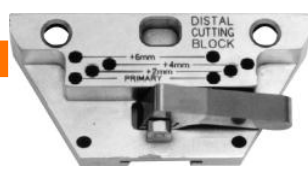

## Stepped Hemi Wedge

Ti-6Al-4V

| Cat. #    | Size | Length |
|-----------|------|--------|
| 7142-0730 | 1-2  | 10mm   |
| 7142-0732 | 3-4  | 10mm   |
| 7142-0734 | 5-6  | 10mm   |
| 7142-0736 | 7-8  | 10mm   |
| 7142-0738 | 1-2  | 15mm   |
| 7142-0740 | 3-4  | 15mm   |
| 7142-0742 | 5-6  | 15mm   |
| 7142-0744 | 7-8  | 15mm   |



## Distal Femoral Resection Stylus

Slides in Distal Cutting Block to ensure correct placement on the femur.

| Cat. No.  |
|-----------|
| 7144-0028 |



## Genesis II Total Knee System/Instrumentation/Femoral Tray, Sizes 3-6

# Reconstructive Surgery

## Knee Systems

### Extended 6° Valgus Bushing

Use with the Valgus Alignment Guide to set Valgus angle on large knees.

| Cat. No.  | Position |
|-----------|----------|
| 7144-0422 | Left     |
| 7144-0420 | Right    |

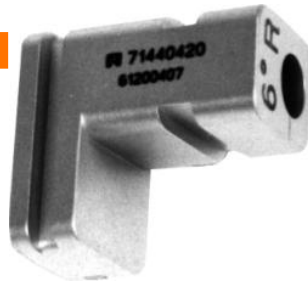

### Femoral Lug Trial

Screws into Femoral Trial to secure M/L position (Six per tray).

| Cat. No.  |
|-----------|
| 7143-0864 |



### Femoral Tray, Sizes 3-6

| Cat. No.  |
|-----------|
| 7144-0870 |

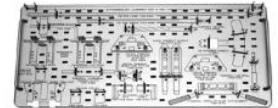

### Extramedullary Alignment Rod

Use to double check knee alignment. Two rods can be screwed together for hip-to-ankle check.

| Cat. No. |
|----------|
| 11-4861  |



### Femoral Alignment Viewing Template

Provides a reference line in relation to the epicondyles and patellar groove. Assists in setting valgus angle.

| Cat. No.  |
|-----------|
| 7144-0426 |



### Femoral Valgus Alignment Guide, Size 3-8

Use for setting femoral valgus alignment angle and determining femoral component size.

| Cat. No.  |
|-----------|
| 7144-0012 |



### Femoral Instrumentation Outer Case (Not shown)

| Cat. No.  |
|-----------|
| 7144-0760 |

### Intramedullary Rod

Provides a reference guide for femoral and tibial cutting blocks.

| Cat. No.  | Size      |
|-----------|-----------|
| 7144-0006 | 8 inches  |
| 7144-0004 | 16 inches |



### Femoral Intramedullary Drill; 9.5mm

Opens intramedullary canal of the femur.

| Cat. No.  |
|-----------|
| 7144-0002 |



### Lower Module, Size 3-4

| Cat. No.  |
|-----------|
| 7144-0804 |

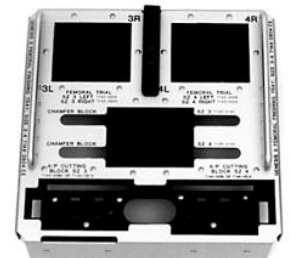

### Femoral Lug Punch

use to punch holes in femoral condyles to prepare for lugs.

| Cat. No.  |
|-----------|
| 7144-0183 |



## Lower Module, Size 5-6

Cat. No.  
7144-0806



## Quick Release T-Handle

Connects to end of Intramedullary Rod.

Cat. No.  
11-6011



## Modular Femoral Slot

Use with nonslotted femoral Blocks when additional stability for a cut is needed.

Cat. No.  
7144-0078



## Quick-Connect Handles/Alignment Tower

Attaches to cutting blocks to provide extra stability and for extramedullary alignment checks (Two per tray).

Cat. No.  
7144-0044



## Nonporous Cruciate-Retaining Femoral Trial

Place on resected femur to assess M/L positioning and to perform trial range of motion.

| Cat. No.  | Size | Position |
|-----------|------|----------|
| 7143-0004 | 3    | Left     |
| 7143-0006 | 4    | Left     |
| 7143-0008 | 5    | Left     |
| 7143-0010 | 6    | Left     |
| 7143-0020 | 3    | Right    |
| 7143-0022 | 4    | Right    |
| 7143-0024 | 5    | Right    |
| 7143-0026 | 6    | Right    |



## Reference Sizing Guide, Size 3-8

Use with the Valgus Alignment Guide to determine femoral sizing.

| Cat. No.  | Description |
|-----------|-------------|
| 7144-0030 | Anterior    |
| 7144-0032 | Posterior   |



## Primary Chamfer Cutting Block

Provides a nonslotted alternative for making anterior and posterior chamfer cuts.

| Cat. No.  | Size |
|-----------|------|
| 7144-0100 | 3    |
| 7144-0102 | 4    |
| 7144-0104 | 5    |
| 7144-0106 | 6    |



## Upper Tray

Cat. No.  
7144-0762

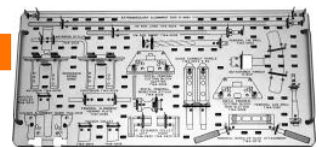

## Valgus Bushing

Assemble with the Valgus Alignment Guide to set the cutting blocks at the desired angle.

| Cat. No.  | Position |
|-----------|----------|
| 7144-0014 | 5°       |
| 7144-0016 | 6°       |
| 7144-0018 | 7°       |



### Genesis II Total Knee System/Instrumentation/Finishing Tray, Sizes 1-2

#### \*Nonporous Fin-Stem Tibial Punch

| Cat. No.  | Size |
|-----------|------|
| 7144-0480 | 1-2  |



\*Optional Piece for set.

#### \*Stemless Nonporous Tibial Trial

| Cat. No.  | Size | Position |
|-----------|------|----------|
| 7143-0161 | 1    | Left     |
| 7143-0163 | 2    | Left     |
| 7143-0177 | 1    | Right    |
| 7143-0179 | 2    | Right    |

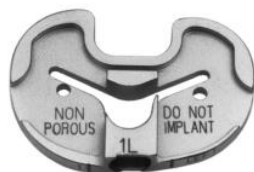

\*Optional piece for set.

#### Anterior-Posterior Cutting Block

Prepares femur to accept femoral trial. Cuts include anterior, anterior chamfer, posterior and posterior chamfer.

| Cat. No.  | Size |
|-----------|------|
| 7144-0080 | 1    |
| 7144-0082 | 2    |



#### Articular Insert Spacer Trial

Snaps into bottom of 9mm Articular Insert Trial to increase trial thickness.

| Cat. No.  | Size | Diameter |
|-----------|------|----------|
| 7143-0224 | 1-2  | 13mm     |
| 7143-0232 | 1-2  | 15mm     |
| 7143-0240 | 1-2  | 18mm     |
| 7143-0248 | 1-2  | 21mm     |
| 7143-0256 | 1-2  | 25mm     |



#### Cruciate-Retaining Articular Trial

Slides into Tibial Trial to check flexion/extension gap and range of motion.

| Cat. No.  | Size | Diameter |
|-----------|------|----------|
| 7143-0480 | 1-2  | 9mm      |
| 7143-0482 | 1-2  | 11mm     |



#### Cruciate-Retaining Femoral Trial

Place on resected femur to assess M/L positioning and to perform trial range of motion.

| Cat. No.  | Size | Position |
|-----------|------|----------|
| 7143.0000 | 1    | Left     |
| 7143-0002 | 2    | Left     |
| 7143-0016 | 1    | Right    |
| 7143-0018 | 2    | Right    |



#### Dished Articular Trial

Slides into Tibial Trial to check flexion/extension gap and range of motion.

| Cat. No.  | Size | Diameter |
|-----------|------|----------|
| 7143-0754 | 1-2  | 9mm      |
| 7143-0756 | 1-2  | 11mm     |



#### Femoral Lug Trial

Screws into holes in Femoral Trial to hold M/L placement (Three per tray).

| Cat. No.  |
|-----------|
| 7143-0864 |



### Femoral Tray

Cat. No.  
7144-0802



### Nonporous Tibial Trial

Place on resected proximal tibia to punch for tibial fins and for trial range of motion.

| Cat. No.  | Size | Position |
|-----------|------|----------|
| 7143-0160 | 1    | Left     |
| 7143-0162 | 2    | Left     |
| 7143-0176 | 1    | Right    |
| 7143-0178 | 2    | Right    |



### Femoral Valgus Alignment Guide, Size 1-6

Use for setting femoral valgus alignment angle and determining femoral component size.

Cat. No.  
7144-0412



### Posterior-Stabilized Articular Trial

Slides into Tibial Trial to check flexion/extension gap and range of motion.

| Cat. No.  | Size | Diameter |
|-----------|------|----------|
| 7143-0801 | 1-2  | 9mm      |
| 7143-0803 | 1-2  | 11mm     |



### Finishing Tray Outer Case

Cat. No. Size  
7144-0770 1-2

### Primary Chamfer Cutting Block

Provides a nonslotted alternative for making anterior and posterior chamfer cuts.

| Cat. No.  | Size |
|-----------|------|
| 7144-0096 | 1    |
| 7144-0098 | 2    |



### Finishing Tray, Sizes 1-2

Cat. No.  
7144-0700



### Reference Sizing Guide, Size 1-6

Use in conjunction with Size 1-6 valgus Alignment Guide to determine femoral sizing.

| Cat. No.  | Position  |
|-----------|-----------|
| 7144-0414 | Posterior |
| 7144-0416 | Anterior  |



### Nonporous Tibial Fin Punch

Punches for Tibial Fins.

Cat. No. Size  
7144-0264 1-2





# Reconstructive Surgery

## Knee Systems

### Tibial Drill Guide

Use with the Tibial Collets to drill and punch for the tibial trial tray.

| Cat. No.  | Size |
|-----------|------|
| 7144-0230 | 1    |
| 7144-0232 | 2    |



### Tibial Tray

| Cat. No.  |
|-----------|
| 7144-0772 |

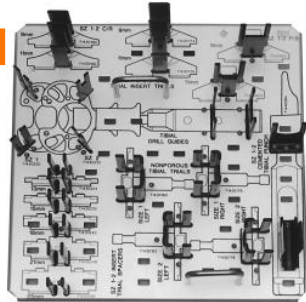

### Genesis II Total Knee System/Instrumentation/Finishing Tray, Sizes 7-8

#### \*Nonporous Fin-Stem Tibial Punch

| Cat. No.  | Size |
|-----------|------|
| 7144-0486 | 7-8  |



\* Optional piece for the set.

#### \*Stemless Nonporous Tibial Trial

| Cat. No.  | Size | Position |
|-----------|------|----------|
| 7143-0173 | 7    | Left     |
| 7143-0175 | 8    | Left     |
| 7143-0189 | 7    | Right    |
| 7143-0191 | 8    | Right    |



\* Optional piece for the set.

### Anterior-Posterior Cutting Block

Prepares femur to accept femoral trial. Cuts include anterior, anterior chamfer, posterior and posterior chamfer.

| Cat. No.  | Size |
|-----------|------|
| 7144-0092 | 7    |
| 7144-0094 | 8    |



### Articular Insert Spacer Trial

Snaps into bottom of 9mm Articular Insert Trial to increase trial thickness.

| Cat. No.  | Size | Diameter |
|-----------|------|----------|
| 7143-0230 | 7-8  | 13mm     |
| 7143-0238 | 7-8  | 15mm     |
| 7143-0246 | 7-8  | 18mm     |
| 7143-0254 | 7-8  | 21mm     |
| 7143-0262 | 7-8  | 25mm     |



### Cruciate-Retaining Articular Trial

Slides into Tibial Trial to check flexion/extension gap and range of motion.

| Cat. No.  | Size | Diameter |
|-----------|------|----------|
| 7143-0510 | 7-8  | 9mm      |
| 7143-0512 | 7-8  | 11mm     |



### Cruciate-Retaining Femoral Trial

Place on resected femur to assess M/L positioning and to perform trial range of motion.

| Cat. No.  | Size | Position |
|-----------|------|----------|
| 7143-0012 | 7    | Left     |
| 7143-0014 | 8    | Left     |
| 7143-0028 | 7    | Right    |
| 7143-0030 | 8    | Right    |



## Dished Articular Trial

Slides into Tibial Trial check flexion/extension gap and range of motion.

| Cat. No.  | Size | Diameter |
|-----------|------|----------|
| 7143-0789 | 7-9  | 9mm      |
| 7143-0791 | 7-8  | 11mm     |



## Finishing Tray, Sizes 7-8

| Cat. No.  |
|-----------|
| 7144-0900 |



## Femoral Lug Trial

Screws into Femoral Trial to secure M/L placement (Three per tray).

| Cat. No.  |
|-----------|
| 7143-0864 |



## Nonporous Tibial Fin Punch

Punches for Tibial Fins.

| Cat. No.  | Size |
|-----------|------|
| 7144-0270 | 7-8  |



## Femoral Tray

| Cat. No.  |
|-----------|
| 7144-0808 |



## Nonporous Tibial Trial

Place on resected proximal tibia to punch for tibial fins and for trial range of motion.

| Cat. No.  | Size | Position |
|-----------|------|----------|
| 7143-0172 | 7    | Left     |
| 7143-0174 | 8    | Left     |
| 7143-0188 | 7    | Right    |
| 7143-0190 | 8    | Right    |



## Finishing Tray Outer Case

(Not shown)

| Cat. No.  | Size |
|-----------|------|
| 7144-0780 | 7-8  |

## Posterior-Stabilized Articular Trial

Slides into Tibial Trial to check flexion/extension gap and range of motion.

| Cat. No.  | Size | Diameter |
|-----------|------|----------|
| 7143-0844 | 7-8  | 9mm      |
| 7143-0846 | 7-8  | 11mm     |



## Primary Chamfer Cutting Block

Provides a nonslotted alternative for making anterior/posterior chamfer cuts.

| Cat. No.  | Size |
|-----------|------|
| 7144-0108 | 7    |
| 7144-0110 | 8    |



# Reconstructive Surgery

## Knee Systems

### Tibial Drill Guide

use with Tibial Collets to drill and punch for the tibial trial tray.

| Cat. No.  | Size |
|-----------|------|
| 7144-0242 | 7    |
| 7144-0244 | 8    |



### Tibial Tray

| Cat. No.  |
|-----------|
| 7144-0782 |

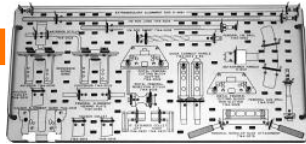

### Genesis II Total Knee System/Instrumentation/Long Stem Sterile Tray

### Femoral Trial Stem Adaptor

Screws into Housing resection Blocks to attach the long stem trial for connect placement and stability.

| Cat. No.  |
|-----------|
| 7144-0184 |



### Long Stem Extractor

Screws into end of stem and trial to assist in removal and for intramedullary tibial alignment.

| Cat. No.  |
|-----------|
| 7144-0186 |



### Long Stem Reamer

Reams femoral and tibial intramedullary canal to prepare for a long stem. Marked in 100mm, 150mm and 200mm increments.

| Cat. No.  | Size |
|-----------|------|
| 7144-0166 | 10mm |
| 7144-0168 | 12mm |
| 7144-0170 | 14mm |
| 7144-0172 | 16mm |
| 7144-0174 | 18mm |
| 7144-0176 | 20mm |



### Long Stem Reamer

Reams femoral and tibial intramedullary canal to prepare for a long stem. Marked in 100mm, 150mm and 200mm increments.

| Cat. No.  | Size |
|-----------|------|
| 7144-0178 | 22mm |
| 7144-0180 | 24mm |

### Long Stem Sterile Tray

| Cat. No.  |
|-----------|
| 7144-0980 |

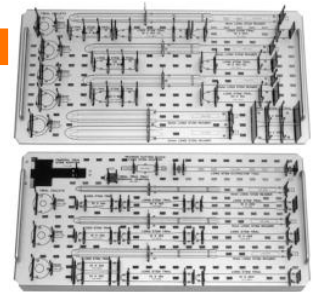

### Long Stem Trial

Attaches to femoral conversion module trial and tibial base trial to test fit and determine range of motion.

| Cat. No.  | Size  | Length (mm) |
|-----------|-------|-------------|
| 7143-0628 | 10mm  | 100         |
| 7143-0630 | 12mm  | 100         |
| 7143-0632 | 14mm* | 100         |
| 7143-0634 | 16mm* | 100         |
| 7143-0636 | 18mm* | 100         |
| 7143-0638 | 20mm  | 100         |
| 7143-0640 | 22mm  | 100         |
| 7143-0642 | 24mm  | 100         |
| 7143-0644 | 10mm  | 150         |
| 7143-0646 | 12mm  | 150         |
| 7143-0648 | 14mm  | 150         |
| 7143-0650 | 16mm* | 150         |
| 7143-0652 | 18mm* | 150         |
| 7143-0654 | 20mm* | 150         |
| 7143-0656 | 10mm  | 200         |
| 7143-0658 | 12mm  | 200         |
| 7143-0660 | 14mm  | 200         |
| 7143-0662 | 16mm  | 200         |



\* Two per tray

### Revision Cutting Block Long Stem Adaptor

Attaches trial stem onto Revision Cutting Blocks for correct placement and stability.

Cat. No. [redacted]  
7144-0454



### Tibial Collet

use with Tibial Drill Guide to ream for a long stem.

| Cat. No.  | Size |
|-----------|------|
| 7144-0246 | 10mm |
| 7144-0248 | 12mm |
| 7144-0250 | 14mm |
| 7144-0252 | 16mm |
| 7144-0254 | 18mm |
| 7144-0256 | 20mm |
| 7144-0258 | 22mm |
| 7144-0260 | 24mm |



### Tibial Trial Removal Adaptor

Cat. No. [redacted]  
7144-0187



### Genesis II Total Knee System/Instrumentation/Miscellaneous

#### Bone Spikes

| Cat. No.  | Size  |
|-----------|-------|
| 7151-2449 | Short |
| 7151-2450 |       |



#### Femoral File

Cat. No. [redacted]  
11-4894



### Genesis 1/8" Pin Driver

Cat. No. [redacted]  
7121-0001



### Genesis 1/8" Pin Puller

Cat. No. [redacted]  
7121-0000



### Genesis Quick Chuck

| Cat. No.  | Description |
|-----------|-------------|
| 7121-0011 | 3-M         |
| 7121-0012 | Hall        |
| 7121-0013 | Stryker     |



### Genesis Trocar Pins

| Cat. No.  | Size      |
|-----------|-----------|
| 7121-0002 | 1/8" x 3" |
| 7121-0003 | 1/8" x 5" |



### One-Piece Collet I/M Rod Assembly

Cat. No. [redacted]  
7144-0046



### Parallel Bars

Cat. No. [redacted]  
11-4886



# Reconstructive Surgery

## Knee Systems

### Pin and Drill Set

Cat. No.  
11-4968



### Articular Inserter/Extractor

Seats insert into tibial implant or removes them.

Cat. No.  
7144-0194



### Sawblades

(Not shown)

| Cat. No.  | Description        |
|-----------|--------------------|
| 7144-0374 | 3M                 |
| 7144-0375 | New Stryker        |
| 7144-0376 | Stryker            |
| 7144-0378 | Amsco-Hall         |
| 7144-0379 | Versipower         |
| 7144-0381 | Narrow 3M          |
| 7144-0383 | Narrow Zimmer      |
| 7144-0385 | Narrow Versipower  |
| 7144-0387 | Narrow Old Stryker |
| 7144-0389 | Narrow New Stryker |

### Femoral Downsizing Shim

Place in anterior slot of Anterior/Posterior Cutting Block to recut femur for smaller component (Bottom of tray).

Cat. No.  
7144-0440

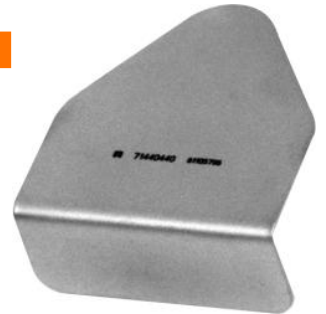

### Genesis II Total Knee System/Instrumentation/Miscellaneous Tray

#### \*Tibial Viewing Templates

Use to size proximal tibia.

| Cat. No.  | Size |
|-----------|------|
| 7144-0214 | 1    |
| 7144-0216 | 2    |
| 7144-0218 | 3    |
| 7144-0220 | 4    |
| 7144-0222 | 5    |
| 7144-0224 | 6    |
| 7144-0226 | 7    |
| 7144-0228 | 8    |

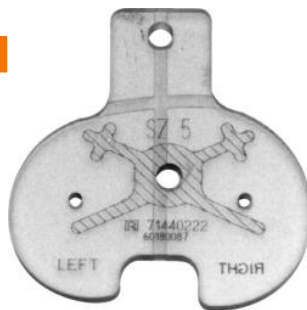

\* Optional piece for the set.

### Femoral Impactor

use to impact femoral trial and implant onto femur.

| Cat. No.  | Description        |
|-----------|--------------------|
| 7144-0190 |                    |
| 7144-0368 | Replacement Bumper |



### Femoral Implant Impactor

Attaches to the femoral component to aid in correct placement of implant on cut femur.

Cat. No.  
7144-0490



### All-Poly Impactor

Impacts all-polyethylene tibial base on proximal tibia.

Cat. No.  
7144-0196



Other instruments found in the bottom of the tray

### Femoral Trial Impactor

Positions and controls femoral trial as it is impacted on femur (Bottom of tray).



### Hex Screwdrivers



### Miscellaneous Tray



### Posterior-Stabilized Reamer Sleeve

used on Patellar Reamer Shaft to add stability and control (Bottom of tray).



### Primary Spacer Block

Place between cut femur and tibia to evaluate flexion and extension spaces.



### Quick-Connect Handles/Alignment Tower

Attaches to cutting blocks to provide extra stability and for extramedullary alignment checks. (Two per tray)



### Resection Check

helps in assessing level and accuracy of cuts.



### Spacer Plate

Snaps into Primary Space Block for larger flexion/extension gaps (Two per tray on 11mm and 13mm spacers).

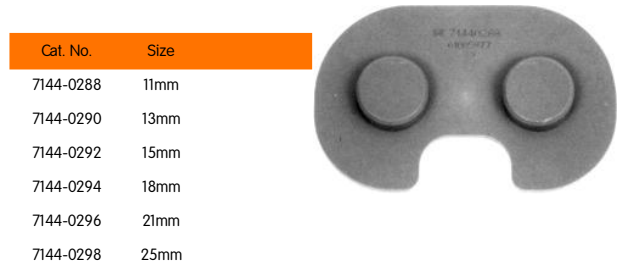

### Tibial Base Impactor

Impacts porous and nonporous tibial base onto proximal



### Tibial Tray Implant Impactor

Locks onto tibial baseplate for rotational control when seating the implant.



Other instruments found in the bottom of the tray

### Universal Extractor

Use throughout system to remove instruments and trials from femur and tibia.



# Reconstructive Surgery

## Knee Systems

### Universal Pin Puller

Grasps smooth and headed pins and nails.

Cat. No.

7144-0488



### 35mm Serrated Patellar Reamer Collet

Snaps in place on Patellar Reamer Guide to ream for appropriate diameter patella.

Cat. No.

7144-0518



### Wide PCL Retractor

Protects posterior cruciate ligament while exposing tibia.

Cat. No.

7144-0020



### All-Poly with Flex-Peg Patellar Depth Gauge

Use to determine appropriate reaming depth for All-Poly with Flex-Peg patella.

Cat. No.

7144-0332



### Genesis II Total Knee System/Instrumentation/Patellar Tray

#### \* All-Poly with Flex-Peg Trial

Place into resected patella to evaluate range of motion.

Cat. No. Size

7143-0582 23mm

7143-0584 26mm

7143-0586 29mm

7143-0588 32mm



\* Optional piece for set

#### \* Patellar Resection Guide

Guides sawblade for patellar resection with resurfacing patella.

Cat. No.

11-4938



\* Optional piece for set

### Biconvex Patellar Depth Gauge

Use to determine the appropriate reaming depth for all bioconvex patellas.

Cat. No.

7144-0328



### Biconvex Patellar Reamer

Connects to Patellar Reamer Shaft to ream for appropriate diameter biconvex patella.

Cat. No. Size

7144-0634 23mm

7144-0636 26mm

7144-0638 29mm

7144-0640 32mm



### Biconvex Patellar Trial

Place into resected patella to evaluate range of motion.

Cat. No. Size

7144-0566 23mm

7144-0568 26mm

7144-0570 29mm

7144-0572 32mm



### Modified Patellar Reamer Guide

Use to clamp patella for precision reaming and to cement button in place.

Cat. No.  
7144-0309



### Patellar Depth Stop

Locks onto Patellar Reamer Shaft to ensure reaming to the correct depth.

Cat. No.  
7144-0326



### Patellar Calipers

Measures patellar thickness.

Cat. No.  
11-4943



### Patellar Reamer Shaft

Attaches to the appropriate diameter Patellar Reamer to prepare for patella button.

Cat. No.  
7144-0324



### Patellar Cement Clamp

Snaps in place on Patellar Reamer Guide to hold patella in place and to pressurize cement.

Cat. No.  
7144-0322



### Patellar Tray

Cat. No.  
7144-0994

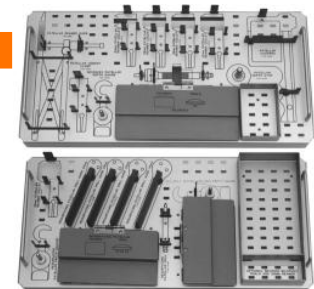

### Patellar Cement Clamp Sleeve

Fits over patella cement clamp for use with larger diameter patellas.

Cat. No.  
7144-0474



### Resurfacing Patellar Depth Gauge

Use to determine the appropriate reaming depth for all resurfacing patellas.

Cat. No.  
7144-0330



### Patellar Cement Clamp Sleeve

Fits over patella cement clamp for use with larger diameter patellas.

Cat. No.  
7144-0474



### Resurfacing Patellar Drill

Drills through the resurfacing Drill Guides to prepare for resurfacing patellar pegs.

Cat. No.  
7144-0360





# Reconstructive Surgery

## Knee Systems

### Resurfacing Patellar Drill Guide

Place in the reamed area for a resurfacing patella to guide drilling for pegs.

| Cat. No.  | Size |
|-----------|------|
| 7144-0362 | 26mm |
| 7144-0428 | 29mm |
| 7144-0430 | 32mm |
| 7144-0432 | 35mm |



### Porous Tibial Base Trial

Place on resected proximal tibia to punch for tibial fins and drill for screws.

| Cat. No.  | Size | Position |
|-----------|------|----------|
| 7143-0192 | 1    | Left     |
| 7143-0194 | 2    | Left     |
| 7143-0196 | 3    | Left     |
| 7143-0198 | 4    | Left     |
| 7143-0200 | 5    | Left     |
| 7143-0202 | 6    | Left     |
| 7143-0204 | 7    | Left     |
| 7143-0206 | 8    | Left     |
| 7143-0208 | 1    | Right    |
| 7143-0210 | 2    | Right    |
| 7143-0212 | 3    | Right    |
| 7143-0214 | 4    | Right    |
| 7143-0216 | 5    | Right    |
| 7143-0218 | 6    | Right    |
| 7143-0220 | 7    | Right    |
| 7143-0222 | 8    | Right    |



### Resurfacing Patellar Reamer

Connects to Patellar Reamer Shaft to ream for appropriate diameter resurfacing patella.

| Cat. No.  | Size |
|-----------|------|
| 7144-0348 | 26mm |
| 7144-0342 | 29mm |
| 7144-0344 | 32mm |
| 7144-0346 | 35mm |



### Resurfacing Patellar Trial

Place into resected patella to evaluate range of motion.

| Cat. No.  | Size |
|-----------|------|
| 7144-0580 | 26mm |
| 7144-0574 | 29mm |
| 7144-0576 | 32mm |
| 7144-0578 | 35mm |



### Porous Tibial Fin Punch

Punches for porous tibial fins.

| Cat. No.  | Size |
|-----------|------|
| 7144-0272 | 1-2  |
| 7144-0274 | 3-4  |
| 7144-0276 | 5-6  |
| 7144-0278 | 7-8  |



### Serrated Patellar Reamer Collet

Snaps in place on Patellar Reamer Guide to ream for appropriate diameter patella.

| Cat. No.  | Size |
|-----------|------|
| 7144-0510 | 23mm |
| 7144-0512 | 26mm |
| 7144-0514 | 29mm |
| 7144-0516 | 32mm |



### Porous Tibial Tray

| Cat. No.  |
|-----------|
| 7144-0984 |

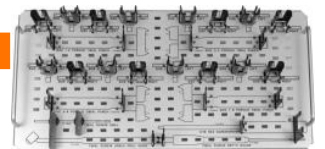

### Genesis II Total Knee

#### System/Instrumentation/Porous Tibial Tray

### Tibial Screw Angle Drill Guide

Guides drill for precise angulation of screw holes.

| Cat. No.  |
|-----------|
| 7144-0866 |



### Tibial Screw Depth Gauge

Place in drilled screw holes to determine screw length.

| Cat. No.  |
|-----------|
| 7151-4602 |



### Tibial Screwdriver

use to insert tibial bone screws.

| Cat. No. |
|----------|
| 11-5035  |



### Twist Drill 3.2 mm

Drills the minor diameter of the 6.5 mm bone screws used with the porous tibial tray (Six per tray).

| Cat. No. |
|----------|
| 21-0442  |

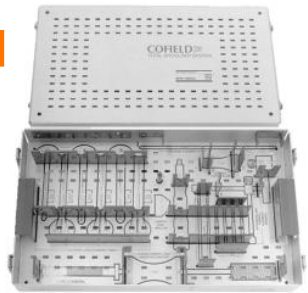

### Genesis II Total Knee System/Instrumentation/Posterior-Referencing Tray

### Distal Femoral Cutting Block

Resects distal femur

| Cat. No.  | Description |
|-----------|-------------|
| 7144-0024 | Slotted     |
| 7144-0026 | Nonslotted  |

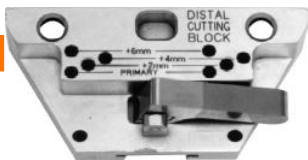

### Extended 6° Valgus Bushing

use with the Valgus Alignment Guide to set valgus angle on larger knees.

| Cat. No.  | Position |
|-----------|----------|
| 7144-0422 | Left     |
| 7144-0420 | Right    |



### Extramedullary Alignment Rod

use to double check knee alignment. Two rods cab be screwed together for a hip-to-ankle check.

| Cat. No. |
|----------|
| 11-4861  |



### Femoral Alignment Viewing Template

Provides a reference line in relation to the epicondyles and patellar groove. Assists in setting valgus angle.

| Cat. No.  |
|-----------|
| 7144-0426 |



### Femoral Instrumentation Outer Case

Not Shown

(Not shown)

| Cat. No.  | Size |
|-----------|------|
| 7144-0760 | 3-6  |

### Femoral Intramedullary Drill, 9.5 mm

Opens intramedullary canal of the femur

| Cat. No.  |
|-----------|
| 7144-0002 |



### Femoral Lug Punch

Use to punch holes in femoral condyles to prepare for lugs.

| Cat. No.  |
|-----------|
| 7144-0183 |



### Femoral Lug Trial

Screws into Femoral Trial to secure M/L position (Six per tray).

Cat. No.

7143-0864



### Nonporous Cruciate-Retaining Femoral Trial

Place on resected femur to assess M/L positioning and perform trial range of motion.

Cat. No. Size Position

|           |   |       |
|-----------|---|-------|
| 7143-0004 | 3 | Left  |
| 7143-0006 | 4 | Left  |
| 7143-0008 | 5 | Left  |
| 7143-0010 | 6 | Left  |
| 7143-0020 | 3 | Right |
| 7143-0022 | 4 | Right |
| 7143-0024 | 5 | Right |
| 7143-0026 | 6 | Right |



### Intramedullary Rod

Provides a reference guide for femoral and tibial cutting blocks.



Cat. No. Size

7144-0006 8"

7144-0004 16"

### Lower Module, Size 3-4

Cat. No.

7144-0804



### Posterior-Referencing A/P Block

Cat. No. Size

|           |   |
|-----------|---|
| 7144-0814 | 3 |
| 7144-0816 | 4 |
| 7144-0818 | 5 |
| 7144-0820 | 6 |



### Lower Module, Size 5-6

Cat. No.

7144-0806



### Posterior-Referencing A/P Cutting Block, Sizes 1-2

Size 1-2 Blocks fit into Size 1-2 Finishing Tray

Cat. No. Size

|           |   |
|-----------|---|
| 7144-0810 | 1 |
| 7144-0812 | 2 |



### Posterior-Referencing A/P Cutting Block, Sizes 7-8

Size 7-8 Blocks fit into Size 7-8 Finishing Tray

Cat. No. Size

|           |   |
|-----------|---|
| 7144-0822 | 7 |
| 7144-0824 | 8 |



## Posterior-Referencing Downsizing Shim

Cat. No.  
7144-0860



## Quick Release T-Handle

Connects to end of Intramedullary Rod.

Cat. No.  
11-6011



## Posterior-Referencing Femoral Alignment Guide

Cat. No.  
7144-0850



## Quick-Connect Handles/Alignment Tower

Attaches to cutting blocks to provide extra stability and for extramedullary alignment checks (Two per tray).

Cat. No.  
7144-0044



## Posterior-Referencing Sizing Guide

Cat. No.  
7144-0852



## Upper Tray

Cat. No.  
7144-0790

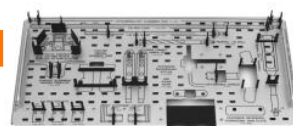

## Posterior-Referencing Sizing Guide Stylus

Cat. No.  
7144-0854



## Valgus Bushing

Assemble with the Valgus Alignment Guide to set the cutting blocks at the desired angle.

| Cat. No.  | Position |
|-----------|----------|
| 7144-0014 | 5°       |
| 7144-0016 | 6°       |
| 7144-0018 | 7°       |



## Genesis II Total Knee System/Instrumentation/Posterior-Stabilized Tray, Sizes 3-6

# Reconstructive Surgery

## Knee Systems

### \* Anterior/Posterior Cutting Block

Prepares femur to accept femoral trial. Cuts include anterior, chamfer, posterior and posterior chamfer.

| Cat. No.  | Size |
|-----------|------|
| 7144-0084 | 3    |
| 7144-0086 | 4    |
| 7144-0088 | 5    |
| 7144-0090 | 6    |



\* Optional piece for the set.

### Chisel/Sizer

Finishes edges of femoral housing box for Posterior-Stabilized and Constrained implants.

| Cat. No.  |
|-----------|
| 7144-0144 |



### Housing Reamer Dome

Locaks onto Patellar Reamer Shaft to ream for Posterior-Stabilized and Constrained femoral housing.

| Cat. No.  |
|-----------|
| 7144-0142 |



### Housing Resection Block

Slides onto resected femur to ream for posterior-Stabilized or Constrained femoral housing.

| Cat. No.  | Size |
|-----------|------|
| 7144-0114 | 3    |
| 7144-0116 | 4    |
| 7144-0118 | 5    |
| 7144-0120 | 6    |



### Posterior-Stabilized Femoral Trial

Pace on resected femur after box is reamed to preform trial range of motion.

| Cat. No.  | Size | Position |
|-----------|------|----------|
| 7143-0100 | 3    | Left     |
| 7143-0102 | 4    | Left     |
| 7143-0104 | 5    | Left     |
| 7143-0106 | 6    | Left     |
| 7143-0116 | 3    | Right    |
| 7143-0118 | 4    | Right    |
| 7143-0120 | 5    | Right    |
| 7143-0122 | 6    | Right    |



### Posterior-Stabilized Reamer Collet

use with all Housing Resection Blocks to provide guide for reaming Posterior-Stabilized housing.

| Cat. No.  |
|-----------|
| 7144-0467 |



### Posterior-Stabilized Tray, Sizes 3-6

| Cat. No.  |
|-----------|
| 7144-0986 |



### Genesis II Total Knee

System/Instrumentation/P-S / Revision Tray,  
Sizes 1-2

### \* Anterior/Posterior Cutting Block

Prepares femur to accept femoral trial. Cuts include anterior, anterior chamfer, posterior and posterior chamfer.

| Cat. No.  | Size |
|-----------|------|
| 7144-0080 | 1    |
| 7144-0082 | 2    |



### Conversion Module Trial

Attaches to Cruciate-Retaining or Posterior-Stabilized Femoral Trial to add trial stem.

| Cat. No.  | Size | Position |
|-----------|------|----------|
| 7143-0596 | 1    | Left     |
| 7143-0598 | 2    | Left     |
| 7143-0612 | 1    | Right    |
| 7143-0614 | 2    | Right    |



### Chisel/Sizer

Finishes edges of femoral housing box for Posterior-Stabilized or Constrained Implants.

| Cat. No.  |
|-----------|
| 7144-0144 |



### Housing Resection Block

Slides onto resected femur to ream for Posterior-Stabilized or Constrained femoral housing.

| Cat. No.  | Size |
|-----------|------|
| 7144-0111 | 1    |
| 7144-0112 | 2    |



### Constrained Articular Trial

Slides into Tibial Trial to check flexion/extension gap and range of motion.

| Cat. No.  | Size | Diameter |
|-----------|------|----------|
| 7143-0961 | 1-2  | 9mm      |
| 7143-0962 | 1-2  | 11mm     |



### Insert Spacer Trial

Snaps into bottom of 9mm Articular Insert Trial to increase trial thickness.

| Cat. No.  | Size | Diameter |
|-----------|------|----------|
| 7143-0264 | 1-2  | 30mm     |



### Constrained Femoral Trial

Place on resected femur after box is reamed to perform trial range of motion.

| Cat. No.  | Size | Position |
|-----------|------|----------|
| 7143-0928 | 1    | Left     |
| 7143-0930 | 2    | Left     |
| 7143-0944 | 1    | Right    |
| 7143-0946 | 2    | Right    |



### Posterior-Stabilized Femoral Trial

Place on resected femur after box is reamed to perform trial range of motion.

| Cat. No.  | Size | Position |
|-----------|------|----------|
| 7143-0096 | 1    | Left     |
| 7143-0098 | 2    | Left     |
| 7143-0112 | 1    | Right    |
| 7143-0114 | 2    | Right    |



### P-S / Revision Tray, Sizes 1-2

Cat. No.

7144-0982



### Revision Cutting Block

Attaches to femur to re-cut anterior-posterior femoral resections and prepare for posterior wedges.

Cat. No. Size

7144-0126 1

7144-0128 2



### Genesis II Total Knee System/Instrumentation/P-S / Revision Tray, Sizes 7-8

#### \* Anterior/Posterior Cutting Block

Prepares femur to accept femoral trial. Cuts include anterior, anterior chamfer, posterior and posterior chamfer.

Cat. No. Size

7144-0092 7

7144-0094 8



\* Optional piece for the set.

### Constrained Articular Trial

Slides into Tibial Trial to check flexion/extension gap and range of motion.

Cat. No. Size Diameter

7143-0551 7-8 9mm

7143-0552 8 11mm



### Constrained Femoral Trial

place on resected femur after box is reamed to perform trial range of motion.

Cat. No. Size Position

7143-0940 7 Left

7143-0942 8 Left

7143-0956 7 Right

7143-0958 8 Right



### Conversion Module Trial

Attaches to Cruciate-Retaining or Posterior-Stabilized Femoral Trial to add trial stem.

Cat. No. Size Position

7143-0608 7 Left

7143-0610 8 Left

7143-0624 7 Right

7143-0626 8 Right



### Housing Reamer Dome

Locaks onto Patellar Reamer Shaft to ream for Posterior-Stabilized and Constrained femoral housing.

Cat. No.

7144-0142



### Housing Resection Block

Slides onto resected femur to ream for Posterior-Stabilized or Constrained femoral housing.

Cat. No. Size

7144-0122 7

7144-0124 8



### Insert Spacer Trial

Snaps onto bottom of 9mm Articular Insert Trial to increase trial thickness.

| Cat. No.  | Size | Position |
|-----------|------|----------|
| 7143-0270 | 7-8  | 30mm     |



### Revision Cutting Block

Attaches to femur to re-cut anterior-posterior femoral resections and prepare for posterior wedges.

| Cat. No.  | Size |
|-----------|------|
| 7144-0138 | 7    |
| 7144-0140 | 8    |



### Posterior-Stabilized Femoral Trial

Place onto resected femur after box is eamed to perform trial range of motion.

| Cat. No.  | Size | Position |
|-----------|------|----------|
| 7143-0108 | 7    | Left     |
| 7143-0110 | 8    | Left     |
| 7143-0124 | 7    | Right    |



### Genesis II Total Knee System/Instrumentation/Revision Miscellaneous Wedge Tray

#### 7° Full Tibial Wedge Trial

Attaches to Tibial Trial to fill massive bony defects.

| Cat. No.  | Size |
|-----------|------|
| 7143-0001 | 1-2  |
| 7143-0005 | 3-4  |
| 7143-0009 | 5-6  |
| 7143-0013 | 7-8  |



### Posterior-Stabilized Reamer Collet

Use with all Housing Resection Blocks to provide guide for reaming Posterior-Stabilized housing.

| Cat. No.  |
|-----------|
| 7144-0467 |



### Angled Hemi Trial

Snaps onto Tibial Trial for trial range of motion.

| Cat. No.  | Size | Degree |
|-----------|------|--------|
| 7143-0714 | 1-2  | 20     |
| 7143-0716 | 3-4  | 20     |
| 7143-0718 | 5-6  | 20     |
| 7143-0720 | 7-8  | 20     |
| 7143-0722 | 1-2  | 30     |
| 7143-0724 | 3-4  | 30     |
| 7143-0736 | 5-6  | 30     |
| 7143-0738 | 7-8  | 30     |



### P-S / Revision Tray, Sizes 7-8

| Cat. No.  |
|-----------|
| 7144-0976 |

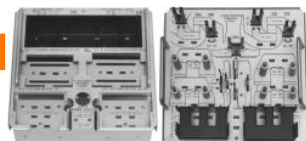



# Reconstructive Surgery

## Knee Systems

### Angled/Stepped Wedge Resection Guide

Attaches to Tibial Trial with quick connect handle for precise preparation for angled or stepped tibial wedges.

Cat. No.

7144-0280



### Articular Insert Trial Spacer Screw

use with Constrained Inserts to lock on Tibial Trial for range-of-motion assessment (two per tray).

Cat. No.

7144-0862

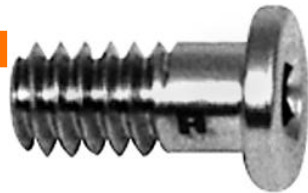

### Cement Clamp

Hold wedges in place while cement dries (Two per tray).

Cat. No.

11-4821



### Distal Femoral Wedge Trial; 5 mm

Magnetized trial snap on Femoral Trial or Housing Resection Blocks for distal build-up (Two per tray).

Cat. No. Size

|           |   |
|-----------|---|
| 7143-0664 | 1 |
| 7143-0665 | 2 |
| 7143-0666 | 3 |
| 7143-0667 | 4 |
| 7143-0668 | 5 |
| 7143-0669 | 6 |
| 7143-0670 | 7 |
| 7143-0671 | 8 |



### Femoral Trial Lug Screwdriver

Used to screw on and remove the trial lugs.

Cat. No.

7144-0865



### Full Wedge Resection Guide

Attaches to Tibial Trial with quick connect handle to prepare for full tibial wedge.

Cat. No.

7144-0436

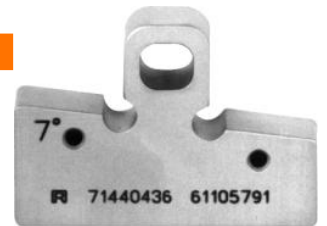

### Medial-Lateral Tibial Wedge Trial

Fits into six different positions on Tibial Trial to fill smaller defects.

Cat. No. Size

|           |     |
|-----------|-----|
| 7143-0746 | 1-2 |
| 7143-0748 | 3-4 |
| 7143-0750 | 5-6 |
| 7143-0752 | 7-8 |



### Posterior Femoral Wedge Trial

Magnetized to fit into Femoral Trial and Housing Resection Blocks for posterior femoral build of 5mm or 10mm (two per tray).

Cat. No. Size Description

|           |     |      |
|-----------|-----|------|
| 7143-0678 | 1-2 | 5LG  |
| 7143-0680 | 3-4 | 5LG  |
| 7143-0682 | 5-6 | 5LG  |
| 7143-0684 | 7-8 | 5LG  |
| 7143-0686 | 1-2 | 5SH  |
| 7143-0688 | 3-4 | 5SH  |
| 7143-0690 | 5-6 | 5SH  |
| 7143-0692 | 7-8 | 5SH  |
| 7143-0694 | 3-4 | 10SH |
| 7143-0696 | 5-6 | 10SH |
| 7143-0698 | 7-8 | 10SH |
| 7143-0700 | 1-2 | 5XS  |
| 7143-0702 | 3-4 | 5XS  |
| 7143-0704 | 5-6 | 5XS  |
| 7143-0706 | 7-8 | 5XS  |
| 7143-0708 | 3-4 | 10XS |



### Posterior Femoral Wedge Trial

Magnetized to fit into Femoral Trial and Housing Resection Blocks for posterior femoral build of 5mm or 10mm (two per tray).

| Cat. No.  | Size | Description |
|-----------|------|-------------|
| 7143-0710 | 5-6  | 10XS        |
| 7143-0712 | 7-8- | 10XS        |

### Revision Distal Femoral Cutting Block

use to resect distal femur in revision surgery and prepare for distal wedges.

| Cat. No.  |
|-----------|
| 7144-0460 |



### Revision Miscellaneous Wedge Tray

| Cat. No.  |
|-----------|
| 7144-0974 |

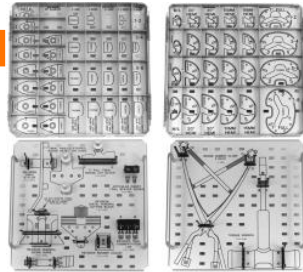

### Revision Reamer Collet

Use with all Housing Resection Blocks to provide guide for reaming Constrained Housing and Posterior-Stabilized Long Stem.

| Cat. No.  |
|-----------|
| 7144-0148 |



### Revision Tibial Stylus

Measures for 1mm resection from proximal tibia.

| Cat. No.  |
|-----------|
| 7144-0212 |



### Stacked Distal L-Wedge Trial

Use for 10mm distal and 10mm posterior build. Magnetized to fit on Femoral Trial (Two per tray).

| Cat. No.  | Size |
|-----------|------|
| 7143-0672 | 3    |
| 7143-0673 | 4    |
| 7143-0674 | 5    |
| 7143-0675 | 6    |
| 7143-0676 | 7    |
| 7143-0677 | 8    |



### Stepped Hemi Trial

Magnetized to fit Tibial Trial to fill 10mm or 15mm hemi defects.

| Cat. No.  | Size | Diameter |
|-----------|------|----------|
| 7143-0730 | 1-2  | 10mm     |
| 7143-0732 | 3-4  | 10mm     |
| 7143-0734 | 5-6  | 10mm     |
| 7143-0736 | 7-8  | 10mm     |
| 7143-0738 | 1-2  | 15mm     |
| 7143-0740 | 3-4  | 15mm     |
| 7143-0742 | 5-6  | 15mm     |
| 7143-0744 | 7-8  | 15mm     |



### Torque Wrench

Tightens down lugs securely with preset torque.

| Cat. No.  |
|-----------|
| 7144-0188 |



# Reconstructive Surgery

## Knee Systems

### Trial Augmentation Lug

Used to attach the conversion module trial onto the femoral trial component (Three per tray).

Cat. No.

7143-0866



### Genesis II Total Knee

#### System/Instrumentation/Revision Tray, Sizes

3-6

### Constrained Articular Trial

Slides into Tibial trial to check flexation/extension gap and range of motion.

Cat. No. Size Diameter

|           |     |      |
|-----------|-----|------|
| 7143-0523 | 3-4 | 9mm  |
| 7143-0524 | 3-4 | 11mm |
| 7143-0537 | 5-6 | 9mm  |
| 7143-0538 | 5-6 | 11mm |



### Constrained Femoral Trial

Place on resected femur after box is reamed to perform trial range of motion.

Cat. No. Size Position

|           |   |       |
|-----------|---|-------|
| 7143-0932 | 3 | Left  |
| 7143-0934 | 4 | Left  |
| 7143-0936 | 5 | Left  |
| 7143-0938 | 6 | Left  |
| 7143-0948 | 3 | Right |
| 7143-0950 | 4 | Right |
| 7143-0952 | 5 | Right |
| 7142-0954 | 6 | Right |



### Conversion Module Trial

Attaches to Cruciate-Retaining Posterior-Stabilized Femoral Trial to add trial stem.

Cat. No. Size Position

|           |   |       |
|-----------|---|-------|
| 7143-0600 | 3 | Left  |
| 7143-0602 | 4 | Left  |
| 7143-0604 | 5 | Left  |
| 7143-0606 | 6 | Left  |
| 7143-0616 | 3 | Right |
| 7143-0618 | 4 | Right |
| 7143-0620 | 5 | Right |
| 7143-0622 | 6 | Right |



### Insert Spacer Trial

Snaps into bottom of 9mm Articular Insert Trial to increase trial thickness.

Cat. No. Size Diameter

|           |     |      |
|-----------|-----|------|
| 7143-0266 | 3-4 | 30mm |
| 7143-0268 | 5-6 | 30mm |



### Revision Cutting Block

Attaches to femur to re-cut anterior-posterior femoral resections and prepare for posterior wedges.

Cat. No. Size

|           |   |
|-----------|---|
| 7144-0130 | 3 |
| 7144-0132 | 4 |
| 7144-0134 | 5 |
| 7144-0136 | 6 |

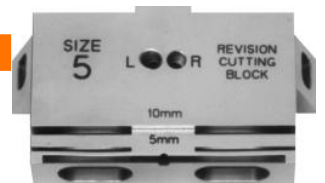

### Revision Tray, Sizes 3-6

Cat. No.

7144-0978

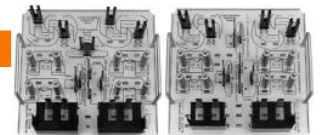

### Genesis II Total Knee

#### System/Instrumentation/Tibial Tray, Sizes 3-6

### \*One-Piece Ankle Clamp

Cat. No. 7144-0438



\* Optional piece for the set.

### \*Stemless Nonporous Tibial Trial

| Cat. No.  | Size | Position |
|-----------|------|----------|
| 7143-0165 | 3    | Left     |
| 7143-0167 | 4    | Left     |
| 7143-0169 | 5    | Left     |
| 7143-0171 | 6    | Left     |
| 7143-0181 | 3    | Right    |
| 7143-0183 | 4    | Right    |
| 7143-0185 | 5    | Right    |
| 7143-0187 | 6    | Right    |



\* Optional piece for the set.

### 11mm Tibial Drill

Drills hole in proximal tibia for stem/taper on tibial baseplate.

Cat. No. 7144-0040



### Adjustable Ankle Clamp

Cat. No. 7144-0444

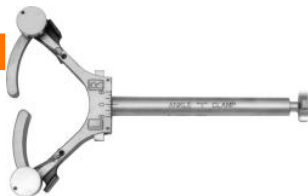

### Articular Insert Spacer Trial

Snaps into bottom of 9mm Articular Insert Trial to increase trial thickness.

| Cat. No.  | Size | Diameter |
|-----------|------|----------|
| 7143-0226 | 3-4  | 13mm     |
| 7143-0234 | 3-4  | 15mm     |
| 7143-0242 | 3-4  | 18mm     |
| 7143-0250 | 3-4  | 21mm     |
| 7143-0258 | 3-4  | 25mm     |
| 7143-0228 | 5-6  | 13mm     |
| 7143-0236 | 5-6  | 15mm     |
| 7143-0244 | 5-6  | 18mm     |
| 7143-0252 | 5-6  | 21mm     |
| 7143-0260 | 5-6  | 25mm     |



### Cruciate-Retaining Insert Trial

Slides into Tibial Trial to check flexion/extension gaps and range of motion.

| Cat. No.  | Size | Diameter |
|-----------|------|----------|
| 7143-0490 | 3-4  | 9mm      |
| 7143-0768 | 3-4  | 11mm     |
| 7143-0778 | 5-6  | 9mm      |
| 7143-0780 | 5-6  | 11mm     |



### Extramedullary Alignment Rod

Use to double check knee alignment. Two rods can be screwed together for hip-to-ankle check.

Cat. No. 11-4861



### Intramedullary Alignment Guide

Use with Intramedullary Rod to provide guide for intramedullary tibial alignment.

Cat. No. 7144-0200

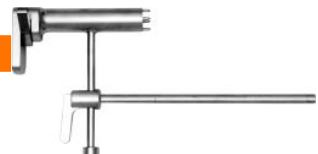

# Reconstructive Surgery

## Knee Systems

### Nonporous Tibial Fin Punch

Punches for Tibial Pins.

| Cat. No.  | Size |
|-----------|------|
| 7144-0266 | 3-4  |
| 7144-0268 | 5-6  |



### Primary Tibial Stylus

Determines the level of resection for the proximal tibia. Removes bone to accept a 9mm component.

| Cat. No.  |
|-----------|
| 7144-0211 |

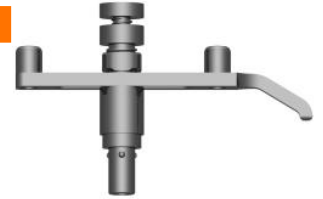

### Nonporous Tibial Trial

Place on resected proximal tibia to punch for tibial fins and for trial range of motion.

| Cat. No.  | Size | Position |
|-----------|------|----------|
| 7143-0164 | 3    | Left     |
| 7143-0166 | 4    | Left     |
| 7143-0168 | 5    | Left     |
| 7143-0170 | 6    | Left     |
| 7143-0180 | 3    | Right    |
| 7143-0182 | 4    | Right    |
| 7143-0184 | 5    | Right    |
| 7143-0186 | 6    | Right    |



### Tibial Alignment Spike Fixation Rod

| Cat. No.  |
|-----------|
| 7144-0198 |



### Tibial Alignment Tube

| Cat. No.  |
|-----------|
| 7144-0448 |



### Nonspiked Fixation Rod

| Cat. No.  |
|-----------|
| 7144-0446 |



### Tibial Collet

use with Tibial Drill Guide to drill and punch for Tibial Stem Taper.

| Cat. No.  | Size           |
|-----------|----------------|
| 7144-0434 | Intramedullary |
| 7144-0010 | 11mm           |
| 7144-0410 | 13mm           |



### Posterior-Stabilized Insert Trial

Slides into Tibial Trial to check flexion/extension gaps and range of motion.

| Cat. No.  | Size | Diameter |
|-----------|------|----------|
| 7143-0815 | 3-4  | 9mm      |
| 7143-0817 | 3-4  | 11mm     |
| 7143-0829 | 5-6  | 9mm      |
| 7143-0831 | 5-6  | 11mm     |



## Tibial Cutting Block

Resects the proximal tibia at a 3° angle.

| Cat. No.  | Position | Description   |
|-----------|----------|---------------|
| 7144-0209 | Left     | Slotted 3°    |
| 7144-0205 | Right    | Slotted 3°    |
| 7144-0207 | Left     | Nonslotted 3° |
| 7144-0203 | Right    | Nonslotted 3° |



## Nonporous Femoral Components - Left



| Cat. No.  | Size | Medial-Lateral | Anterior-Posterior |
|-----------|------|----------------|--------------------|
| 7152-2210 | 1    | 60mm           | 48mm               |
| 7152-2220 | 2    | 65mm           | 52mm               |
| 7152-2230 | 3    | 67mm           | 56mm               |
| 7152-2240 | 4    | 69mm           | 59mm               |
| 7152-2250 | 5    | 73mm           | 63mm               |
| 7152-2260 | 6    | 78mm           | 68mm               |
| 7152-2270 | 7    | 83mm           | 73mm               |

## Tibial Drill Guide

Use with the Tibial Collets to drill and punch for the tibial trial tray.

| Cat. No.  | Size |
|-----------|------|
| 7144-0234 | 3    |
| 7144-0236 | 4    |
| 7144-0238 | 5    |
| 7144-0240 | 6    |



## Tibial Stem Punch

Finishes out hole for tibial stem/taper and plugs tibial canal with bone.

| Cat. No.  | Size |
|-----------|------|
| 7144-0262 | 11mm |
| 7144-0408 | 13mm |



## Nonporous Femoral Components - Right



## Tibial Tray, Sizes 3-6

| Cat. No.  |
|-----------|
| 7144-0996 |

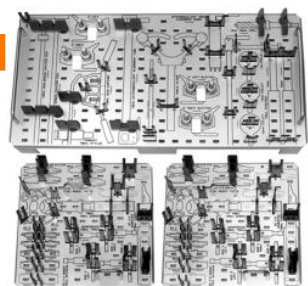

| Cat. No.  | Size | Medial-Lateral | Anterior-Posterior |
|-----------|------|----------------|--------------------|
| 7152-2110 | 1    | 60mm           | 48mm               |
| 7152-2120 | 2    | 65mm           | 52mm               |
| 7152-2130 | 3    | 67mm           | 56mm               |
| 7152-2140 | 4    | 69mm           | 59mm               |
| 7152-2150 | 5    | 73mm           | 63mm               |
| 7152-2160 | 6    | 78mm           | 68mm               |
| 7152-2170 | 7    | 83mm           | 73mm               |

## Profix Total Knee System/Cruciate-Retaining Femoral Implants

# Reconstructive Surgery

## Knee Systems

Porous Femoral Components - Left



| Cat. No.  | Size | Medial-Lateral | Anterior-Posterior |
|-----------|------|----------------|--------------------|
| 7150-2210 | 1    | 60mm           | 48mm               |
| 7150-2220 | 2    | 65mm           | 52mm               |
| 7150-2230 | 3    | 67mm           | 56mm               |
| 7150-2240 | 4    | 69mm           | 59mm               |
| 7150-2250 | 5    | 73mm           | 63mm               |
| 7150-2260 | 6    | 78mm           | 68mm               |
| 7150-2270 | 7    | 83mm           | 73mm               |

Nonporous Constrained Femoral Components - Left



| Cat. No.  | Size | Medial-Lateral | Anterior-Posterior |
|-----------|------|----------------|--------------------|
| 7152-2226 | 2    | 65mm           | 52mm               |
| 7152-2236 | 3    | 67mm           | 56mm               |
| 7152-2246 | 4    | 69mm           | 59mm               |
| 7152-2256 | 5    | 73mm           | 63mm               |
| 7152-2266 | 6    | 78mm           | 68mm               |
| 7152-2276 | 7    | 83mm           | 73mm               |

Porous Femoral Components - Right



| Cat. No.  | Size | Medial-Lateral | Anterior-Posterior |
|-----------|------|----------------|--------------------|
| 7150-2110 | 1    | 60mm           | 48mm               |
| 7150-2120 | 2    | 65mm           | 52mm               |
| 7150-2130 | 3    | 67mm           | 56mm               |
| 7150-2140 | 4    | 69mm           | 59mm               |
| 7150-2150 | 5    | 73mm           | 63mm               |
| 7150-2160 | 6    | 78mm           | 68mm               |
| 7150-2170 | 7    | 83mm           | 73mm               |

Nonporous Constrained Femoral Components - Right



| Cat. No.  | Size | Medial-Lateral | Anterior-Posterior |
|-----------|------|----------------|--------------------|
| 7152-2126 | 2    | 65mm           | 52mm               |
| 7152-2136 | 3    | 67mm           | 56mm               |
| 7152-2146 | 4    | 69mm           | 59mm               |
| 7152-2156 | 5    | 73mm           | 63mm               |
| 7152-2166 | 6    | 78mm           | 68mm               |
| 7152-2176 | 7    | 83mm           | 73mm               |

**Profix Total Knee  
System/Posterior-Stabilized/Constrained  
Femoral Implants**

Nonporous Posterior-Stabilized Components with Taper - Left



| Cat. No.  | Size | Medial-Lateral | Anterior-Posterior |
|-----------|------|----------------|--------------------|
| 7152-2225 | 2    | 65mm           | 55mm               |
| 7152-2235 | 3    | 67mm           | 56mm               |
| 7152-2245 | 4    | 69mm           | 59mm               |
| 7152-2255 | 5    | 73mm           | 63mm               |
| 7152-2265 | 6    | 78mm           | 68mm               |
| 7152-2275 | 7    | 83mm           | 73mm               |

Nonporous Posterior-Stabilized Components without Taper - Left



| Cat. No.  | Size | Medial-Lateral | Anterior-Posterior |
|-----------|------|----------------|--------------------|
| 7152-2224 | 2    | 65mm           | 52mm               |
| 7152-2234 | 3    | 67mm           | 56mm               |
| 7152-2244 | 4    | 69mm           | 59mm               |
| 7152-2254 | 5    | 73mm           | 63mm               |
| 7152-2264 | 6    | 78mm           | 68mm               |
| 7152-2274 | 7    | 83mm           | 73mm               |

Nonporous Posterior-Stabilized Components with Taper - Right

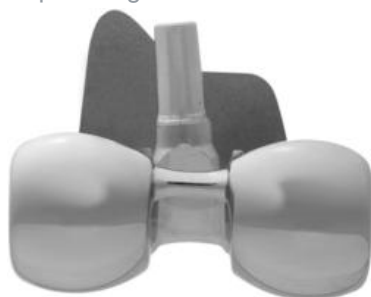

| Cat. No.  | Size | Medial-Lateral | Anterior-Posterior |
|-----------|------|----------------|--------------------|
| 7152-2125 | 2    | 65mm           | 52mm               |
| 7152-2135 | 3    | 67mm           | 56mm               |
| 7152-2145 | 4    | 69mm           | 59mm               |
| 7152-2155 | 5    | 73mm           | 63mm               |
| 7152-2165 | 6    | 78mm           | 68mm               |
| 7152-2175 | 7    | 83mm           | 73mm               |

Nonporous Posterior-Stabilized Components without Taper - Right



| Cat. No.  | Size | Medial-Lateral | Anterior-Posterior |
|-----------|------|----------------|--------------------|
| 7152-2124 | 2    | 65mm           | 52mm               |
| 7152-2134 | 3    | 67mm           | 56mm               |
| 7152-2144 | 4    | 69mm           | 59mm               |
| 7152-2154 | 5    | 73mm           | 63mm               |
| 7152-2164 | 6    | 78mm           | 68mm               |
| 7152-2174 | 7    | 83mm           | 73mm               |



# Reconstructive Surgery

## Knee Systems

Porous Posterior-Stabilized Components with Taper - Left



| Cat. No.  | Size | Medial-Lateral | Anterior-Posterior |
|-----------|------|----------------|--------------------|
| 7150-2225 | 2    | 65mm           | 52mm               |
| 7150-2235 | 3    | 67mm           | 56mm               |
| 7150-2245 | 4    | 69mm           | 59mm               |
| 7150-2255 | 5    | 73mm           | 63mm               |
| 7150-2265 | 6    | 78mm           | 68mm               |
| 7150-2275 | 7    | 83mm           | 73mm               |

Porous Posterior-Stabilized Components without Taper - Left



| Cat. No.  | Size | Medial-Lateral | Anterior-Posterior |
|-----------|------|----------------|--------------------|
| 7150-2224 | 2    | 65mm           | 52mm               |
| 7150-2234 | 3    | 67mm           | 56mm               |
| 7150-2244 | 4    | 69mm           | 59mm               |
| 7150-2254 | 5    | 73mm           | 63mm               |
| 7150-2264 | 6    | 78mm           | 68mm               |
| 7150-2274 | 7    | 83mm           | 73mm               |

Porous Posterior-Stabilized Components with Taper - Right



| Cat. No.  | Size | Medial-Lateral | Anterior-Posterior |
|-----------|------|----------------|--------------------|
| 7150-2125 | 2    | 65mm           | 52mm               |
| 7150-2135 | 3    | 67mm           | 56mm               |
| 7150-2145 | 4    | 69mm           | 59mm               |
| 7150-2155 | 5    | 73mm           | 63mm               |
| 7150-2165 | 6    | 78mm           | 68mm               |
| 7150-2175 | 7    | 83mm           | 73mm               |

Porous Posterior-Stabilized Components without Taper - Right



| Cat. No.  | Size | Medial-Lateral | Anterior-Posterior |
|-----------|------|----------------|--------------------|
| 7150-2124 | 2    | 65mm           | 52mm               |
| 7150-2134 | 3    | 67mm           | 56mm               |
| 7150-2144 | 4    | 69mm           | 59mm               |
| 7150-2154 | 5    | 73mm           | 63mm               |
| 7150-2164 | 6    | 78mm           | 68mm               |
| 7150-2174 | 7    | 83mm           | 73mm               |

### Profix Total Knee System/Patellar Implants

## Inset Patellar Components



| Cat. No.  | Size | Thickness |
|-----------|------|-----------|
| 7152-5010 | 23mm | 11mm      |
| 7152-5020 | 26mm | 12mm      |
| 7152-5030 | 29mm | 14mm      |

## Onset Patellar Components



| Cat. No.  | Size | Thickness |
|-----------|------|-----------|
| 7152-5011 | 29mm | 8.5mm     |
| 7152-5021 | 32mm | 8.5mm     |
| 7152-5031 | 35mm | 9.5mm     |
| 7152-5041 | 39mm | 10.0mm    |

## Profix Total Knee System/Metal-Base Tibial Implants

### Nonporous Tibial Base - Left



| Cat. No.  | Size | Medial-Lateral | Anterior-Posterior |
|-----------|------|----------------|--------------------|
| 7152-4210 | 1    | 61mm           | 42mm               |
| 7152-4220 | 2    | 65mm           | 45mm               |
| 7152-4230 | 3    | 70mm           | 48mm               |
| 7152-4240 | 4    | 75mm           | 51mm               |
| 7152-4250 | 5    | 80mm           | 55mm               |
| 7152-4260 | 6    | 85mm           | 58mm               |
| 7152-4270 | 7    | 91mm           | 61mm               |

### Nonporous Tibial Base - Right



| Cat. No.  | Size | Medial/Lateral | Anterior-Posterior |
|-----------|------|----------------|--------------------|
| 7152-4110 | 1    | 61mm           | 42mm               |
| 7152-4120 | 2    | 65mm           | 45mm               |
| 7152-4130 | 3    | 70mm           | 48mm               |
| 7152-4140 | 4    | 75mm           | 51mm               |
| 7152-4150 | 5    | 80mm           | 55mm               |
| 7152-4160 | 6    | 85mm           | 58mm               |
| 7152-4170 | 7    | 91mm           | 61mm               |

### Porous Tibial Base W/O Hole - Left



| Cat. No.  | Size | Medial-Lateral | Anterior-Posterior |
|-----------|------|----------------|--------------------|
| 7150-4211 | 1    | 61mm           | 42mm               |
| 7150-4221 | 2    | 65mm           | 45mm               |
| 7150-4231 | 3    | 70mm           | 48mm               |
| 7150-4241 | 4    | 75mm           | 51mm               |
| 7150-4251 | 5    | 80mm           | 55mm               |
| 7150-4261 | 6    | 85mm           | 58mm               |

### Porous Tibial Base - Left



| Cat. No.  | Size | Medial-Lateral | Anterior-Posterior |
|-----------|------|----------------|--------------------|
| 7150-4210 | 1    | 61mm           | 42mm               |
| 7150-4220 | 2    | 65mm           | 45mm               |
| 7150-4230 | 3    | 70mm           | 48mm               |
| 7150-4240 | 4    | 75mm           | 51mm               |
| 7150-4250 | 5    | 80mm           | 55mm               |

### Porous Tibial Base - Left

| Cat. No.  | Size | Medial-Lateral | Anterior-Posterior |
|-----------|------|----------------|--------------------|
| 7150-4260 | 6    | 85mm           | 58mm               |
| 7150-4270 | 7    | 91mm           | 61mm               |

### Porous Tibial Base - Right



| Cat. No.  | Size | Medial-Lateral | Anterior-Posterior |
|-----------|------|----------------|--------------------|
| 7150-4110 | 1    | 61mm           | 42mm               |
| 7150-4120 | 2    | 65mm           | 45mm               |
| 7150-4130 | 3    | 70mm           | 48mm               |
| 7150-4140 | 4    | 75mm           | 51mm               |
| 7150-4150 | 5    | 80mm           | 55mm               |
| 7150-4160 | 6    | 85mm           | 58mm               |
| 7150-4170 | 7    | 91mm           | 61mm               |

### Porous Tibial Base W/O Hole - Right



| Cat. No.  | Size | Medial-Lateral | Anterior-Posterior |
|-----------|------|----------------|--------------------|
| 7150-4111 | 1    | 61mm           | 42mm               |
| 7150-4121 | 2    | 65mm           | 45mm               |
| 7150-4131 | 3    | 70mm           | 48mm               |
| 7150-4141 | 4    | 75mm           | 51mm               |
| 7150-4151 | 5    | 80mm           | 55mm               |
| 7150-4161 | 6    | 85mm           | 58mm               |

### Tibial Screws



| Cat. No.  | Size |
|-----------|------|
| 7150-4315 | 15mm |

### Tibial Screws

| Cat. No.  | Size |
|-----------|------|
| 7150-4320 | 20mm |
| 7150-4325 | 25mm |
| 7150-4330 | 30mm |
| 7150-4335 | 35mm |
| 7150-4340 | 40mm |
| 7150-4345 | 45mm |
| 7150-4350 | 50mm |

### Profix Total Knee System/Cruciate-Retaining Articular Inserts

#### Conforming Plus Tibial Inserts - Left

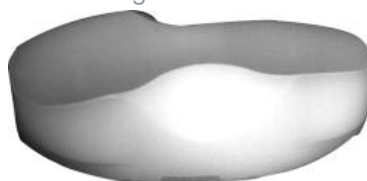

| Cat. No.  | Size | Thickness |
|-----------|------|-----------|
| 7150-8211 | 1    | 10mm      |
| 7150-8212 | 1    | 12mm      |
| 7150-8213 | 1    | 14mm      |
| 7150-8214 | 1    | 16mm      |
| 7150-8215 | 1    | 18mm      |
| 7150-8216 | 1    | 20mm      |
| 7150-8217 | 1    | 25mm      |
| 7150-8218 | 1    | 30mm      |
| 7150-8219 | 1    | 35mm      |
| 7150-8227 | 2    | 25mm      |
| 7150-8228 | 2    | 30mm      |
| 7150-8229 | 2    | 35mm      |
| 7150-8231 | 3    | 10mm      |
| 7150-8232 | 3    | 12mm      |
| 7150-8233 | 3    | 14mm      |
| 7150-8234 | 3    | 16mm      |
| 7150-8235 | 3    | 18mm      |
| 7150-8236 | 3    | 20mm      |
| 7150-8237 | 3    | 25mm      |
| 7150-8245 | 4    | 18mm      |
| 7150-8246 | 4    | 20mm      |
| 7150-8247 | 4    | 25mm      |
| 7150-8248 | 4    | 30mm      |
| 7150-8249 | 4    | 35mm      |
| 7150-8251 | 5    | 10mm      |
| 7150-8252 | 5    | 12mm      |

### Conforming Plus Tibial Inserts - Left

| Cat. No.  | Size | Thickness |
|-----------|------|-----------|
| 7150-8253 | 5    | 14mm      |
| 7150-8254 | 5    | 16mm      |
| 7150-8255 | 5    | 18mm      |
| 7150-8263 | 6    | 14mm      |
| 7150-8264 | 6    | 16mm      |
| 7150-8265 | 6    | 18mm      |
| 7150-8266 | 6    | 20mm      |
| 7150-8267 | 6    | 25mm      |
| 7150-8268 | 6    | 30mm      |
| 7150-8269 | 6    | 35mm      |

### Conforming Plus Tibial Inserts - Right

| Cat. No.  | Size | Thickness |
|-----------|------|-----------|
| 7150-8154 | 5    | 16mm      |
| 7150-8155 | 5    | 18mm      |
| 7150-8163 | 6    | 14mm      |
| 7150-8164 | 6    | 16mm      |
| 7150-8165 | 6    | 18mm      |
| 7150-8166 | 6    | 20mm      |
| 7150-8167 | 6    | 25mm      |
| 7150-8168 | 6    | 30mm      |

### Conforming Plus Tibial Inserts - Right

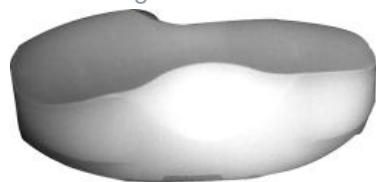

### Conforming Tibial Inserts - Left



| Cat. No.  | Size | Thickness |
|-----------|------|-----------|
| 7150-8111 | 1    | 10mm      |
| 7150-8112 | 1    | 12mm      |
| 7150-8113 | 1    | 14mm      |
| 7150-8114 | 1    | 16mm      |
| 7150-8115 | 1    | 18mm      |
| 7150-8116 | 1    | 20mm      |
| 7150-8117 | 1    | 25mm      |
| 7150-8118 | 1    | 30mm      |
| 7150-8121 | 2    | 10mm      |
| 7150-8128 | 2    | 30mm      |
| 7150-8129 | 2    | 35mm      |
| 7150-8119 | 1    | 35mm      |
| 7150-8131 | 3    | 10mm      |
| 7150-8132 | 3    | 12mm      |
| 7150-8133 | 3    | 14mm      |
| 7150-8134 | 3    | 16mm      |
| 7150-8135 | 3    | 18mm      |
| 7150-8136 | 3    | 20mm      |
| 7150-8137 | 3    | 25mm      |
| 7150-8145 | 4    | 18mm      |
| 7150-8146 | 4    | 20mm      |
| 7150-8147 | 4    | 25mm      |
| 7150-8148 | 4    | 30mm      |
| 7150-8149 | 4    | 35mm      |
| 7150-8151 | 5    | 10mm      |
| 7150-8152 | 5    | 12mm      |
| 7150-8153 | 5    | 14mm      |

| Cat. No.  | Size | Thickness |
|-----------|------|-----------|
| 7150-7211 | 1    | 10mm      |
| 7150-7212 | 1    | 12mm      |
| 7150-7213 | 1    | 14mm      |
| 7150-7214 | 1    | 16mm      |
| 7150-7215 | 1    | 18mm      |
| 7150-7216 | 1    | 20mm      |
| 7150-7217 | 1    | 25mm      |
| 7150-7218 | 1    | 30mm      |
| 7150-7221 | 2    | 10mm      |
| 7150-7228 | 2    | 30mm      |
| 7150-7231 | 3    | 10mm      |
| 7150-7232 | 3    | 12mm      |
| 7150-7233 | 3    | 14mm      |
| 7150-7234 | 3    | 16mm      |
| 7150-7235 | 3    | 18mm      |
| 7150-7236 | 3    | 20mm      |
| 7150-7237 | 3    | 25mm      |
| 7150-7238 | 3    | 30mm      |
| 7150-7241 | 4    | 10mm      |
| 7150-7248 | 4    | 30mm      |
| 7150-7251 | 5    | 10mm      |
| 7150-7252 | 5    | 12mm      |
| 7150-7253 | 5    | 14mm      |
| 7150-7254 | 5    | 16mm      |
| 7150-7255 | 5    | 18mm      |
| 7150-7256 | 5    | 20mm      |
| 7150-7257 | 5    | 25mm      |
| 7150-7258 | 5    | 30mm      |
| 7150-7261 | 6    | 10mm      |
| 7150-7268 | 6    | 30mm      |

# Reconstructive Surgery

## Knee Systems

### Conforming Tibial Inserts - Right



| Cat. No.  | Size | Thickness |
|-----------|------|-----------|
| 7150-7111 | 1    | 10mm      |
| 7150-7112 | 1    | 12mm      |
| 7150-7113 | 1    | 14mm      |
| 7150-7114 | 1    | 16mm      |
| 7150-7115 | 1    | 18mm      |
| 7150-7116 | 1    | 20mm      |
| 7150-7117 | 1    | 25mm      |
| 7150-7118 | 1    | 30mm      |
| 7150-7121 | 2    | 10mm      |
| 7150-7128 | 2    | 30mm      |
| 7150-7131 | 3    | 10mm      |
| 7150-7132 | 3    | 12mm      |
| 7150-7133 | 3    | 14mm      |
| 7150-7134 | 3    | 16mm      |
| 7150-7135 | 3    | 18mm      |
| 7150-7136 | 3    | 20mm      |
| 7150-7137 | 3    | 25mm      |
| 7150-7138 | 3    | 30mm      |
| 7150-7141 | 4    | 10mm      |
| 7150-7148 | 4    | 30mm      |
| 7150-7151 | 5    | 10mm      |
| 7150-7152 | 5    | 12mm      |
| 7150-7153 | 5    | 14mm      |
| 7150-7154 | 5    | 16mm      |
| 7150-7155 | 5    | 18mm      |
| 7150-7156 | 5    | 20mm      |
| 7150-7157 | 5    | 25mm      |
| 7150-7158 | 5    | 30mm      |
| 7150-7161 | 6    | 10mm      |

### Profix Total Knee System/Posterior-Stabilized/Constrained Articular Inserts

### Constrained Inserts - Left



| Cat. No.  | Size | Thickness |
|-----------|------|-----------|
| 7150-9422 | 2    | 12mm      |
| 7150-9423 | 2    | 14mm      |
| 7150-9424 | 2    | 16mm      |
| 7150-9425 | 2    | 18mm      |
| 7150-9426 | 2    | 20mm      |
| 7150-9427 | 2    | 25mm      |
| 7150-9432 | 3    | 12mm      |
| 7150-9433 | 3    | 14mm      |
| 7150-9434 | 3    | 16mm      |
| 7150-9445 | 4    | 18mm      |
| 7150-9446 | 4    | 20mm      |
| 7150-9447 | 4    | 25mm      |
| 7150-9452 | 5    | 12mm      |
| 7150-9453 | 5    | 14mm      |
| 7150-9454 | 5    | 16mm      |
| 7150-9455 | 5    | 18mm      |
| 7150-9456 | 5    | 20mm      |
| 7150-9457 | 5    | 25mm      |
| 7150-9462 | 6    | 12mm      |

### Constrained Inserts - Right



| Cat. No.  | Size | Thickness |
|-----------|------|-----------|
| 7150-9322 | 2    | 12mm      |
| 7150-9323 | 2    | 14mm      |
| 7150-9324 | 2    | 16mm      |
| 7150-9325 | 2    | 18mm      |
| 7150-9236 | 2    | 20mm      |
| 7150-9237 | 2    | 25mm      |
| 7150-9332 | 3    | 12mm      |

### Constrained Inserts - Right

| Cat. No.  | Size | Thickness |
|-----------|------|-----------|
| 7150-9333 | 3    | 14mm      |
| 7150-9334 | 3    | 16mm      |
| 7150-9145 | 4    | 18mm      |
| 7150-9146 | 4    | 20mm      |
| 7150-9147 | 4    | 25mm      |
| 7150-9352 | 5    | 12mm      |
| 7150-9353 | 5    | 14mm      |
| 7150-9354 | 5    | 16mm      |
| 7150-9255 | 5    | 18mm      |
| 7150-9256 | 5    | 20mm      |
| 7150-9257 | 5    | 25mm      |
| 7150-9362 | 6    | 12mm      |

### Posterior Stabilized Articular Inserts - Left

| Cat. No.  | Size | Thickness |
|-----------|------|-----------|
| 7150-9261 | 6    | 10mm      |
| 7150-9262 | 6    | 12mm      |
| 7150-9263 | 6    | 14mm      |
| 7150-9264 | 6    | 16mm      |
| 7150-9265 | 6    | 18mm      |

### Posterior Stabilized Articular Inserts - Right



### Posterior Stabilized Articular Inserts - Left



| Cat. No.  | Size | Thickness |
|-----------|------|-----------|
| 7150-9121 | 2    | 10mm      |
| 7150-9122 | 2    | 12mm      |
| 7150-9123 | 2    | 14mm      |
| 7150-9124 | 2    | 16mm      |
| 7150-9125 | 2    | 18mm      |
| 7150-9126 | 2    | 20mm      |
| 7150-9127 | 2    | 25mm      |
| 7150-9128 | 2    | 30mm      |
| 7150-9129 | 2    | 35mm      |
| 7150-9137 | 3    | 25mm      |
| 7150-9138 | 3    | 30mm      |
| 7150-9139 | 3    | 35mm      |
| 7150-9141 | 4    | 10mm      |
| 7150-9142 | 4    | 12mm      |
| 7150-9143 | 4    | 14mm      |
| 7150-9144 | 4    | 16mm      |
| 7150-9145 | 4    | 18mm      |
| 7150-9146 | 4    | 20mm      |
| 7150-9147 | 4    | 25mm      |
| 7150-9155 | 5    | 18mm      |
| 7150-9156 | 5    | 20mm      |
| 7150-9157 | 5    | 25mm      |
| 7150-9158 | 5    | 30mm      |
| 7150-9159 | 5    | 35mm      |
| 7150-9161 | 6    | 10mm      |
| 7150-9162 | 6    | 12mm      |
| 7150-9163 | 6    | 14mm      |
| 7150-9164 | 6    | 16mm      |
| 7150-9165 | 6    | 18mm      |

| Cat. No.  | Size | Thickness |
|-----------|------|-----------|
| 7150-9221 | 2    | 10mm      |
| 7150-9222 | 2    | 12mm      |
| 7150-9223 | 2    | 14mm      |
| 7150-9224 | 2    | 16mm      |
| 7150-9225 | 2    | 18mm      |
| 7150-9226 | 2    | 20mm      |
| 7150-9227 | 2    | 25mm      |
| 7150-9228 | 2    | 30mm      |
| 7150-9229 | 2    | 35mm      |
| 7150-9237 | 3    | 25mm      |
| 7150-9238 | 3    | 30mm      |
| 7150-9239 | 3    | 35mm      |
| 7150-9241 | 4    | 10mm      |
| 7150-9142 | 4    | 12mm      |
| 7150-9243 | 4    | 14mm      |
| 7150-9244 | 4    | 16mm      |
| 7150-9245 | 4    | 18mm      |
| 7150-9246 | 4    | 20mm      |
| 7150-9247 | 4    | 25mm      |
| 7150-9255 | 5    | 18mm      |
| 7150-9256 | 5    | 20mm      |
| 7150-9257 | 5    | 25mm      |
| 7150-9258 | 5    | 30mm      |
| 7150-9259 | 5    | 35mm      |

### Profix Total Knee System/All-Polyethylene Base Tibial Implants

#### All-Polyethylene Tibial Base - Left

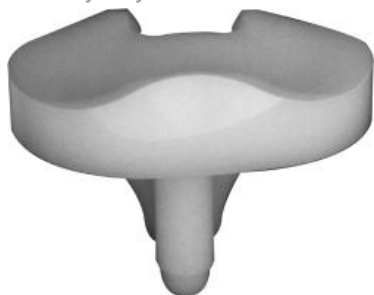

| Cat. No.  | Size | Thickness (mm) |
|-----------|------|----------------|
| 7152-8211 | 1    | 10             |
| 7152-8212 | 1    | 12             |
| 7152-8213 | 1    | 14             |
| 7152-8214 | 1    | 16             |
| 7152-8215 | 1    | 18             |
| 7152-8216 | 1    | 20             |
| 7152-8221 | 2    | 10             |
| 7152-8222 | 2    | 12             |
| 7152-8223 | 2    | 14             |
| 7152-8224 | 2    | 16             |
| 7152-8225 | 2    | 18             |
| 7152-8226 | 2    | 20             |
| 7152-8231 | 3    | 10             |
| 7152-8232 | 3    | 12             |
| 7152-8233 | 3    | 14             |
| 7152-8234 | 3    | 16             |
| 7152-8235 | 3    | 18             |
| 7152-8236 | 3    | 20             |
| 7152-8241 | 4    | 10             |
| 7152-8242 | 4    | 12             |
| 7152-8243 | 4    | 14             |
| 7152-8244 | 4    | 16             |
| 7152-8245 | 4    | 18             |
| 7152-8246 | 4    | 20             |
| 7152-8251 | 5    | 10             |
| 7152-8252 | 5    | 12             |
| 7152-8253 | 5    | 14             |
| 7152-8254 | 5    | 16             |
| 7152-8255 | 5    | 18             |
| 7152-8256 | 5    | 20             |
| 7152-8261 | 6    | 10             |
| 7152-8262 | 6    | 12             |
| 7152-8263 | 6    | 14             |
| 7152-8264 | 6    | 16             |

#### All-Polyethylene Tibial Base - Left

| Cat. No.  | Size | Thickness (mm) |
|-----------|------|----------------|
| 7152-8265 | 6    | 18             |
| 7152-8266 | 6    | 20             |

#### All-Polyethylene Tibial Base - Right

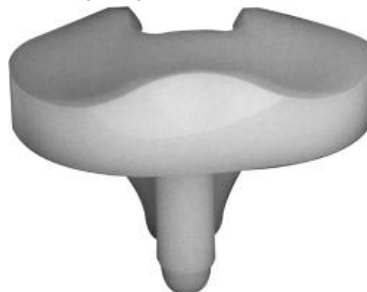

| Cat. No.  | Size | Thickness |
|-----------|------|-----------|
| 7152-8111 | 1    | 10mm      |
| 7152-8112 | 1    | 12mm      |
| 7152-8113 | 1    | 14mm      |
| 7152-8114 | 1    | 16mm      |
| 7152-8115 | 1    | 18mm      |
| 7152-8116 | 1    | 20mm      |
| 7152-8121 | 2    | 10mm      |
| 7152-8122 | 2    | 12mm      |
| 7152-8123 | 2    | 14mm      |
| 7152-8124 | 2    | 16mm      |
| 7152-8125 | 2    | 18mm      |
| 7152-8126 | 2    | 20mm      |
| 7152-8131 | 3    | 10mm      |
| 7152-8132 | 3    | 12mm      |
| 7152-8133 | 3    | 14mm      |
| 7152-7134 | 3    | 16mm      |
| 7152-7135 | 3    | 18mm      |
| 7152-8136 | 3    | 20mm      |
| 7152-8141 | 4    | 10mm      |
| 7152-8142 | 4    | 12mm      |
| 7152-8143 | 4    | 14mm      |
| 7152-8144 | 4    | 16mm      |
| 7152-8145 | 4    | 18mm      |
| 7152-8146 | 4    | 20mm      |
| 7152-8151 | 5    | 10mm      |
| 7152-8152 | 5    | 12mm      |
| 7152-8153 | 5    | 14mm      |
| 7152-8154 | 5    | 16mm      |
| 7152-8155 | 5    | 18mm      |
| 7152-8156 | 5    | 20mm      |
| 7152-8161 | 6    | 10mm      |

### All-Polyethylene Tibial Base - Right

| Cat. No.  | Size | Thickness |
|-----------|------|-----------|
| 7152-8162 | 6    | 12mm      |
| 7152-8163 | 6    | 14mm      |
| 7152-8164 | 6    | 16mm      |
| 7152-8165 | 6    | 18mm      |
| 7152-8166 | 6    | 20mm      |

### Nonporous Primary Femoral Components with Taper - Left



### Profix Total Knee System/Primary Tibial Stems

#### Tibial Metaphyseal Stem

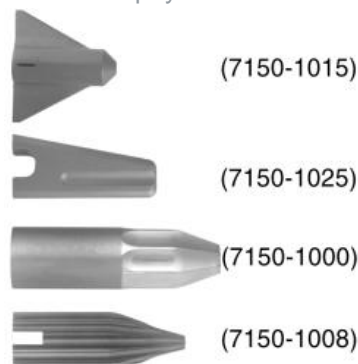

| Cat. No.  | Length | Diameter       |
|-----------|--------|----------------|
| 7150-1000 | 60mm   | 14mm           |
| 7150-1008 | 50mm   | 16mm           |
| 7150-1010 | 55mm   | 18mm           |
| 7150-1011 | 55mm   | 18mm<br>Smooth |
| 7150-1015 | 50mm   | 20mm           |
| 7150-1020 | 60mm   | 20mm           |
| 7150-1021 | 60mm   | 20mm<br>Smooth |
| 7150-1025 | 5mm    | I-Beam         |

| Cat. No.  | Size | Medial-Lateral | Anterior-Posterior |
|-----------|------|----------------|--------------------|
| 7152-2211 | 1    | 60mm           | 48mm               |
| 7152-2221 | 2    | 65mm           | 52mm               |
| 7152-2231 | 3    | 67mm           | 56mm               |
| 7152-2241 | 4    | 69mm           | 59mm               |
| 7152-2251 | 5    | 73mm           | 63mm               |
| 7152-2261 | 6    | 78mm           | 68mm               |
| 7152-2271 | 7    | 83mm           | 73mm               |

### Nonporous Primary Femoral Components with Taper - Right



| Cat. No.  | Size | Medial-Lateral | Anterior-Posterior |
|-----------|------|----------------|--------------------|
| 7152-2111 | 1    | 60mm           | 48mm               |
| 7152-2121 | 2    | 65mm           | 52mm               |
| 7152-2131 | 3    | 67mm           | 56mm               |
| 7152-2141 | 4    | 69mm           | 59mm               |
| 7152-2151 | 5    | 73mm           | 63mm               |
| 7152-2161 | 6    | 78mm           | 68mm               |
| 7152-2171 | 7    | 83mm           | 73mm               |

### Profix Total Knee System/Femoral Revision Implants



# Reconstructive Surgery

## Knee Systems

### Porous Femoral Component with Taper - Right



| Cat. No.  | Size | Medial-Lateral | Anterior-Posterior |
|-----------|------|----------------|--------------------|
| 7150-2111 | 1    | 60mm           | 48mm               |
| 7150-2121 | 2    | 65mm           | 52mm               |
| 7150-2131 | 3    | 67mm           | 56mm               |
| 7150-2141 | 4    | 69mm           | 59mm               |
| 7150-2151 | 5    | 73mm           | 63mm               |
| 7150-2161 | 6    | 78mm           | 68mm               |
| 7150-2171 | 7    | 83mm           | 73mm               |

### Porous Femoral Component with Taper - Left



| Cat. No.  | Size | Medial-Lateral | Anterior-Posterior |
|-----------|------|----------------|--------------------|
| 7150-2211 | 1    | 60mm           | 48mm               |
| 7150-2221 | 2    | 65mm           | 52mm               |
| 7150-2231 | 3    | 67mm           | 56mm               |
| 7150-2241 | 4    | 69mm           | 59mm               |
| 7150-2251 | 5    | 73mm           | 63mm               |
| 7150-2261 | 6    | 78mm           | 68mm               |
| 7150-2271 | 7    | 83mm           | 73mm               |

### Profix Total Knee System/Long Stems and Wedges (Tib & Fem)

### 4 degree Tibial Stems



| Cat. No.  | Length | Diameter |
|-----------|--------|----------|
| 7150-1710 | 100mm  | 10mm     |
| 7150-1810 | 150mm  | 10mm     |
| 7150-1910 | 200mm  | 10mm     |
| 7150-1712 | 100mm  | 12mm     |
| 7150-1812 | 150mm  | 12mm     |
| 7150-1912 | 200mm  | 12mm     |
| 7150-1714 | 100mm  | 14mm     |
| 7150-1814 | 150mm  | 14mm     |
| 7150-1914 | 200mm  | 14mm     |

### 7 degree Femoral Stems



| Cat. No.  | Length | Diameter |
|-----------|--------|----------|
| 7150-1410 | 100mm  | 10mm     |
| 7150-1510 | 150mm  | 10mm     |
| 7150-1610 | 200mm  | 10mm     |
| 7150-1412 | 100mm  | 12mm     |
| 7150-1512 | 150mm  | 12mm     |
| 7150-1612 | 200mm  | 12mm     |
| 7150-1414 | 100mm  | 14mm     |
| 7150-1514 | 150mm  | 14mm     |
| 7150-1614 | 200mm  | 14mm     |
| 7150-1420 | 100mm  | 20mm     |
| 7150-1520 | 150mm  | 20mm     |
| 7150-1620 | 200mm  | 20mm     |

### Distal-Only Nonporous Wedges



| Cat. No.  | Size | Description |
|-----------|------|-------------|
| 7152-0013 | 1    | Small       |
| 7152-0014 | 1    | Large       |
| 7152-0023 | 2    | Small       |
| 7152-0024 | 2    | Large       |
| 7152-0033 | 3    | Small       |
| 7152-0034 | 3    | Large       |

### Distal-Only Nonporous Wedges

| Cat. No.  | Size | Description |
|-----------|------|-------------|
| 7152-0043 | 4    | Small       |
| 7152-0044 | 4    | Large       |
| 7152-0053 | 5    | Small       |
| 7152-0054 | 5    | Large       |
| 7152-0063 | 6    | Small       |
| 7152-0064 | 6    | Large       |
| 7152-0073 | 7    | Small       |
| 7152-0074 | 7    | Large       |

### Neutral Femoral / Tibial Stems

| Cat. No.  | Length | Diameter |
|-----------|--------|----------|
| 7150-1212 | 150mm  | 12mm     |
| 7150-1312 | 200mm  | 12mm     |
| 7150-1114 | 100mm  | 14mm     |
| 7150-1214 | 150mm  | 14mm     |
| 7150-1314 | 200mm  | 14mm     |
| 7150-1120 | 100mm  | 20mm     |
| 7150-1220 | 150mm  | 20mm     |
| 7150-1320 | 200mm  | 20mm     |

### Distal-Only Porous Wedges

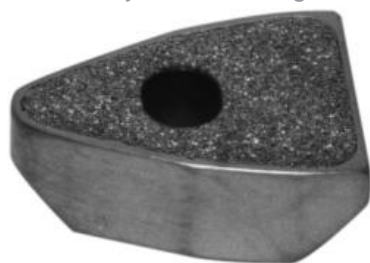

| Cat. No.  | Size | Description |
|-----------|------|-------------|
| 7150-0013 | 1    | Small       |
| 7150-0014 | 1    | Large       |
| 7150-0023 | 2    | Small       |
| 7150-0024 | 2    | Large       |
| 7150-0033 | 3    | Small       |
| 7150-0034 | 3    | Large       |
| 7150-0043 | 4    | Small       |
| 7150-0044 | 4    | Large       |
| 7150-0053 | 5    | Small       |
| 7150-0054 | 5    | Large       |
| 7150-0063 | 6    | Small       |
| 7150-0064 | 6    | Large       |
| 7150-0073 | 7    | Small       |
| 7150-0074 | 7    | Large       |

### Nonporous Femoral Wedges



| Cat. No.  | Size | Description |
|-----------|------|-------------|
| 7152-0011 | 1    | Small       |
| 7152-0012 | 1    | Large       |
| 7152-0021 | 2    | Small       |
| 7152-0022 | 2    | Large       |
| 7152-0031 | 3    | Small       |
| 7152-0032 | 3    | Large       |
| 7152-0041 | 4    | Small       |
| 7152-0042 | 4    | Large       |
| 7152-0051 | 5    | Small       |
| 7152-0052 | 5    | Large       |
| 7152-0061 | 6    | Small       |
| 7152-0062 | 6    | Large       |
| 7152-0071 | 7    | Small       |
| 7152-0072 | 7    | Large       |

### Neutral Femoral / Tibial Stems



| Cat. No.  | Length | Diameter |
|-----------|--------|----------|
| 7150-1110 | 100mm  | 10mm     |
| 7150-1210 | 150mm  | 10mm     |
| 7150-1310 | 200mm  | 10mm     |
| 7150-1112 | 100mm  | 12mm     |

### Nonporous Tibial Step Wedges



| Cat. No.  | Size | Description        | Diameter |
|-----------|------|--------------------|----------|
| 7152-0409 | 1    | Medial             | 5mm      |
| 7152-0410 | 1    | Medial             | 10mm     |
| 7152-0411 | 1    | Lateral / 2 Medial | 5mm      |

### Nonporous Tibial Step Wedges

| Cat. No.  | Size | Description        | Diameter |
|-----------|------|--------------------|----------|
| 7152-0412 | 1    | Lateral / 2 Medial | 10mm     |
| 7152-0421 | 2    | Lateral / 3 Medial | 5mm      |
| 7152-0422 | 2    | Lateral / 3 Medial | 10mm     |
| 7152-0431 | 3    | Lateral / 4 Medial | 5mm      |
| 7152-0432 | 3    | Lateral / 4 Medial | 10mm     |
| 7152-0441 | 4    | Lateral / 5 Medial | 5mm      |

### Porous Femoral Wedges



| Cat. No.  | Size | Description |
|-----------|------|-------------|
| 7150-0011 | 1    | Small       |
| 7150-0012 | 1    | Large       |
| 7150-0021 | 2    | Small       |
| 7150-0022 | 2    | Large       |
| 7150-0031 | 3    | Small       |
| 7150-0032 | 3    | Large       |
| 7150-0041 | 4    | Small       |
| 7150-0042 | 4    | Large       |
| 7150-0051 | 5    | Small       |
| 7150-0052 | 5    | Large       |
| 7150-0061 | 6    | Small       |
| 7150-0062 | 6    | Large       |
| 7150-0071 | 7    | Small       |
| 7150-0072 | 7    | Large       |

### Profix Total Knee System/Instrumentation/Case #1, Femoral Prep Instruments

#### \* Adj. External Rotation Guide

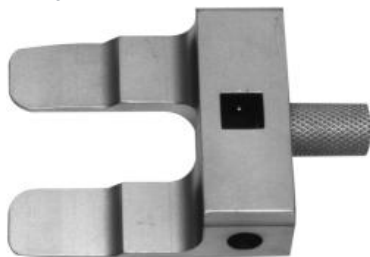

| Cat. No.  | Desc.   | Qty. |
|-----------|---------|------|
| 7151-2467 | 3→ Left | 1    |

#### \* Adj. External Rotation Guide

| Cat. No.  | Desc.      | Qty. |
|-----------|------------|------|
| 7151-2468 | 3→ Right   | 1    |
| 7151-2467 | 3→ Neutral | 1    |
| 7151-2470 | Guide      |      |

\* Optional

#### \* Anterior Femoral Rake

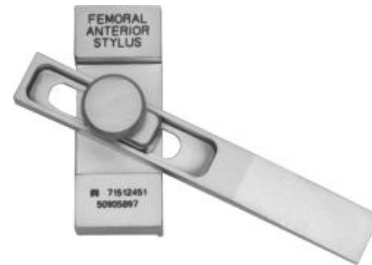

| Cat. No.  | Qty. |
|-----------|------|
| 7151-2003 | 1    |

\* Optional

#### 3M Quick Chuck



| Cat. No.  | Qty. |
|-----------|------|
| 7121-0011 | 1    |

#### 5" Bone Rongeur



| Cat. No.  | Qty. |
|-----------|------|
| 7151-2455 | 1    |

750 Gram Mallet



| Cat. No.  | Qty. |
|-----------|------|
| 7151-2452 | 1    |

8mm Reamer Rod



| Cat. No.  | Size    | Qty. |
|-----------|---------|------|
| 7151-2025 | Short * | 1    |
| 7151-2040 | Long *  | 1    |
| 7151-2030 | Medium  | 1    |

\* optional

Amsco Hall/Stryker Reamer/Jacobs Quick Chuck



| Cat. No.  | Qty. |
|-----------|------|
| 7121-0011 | 1    |

Anterior Stylus

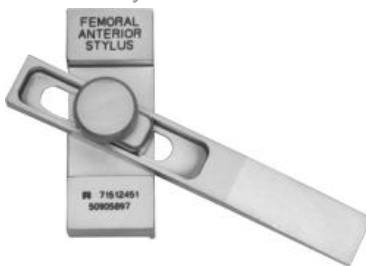

| Cat. No.  | Qty. |
|-----------|------|
| 7151-2451 | 1    |

Bone Spikes



| Cat. No.  | Desc. | Qty. |
|-----------|-------|------|
| 7151-2449 | Short | 4    |
| 7151-2450 | Long  | 4    |

External Rotation Guide



| Cat. No.  | Desc.    | Qty. |
|-----------|----------|------|
| 7151-2456 | Neutral  | 1    |
| 7151-2457 | 3→ Left  | 1    |
| 7151-2458 | 3→ Right | 1    |

External Rotation Guide Handle



| Cat. No.  | Qty. |
|-----------|------|
| 7151-2460 | 1    |

Femoral 3/8



| Cat. No.  | Qty. |
|-----------|------|
| 7151-2002 | 1    |

Femoral Sizer

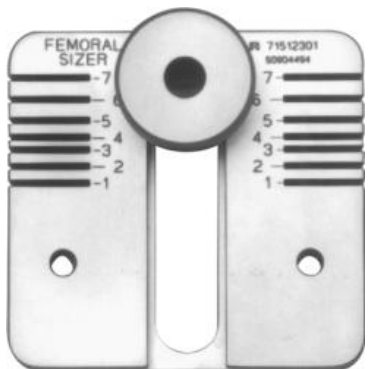

| Cat. No.  | Qty. |
|-----------|------|
| 7151-2301 | 1    |

Quick Release T-Handle



| Cat. No.  | Qty. |
|-----------|------|
| 7111-0080 | 1    |

Universal Pin Puller



| Cat. No.  | Qty. |
|-----------|------|
| 7144-0488 | 1    |

Sterile Case



| Cat. No.  | Qty. |
|-----------|------|
| 7151-5001 | 1    |

Valgus Module



| Cat. No.  | Desc. | Qty. |
|-----------|-------|------|
| 7151-2405 | 5→    | 1    |
| 7151-2407 | 7→    | 1    |

Profix Total Knee System/Instrumentation/Case #2, Femoral/Tibial Cutting Blocks

Stryker Drill Quick Chuck



| Cat. No.  | Qty. |
|-----------|------|
| 7121-0013 | 1    |

\* EM Alignment Guide  
(For Femoral and Tibial Use)



| Cat. No.  | Qty. |
|-----------|------|
| 7151-4520 | 1    |

\* Optional

Anterior Referencing Guide



| Cat. No.  | Qty. |
|-----------|------|
| 7151-2471 | 1    |

Femoral Cutting Block

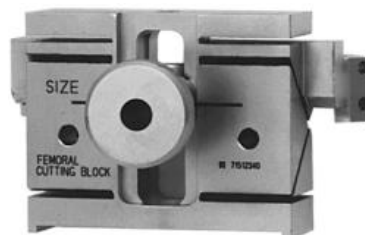

| Cat. No.  | Size | Qty. |
|-----------|------|------|
| 7151-2310 | 1    | 1    |
| 7151-2320 | 2    | 1    |
| 7151-2330 | 3    | 1    |
| 7151-2340 | 4    | 1    |
| 7151-2350 | 5    | 1    |
| 7151-2360 | 6    | 1    |
| 7151-2370 | 7    | 1    |

Cutting Block Alignment Plate



| Cat. No.  | Qty. |
|-----------|------|
| 7151-2577 | 1    |

Half Distal Spacer Gauge

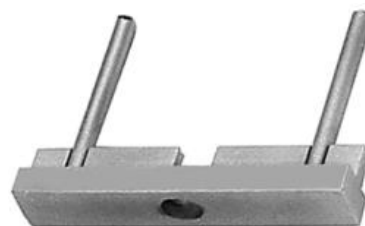

| Cat. No.  | Qty. |
|-----------|------|
| 7151-2578 | 1    |

Distal Femoral Cutting Block



| Cat. No.  | Size | Qty. |
|-----------|------|------|
| 7151-2515 | 1    | 1    |
| 7151-2525 | 2    | 1    |
| 7151-2535 | 3    | 1    |
| 7151-2545 | 4    | 1    |
| 7151-2555 | 5    | 1    |
| 7151-2565 | 6    | 1    |
| 7151-2575 | 7    | 1    |

Hex Screwdriver



| Cat. No. | Qty. |
|----------|------|
| 11-5035  | 1    |

Provisional Distal Cutting Block

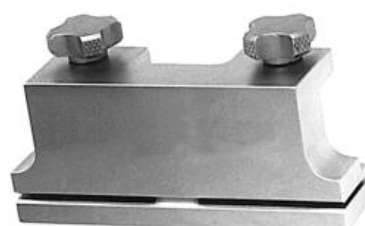

# Reconstructive Surgery

## Knee Systems

### Provisional Distal Cutting Block

| Cat. No.  | Qty. |
|-----------|------|
| 7151-2576 | 1    |

### Proximal Rod



| Cat. No. | Qty. |
|----------|------|
| 11-4662  | 1    |

### Replacement Screws and Bolts (Not shown)

| Cat. No.  | Desc.                                     | Qty. |
|-----------|---|------|
| 11-4675   | Screw for Distal Cutting Block            | 1    |
| 7192-5296 | Screw for Tibial Stylus                   | 1    |
| 7192-5297 | Screw for Tibial Stylus                   | 1    |
| 7192-5298 | Bolt for Tibial Secondary Prep Instrument | 1    |

### Rotating Tibial Stylus (Optional)



| Cat. No.  |
|-----------|
| 7151-4504 |

### Sterile Case



| Cat. No.  | Qty. |
|-----------|------|
| 7151-5002 | 1    |

### Tibial Ankle Clamp/Alignment Sleeve



| Cat. No. | Qty. |
|----------|------|
| 11-4660  | 1    |

### Tibial Cutting Block

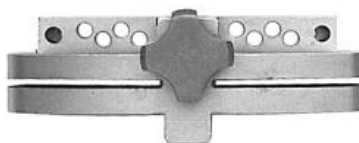

| Cat. No.  | Desc. | Qty. |
|-----------|-------|------|
| 7151-4510 | 0→    | 1    |
| 7151-4514 | 4→    | 1    |

### Tibial EM Spike



Tibial EM Spike

| Cat. No.  | Qty. |
|-----------|------|
| 7151-4502 | 1    |

12mm Stem Plug



| Cat. No.  | Qty. |
|-----------|------|
| 7151-2459 | 1    |

Tibial Secondary Prep Instrument



| Cat. No.  | Desc. | Qty. |
|-----------|-------|------|
| 7151-4511 | 0→    | 1    |
| 7151-4512 | 4→    | 1    |

Articular Insert Trial Handle



| Cat. No.  | Qty. |
|-----------|------|
| 7151-1008 | 1    |

Femoral Impactor



| Cat. No.  | Qty. |
|-----------|------|
| 7151-2510 | 1    |

Tibial Stylus

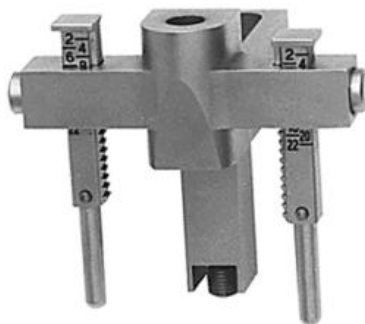

| Cat. No.  | Qty. |
|-----------|------|
| 7151-4501 | 1    |

Femoral Trial



Profix Total Knee System/Instrumentation/Case #3, Femoral/Tibial Trials

| Cat. No.  | Size | Position | Qty. |
|-----------|------|----------|------|
| 7151-2110 | 1    | Right    | 1    |
| 7151-2120 | 2    | Right    | 1    |
| 7151-2130 | 3    | Right    | 1    |
| 7151-2140 | 4    | Right    | 1    |
| 7151-2150 | 5    | Right    | 1    |
| 7151-2160 | 6    | Right    | 1    |
| 7151-2170 | 7    | Right    | 1    |
| 7151-2210 | 1    | Left     | 1    |
| 7151-2220 | 2    | Left     | 1    |
| 7151-2230 | 3    | Left     | 1    |



### Femoral Trial

| Cat. No.  | Size | Position | Qty. |
|-----------|------|----------|------|
| 7151-2240 | 4    | Left     | 1    |
| 7151-2250 | 5    | Left     | 1    |
| 7151-2260 | 6    | Left     | 1    |
| 7151-2270 | 7    | Left     | 1    |

### Patellofemoral Groove

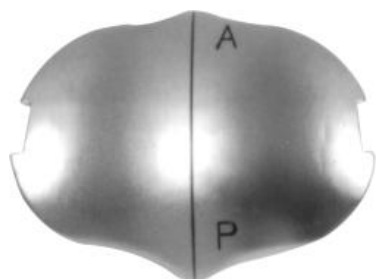

| Cat. No.  | Size | Qty. |
|-----------|------|------|
| 7151-2710 | 1    | 1    |
| 7151-2720 | 2    | 1    |
| 7151-2730 | 3    | 1    |
| 7151-2740 | 4    | 1    |
| 7151-2750 | 5    | 1    |
| 7151-2760 | 6    | 1    |
| 7151-2770 | 7    | 1    |

### Sterile Case

(Left and Right)



| Cat. No.  | Qty. |
|-----------|------|
| 7151-5003 | 1    |

### Tibial Prep Plate

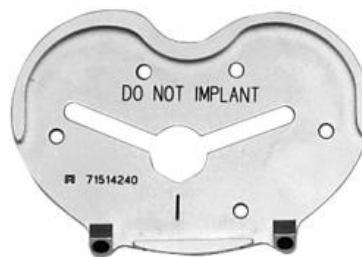

| Cat. No.  | Size | Position | Qty. |
|-----------|------|----------|------|
| 7151-4110 | 1    | Right    | 1    |
| 7151-4120 | 2    | Right    | 1    |
| 7151-4130 | 3    | Right    | 1    |
| 7151-4140 | 4    | Right    | 1    |
| 7151-4150 | 5    | Right    | 1    |
| 7151-4160 | 6    | Right    | 1    |
| 7151-4170 | 7    | Right    | 1    |
| 7151-4210 | 1    | Left     | 1    |
| 7151-4220 | 2    | Left     | 1    |
| 7151-4230 | 3    | Left     | 1    |
| 7151-4240 | 4    | Left     | 1    |
| 7151-4250 | 5    | Left     | 1    |
| 7151-4260 | 6    | Left     | 1    |
| 7151-4270 | 7    | Left     | 1    |

### Trial Taper Stem



| Cat. No.  | Qty. |
|-----------|------|
| 7151-4300 | 1    |

### Profix Total Knee System/Instrumentation/Case #4, Conforming Articular Insert Trials

### Conforming Articular Insert Trials-Left



| Cat. No.  | Size | Thickness | Qty. |
|-----------|------|-----------|------|
| 7151-7211 | 1    | 10 mm     | 1    |

### Conforming Articular Insert Trials-Left

| Cat. No.  | Size | Thickness | Qty. |
|-----------|------|-----------|------|
| 7151-7212 | 1    | 12 mm     | 1    |
| 7151-7213 | 1    | 14 mm     | 1    |
| 7151-7214 | 1    | 16 mm     | 1    |
| 7151-7215 | 1    | 18 mm     | 1    |
| 7151-7216 | 1    | 20 mm     | 1    |
| 7151-7217 | 1    | 25 mm*    | 1    |
| 7151-7218 | 1    | 30 mm*    | 1    |
| 7151-7219 | 1    | 35 mm*    | 1    |
| 7151-7221 | 2    | 10 mm     | 1    |
| 7151-7222 | 2    | 12 mm     | 1    |
| 7151-7223 | 2    | 14 mm     | 1    |
| 7151-7224 | 2    | 16 mm     | 1    |
| 7151-7225 | 2    | 18 mm     | 1    |
| 7151-7226 | 2    | 20 mm     | 1    |
| 7151-7227 | 2    | 25 mm*    | 1    |
| 7151-7228 | 2    | 30 mm*    | 1    |
| 7151-7229 | 2    | 35 mm*    | 1    |
| 7151-7231 | 3    | 10 mm     | 1    |
| 7151-7232 | 3    | 12 mm     | 1    |
| 7151-7233 | 3    | 14 mm     | 1    |
| 7151-7234 | 3    | 16 mm     | 1    |
| 7151-7235 | 3    | 18 mm     | 1    |
| 7151-7236 | 3    | 20 mm     | 1    |
| 7151-7237 | 3    | 25 mm*    | 1    |
| 7151-7238 | 3    | 30 mm*    | 1    |
| 7151-7239 | 3    | 35 mm*    | 1    |
| 7151-7241 | 4    | 10 mm     | 1    |
| 7151-7242 | 4    | 12 mm     | 1    |
| 7151-7243 | 4    | 14 mm     | 1    |
| 7151-7244 | 4    | 16 mm     | 1    |
| 7151-7245 | 4    | 18 mm     | 1    |
| 7151-7246 | 4    | 20 mm     | 1    |
| 7151-7247 | 4    | 25 mm*    | 1    |
| 7151-7248 | 4    | 30 mm*    | 1    |
| 7151-7249 | 4    | 35 mm*    | 1    |
| 7151-7251 | 5    | 10 mm     | 1    |
| 7151-7252 | 5    | 12 mm     | 1    |
| 7151-7253 | 5    | 14 mm     | 1    |
| 7151-7254 | 5    | 16 mm     | 1    |
| 7151-7255 | 5    | 18 mm     | 1    |
| 7151-7256 | 5    | 20 mm     | 1    |
| 7151-7257 | 5    | 25 mm*    | 1    |
| 7151-7258 | 5    | 30 mm*    | 1    |
| 7151-7259 | 5    | 35 mm*    | 1    |
| 7151-7261 | 6    | 10 mm     | 1    |
| 7151-7262 | 6    | 12 mm     | 1    |
| 7151-7263 | 6    | 14 mm     | 1    |
| 7151-7264 | 6    | 16 mm     | 1    |

### Conforming Articular Insert Trials-Left

| Cat. No.  | Size | Thickness | Qty. |
|-----------|------|-----------|------|
| 7151-7265 | 6    | 18 mm     | 1    |
| 7151-7266 | 6    | 20 mm     | 1    |
| 7151-7267 | 6    | 25 mm*    | 1    |
| 7151-7268 | 6    | 30 mm*    | 1    |
| 7151-7269 | 6    | 35 mm*    | 1    |

\* Not included in Basic Set

### Conforming Articular Insert Trials-Right



| Cat. No.  | Size | Thickness | Qty. |
|-----------|------|-----------|------|
| 7151-7111 | 1    | 10 mm     | 1    |
| 7151-7112 | 1    | 12 mm     | 1    |
| 7151-7113 | 1    | 14 mm     | 1    |
| 7151-7114 | 1    | 16 mm     | 1    |
| 7151-7115 | 1    | 18 mm     | 1    |
| 7151-7116 | 1    | 20 mm     | 1    |
| 7151-7117 | 1    | 25 mm*    | 1    |
| 7151-7118 | 1    | 30 mm*    | 1    |
| 7151-7119 | 1    | 35 mm*    | 1    |
| 7151-7121 | 2    | 10 mm     | 1    |
| 7151-7122 | 2    | 12 mm     | 1    |
| 7151-7123 | 2    | 14 mm     | 1    |
| 7151-7124 | 2    | 16 mm     | 1    |
| 7151-7125 | 2    | 18 mm     | 1    |
| 7151-7126 | 2    | 20 mm     | 1    |
| 7151-7127 | 2    | 25 mm*    | 1    |
| 7151-7128 | 2    | 30 mm*    | 1    |
| 7151-7129 | 2    | 35 mm*    | 1    |
| 7151-7131 | 3    | 10 mm     | 1    |
| 7151-7132 | 3    | 12 mm     | 1    |
| 7151-7133 | 3    | 14 mm     | 1    |
| 7151-7134 | 3    | 16 mm     | 1    |
| 7151-7135 | 3    | 18 mm     | 1    |
| 7151-7136 | 3    | 20 mm     | 1    |
| 7151-7137 | 3    | 25 mm*    | 1    |
| 7151-7138 | 3    | 30 mm*    | 1    |
| 7151-7139 | 3    | 35 mm*    | 1    |
| 7151-7141 | 4    | 10 mm     | 1    |
| 7151-7142 | 4    | 12 mm     | 1    |

### Conforming Articular Insert Trials-Right

| Cat. No.  | Size | Thickness | Qty. |
|-----------|------|-----------|------|
| 7151-7143 | 4    | 14 mm     | 1    |
| 7151-7144 | 4    | 16 mm     | 1    |
| 7151-7145 | 4    | 18 mm     | 1    |
| 7151-7146 | 4    | 20 mm     | 1    |
| 7151-7147 | 4    | 25 mm*    | 1    |
| 7151-7148 | 4    | 30 mm*    | 1    |
| 7151-7149 | 4    | 35 mm*    | 1    |
| 7151-7151 | 5    | 10 mm     | 1    |
| 7151-7152 | 5    | 12 mm     | 1    |
| 7151-7153 | 5    | 14 mm     | 1    |
| 7151-7154 | 5    | 16 mm     | 1    |
| 7151-7155 | 5    | 18 mm     | 1    |
| 7151-7156 | 5    | 20 mm     | 1    |
| 7151-7157 | 5    | 25 mm*    | 1    |
| 7151-7158 | 5    | 30 mm*    | 1    |
| 7151-7159 | 5    | 35 mm*    | 1    |
| 7151-7161 | 6    | 10 mm     | 1    |
| 7151-7162 | 6    | 12 mm     | 1    |
| 7151-7163 | 6    | 14 mm     | 1    |
| 7151-7164 | 6    | 16 mm     | 1    |
| 7151-7165 | 6    | 18 mm     | 1    |
| 7151-7166 | 6    | 20 mm     | 1    |
| 7151-7167 | 6    | 25 mm*    | 1    |
| 7151-7168 | 6    | 30 mm*    | 1    |
| 7151-7169 | 6    | 35 mm*    | 1    |

\* Not included in Basic Set

### Sterile Case



| Cat. No.  | Qty. |
|-----------|------|
| 7151-5004 | 1    |

### Profix Total Knee System/Instrumentation/Case #5, Conforming Plus Articular Insert Trials

### Conforming Plus Articular Insert Trials-Left



| Cat. No.  | Size | Thickness | Qty. |
|-----------|------|-----------|------|
| 7151-8211 | 1    | 10 mm     | 1    |
| 7151-8212 | 1    | 12 mm     | 1    |
| 7151-8213 | 1    | 14 mm     | 1    |
| 7151-8214 | 1    | 16 mm     | 1    |
| 7151-8215 | 1    | 18 mm     | 1    |
| 7151-8216 | 1    | 20 mm     | 1    |
| 7151-8217 | 1    | 25 mm*    | 1    |
| 7151-8218 | 1    | 30 mm*    | 1    |
| 7151-8219 | 1    | 35 mm*    | 1    |
| 7151-8221 | 2    | 10 mm     | 1    |
| 7151-8222 | 2    | 12 mm     | 1    |
| 7151-8223 | 2    | 14 mm     | 1    |
| 7151-8224 | 2    | 16 mm     | 1    |
| 7151-8225 | 2    | 18 mm     | 1    |
| 7151-8226 | 2    | 20 mm     | 1    |
| 7151-8227 | 2    | 25 mm*    | 1    |
| 7151-8228 | 2    | 30 mm*    | 1    |
| 7151-8229 | 2    | 35mm*     | 1    |
| 7151-8231 | 3    | 10 mm     | 1    |
| 7151-8232 | 3    | 12 mm     | 1    |
| 7151-8233 | 3    | 14 mm     | 1    |
| 7151-8234 | 3    | 16 mm     | 1    |
| 7151-8235 | 3    | 18 mm     | 1    |
| 7151-8236 | 3    | 20 mm     | 1    |
| 7151-8237 | 3    | 25 mm*    | 1    |
| 7151-8238 | 3    | 30 mm*    | 1    |
| 7151-8239 | 3    | 35 mm*    | 1    |
| 7151-8241 | 4    | 10 mm     | 1    |
| 7151-8242 | 4    | 12 mm     | 1    |
| 7151-8243 | 4    | 14 mm     | 1    |
| 7151-8244 | 4    | 16 mm     | 1    |
| 7151-8245 | 4    | 18 mm     | 1    |
| 7151-8246 | 4    | 20 mm     | 1    |
| 7151-8247 | 4    | 25mm*     | 1    |
| 7151-8248 | 4    | 30 mm*    | 1    |
| 7151-8249 | 4    | 35 mm*    | 1    |
| 7151-8251 | 5    | 10 mm     | 1    |
| 7151-8252 | 5    | 12 mm     | 1    |
| 7151-8253 | 5    | 14 mm     | 1    |
| 7151-8254 | 5    | 16 mm     | 1    |
| 7151-8255 | 5    | 18 mm     | 1    |

### Conforming Plus Articular Insert Trials-Left

| Cat. No.  | Size | Thickness | Qty. |
|-----------|------|-----------|------|
| 7151-8256 | 5    | 20 mm     | 1    |
| 7151-8257 | 5    | 25mm*     | 1    |
| 7151-8258 | 5    | 30 mm*    | 1    |
| 7151-8259 | 5    | 35 mm*    | 1    |
| 7151-8261 | 6    | 10 mm     | 1    |
| 7151-8262 | 6    | 12 mm     | 1    |
| 7151-8263 | 6    | 14 mm     | 1    |
| 7151-8264 | 6    | 16 mm     | 1    |
| 7151-8265 | 6    | 18 mm     | 1    |
| 7151-8266 | 6    | 20 mm     | 1    |
| 7151-8267 | 6    | 25mm*     | 1    |
| 7151-8268 | 6    | 30 mm*    | 1    |
| 7151-8269 | 6    | 35 mm*    | 1    |

\* Not included in basic set.

### Conforming Plus Articular Insert Trials-Right



| Cat. No.  | Size | Thickness | Qty. |
|-----------|------|-----------|------|
| 7151-8111 | 1    | 10 mm     | 1    |
| 7151-8112 | 1    | 12 mm     | 1    |
| 7151-8113 | 1    | 14 mm     | 1    |
| 7151-8114 | 1    | 16 mm     | 1    |
| 7151-8115 | 1    | 18 mm     | 1    |
| 7151-8116 | 1    | 20 mm     | 1    |
| 7151-8117 | 1    | 25 mm*    | 1    |
| 7151-8118 | 1    | 30 mm*    | 1    |
| 7151-8119 | 1    | 35 mm*    | 1    |
| 7151-8121 | 2    | 10 mm     | 1    |
| 7151-8122 | 2    | 12 mm     | 1    |
| 7151-8123 | 2    | 14 mm     | 1    |
| 7151-8124 | 2    | 16 mm     | 1    |
| 7151-8125 | 2    | 18 mm     | 1    |
| 7151-8126 | 2    | 20 mm     | 1    |
| 7151-8127 | 2    | 25 mm*    | 1    |
| 7151-8128 | 2    | 30 mm*    | 1    |
| 7151-8129 | 2    | 35 mm*    | 1    |
| 7151-8131 | 3    | 10 mm     | 1    |
| 7151-8132 | 3    | 12 mm     | 1    |
| 7151-8133 | 3    | 14 mm     | 1    |

### Conforming Plus Articular Insert Trials-Right

| Cat. No.  | Size | Thickness | Qty. |
|-----------|------|-----------|------|
| 7151-8134 | 3    | 16 mm     | 1    |
| 7151-8135 | 3    | 18 mm     | 1    |
| 7151-8136 | 3    | 20 mm     | 1    |
| 7151-8137 | 3    | 25 mm*    | 1    |
| 7151-8138 | 3    | 30 mm*    | 1    |
| 7151-8139 | 3    | 35 mm*    | 1    |
| 7151-8141 | 4    | 10 mm     | 1    |
| 7151-8142 | 4    | 12 mm     | 1    |
| 7151-8143 | 4    | 14 mm     | 1    |
| 7151-8144 | 4    | 16 mm     | 1    |
| 7151-8145 | 4    | 18 mm     | 1    |
| 7151-8146 | 4    | 20 mm     | 1    |
| 7151-8147 | 4    | 25 mm*    | 1    |
| 7151-8148 | 4    | 30 mm*    | 1    |
| 7151-8149 | 4    | 35 mm*    | 1    |
| 7151-8151 | 5    | 10 mm     | 1    |
| 7151-8152 | 5    | 12 mm     | 1    |
| 7151-8153 | 5    | 14 mm     | 1    |
| 7151-8154 | 5    | 16 mm     | 1    |
| 7151-8155 | 5    | 18 mm     | 1    |
| 7151-8156 | 5    | 20 mm     | 1    |
| 7151-8157 | 5    | 25 mm*    | 1    |
| 7151-8158 | 5    | 30 mm*    | 1    |
| 7151-8159 | 5    | 35 mm*    | 1    |
| 7151-8161 | 6    | 10 mm     | 1    |
| 7151-8162 | 6    | 12 mm     | 1    |
| 7151-8163 | 6    | 14 mm     | 1    |
| 7151-8164 | 6    | 16 mm     | 1    |
| 7151-8165 | 6    | 18 mm     | 1    |
| 7151-8166 | 6    | 20 mm     | 1    |
| 7151-8167 | 6    | 25 mm*    | 1    |
| 7151-8168 | 6    | 30 mm*    | 1    |
| 7151-8169 | 6    | 35 mm*    | 1    |

\* Not included in basic set.

### Sterile Case



### Sterile Case

| Cat. No.  | Qty. |
|-----------|------|
| 7151-5005 | 1    |

### Profix Total Knee System/Instrumentation/Case #6, Miscellaneous Instruments

3/16



| Cat. No.  | Qty. |
|-----------|------|
| 7151-2574 | 1    |

### Articular Insert Disassembly Tool



| Cat. No. | Qty. |
|----------|------|
| 11-4931  | 1    |

### Depth Gauge



| Cat. No.  | Qty. |
|-----------|------|
| 7151-4602 | 1    |

### Femoral Extractor



| Cat. No.  | Qty. |
|-----------|------|
| 7151-2511 | 1    |

### Femoral Peg Drill



| Cat. No.  | Qty. |
|-----------|------|
| 7151-2610 | 1    |

### Fin Punch handle



| Cat. No.  | Qty. |
|-----------|------|
| 7151-4515 | 1    |

### I-Beam Stem Punch



| Cat. No.  | Qty. |
|-----------|------|
| 7151-4620 | 1    |

### Keel Stem Punch



| Cat. No.  | Qty. |
|-----------|------|
| 7151-4621 | 1    |

### Nonporous Tibial Fin Punch

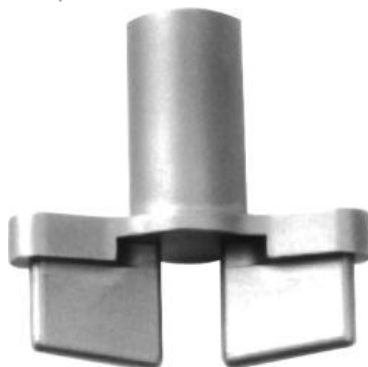

| Cat. No.  | Size | Qty. |
|-----------|------|------|
| 7151-4516 | 1-2  | 1    |
| 7151-4517 | 3-4  | 1    |
| 7151-4518 | 5-6  | 1    |

Sterile Case

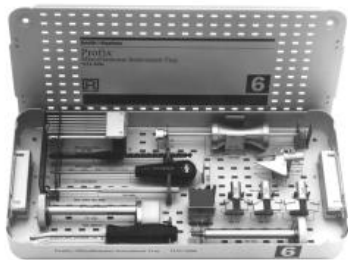

| Cat. No.  | Qty. |
|-----------|------|
| 7151-5006 | 1    |

Tibial Impactor



| Cat. No.  | Qty. |
|-----------|------|
| 7151-4606 | 1    |

Tibial Rotation Alignment Impactor



| Cat. No.  | Qty. |
|-----------|------|
| 7151-4601 | 1    |

Tibial Screw Drill

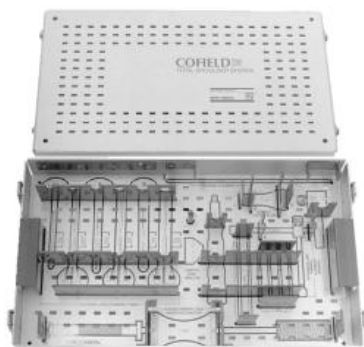

Tibial Screw Drill

| Cat. No. | Qty. |
|----------|------|
| 21-0442  | 4    |

Tibial Screw Drill Guide



| Cat. No.  | Qty. |
|-----------|------|
| 7151-4603 | 1    |

Profix Total Knee System/Instrumentation/Case #7, Patellar Instruments

Patellar Cement Clamp Fitting



| Cat. No.  | Qty. |
|-----------|------|
| 7151-5105 | 1    |

Patellar Clamp



| Cat. No.  | Qty. |
|-----------|------|
| 7151-5100 | 1    |

Patellar Onset Trial  
(Not shown)

| Cat. No.  | Size  | Qty. |
|-----------|-------|------|
| 7151-6011 | 29 mm | 1    |
| 7151-6021 | 32 mm | 1    |
| 7151-6031 | 35 mm | 1    |
| 7151-6041 | 39 mm | 1    |

# Reconstructive Surgery

## Knee Systems

Patellar Reamer



| Cat. No.  | Size  | Qty. |
|-----------|-------|------|
| 7151-5110 | 23 mm | 1    |
| 7151-5120 | 26 mm | 1    |
| 7151-5130 | 29 mm | 1    |

Patellar Ring Gauge

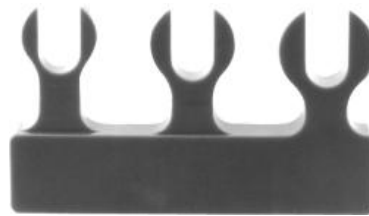

| Cat. No.  | Qty. |
|-----------|------|
| 7151-5103 | 1    |

Patellar Reamer Centering Ring



| Cat. No.  | Size  | Qty. |
|-----------|-------|------|
| 7151-5323 | 23 mm | 1    |
| 7151-5326 | 26 mm | 1    |
| 7151-5329 | 29 mm | 1    |

Patellar Trial



| Cat. No.  | Size  | Qty. |
|-----------|-------|------|
| 7151-5010 | 23 mm | 1    |
| 7151-5020 | 26 mm | 1    |
| 7151-5030 | 29 mm | 1    |

Patellar Reamer Collet



| Cat. No.  | Size  | Qty. |
|-----------|-------|------|
| 7151-5310 | 23 mm | 1    |
| 7151-5320 | 26 mm | 1    |
| 7151-5330 | 29 mm | 1    |

Resurfacing Patellar Drill



| Cat. No. |
|----------|
| 11-4944  |

Patellar Reamer Stop



| Cat. No.  | Qty. |
|-----------|------|
| 7151-5101 | 1    |

Resurfacing Patellar Drill Guide, Medium



| Cat. No. |
|----------|
| 11-4941  |

## Resurfacing Patellar Resection Guide



| Cat. No. |
|----------|
| 11-4938  |

## Sterile Case

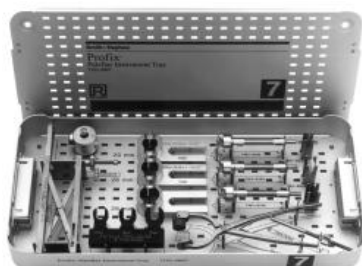

| Cat. No.  | Qty. |
|-----------|------|
| 7151-5007 | 1    |

## Profix Total Knee System/Instrumentation/Case #8, Revision Reamer/Long Stem Trials

### Long Stem Drill



| Cat. No.  | Qty. |
|-----------|------|
| 7151-2025 | 1    |

### Reamer



| Cat. No.  | Size  | Qty. |
|-----------|-------|------|
| 7151-2009 | 9 mm  | 1    |
| 7151-2010 | 10 mm | 1    |
| 7151-2011 | 11 mm | 1    |
| 7151-2012 | 12 mm | 1    |
| 7151-2013 | 13 mm | 1    |
| 7151-2014 | 14 mm | 1    |
| 7151-2015 | 15 mm | 1    |
| 7151-2016 | 16 mm | 1    |

## Reamer

| Cat. No.  | Size  | Qty. |
|-----------|-------|------|
| 7151-2017 | 17 mm | 1    |
| 7151-2018 | 18 mm | 1    |
| 7151-2019 | 19 mm | 1    |
| 7151-2020 | 20 mm | 1    |

## Stem Trial



| Cat. No.  | Size        | Qty. |
|-----------|-------------|------|
| 7151-1110 | 100 mm x 10 | 1    |
| 7151-1112 | 100 mm x 12 | 1    |
| 7151-1114 | 100 mm x 14 | 1    |
| 7151-1116 | 100 mm x 16 | 1    |
| 7151-1118 | 100 mm x 18 | 1    |
| 7151-1120 | 100 mm x 20 | 1    |
| 7151-1810 | 150 mm x 10 | 1    |
| 7151-1812 | 150 mm x 12 | 1    |
| 7151-1814 | 150 mm x 14 | 1    |
| 7151-1816 | 150 mm x 16 | 1    |
| 7151-1818 | 150 mm x 18 | 1    |
| 7151-1820 | 150 mm x 20 | 1    |
| 7151-1910 | 200 mm x 10 | 1    |
| 7151-1912 | 200 mm x 12 | 1    |
| 7151-1914 | 200 mm x 14 | 1    |
| 7151-1916 | 200 mm x 16 | 1    |
| 7151-1918 | 200 mm x 18 | 1    |
| 7151-1920 | 200 mm x 20 | 1    |

## Stem Trial Coupler



| Cat. No.  | Desc.   | Qty. |
|-----------|---------|------|
| 7151-1000 | Neutral | 2    |
| 7151-1007 | 7→      | 1    |
| 7151-1004 | 4→      | 1    |



# Reconstructive Surgery

## Knee Systems

### Sterile Case



| Cat. No.  | Qty. |
|-----------|------|
| 7151-5008 | 1    |

### Trial Stem Disassembly Tool



| Cat. No.  | Qty. |
|-----------|------|
| 7151-1005 | 1    |

### Profix Total Knee System/Instrumentation/Case #9, Revision Femoral Trials

### Revision Femoral Trial



| Cat. No.  | Size | Position | Qty. |
|-----------|------|----------|------|
| 7151-2111 | 1    | Right    | 1    |
| 7151-2121 | 2    | Right    | 1    |
| 7151-2131 | 3    | Right    | 1    |
| 7151-2141 | 4    | Right    | 1    |
| 7151-2151 | 5    | Right    | 1    |

### Revision Femoral Trial

| Cat. No.  | Size | Position | Qty. |
|-----------|------|----------|------|
| 7151-2161 | 6    | Right    | 1    |
| 7151-2171 | 7    | Right    | 1    |
| 7151-2211 | 1    | Left     | 1    |
| 7151-2221 | 2    | Left     | 1    |
| 7151-2231 | 3    | Left     | 1    |
| 7151-2241 | 4    | Left     | 1    |
| 7151-2251 | 5    | Left     | 1    |
| 7151-2261 | 6    | Left     | 1    |
| 7151-2271 | 7    | Left     | 1    |

### Sterile Case (Not shown)

| Cat. No.  |
|-----------|
| 7151-5009 |

### Profix Total Knee System/Instrumentation/Case #10, Femoral Wedge Trials/Tibial Spacers

### Femoral Wedge Trial LM/RL



| Cat. No.  | Size    | Qty. |
|-----------|---------|------|
| 7151-0013 | 1-Small | 1    |
| 7151-0014 | 1-Large | 1    |
| 7151-0023 | 2-Small | 1    |
| 7151-0024 | 2-Large | 1    |
| 7151-0033 | 3-Small | 1    |
| 7151-0034 | 3-Large | 1    |
| 7151-0043 | 4-Small | 1    |
| 7151-0044 | 4-Large | 1    |
| 7151-0053 | 5-Small | 1    |
| 7151-0054 | 5-Large | 1    |
| 7151-0063 | 6-Small | 1    |
| 7151-0064 | 6-Large | 1    |
| 7151-0073 | 7-Small | 1    |
| 7151-0074 | 7-Large | 1    |

Femoral Wedge Trial RM/LL



| Cat. No.  | Size    | Qty. |
|-----------|---------|------|
| 7151-0011 | 1-Small | 1    |
| 7151-0012 | 1-Large | 1    |
| 7151-0021 | 2-Small | 1    |
| 7151-0022 | 2-Large | 1    |
| 7151-0031 | 3-Small | 1    |
| 7151-0032 | 3-Large | 1    |
| 7151-0041 | 4-Small | 1    |
| 7151-0042 | 4-Large | 1    |
| 7151-0051 | 5-Small | 1    |
| 7151-0052 | 5-Large | 1    |
| 7151-0061 | 6-Small | 1    |
| 7151-0062 | 6-Large | 1    |
| 7151-0071 | 7-Small | 1    |
| 7151-0072 | 7-Large | 1    |

Stem Removal Tool



| Cat. No.  | Qty. |
|-----------|------|
| 7151-1010 | 1    |

Sterile Case



| Cat. No.  | Qty. |
|-----------|------|
| 7151-5011 | 1    |

Nonporous Tibial Wedge Trial Spacer



| Cat. No.  | Size      | Qty. |
|-----------|-----------|------|
| 7151-0411 | 1-2-Small | 1    |
| 7151-0412 | 1-2-Large | 1    |
| 7151-0431 | 3-4-Small | 1    |
| 7151-0432 | 3-4-Large | 1    |
| 7151-0451 | 5-6-Small | 1    |
| 7151-0452 | 5-6-Large | 1    |

Tibial Alignment Plate Long  
(Not shown)

| Cat. No.  | Qty. |
|-----------|------|
| 7151-4600 | 1    |

Revision Distal Cutting Block

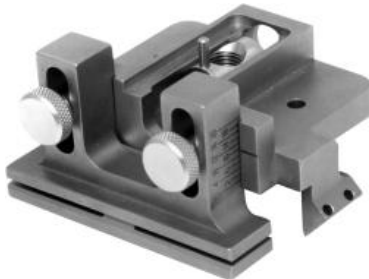

| Cat. No.  | Qty. |
|-----------|------|
| 7151-2585 | 1    |

Tibial Wedge Resection Guide



| Cat. No.  | Qty. |
|-----------|------|
| 7151-4513 | 1    |

# Reconstructive Surgery

## Knee Systems

Trial Coupler Extractor



| Cat. No.  | Qty. |
|-----------|------|
| 7151-1015 | 1    |

Trial Stem Extractor



| Cat. No.  | Qty. |
|-----------|------|
| 7151-1009 | 1    |

Wedge Cement Clamp



| Cat. No.  | Qty. |
|-----------|------|
| 7151-5104 | 2    |

### Profix Total Knee System/Instrumentation/Case #11, Posterior-Stabilized Trial Instruments

Box Chisel



| Cat. No.  | Qty. |
|-----------|------|
| 7151-2466 | 1    |

Box Chisel Guide



| Cat. No.  | Qty. |
|-----------|------|
| 7151-2463 | 1    |

Box Reamer



| Cat. No.  | Qty. |
|-----------|------|
| 7151-2465 | 1    |

Box Reamer Guide



| Cat. No.  | Qty. |
|-----------|------|
| 7151-2464 | 1    |

### Femoral Taper Attachment

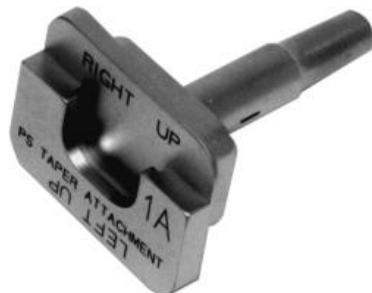

| Cat. No.  | Qty. |
|-----------|------|
| 7151-2472 | 1    |

### Femoral Trial Module

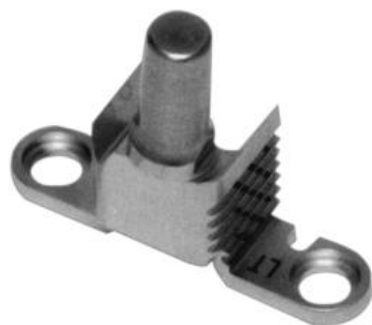

| Cat. No.  | Desc.         | Qty. |
|-----------|---------------|------|
| 7151-2474 | w/Taper Right | 1    |
| 7151-2475 | w/Taper Left  | 1    |
| 7151-2476 | w/o Taper     | 1    |

### Femoral Trial module Lug



| Cat. No.  | Qty. |
|-----------|------|
| 7151-2477 | 1    |

### P/S Femoral Trial



| Cat. No.  | Size    | Qty. |
|-----------|---------|------|
| 7151-2222 | 2-Left  | 1    |
| 7151-2122 | 2-Right | 1    |
| 7151-2232 | 3-Left  | 1    |
| 7151-2132 | 3-Right | 1    |
| 7151-2242 | 4-Left  | 1    |
| 7151-2142 | 4-Right | 1    |
| 7151-2252 | 5-Left  | 1    |
| 7151-2152 | 5-Right | 1    |
| 7151-2262 | 6-Left  | 1    |
| 7151-2162 | 6-Right | 1    |
| 7151-2272 | 7-Left  | 1    |
| 7151-2172 | 7-Right | 1    |

### P/S Femoral Wedge Spacer



| Cat. No.  | Size    | Qty. |
|-----------|---------|------|
| 7151-2480 | 2-Small | 1    |
| 7151-2481 | 2-Large | 1    |
| 7151-2482 | 3-Small | 1    |
| 7151-2483 | 3-Large | 1    |
| 7151-2484 | 4-Small | 1    |
| 7151-2485 | 4-Large | 1    |
| 7151-2486 | 5-Small | 1    |
| 7151-2487 | 5-Large | 1    |
| 7151-2488 | 6-Small | 1    |
| 7151-2489 | 6-Large | 1    |
| 7151-2490 | 7-Small | 1    |
| 7151-2491 | 7-Large | 1    |

### Positioner



| Cat. No.  | Qty. |
|-----------|------|
| 7151-2462 | 1    |

### Sterile Case

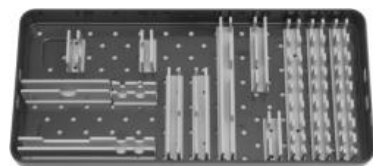

| Cat. No.  | Qty. |
|-----------|------|
| 7151-5012 | 1    |

### Profix Total Knee System/Instrumentation/Case #12, P/S Articular Insert Trials

### P/S Articular Insert Trials-Left



| Cat. No.  | Size | Thickness | Qty. |
|-----------|------|-----------|------|
| 7151-9221 | 2    | 10 mm     | 1    |
| 7151-9122 | 2    | 12 mm     | 1    |
| 7151-9123 | 2    | 14 mm     | 1    |
| 7151-9124 | 2    | 16 mm     | 1    |
| 7151-9125 | 2    | 18 mm     | 1    |
| 7151-9126 | 2    | 20 mm     | 1    |

### P/S Articular Insert Trials-Left

| Cat. No.  | Size | Thickness | Qty. |
|-----------|------|-----------|------|
| 7151-9127 | 2    | 25 mm     | 1    |
| 7151-9128 | 2    | 30 mm     | 1    |
| 7151-9129 | 2    | 35 mm     | 1    |
| 7151-9131 | 3    | 10 mm     | 1    |
| 7151-9132 | 3    | 12 mm     | 1    |
| 7151-9133 | 3    | 14 mm     | 1    |
| 7151-9134 | 3    | 16 mm     | 1    |
| 7151-9135 | 3    | 18 mm     | 1    |
| 7151-9136 | 3    | 20 mm     | 1    |
| 7151-9137 | 3    | 25 mm     | 1    |
| 7151-9138 | 3    | 30 mm     | 1    |
| 7151-9139 | 3    | 35 mm     | 1    |
| 7151-9141 | 4    | 10 mm     | 1    |
| 7151-9142 | 4    | 12 mm     | 1    |
| 7151-9143 | 4    | 14 mm     | 1    |
| 7151-9144 | 4    | 16 mm     | 1    |
| 7151-9145 | 4    | 18 mm     | 1    |
| 7151-9146 | 4    | 20 mm     | 1    |
| 7151-9147 | 4    | 25 mm     | 1    |
| 7151-9148 | 4    | 30 mm     | 1    |
| 7151-9149 | 4    | 35 mm     | 1    |
| 7151-9151 | 5    | 10 mm     | 1    |
| 7151-9152 | 5    | 12 mm     | 1    |
| 7151-9153 | 5    | 14 mm     | 1    |
| 7151-9154 | 5    | 16 mm     | 1    |
| 7151-9155 | 5    | 18 mm     | 1    |
| 7151-9156 | 5    | 20 mm     | 1    |
| 7151-9157 | 5    | 25 mm     | 1    |
| 7151-9158 | 5    | 30 mm     | 1    |
| 7151-9159 | 5    | 35 mm     | 1    |
| 7151-9161 | 6    | 10 mm     | 1    |
| 7151-9162 | 6    | 12 mm     | 1    |
| 7151-9163 | 6    | 14 mm     | 1    |
| 7151-9164 | 6    | 16 mm     | 1    |
| 7151-9165 | 6    | 18 mm     | 1    |
| 7151-9166 | 6    | 20 mm     | 1    |
| 7151-9167 | 6    | 25 mm     | 1    |
| 7151-9168 | 6    | 30 mm     | 1    |
| 7151-9169 | 6    | 35 mm     | 1    |

### P/S Articular Insert Trials-Right



| Cat. No.  | Size | Thickness | Qty. |
|-----------|------|-----------|------|
| 7151-9121 | 2    | 10 mm     | 1    |
| 7151-9122 | 2    | 12 mm     | 1    |
| 7151-9123 | 2    | 14 mm     | 1    |
| 7151-9124 | 2    | 16 mm     | 1    |
| 7151-9125 | 2    | 18 mm     | 1    |
| 7151-9126 | 2    | 20 mm     | 1    |
| 7151-9127 | 2    | 25 mm     | 1    |
| 7151-9128 | 2    | 30 mm     | 1    |
| 7151-9129 | 2    | 35 mm     | 1    |
| 7151-9131 | 3    | 10 mm     | 1    |
| 7151-9132 | 3    | 12 mm     | 1    |
| 7151-9133 | 3    | 14 mm     | 1    |
| 7151-9134 | 3    | 16 mm     | 1    |
| 7151-9135 | 3    | 18 mm     | 1    |
| 7151-9136 | 3    | 20 mm     | 1    |
| 7151-9137 | 3    | 25 mm     | 1    |
| 7151-9138 | 3    | 30 mm     | 1    |
| 7151-9139 | 3    | 35 mm     | 1    |
| 7151-9141 | 4    | 10 mm     | 1    |
| 7151-9142 | 4    | 12 mm     | 1    |
| 7151-9143 | 4    | 14 mm     | 1    |
| 7151-9144 | 4    | 16 mm     | 1    |
| 7151-9145 | 4    | 18 mm     | 1    |
| 7151-9146 | 4    | 20 mm     | 1    |
| 7151-9147 | 4    | 25 mm     | 1    |
| 7151-9148 | 4    | 30 mm     | 1    |
| 7151-9149 | 4    | 35 mm     | 1    |
| 7151-9151 | 5    | 10 mm     | 1    |
| 7151-9152 | 5    | 12 mm     | 1    |
| 7151-9153 | 5    | 14 mm     | 1    |
| 7151-9154 | 5    | 16 mm     | 1    |
| 7151-9155 | 5    | 18 mm     | 1    |
| 7151-9156 | 5    | 20 mm     | 1    |
| 7151-9157 | 5    | 25 mm     | 1    |
| 7151-9158 | 5    | 30 mm     | 1    |
| 7151-9159 | 5    | 35 mm     | 1    |
| 7151-9161 | 6    | 10 mm     | 1    |
| 7151-9162 | 6    | 12 mm     | 1    |
| 7151-9163 | 6    | 14 mm     | 1    |
| 7151-9164 | 6    | 16 mm     | 1    |

### P/S Articular Insert Trials-Right

| Cat. No.  | Size | Thickness | Qty. |
|-----------|------|-----------|------|
| 7151-9165 | 6    | 18 mm     | 1    |
| 7151-9166 | 6    | 20 mm     | 1    |
| 7151-9167 | 6    | 25 mm     | 1    |
| 7151-9168 | 6    | 30 mm     | 1    |
| 7151-9169 | 6    | 35 mm     | 1    |

### Sterile Case



| Cat. No.  | Qty. |
|-----------|------|
| 7151-5013 | 1    |

### Profix Total Knee System/Instrumentation/Constrained Articular Trials

#### Constrained Articular Trials-Left (Not shown)

| Cat. No.  | Size | Thickness |
|-----------|------|-----------|
| 7151-9422 | 2    | 12 mm     |
| 7151-9423 | 2    | 14 mm     |
| 7151-9424 | 2    | 16 mm     |
| 7151-9425 | 2    | 18 mm     |
| 7151-9426 | 2    | 20 mm     |
| 7151-9427 | 2    | 25 mm     |
| 7151-9432 | 3    | 12 mm     |
| 7151-9433 | 3    | 14 mm     |
| 7151-9434 | 3    | 16 mm     |
| 7151-9435 | 3    | 18 mm     |
| 7151-9436 | 3    | 20 mm     |
| 7151-9437 | 3    | 25 mm     |
| 7151-9442 | 4    | 12 mm     |
| 7151-9443 | 4    | 14 mm     |
| 7151-9444 | 4    | 16 mm     |
| 7151-9445 | 4    | 18 mm     |

### Constrained Articular Trials-Left

| Cat. No.  | Size | Thickness |
|-----------|------|-----------|
| 7151-9446 | 4    | 20 mm     |
| 7151-9447 | 4    | 25 mm     |
| 7151-9452 | 5    | 12 mm     |
| 7151-9453 | 5    | 14 mm     |
| 7151-9454 | 5    | 16 mm     |
| 7151-9455 | 5    | 18 mm     |
| 7151-9456 | 5    | 20 mm     |
| 7151-9457 | 5    | 25 mm     |
| 7151-9462 | 6    | 12 mm     |
| 7151-9463 | 6    | 14 mm     |
| 7151-9464 | 6    | 16 mm     |
| 7151-9465 | 6    | 18 mm     |
| 7151-9466 | 6    | 20 mm     |
| 7151-9467 | 6    | 25 mm     |

### Constrained Articular Trials-Right (Not shown)

| Cat. No.  | Size | Thickness | Position |
|-----------|------|-----------|----------|
| 7151-9322 | 2    | 12 mm     | Right    |
| 7151-9323 | 2    | 14 mm     | Right    |
| 7151-9324 | 2    | 16 mm     | Right    |
| 7151-9325 | 2    | 18 mm     | Right    |
| 7151-9326 | 2    | 20 mm     | Right    |
| 7151-9327 | 2    | 25 mm     | Right    |
| 7151-9332 | 3    | 12 mm     | Right    |
| 7151-9333 | 3    | 14 mm     | Right    |
| 7151-9334 | 3    | 16 mm     | Right    |
| 7151-9335 | 3    | 18 mm     | Right    |
| 7151-9336 | 3    | 20 mm     | Right    |
| 7151-9337 | 3    | 25 mm     | Right    |
| 7151-9342 | 4    | 12 mm     | Right    |
| 7151-9343 | 4    | 14 mm     | Right    |
| 7151-9344 | 4    | 16 mm     | Right    |
| 7151-9345 | 4    | 18 mm     | Right    |
| 7151-9346 | 4    | 20 mm     | Right    |
| 7151-9347 | 4    | 25 mm     | Right    |
| 7151-9352 | 5    | 12 mm     | Right    |
| 7151-9353 | 5    | 14 mm     | Right    |
| 7151-9354 | 5    | 16 mm     | Right    |
| 7151-9355 | 5    | 18 mm     | Right    |
| 7151-9356 | 5    | 20 mm     | Right    |
| 7151-9357 | 5    | 25 mm     | Right    |
| 7151-9362 | 6    | 12 mm     | Right    |
| 7151-9363 | 6    | 14 mm     | Right    |
| 7151-9364 | 6    | 16 mm     | Right    |
| 7151-9365 | 6    | 18 mm     | Right    |

### Constrained Articular Trials-Right

| Cat. No.  | Size | Thickness | Position |
|-----------|------|-----------|----------|
| 7151-9366 | 6    | 20 mm     | Right    |
| 7151-9367 | 6    | 25 mm     | Right    |

### Constrained Sterile Case (Left)



| Cat. No.  |
|-----------|
| 7151-5016 |

### Constrained Sterile Case (Right) (Not shown)

| Cat. No.  |
|-----------|
| 7151-5017 |

### Profix Total Knee System/Instrumentation/Sawblades

#### 3M 1/2



| Cat. No.  |
|-----------|
| 7151-2908 |

#### 3M 3/4



| Cat. No.  |
|-----------|
| 7151-2904 |

#### Amsco Hall 1/2



| Cat. No.  |
|-----------|
| 7151-2907 |

### Amsco Hall 3/4

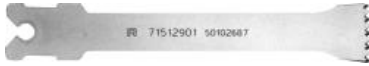

Cat. No.  
7151-2903

### Old Stryker 1/2

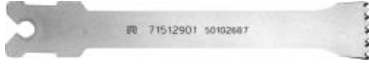

Cat. No.  
7151-2906

### Old Stryker 3/4



Cat. No.  
7151-2902

### Stryker 2000 1/2

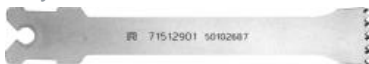

Cat. No.  
7151-2905

### Stryker 2000 3/4

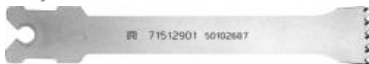

Cat. No.  
7151-2901

### Accuris Uni Knee System/Oxinium Uni Femoral Implants

### Oxinium Uni Femoral Implant (Not shown)

| Cat. No.  | Size    | Qty  |
|-----------|---------|------|
| 7124-5030 | X-Small | 1 ea |

### Oxinium Uni Femoral Implant

| Cat. No.  | Size        | Qty  |
|-----------|-------------|------|
| 7124-5031 | Small       | 1 ea |
| 7124-5032 | Medium      | 1 ea |
| 7124-5033 | Large       | 1 ea |
| 7124-5034 | X-Large     | 1 ea |
| 7124-5035 | Magnum      | 1 ea |
| 7124-5036 | Magnum Plus | 1 ea |

### Oxinium Uni Femoral Set (Not shown)

Cat. No.  
7124-5000

### Accuris Uni Knee System/Genesis Uni Femoral Implants

### Genesis Uni Femoral Component (Not shown)

| Cat. No. | Size        | Qty  |
|----------|-------------|------|
| 72-5001  | X-Small     | 1 ea |
| 72-5002  | Small       | 1 ea |
| 72-5003  | Medium      | 1 ea |
| 72-5004  | Large       | 1 ea |
| 72-5005  | X-Large     | 1 ea |
| 72-5006  | Magnum      | 1 ea |
| 72-5007  | Magnum Plus | 1 ea |

### Genesis Uni Femoral Set (Not shown)

Cat. No.  
7123-6100

### Accuris Uni Knee System/Metal-Base Tibial Implants

### Genesis Uni Articular Insert (Not shown)

| Cat. No.  | Size          | Thickness | Qty  |
|-----------|---------------|-----------|------|
| 7124-8108 | X-Small/Small | 8mm       | 2 ea |
| 7124-8109 | X-Small/Small | 9mm       | 2 ea |



# Reconstructive Surgery

## Knee Systems

### Genesis Uni Articular Insert

| Cat. No.  | Size           | Thickness | Qty  |
|-----------|----------------|-----------|------|
| 7124-8110 | X-Small/Small  | 10mm      | 2 ea |
| 7124-8111 | X-Small/Small  | 11mm      | 2 ea |
| 7124-8112 | X-Small/Small  | 12mm      | 2 ea |
| 7124-8208 | Medium/Large   | 8mm       | 2 ea |
| 7124-8209 | Medium/Large   | 9mm       | 2 ea |
| 7124-8210 | Medium/Large   | 10mm      | 2 ea |
| 7124-8211 | Medium/Large   | 11mm      | 2 ea |
| 7124-8212 | Medium/Large   | 12mm      | 2 ea |
| 7124-8308 | X-Large/Magnum | 8mm       | 2 ea |
| 7124-8309 | X-Large/Magnum | 9mm       | 2 ea |
| 7124-8310 | X-Large/Magnum | 10mm      | 2 ea |
| 7124-8311 | X-Large/Magnum | 11mm      | 2 ea |
| 7124-8312 | X-Large/Magnum | 12mm      | 2 ea |

### Genesis Uni Tibial Base

(Not shown)

| Cat. No. | Desc          | Size    | Qty  |
|----------|---------------|---------|------|
| 72-6100  | LT MDL/RT LAT | X-Small | 1 ea |
| 72-6101  | LT MDL/RT LAT | Small   | 1 ea |
| 72-6202  | LT MDL/RT LAT | Medium  | 1 ea |
| 72-6203  | LT MDL/RT LAT | Large   | 1 ea |
| 72-6304  | LT MDL/RT LAT | X-Large | 1 ea |
| 72-6305  | LT MDL/RT LAT | Magnum  | 1 ea |
| 72-7100  | RT MDL/LT LAT | X-Small | 1 ea |
| 72-7101  | RT MDL/LT LAT | Small   | 1 ea |
| 72-7202  | RT MDL/LT LAT | Medium  | 1 ea |
| 72-7203  | RT MDL/LT LAT | Large   | 1 ea |
| 72-7304  | RT MDL/LT LAT | X-Large | 1 ea |
| 72-7305  | RT MDL/LT LAT | Magnum  | 1 ea |

### Genesis Uni Tibial Modular Peg

(Not shown)

Cat. No.  
72-5557

### Metal Backed Tibial & Insert Set

(Not shown)

Cat. No.  
7123-6200

### Oxinium UniCompartmental Femoral Sample

(Not shown)

Cat. No.  
7143-0851 Large  
7143-0853 Misc. Sizes

### Accuris Uni Knee System/All-Polyethylene Inlay Tibial Implants

#### Accuris Tibial Inlay Cutter

2 each

(Not shown)

Cat. No.  
7123-7200

### Genesis Uni Symmetric A/P Tibial Base

(Not shown)

| Cat. No.  | Size      | Qty  |
|-----------|-----------|------|
| 7124-2409 | 34 x 9mm  | 2 ea |
| 7124-2410 | 34 x 10mm | 2 ea |
| 7124-2412 | 34 x 12mm | 2 ea |
| 7124-2415 | 34 x 15mm | 2 ea |
| 7124-2509 | 38 x 9mm  | 2 ea |
| 7124-2510 | 38 x 10mm | 2 ea |
| 7124-2512 | 38 x 12mm | 2 ea |
| 7124-2515 | 38 x 15mm | 2 ea |
| 7124-2609 | 42 x 9mm  | 2 ea |
| 7124-2610 | 42 x 10mm | 2 ea |
| 7124-2612 | 42 x 12mm | 2 ea |
| 7124-2615 | 42 x 15mm | 2 ea |

### Symmetric All-Polyethylene Inlay Implant Set

(Not shown)

Cat. No.  
7123-6300

### Accuris Uni Knee System/Instrumentation

#### Accuris Tibial Inlay Base Trial

(Not shown)

Cat. No. Size  
7123-6234 34mm

### Accuris Tibial Inlay Base Trial

| Cat. No.  | Size |
|-----------|------|
| 7123-6238 | 38mm |
| 7123-6242 | 42mm |

### Accuris Tibial Inlay Cutter

(Not shown)

| Cat. No.  |
|-----------|
| 7123-7200 |

### Accuris Alternate Femoral Reamer

(Not shown)

| Cat. No.  |
|-----------|
| 7123-6150 |

### Accuris Alternate Femoral Reamer Pilot Drill

(Not shown)

| Cat. No.  |
|-----------|
| 7123-6156 |

### Accuris Alternate Femoral Reamer Small

(Not shown)

| Cat. No.  |
|-----------|
| 7123-6151 |

### Accuris Cutting Block

(Not shown)

| Cat. No.  | Size |
|-----------|------|
| 7123-6108 | 8mm  |
| 7123-6109 | 9mm  |

### Accuris Femoral Final Trial Tray Insert

(Not shown)

| Cat. No.  |
|-----------|
| 7123-6996 |

### Accuris Femoral Handle/Drill Guide

(Not shown)

| Cat. No.  |
|-----------|
| 7123-6950 |

### Accuris Femoral Lug Drill

(Not shown)

| Cat. No.  |
|-----------|
| 7123-6951 |

### Accuris Impactor Head

(Not shown)

| Cat. No.  |
|-----------|
| 7123-6967 |

### Accuris Inlay Tibial Alignment System

(Not shown)

| Cat. No.  |
|-----------|
| 7123-6130 |

### Accuris Instrument Tray #1

(Not shown)

| Cat. No.  |
|-----------|
| 7123-6992 |

### Accuris Instrument Tray #2

(Not shown)

| Cat. No.  |
|-----------|
| 7123-6994 |

### Accuris Instruments (MicroMotors)

(Not shown)

| Cat. No.  | Size/Position | Description                             | Material  |
|-----------|---------------|---|---|
| 7123-7100 | LW/RL         | Sterile Femoral Cutters                 |   |
| 7123-7101 | RM/LL         | Sterile Femoral Cutters                 |   |
| 7123-7200 |               | Sterile Tibial Inlay Cutter             |   |
| 7123-7430 | LW/RL         | Non-Sterile Fem Reamer Assy, Left Hand  | 440C Stainless Steel  |
| 7123-7431 | RM/LL         | Non-Sterile Fem Reamer Assy, Right Hand | 440C Stainless Steel  |
| 7123-7550 |               | Femoral reamer Connector Assembly       | 17-4 Stainless Steel; 6061-T6 Aluminum  |
| 7123-7432 |               | Non-Sterile Tibial Inlay Cutter         | 17-4 Stainless Steel, 440C Stainless Steel  |
| 7123-7300 |               | POwer/Surgical Drive System 115V Kit    | 5052 H32 Aluminum   |
| 7123-7500 |               | Hand Piece (assembly motor)             | 416T Stainless Steel, 6061-T6 Aluminum, 303 Stainless Steel, Silicone rubber w/ Sterilene Coating |

# Reconstructive Surgery

## Knee Systems

### Accuris Instruments (MicroMotors)

| Cat. No.  | Size/Position | Description                        | Material          |
|-----------|---------------|------------------------------------|-------------------|
| 7123-7502 |               | Power System 230 V Kit             | 5052 H32 Aluminum |
| 7123-7402 |               | Power Cord - North America         | Molded PVC        |
| 7123-7404 |               | Power Cord - India/South Africa    | Molded PVC        |
| 7123-7406 |               | Power Cord - Italy                 | Molded PVC        |
| 7123-7408 |               | Power Cord - Denmark               | Molded PVC        |
| 7123-7410 |               | Power Cord - West/East Europe      | Molded PVC        |
| 7123-7412 |               | Power Cord - Switzerland           | Molded PVC        |
| 7123-7414 |               | Power Cord - UK/Hong Kong          | Molded PVC        |
| 7123-7416 |               | Power Cord - Australia/New Zealand | Molded PVC        |
| 7123-7418 |               | Power Cord - Argentina             | Molded PVC        |
| 7123-7420 |               | Power Cord - Japan                 | Molded PVC        |

### Accuris Instruments (S&N)

| Cat. No.  | Size        | Description                          | Material             |
|-----------|-------------|--------------------------------------|----------------------|
|           |             | Alignment Connector                  | Stainless Steel      |
| 7123-6123 | 7°          | Inlay Alignment Connector            | 17-4 Stainless Steel |
| 7123-6130 |             | Tibial Alignment System Assy         | 17-4 Stainless Steel |
| 7123-6132 |             | Ankle Clamp                          | 17-4 Stainless Steel |
| 7123-6133 |             | Locking Screws (3)                   | 17-4 Stainless Steel |
| 7123-6140 |             | Tibial Inlay Template                | 17-4 Stainless Steel |
| 7123-6150 | Large       | Alternate Femoral Reamer             | 17-4 Stainless Steel |
| 7123-6151 | Small       | Alternate Femoral Reamer             | 17-4 Stainless Steel |
| 7123-6152 | XSM/SM      | Alternate femoral Reamer Sizer/Guide | 17-4 Stainless Steel |
| 7123-6153 | MED/LG      | Alternate Femoral Reamer Sizer/Guide | 17-4 Stainless Steel |
| 7123-6154 | XL/MAG/MAG+ | Alternate Femoral Reamer Sizer/Guide | 17-4 Stainless Steel |
| 7123-6156 |             | Alternate Femoral Reamer Pilot Drill | 17-4 Stainless Steel |
| 7123-6609 | 34mm x 9mm  | Tibial Inlay Insert Trial            | Acetal Copolymer     |
| 7123-6610 | 34mm x 10mm | Tibial Inlay Insert Trial            | Acetal Copolymer     |
| 7123-6612 | 34mm x 12mm | Tibial Inlay Insert Trial            | Acetal Copolymer     |
| 7123-6709 | 38mm x 9mm  | Tibial Inlay Insert Trial            | Acetal Copolymer     |
| 7123-6710 | 38mm x 10mm | Tibial Inlay Insert Trial            | Acetal Copolymer     |
| 7123-6712 | 38mm x 12mm | Tibial Inlay Insert Trial            | Acetal Copolymer     |
| 7123-6809 | 42mm x 9mm  | Tibial Inlay Insert Trial            | Acetal Copolymer     |
| 7123-6810 | 42mm x 10mm | Tibial Inlay Insert Trial            | Acetal Copolymer     |
| 7123-6812 | 42mm x 12mm | Tibial Inlay Insert Trial            | Acetal Copolymer     |
| 7123-6234 | 34mm        | Tibial Inlay Base Trial              | 17-4 Stainless Steel |

### Accuris Instruments (S&N)



| Cat. No.  | Size      | Description               | Material             |
|-----------|-----------|---------------------------|----------------------|
| 7123-6002 | 2mm RM/LL | Joint Balancing Shim      | 17-4 Stainless Steel |
| 7123-6003 | 3mm Rm/LL | Joint Balancing Shim      | 17-4 Stainless Steel |
| 7123-6004 | 4mm RM/LL | Joint Balancing Shim      | 17-4 Stainless Steel |
| 7123-6005 | 2mm LM/RL | Joint Balancing Shim      | 17-4 Stainless Steel |
| 7123-6006 | 3mm LM/RL | Joint Balancing Shim      | 17-4 Stainless Steel |
| 7123-6007 | 4mm LM/RL | Joint Balancing Shim      | 17-4 Stainless Steel |
| 7123-6008 | 1mm LM/RL | Joint Balancing Shim      | 17-4 Stainless Steel |
| 7123-6009 | 1mm RM/LL | Joint Balancing Shim      | 17-4 Stainless Steel |
| 7123-6108 | 8mm       | Cutting Blocks            | 17-4 Stainless Steel |
| 7123-6109 | 9mm       | Cutting Blocks            | 17-4 Stainless Steel |
| 7123-6120 | 3°        | Onlay Alignment Connector | 17-4 Stainless Steel |
| 7123-6121 | 7°        | Onlay Alignment Connector | 17-4 Stainless Steel |
| 7123-6122 | 3°        | Inlay                     | 17-4                 |

### Accuris Instruments (S&N)

| Cat. No.  | Size          | Description             | Material             |
|-----------|---------------|-------------------------|----------------------|
|           |               |                         | Steel                |
| 7123-6238 | 38mm          | Tibial Inlay Base Trial | 17-4 Stainless Steel |
| 7123-6242 | 42mm          | Tibial Inlay Base Trial | 17-4 Stainless Steel |
| 7123-6201 | X-Small RM/LL | Tibial Onlay Base Trial | 17-4 Stainless Steel |
| 7123-6202 | Small/RM/LL   | Tibial Onlay Base Trial | 17-4 Stainless Steel |
| 7123-6203 | Medium RM/LL  | Tibial Onlay Base Trial | 17-4 Stainless Steel |
| 7123-6204 | Large RM/LL   | Tibial Onlay Base Trial | 17-4 Stainless Steel |
| 7123-6205 | X-Large Rm/LL | Tibial Onlay Base Trial | 17-4 Stainless Steel |
| 7123-6206 | Mag RM/LL     | Tibial Onlay Base Trial | 17-4 Stainless Steel |
| 7123-6211 | X-Small LM/RL | Tibial Onlay Base Trial | 17-4 Stainless Steel |
| 7123-6212 | Small LM/RL   | Tibial Onlay Base Trial | 17-4 Stainless Steel |
| 7123-6213 | Medium LM/RL  | Tibial Onlay Base Trial | 17-4 Stainless Steel |
| 7123-6214 | Large LM/RL   | Tibial Onlay Base Trial | 17-4 Stainless Steel |
| 7123-6215 | X-Large LM/RL | Tibial Onlay Base Trial | 17-4 Stainless Steel |
| 7123-6216 | Mag LM/RL     | Tibial Onlay Base Trial | 17-4 Stainless Steel |
| 7123-6901 | X-Small       | Femoral Finishing Trial | 17-4 Stainless Steel |
| 7123-6902 | Small         | Femoral Finishing Trial | 17-4 Stainless Steel |
| 7123-6903 | Medium        | Femoral Finishing Trial | 17-4 Stainless Steel |
| 7123-6904 | Large         | Femoral Finishing Trial | 17-4 Stainless Steel |
| 7123-6905 | X-Large       | Femoral Finishing Trial | 17-4 Stainless Steel |
| 7123-6906 | Mag           | Femoral Finishing Trial | 17-4 Stainless Steel |

### Accuris Instruments (S&N)

| Cat. No.  | Size              | Description                      | Material                            |
|-----------|-------------------|----------------------------------|-------------------------------------|
| 7123-6907 | Mag+              | Femoral Finishing Trial          | 17-4 Stainless Steel                |
| 7123-6913 | X-Small           | Femoral Final Trial              | 17-4 Stainless Steel                |
| 7123-6914 | Small             | Femoral Final Trial              | 17-4 Stainless Steel                |
| 7123-6915 | Medium            | Femoral Final Trial              | 17-4 Stainless Steel                |
| 7123-6916 | Large             | Femoral Final Trial              | 17-4 Stainless Steel                |
| 7123-6917 | X-Large           | Femoral Final Trial              | 17-4 Stainless Steel                |
| 7123-6918 | Mag               | Femoral Final Trial              | 17-4 Stainless Steel                |
| 7123-6919 | Mag+              | Femoral Final Trial              | 17-4 Stainless Steel                |
| 7123-6308 | XSM/SM, 8mm       | Tibial Onlay Insert Trials       | Acetal Copolymer                    |
| 7123-6309 | XSM/SM, 9mm       | Tibial Onlay Insert Trials       | Acetal Copolymer                    |
| 7123-6310 | XSM/SM, 10mm      | Tibial Onlay Insert Trials       | Acetal Copolymer                    |
| 7123-6311 | XSM/SM, 11mm      | Tibial Onlay Insert Trials       | Acetal Copolymer                    |
| 7123-6312 | XSM/SM, 12mm      | Tibial Onlay Insert Trials       | Acetal Copolymer                    |
| 7123-6409 | MED/LG, 9mm       | Tibial Onlay Insert Trials       | Acetal Copolymer                    |
| 7123-6410 | MED/LG, 10mm      | Tibial Onlay Insert Trials       | Acetal Copolymer                    |
| 7123-6411 | MED/LG, 11mm      | Tibial Onlay Insert Trials       | Acetal Copolymer                    |
| 7123-6412 | MED/LG, 12mm      | Tibial Onlay Insert Trials       | Acetal Copolymer                    |
| 7123-6508 | XLG/MAG, 8mm      | Tibial Onlay Insert Trials       | Acetal Copolymer                    |
| 7123-6509 | XLG/MAG, 9mm      | Tibial Onlay Insert Trials       | Acetal Copolymer                    |
| 7123-6510 | XLG/MAG, 10mm     | Tibial Onlay Insert Trials       | Acetal Copolymer                    |
| 7123-6511 | XLG/MAG, 11mm     | Tibial Onlay Insert Trials       | Acetal Copolymer                    |
| 7123-6512 | XLG/MAG, 12mm     | Tibial Onlay Insert Trials       | Acetal Copolymer                    |
| 28-2772   | Baby Lane Forceps | Femoral Trial Extractor          | 400 Series Stainless Steel          |
| 7123-6950 |                   | Femoral Trial Handle/Drill Guide | 17-4 Stainless Steel, 316 Stainless |

# Reconstructive Surgery

## Knee Systems

### Accuris Instruments (S&N)

| Cat. No.  | Size     | Description                                      | Material  |
|-----------|----------|--|---|
|           |          |  | Steel   |
| 7123-6911 |          | Femoral Final Trial Lug                          |   |
| 7123-6951 | 17-4     | Femoral Lug Drill                                | Stainless Steel   |
| 7123-6952 | 17-4     | Femoral Impactor                                 | Stainless Steel, Polypropylene  |
| 7123-6960 | 17-4     | Tibial Trial head/Sizer                          | Stainless Steel   |
| 7123-6962 | 17-4     | Tibial Drill Guide                               | Stainless Steel   |
| 7123-6963 | 17-4     | Tibial Boss Drill                                | Stainless Steel   |
| 7123-6964 | 17-4     | Tibial Boss/Screw Drill                          | Stainless Steel   |
| 7123-6965 | 17-4     | Tibial Boss/Modular Peg Drill                    | Stainless Steel   |
| 7123-6966 | 17-4     | Tibial Fin Punch                                 | Stainless Steel   |
| 7123-6967 | 17-4     | Impactor Head                                    | Stainless Steel   |
| 7123-6968 | 17-4     | Tibial Base Impactor/Cement Pressurizer          | Stainless Steel, 416 Stainless Steel, Acetal Copolymer                    |
| 11-4894   |          | Femoral File                                     |   |
| 7123-6971 | 17-4     | Tibial Screw Tap                                 | Stainless Steel, 6061-T6 Aluminum   |
| 7123-6990 | 5052-H32 | Accuris Unicompartmen Knee System Trial Tray     | Aluminum, Polyamide (nylon) powder coating brackets), 304 Stainless Steel |
| 7123-6992 | 5052-H32 | Accuris Unicompartmen Knee System Instru Tray #1 | Aluminum, Polyamide (nylon) powder coating brackets),                     |

### Accuris Instruments (S&N)

| Cat. No.  | Size     | Description                                    | Material  |
|-----------|----------|--|---|
|           |          |  | 304 Stainless Steel   |
| 7123-6994 | 5052-H32 | Accuris Unicompartmen System Instru Tray #2    | Aluminum, Polyamide (nylon) powder coating brackets), 304 Stainless Steel |
| 7123-6996 | 5052-H32 | Accuris Femoral Final Trail Tray Insert        | Aluminum, 70 durometer medical grade silicone (for trial holder)          |
| 7123-6998 | Radel    | Accuris Unicompartmen Power Case               | polyphenyl sulfone) 5500, 304 Stainless Steel                             |
| 11-4968   | 17-4     | Pin and Drill Set                              | Stainless Steel, 316 Stainless Steel                                      |
| 7121-0002 | 17-4     | Trocar Pin                                     | Stainless Steel   |
| 7144-0488 | 17-4     | Profix Universal Pin Puller                    | Stainless Steel   |
| 7144-0044 | 17-4     | Quick Connect Handle/Alignment Tower           | Stainless Steel   |
| 7156-5631 | 17-4     | Short Bone Spike                               | Stainless Steel   |
| 7123-7550 |          | Accuris Femoral Reamer                         |   |
| 7112-9400 | 4.8"     | Large Outer Case                               |   |
| 7112-9401 | 2.4"     | Small Outer Case                               |   |
| 7112-9402 |          | Lid for Outer Cases                            |   |
| 11-5035   |          | HEX SCDR for 4.5mm and 6.5mm BN SCRS Pin Caddy |   |

### Accuris Joint Balancing Shim

(Not shown)

| Cat. No.  | Size | Desc  |
|-----------|------|-------|
| 7123-6002 | 2mm  | RM/LL |
| 7123-6003 | 3mm  | RM/LL |
| 7123-6004 | 4mm  | RM/LL |
| 7123-6005 | 2mm  | LM/RL |
| 7123-6006 | 3mm  | LM/RL |

### Accuris Joint Balancing Shim

(Not shown)

| Cat. No.  | Desc      |
|-----------|-----------|
| 7123-6007 | 4mm LM/RL |
| 7123-6008 | 1MM LM/RL |
| 7123-6009 | 1MM RM/LL |

### Accuris Onlay Alignment Connector

(Not shown)

| Cat. No.  | Desc  |
|-----------|-------|
| 7123-6120 | 3 Deg |
| 7132-6121 | 7 Deg |

### Accuris Power Cords

(Not shown)

| Cat. No.  | Description       |
|-----------|-------------------|
| 7123-7402 | North America     |
| 7123-7410 | West/East America |

### Accuris Power System 115 V

(Not shown)

| Cat. No.  |
|-----------|
| 7123-7300 |

### Accuris Sizer Guide Block

(Not shown)

| Cat. No.  | Size                       |
|-----------|----------------------------|
| 7123-6152 | X-Small/Small              |
| 7123-6153 | Medium/Large               |
| 7123-6154 | X-Large/Magnum/Magnum Plus |

### Accuris Tibial Base Impact/Cement Pressurize

(Not shown)

| Cat. No.  |
|-----------|
| 7123-6968 |

### Accuris Tibial Base Inlay Sizing Template

(Not shown)

| Cat. No.  |
|-----------|
| 7123-6140 |

### Accuris Tibial Boss/Modular Peg Drill

(Not shown)

| Cat. No.  |
|-----------|
| 7123-6964 |

### Accuris Tibial Boss/Screw Drill

(Not shown)

| Cat. No.  |
|-----------|
| 7123-6964 |

### Accuris Tibial Fin Punch

(RM/LL)

(Not shown)

| Cat. No.  |
|-----------|
| 7123-6966 |

### Accuris Tibial Inlay Trial

(Not shown)

| Cat. No.  | Size        |
|-----------|-------------|
| 7123-6609 | 34mm x 9mm  |
| 7123-6610 | 34mm x 10mm |
| 7123-6612 | 34mm x 12mm |
| 7123-6709 | 38mm x 9mm  |
| 7123-6710 | 38mm x 10mm |
| 7123-6712 | 38mm x 12mm |
| 7123-6809 | 42mm x 9mm  |
| 7123-6810 | 42mm x 10mm |
| 7123-6812 | 42mm x 12mm |

### Accuris Tibial Insert Trial

(Not shown)

| Cat. No.  | Desc           | Size |
|-----------|----------------|------|
| 7123-6308 | X-Small/Small  | 8    |
| 7123-6309 | X-Small/Small  | 9    |
| 7123-6310 | X-Small/Small  | 10   |
| 7123-6311 | X-Small/Small  | 11   |
| 7123-6312 | X-Small/Small  | 12   |
| 7123-6408 | Medium/Large   | 8    |
| 7123-6409 | Medium/Large   | 9    |
| 7123-6410 | Medium/Large   | 10   |
| 7123-6411 | Medium/Large   | 11   |
| 7123-6412 | Medium/Large   | 12   |
| 7123-6508 | X-Large/Magnum | 8    |
| 7123-6509 | X-Large/Magnum | 9    |
| 7123-6510 | X-Large/Magnum | 10   |
| 7123-6511 | X-Large/Magnum | 11   |
| 7123-6512 | X-Large/Magnum | 12   |

### Accuris Tibial Only Base Trial

(Not shown)

| Cat. No.  | Size           |
|-----------|----------------|
| 7123-6211 | X-Small, LM/RL |
| 7123-6212 | Small, LM/RL   |
| 7123-6213 | Medium, LM/RL  |
| 7123-6214 | Large, LM/RL   |
| 7123-6215 | X-Large, LM/RL |
| 7123-6216 | Magnum, LM/RL  |

### Accuris Tibial Only Base Trial

(Not shown)

| Cat. No.  | Size    |
|-----------|---------|
| 7123-6201 | X-Small |
| 7123-6202 | Small   |
| 7123-6203 | Medium  |
| 7123-6204 | Large   |
| 7123-6205 | X-Large |
| 7123-6206 | Magnum  |

### Accuris Tibial Screw Tap

(Not shown)

| Cat. No.  |
|-----------|
| 7123-6971 |

### Accuris Tibial Trial Handle/Sizer

(Not shown)

| Cat. No.  |
|-----------|
| 7123-6960 |

### Accuris Trial Tray

(Not shown)

| Cat. No.  |
|-----------|
| 7123-6990 |

### Accuris/Genesis Unicondylar Implants (S&N)

(Not shown)

| Cat. No.  | Size              | Description                    | Material                 |
|-----------|-------------------|--------------------------------|--------------------------|
| 72-5001   | X-Small           | Genesis Uni Femoral            | Cobalt-Chromium          |
| 72-5002   | Small             | Genesis Uni Femoral            | Cobalt-Chromium          |
| 72-5003   | Medium            | Genesis Uni Femoral            | Cobalt-Chromium          |
| 72-5004   | Large             | Genesis Uni Femoral            | Cobalt-Chromium          |
| 72-5005   | X-Large           | Genesis Uni Femoral            | Cobalt-Chromium          |
| 72-5006   | Magnum            | Genesis Uni Femoral            | Cobalt-Chromium          |
| 7124-5007 | Mangmun+          | Genesis Uni Femoral            | Cobalt-Chromium          |
| 72-6100   | X-Small           | Genesis Uni LM/RL Tibial Base  | Titanium Alloy (Ti6Al4V) |
| 72-6101   | Small             | Genesis Uni LM/RL Tibial Base  | Titanium Alloy (Ti6Al4V) |
| 72-6202   | Medium            | Genesis Uni LM/RL Tibial Base  | Titanium Alloy (Ti6Al4V) |
| 72-6203   | Large             | Genesis Uni LM/RL Tibial Base  | Titanium Alloy (Ti6Al4V) |
| 72-6304   | X-Large           | Genesis Uni LM/RL Tibial Base  | Titanium Alloy (Ti6Al4V) |
| 72-6305   | Magnum            | Genesis Uni LM/RL Tibial Base  | Titanium Alloy (Ti6Al4V) |
| 72-7100   | X-Small           | Genesis Uni RM/LL Tibial Base  | Titanium Alloy (Ti6Al4V) |
| 72-7101   | Small             | Genesis Uni RM/LL Tibial Base  | Titanium Alloy (Ti6Al4V) |
| 72-7202   | Medium            | Genesis Uni RM/LL Tibial Base  | Titanium Alloy (Ti6Al4V) |
| 72-7203   | Large             | Genesis Uni RM/LL Tibial Base  | Titanium Alloy (Ti6Al4V) |
| 72-7304   | X-Large           | Genesis Uni RM/LL Tibial Base  | Titanium Alloy (Ti6Al4V) |
| 72-7305   | Magnum            | Genesis Uni RM/LL Tibial Base  | Titanium Alloy (Ti6Al4V) |
| 72-5558   | 16m               | Tibial Compression Screw       | Titanium Alloy (Ti6Al4V) |
| 72-5559   | 22m               | Tibial Compression Screw       | Titanium Alloy (Ti6Al4V) |
| 72-5557   |                   | Genesis Uni Tibial Modular Peg | Titanium Alloy (Ti6Al4V) |
| 7124-8108 | X-Small/Small 8mm | Genesis Uni Articular Insert   | UHMWPE                   |
| 7124-8109 | X-Small/Small 9mm | Genesis Uni Articular Insert   | UHMWPE                   |

### Accuris/Genesis Unicondylar Implants (S&N)

| Cat. No.  | Size                | Description                          | Material |
|-----------|---------------------|--------------------------------------|----------|
| 7124-8110 | X-Small/Small 10mm  | Genesis Uni Articular Insert         | UHMWPE   |
| 7124-8111 | X-Small/Small 11mm  | Genesis Uni Articular Insert         | UHMWPE   |
| 7124-8112 | X-Small/Small 12mm  | Genesis Uni Articular Insert         | UHMWPE   |
| 7124-8208 | Medium/Large 8mm    | Genesis Uni Articular Insert         | UHMWPE   |
| 7124-8209 | Medium/Large 9mm    | Genesis Uni Articular Insert         | UHMWPE   |
| 7124-8210 | Medium/Large 10mm   | Genesis Uni Articular Insert         | UHMWPE   |
| 7124-8211 | Medium/Large 11mm   | Genesis Uni Articular Insert         | UHMWPE   |
| 7124-8212 | Medium/Large 12mm   | Genesis Uni Articular Insert         | UHMWPE   |
| 7124-8308 | X-Large/Magnum 8mm  | Genesis Uni Articular Insert         | UHMWPE   |
| 7124-8309 | X-Large/Magnum 9mm  | Genesis Uni Articular Insert         | UHMWPE   |
| 7124-8310 | X-Large/Magnum 10mm | Genesis Uni Articular Insert         | UHMWPE   |
| 7124-8311 | X-Large/Magnum 11mm | Genesis Uni Articular Insert         | UHMWPE   |
| 7124-8312 | X-Large/Magnum 12mm | Genesis Uni Articular Insert         | UHMWPE   |
| 7124-2409 | 34 x 9mm            | Genesis Uni Symmetric All-Poly Tibia | UHMWPE   |
| 7124-2410 | 34 x 10mm           | Genesis Uni Symmetric All-Poly Tibia | UHMWPE   |
| 7124-2412 | 34 x 12mm           | Genesis Uni Symmetric All-Poly Tibia | UHMWPE   |
| 7124-2415 | 34 x 15mm           | Genesis Uni Symmetric All-Poly Tibia | UHMWPE   |
| 7124-2509 | 38 x 9mm            | Genesis Uni Symmetric All-Poly Tibia | UHMWPE   |
| 7124-2510 | 38 x 10mm           | Genesis Uni Symmetric All-Poly Tibia | UHMWPE   |
| 7124-2512 | 38 x 12mm           | Genesis Uni Symmetric All-Poly Tibia | UHMWPE   |
| 7124-2515 | 38 x 15mm           | Genesis Uni Symmetric All-Poly Tibia | UHMWPE   |
| 7124-2609 | 42 x 9mm            | Genesis Uni Symmetric All-Poly Tibia | UHMWPE   |
| 7124-2610 | 42 x 10mm           | Genesis Uni Symmetric All-Poly Tibia | UHMWPE   |
| 7124-2612 | 42 x 12mm           | Genesis Uni Symmetric All-Poly Tibia | UHMWPE   |
| 7124-2615 | 42 x 15mm           | Genesis Uni Symmetric All-Poly Tibia | UHMWPE   |

### Baby Lane Bone Forceps

(Not shown)

| Cat. No. | Size  |
|----------|-------|
| 28-2772  | 140mm |

### Femoral Reamer

(Not shown)

| Cat. No.  |
|-----------|
| 7123-7100 |

### Genesis Femoral File

(Not shown)

| Cat. No. |
|----------|
| 11-4894  |

### GII Quick Connect Handles/Alignment Tower

(Not shown)

| Cat. No.  |
|-----------|
| 7144-0044 |

### Large Outer Case, 4.8"

(Not shown)

| Cat. No.  |
|-----------|
| 7112-9400 |

### Lid for OuterCases

(Not shown)

| Cat. No.  |
|-----------|
| 7112-9402 |

### Onlay & Inlay Instrument Set

(Not shown)

| Cat. No.  |
|-----------|
| 7123-6000 |

### Oxinium UniCompartmental Femoral Final Trial

(Not shown)

| Cat. No.  | Size    |
|-----------|---------|
| 7121-5030 | X-Small |
| 7121-5031 | Small   |



# Reconstructive Surgery

## Knee Systems

### Oxinium UniCompartmental Femoral Final Trial

| Cat. No.  | Size        |
|-----------|-------------|
| 7121-5032 | Medium      |
| 7121-5033 | Large       |
| 7121-5034 | X-Large     |
| 7121-5035 | Magnum      |
| 7121-5036 | Magnum Plus |

### Oxinium UniCompartmental Femoral Finishing Trial

(Not shown)

| Cat. No.  | Size        |
|-----------|-------------|
| 7121-5042 | X-Small     |
| 7121-5043 | Small       |
| 7121-5044 | Medium      |
| 7121-5045 | Large       |
| 7121-5046 | X-Large     |
| 7121-5047 | Magnum      |
| 7121-5048 | Magnum Plus |

### Oxinium UniCompartmental Femoral Lug Drill

(Not shown)

| Cat. No.  |
|-----------|
| 7121-5041 |

### Oxinium UniCompartmental Femoral Trial Lug

(Not shown)

| Cat. No.  |
|-----------|
| 7121-5040 |

### Oxinium UniCompartmental Instruments Set

(Not shown)

| Cat. No.  |
|-----------|
| 7121-5000 |

### Small Outer Case, 2.4"

(Not shown)

| Cat. No.  |
|-----------|
| 7112-9401 |

### Universal Pin Puller

(Not shown)

| Cat. No.  |
|-----------|
| 7144-0488 |

### Accuris Uni Knee System/All-Polyethylene Onlay Tibial Implants

### Accuris Asymetric All-Polyethylene Onlay Implant Set

(Not shown)

| Cat. No. |
|----------|
| 71236400 |

### Genesis All-Polyethylene Onlay Implants

(Not shown)

| Cat. No.  | Desc        | Size    | Qty |
|-----------|-------------|---------|-----|
| 7124-3108 | LM/RL 8     | X-Small | 2   |
| 7124-3109 | LM/RL 9     | X-Small | 2   |
| 7124-3110 | LM/RL 10    | X-Small | 2   |
| 7124-3112 | LM/RL 12    | X-Small | 2   |
| 7124-3115 | LM/RL 15MM  | X-Small | 2   |
| 7124-3118 | RM/LL 8     | X-Small | 2   |
| 7124-3119 | RM/LL 9     | X-Small | 2   |
| 7124-3120 | LM/RL 10    | X-Small | 2   |
| 7124-3122 | LM/RL 12    | X-Small | 2   |
| 3124-3125 | RM/LL 15    | X-Small | 2   |
| 7124-3209 | LM/RL 9     | Small   | 2   |
| 7124-3009 | RM/LL 9M    | Small   | 2   |
| 7124-3308 | LM/RL 8     | Medium  | 2   |
| 7124-3309 | LM/RL 9     | Medium  | 2   |
| 7124-3310 | LM/RL 10    | Medium  | 2   |
| 7124-3315 | LM/RL 15MM  | Medium  | 2   |
| 7124-3318 | RM/LL 8     | Medium  | 2   |
| 7124-3319 | RM/LL 9 MM  | Medium  | 2   |
| 7124-3320 | RM/LL 10    | Medium  | 2   |
| 7124-3322 | RM/LL12     | Medium  | 2   |
| 7124-3325 | RM/LL 15MM  | Medium  | 2   |
| 7124-3408 | LM/RL 8     | Large   | 2   |
| 7124-3409 | LM/RL 9     | Large   | 2   |
| 7124-3410 | LM/RL 10    | Large   | 2   |
| 7124-3412 | LM/RL12     | Large   | 2   |
| 7124-3415 | LM/RL 15 MM | Large   | 2   |
| 7124-3418 | LM/RL 8     | Large   | 2   |
| 7124-4509 | RM/LL 9M    | Large   | 2   |
| 7124-3420 | RM/LL 10    | Large   | 2   |

## Genesis All-Polyethylene Onlay Implants

| Cat. No.  | Desc       | Size    | Qty |
|-----------|------------|---------|-----|
| 7124-3422 | RM/LL 12   | Large   | 2   |
| 7124-4515 | RM/LL 15M  | Large   | 2   |
| 7124-3508 | LM/RL 8    | X-Large | 2   |
| 7124-3509 | LM/RL 9MM  | X-Large | 2   |
| 7124-3510 | LM/RL 10   | X-Large | 2   |
| 7124-3512 | LM/RL 12   | X-Large | 2   |
| 7124-3515 | LM/RL 15MM | X-Large | 2   |
| 7124-3518 | RM/LL 8    | X-Large | 2   |
| 7124-3519 | RM/LL 9MM  | X-Large | 2   |
| 7124-3520 | RM/LL 10   | X-Large | 2   |
| 7124-3522 | RM/LL 12   | X-Large | 2   |
| 7124-3525 | RM/LL 15MM | X-Large | 2   |
| 7124-3608 | LM/RL 8    | Magnum  | 2   |
| 7124-3609 | LM/RL 9MM  | Magnum  | 2   |
| 7124-3610 | LM/RL 10   | Magnum  | 2   |
| 7124-3618 | RM/LL 8    | Magnum  | 2   |

# Reconstructive Surgery

## Hip Systems

### Hip Systems

#### Femoral Options/Synergy Primary Hip System/Implants

##### Porous Plus HA



| Standard Cat. No. | High Offset Cat. No. | Size | Length |
|-------------------|----------------------|------|--------|
| 7130-9009         | 7130-9109            | 9    | 135mm  |
| 7130-9010         | 7130-9110            | 10   | 140mm  |
| 7130-9011         | 7130-9111            | 11   | 145mm  |
| 7130-9012         | 7130-9112            | 12   | 150mm  |
| 7130-9013         | 7130-9113            | 13   | 155mm  |
| 7130-9014         | 7130-9114            | 14   | 160mm  |
| 7130-9015         | 7130-9115            | 15   | 165mm  |
| 7130-9016         | 7130-9116            | 16   | 170mm  |
| 7130-9017         | 7130-9117            | 17   | 175mm  |
| 7130-9018         | 7130-9118            | 18   | 180mm  |

#### Synergy Cemented Stems

Forged CoCr



| Standard Cat. # | High Offset Cat. # | Size | Length |
|-----------------|--------------------|------|--------|
| 7131-6009       | 7131-6209          | 9    | 110mm  |
| 7131-6010       | 7131-6210          | 10   | 115mm  |
| 7131-6011       | 7131-6211          | 11   | 120mm  |
| 7131-6012       | 7131-6212          | 12   | 125mm  |

#### Synergy Cemented Stems

Forged CoCr

| Standard Cat. # | High Offset Cat. # | Size | Length |
|-----------------|--------------------|------|--------|
| 7131-6013       | 7131-6213          | 13   | 130mm  |
| 7131-6014       | 7131-6214          | 14   | 135mm  |
| 7131-6015       | 7131-6215          | 15   | 140mm  |
| 7131-6016       | 7131-6216          | 16   | 140mm  |
| 7131-6017       | 7131-6217          | 17   | 140mm  |

#### Synergy HA-Coated Press-Fit Stems

Titanium 6Al-4V



| Standard Cat. # | High Offset Cat. # | Size | Length |
|-----------------|--------------------|------|--------|
| 7130-6709       | 7130-6409          | 9    | 135mm  |
| 7130-6710       | 7130-6410          | 10   | 140mm  |
| 7130-6711       | 7130-6411          | 11   | 145mm  |
| 7130-6712       | 7130-6412          | 12   | 150mm  |
| 7130-6713       | 7130-6413          | 13   | 155mm  |
| 7130-6714       | 7130-6414          | 14   | 160mm  |
| 7130-6715       | 7130-6415          | 15   | 165mm  |
| 7130-6716       | 7130-6416          | 16   | 170mm  |
| 7130-6717       | 7130-6417          | 17   | 175mm  |
| 7130-6718       | 7130-6418          | 18   | 180mm  |

#### Synergy Porous-Coated Stems

Titanium 6Al-4V



| Standard Cat. # | High Offset Cat. # | Size | Length |
|-----------------|--------------------|------|--------|
| 7130-6608       | -                  | 8*   | 120mm  |

## Synergy Porous-Coated Stems

Titanium 6Al-4V

| Standard Cat. # | High Offset Cat. # | Size | Length |
|-----------------|--------------------|------|--------|
| 7130-6609       | 7130-6109          | 9    | 135mm  |
| 7130-6610       | 7130-6110          | 10   | 140mm  |
| 7130-6611       | 7130-6111          | 11   | 145mm  |
| 7130-6612       | 7130-6112          | 12   | 150mm  |
| 7130-6613       | 7130-6113          | 13   | 155mm  |
| 7130-6614       | 7130-6114          | 14   | 160mm  |
| 7130-6615       | 7130-6115          | 15   | 165mm  |
| 7130-6616       | 7130-6116          | 16   | 170mm  |
| 7130-6617       | 7130-6117          | 17   | 175mm  |
| 7130-6618       | 7130-6118          | 18   | 180mm  |
| 7192-6107       | -                  | 19*  | 185mm  |
| 7192-6108       | -                  | 20*  | 190mm  |

\* Available by special request

## Synergy Titanium Press-Fit Stems

Titanium 6Al-4V

| Cat. No.  | Size | Length |
|-----------|------|--------|
| 7130-6809 | 9    | 135mm  |
| 7130-6810 | 10   | 140mm  |
| 7130-6811 | 11   | 145mm  |
| 7130-6812 | 12   | 150mm  |
| 7130-6813 | 13   | 155mm  |
| 7130-6814 | 14   | 160mm  |
| 7130-6815 | 15   | 165mm  |
| 7130-6816 | 16   | 170mm  |
| 7130-6817 | 17   | 175mm  |
| 7130-6818 | 18   | 180mm  |



## Femoral Options/Synergy Primary Hip System/Heads

## Alumina 12/14 Taper Femoral Heads

| Cat. No.  | Size | Length (mm) |
|-----------|------|-------------|
| 7133-2800 | +0   | 28mm        |
| 7133-2804 | +4   | 28mm        |
| 7133-2808 | +8   | 28mm        |
| 7133-3200 | +0   | 32mm        |
| 7133-3204 | +4   | 32mm        |
| 7133-3208 | +8   | 32mm        |
| 7133-3600 | +0   | 36mm        |
| 7133-3604 | +4   | 36mm        |
| 7133-3608 | +8   | 36mm        |



## CoCr 12/14 Femoral Heads

Cobalt Chromium- ASTM F 799

| Cat. No.  | Size | Neck Length |
|-----------|------|-------------|
| 7130-2200 | 22mm | +0          |
| 7130-2204 | 22mm | +4          |
| 7130-2208 | 22mm | +8          |
| 7130-2212 | 22mm | +12         |
| 7130-2600 | 26mm | +0          |
| 7130-2604 | 26mm | +4          |
| 7130-2608 | 26mm | +8          |
| 7130-2612 | 26mm | +12         |
| 7130-2803 | 28mm | -3          |
| 7130-2800 | 28mm | +0          |
| 7130-2804 | 28mm | +4          |
| 7130-2808 | 28mm | +8          |
| 7130-2812 | 28mm | +12         |
| 7130-2816 | 28mm | +16         |
| 7130-3203 | 32mm | -3          |
| 7130-3200 | 32mm | +0          |
| 7130-3204 | 32mm | +4          |
| 7130-3208 | 32mm | +8          |
| 7130-3212 | 32mm | +12         |
| 7130-3216 | 32mm | +16         |
| 7130-3603 | 36mm | -3          |
| 7130-3600 | 36mm | +0          |
| 7130-3604 | 36mm | +4          |
| 7130-3608 | 36mm | +8          |
| 7130-3612 | 36mm | +12         |



### Oxinium 12/14 Taper Femoral Heads

| Cat. No.  | Size | Neck Length |
|-----------|------|-------------|
| 7134-2200 | 22mm | +0          |
| 7134-2204 | 22mm | +4          |
| 7134-2208 | 22mm | +8          |
| 7134-2600 | 26mm | +0          |
| 7134-2604 | 26mm | +4          |
| 7134-2608 | 26mm | +8          |
| 7134-2803 | 28mm | -3          |
| 7134-2800 | 28mm | +0          |
| 7134-2804 | 28mm | +4          |
| 7134-2808 | 28mm | +8          |
| 7134-2812 | 28mm | +12         |
| 7134-2816 | 28mm | +16         |
| 7134-3203 | 32mm | -3          |
| 7134-3200 | 32mm | +0          |
| 7134-3204 | 32mm | +4          |
| 7134-3208 | 32mm | +8          |
| 7134-3212 | 32mm | +12         |
| 7134-3216 | 32mm | +16         |
| 7134-3603 | 36mm | -3          |
| 7134-3600 | 36mm | +0          |
| 7134-3604 | 36mm | +4          |
| 7134-3608 | 36mm | +8          |
| 7134-3612 | 36mm | +12         |



### Trial 12/14 Taper Femoral Heads

| Cat. No.  | Size | Neck Length | Color Code |
|-----------|------|-------------|------------|
| 7135-2608 | 26mm | +8          | White      |
| 7135-2612 | 26mm | +12         | Blue       |
| 7135-2803 | 28mm | -3          | Green      |
| 7135-2800 | 28mm | +0          | Yellow     |
| 7135-2804 | 28mm | +4          | Red        |
| 7135-2808 | 28mm | +8          | White      |
| 7135-2812 | 28mm | +12         | Blue       |
| 7135-2816 | 28mm | +16         | Black      |
| 7135-3203 | 32mm | -3          | Green      |
| 7135-3200 | 32mm | +0          | Yellow     |
| 7135-3204 | 32mm | +4          | Red        |
| 7135-3208 | 32mm | +8          | White      |
| 7135-3212 | 32mm | +12         | Blue       |
| 7135-3216 | 32mm | +16         | Black      |
| 7135-3603 | 36mm | -3          | Green      |
| 7135-3600 | 36mm | +0          | Yellow     |
| 7135-3604 | 36mm | +4          | Red        |
| 7135-3608 | 36mm | +8          | White      |
| 7135-3612 | 36mm | +12         | Blue       |

### Femoral Options/Synergy Primary Hip System/Distal Centralizers

### Trial 12/14 Taper Femoral Heads



| Cat. No.  | Size | Neck Length | Color Code |
|-----------|------|-------------|------------|
| 7135-2200 | 22mm | +0          | Yellow     |
| 7135-2204 | 22mm | +4          | Red        |
| 7135-2208 | 22mm | +8          | White      |
| 7135-2212 | 22mm | +12         | Blue       |
| 7135-2600 | 26mm | +0          | Yellow     |
| 7135-2604 | 26mm | +4          | Red        |

### Invis Distal Centralizers

| Cat. No.  | O.D. |
|-----------|------|
| 7131-3208 | 8mm  |
| 7131-3209 | 9mm  |
| 7131-3210 | 10mm |
| 7131-3211 | 11mm |
| 7131-3212 | 12mm |
| 7131-3213 | 13mm |
| 7131-3214 | 14mm |
| 7131-3215 | 15mm |
| 7131-3216 | 16mm |
| 7131-3218 | 17mm |
| 7131-3218 | 18mm |
| 7131-3219 | 19mm |



### Femoral Options/Synergy Primary Hip System/Femoral Instrumentation Tray No. 1

## Anteversio Handle

| Cat. No.  |
|-----------|
| 7136-4012 |



## Box Osteotome

| Cat. No.  | Size  |
|-----------|-------|
| 7136-4002 | Small |
| 7136-4003 | Large |



## Broach Handle

| Cat. No.  |
|-----------|
| 7136-4007 |



Two per set

## Canal Finder

| Cat. No.  |
|-----------|
| 7136-4001 |



## Femoral Instrumentation Tray No. 1



| Cat. No.  |
|-----------|
| 7136-6201 |

## Osteotomy Guide

| Cat. No.  |
|-----------|
| 7136-4000 |



## Tapered Reamer

| Cat. No.  | Size   |
|-----------|--------|
| 7136-6209 | 8-9-10 |
| 7136-6211 | 11-12  |
| 7136-6213 | 13-14  |
| 7136-6215 | 15-16  |
| 7136-6217 | 17-18  |



## T-Handle

| Cat. No.  |
|-----------|
| 7136-4006 |



## Femoral Options/Synergy Primary Hip System/Femoral Instrumentation Tray No. 2

### Calcar Reamer

| Cat. No.  | Size  |
|-----------|-------|
| 7136-4004 | Small |



### Femoral Head Impactor

| Cat. No.  |
|-----------|
| 7136-4009 |



## Femoral Instrumentation Tray No. 2

| Cat. No.  |
|-----------|
| 7136-6203 |



# Reconstructive Surgery

## Hip Systems

### Fully Toothed Broach

| Cat. No.  | Size |
|-----------|------|
| 7136-6708 | 8    |
| 7136-6709 | 9    |
| 7136-6710 | 10   |
| 7136-6711 | 11   |
| 7136-6712 | 12   |
| 7136-6713 | 13   |
| 7136-6714 | 14   |
| 7136-6715 | 15   |
| 7136-6716 | 16   |
| 7136-6717 | 17   |
| 7136-6718 | 18   |



### System/Collared Trial Neck Sterilization Tray

#### Collared Trial Neck Sterilization Tray

| Cat. No.  |
|-----------|
| 7136-6204 |



### Slap Hammer Weight

| Cat. No.  |
|-----------|
| 7136-4010 |

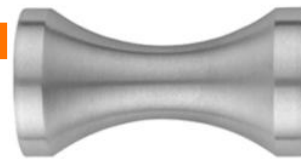

### Collared Trial Neck, High Offset

| Cat. No.  | Size  |
|-----------|-------|
| 7136-6918 | 8-9   |
| 7136-6920 | 10-11 |
| 7136-6922 | 12-13 |
| 7136-6924 | 14-15 |
| 7136-6926 | 16-17 |



### Stem Inserter Frame

| Cat. No.  |
|-----------|
| 7136-4008 |



### Collared Trial Neck, Standard Offset

| Cat. No.  | Size  |
|-----------|-------|
| 7136-6908 | 8-9   |
| 7136-6910 | 10-11 |
| 7136-6912 | 12-13 |
| 7136-6914 | 14-15 |
| 7136-6916 | 16-17 |



### Stem Inserter Pommel

| Cat. No.  |
|-----------|
| 7136-4011 |



### Trial Neck

| Cat. No.  | Size  | Desc            |
|-----------|-------|-----------------|
| 7136-6408 | 8-13  | Standard Offset |
| 7136-6414 | 14-18 | Standard Offset |
| 7136-6508 | 8-13  | High Offset     |
| 7136-6514 | 14-18 | High Offset     |



### Femoral Options/Conquest Fx/Implants

#### Conquest FX Stems

CoCr

| Standard Cat. # | Size | Length |
|-----------------|------|--------|
| 7131-6509       | 9    | 125mm  |
| 7131-6510       | 10   | 130mm  |
| 7131-6511       | 11   | 135mm  |
| 7131-6512       | 12   | 140mm  |
| 7131-6513       | 13   | 145mm  |
| 7131-6514       | 14   | 150mm  |



### Femoral Options/Synergy Primary Hip

## Conquest FX Stems

CoCr

| Standard Cat. # | Size | Length |
|-----------------|------|--------|
| 7131-6515       | 15   | 150mm  |
| 7131-6516       | 16   | 150mm  |
| 7131-6517       | 17   | 150mm  |
| 7131-6518       | 18   | 150mm  |

## CoCr 12/14 Femoral Heads

Cobalt Chromium- ASTM F 799

| Cat. No.  | Size | Neck Length |
|-----------|------|-------------|
| 7130-3208 | 32mm | +8          |
| 7130-3212 | 32mm | +12         |
| 7130-3216 | 32mm | +16         |
| 7130-3603 | 36mm | -3          |
| 7130-3600 | 36mm | +0          |
| 7130-3604 | 36mm | +4          |
| 7130-3608 | 36mm | +8          |
| 7130-3612 | 36mm | +12         |

## Femoral Options/Conquest Fx/Heads

### Alumina 12/14 Taper Femoral Heads

| Cat. No.  | Size | Length (mm) |
|-----------|------|-------------|
| 7133-2800 | +0   | 28mm        |
| 7133-2804 | +4   | 28mm        |
| 7133-2808 | +8   | 28mm        |
| 7133-3200 | +0   | 32mm        |
| 7133-3204 | +4   | 32mm        |
| 7133-3208 | +8   | 32mm        |
| 7133-3600 | +0   | 36mm        |
| 7133-3604 | +4   | 36mm        |
| 7133-3608 | +8   | 36mm        |



### Oxinium 12/14 Taper Femoral Heads

| Cat. No.  | Size | Neck Length |
|-----------|------|-------------|
| 7134-2200 | 22mm | +0          |
| 7134-2204 | 22mm | +4          |
| 7134-2208 | 22mm | +8          |
| 7134-2600 | 26mm | +0          |
| 7134-2604 | 26mm | +4          |
| 7134-2608 | 26mm | +8          |
| 7134-2803 | 28mm | -3          |
| 7134-2800 | 28mm | +0          |
| 7134-2804 | 28mm | +4          |
| 7134-2808 | 28mm | +8          |
| 7134-2812 | 28mm | +12         |
| 7134-2816 | 28mm | +16         |
| 7134-3203 | 32mm | -3          |
| 7134-3200 | 32mm | +0          |
| 7134-3204 | 32mm | +4          |
| 7134-3208 | 32mm | +8          |
| 7134-3212 | 32mm | +12         |
| 7134-3216 | 32mm | +16         |
| 7134-3603 | 36mm | -3          |
| 7134-3600 | 36mm | +0          |
| 7134-3604 | 36mm | +4          |
| 7134-3608 | 36mm | +8          |
| 7134-3612 | 36mm | +12         |



## CoCr 12/14 Femoral Heads

Cobalt Chromium- ASTM F 799

| Cat. No.  | Size | Neck Length |
|-----------|------|-------------|
| 7130-2200 | 22mm | +0          |
| 7130-2204 | 22mm | +4          |
| 7130-2208 | 22mm | +8          |
| 7130-2212 | 22mm | +12         |
| 7130-2600 | 26mm | +0          |
| 7130-2604 | 26mm | +4          |
| 7130-2608 | 26mm | +8          |
| 7130-2612 | 26mm | +12         |
| 7130-2803 | 28mm | -3          |
| 7130-2800 | 28mm | +0          |
| 7130-2804 | 28mm | +4          |
| 7130-2808 | 28mm | +8          |
| 7130-2812 | 28mm | +12         |
| 7130-2816 | 28mm | +16         |
| 7130-3203 | 32mm | -3          |
| 7130-3200 | 32mm | +0          |
| 7130-3204 | 32mm | +4          |





### Trial 12/14 Taper Femoral Heads



| Cat. No.  | Size | Neck Length | Color Code |
|-----------|------|-------------|------------|
| 7135-2200 | 22mm | +0          | Yellow     |
| 7135-2204 | 22mm | +4          | Red        |
| 7135-2208 | 22mm | +8          | White      |
| 7135-2212 | 22mm | +12         | Blue       |
| 7135-2600 | 26mm | +0          | Yellow     |
| 7135-2604 | 26mm | +4          | Red        |
| 7135-2608 | 26mm | +8          | White      |
| 7135-2612 | 26mm | +12         | Blue       |
| 7135-2803 | 28mm | -3          | Green      |
| 7135-2800 | 28mm | +0          | Yellow     |
| 7135-2804 | 28mm | +4          | Red        |
| 7135-2808 | 28mm | +8          | White      |
| 7135-2812 | 28mm | +12         | Blue       |
| 7135-2816 | 28mm | +16         | Black      |
| 7135-3203 | 32mm | -3          | Green      |
| 7135-3200 | 32mm | +0          | Yellow     |
| 7135-3204 | 32mm | +4          | Red        |
| 7135-3208 | 32mm | +8          | White      |
| 7135-3212 | 32mm | +12         | Blue       |
| 7135-3216 | 32mm | +16         | Black      |
| 7135-3603 | 36mm | -3          | Green      |
| 7135-3600 | 36mm | +0          | Yellow     |
| 7135-3604 | 36mm | +4          | Red        |
| 7135-3608 | 36mm | +8          | White      |
| 7135-3612 | 36mm | +12         | Blue       |

### Femoral Options/Conquest Fx/Distal Centralizers

### Invis Distal Centralizers

| Cat. No.  | O.D. |
|-----------|------|
| 7131-3208 | 8mm  |
| 7131-3209 | 9mm  |
| 7131-3210 | 10mm |
| 7131-3211 | 11mm |
| 7131-3212 | 12mm |
| 7131-3213 | 13mm |
| 7131-3214 | 14mm |
| 7131-3215 | 15mm |
| 7131-3216 | 16mm |
| 7131-3218 | 17mm |
| 7131-3218 | 18mm |
| 7131-3219 | 19mm |



### Femoral Options/Conquest Fx/Femoral Instrumentation Tray No. 1

#### Anteverson Handle

| Cat. No.  |
|-----------|
| 7136-4012 |



#### Box Osteotome

| Cat. No.  | Size  |
|-----------|-------|
| 7136-4002 | Small |
| 7136-4003 | Large |



#### Broach Handle

| Cat. No.  |
|-----------|
| 7136-4007 |



Two per set

#### Canal Finder

| Cat. No.  |
|-----------|
| 7136-4001 |



## Femoral Instrumentation Tray No. 1



Cat. No. [Redacted]  
7136-6201

## Osteotomy Guide

Cat. No. [Redacted]  
7136-4000



## Tapered Reamer

| Cat. No.  | Size   |
|-----------|--------|
| 7136-6209 | 8-9-10 |
| 7136-6211 | 11-12  |
| 7136-6213 | 13-14  |
| 7136-6215 | 15-16  |
| 7136-6217 | 17-18  |



## T-Handle

Cat. No. [Redacted]  
7136-4006



## Femoral Options/Conquest Fx/Femoral Instrumentation Tray No. 2

## Calcar Reamer

| Cat. No.  | Size  |
|-----------|-------|
| 7136-4004 | Small |



## Femoral Head Impactor

Cat. No. [Redacted]  
7136-4009



## Femoral Instrumentation Tray No. 2

Cat. No. [Redacted]  
7136-6203



## Fully Toothed Broach

| Cat. No.  | Size |
|-----------|------|
| 7136-6708 | 8    |
| 7136-6709 | 9    |
| 7136-6710 | 10   |
| 7136-6711 | 11   |
| 7136-6712 | 12   |
| 7136-6713 | 13   |
| 7136-6714 | 14   |
| 7136-6715 | 15   |
| 7136-6716 | 16   |
| 7136-6717 | 17   |
| 7136-6718 | 18   |



## Slap Hammer Weight

Cat. No. [Redacted]  
7136-4010



## Stem Inserter Frame

Cat. No. [Redacted]  
7136-4008



# Reconstructive Surgery

## Hip Systems

### Stem Inserter Pommel

Cat. No.

7136-4011



### Trial Neck

Cat. No. Size Desc

|           |       |                 |
|-----------|-------|-----------------|
| 7136-6408 | 8-13  | Standard Offset |
| 7136-6414 | 14-18 | Standard Offset |
| 7136-6508 | 8-13  | High Offset     |
| 7136-6514 | 14-18 | High Offset     |



### Femoral Options/Echelon Primary Hip System/Implants

#### Femoral Implants; High Offset

Cat. No. Size

|           |    |
|-----------|----|
| 7134-1022 | 12 |
| 7134-1023 | 13 |
| 7134-1024 | 14 |
| 7134-1025 | 15 |
| 7134-1026 | 16 |
| 7134-1027 | 17 |
| 7134-1028 | 18 |
| 7134-1029 | 19 |



#### Femoral Implants; Standard Offset

Cat. No. Size

|           |    |
|-----------|----|
| 7134-1011 | 11 |
| 7134-1012 | 12 |
| 7134-1013 | 13 |
| 7134-1014 | 14 |
| 7134-1015 | 15 |
| 7135-1016 | 16 |
| 7134-1017 | 17 |
| 7134-1018 | 18 |
| 7134-1019 | 19 |



### Femoral Options/Echelon Primary Hip System/Heads

#### Alumina 12/14 Taper Femoral Heads

Cat. No. Size Length (mm)

|           |    |      |
|-----------|----|------|
| 7133-2800 | +0 | 28mm |
| 7133-2804 | +4 | 28mm |
| 7133-2808 | +8 | 28mm |
| 7133-3200 | +0 | 32mm |
| 7133-3204 | +4 | 32mm |
| 7133-3208 | +8 | 32mm |
| 7133-3600 | +0 | 36mm |
| 7133-3604 | +4 | 36mm |
| 7133-3608 | +8 | 36mm |



#### CoCr 12/14 Femoral Heads

Cobalt Chromium- ASTM F 799

Cat. No. Size Neck Length

|           |      |     |
|-----------|------|-----|
| 7130-2200 | 22mm | +0  |
| 7130-2204 | 22mm | +4  |
| 7130-2208 | 22mm | +8  |
| 7130-2212 | 22mm | +12 |
| 7130-2600 | 26mm | +0  |
| 7130-2604 | 26mm | +4  |
| 7130-2608 | 26mm | +8  |
| 7130-2612 | 26mm | +12 |
| 7130-2803 | 28mm | -3  |
| 7130-2800 | 28mm | +0  |
| 7130-2804 | 28mm | +4  |
| 7130-2808 | 28mm | +8  |
| 7130-2812 | 28mm | +12 |
| 7130-2816 | 28mm | +16 |
| 7130-3203 | 32mm | -3  |
| 7130-3200 | 32mm | +0  |
| 7130-3204 | 32mm | +4  |
| 7130-3208 | 32mm | +8  |
| 7130-3212 | 32mm | +12 |
| 7130-3216 | 32mm | +16 |
| 7130-3603 | 36mm | -3  |
| 7130-3600 | 36mm | +0  |
| 7130-3604 | 36mm | +4  |
| 7130-3608 | 36mm | +8  |
| 7130-3612 | 36mm | +12 |



## Oxinium 12/14 Taper Femoral Heads

| Cat. No.  | Size | Neck Length |
|-----------|------|-------------|
| 7134-2200 | 22mm | +0          |
| 7134-2204 | 22mm | +4          |
| 7134-2208 | 22mm | +8          |
| 7134-2600 | 26mm | +0          |
| 7134-2604 | 26mm | +4          |
| 7134-2608 | 26mm | +8          |
| 7134-2803 | 28mm | -3          |
| 7134-2800 | 28mm | +0          |
| 7134-2804 | 28mm | +4          |
| 7134-2808 | 28mm | +8          |
| 7134-2812 | 28mm | +12         |
| 7134-2816 | 28mm | +16         |
| 7134-3203 | 32mm | -3          |
| 7134-3200 | 32mm | +0          |
| 7134-3204 | 32mm | +4          |
| 7134-3208 | 32mm | +8          |
| 7134-3212 | 32mm | +12         |
| 7134-3216 | 32mm | +16         |
| 7134-3603 | 36mm | -3          |
| 7134-3600 | 36mm | +0          |
| 7134-3604 | 36mm | +4          |
| 7134-3608 | 36mm | +8          |
| 7134-3612 | 36mm | +12         |



## Trial 12/14 Taper Femoral Heads

| Cat. No.  | Size | Neck Length | Color Code |
|-----------|------|-------------|------------|
| 7135-2608 | 26mm | +8          | White      |
| 7135-2612 | 26mm | +12         | Blue       |
| 7135-2803 | 28mm | -3          | Green      |
| 7135-2800 | 28mm | +0          | Yellow     |
| 7135-2804 | 28mm | +4          | Red        |
| 7135-2808 | 28mm | +8          | White      |
| 7135-2812 | 28mm | +12         | Blue       |
| 7135-2816 | 28mm | +16         | Black      |
| 7135-3203 | 32mm | -3          | Green      |
| 7135-3200 | 32mm | +0          | Yellow     |
| 7135-3204 | 32mm | +4          | Red        |
| 7135-3208 | 32mm | +8          | White      |
| 7135-3212 | 32mm | +12         | Blue       |
| 7135-3216 | 32mm | +16         | Black      |
| 7135-3603 | 36mm | -3          | Green      |
| 7135-3600 | 36mm | +0          | Yellow     |
| 7135-3604 | 36mm | +4          | Red        |
| 7135-3608 | 36mm | +8          | White      |
| 7135-3612 | 36mm | +12         | Blue       |

## Femoral Options/Echelon Primary Hip System/Echelon Starter Tray

## Trial 12/14 Taper Femoral Heads



| Cat. No.  | Size | Neck Length | Color Code |
|-----------|------|-------------|------------|
| 7135-2200 | 22mm | +0          | Yellow     |
| 7135-2204 | 22mm | +4          | Red        |
| 7135-2208 | 22mm | +8          | White      |
| 7135-2212 | 22mm | +12         | Blue       |
| 7135-2600 | 26mm | +0          | Yellow     |
| 7135-2604 | 26mm | +4          | Red        |

## Anteverson Handle (2 per set)

| Cat. No.  |
|-----------|
| 7136-4012 |



## Box Osteotome

| Cat. No.  |
|-----------|
| 7136-4002 |



Broach Handle  
(2 per set)

Cat. No.  
7136-4007



T-Handle

Cat. No.  
7136-4006



Echelon Starter Tray

Cat. No.  
7136-6001

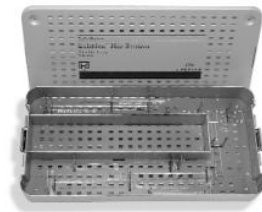

Femoral Options/Echelon Primary Hip System/Echelon Reamer Tray

Femoral Canal Finder

Cat. No.  
7136-4001



Echelon Reamer Tray

Cat. No.  
7136-6002



Osteotomy Guide

Cat. No.  
7136-4000



Proximal Reamer

Cat. No.  
7136-4015



Rigid Reamer

Cat. No. Size

|           |         |
|-----------|---------|
| 7135-0090 | 9 mm    |
| 7135-0095 | 9.5 mm  |
| 7135-0100 | 10 mm   |
| 7135-0105 | 10.5 mm |
| 7135-0110 | 11 mm   |
| 7135-0115 | 11.5 mm |
| 7135-0120 | 12 mm   |
| 7135-0125 | 12.5 mm |
| 7135-0130 | 13 mm   |
| 7135-0135 | 13.5 mm |
| 7135-0140 | 14 mm   |
| 7135-0145 | 14.5 mm |
| 7135-0150 | 15 mm   |
| 7135-0155 | 15.5 mm |
| 7135-0160 | 16 mm   |
| 7135-0165 | 16.5 mm |
| 7135-0170 | 17 mm   |



## Rigid Reamer

| Cat. No.  | Size    |
|-----------|---------|
| 7135-0175 | 17.5 mm |
| 7135-0180 | 18 mm   |
| 7135-0185 | 18.5 mm |
| 7135-0190 | 19 mm   |
| 7135-0195 | 19.5 mm |
| 7135-0200 | 20 mm   |

## Femoral Options/Echelon Primary Hip System/Broach Tray

### Broach

| Cat. No.  | Size |
|-----------|------|
| 7136-7010 | 10   |
| 7136-7011 | 11   |
| 7136-7012 | 12   |
| 7136-7013 | 13   |
| 7136-7014 | 14   |
| 7136-7015 | 15   |
| 7136-7016 | 16   |
| 7136-7017 | 17   |
| 7136-7018 | 18   |
| 7136-7019 | 19   |
| 7136-7020 | 20   |



### Broach Tray

| Cat. No.  |
|-----------|
| 7136-6003 |



### Calcar Reamer

| Cat. No.  | Size  |
|-----------|-------|
| 7136-4004 | Small |
| 7136-4005 | Large |



## Femoral Head Impactor

| Cat. No.  |
|-----------|
| 7136-4009 |



## Stem Inserter Frame

| Cat. No.  |
|-----------|
| 7136-4008 |



## Stem Inserter Pommel

| Cat. No.  |
|-----------|
| 7136-4011 |



## Trial Neck; High Offset Echelon Primary

| Cat. No.  | Size  |
|-----------|-------|
| 7136-7221 | 11-12 |
| 7136-7222 | 13-14 |
| 7136-7223 | 15-17 |
| 7136-7224 | 18-19 |



## Trial Neck; Standard Offset Echelon Primary

| Cat. No.  | Size  |
|-----------|-------|
| 7136-7201 | 11-12 |
| 7136-7202 | 13-14 |
| 7136-7203 | 15-17 |
| 7136-7204 | 18-19 |



## Femoral Options/Echelon Revision Hip System/Implants

# Reconstructive Surgery

## Hip Systems

### Cemented Implants; +15mm Calcar

| Cat. No.  | Size | Length (mm) |
|-----------|------|-------------|
| 7131-0312 | 12   | 175         |
| 7131-0412 | 12   | 225         |
| 7131-0314 | 14   | 175         |
| 7131-0414 | 14   | 225         |
| 7131-0316 | 16   | 175         |
| 7131-0416 | 16   | 225         |



### Extensively Coated Porous Straight Implants (190mm); +15mm Calcar

| Cat. No.  | Size |
|-----------|------|
| 7134-0211 | 11   |
| 7134-0212 | 12   |
| 7134-0213 | 13   |
| 7134-0214 | 14   |
| 7134-0215 | 15   |
| 7134-0216 | 16   |
| 7134-0217 | 17   |
| 7134-0218 | 18   |
| 7134-0219 | 19   |
| 7134-0220 | 20   |



### Cemented Implants; +30mm Calcar

| Cat. No.  | Size | Length (mm) |
|-----------|------|-------------|
| 7131-0612 | 12   | 175         |
| 7131-0712 | 12   | 225         |
| 7131-0614 | 14   | 175         |
| 7131-0714 | 14   | 225         |
| 7131-0616 | 16   | 175         |
| 7131-0716 | 16   | 225         |



### Extensively Coated Porous Straight Implants (190mm); Standard

| Cat. No.  | Size |
|-----------|------|
| 7134-0111 | 11   |
| 7134-0112 | 12   |
| 7134-0113 | 13   |
| 7134-0114 | 14   |
| 7134-0115 | 15   |
| 7134-0116 | 16   |
| 7134-0117 | 17   |
| 7134-0118 | 18   |
| 7134-0119 | 19   |
| 7134-0120 | 20   |



### Cemented Implants; Standard Collar

| Cat. No.  | Size  | Length (mm) |
|-----------|-------|-------------|
| 7131-0112 | 12    | 175         |
| 7131-0212 | 12    | 225         |
| 7131-0114 | 14    | 175         |
| 7131-0214 | 14    | 225         |
| 7131-0116 | 16    | 175         |
| 7131-0216 | 16    | 225         |
| 7131-4112 | 12L * | 300         |
| 7131-4114 | 14L * | 300         |
| 7131-5112 | 12R * | 300         |
| 7131-5114 | 14R * | 300         |



### Porous Bowed Implants (260mm); +15mm Calcar

| Cat. No.  | Size |
|-----------|------|
| 7134-0612 | 12L  |
| 7134-0613 | 13L  |
| 7134-0614 | 14L  |
| 7134-0615 | 15L  |
| 7134-0616 | 16L  |
| 7134-0617 | 17L  |
| 7134-0618 | 18L  |
| 7134-0619 | 19L  |
| 7134-0620 | 20L  |
| 7134-0712 | 12R  |
| 7134-0713 | 13R  |
| 7134-0714 | 14R  |
| 7134-0715 | 15R  |
| 7134-0716 | 16R  |
| 7134-0717 | 17R  |



\* Note: These sizes available by special request.

## Porous Bowed Implants (260mm); +15mm Calcar

| Cat. No.  | Size  |
|-----------|-------|
| 7134-0718 | 18R   |
| 7134-0719 | 19R   |
| 7134-0720 | 20R   |
| 7134-0621 | 21L * |
| 7134-0622 | 22L * |
| 7134-0721 | 21R * |
| 7134-0722 | 22R * |

\* NOTE: These sizes available by special request.

## Porous Bowed Implants (260mm); +30mm Calcar

| Cat. No.  | Size  |
|-----------|-------|
| 7134-0812 | 12L   |
| 7134-0813 | 13L   |
| 7134-0814 | 14L   |
| 7134-0815 | 15L   |
| 7134-0816 | 16L   |
| 7134-0817 | 17L   |
| 7134-0818 | 18L   |
| 7134-0819 | 19L   |
| 7134-0820 | 20L   |
| 7134-0912 | 12R   |
| 7134-0913 | 13R   |
| 7134-0914 | 14R   |
| 7134-0915 | 15R   |
| 7134-0916 | 16R   |
| 7134-0917 | 17R   |
| 7134-0918 | 18R   |
| 7134-0919 | 19R   |
| 7134-0920 | 20R   |
| 7134-0821 | 21L * |
| 7134-0822 | 22L * |
| 7134-0921 | 21R * |
| 7134-0922 | 22R * |

\* NOTE: These sizes available by special request.



## Porous Bowed Implants (260mm); Standard Collar

| Cat. No.  | Size  |
|-----------|-------|
| 7134-0412 | 12L   |
| 7134-0413 | 13L   |
| 7134-0414 | 14L   |
| 7134-0415 | 15L   |
| 7134-0416 | 16L   |
| 7134-0417 | 17L   |
| 7134-0418 | 18L   |
| 7134-0419 | 19L   |
| 7134-0420 | 20L   |
| 7134-0512 | 12R   |
| 7134-0513 | 13R   |
| 7134-0514 | 14R   |
| 7134-0515 | 15R   |
| 7134-0516 | 16R   |
| 7134-0517 | 17R   |
| 7134-0518 | 18R   |
| 7134-0519 | 19R   |
| 7134-0520 | 20R   |
| 7134-0421 | 21L * |
| 7134-0422 | 22L * |
| 7134-0521 | 21R * |
| 7134-0522 | 22R * |

\* NOTE: These sizes available by special request.



## Porous Plus HA (190mm); +15mm Calcar

| Cat. No.  | Size |
|-----------|------|
| 7134-3011 | 11   |
| 7134-3012 | 12   |
| 7134-3013 | 13   |
| 7134-3014 | 14   |
| 7134-3015 | 15   |
| 7134-3016 | 16   |
| 7134-3017 | 17   |
| 7134-3018 | 18   |
| 7134-3019 | 19   |
| 7134-3020 | 20   |





# Reconstructive Surgery

## Hip Systems

### Porous Plus HA (190mm); Standard Collar

| Cat. No.  | Size |
|-----------|------|
| 7134-2011 | 11   |
| 7134-2012 | 12   |
| 7134-2013 | 13   |
| 7134-2014 | 14   |
| 7134-2015 | 15   |
| 7134-2016 | 16   |
| 7134-2017 | 17   |
| 7134-2018 | 18   |
| 7134-2019 | 19   |
| 7134-2020 | 20   |



### CoCr 12/14 Femoral Heads

Cobalt Chromium- ASTM F 799

| Cat. No.  | Size | Neck Length |
|-----------|------|-------------|
| 7130-2808 | 28mm | +8          |
| 7130-2812 | 28mm | +12         |
| 7130-2816 | 28mm | +16         |
| 7130-3203 | 32mm | -3          |
| 7130-3200 | 32mm | +0          |
| 7130-3204 | 32mm | +4          |
| 7130-3208 | 32mm | +8          |
| 7130-3212 | 32mm | +12         |
| 7130-3216 | 32mm | +16         |
| 7130-3603 | 36mm | -3          |
| 7130-3600 | 36mm | +0          |
| 7130-3604 | 36mm | +4          |
| 7130-3608 | 36mm | +8          |
| 7130-3612 | 36mm | +12         |

### Femoral Options/Echelon Revision Hip System/Heads

#### Alumina 12/14 Taper Femoral Heads

| Cat. No.  | Size | Length (mm) |
|-----------|------|-------------|
| 7133-2800 | +0   | 28mm        |
| 7133-2804 | +4   | 28mm        |
| 7133-2808 | +8   | 28mm        |
| 7133-3200 | +0   | 32mm        |
| 7133-3204 | +4   | 32mm        |
| 7133-3208 | +8   | 32mm        |
| 7133-3600 | +0   | 36mm        |
| 7133-3604 | +4   | 36mm        |
| 7133-3608 | +8   | 36mm        |



#### Oxinium 12/14 Taper Femoral Heads

| Cat. No.  | Size | Neck Length |
|-----------|------|-------------|
| 7134-2200 | 22mm | +0          |
| 7134-2204 | 22mm | +4          |
| 7134-2208 | 22mm | +8          |
| 7134-2600 | 26mm | +0          |
| 7134-2604 | 26mm | +4          |
| 7134-2608 | 26mm | +8          |
| 7134-2803 | 28mm | -3          |
| 7134-2800 | 28mm | +0          |
| 7134-2804 | 28mm | +4          |
| 7134-2808 | 28mm | +8          |
| 7134-2812 | 28mm | +12         |
| 7134-2816 | 28mm | +16         |
| 7134-3203 | 32mm | -3          |
| 7134-3200 | 32mm | +0          |
| 7134-3204 | 32mm | +4          |
| 7134-3208 | 32mm | +8          |
| 7134-3212 | 32mm | +12         |
| 7134-3216 | 32mm | +16         |
| 7134-3603 | 36mm | -3          |
| 7134-3600 | 36mm | +0          |
| 7134-3604 | 36mm | +4          |
| 7134-3608 | 36mm | +8          |
| 7134-3612 | 36mm | +12         |



### CoCr 12/14 Femoral Heads

Cobalt Chromium- ASTM F 799

| Cat. No.  | Size | Neck Length |
|-----------|------|-------------|
| 7130-2200 | 22mm | +0          |
| 7130-2204 | 22mm | +4          |
| 7130-2208 | 22mm | +8          |
| 7130-2212 | 22mm | +12         |
| 7130-2600 | 26mm | +0          |
| 7130-2604 | 26mm | +4          |
| 7130-2608 | 26mm | +8          |
| 7130-2612 | 26mm | +12         |
| 7130-2803 | 28mm | -3          |
| 7130-2800 | 28mm | +0          |
| 7130-2804 | 28mm | +4          |



## Trial 12/14 Taper Femoral Heads



| Cat. No.  | Size | Neck Length | Color Code |
|-----------|------|-------------|------------|
| 7135-2200 | 22mm | +0          | Yellow     |
| 7135-2204 | 22mm | +4          | Red        |
| 7135-2208 | 22mm | +8          | White      |
| 7135-2212 | 22mm | +12         | Blue       |
| 7135-2600 | 26mm | +0          | Yellow     |
| 7135-2604 | 26mm | +4          | Red        |
| 7135-2608 | 26mm | +8          | White      |
| 7135-2612 | 26mm | +12         | Blue       |
| 7135-2803 | 28mm | -3          | Green      |
| 7135-2800 | 28mm | +0          | Yellow     |
| 7135-2804 | 28mm | +4          | Red        |
| 7135-2808 | 28mm | +8          | White      |
| 7135-2812 | 28mm | +12         | Blue       |
| 7135-2816 | 28mm | +16         | Black      |
| 7135-3203 | 32mm | -3          | Green      |
| 7135-3200 | 32mm | +0          | Yellow     |
| 7135-3204 | 32mm | +4          | Red        |
| 7135-3208 | 32mm | +8          | White      |
| 7135-3212 | 32mm | +12         | Blue       |
| 7135-3216 | 32mm | +16         | Black      |
| 7135-3603 | 36mm | -3          | Green      |
| 7135-3600 | 36mm | +0          | Yellow     |
| 7135-3604 | 36mm | +4          | Red        |
| 7135-3608 | 36mm | +8          | White      |
| 7135-3612 | 36mm | +12         | Blue       |

## Femoral Options/Echelon Revision Hip System/Echelon Starter Tray

## Anteversersion Handle (2 per set)

Cat. No. 7136-4012



## Box Osteotome

Cat. No. 7136-4002



## Broach Handle (2 per set)

Cat. No. 7136-4007



## Echelon Starter Tray

Cat. No. 7136-6001

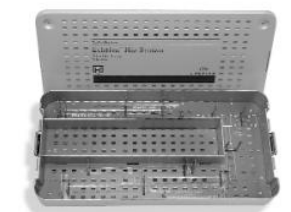

## Femoral Canal Finder

Cat. No. 7136-4001



## Osteotomy Guide

Cat. No. 7136-4000



### Proximal Reamer

Cat. No.  
7136-4015



### Rigid Reamer

| Cat. No.  | Size    |
|-----------|---------|
| 7135-0140 | 14 mm   |
| 7135-0145 | 14.5 mm |
| 7135-0150 | 15 mm   |
| 7135-0155 | 15.5 mm |
| 7135-0160 | 16 mm   |
| 7135-0165 | 16.5 mm |
| 7135-0170 | 17 mm   |
| 7135-0175 | 17.5 mm |
| 7135-0180 | 18 mm   |
| 7135-0185 | 18.5 mm |
| 7135-0190 | 19 mm   |
| 7135-0195 | 19.5 mm |
| 7135-0200 | 20 mm   |

### T-Handle

Cat. No.  
7136-4006



### Femoral Options/Echelon Revision Hip System/Echelon Reamer Tray

#### Echelon Reamer Tray

Cat. No.  
7136-6002



### Femoral Options/Echelon Revision Hip System/Broach Tray

#### Broach

| Cat. No.  | Size |
|-----------|------|
| 7136-7010 | 10   |
| 7136-7011 | 11   |
| 7136-7012 | 12   |
| 7136-7013 | 13   |
| 7136-7014 | 14   |
| 7136-7015 | 15   |
| 7136-7016 | 16   |
| 7136-7017 | 17   |
| 7136-7018 | 18   |
| 7136-7019 | 19   |
| 7136-7020 | 20   |



### Rigid Reamer

| Cat. No.  | Size    |
|-----------|---------|
| 7135-0090 | 9 mm    |
| 7135-0095 | 9.5 mm  |
| 7135-0100 | 10 mm   |
| 7135-0105 | 10.5 mm |
| 7135-0110 | 11 mm   |
| 7135-0115 | 11.5 mm |
| 7135-0120 | 12 mm   |
| 7135-0125 | 12.5 mm |
| 7135-0130 | 13 mm   |
| 7135-0135 | 13.5 mm |



### Broach Tray

Cat. No.  
7136-6003



## Calcar Reamer

| Cat. No.  | Size  |
|-----------|-------|
| 7136-4004 | Small |
| 7136-4005 | Large |



## Femoral Head Impactor

| Cat. No.  |
|-----------|
| 7136-4009 |



## Stem Inserter Frame

| Cat. No.  |
|-----------|
| 7136-4008 |



## Stem Inserter Pommel

| Cat. No.  |
|-----------|
| 7136-4011 |



## Trial Neck

Echelon Revision

| Cat. No.  | Size  |
|-----------|-------|
| 7136-7101 | 11-12 |
| 7136-7102 | 13-17 |
| 7136-7103 | 18-20 |



## Femoral Options/Echelon Revision Hip System/Straight Stem Trial Tray Porous and Cemented

## Cemented Stem Inserter

| Cat. No.  |
|-----------|
| 7136-4014 |



## Cemented Stem Trial

| Cat. No.  | Size | Length (mm) |
|-----------|------|-------------|
| 7136-8512 | 12   | 175         |
| 7136-8514 | 14   | 175         |
| 7136-8516 | 16   | 175         |
| 7136-8612 | 12   | 225         |
| 7136-8614 | 14   | 225         |
| 7136-8616 | 16   | 225         |
| 7136-8712 | 12L  | 300         |
| 7136-8714 | 14L  | 300         |
| 7136-8812 | 12R  | 300         |
| 7136-8814 | 14R  | 300         |



## Porous Straight Stem Trial

| Cat. No.  | Size |
|-----------|------|
| 7136-8011 | 11   |
| 7136-8012 | 12   |
| 7136-8013 | 13   |
| 7136-8014 | 14   |
| 7136-8015 | 15   |
| 7136-8016 | 16   |
| 7136-8017 | 17   |
| 7136-8018 | 18   |
| 7136-8019 | 19   |
| 7136-8020 | 20   |



## Straight Stem Trial Tray Porous and Cemented

| Cat. No.  |
|-----------|
| 7136-6004 |



# Reconstructive Surgery

## Hip Systems

**Trial Collar**  
(2 per set)

| Cat. No.  |
|-----------|
| 7136-7034 |



**Porous Bowed Stem Trial**

| Cat. No.  | Size |
|-----------|------|
| 7136-8422 | 22R* |

\* NOTE: Available by special request.

**Femoral Options/Echelon Revision Hip System/Bowed Stem Trial Tray**

**Bowed Stem Trial Tray**

| Cat. No.  |
|-----------|
| 7136-6015 |



**Femoral Options/Echelon Revision Hip System/Echelon Thin Shaft Reamer Tray**

**Echelon Thin Shaft Reamer Tray**

| Cat. No.  |
|-----------|
| 7136-6006 |



**Porous Bowed Stem Trial**

| Cat. No.  | Size |
|-----------|------|
| 7136-8312 | 12L  |
| 7136-8313 | 13L  |
| 7136-8314 | 14L  |
| 7136-8315 | 15L  |
| 7136-8316 | 16L  |
| 7136-8317 | 17L  |
| 7136-8318 | 18L  |
| 7136-8319 | 19L  |
| 7136-8320 | 20L  |
| 7136-8321 | 21L* |
| 7136-8322 | 22L* |
| 7136-8412 | 12R  |
| 7136-8413 | 13R  |
| 7136-8414 | 14R  |
| 7136-8415 | 15R  |
| 7136-8416 | 16R  |
| 7136-8417 | 17R  |
| 7136-8418 | 18R  |
| 7136-8419 | 19R  |
| 7136-8420 | 20R  |
| 7136-8421 | 21R* |



**Thin Shaft Reamer**

| Cat. No.  | Size    |
|-----------|---------|
| 7135-1900 | 9 mm    |
| 7135-1100 | 10 mm   |
| 7135-1110 | 11 mm   |
| 7135-1115 | 11.5 mm |
| 7135-1120 | 12 mm   |
| 7135-1125 | 12.5 mm |
| 7135-1130 | 13 mm   |
| 7135-1135 | 13.5 mm |
| 7135-1140 | 14 mm   |
| 7135-1145 | 14.5 mm |
| 7135-1150 | 15 mm   |
| 7135-1155 | 15.5 mm |
| 7135-1160 | 16 mm   |
| 7135-1165 | 16.5 mm |
| 7135-1170 | 17 mm   |
| 7135-1175 | 17.5 mm |
| 7135-1180 | 18 mm   |
| 7135-1185 | 18.5 mm |
| 7135-1190 | 19 mm   |
| 7135-1195 | 19.5 mm |
| 7135-1200 | 20 mm   |
| 7135-1205 | 20.5 mm |



## Thin Shaft Reamer

| Cat. No.  | Size      |
|-----------|-----------|
| 7135-1210 | 21 mm     |
| 7135-1215 | 21.5 mm   |
| 7135-1220 | 22 mm     |
| 7135-1225 | 22.5 mm * |
| 7135-1230 | 23 mm *   |
| 7135-1235 | 23.5 mm * |
| 7135-1240 | 24 mm *   |

\* NOTE: Available by special request.

## Femoral Options/Echelon Revision Hip System/21-22 mm Bowed Stem Trial Thin Shaft Reamer Tray

### 21-22 mm Bowed Stem Trial Thin Shaft Reamer Tray

(Available by special request.)

| Cat. No.    |
|-------------|
| 7136-6007 * |



\* NOTE: Available by special request.

## Femoral Options/Echelon Revision Hip System/300 mm Bowed Cemented Stem Trial Tray

### 300 mm Bowed Cemented Stem Trial Tray

(Available by special request.)

| Cat. No.    |
|-------------|
| 7136-6008 * |



\* NOTE: Available by special request.

## Femoral Options/Spectron Primary Hip System/Implants

### Spectron EF 12/14 Primary Collared Stems

Cobalt Chromium - ASTM F 799



| Cat. No.  | Size | Length (mm) | Description |
|-----------|------|-------------|-------------|
| 7131-2101 | 1    | 115         | Implant     |
| 7131-2102 | 2    | 125         | Implant     |
| 7131-2103 | 3    | 135         | Implant     |
| 7131-2104 | 4    | 135         | Implant     |
| 7131-2105 | 5    | 135         | Implant     |

### Spectron EF 12/14 Primary High Offset Stems

Cobalt Chromium - ASTM F 799



| Cat. No.  | Size | Length (mm) | Description |
|-----------|------|-------------|-------------|
| 7131-2111 | 1H   | 115         | Implant     |
| 7131-2112 | 2H   | 125         | Implant     |
| 7131-2113 | 3H   | 135         | Implant     |
| 7131-2114 | 4H   | 135         | Implant     |
| 7131-2115 | 5H   | 135         | Implant     |

## Femoral Options/Spectron Primary Hip

### System/Heads

#### Alumina 12/14 Taper Femoral Heads

| Cat. No.  | Size | Length (mm) |
|-----------|------|-------------|
| 7133-2800 | +0   | 28mm        |
| 7133-2804 | +4   | 28mm        |
| 7133-2808 | +8   | 28mm        |
| 7133-3200 | +0   | 32mm        |
| 7133-3204 | +4   | 32mm        |
| 7133-3208 | +8   | 32mm        |
| 7133-3600 | +0   | 36mm        |
| 7133-3604 | +4   | 36mm        |
| 7133-3608 | +8   | 36mm        |



#### CoCr 12/14 Femoral Heads

Cobalt Chromium- ASTM F 799

| Cat. No.  | Size | Neck Length |
|-----------|------|-------------|
| 7130-2200 | 22mm | +0          |
| 7130-2204 | 22mm | +4          |
| 7130-2208 | 22mm | +8          |
| 7130-2212 | 22mm | +12         |
| 7130-2600 | 26mm | +0          |
| 7130-2604 | 26mm | +4          |
| 7130-2608 | 26mm | +8          |
| 7130-2612 | 26mm | +12         |
| 7130-2803 | 28mm | -3          |
| 7130-2800 | 28mm | +0          |
| 7130-2804 | 28mm | +4          |
| 7130-2808 | 28mm | +8          |
| 7130-2812 | 28mm | +12         |
| 7130-2816 | 28mm | +16         |
| 7130-3203 | 32mm | -3          |
| 7130-3200 | 32mm | +0          |
| 7130-3204 | 32mm | +4          |
| 7130-3208 | 32mm | +8          |
| 7130-3212 | 32mm | +12         |
| 7130-3216 | 32mm | +16         |
| 7130-3603 | 36mm | -3          |
| 7130-3600 | 36mm | +0          |
| 7130-3604 | 36mm | +4          |
| 7130-3608 | 36mm | +8          |
| 7130-3612 | 36mm | +12         |



#### Oxinium 12/14 Taper Femoral Heads

| Cat. No.  | Size | Neck Length |
|-----------|------|-------------|
| 7134-2200 | 22mm | +0          |
| 7134-2204 | 22mm | +4          |
| 7134-2208 | 22mm | +8          |
| 7134-2600 | 26mm | +0          |
| 7134-2604 | 26mm | +4          |
| 7134-2608 | 26mm | +8          |
| 7134-2803 | 28mm | -3          |
| 7134-2800 | 28mm | +0          |
| 7134-2804 | 28mm | +4          |
| 7134-2808 | 28mm | +8          |
| 7134-2812 | 28mm | +12         |
| 7134-2816 | 28mm | +16         |
| 7134-3203 | 32mm | -3          |
| 7134-3200 | 32mm | +0          |
| 7134-3204 | 32mm | +4          |
| 7134-3208 | 32mm | +8          |
| 7134-3212 | 32mm | +12         |
| 7134-3216 | 32mm | +16         |
| 7134-3603 | 36mm | -3          |
| 7134-3600 | 36mm | +0          |
| 7134-3604 | 36mm | +4          |
| 7134-3608 | 36mm | +8          |
| 7134-3612 | 36mm | +12         |



#### Trial 12/14 Taper Femoral Heads

| Cat. No.  | Size | Neck Length | Color Code |
|-----------|------|-------------|------------|
| 7135-2200 | 22mm | +0          | Yellow     |
| 7135-2204 | 22mm | +4          | Red        |
| 7135-2208 | 22mm | +8          | White      |
| 7135-2212 | 22mm | +12         | Blue       |
| 7135-2600 | 26mm | +0          | Yellow     |
| 7135-2604 | 26mm | +4          | Red        |



## Trial 12/14 Taper Femoral Heads

| Cat. No.  | Size | Neck Length | Color Code |
|-----------|------|-------------|------------|
| 7135-2608 | 26mm | +8          | White      |
| 7135-2612 | 26mm | +12         | Blue       |
| 7135-2803 | 28mm | -3          | Green      |
| 7135-2800 | 28mm | +0          | Yellow     |
| 7135-2804 | 28mm | +4          | Red        |
| 7135-2808 | 28mm | +8          | White      |
| 7135-2812 | 28mm | +12         | Blue       |
| 7135-2816 | 28mm | +16         | Black      |
| 7135-3203 | 32mm | -3          | Green      |
| 7135-3200 | 32mm | +0          | Yellow     |
| 7135-3204 | 32mm | +4          | Red        |
| 7135-3208 | 32mm | +8          | White      |
| 7135-3212 | 32mm | +12         | Blue       |
| 7135-3216 | 32mm | +16         | Black      |
| 7135-3603 | 36mm | -3          | Green      |
| 7135-3600 | 36mm | +0          | Yellow     |
| 7135-3604 | 36mm | +4          | Red        |
| 7135-3608 | 36mm | +8          | White      |
| 7135-3612 | 36mm | +12         | Blue       |

## Femoral Options/Spectron Primary Hip System/Instruments

### 12/14 Dual Offset Sterilization Tray

Cat. No.  
7136-9112



### 12/14 Standard Offset Sterilization Tray (Not shown)

Cat. No.  
7136-9113

### 12/14 Taper Trial Necks, High Offset

| Cat. No.  | Size |
|-----------|------|
| 7136-5091 | 1H   |



### 12/14 Taper Trial Necks, High Offset

| Cat. No.  | Size |
|-----------|------|
| 7136-5092 | 2H   |
| 7136-5093 | 3H   |
| 7136-5094 | 4H   |
| 7136-5095 | 5H   |

### 12/14 Taper Trial Necks, Standard Offset Primary Collared

| Cat. No.  | Size |
|-----------|------|
| 7136-5081 | 1    |
| 7136-5082 | 2    |
| 7136-5083 | 3    |
| 7136-5084 | 4    |
| 7136-5085 | 5    |



### Anteversion Handle

Cat. No.  
7136-4012



### Blunt Medullary Reamer

Cat. No.  
11-9657



### Box Chisel

Cat. No. Size  
7136-4002 Small



### Broach Handle

Cat. No.  
7136-4007





### Broaches/Trials

| Cat. No.  | Size |
|-----------|------|
| 7136-5001 | 1    |
| 7136-5002 | 2    |
| 7136-5003 | 3    |
| 7136-5004 | 4    |
| 7136-5005 | 5    |



### Calcar Reamers

| Cat. No.  | Size |
|-----------|------|
| 7136-5023 | 1-3  |
| 7136-5025 | 4-5  |



### Dead Blow Mallet

| Cat. No.  |
|-----------|
| 7136-2106 |



### Femoral Component Driver

| Cat. No. |
|----------|
| 11-9817  |



### Femoral Head Impactor

| Cat. No.  |
|-----------|
| 7136-4009 |



### Osteotomy Guide

| Cat. No.  |
|-----------|
| 7136-5036 |



### System/Distal Centralizers

#### Invis Distal Centralizers

| Cat. No.  | Size | O.D. |
|-----------|------|------|
| 7131-3101 | 1    | 8mm  |
| 7131-3102 | 2    | 9mm  |
| 7131-3103 | 3    | 10mm |
| 7131-3104 | 4    | 12mm |
| 7131-3105 | 5    | 13mm |



### Femoral Options/Spectron Primary Hip System/Additional/Optional Instruments

#### Dead Blow Mallet

| Cat. No.  |
|-----------|
| 7136-2106 |



#### Femoral Component Extractor

| Cat. No. |
|----------|
| 11-9871  |



#### Femoral Head Removal Tool

| Cat. No. | Description      |
|----------|------------------|
| 11-9683  | Pry Tool - Thin  |
|          | Platform - Left  |
|          | Pry Tool - Thick |
|          | Platform - Right |

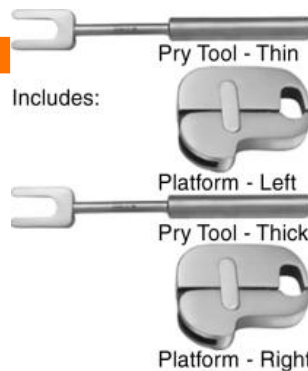

### Femoral Options/Spectron Primary Hip

## Femoral Sounds

| Cat. No.  | Size     |
|-----------|----------|
| 7136-3508 | 8-9 mm   |
| 7136-3510 | 10-11 mm |
| 7136-3512 | 12-13 mm |
| 7136-3514 | 14-15 mm |
| 7136-3516 | 16-17 mm |
| 7136-3518 | 18-19 mm |



## Large Box Chisel

| Cat. No.  | Size  |
|-----------|-------|
| 7136-4003 | Large |



## Side Angled Curette

| Cat. No. | Size  |
|----------|-------|
| 11-9672  | Right |
| 11-9673  | Left  |



## Slotted Hammer

| Cat. No. |
|----------|
| MT-1901  |



## Femoral Options/Spectron Revision Hip System /Implants

### Long Straight Implants

| Cat. No.  | Size   | Length |
|-----------|--------|--------|
| 7131-2231 | Small  | 165mm  |
| 7131-2232 | Medium | 165mm  |
| 7131-2233 | Large  | 165mm  |
| 7131-2234 | Small  | 195mm  |
| 7131-2235 | Medium | 195mm  |
| 7131-2236 | Large  | 195mm  |
| 7131-2237 | Small  | 225mm  |
| 7131-2238 | Medium | 225mm  |
| 7131-2239 | Large  | 225mm  |



## Neck Replacement Implants

| Cat. No.  | Size   | Length |
|-----------|--------|--------|
| 7131-2240 | Small  | 135mm  |
| 7131-2241 | Medium | 135mm  |
| 7131-2242 | Large  | 135mm  |
| 7131-2243 | Small  | 165mm  |
| 7131-2244 | Medium | 165mm  |
| 7131-2245 | Large  | 165mm  |
| 7131-2246 | Small  | 195mm  |
| 7131-2247 | Medium | 195mm  |
| 7131-2248 | Large  | 195mm  |
| 7131-2249 | Small  | 225mm  |
| 7131-2250 | Medium | 225mm  |
| 7131-2251 | Large  | 225mm  |



## Femoral Options/Spectron Revision Hip System /Heads

### Alumina 12/14 Taper Femoral Heads

| Cat. No.  | Size | Length (mm) |
|-----------|------|-------------|
| 7133-2800 | +0   | 28mm        |
| 7133-2804 | +4   | 28mm        |
| 7133-2808 | +8   | 28mm        |
| 7133-3200 | +0   | 32mm        |
| 7133-3204 | +4   | 32mm        |
| 7133-3208 | +8   | 32mm        |
| 7133-3600 | +0   | 36mm        |
| 7133-3604 | +4   | 36mm        |
| 7133-3608 | +8   | 36mm        |



### CoCr 12/14 Femoral Heads Cobalt Chromium- ASTM F 799

| Cat. No.  | Size | Neck Length |
|-----------|------|-------------|
| 7130-2200 | 22mm | +0          |
| 7130-2204 | 22mm | +4          |
| 7130-2208 | 22mm | +8          |
| 7130-2212 | 22mm | +12         |
| 7130-2600 | 26mm | +0          |
| 7130-2604 | 26mm | +4          |
| 7130-2608 | 26mm | +8          |
| 7130-2612 | 26mm | +12         |
| 7130-2803 | 28mm | -3          |



# Reconstructive Surgery

## Hip Systems

### CoCr 12/14 Femoral Heads

Cobalt Chromium- ASTM F 799

| Cat. No.  | Size | Neck Length |
|-----------|------|-------------|
| 7130-2800 | 28mm | +0          |
| 7130-2804 | 28mm | +4          |
| 7130-2808 | 28mm | +8          |
| 7130-2812 | 28mm | +12         |
| 7130-2816 | 28mm | +16         |
| 7130-3203 | 32mm | -3          |
| 7130-3200 | 32mm | +0          |
| 7130-3204 | 32mm | +4          |
| 7130-3208 | 32mm | +8          |
| 7130-3212 | 32mm | +12         |
| 7130-3216 | 32mm | +16         |
| 7130-3603 | 36mm | -3          |
| 7130-3600 | 36mm | +0          |
| 7130-3604 | 36mm | +4          |
| 7130-3608 | 36mm | +8          |
| 7130-3612 | 36mm | +12         |

### Trial 12/14 Taper Femoral Heads



| Cat. No.  | Size | Neck Length | Color Code |
|-----------|------|-------------|------------|
| 7135-2200 | 22mm | +0          | Yellow     |
| 7135-2204 | 22mm | +4          | Red        |
| 7135-2208 | 22mm | +8          | White      |
| 7135-2212 | 22mm | +12         | Blue       |
| 7135-2600 | 26mm | +0          | Yellow     |
| 7135-2604 | 26mm | +4          | Red        |
| 7135-2608 | 26mm | +8          | White      |
| 7135-2612 | 26mm | +12         | Blue       |
| 7135-2803 | 28mm | -3          | Green      |
| 7135-2800 | 28mm | +0          | Yellow     |
| 7135-2804 | 28mm | +4          | Red        |
| 7135-2808 | 28mm | +8          | White      |
| 7135-2812 | 28mm | +12         | Blue       |
| 7135-2816 | 28mm | +16         | Black      |
| 7135-3203 | 32mm | -3          | Green      |
| 7135-3200 | 32mm | +0          | Yellow     |
| 7135-3204 | 32mm | +4          | Red        |
| 7135-3208 | 32mm | +8          | White      |
| 7135-3212 | 32mm | +12         | Blue       |
| 7135-3216 | 32mm | +16         | Black      |
| 7135-3603 | 36mm | -3          | Green      |
| 7135-3600 | 36mm | +0          | Yellow     |
| 7135-3604 | 36mm | +4          | Red        |
| 7135-3608 | 36mm | +8          | White      |
| 7135-3612 | 36mm | +12         | Blue       |

### Oxinium 12/14 Taper Femoral Heads

| Cat. No.  | Size | Neck Length |
|-----------|------|-------------|
| 7134-2200 | 22mm | +0          |
| 7134-2204 | 22mm | +4          |
| 7134-2208 | 22mm | +8          |
| 7134-2600 | 26mm | +0          |
| 7134-2604 | 26mm | +4          |
| 7134-2608 | 26mm | +8          |
| 7134-2803 | 28mm | -3          |
| 7134-2800 | 28mm | +0          |
| 7134-2804 | 28mm | +4          |
| 7134-2808 | 28mm | +8          |
| 7134-2812 | 28mm | +12         |
| 7134-2816 | 28mm | +16         |
| 7134-3203 | 32mm | -3          |
| 7134-3200 | 32mm | +0          |
| 7134-3204 | 32mm | +4          |
| 7134-3208 | 32mm | +8          |
| 7134-3212 | 32mm | +12         |
| 7134-3216 | 32mm | +16         |
| 7134-3603 | 36mm | -3          |
| 7134-3600 | 36mm | +0          |
| 7134-3604 | 36mm | +4          |
| 7134-3608 | 36mm | +8          |
| 7134-3612 | 36mm | +12         |



### Femoral Options/Spectron Revision Hip System /Instruments

## Interior Tray

| Cat. No.  |
|-----------|
| 7136-9114 |

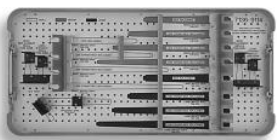

## Neck Replacement Trial Necks 12/14 Taper

| Cat. No.  | Size  |
|-----------|-------|
| 7136-5096 | Small |
| 7136-5097 | Large |



## Lid For Exterior Carrying Case

| Cat. No.  |
|-----------|
| 7136-9402 |



## Osteotomy Guide

| Cat. No.  |
|-----------|
| 7136-5036 |



## Long Straight Trial Necks 12/14 Taper

| Cat. No.  | Size  |
|-----------|-------|
| 7136-5098 | Small |
| 7136-5099 | Large |



## Side Angled Curette

| Cat. No. | Size  |
|----------|-------|
| 11-9672  | Right |
| 11-9673  | Left  |



## Long Straight/ Neck Replacements Broaches/Trials

| Cat. No.  | Size    | Length |
|-----------|---------|--------|
| 7136-5126 | Small*  | 135mm  |
| 7136-5127 | Medium* | 135mm  |
| 7136-5128 | Large*  | 135mm  |
| 7136-5129 | Small   | 165mm  |
| 7136-5132 | Medium  | 165mm  |
| 7136-5135 | Large   | 165mm  |
| 7136-5130 | Small   | 195mm  |
| 7136-5133 | Medium  | 195mm  |
| 7136-5136 | Large   | 195mm  |
| 7136-5131 | Small   | 225mm  |
| 7136-5137 | Large   | 195mm  |



## Small Exterior Carrying Case

| Cat. No.  |
|-----------|
| 7112-9401 |

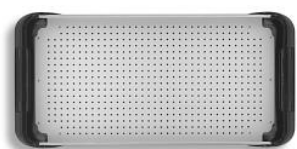

## Spectron 12/14 Revision Instrument Tray Set

Set includes: 7112-9401; 7112-9402 and 7136-9114

| Cat. No.  |
|-----------|
| 7136-9115 |

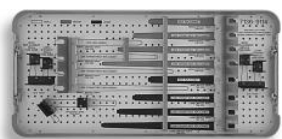

\* Only available with neck replacement implants.

## Femoral Options/Spectron Revision Hip System /Centralizers

# Reconstructive Surgery

## Hip Systems

### Spectron Revision Centralizers

| Cat. No.  | Size   | O.D. |
|-----------|--------|------|
| 7131-3312 | Small  | 12mm |
| 7131-3314 | Medium | 14mm |
| 7131-3316 | Large  | 16mm |



### Femoral Options/Cobra Femoral Component/Implants

#### Cobra 12/14 Taper Primary Collared Stems

Cobalt Chromium - ASTM F 799

| Cat. No.  | Size | Length (mm) |
|-----------|------|-------------|
| 7131-2161 | 1    | 115         |
| 7131-2162 | 2    | 125         |
| 7131-2163 | 3    | 135         |
| 7131-2164 | 4    | 135         |
| 7131-2165 | 5    | 135         |



### Femoral Options/Cobra Femoral Component/Heads

#### Alumina 12/14 Taper Femoral Heads

| Cat. No.  | Size | Length (mm) |
|-----------|------|-------------|
| 7133-2800 | +0   | 28mm        |
| 7133-2804 | +4   | 28mm        |
| 7133-2808 | +8   | 28mm        |
| 7133-3200 | +0   | 32mm        |
| 7133-3204 | +4   | 32mm        |
| 7133-3208 | +8   | 32mm        |
| 7133-3600 | +0   | 36mm        |
| 7133-3604 | +4   | 36mm        |
| 7133-3608 | +8   | 36mm        |



### CoCr 12/14 Femoral Heads

Cobalt Chromium- ASTM F 799

| Cat. No.  | Size | Neck Length |
|-----------|------|-------------|
| 7130-2200 | 22mm | +0          |
| 7130-2204 | 22mm | +4          |
| 7130-2208 | 22mm | +8          |
| 7130-2212 | 22mm | +12         |
| 7130-2600 | 26mm | +0          |
| 7130-2604 | 26mm | +4          |
| 7130-2608 | 26mm | +8          |
| 7130-2612 | 26mm | +12         |
| 7130-2803 | 28mm | -3          |
| 7130-2800 | 28mm | +0          |
| 7130-2804 | 28mm | +4          |
| 7130-2808 | 28mm | +8          |
| 7130-2812 | 28mm | +12         |
| 7130-2816 | 28mm | +16         |
| 7130-3203 | 32mm | -3          |
| 7130-3200 | 32mm | +0          |
| 7130-3204 | 32mm | +4          |
| 7130-3208 | 32mm | +8          |
| 7130-3212 | 32mm | +12         |
| 7130-3216 | 32mm | +16         |
| 7130-3603 | 36mm | -3          |
| 7130-3600 | 36mm | +0          |
| 7130-3604 | 36mm | +4          |
| 7130-3608 | 36mm | +8          |
| 7130-3612 | 36mm | +12         |



#### Oxinium 12/14 Taper Femoral Heads

| Cat. No.  | Size | Neck Length |
|-----------|------|-------------|
| 7134-2200 | 22mm | +0          |
| 7134-2204 | 22mm | +4          |
| 7134-2208 | 22mm | +8          |
| 7134-2600 | 26mm | +0          |
| 7134-2604 | 26mm | +4          |
| 7134-2608 | 26mm | +8          |
| 7134-2803 | 28mm | -3          |
| 7134-2800 | 28mm | +0          |
| 7134-2804 | 28mm | +4          |
| 7134-2808 | 28mm | +8          |
| 7134-2812 | 28mm | +12         |
| 7134-2816 | 28mm | +16         |
| 7134-3203 | 32mm | -3          |
| 7134-3200 | 32mm | +0          |
| 7134-3204 | 32mm | +4          |



## Oxinium 12/14 Taper Femoral Heads

| Cat. No.  | Size | Neck Length |
|-----------|------|-------------|
| 7134-3208 | 32mm | +8          |
| 7134-3212 | 32mm | +12         |
| 7134-3216 | 32mm | +16         |
| 7134-3603 | 36mm | -3          |
| 7134-3600 | 36mm | +0          |
| 7134-3604 | 36mm | +4          |
| 7134-3608 | 36mm | +8          |
| 7134-3612 | 36mm | +12         |

## Trial 12/14 Taper Femoral Heads

| Cat. No.  | Size | Neck Length | Color Code |
|-----------|------|-------------|------------|
| 7135-3604 | 36mm | +4          | Red        |
| 7135-3608 | 36mm | +8          | White      |
| 7135-3612 | 36mm | +12         | Blue       |

## Trial 12/14 Taper Femoral Heads



## Femoral Options/Cobra Femoral Component/Instruments

### 12/14 Dual Offset Sterilization Tray

| Cat. No.  |
|-----------|
| 7136-9112 |

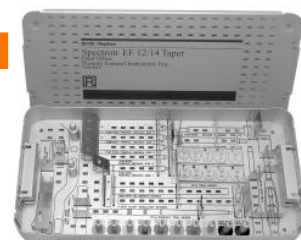

### 12/14 Standard Offset Sterilization Tray (Not shown)

| Cat. No.  |
|-----------|
| 7136-9113 |

| Cat. No.  | Size | Neck Length | Color Code |
|-----------|------|-------------|------------|
| 7135-2200 | 22mm | +0          | Yellow     |
| 7135-2204 | 22mm | +4          | Red        |
| 7135-2208 | 22mm | +8          | White      |
| 7135-2212 | 22mm | +12         | Blue       |
| 7135-2600 | 26mm | +0          | Yellow     |
| 7135-2604 | 26mm | +4          | Red        |
| 7135-2608 | 26mm | +8          | White      |
| 7135-2612 | 26mm | +12         | Blue       |
| 7135-2803 | 28mm | -3          | Green      |
| 7135-2800 | 28mm | +0          | Yellow     |
| 7135-2804 | 28mm | +4          | Red        |
| 7135-2808 | 28mm | +8          | White      |
| 7135-2812 | 28mm | +12         | Blue       |
| 7135-2816 | 28mm | +16         | Black      |
| 7135-3203 | 32mm | -3          | Green      |
| 7135-3200 | 32mm | +0          | Yellow     |
| 7135-3204 | 32mm | +4          | Red        |
| 7135-3208 | 32mm | +8          | White      |
| 7135-3212 | 32mm | +12         | Blue       |
| 7135-3216 | 32mm | +16         | Black      |
| 7135-3603 | 36mm | -3          | Green      |
| 7135-3600 | 36mm | +0          | Yellow     |

### 12/14 Taper Trial Necks

| Cat. No.  | Size |
|-----------|------|
| 7136-5081 | 1    |
| 7136-5082 | 2    |
| 7136-5083 | 3    |
| 7136-5084 | 4    |
| 7136-5085 | 5    |



### Anteverson Handle

| Cat. No.  |
|-----------|
| 7136-4012 |



### Blunt Medullary Reamer

| Cat. No. |
|----------|
| 11-9657  |



### Femoral Component Driver

| Cat. No. |
|----------|
| 11-9817  |



### Box Chisel

| Cat. No.  | Size  |
|-----------|-------|
| 7136-4002 | Small |



### Femoral Head Impactor

| Cat. No.  |
|-----------|
| 7136-4009 |



### Broach Handle

| Cat. No.  |
|-----------|
| 7136-4007 |



### Osteotomy Guide

| Cat. No.  |
|-----------|
| 7136-5036 |



### Broaches/Trials

| Cat. No.  | Size |
|-----------|------|
| 7136-5001 | 1    |
| 7136-5002 | 2    |
| 7136-5003 | 3    |
| 7136-5004 | 4    |
| 7136-5005 | 5    |



### Femoral Options/Cobra Femoral Component/Distal Centralizers

#### Invis Distal Centralizers

| Cat. No.  | Size | O.D. |
|-----------|------|------|
| 7131-3101 | 1    | 8mm  |
| 7131-3102 | 2    | 9mm  |
| 7131-3103 | 3    | 10mm |
| 7131-3104 | 4    | 12mm |
| 7131-3105 | 5    | 13mm |



### Calcar Reamers

| Cat. No.  | Size |
|-----------|------|
| 7136-5023 | 1-3  |
| 7136-5025 | 4-5  |



### Femoral Options/Cobra Femoral Component/Additional/Optional Instruments

### Dead Blow Mallet

| Cat. No.  |
|-----------|
| 7136-2106 |



### Dead Blow Mallet

| Cat. No.  |
|-----------|
| 7136-2106 |



### Femoral Component Extractor

| Cat. No. |
|----------|
| 11-9871  |



## Femoral Head Removal Tool

| Cat. No. | Description      |
|----------|------------------|
| 11-9683  |                  |
|          | Pry Tool - Thin  |
|          | Platform - Left  |
|          | Pry Tool - Thick |
|          | Platform - Right |

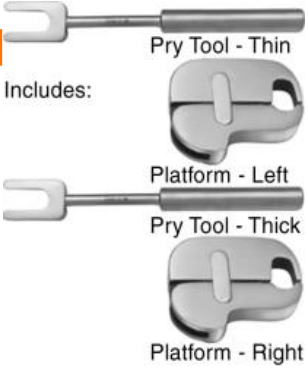

## Alumina 12/14 Taper Femoral Heads

| Cat. No.  | Size | Length (mm) |
|-----------|------|-------------|
| 7133-2800 | +0   | 28mm        |
| 7133-2804 | +4   | 28mm        |
| 7133-2808 | +8   | 28mm        |
| 7133-3200 | +0   | 32mm        |
| 7133-3204 | +4   | 32mm        |
| 7133-3208 | +8   | 32mm        |
| 7133-3600 | +0   | 36mm        |
| 7133-3604 | +4   | 36mm        |
| 7133-3608 | +8   | 36mm        |



## Femoral Sounds

| Cat. No.  | Size     |
|-----------|----------|
| 7136-3508 | 8-9 mm   |
| 7136-3510 | 10-11 mm |
| 7136-3512 | 12-13 mm |
| 7136-3514 | 14-15 mm |
| 7136-3516 | 16-17 mm |
| 7136-3518 | 18-19 mm |



## CoCr 12/14 Femoral Heads

Cobalt Chromium- ASTM F 799

| Cat. No.  | Size | Neck Length |
|-----------|------|-------------|
| 7130-2200 | 22mm | +0          |
| 7130-2204 | 22mm | +4          |
| 7130-2208 | 22mm | +8          |
| 7130-2212 | 22mm | +12         |
| 7130-2600 | 26mm | +0          |
| 7130-2604 | 26mm | +4          |
| 7130-2608 | 26mm | +8          |
| 7130-2612 | 26mm | +12         |
| 7130-2803 | 28mm | -3          |
| 7130-2800 | 28mm | +0          |
| 7130-2804 | 28mm | +4          |
| 7130-2808 | 28mm | +8          |
| 7130-2812 | 28mm | +12         |
| 7130-2816 | 28mm | +16         |
| 7130-3203 | 32mm | -3          |
| 7130-3200 | 32mm | +0          |
| 7130-3204 | 32mm | +4          |
| 7130-3208 | 32mm | +8          |
| 7130-3212 | 32mm | +12         |
| 7130-3216 | 32mm | +16         |
| 7130-3603 | 36mm | -3          |
| 7130-3600 | 36mm | +0          |
| 7130-3604 | 36mm | +4          |
| 7130-3608 | 36mm | +8          |
| 7130-3612 | 36mm | +12         |



## Large Box Chisel

| Cat. No.  | Size  |
|-----------|-------|
| 7136-4003 | Large |



## Side Angled Curette

| Cat. No. | Size  |
|----------|-------|
| 11-9672  | Right |
| 11-9673  | Left  |



## Slotted Hammer

| Cat. No. |
|----------|
| MT-1901  |



## Femoral Options/Image Porous Hip System/Heads



# Reconstructive Surgery

## Hip Systems

### Oxinium 12/14 Taper Femoral Heads

| Cat. No.  | Size | Neck Length |
|-----------|------|-------------|
| 7134-2200 | 22mm | +0          |
| 7134-2204 | 22mm | +4          |
| 7134-2208 | 22mm | +8          |
| 7134-2600 | 26mm | +0          |
| 7134-2604 | 26mm | +4          |
| 7134-2608 | 26mm | +8          |
| 7134-2803 | 28mm | -3          |
| 7134-2800 | 28mm | +0          |
| 7134-2804 | 28mm | +4          |
| 7134-2808 | 28mm | +8          |
| 7134-2812 | 28mm | +12         |
| 7134-2816 | 28mm | +16         |
| 7134-3203 | 32mm | -3          |
| 7134-3200 | 32mm | +0          |
| 7134-3204 | 32mm | +4          |
| 7134-3208 | 32mm | +8          |
| 7134-3212 | 32mm | +12         |
| 7134-3216 | 32mm | +16         |
| 7134-3603 | 36mm | -3          |
| 7134-3600 | 36mm | +0          |
| 7134-3604 | 36mm | +4          |
| 7134-3608 | 36mm | +8          |
| 7134-3612 | 36mm | +12         |



### Trial 12/14 Taper Femoral Heads

| Cat. No.  | Size | Neck Length | Color Code |
|-----------|------|-------------|------------|
| 7135-2608 | 26mm | +8          | White      |
| 7135-2612 | 26mm | +12         | Blue       |
| 7135-2803 | 28mm | -3          | Green      |
| 7135-2800 | 28mm | +0          | Yellow     |
| 7135-2804 | 28mm | +4          | Red        |
| 7135-2808 | 28mm | +8          | White      |
| 7135-2812 | 28mm | +12         | Blue       |
| 7135-2816 | 28mm | +16         | Black      |
| 7135-3203 | 32mm | -3          | Green      |
| 7135-3200 | 32mm | +0          | Yellow     |
| 7135-3204 | 32mm | +4          | Red        |
| 7135-3208 | 32mm | +8          | White      |
| 7135-3212 | 32mm | +12         | Blue       |
| 7135-3216 | 32mm | +16         | Black      |
| 7135-3603 | 36mm | -3          | Green      |
| 7135-3600 | 36mm | +0          | Yellow     |
| 7135-3604 | 36mm | +4          | Red        |
| 7135-3608 | 36mm | +8          | White      |
| 7135-3612 | 36mm | +12         | Blue       |

### Femoral Options/Image Porous Hip System/Implants

### Trial 12/14 Taper Femoral Heads



| Cat. No.  | Size | Neck Length | Color Code |
|-----------|------|-------------|------------|
| 7135-2200 | 22mm | +0          | Yellow     |
| 7135-2204 | 22mm | +4          | Red        |
| 7135-2208 | 22mm | +8          | White      |
| 7135-2212 | 22mm | +12         | Blue       |
| 7135-2600 | 26mm | +0          | Yellow     |
| 7135-2604 | 26mm | +4          | Red        |

### Image Porous

| Cat. No.  | Size |       |
|-----------|------|-------|
| 7130-8209 | 9mm  | Right |
| 7130-8210 | 10mm | Right |
| 7130-8211 | 11mm | Right |
| 7130-8212 | 12mm | Right |
| 7130-8213 | 13mm | Right |
| 7130-8214 | 14mm | Right |
| 7130-8215 | 15mm | Right |
| 7130-8216 | 16mm | Right |
| 7130-8217 | 17mm | Right |
| 7130-8218 | 18mm | Right |
| 7130-8109 | 9mm  | Left  |
| 7130-8110 | 10mm | Left  |
| 7130-8111 | 11mm | Left  |
| 7130-8112 | 12mm | Left  |
| 7130-8114 | 14mm | Left  |
| 7130-8113 | 13mm | Left  |
| 7130-8115 | 15mm | Left  |
| 7130-8116 | 16mm | Left  |



## Image Porous

| Cat. No.  | Size |      |
|-----------|------|------|
| 7130-8117 | 17mm | Left |
| 7130-8118 | 18mm | Left |

## Femoral Options/Image Porous Hip System/Instruments

### Anteversion Handle (2 per set)

| Cat. No.  |
|-----------|
| 7136-4012 |



### Box Osteotome

| Cat. No.  |
|-----------|
| 7136-4002 |



### Broach Handle (2 per set)

| Cat. No.  |
|-----------|
| 7136-4007 |



## Broaches

| Cat. No.  | Size |       |
|-----------|------|-------|
| 7609-8171 | 9mm  | Right |
| 7609-8172 | 10mm | Right |
| 7609-8173 | 11mm | Right |
| 7609-8174 | 12mm | Right |
| 7609-8175 | 13mm | Right |
| 7609-8176 | 14mm | Right |
| 7609-8177 | 15mm | Right |
| 7609-8178 | 16mm | Right |
| 7609-8179 | 17mm | Right |
| 7609-8180 | 18mm | Right |
| 7609-8182 | 9mm  | Left  |



## Broaches

| Cat. No.  | Size |      |
|-----------|------|------|
| 7609-8183 | 10mm | Left |
| 7609-8184 | 11mm | Left |
| 7609-8185 | 12mm | Left |
| 7609-8186 | 13mm | Left |
| 7609-8187 | 14mm | Left |
| 7609-8188 | 15mm | Left |
| 7609-8189 | 16mm | Left |
| 7609-8190 | 17mm | Left |
| 7609-8191 | 18mm | Left |

## Calcar Reamer

| Cat. No.  | Size  |
|-----------|-------|
| 7136-4004 | Small |
| 7136-4005 | Large |



## Femoral Canal Finder

| Cat. No.  |
|-----------|
| 7136-4001 |



## Femoral Head Impactor

| Cat. No.  |
|-----------|
| 7136-4009 |



## Instrument Trays

(Not shown)

| Cat. No.  |             |
|-----------|-------------|
| 7197-6031 | Tray #1     |
| 7197-6032 | Tray #2     |
| 7197-6033 | Tray #3     |
| 7197-6034 | Reamer Tray |

## Osteotomy Guide

| Cat. No.  |
|-----------|
| 7136-4000 |



# Reconstructive Surgery

## Hip Systems

### Rigid Reamer

| Cat. No.  | Size |
|-----------|------|
| 7136-0209 | 9mm  |
| 7136-0210 | 10mm |
| 7136-0211 | 11mm |
| 7136-0212 | 12mm |
| 7136-0213 | 13mm |
| 7136-0214 | 14mm |
| 7136-0215 | 15mm |
| 7136-0216 | 16mm |
| 7136-0217 | 17mm |
| 7136-0218 | 18mm |



### Stem Inserter Frame

| Cat. No.  |
|-----------|
| 7136-4008 |



### Stem Inserter Pommel

| Cat. No.  |
|-----------|
| 7136-4011 |



### T-Handle

| Cat. No.  |
|-----------|
| 7136-4006 |



### Trial Neck

| Cat. No.  | Size  |
|-----------|-------|
| 7136-6408 | 8-13  |
| 7136-6414 | 14-18 |



### Acetabular Options/Acetabular

### Shells/Reflection All-Poly

#### Reflection All-Poly Cup



| Cat. No.  | O.D. (mm) | I.D. (mm) |
|-----------|-----------|-----------|
| 7135-2240 | 40        | 22        |
| 7135-2243 | 43        | 22        |
| 7135-2246 | 46        | 22        |
| 7135-2249 | 49        | 22        |
| 7135-2252 | 52        | 22        |
| 7135-2255 | 55        | 22        |
| 7135-2258 | 58        | 22        |
| 7135-2261 | 61        | 22        |
| 7135-2846 | 46        | 28        |
| 7135-2849 | 49        | 28        |
| 7135-2852 | 52        | 28        |
| 7135-2855 | 55        | 28        |
| 7135-2858 | 58        | 28        |
| 7135-2861 | 61        | 28        |
| 7135-3249 | 49        | 32        |
| 7135-3252 | 52        | 32        |
| 7135-3255 | 55        | 32        |
| 7135-3258 | 58        | 32        |
| 7135-3261 | 61        | 32        |

#### XLPE All-Poly Cup

(Not shown)

| Cat. No.  | Femoral Head Size | O.D. (mm) |
|-----------|-------------------|-----------|
| 7135-8001 | 22mm              | 40        |
| 7135-8002 | 22mm              | 43        |
| 7135-8003 | 22mm              | 46        |
| 7135-8004 | 22mm              | 49        |
| 7135-8005 | 22mm              | 52        |
| 7135-8006 | 22mm              | 55        |
| 7135-8007 | 22mm              | 58        |
| 7135-8008 | 22mm              | 61        |
| 7135-8023 | 28mm              | 46        |
| 7135-8024 | 28mm              | 49        |
| 7135-8025 | 28mm              | 52        |
| 7135-8026 | 28mm              | 55        |
| 7135-8027 | 28mm              | 58        |

## XLPE All-Poly Cup

| Cat. No.  | Femoral Head Size | O.D. (mm) |
|-----------|-------------------|-----------|
| 7135-8028 | 28mm              | 61        |
| 7135-8034 | 32mm              | 49        |
| 7135-8035 | 32mm              | 51        |
| 7135-8036 | 32mm              | 55        |
| 7135-8037 | 32mm              | 58        |
| 7135-8038 | 32mm              | 61        |

## Acetabular Options/Acetabular Shells/Reflection Ceramic

### Reflection Ceramic Acetabular Shells; FSO 5 (Not shown)

| Cat. No.  | O.D. (mm) |
|-----------|-----------|
| 7133-9046 | 46        |
| 7133-9048 | 48        |
| 7133-9050 | 50        |
| 7133-9052 | 52        |
| 7133-9054 | 54        |
| 7133-9056 | 56        |
| 7133-9058 | 58        |
| 7133-9060 | 60        |
| 7133-9062 | 62        |
| 7133-9064 | 64        |
| 7133-9066 | 66        |

### Reflection Ceramic Acetabular Shells; InterFit (Not shown)

| Cat. No.  | O.D. (mm) |
|-----------|-----------|
| 7133-8046 | 46        |
| 7133-8048 | 48        |
| 7133-8050 | 50        |
| 7133-8052 | 52        |
| 7133-8054 | 54        |
| 7133-8056 | 56        |
| 7133-8058 | 58        |
| 7133-8060 | 60        |
| 7133-8062 | 62        |
| 7133-8064 | 64        |
| 7133-8066 | 66        |

## Acetabular Options/Acetabular Shells/Reflection FSO

### Reflection FSO Shells; FSO3 & 5 Shell



| Cat. No.  | O.D. (mm) | Liner Size | Liner I.D. (mm) |
|-----------|-----------|------------|-----------------|
| 7133-0042 | 42        | B          | 22              |
| 7133-0044 | 44        | C          | 22, 26          |
| 7133-0046 | 46        | D          | 22, 26, 28      |
| 7133-0048 | 48        | D          | 22, 26, 28      |
| 7133-0050 | 50        | E          | 22, 26, 28, 32  |
| 7133-0052 | 52        | E          | 22, 26, 28, 32  |
| 7133-0054 | 54        | F          | 22, 26, 28, 32  |
| 7133-0056 | 56        | F          | 22, 26, 28, 32  |
| 7133-0058 | 58        | G          | 22, 26, 28, 32  |
| 7133-0060 | 60        | G          | 22, 26, 28, 32  |
| 7133-0062 | 62        | H          | 22, 26, 28, 32  |
| 7133-0064 | 64        | H          | 22, 26, 28, 32  |
| 7133-0066 | 66        | J          | 22, 26, 28, 32  |
| 7133-0068 | 68        | J          | 22, 26, 28, 32  |

### Reflection FSO Shells; FSO9 Shell



| Cat. No.  | O.D. (mm) | Liner Size | Liner I.D. (mm) |
|-----------|-----------|------------|-----------------|
| 7133-1050 | 50        | E          | 22, 26, 28, 32  |
| 7133-1052 | 52        | E          | 22, 26, 28, 32  |
| 7133-1054 | 54        | F          | 22, 26, 28, 32  |
| 7133-1056 | 56        | F          | 22, 26, 28, 32  |
| 7133-1058 | 58        | G          | 22, 26, 28, 32  |
| 7133-1060 | 60        | G          | 22, 26, 28, 32  |
| 7133-1062 | 62        | H          | 22, 26, 28, 32  |
| 7133-1064 | 64        | H          | 22, 26, 28, 32  |
| 7133-1066 | 66        | J          | 22, 26, 28, 32  |
| 7133-1068 | 68        | J          | 22, 26, 28, 32  |
| 7133-1070 | 70        | K          | 22, 26, 28, 32  |
| 7133-1072 | 72        | K          | 22, 26, 28, 32  |
| 7133-1074 | 74        | K          | 22, 26, 28, 32  |
| 7133-1076 | 76        | K          | 22, 26, 28, 32  |

### Acetabular Options/Acetabular Shells/Reflection InterFit

#### InterFit Multihole



| Cat. No.  | O.D. (mm) | Liner Size | Liner I.D. (mm)    |
|-----------|-----------|------------|--------------------|
| 7133-5050 | 50        | E          | 22, 26, 28, 32     |
| 7133-5052 | 52        | E          | 22, 26, 28, 32     |
| 7133-5054 | 54        | F          | 22, 26, 28, 32, 36 |
| 7133-5056 | 56        | F          | 22, 26, 28, 32, 36 |
| 7133-5058 | 58        | G          | 22, 26, 28, 32, 36 |
| 7133-5060 | 60        | G          | 22, 26, 28, 32, 36 |
| 7133-5062 | 62        | H          | 22, 26, 28, 32, 36 |
| 7133-5064 | 64        | H          | 22, 26, 28, 32, 36 |
| 7133-5066 | 66        | J          | 22, 26, 28, 32, 36 |
| 7133-5068 | 68        | J          | 22, 26, 28, 32, 36 |
| 7133-5070 | 70        | K          | 22, 26, 28, 32, 36 |
| 7133-5072 | 72        | K          | 22, 26, 28, 32, 36 |
| 7133-5074 | 74        | K          | 22, 26, 28, 32, 36 |
| 7133-5076 | 76        | K          | 22, 26, 28, 32, 36 |

#### InterFit No Hole



| Cat. No.  | O.D. (mm) | Liner Size | Liner I.D. (mm)    |
|-----------|-----------|------------|--------------------|
| 7133-4042 | 42        | B          | 22                 |
| 7133-4044 | 44        | C          | 22, 26             |
| 7133-4046 | 46        | D          | 22, 26, 28         |
| 7133-4048 | 48        | D          | 22, 26, 28         |
| 7133-4050 | 50        | E          | 22, 26, 28, 32     |
| 7133-4052 | 52        | E          | 22, 26, 28, 32     |
| 7133-4054 | 54        | F          | 22, 26, 28, 32, 36 |
| 7133-4056 | 56        | F          | 22, 26, 28, 32, 36 |
| 7133-4058 | 58        | G          | 22, 26, 28, 32, 36 |
| 7133-4060 | 60        | G          | 22, 26, 28, 32, 36 |
| 7133-4062 | 62        | H          | 22, 26, 28, 32, 36 |
| 7133-4064 | 64        | H          | 22, 26, 28, 32, 36 |

#### InterFit No Hole

| Cat. No.  | O.D. (mm) | Liner Size | Liner I.D. (mm)    |
|-----------|-----------|------------|--------------------|
| 7133-4066 | 66        | J          | 22, 26, 28, 32, 36 |
| 7133-4068 | 68        | J          | 22, 26, 28, 32, 36 |

#### InterFit Three Hole



| Cat. No.  | O.D. (mm) | Liner Size | Liner I.D. (mm)    |
|-----------|-----------|------------|--------------------|
| 7133-6042 | 42        | B          | 22                 |
| 7133-6044 | 44        | C          | 22, 26             |
| 7133-6046 | 46        | D          | 22, 26, 28         |
| 7133-6048 | 48        | D          | 22, 26, 28         |
| 7133-6050 | 50        | E          | 22, 26, 28, 32     |
| 7133-6052 | 52        | E          | 22, 26, 28, 32     |
| 7133-6054 | 54        | F          | 22, 26, 28, 32, 36 |
| 7133-6056 | 56        | F          | 22, 26, 28, 32, 36 |
| 7133-6058 | 58        | G          | 22, 26, 28, 32, 36 |
| 7133-6060 | 60        | G          | 22, 26, 28, 32, 36 |
| 7133-6062 | 62        | H          | 22, 26, 28, 32, 36 |
| 7133-6064 | 64        | H          | 22, 26, 28, 32, 36 |
| 7133-6066 | 66        | J          | 22, 26, 28, 32, 36 |
| 7133-6068 | 68        | J          | 22, 26, 28, 32, 36 |

### Acetabular Options/Acetabular Shells/Reflection NH

#### Reflection HA No-Hole Shells



| Cat. No.  | O.D. (mm) | Liner Size |
|-----------|-----------|------------|
| 7133-4246 | 46        | D          |
| 7133-4248 | 48        | D          |
| 7133-4250 | 50        | E          |
| 7133-4252 | 52        | E          |
| 7133-4254 | 54        | F          |

## Reflection HA No-Hole Shells

| Cat. No.  | O.D. (mm) | Liner Size |
|-----------|-----------|------------|
| 7133-4256 | 56        | F          |
| 7133-4258 | 58        | G          |
| 7133-4260 | 60        | G          |
| 7133-4262 | 62        | H          |
| 7133-4264 | 64        | H          |

## Reflection No-Hole Shells



| Cat. No.  | O.D. | Liner Size |
|-----------|------|------------|
| 7133-4146 | 46   | D          |
| 7133-4148 | 48   | D          |
| 7133-4150 | 50   | E          |
| 7133-4152 | 52   | E          |
| 7133-4154 | 54   | F          |
| 7133-4156 | 56   | F          |
| 7133-4158 | 58   | G          |
| 7133-4160 | 60   | G          |
| 7133-4162 | 62   | H          |
| 7133-4164 | 64   | H          |

## Acetabular Options/Acetabular Shells/Reflection SP3

### Reflection HA 3-Hole Shells



| Cat. No.  | O.D. (mm) | Liner Size |
|-----------|-----------|------------|
| 7133-6246 | 46        | D          |
| 7133-6248 | 48        | D          |
| 7133-6250 | 50        | E          |
| 7133-6252 | 52        | E          |
| 7133-6254 | 54        | F          |
| 7133-6256 | 56        | F          |
| 7133-6258 | 58        | G          |
| 7133-6260 | 60        | G          |

## Reflection HA 3-Hole Shells

| Cat. No.  | O.D. (mm) | Liner Size |
|-----------|-----------|------------|
| 7133-6262 | 62        | H          |
| 7133-6264 | 64        | H          |

## Reflection SP3 3-Hole Shells



| Cat. No.  | O.D. (mm) | Liner Size | Size     |
|-----------|-----------|------------|----------|
| 7133-6440 | 40        | A          | Small    |
| 7133-6442 | 42        | B          | Small    |
| 7133-6444 | 44        | C          | Small    |
| 7133-6246 | 46        | D          | Standard |
| 7133-6248 | 48        | D          | Standard |
| 7133-6250 | 50        | E          | Standard |
| 7133-6252 | 52        | E          | Standard |
| 7133-6254 | 54        | F          | Standard |
| 7133-6256 | 56        | F          | Standard |
| 7133-6258 | 58        | G          | Standard |
| 7133-6260 | 60        | G          | Standard |
| 7133-6262 | 62        | H          | Standard |
| 7133-6264 | 64        | H          | Standard |
| 7133-6466 | 66        | J          | Large    |
| 7133-6468 | 68        | J          | Large    |

## Acetabular Options/Acetabular Shells/Reflection Spiked

### Reflection Spiked Shells



| Cat. No.  | O.D. | Liner Size | Size  |
|-----------|------|------------|-------|
| 7133-6340 | 40   | A          | Small |
| 7133-6342 | 42   | B          | Small |
| 7133-6344 | 44   | C          | Small |

# Reconstructive Surgery

## Hip Systems

### Reflection Spiked Shells

| Cat. No.  | O.D. | Liner Size | Size     |
|-----------|------|------------|----------|
| 7133-6346 | 46   | D          | Standard |
| 7133-6348 | 48   | D          | Standard |
| 7133-6350 | 50   | E          | Standard |
| 7133-6352 | 52   | E          | Standard |
| 7133-6354 | 54   | F          | Standard |
| 7133-6356 | 56   | F          | Standard |
| 7133-6358 | 58   | G          | Standard |
| 7133-6360 | 60   | G          | Standard |
| 7133-6362 | 62   | H          | Standard |
| 7133-6364 | 64   | H          | Standard |
| 7133-6366 | 66   | j          | Large    |
| 7133-6368 | 68   | J          | Large    |

### Acetabular Options/Acetabular Liners/Reflection Acetabular Liners

#### Reflection Acetabular Liners; 0° Liner



| Cat. No.  | I.D. (mm) | O.D. (mm) | Liner Size |
|-----------|-----------|-----------|------------|
| 7174-2042 | 22        | 42        | B          |
| 7174-2044 | 22        | 44        | C          |
| 7174-2046 | 22        | 46-48     | D          |
| 7174-2050 | 22        | 50-52     | E          |
| 7174-2054 | 22        | 54-56     | F          |
| 7174-2058 | 22        | 58-60     | G          |
| 7174-0644 | 26        | 44        | C          |
| 7174-0646 | 26        | 46-48     | D          |
| 7174-0650 | 26        | 50-52     | E          |
| 7174-0654 | 26        | 54-56     | F          |
| 7174-0658 | 26        | 58-60     | G          |
| 7174-0846 | 28        | 46-48     | D          |
| 7174-0850 | 28        | 50-52     | E          |
| 7174-0854 | 28        | 54-56     | F          |
| 7174-0858 | 28        | 58-60     | G          |
| 7174-0862 | 28        | 62-64     | H          |
| 7174-0866 | 28        | 66-68     | J          |
| 7174-0870 | 28        | 70-76     | K          |
| 7174-0250 | 32        | 50-52     | E          |
| 7174-0254 | 32        | 54-56     | F          |
| 7174-0258 | 32        | 58-60     | G          |
| 7174-0262 | 32        | 62-64     | H          |
| 7174-0266 | 32        | 66-68     | J          |

#### Reflection Acetabular Liners; 0° Liner

| Cat. No.  | I.D. (mm) | O.D. (mm) | Liner Size |
|-----------|-----------|-----------|------------|
| 7174-0270 | 32        | 70-76     | K          |

#### Reflection Acetabular Liners; 20° Liner



| Cat. No.  | I.D. (mm) | O.D. (mm) | Liner Size |
|-----------|-----------|-----------|------------|
| 7174-2242 | 22        | 42        | B          |
| 7174-2244 | 22        | 44        | C          |
| 7174-2246 | 22        | 46-48     | D          |
| 7174-2250 | 22        | 50-52     | E          |
| 7174-2254 | 22        | 54-56     | F          |
| 7174-2258 | 22        | 58-60     | G          |
| 7174-2644 | 26        | 44        | C          |
| 7174-2646 | 26        | 46-48     | D          |
| 7174-2650 | 26        | 50-52     | E          |
| 7174-2654 | 26        | 54-56     | F          |
| 7174-2658 | 26        | 58-60     | G          |
| 7174-2846 | 28        | 46-48     | D          |
| 7174-2850 | 28        | 50-52     | E          |
| 7174-2854 | 28        | 54-56     | F          |
| 7174-2858 | 28        | 58-60     | G          |
| 7174-2862 | 28        | 62-64     | H          |
| 7174-2866 | 28        | 66-68     | J          |
| 7174-2870 | 28        | 70-76     | K          |
| 7174-3250 | 32        | 50-52     | E          |
| 7174-3254 | 32        | 54-56     | F          |
| 7174-3258 | 32        | 58-60     | G          |
| 7174-3262 | 32        | 62-64     | H          |
| 7174-3266 | 32        | 66-68     | J          |
| 7174-3270 | 32        | 70-76     | K          |

### Acetabular Options/Acetabular Liners/Reflection Lateralized Liners (+4mm)

#### Reflection Lateralized Liners (+4mm); 0° Liner



| Cat. No.  | I.D. | O.D.  | Liner Size |
|-----------|------|-------|------------|
| 7133-0446 | 28   | 46-48 | D          |

### Reflection Lateralized Liners (+4mm); 0° Liner

| Cat. No.  | I.D. | O.D.  | Liner Size |
|-----------|------|-------|------------|
| 7133-0450 | 28   | 50-52 | E          |
| 7133-0454 | 28   | 54-56 | F          |
| 7133-0458 | 28   | 58-60 | G          |
| 7133-0462 | 28   | 62-64 | H          |
| 7133-0466 | 28   | 66-68 | J          |
| 7133-0470 | 28   | 70-76 | K          |

### Reflection Lateralized Liners (+4mm); 20° Liner



| Cat. No.  | I.D. | O.D.  | Liner Size |
|-----------|------|-------|------------|
| 7133-2446 | 28   | 46-48 | D          |
| 7133-2450 | 28   | 50-52 | E          |
| 7133-2454 | 28   | 54-56 | F          |
| 7133-2458 | 28   | 58-60 | G          |
| 7133-2462 | 28   | 62-64 | H          |
| 7133-2466 | 28   | 66-68 | J          |
| 7133-2470 | 28   | 70-76 | K          |

### Acetabular Options/Acetabular Liners/XLPE Acetabular Liners

#### XLPE Acetabular 0° Liners



| Cat. No.  | I.D. (mm) | O.D. (mm) | Liner Size |
|-----------|-----------|-----------|------------|
| 7133-3351 | 22        | 42        | B          |
| 7133-3352 | 22        | 44        | C          |
| 7133-3353 | 22        | 46-48     | D          |
| 7133-3354 | 22        | 50-52     | E          |
| 7133-3355 | 22        | 54-56     | F          |
| 7133-3356 | 22        | 58-60     | G          |
| 7133-3357 | 22        | 62-64     | H          |
| 7133-3358 | 22        | 66-68     | J          |
| 7133-3359 | 22        | 70-76     | K          |
| 7133-3362 | 26        | 44        | C          |
| 7133-3363 | 26        | 46-48     | D          |

### XLPE Acetabular 0° Liners

| Cat. No.  | I.D. (mm) | O.D. (mm) | Liner Size |
|-----------|-----------|-----------|------------|
| 7133-3364 | 26        | 50-52     | E          |
| 7133-3365 | 26        | 54-56     | F          |
| 7133-3366 | 26        | 58-60     | G          |
| 7133-3367 | 26        | 62-64     | H          |
| 7133-3368 | 26        | 66-68     | J          |
| 7133-3369 | 26        | 70-76     | K          |
| 7133-3373 | 28        | 46-48     | D          |
| 7133-3374 | 28        | 50-52     | E          |
| 7133-3375 | 28        | 54-56     | F          |
| 7133-3376 | 28        | 58-60     | G          |
| 7133-3377 | 28        | 62-64     | H          |
| 7133-3378 | 28        | 66-68     | J          |
| 7133-3379 | 28        | 70-76     | K          |
| 7133-3384 | 32        | 50-52     | E          |
| 7133-3385 | 32        | 54-56     | F          |
| 7133-3386 | 32        | 58-60     | G          |
| 7133-3387 | 32        | 62-64     | H          |
| 7133-3388 | 32        | 66-68     | J          |
| 7133-3389 | 32        | 70-76     | K          |
| 7133-3395 | 36        | 54-56     | F          |
| 7133-3396 | 36        | 58-60     | G          |
| 7133-3397 | 36        | 62-64     | H          |
| 7133-3398 | 36        | 66-68     | J          |
| 7133-3399 | 36        | 70-76     | K          |

#### XLPE Acetabular 20° Liners



| Cat. No.  | I.D. (mm) | O.D. (mm) | Liner Size |
|-----------|-----------|-----------|------------|
| 7133-3301 | 22        | 42        | B          |
| 7133-3302 | 22        | 44        | C          |
| 7133-3303 | 22        | 46-48     | D          |
| 7133-3304 | 22        | 50-52     | E          |
| 7133-3305 | 22        | 54-56     | F          |
| 7133-3306 | 22        | 58-60     | G          |
| 7133-3307 | 22        | 62-64     | H          |
| 7133-3308 | 22        | 66-68     | J          |
| 7133-3309 | 22        | 70-76     | K          |
| 7133-3312 | 26        | 44        | C          |
| 7133-3313 | 26        | 46-48     | D          |
| 7133-3314 | 26        | 50-52     | E          |
| 7133-3315 | 26        | 54-56     | F          |
| 7133-3316 | 26        | 58-60     | G          |
| 7133-3317 | 26        | 62-64     | H          |
| 7133-3318 | 26        | 66-68     | J          |



# Reconstructive Surgery

## Hip Systems

### XLPE Acetabular 20° Liners

| Cat. No.  | I.D. (mm) | O.D. (mm) | Liner Size |
|-----------|-----------|-----------|------------|
| 7133-3319 | 26        | 70-76     | K          |
| 7133-3323 | 28        | 46-48     | D          |
| 7133-3324 | 28        | 50-52     | E          |
| 7133-3325 | 28        | 54-56     | F          |
| 7133-3326 | 28        | 58-60     | G          |
| 7133-3327 | 28        | 62-64     | H          |
| 7133-3328 | 28        | 66-68     | J          |
| 7133-3329 | 28        | 70-76     | K          |
| 7133-3334 | 32        | 50-52     | E          |
| 7133-3335 | 32        | 54-56     | F          |
| 7133-3336 | 32        | 58-60     | G          |
| 7133-3337 | 32        | 62-64     | H          |
| 7133-3338 | 32        | 66-68     | J          |
| 7133-3339 | 32        | 70-76     | K          |
| 7133-3345 | 36        | 54-56     | F          |
| 7133-3346 | 36        | 58-60     | G          |
| 7133-3347 | 36        | 62-64     | H          |
| 7133-3348 | 36        | 66-68     | J          |
| 7133-3349 | 36        | 70-76     | K          |

### XLPE Anteverted 20° Liners (+4mm)

| Cat. No.  | I.D. (mm) | O.D. (mm) | Liner Size |
|-----------|-----------|-----------|------------|
| 7133-3418 | 26        | 66-68     | J          |
| 7133-3419 | 26        | 70-76     | K          |
| 7133-3423 | 28        | 46-48     | D          |
| 7133-3424 | 28        | 50-52     | E          |
| 7133-3425 | 28        | 54-56     | F          |
| 7133-3426 | 28        | 58-60     | G          |
| 7133-3427 | 28        | 62-64     | H          |
| 7133-3428 | 28        | 66-68     | J          |
| 7133-3429 | 28        | 70-76     | K          |
| 7133-3434 | 32        | 50-52     | E          |
| 7133-3435 | 32        | 54-56     | F          |
| 7133-3436 | 32        | 58-60     | G          |
| 7133-3437 | 32        | 62-64     | H          |
| 7133-3438 | 32        | 66-68     | J          |
| 7133-3439 | 32        | 70-76     | K          |
| 7133-3445 | 36        | 54-56     | F          |
| 7133-3446 | 36        | 58-60     | G          |
| 7133-3447 | 36        | 62-64     | H          |
| 7133-3448 | 36        | 66-68     | J          |
| 7133-3449 | 36        | 70-76     | K          |

### Acetabular Options/Acetabular Liners/XLPE Lateralized/Anteverted Liners (+4mm)

#### XLPE Anteverted 20° Liners (+4mm)



| Cat. No.  | I.D. (mm) | O.D. (mm) | Liner Size |
|-----------|-----------|-----------|------------|
| 7133-3401 | 22        | 42        | B          |
| 7133-3402 | 22        | 44        | C          |
| 7133-3403 | 22        | 46-48     | D          |
| 7133-3404 | 22        | 50-52     | E          |
| 7133-3405 | 22        | 54-56     | F          |
| 7133-3406 | 22        | 58-60     | G          |
| 7133-3407 | 22        | 62-64     | H          |
| 7133-3408 | 22        | 66-68     | J          |
| 7133-3409 | 22        | 70-76     | K          |
| 7133-3412 | 26        | 44        | C          |
| 7133-3413 | 26        | 46-48     | D          |
| 7133-3414 | 26        | 50-52     | E          |
| 7133-3415 | 26        | 54-56     | F          |
| 7133-3416 | 26        | 58-60     | G          |
| 7133-3417 | 26        | 62-64     | H          |

#### XLPE Lateralized 0° Liners (+4mm)



| Cat. No.  | I.D. (mm) | O.D. (mm) | Liner Size |
|-----------|-----------|-----------|------------|
| 7133-3451 | 22        | 42        | B          |
| 7133-3452 | 22        | 44        | C          |
| 7133-3453 | 22        | 46-48     | D          |
| 7133-3454 | 22        | 50-52     | E          |
| 7133-3455 | 22        | 54-56     | F          |
| 7133-3456 | 22        | 58-60     | G          |
| 7133-3457 | 22        | 62-64     | H          |
| 7133-3458 | 22        | 66-68     | J          |
| 7133-3459 | 22        | 70-76     | K          |
| 7133-3462 | 26        | 44        | C          |
| 7133-3463 | 26        | 46-48     | D          |
| 7133-3464 | 26        | 50-52     | E          |
| 7133-3465 | 26        | 54-56     | F          |
| 7133-3466 | 26        | 58-60     | G          |
| 7133-3467 | 26        | 62-64     | H          |
| 7133-3468 | 26        | 66-68     | J          |
| 7133-3469 | 26        | 70-76     | K          |
| 7133-3473 | 28        | 46-48     | D          |

### XLPE Lateralized 0° Liners (+4mm)

| Cat. No.  | I.D. (mm) | O.D. (mm) | Liner Size |
|-----------|-----------|-----------|------------|
| 7133-3474 | 28        | 50-52     | E          |
| 7133-3475 | 28        | 54-56     | F          |
| 7133-3476 | 28        | 58-60     | G          |
| 7133-3477 | 28        | 62-64     | H          |
| 7133-3478 | 28        | 66-68     | J          |
| 7133-3479 | 28        | 70-76     | K          |
| 7133-3484 | 32        | 50-52     | E          |
| 7133-3485 | 32        | 54-56     | F          |
| 7133-3486 | 32        | 58-60     | G          |
| 7133-3487 | 32        | 62-64     | H          |
| 7133-3488 | 32        | 66-68     | J          |
| 7133-3489 | 32        | 70-76     | K          |
| 7133-3495 | 36        | 54-56     | F          |
| 7133-3496 | 36        | 58-60     | G          |
| 7133-3497 | 36        | 62-64     | H          |
| 7133-3498 | 36        | 66-68     | J          |
| 7133-3499 | 36        | 70-76     | K          |

### Reflection Anteverted Screw-in Trial Liners (+4mm); 20° Liner

| Cat. No.  | I.D. (mm) | O.D. (mm) | Liner Size |
|-----------|-----------|-----------|------------|
| 7136-2860 | 28        | 58-60     | G          |
| 7136-2864 | 28        | 62-64     | H          |
| 7136-2868 | 28        | 66-68     | J          |
| 7136-2872 | 28        | 70-76     | K          |
| 7136-3252 | 32        | 50-52     | E          |
| 7136-3256 | 32        | 54-56     | F          |
| 7136-3260 | 32        | 58-60     | G          |
| 7136-3264 | 32        | 62-64     | H          |
| 7136-3268 | 32        | 66-68     | J          |
| 7136-3272 | 32        | 70-76     | K          |
| 7136-3656 | 36        | 54-56     | F          |
| 7136-3660 | 36        | 58-60     | G          |
| 7136-3664 | 36        | 62-64     | H          |
| 7136-3668 | 36        | 66-68     | J          |
| 7136-3672 | 36        | 70-76     | K          |

### Acetabular Options/Acetabular Liners/Reflection Trial Liners

### Reflection Anteverted Screw-in Trial Liners (+4mm); 20° Liner

(Not shown)

| Cat. No.  | I.D. (mm) | O.D. (mm) | Liner Size |
|-----------|-----------|-----------|------------|
| 7136-2238 | 22        | 42        | B          |
| 7136-2239 | 22        | 44        | C          |
| 7136-2248 | 22        | 46-48     | D          |
| 7136-2252 | 22        | 50-52     | E          |
| 7136-2256 | 22        | 54-56     | F          |
| 7136-2260 | 22        | 58-60     | G          |
| 7136-2264 | 22        | 62-64     | H          |
| 7136-2268 | 22        | 66-68     | J          |
| 7136-2272 | 22        | 70-76     | K          |
| 7136-2635 | 26        | 44        | C          |
| 7136-2648 | 26        | 46-48     | D          |
| 7136-2652 | 26        | 50-52     | E          |
| 7136-2656 | 26        | 54-56     | F          |
| 7136-2660 | 26        | 58-60     | G          |
| 7136-2664 | 26        | 62-64     | H          |
| 7136-2668 | 26        | 66-68     | J          |
| 7136-2672 | 26        | 70-76     | K          |
| 7136-2848 | 28        | 46-48     | D          |
| 7136-2852 | 28        | 50-52     | E          |
| 7136-2856 | 28        | 54-56     | F          |

### Reflection Lateralized Screw-in Trial Liners (+4mm); 0° Liner

(Not shown)

| Cat. No.  | I.D. (mm) | O.D. (mm) | Liner Size |
|-----------|-----------|-----------|------------|
| 7136-2235 | 22        | 42        | B          |
| 7136-2236 | 22        | 44        | C          |
| 7136-2249 | 22        | 46-48     | D          |
| 7136-2253 | 22        | 50-52     | E          |
| 7136-2257 | 22        | 54-56     | F          |
| 7136-2261 | 22        | 58-60     | G          |
| 7136-2265 | 22        | 62-64     | H          |
| 7136-2269 | 22        | 66-68     | J          |
| 7136-2273 | 22        | 70-76     | K          |
| 7136-2636 | 26        | 44        | C          |
| 7136-2649 | 26        | 46-48     | D          |
| 7136-2653 | 26        | 50-52     | E          |
| 7136-2657 | 26        | 54-56     | F          |
| 7136-2661 | 26        | 58-60     | G          |
| 7136-2665 | 26        | 62-64     | H          |
| 7136-2669 | 26        | 66-68     | J          |
| 7136-2673 | 26        | 70-76     | K          |
| 7136-2849 | 28        | 46-48     | D          |
| 7136-2853 | 28        | 50-52     | E          |
| 7136-2857 | 28        | 54-56     | F          |
| 7136-2861 | 28        | 58-60     | G          |
| 7136-2865 | 28        | 62-64     | H          |
| 7136-2869 | 28        | 66-68     | J          |
| 7136-2873 | 28        | 70-76     | K          |
| 7136-3253 | 32        | 50-52     | E          |
| 7136-3257 | 32        | 54-56     | F          |

# Reconstructive Surgery

## Hip Systems

### Reflection Lateralized Screw-in Trial Liners (+4mm); 0° Liner

| Cat. No.  | I.D. (mm) | O.D. (mm) | Liner Size |
|-----------|-----------|-----------|------------|
| 7136-3261 | 32        | 58-60     | G          |
| 7136-3265 | 32        | 62-64     | H          |
| 7136-3269 | 32        | 66-68     | J          |
| 7136-3273 | 32        | 70-76     | K          |
| 7136-3657 | 36        | 54-56     | F          |
| 7136-3661 | 36        | 58-60     | G          |
| 7136-3665 | 36        | 62-64     | H          |
| 7136-3669 | 36        | 66-68     | J          |
| 7136-3673 | 36        | 70-76     | K          |

### Reflection Screw-in Trial Liners; 0° Liner

| Cat. No.  | I.D. (mm) | O.D. (mm) | Liner Size |
|-----------|-----------|-----------|------------|
| 7136-3263 | 32        | 62-64     | H          |
| 7136-3267 | 32        | 66-68     | J          |
| 7136-3271 | 32        | 70-76     | K          |
| 7136-3655 | 36        | 54-56     | F          |
| 7136-3659 | 36        | 58-60     | G          |
| 7136-3663 | 36        | 62-64     | H          |
| 7136-3667 | 36        | 66-68     | J          |
| 7136-3671 | 36        | 70-76     | K          |

### Reflection Screw-in Trial Liners; 0° Liner



| Cat. No.  | I.D. (mm) | O.D. (mm) | Liner Size |
|-----------|-----------|-----------|------------|
| 7136-2241 | 22        | 40        | A          |
| 7136-2243 | 22        | 42        | B          |
| 7136-2245 | 22        | 44        | C          |
| 7136-2247 | 22        | 46-48     | D          |
| 7136-2251 | 22        | 50-52     | E          |
| 7136-2255 | 22        | 54-56     | F          |
| 7136-2259 | 22        | 58-60     | G          |
| 7136-2263 | 22        | 62-64     | H          |
| 7136-2267 | 22        | 66-68     | J          |
| 7136-2271 | 22        | 70-76     | K          |
| 7136-2645 | 26        | 44        | C          |
| 7136-2647 | 26        | 46-48     | D          |
| 7136-2651 | 26        | 50-52     | E          |
| 7136-2655 | 26        | 54-56     | F          |
| 7136-2659 | 26        | 58-60     | G          |
| 7136-2663 | 26        | 62-64     | H          |
| 7136-2667 | 26        | 66-68     | J          |
| 7136-2671 | 26        | 70-76     | K          |
| 7136-2847 | 28        | 46-48     | D          |
| 7136-2851 | 28        | 50-52     | E          |
| 7136-2855 | 28        | 54-56     | F          |
| 7136-2859 | 28        | 58-60     | G          |
| 7136-2863 | 28        | 62-64     | H          |
| 7136-2867 | 28        | 66-68     | J          |
| 7136-2871 | 28        | 70-76     | K          |
| 7136-3251 | 32        | 50-52     | E          |
| 7136-3255 | 32        | 54-56     | F          |
| 7136-3259 | 32        | 58-60     | G          |

### Reflection Screw-in Trial Liners; 20° Liner



| Cat. No.  | I.D. (mm) | O.D. (mm) | Liner Size |
|-----------|-----------|-----------|------------|
| 7136-2240 | 22        | 40        | A          |
| 7136-2242 | 22        | 42        | B          |
| 7136-2244 | 22        | 44        | C          |
| 7136-2246 | 22        | 46-48     | D          |
| 7136-2250 | 22        | 50-52     | E          |
| 7136-2254 | 22        | 54-56     | F          |
| 7136-2258 | 22        | 58-60     | G          |
| 7136-2262 | 22        | 62-64     | H          |
| 7136-2266 | 22        | 66-68     | J          |
| 7136-2270 | 22        | 70-76     | K          |
| 7136-2644 | 26        | 44        | C          |
| 7136-2646 | 26        | 46-48     | D          |
| 7136-2650 | 26        | 50-52     | E          |
| 7136-2654 | 26        | 54-56     | F          |
| 7136-2658 | 26        | 58-60     | G          |
| 7136-2662 | 26        | 62-64     | H          |
| 7136-2666 | 26        | 66-68     | J          |
| 7136-2670 | 26        | 70-76     | K          |
| 7136-2846 | 28        | 46-48     | D          |
| 7136-2850 | 28        | 50-52     | E          |
| 7136-2854 | 28        | 54-56     | F          |
| 7136-2858 | 28        | 58-60     | G          |
| 7136-2862 | 28        | 62-64     | H          |
| 7136-2866 | 28        | 66-68     | J          |
| 7136-2870 | 28        | 70-76     | K          |
| 7136-3250 | 32        | 50-52     | E          |
| 7136-3254 | 32        | 54-56     | F          |
| 7136-3258 | 32        | 58-60     | G          |
| 7136-3262 | 32        | 62-64     | H          |
| 7136-3266 | 32        | 66-68     | J          |

## Reflection Screw-in Trial Liners; 20° Liner

| Cat. No.  | I.D. (mm) | O.D. (mm) | Liner Size |
|-----------|-----------|-----------|------------|
| 7136-3270 | 32        | 70-76     | K          |
| 7136-3654 | 36        | 54-56     | F          |
| 7136-3658 | 36        | 58-60     | G          |
| 7136-3662 | 36        | 62-64     | H          |
| 7136-3666 | 36        | 66-68     | J          |
| 7136-3670 | 36        | 70-76     | K          |

## Acetabular Options/Instruments/Contour Instruments

### Contour Flange Bender

Cat. No.  
7136-7001



\*Contour Requires Reflection Instrumentation

### Contour Instrument Tray

Cat. No.  
7136-7000

(Not shown)

\*Contour Requires Reflection Instrumentation

### Impaction Domes

| Cat. No.  | Desc. |
|-----------|-------|
| 7136-7341 | 41mm  |
| 7136-7344 | 44mm  |
| 7136-7347 | 47mm  |
| 7136-7350 | 50mm  |
| 7136-7353 | 53mm  |
| 7136-7356 | 56mm  |
| 7136-7359 | 59mm  |
| 7136-7362 | 62mm  |
| 7136-7365 | 65mm  |
| 7136-7368 | 68mm  |



\*Contour Requires Reflection Instrumentation

## Impactor Dome Tray

Cat. No.  
7136-7004



\*Contour Requires Reflection Instrumentation

## T-Handle

Cat. No.  
7136-4006



## Twist Drill, 3.2mm

Cat. No.  
21-0442



\*Contour Requires Reflection Instrumentation

## Vice Grip Pliers

Cat. No.  
7136-7537



\*Contour Requires Reflection Instrumentation

## Acetabular Options/Instruments/Other Instruments

# Reconstructive Surgery

## Hip Systems

### Dead Blow Mallet

Cat. No.  
7136-2106



### Peg Removal Tool

Cat. No.  
73-2127



### Flexible Screw Drills

| Cat. No.  | Length |
|-----------|--------|
| 7136-2915 | 15     |
| 7136-2925 | 25     |
| 7136-2935 | 35     |
| 7136-2950 | 50     |



### Positioner/Impactor Replacement Tip

Cat. No.  
73-2108



### InterFit Threaded Hole Cover

Cat. No.  
7133-0001



### Reflection Angled Peg Impactor

Cat. No.  
73-2117



### Modular Drill Bit

(Not shown)

| Cat. No.  | Length |
|-----------|--------|
| 7136-2515 | 15     |
| 7136-2520 | 20     |
| 7136-2525 | 25     |
| 7136-2530 | 30     |
| 7136-2535 | 35     |
| 7136-2540 | 40     |
| 7136-2545 | 45     |
| 7136-2550 | 50     |
| 7136-2560 | 60     |
| 7136-2570 | 70     |

### Reflection Captured Flexible Screwdriver Shaft

Cat. No.  
7136-2291



### Reflection Captured U-Joint Screwdriver Shaft

Cat. No.  
7136-2292



### Reflection Flexible Peg Drill

Cat. No.  
7136-2918



### Peg Removal Pin

Cat. No.  
73-2129



### Reflection Flexible Screwdriver Shaft

Cat. No.  
7136-2290



## Reflection Locking Head Peg

Cat. No. [Redacted]  
7133-2518



## Reflection Additional Trial Liner Tray (Not shown)

Cat. No. [Redacted]  
7136-2283

## Reflection Screw Hole Cover

Cat. No. [Redacted]  
7133-2500



## Acetabular Brush

6 per box  
(Not shown)

Cat. No. [Redacted]  
11-0032

\*All-Poly Requires Reflection Instrumentation

## Reflection Spherical Head Screws

| Cat. No.  | Length |
|-----------|--------|
| 7133-2515 | 15     |
| 7133-2520 | 20     |
| 7133-2525 | 25     |
| 7133-2530 | 30     |
| 7133-2535 | 35     |
| 7133-2540 | 40     |
| 7133-2545 | 45     |
| 7133-2550 | 50     |
| 7133-2560 | 60     |
| 7133-2570 | 70     |



## Acetabular Cement Compressor (Not shown)

Cat. No. [Redacted]  
11-1430

\*All-Poly Requires Reflection Instrumentation

## Reflection Tapered Hole Cover Inserter

Cat. No. [Redacted]  
73-2133



## Reflection Trial Shell Handle

Cat. No. [Redacted]  
7136-2297



## Acetabular Reamer Dome

| Cat. No. | Size (mm) |
|----------|-----------|
| 41-7138  | 38        |
| 41-7139  | 39        |
| 41-7140  | 40        |
| 41-7141  | 41        |
| 41-7142  | 42        |
| 41-7143  | 43        |
| 41-7144  | 44        |
| 41-7145  | 45        |
| 41-7146  | 46        |
| 41-7147  | 47        |
| 41-7148  | 48        |
| 41-7149  | 49        |
| 41-7150  | 50        |
| 41-7151  | 51        |
| 41-7152  | 52        |
| 41-7153  | 53        |
| 41-7154  | 54        |
| 41-7155  | 55        |
| 41-7156  | 56        |
| 41-7157  | 57        |



## Acetabular Options/Instruments/Reflection Additional Trial Liner Tray

# Reconstructive Surgery

## Hip Systems

### Acetabular Reamer Dome

| Cat. No. | Size (mm) |
|----------|-----------|
| 41-7158  | 58        |
| 41-7159  | 59        |
| 41-7160  | 60        |
| 41-7161  | 61        |

\*All-Poly Requires Reflection Instrumentation

### Acetabular Reamer Handle

(Not shown)

| Cat. No. |
|----------|
| 11-4265  |

\*All-Poly Requires Reflection Instrumentation

### All-Poly Cup Instrument Tray

| Cat. No.  |
|-----------|
| 7136-2110 |

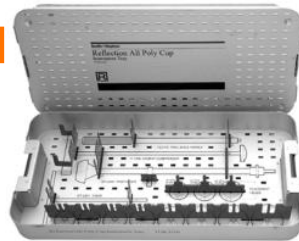

\*All-Poly Requires Reflection Instrumentation

### Concise Cement Sculps Kit

(Not shown)

| Cat. No. |
|----------|
| 11-1000  |

\*All-Poly Requires Reflection Instrumentation

### Disposable Acetabular Cement Compressor Cap with Shield

5 per box

| Cat. No. | Size              |
|----------|-------------------|
| 11-1431  | Small, 54mm dia.  |
| 11-1432  | Medium, 62mm dia. |
| 11-1433  | Large, 70mm dia.  |



\*All-Poly Requires Reflection Instrumentation

### Placement Head

| Cat. No. | Size (mm) |
|----------|-----------|
| MT-2222  | 22        |
| MT-2228  | 28        |
| MT-2232  | 32        |



\*All-Poly Requires Reflection Instrumentation

### Positioner

| Cat. No. |
|----------|
| MT-2200  |



\*All-Poly Requires Reflection Instrumentation

### Trial Shell

| Cat. No. | Size (mm) |
|----------|-----------|
| 73-0040  | 40        |
| 73-0041  | 41        |
| 73-0042  | 42        |
| 73-0043  | 43        |
| 73-0044  | 44        |
| 73-0045  | 45        |
| 73-0046  | 46        |
| 73-0047  | 47        |
| 73-0048  | 48        |
| 73-0049  | 49        |
| 73-0050  | 50        |
| 73-0051  | 51        |
| 73-0052  | 52        |
| 73-0053  | 53        |
| 73-0054  | 54        |
| 73-0055  | 55        |
| 73-0056  | 56        |
| 73-0057  | 57        |
| 73-0058  | 58        |
| 73-0059  | 59        |
| 73-0060  | 60        |
| 73-0061  | 61        |



\*All-Poly Requires Reflection Instrumentation

### Acetabular Options/Instruments/Reflection Jumbo Reamer/Trial Tray

### Reflection Jumbo Reamer/Trial Tray (Not shown)

| Cat. No.  |
|-----------|
| 7136-2285 |

### Reflection Reamer Domes, Size 71-76

| Cat. No.  | Size | Desc. |
|-----------|------|-------|
| 7136-2771 | 71   | Large |
| 7136-2772 | 72   | Large |
| 7136-2773 | 73   | Large |
| 7136-2774 | 74   | Large |
| 7136-2775 | 75   | Large |
| 7136-2776 | 76   | Large |



### Reflection Trial Shells, Size 71-76

| Cat. No.  | O.D. | Size  |
|-----------|------|-------|
| 7136-2371 | 71   | Large |
| 7136-2372 | 72   | Large |
| 7136-2373 | 73   | Large |
| 7136-2374 | 74   | Large |
| 7136-2375 | 75   | Large |
| 7136-2376 | 76   | Large |



### Acetabular Options/Instruments/Reflection Large Reamer/Trial Tray

### Reflection Large Reamer/Trial Tray (Not shown)

| Cat. No.  |
|-----------|
| 7136-2284 |

### Reflection Reamer Domes, Size 65-70

| Cat. No.  | Size | Desc. |
|-----------|------|-------|
| 7136-2765 | 65   | Large |
| 7136-2766 | 66   | Large |
| 7136-2767 | 67   | Large |
| 7136-2768 | 68   | Large |
| 7136-2769 | 69   | Large |
| 7136-2770 | 70   | Large |



### Reflection Screw-in Trial Liners; 0° Liner



| Cat. No.  | I.D. (mm) | O.D. (mm) | Liner Size |
|-----------|-----------|-----------|------------|
| 7136-2867 | 28        | 66-68     | J          |
| 7136-2871 | 28        | 70-76     | K          |

### Reflection Screw-in Trial Liners; 20° Liner



| Cat. No.  | I.D. (mm) | O.D. (mm) | Liner Size |
|-----------|-----------|-----------|------------|
| 7136-2866 | 28        | 66-68     | J          |
| 7136-2870 | 28        | 70-76     | K          |

### Reflection Trial Shells, Size 65-70

| Cat. No.  | O.D. | Size  |
|-----------|------|-------|
| 7136-2365 | 65   | Large |
| 7136-2366 | 66   | Large |
| 7136-2367 | 67   | Large |
| 7136-2368 | 68   | Large |
| 7136-2369 | 69   | Large |
| 7136-2370 | 70   | Large |



### Acetabular Options/Instruments/Reflection Main Instrument Tray

### Reflection Ball Joint Screwdriver

| Cat. No.  |
|-----------|
| 7136-2295 |





# Reconstructive Surgery

## Hip Systems

Reflection Depth Gauge

Cat. No.  
7136-2012



Reflection Positioner/Impactor

Cat. No.  
7136-2299



Reflection Liner Impactor Head

| Cat. No.  | Size |
|-----------|------|
| 7136-2222 | 22   |
| 7136-2226 | 26   |
| 7136-2228 | 28   |
| 7136-2232 | 32   |



Reflection Ratchet Handle

Cat. No.  
7136-2294



Reflection Liner Removal Tool

Cat. No.  
7136-2296



Reflection Screw Drill Guide

Cat. No.  
7136-2919



Reflection Main Instrument Tray (Shown with instruments)

Cat. No.  
7136-2280



Reflection Screw Forceps

Cat. No.  
7136-2298



Reflection Modular Drill Shaft

(Not shown)

Cat. No.  
7136-2519

Reflection Screw-in Trial Liners; 20° Liner



| Cat. No.  | I.D. (mm) | O.D. (mm) | Liner Size |
|-----------|-----------|-----------|------------|
| 7136-2846 | 28        | 46-48     | D          |
| 7136-2850 | 28        | 50-52     | E          |
| 7136-2854 | 28        | 54-56     | F          |
| 7136-2858 | 28        | 58-60     | G          |
| 7136-2862 | 28        | 62-64     | H          |

Reflection Peg Drill Guide

Cat. No.  
7136-2917



Reflection Straight Screwdriver Shaft

Cat. No.  
7136-2293



## Reflection X-Bar

Cat. No.  
MT-2201



## Acetabular Options/Instruments/Reflection Primary Reamer Tray

Reflection Primary Reamer Tray (Shown with  
instruments)

Cat. No.  
7136-2281



## Reflection Reamer Domes, Size 42-64

| Cat. No.  | Size | Desc.    |
|-----------|------|----------|
| 7136-2742 | 42   | Standard |
| 7136-2743 | 43   | Standard |
| 7136-2744 | 44   | Standard |
| 7136-2745 | 45   | Standard |
| 7136-2746 | 46   | Standard |
| 7136-2747 | 47   | Standard |
| 7136-2748 | 48   | Standard |
| 7136-2749 | 49   | Standard |
| 7136-2750 | 50   | Standard |
| 7136-2751 | 51   | Standard |
| 7136-2752 | 52   | Standard |
| 7136-2753 | 53   | Standard |
| 7136-2754 | 54   | Standard |
| 7136-2755 | 55   | Standard |
| 7136-2756 | 56   | Standard |
| 7136-2757 | 57   | Standard |
| 7136-2758 | 58   | Standard |
| 7136-2759 | 59   | Standard |
| 7136-2760 | 60   | Standard |
| 7136-2761 | 61   | Standard |
| 7136-2762 | 62   | Standard |
| 7136-2763 | 63   | Standard |
| 7136-2764 | 64   | Standard |



## Reflection Reamer Handle

Cat. No.  
7136-2279



## Acetabular Options/Instruments/Reflection Reamer Domes

### Reflection Reamer Domes, Size 38-41

| Cat. No.  | Size | Desc. |
|-----------|------|-------|
| 7136-2738 | 38   | Small |
| 7136-2739 | 39   | Small |
| 7136-2740 | 40   | Small |
| 7136-2741 | 41   | Small |



### Reflection Reamer Domes, Size 42-64

| Cat. No.  | Size | Desc.    |
|-----------|------|----------|
| 7136-2742 | 42   | Standard |
| 7136-2743 | 43   | Standard |
| 7136-2744 | 44   | Standard |
| 7136-2745 | 45   | Standard |
| 7136-2746 | 46   | Standard |
| 7136-2747 | 47   | Standard |
| 7136-2748 | 48   | Standard |
| 7136-2749 | 49   | Standard |
| 7136-2750 | 50   | Standard |
| 7136-2751 | 51   | Standard |
| 7136-2752 | 52   | Standard |
| 7136-2753 | 53   | Standard |
| 7136-2754 | 54   | Standard |
| 7136-2755 | 55   | Standard |
| 7136-2756 | 56   | Standard |
| 7136-2757 | 57   | Standard |
| 7136-2758 | 58   | Standard |
| 7136-2759 | 59   | Standard |
| 7136-2760 | 60   | Standard |
| 7136-2761 | 61   | Standard |
| 7136-2762 | 62   | Standard |
| 7136-2763 | 63   | Standard |
| 7136-2764 | 64   | Standard |



# Reconstructive Surgery

## Hip Systems

### Reflection Reamer Domes, Size 65-70

| Cat. No.  | Size | Desc. |
|-----------|------|-------|
| 7136-2765 | 65   | Large |
| 7136-2766 | 66   | Large |
| 7136-2767 | 67   | Large |
| 7136-2768 | 68   | Large |
| 7136-2769 | 69   | Large |
| 7136-2770 | 70   | Large |



### Reflection Screw-in Trial Liners; 0° Liner



| Cat. No.  | I.D. (mm) | O.D. (mm) | Liner Size |
|-----------|-----------|-----------|------------|
| 7136-2241 | 22        | 40        | A          |
| 7136-2243 | 22        | 42        | B          |
| 7136-2245 | 22        | 44        | C          |
| 7136-2645 | 26        | 44        | D          |

### Reflection Reamer Domes, Size 71-76

| Cat. No.  | Size | Desc. |
|-----------|------|-------|
| 7136-2771 | 71   | Large |
| 7136-2772 | 72   | Large |
| 7136-2773 | 73   | Large |
| 7136-2774 | 74   | Large |
| 7136-2775 | 75   | Large |
| 7136-2776 | 76   | Large |



### Reflection Screw-in Trial Liners; 20° Liner



| Cat. No.  | I.D. (mm) | O.D. (mm) | Liner Size |
|-----------|-----------|-----------|------------|
| 7136-2240 | 22        | 40        | A          |
| 7136-2242 | 22        | 42        | B          |
| 7136-2244 | 22        | 44        | C          |
| 7136-2644 | 26        | 44        | D          |

### Acetabular Options/Instruments/Reflection Small Reamers and Trials Tray

#### Reflection Liner Impactor Head

| Cat. No.  | Size |
|-----------|------|
| 7136-2222 | 22   |
| 7136-2226 | 26   |
| 7136-2228 | 28   |
| 7136-2232 | 32   |



#### Reflection Small Reamer/Trial Tray (Not shown)

| Cat. No.  |
|-----------|
| 7136-2286 |

### Reflection Reamer Domes, Size 38-41

| Cat. No.  | Size | Desc. |
|-----------|------|-------|
| 7136-2738 | 38   | Small |
| 7136-2739 | 39   | Small |
| 7136-2740 | 40   | Small |
| 7136-2741 | 41   | Small |



### Reflection Trial Shells, Size 40-44

| Cat. No.  | O.D. | Size  |
|-----------|------|-------|
| 7136-2340 | 40   | Small |
| 7136-2341 | 41   | Small |
| 7136-2342 | 42   | Small |
| 7136-2343 | 43   | Small |
| 7136-2344 | 44   | Small |



#### Reflection Reamer Handle

| Cat. No.  |
|-----------|
| 7136-2279 |



### Acetabular Options/Instruments/Reflection Trial Shell Tray

## Reflection Trial Shell Handle



| Cat. No.  |
|-----------|
| 7136-2297 |

## Reflection Trial Shell Tray

(Not shown)

| Cat. No.  |
|-----------|
| 7136-2282 |

## Reflection Trial Shells, Size 65-70

| Cat. No.  | O.D. | Size  |
|-----------|------|-------|
| 7136-2365 | 65   | Large |
| 7136-2366 | 66   | Large |
| 7136-2367 | 67   | Large |
| 7136-2368 | 68   | Large |
| 7136-2369 | 69   | Large |
| 7136-2370 | 70   | Large |



## Reflection Trial Shells, Size 40-44

| Cat. No.  | O.D. | Size  |
|-----------|------|-------|
| 7136-2340 | 40   | Small |
| 7136-2341 | 41   | Small |
| 7136-2342 | 42   | Small |
| 7136-2343 | 43   | Small |
| 7136-2344 | 44   | Small |



## Reflection Trial Shells, Size 71-76

| Cat. No.  | O.D. | Size  |
|-----------|------|-------|
| 7136-2371 | 71   | Large |
| 7136-2372 | 72   | Large |
| 7136-2373 | 73   | Large |
| 7136-2374 | 74   | Large |
| 7136-2375 | 75   | Large |
| 7136-2376 | 76   | Large |



## Reflection Trial Shells, Size 45-64

| Cat. No.  | O.D. | Size     |
|-----------|------|----------|
| 7136-2345 | 45   | Standard |
| 7136-2346 | 46   | Standard |
| 7136-2347 | 47   | Standard |
| 7136-2348 | 48   | Standard |
| 7136-2349 | 49   | Standard |
| 7136-2350 | 50   | Standard |
| 7136-2351 | 51   | Standard |
| 7136-2352 | 52   | Standard |
| 7136-2353 | 53   | Standard |
| 7136-2354 | 54   | Standard |
| 7136-2355 | 55   | Standard |
| 7136-2356 | 56   | Standard |
| 7136-2357 | 57   | Standard |
| 7136-2358 | 58   | Standard |
| 7136-2359 | 59   | Standard |
| 7136-2360 | 60   | Standard |
| 7136-2361 | 61   | Standard |
| 7136-2362 | 62   | Standard |
| 7136-2363 | 63   | Standard |
| 7136-2364 | 64   | Standard |



## Acetabular Options/Contour Acetabular Rings/Implants

### Contour Reconstruction Ring



| Implant Cat. No. | O.D. | I.D. | Side  |
|------------------|------|------|-------|
| 7133-7150        | 50   | 46   | Left  |
| 7133-7156        | 56   | 52   | Left  |
| 7133-7162        | 62   | 58   | Left  |
| 7133-7250        | 50   | 46   | Right |
| 7133-7256        | 56   | 52   | Right |
| 7133-7262        | 62   | 58   | Right |

### Contour Reinforcement Ring

| Implant Cat. No. | O.D. | I.D. |
|------------------|------|------|
| 7133-7044        | 44   | 40   |
| 7133-7047        | 47   | 43   |
| 7133-7050        | 50   | 46   |
| 7133-7053        | 53   | 49   |
| 7133-7056        | 56   | 52   |
| 7133-7059        | 59   | 55   |
| 7133-7062        | 62   | 58   |
| 7133-7065        | 65   | 61   |
| 7133-7068        | 68   | 64   |



### Reflection Spherical Head Screws

| Cat. No.  | Length |
|-----------|--------|
| 7133-2515 | 15     |
| 7133-2520 | 20     |
| 7133-2525 | 25     |
| 7133-2530 | 30     |
| 7133-2535 | 35     |
| 7133-2540 | 40     |
| 7133-2545 | 45     |
| 7133-2550 | 50     |
| 7133-2560 | 60     |
| 7133-2570 | 70     |



### Reflection All-Poly Cup



| Cat. No.  | O.D. (mm) | I.D. (mm) |
|-----------|-----------|-----------|
| 7135-2240 | 40        | 22        |
| 7135-2243 | 43        | 22        |
| 7135-2246 | 46        | 22        |
| 7135-2249 | 49        | 22        |
| 7135-2252 | 52        | 22        |
| 7135-2255 | 55        | 22        |
| 7135-2258 | 58        | 22        |
| 7135-2261 | 61        | 22        |
| 7135-2846 | 46        | 28        |
| 7135-2849 | 49        | 28        |
| 7135-2852 | 52        | 28        |
| 7135-2855 | 55        | 28        |
| 7135-2858 | 58        | 28        |
| 7135-2861 | 61        | 28        |
| 7135-3249 | 49        | 32        |
| 7135-3252 | 52        | 32        |
| 7135-3255 | 55        | 32        |
| 7135-3258 | 58        | 32        |
| 7135-3261 | 61        | 32        |

### Acetabular Options/Contour Acetabular Rings/Trials

#### Contour Reconstruction Trials

(Not shown)

| Trial Cat. No. | Size | Side  |
|----------------|------|-------|
| 7136-7150      | 50   | Left  |
| 7136-7156      | 56   | Left  |
| 7136-7162      | 62   | Left  |
| 7136-7250      | 50   | Right |
| 7136-7256      | 56   | Right |
| 7136-7262      | 62   | Right |

#### Contour Reinforcement Trials

(Not shown)

| Trial Cat. No. | O.D. | I.D. |
|----------------|------|------|
| 7136-7044      | 44   | 40   |
| 7136-7047      | 47   | 43   |
| 7136-7050      | 50   | 46   |
| 7136-7053      | 53   | 49   |
| 7136-7056      | 56   | 52   |
| 7136-7059      | 59   | 55   |
| 7136-7062      | 62   | 58   |
| 7136-7065      | 65   | 61   |
| 7136-7068      | 68   | 64   |

### Acetabular Options/Contour Acetabular Rings/Contour Instrumentation

## Contour Flange Bender

Cat. No. [Redacted]  
7136-7001



\*Contour Requires Reflection Instrumentation

## Contour Instrument Tray

(Not shown)

Cat. No. [Redacted]  
7136-7000

\*Contour Requires Reflection Instrumentation

## Impaction Domes

| Cat. No.  | Desc. |
|-----------|-------|
| 7136-7341 | 41mm  |
| 7136-7344 | 44mm  |
| 7136-7347 | 47mm  |
| 7136-7350 | 50mm  |
| 7136-7353 | 53mm  |
| 7136-7356 | 56mm  |
| 7136-7359 | 59mm  |
| 7136-7362 | 62mm  |
| 7136-7365 | 65mm  |
| 7136-7368 | 68mm  |



\*Contour Requires Reflection Instrumentation

## Impactor Dome Tray

Cat. No. [Redacted]  
7136-7004



\*Contour Requires Reflection Instrumentation

## T-Handle

Cat. No. [Redacted]  
7136-4006



## Twist Drill, 3.2mm

Cat. No. [Redacted]  
21-0442



\*Contour Requires Reflection Instrumentation

## Vice Grip Pliers

Cat. No. [Redacted]  
7136-7537



\*Contour Requires Reflection Instrumentation

## Acetabular Options/Contour Acetabular Rings/All-Poly Instrumentation

### Acetabular Brush

6 per box

(Not shown)

Cat. No. [Redacted]  
11-0032

\*All-Poly Requires Reflection Instrumentation

### Acetabular Cement Compressor (Not shown)

Cat. No. 11-1430

\*All-Poly Requires Reflection Instrumentation

### Acetabular Reamer Dome

| Cat. No. | Size (mm) |
|----------|-----------|
| 41-7138  | 38        |
| 41-7139  | 39        |
| 41-7140  | 40        |
| 41-7141  | 41        |
| 41-7142  | 42        |
| 41-7143  | 43        |
| 41-7144  | 44        |
| 41-7145  | 45        |
| 41-7146  | 46        |
| 41-7147  | 47        |
| 41-7148  | 48        |
| 41-7149  | 49        |
| 41-7150  | 50        |
| 41-7151  | 51        |
| 41-7152  | 52        |
| 41-7153  | 53        |
| 41-7154  | 54        |
| 41-7155  | 55        |
| 41-7156  | 56        |
| 41-7157  | 57        |
| 41-7158  | 58        |
| 41-7159  | 59        |
| 41-7160  | 60        |
| 41-7161  | 61        |



\*All-Poly Requires Reflection Instrumentation

### Acetabular Reamer Handle (Not shown)

Cat. No. 11-4265

\*All-Poly Requires Reflection Instrumentation

### All-Poly Cup Instrument Tray

Cat. No. 7136-2110



\*All-Poly Requires Reflection Instrumentation

### Concise Cement Sculps Kit (Not shown)

Cat. No. 11-1000

\*All-Poly Requires Reflection Instrumentation

### Disposable Acetabular Cement Compressor Cap with Shield (5 per box)

| Cat. No. | Size              |
|----------|-------------------|
| 11-1431  | Small, 54mm dia.  |
| 11-1432  | Medium, 62mm dia. |
| 11-1433  | Large, 70mm dia.  |



\*All-Poly Requires Reflection Instrumentation

### Placement Head

| Cat. No. | Size (mm) |
|----------|-----------|
| MT-2222  | 22        |
| MT-2228  | 28        |
| MT-2232  | 32        |



\*All-Poly Requires Reflection Instrumentation

### Positioner

Cat. No. MT-2200



\*All-Poly Requires Reflection Instrumentation

## Trial Shell

| Cat. No. | Size (mm) |
|----------|-----------|
| 73-0040  | 40        |
| 73-0041  | 41        |
| 73-0042  | 42        |
| 73-0043  | 43        |
| 73-0044  | 44        |
| 73-0045  | 45        |
| 73-0046  | 46        |
| 73-0047  | 47        |
| 73-0048  | 48        |
| 73-0049  | 49        |
| 73-0050  | 50        |
| 73-0051  | 51        |
| 73-0052  | 52        |
| 73-0053  | 53        |
| 73-0054  | 54        |
| 73-0055  | 55        |
| 73-0056  | 56        |
| 73-0057  | 57        |
| 73-0058  | 58        |
| 73-0059  | 59        |
| 73-0060  | 60        |
| 73-0061  | 61        |



\*All-Poly Requires Reflection Instrumentation

## Femoral Head Options/Oxinium Femoral Heads

### Oxinium 12/14 Taper Femoral Heads

| Cat. No.  | Size | Neck Length |
|-----------|------|-------------|
| 7134-2200 | 22mm | +0          |
| 7134-2204 | 22mm | +4          |
| 7134-2208 | 22mm | +8          |
| 7134-2600 | 26mm | +0          |
| 7134-2604 | 26mm | +4          |
| 7134-2608 | 26mm | +8          |
| 7134-2803 | 28mm | -3          |
| 7134-2800 | 28mm | +0          |
| 7134-2804 | 28mm | +4          |
| 7134-2808 | 28mm | +8          |
| 7134-2812 | 28mm | +12         |
| 7134-2816 | 28mm | +16         |
| 7134-3203 | 32mm | -3          |
| 7134-3200 | 32mm | +0          |



### Oxinium 12/14 Taper Femoral Heads

| Cat. No.  | Size | Neck Length |
|-----------|------|-------------|
| 7134-3204 | 32mm | +4          |
| 7134-3208 | 32mm | +8          |
| 7134-3212 | 32mm | +12         |
| 7134-3216 | 32mm | +16         |
| 7134-3603 | 36mm | -3          |
| 7134-3600 | 36mm | +0          |
| 7134-3604 | 36mm | +4          |
| 7134-3608 | 36mm | +8          |
| 7134-3612 | 36mm | +12         |

## Femoral Head Options/Alumina Femoral Heads

### Alumina 12/14 Taper Femoral Heads

| Cat. No.  | Size | Length (mm) |
|-----------|------|-------------|
| 7133-2800 | +0   | 28mm        |
| 7133-2804 | +4   | 28mm        |
| 7133-2808 | +8   | 28mm        |
| 7133-3200 | +0   | 32mm        |
| 7133-3204 | +4   | 32mm        |
| 7133-3208 | +8   | 32mm        |
| 7133-3600 | +0   | 36mm        |
| 7133-3604 | +4   | 36mm        |
| 7133-3608 | +8   | 36mm        |



## Femoral Head Options/CoCr Femoral Heads

### CoCr 12/14 Femoral Heads

Cobalt Chromium- ASTM F 799

| Cat. No.  | Size | Neck Length |
|-----------|------|-------------|
| 7130-2200 | 22mm | +0          |
| 7130-2204 | 22mm | +4          |
| 7130-2208 | 22mm | +8          |
| 7130-2212 | 22mm | +12         |
| 7130-2600 | 26mm | +0          |
| 7130-2604 | 26mm | +4          |
| 7130-2608 | 26mm | +8          |
| 7130-2612 | 26mm | +12         |
| 7130-2803 | 28mm | -3          |





# Reconstructive Surgery

## Hip Systems

### CoCr 12/14 Femoral Heads

Cobalt Chromium- ASTM F 799

| Cat. No.  | Size | Neck Length |
|-----------|------|-------------|
| 7130-2800 | 28mm | +0          |
| 7130-2804 | 28mm | +4          |
| 7130-2808 | 28mm | +8          |
| 7130-2812 | 28mm | +12         |
| 7130-2816 | 28mm | +16         |
| 7130-3203 | 32mm | -3          |
| 7130-3200 | 32mm | +0          |
| 7130-3204 | 32mm | +4          |
| 7130-3208 | 32mm | +8          |
| 7130-3212 | 32mm | +12         |
| 7130-3216 | 32mm | +16         |
| 7130-3603 | 36mm | -3          |
| 7130-3600 | 36mm | +0          |
| 7130-3604 | 36mm | +4          |
| 7130-3608 | 36mm | +8          |
| 7130-3612 | 36mm | +12         |

### Trial 12/14 Taper Femoral Heads



| Cat. No.  | Size | Neck Length | Color Code |
|-----------|------|-------------|------------|
| 7135-2200 | 22mm | +0          | Yellow     |
| 7135-2204 | 22mm | +4          | Red        |
| 7135-2208 | 22mm | +8          | White      |
| 7135-2212 | 22mm | +12         | Blue       |
| 7135-2600 | 26mm | +0          | Yellow     |
| 7135-2604 | 26mm | +4          | Red        |
| 7135-2608 | 26mm | +8          | White      |
| 7135-2612 | 26mm | +12         | Blue       |
| 7135-2803 | 28mm | -3          | Green      |
| 7135-2800 | 28mm | +0          | Yellow     |
| 7135-2804 | 28mm | +4          | Red        |
| 7135-2808 | 28mm | +8          | White      |
| 7135-2812 | 28mm | +12         | Blue       |
| 7135-2816 | 28mm | +16         | Black      |
| 7135-3203 | 32mm | -3          | Green      |
| 7135-3200 | 32mm | +0          | Yellow     |
| 7135-3204 | 32mm | +4          | Red        |
| 7135-3208 | 32mm | +8          | White      |
| 7135-3212 | 32mm | +12         | Blue       |
| 7135-3216 | 32mm | +16         | Black      |
| 7135-3603 | 36mm | -3          | Green      |
| 7135-3600 | 36mm | +0          | Yellow     |
| 7135-3604 | 36mm | +4          | Red        |
| 7135-3608 | 36mm | +8          | White      |
| 7135-3612 | 36mm | +12         | Blue       |

### Femoral Head Options/Zirconia Femoral Heads

#### Zirconia 12/14 Taper Femoral Heads

| Cat. No.  | Size  | Neck Length |
|-----------|-------|-------------|
| 7132-0422 | 22 mm | +4          |
| 7132-0822 | 22 mm | +8          |
| 7132-0026 | 26 mm | +0          |
| 7132-0426 | 26 mm | +4          |
| 7132-0826 | 26 mm | +8          |
| 7132-0028 | 28 mm | +0          |
| 7132-0428 | 28 mm | +4          |
| 7132-0828 | 28 mm | +8          |

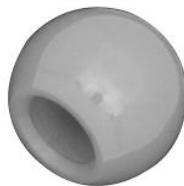

### Femoral Head Options/Trial 12/14 Taper Femoral Heads

### Fracture Management/Austin Moore Endoprotheses

## Curved Rasp 158mm-Top Shoulder

(Not shown)

| Cat. No.  |
|-----------|
| 7136-4154 |

## Femoral Endoprosthesis Driver

(Not shown)

| Cat. No. |
|----------|
| 11-1560  |

## Femoral Head Gauge

(Not shown)

| Cat. No. |
|----------|
| 11-0250  |

## Fenestrated Stem

| Cat. No. | Head Size (mm) | Stem Length (mm) |
|----------|----------------|------------------|
| 12-0941  | 41             | 150              |
| 12-0942  | 42             | 150              |
| 12-0943  | 43             | 150              |
| 12-0944  | 44             | 150              |
| 12-0945  | 45             | 160              |
| 12-0946  | 46             | 160              |
| 12-0947  | 47             | 160              |
| 12-0948  | 48             | 175              |
| 12-0949  | 49             | 175              |
| 12-0950  | 50             | 175              |
| 12-0951  | 51             | 175              |
| 12-0952  | 52             | 175              |
| 12-0953  | 53             | 175              |
| 12-0954  | 54             | 175              |



## Solid Stem

| Cat. No. | Head Size (mm) | Stem Length (mm) |
|----------|----------------|------------------|
| 12-1941  | 41             | 150              |
| 12-1942  | 42             | 150              |
| 12-1943  | 43             | 150              |
| 12-1944  | 44             | 150              |
| 12-1945  | 45             | 160              |
| 12-1946  | 46             | 160              |
| 12-1947  | 47             | 160              |
| 12-1948  | 48             | 175              |
| 12-1949  | 49             | 175              |
| 12-1950  | 50             | 175              |
| 12-1951  | 51             | 175              |
| 12-1952  | 52             | 175              |
| 12-1953  | 53             | 175              |
| 12-1954  | 54             | 175              |



## Fracture Management/Convex Bipolar System

### CoCr 12/14 Taper Femoral Heads\*

Cobalt Chrome CoCr



| Cat. No.  | O.D. | Neck Length |
|-----------|------|-------------|
| 7130-2600 | 26mm | +0          |
| 7130-2604 | 26mm | +4          |
| 7130-2608 | 26mm | +8          |
| 7130-2612 | 26mm | +12         |
| 7130-2803 | 28mm | -3          |
| 7130-2800 | 28mm | +0          |
| 7130-2804 | 28mm | +4          |
| 7130-2808 | 28mm | +8          |
| 7130-2812 | 28mm | +12         |
| 7130-2816 | 28mm | +16         |

\*For use with the Smith & Nephew 12/14 taper femoral components

# Reconstructive Surgery

## Hip Systems

### Convене Bipolar Instrument and Trial Tray

(Not shown)

Cat. No.

7136-2810

### Convене Bipolar Liners



| Cat. No.  | I.D. (mm) | O.D. (mm) |
|-----------|-----------|-----------|
| 7139-2638 | 26        | 38-42     |
| 7139-2843 | 28        | 43-46     |
| 7139-2847 | 28        | 47-51     |
| 7139-2852 | 28        | 52-56     |
| 7139-2857 | 28        | 57-60     |

### Convене Bipolar Shells

CoCr

| Implant Cat. No. | Outside Diameter (mm) | Trial Cat. No. |
|------------------|-----------------------|----------------|
| 12-6438          | 38                    | 7136-2638      |
| 12-6439          | 39                    | 7136-2639      |
| 12-6440          | 40                    | 7136-2640      |
| 12-6441          | 41                    | 7136-2641      |
| 12-6442          | 42                    | 7136-2642      |
| 12-6543          | 43                    | 11-7543        |
| 12-6544          | 44                    | 11-7544        |
| 12-6545          | 45                    | 11-7545        |
| 12-6546          | 46                    | 11-7546        |
| 12-6547          | 47                    | 11-7547        |
| 12-6548          | 48                    | 11-7548        |
| 12-6549          | 49                    | 11-7549        |
| 12-6550          | 50                    | 11-7550        |
| 12-6551          | 51                    | 11-7551        |
| 12-6552          | 52                    | 11-7552        |
| 12-6553          | 53                    | 11-7553        |
| 12-6554          | 54                    | 11-7554        |
| 12-6555          | 55                    | 11-7555        |
| 12-6556          | 56                    | 11-7556        |
| 12-6557          | 57                    | 11-7557        |
| 12-6558          | 58                    | 11-7558        |
| 12-6559          | 59                    | 11-7559        |
| 12-6560          | 60                    | 11-7560        |



### Trial 12/14 Taper Femoral Heads



| Cat. No.  | O.D. | Neck Length | Color  |
|-----------|------|-------------|--------|
| 7135-2600 | 26mm | +0          | Yellow |
| 7135-2604 | 26mm | +4          | Red    |
| 7135-2608 | 26mm | +8          | White  |
| 7135-2612 | 26mm | +12         | Blue   |
| 7135-2803 | 28mm | -3          | Green  |
| 7135-2800 | 28mm | +0          | Yellow |
| 7135-2804 | 28mm | +4          | Red    |
| 7135-2808 | 28mm | +8          | White  |
| 7135-2812 | 28mm | +12         | Blue   |
| 7135-2816 | 28mm | +16         | Black  |

### Trial Handle

(Not shown)

Cat. No.

73-2119

### Trial Head Separator

(Not shown)

Cat. No.

11-7580

### Fracture Management/Unipolar System

### Taper Sleeve Removal Tool

(Not shown)

Cat. No.

11-6608

## Trial Handle

(Not shown)

| Cat. No. |
|----------|
| 73-2119  |

## Unipolar Instrument and Trial Tray

| Cat. No. |
|----------|
| 11-7406  |

## Unipolar 12/14 Taper Sleeves\*

| Cat. No.  | Length | Trials    |
|-----------|--------|-----------|
| 7132-6603 | -3 mm  | 7136-6603 |
| 7132-6600 | +0 mm  | 7136-6600 |
| 7132-6604 | +4 mm  | 7136-6604 |
| 7132-6608 | +8 mm  | 7136-6608 |
| 7132-6612 | +12 mm | 7136-6612 |



\* For use with Smith & Nephew 12/14 Taper Femoral Components.

## Implant Removal System/Renovation Implant Removal System

### Acetabular Implant Removal Tray (Not shown)

| Cat. No.  | Tray Accepts the Following:            |
|-----------|--|
| 7136-7577 | Acetabular Implant Removal Tray Insert |
| 7136-7547 | Osteotome System Tray Insert           |
| 7136-7541 | Small Slap Hammer                      |
| 7136-7542 | Acetabular Component Gripper           |
| 7136-7543 | Acetabular Component Forceps           |
| 7136-7544 | Curved Acetabular Chisel               |
| 7136-7545 | Round Acetabular Cement Splitter       |
| 7136-7548 | Quick-Coupling Osteotome Handle, Short |
| 7136-7549 | Quick-Coupling Osteotome Handle, Long  |
| 7136-7546 | Acetabular Gouge, Size 46              |
| 7136-7550 | Acetabular Gouge, Size 50              |
| 7136-7554 | Acetabular Gouge, Size 54              |
| 7136-7558 | Acetabular Gouge, Size 58              |
| 7136-7562 | Acetabular Gouge, Size 62              |
| 7136-7567 | Small Acetabular Gouge                 |

## Unipolar Heads

| CoCr Implant Cat. No. | Outside Diameter (mm) | Trial Cat. No. |
|-----------------------|-----------------------|----------------|
| 12-6640               | 40                    | 11-7840        |
| 12-6641               | 41                    | 11-7841        |
| 12-6642               | 42                    | 11-7842        |
| 12-6643               | 43                    | 11-7843        |
| 12-6644               | 44                    | 11-7844        |
| 12-6645               | 45                    | 11-7845        |
| 12-6646               | 46                    | 11-7846        |
| 12-6647               | 47                    | 11-7847        |
| 12-6648               | 48                    | 11-7848        |
| 12-6649               | 49                    | 11-7849        |
| 12-6650               | 50                    | 11-7850        |
| 12-6651               | 51                    | 11-7851        |
| 12-6652               | 52                    | 11-7852        |
| 12-6653               | 53                    | 11-7853        |
| 12-6654               | 54                    | 11-7854        |
| 12-6655               | 55                    | 11-7855        |
| 12-6657               | 57                    | 11-7857        |
| 12-6659               | 59                    | 11-7859        |
| 12-6661               | 61                    | 11-7861        |



## Disposable Osteotome Blades (Sterile) (Not shown)

| Cat. No.  | Description                              |
|-----------|--|
| 7136-9310 | Radial Osteotome Blade, Size 10          |
| 7136-9312 | Radial Osteotome Blade, Size 12          |
| 7136-9314 | Radial Osteotome Blade, Size 14          |
| 7136-9316 | Radial Osteotome Blade, Size 16          |
| 7136-9208 | Thin Osteotome Blade, 8 mm x 3"          |
| 7136-9210 | Thin Osteotome Blade, 10 mm x 3"         |
| 7136-9212 | Thin Osteotome Blade, 12 mm x 3"         |
| 7136-9220 | Thin Osteotome Blade, 20 mm x 3"         |
| 7136-9412 | Thin Osteotome Blade, Rounded End, 12 mm |

### Disposable Osteotome Blades (Sterile)

| Cat. No.  | Description                              |
|-----------|--|
| 7136-9420 | Thin Osteotome Blade, Rounded End, 20 mm |
| 7136-9410 | Thin Osteotome Blade, 10 mm x 5"         |
| 7136-9408 | Thin Osteotome Blade, 8 mm x 5"          |

### Femoral Implant Removal Tray

(Not shown)

| Cat. No.  | Tray Accepts the Following:               |
|-----------|---|
| 7136-7579 | Femoral Implant Removal Tray<br>Insert #1 |
| 7136-7580 | Femoral Implant Removal Tray<br>Insert #2 |
| 7136-7552 | Slotted Mallet                            |
| 7136-7553 | Large Slap Hammer                         |
| 7136-7555 | Modular Stem Extractor                    |
| 7136-7556 | T-Handle Wrench                           |
| 7136-7557 | Hook Stem Extractor                       |
| 7136-7559 | Fixed Head Stem Extractor                 |
| 7136-9007 | Conical Tap, 7 mm                         |
| 7136-9009 | Conical Tap, 9 mm                         |
| 7136-9045 | Cement Drill, 4.5 mm                      |
| 7136-9006 | Cement Drill, 6 mm                        |
| 7136-9008 | Cement Drill, 8 mm                        |
| 7136-7560 | Flag Splitter                             |
| 7136-9308 | "V" Splitter                              |
| 7136-7563 | Angled Gouge                              |
| 7136-7564 | Straight Gouge                            |
| 7136-7566 | Carbide Punch                             |
| 7136-9517 | Reverse Curette, 7 mm x 17"               |
| 7136-9519 | Reverse Curette, 9 mm x 17"               |
| 7136-9207 | "X" Osteotome, 7 mm x 17"                 |
| 7136-9200 | Rongeur 200 mm with Teeth                 |
| 7136-9300 | Rongeur 300 mm with Teeth                 |

### Revonation Hip Implant Removal Kit

(Not shown)

| Cat. No.  |
|-----------|
| 7136-7575 |

### Shoulder Systems

### Cofield Humeral Heads; Primary Humeral Head Components

Primary Humeral Head Components Chromium Cobalt (ASTM F799)

### Cofield 2 Shoulder System

#### All-Poly Glenoid Instrument Tray

Cat. No.  
7124-8705

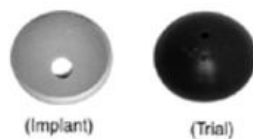

### Cofield Glenoids

All-Poly Glenoid Components UHMWPE (ASTM F648)

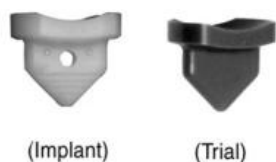

| Cat. No.  | Head Height (mm) | Head Diameter (mm) | Description |
|-----------|------------------|--------------------|-------------|
| 7125-9314 | 14               | 36                 | Implant     |
| 7125-9316 | 16               | 38                 | Implant     |
| 7125-9318 | 18               | 40                 | Implant     |
| 7125-9320 | 20               | 42                 | Implant     |
| 7125-9322 | 22               | 44                 | Implant     |
| 7125-9324 | 24               | 46                 | Implant     |
| 7125-9326 | 26               | 48                 | Implant     |
| 7125-9328 | 28               | 50                 | Implant     |
| 7124-9314 | 14               | 36                 | Trial       |
| 7124-9316 | 16               | 38                 | Trial       |
| 7124-9318 | 18               | 40                 | Trial       |
| 7124-9320 | 20               | 42                 | Trial       |
| 7124-9322 | 22               | 44                 | Trial       |
| 7124-9324 | 24               | 46                 | Trial       |
| 7124-9326 | 26               | 48                 | Trial       |
| 7124-9328 | 28               | 50                 | Trial       |

| Implant Cat. No. | Size   | Trial Cat. No. | Description |
|------------------|--------|----------------|-------------|
| 7125-9501        | Small  | 7124-9501      | Standard    |
| 7125-9502        | Medium | 7124-9502      | Standard    |
| 7125-9503        | Large  | 7124-9503      | Standard    |
| 7125-9531        | Small  | 7124-9531      | +2 mm       |
| 7125-9532        | Medium | 7124-9532      | +2 mm       |
| 7125-9533        | Large  | 7124-9533      | +2 mm       |
| 7125-9521        | Small  | 7124-9521      | Lipped      |
| 7125-9522        | Medium | 7124-9522      | Lipped      |
| 7125-9523        | Large  | 7124-9523      | Lipped      |

### Cofield Humeral Stems; Intermediate Length Humeral Stem Components

\*Trial extensions attach to the primary humeral stem trial and are made from stainless steel. The corresponding implant is one piece. Intermediate Length Humeral Stem Components Chromium Cobalt (ASTM F75)

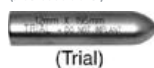

| Cat. No.  | Stem Diameter (mm) | Stem Length (mm) | Description       |
|-----------|--------------------|------------------|-------------------|
| 7125-9108 | 8                  | 195              | Implant and Trial |
| 7125-9110 | 10                 | 195              | Implant and Trial |
| 7125-9112 | 12                 | 195              | Implant and Trial |
| 7125-9114 | 14                 | 195              | Implant and Trial |
| 7125-9116 | 16                 | 195              | Implant and Trial |

# Reconstructive Surgery

## Shoulder Systems

### Cofield Humeral Stems; Long Length Humeral Stem Components

\*Trial extensions attach to the primary humeral stem trial and are made from stainless steel. The corresponding implant is one piece. Long Length Humeral Stem Components Chromium Cobalt (ASTM F75)



(Trial)

| Cat. No.  | Stem Diameter | Stem Length | Description       |
|-----------|---------------|-------------|-------------------|
| 7125-9210 | 10            | 245         | Implant and Trial |
| 7125-9212 | 12            | 245         | Implant and Trial |
| 7125-9214 | 14            | 245         | Implant and Trial |
| 7125-9216 | 16            | 245         | Implant and Trial |

### Cofield Humeral Stems; Standard Length Humeral Stem Components

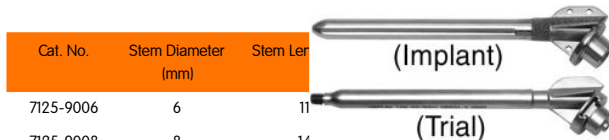

| Cat. No.  | Stem Diameter (mm) | Stem Length | Description             |
|-----------|--------------------|-------------|-------------------------|
| 7125-9006 | 6                  | 115         | Implant                 |
| 7125-9008 | 8                  | 145         | Implant                 |
| 7125-9010 | 10                 | 145         | Implant                 |
| 7125-9012 | 12                 | 145         | Implant                 |
| 7125-9014 | 14                 | 145         | Implant                 |
| 7125-9016 | 16                 | 145         | Implant                 |
| 7124-9006 | 6                  | 115         | Modular Trial           |
| 7124-9008 | 8                  | 145         | Modular Trial           |
| 7124-9010 | 10                 | 145         | Modular Trial           |
| 7124-9012 | 12                 | 145         | Modular Trial           |
| 7124-9014 | 14                 | 145         | Modular Trial           |
| 7124-9016 | 16                 | 145         | Modular Trial           |
| 7124-9506 | 6                  | 115         | One-Piece Humeral Trial |
| 7124-9508 | 8                  | 145         | One-Piece Humeral Trial |
| 7124-9510 | 10                 | 145         | One-Piece Humeral Trial |
| 7124-9512 | 12                 | 145         | One-Piece Humeral Trial |
| 7124-9514 | 14                 | 145         | One-Piece Humeral Trial |
| 7124-9516 | 16                 | 145         | One-Piece Humeral Trial |

\*Trial Stems are made from Stainless Steel

### Glenoid Drill Guides 1

| Cat. No.  | Size  |
|-----------|-------|
| 7124-9811 | Small |



### Glenoid Drill Guides 1

| Cat. No.  | Size   |
|-----------|--------|
| 7124-9812 | Medium |
| 7124-9813 | Large  |

### Humeral Resection Guide

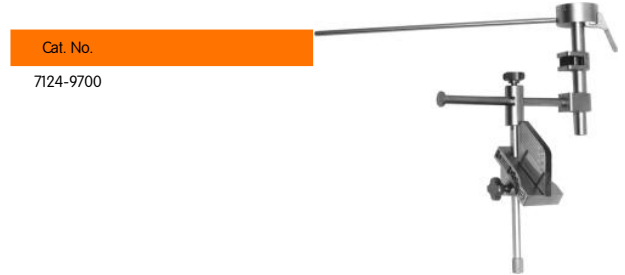

| Cat. No.  |
|-----------|
| 7124-9700 |

### Humeral Trial Impactor/Extractor



| Cat. No.  |
|-----------|
| 7124-9703 |

### Retractor Instrument Tray

(Not shown)

| Cat. No.  |
|-----------|
| 7124-8704 |

### Sterilization Cases

#### Humeral Trial Instrument Tray



| Cat. No.  |
|-----------|
| 7124-8702 |

### Sterilization Cases

#### Retractor Instrument Tray

(Not shown)

| Cat. No.  |
|-----------|
| 7124-8704 |

## Sterilization Cases

Humeral Preparation Instrument Tray

| Cat. No.  |
|-----------|
| 7124-8701 |



## Sterilization Cases

All-Poly Glenoid Instrument Tray

| Cat. No.  |
|-----------|
| 7124-8705 |



## Sterilization Cases

Humeral Revision Instrument Tray

| Cat. No.  |
|-----------|
| 7124-8703 |



## Glenoid Options

### Anatomic Glenoids

(Not shown)

| Implant Cat. No. | Size |
|------------------|------|
| 7125-9601        | 36mm |
| 7125-9602        | 38mm |
| 7125-9603        | 40mm |

### COFIELD2 Keeled Glenoids

| Implant Cat. No. | Size |
|------------------|------|
| 7125-9501        | 36mm |
| 7125-9502        | 38mm |
| 7125-9503        | 40mm |



### COFIELD2 Pegged Glenoids

| Implant Cat. No. | Size |
|------------------|------|
| 7125-9601        | 36mm |
| 7125-9602        | 38mm |
| 7125-9603        | 40mm |



### Humeral Head Componets

#### COFIELD2 Eccentric Heads

Same sizes as standard heads Off-center taper hole for more positioning options



| Cat. No.  | Head Height (mm) | Head Diameter (mm) | Eccentric Offset (mm) |
|-----------|------------------|--------------------|-----------------------|
| 7125-9614 | 14               | 36                 | 1.5                   |
| 7125-9616 | 16               | 38                 | 3                     |
| 7125-9618 | 18               | 40                 | 4                     |
| 7125-9620 | 20               | 42                 | 4                     |
| 7125-9622 | 22               | 44                 | 4                     |
| 7125-9624 | 24               | 46                 | 4                     |
| 7125-9626 | 26               | 48                 | 5                     |
| 7125-9628 | 28               | 50                 | 5                     |

#### COFIELD2 Lateral Offset Heads



| Implant Cat. No. | Head Thickness | Head Diameter | Lateral Offset |
|------------------|----------------|---------------|----------------|
| 7125-9717        | 17mm           | 36mm          | 3mm            |
| 7125-9719        | 19mm           | 38mm          | 3mm            |
| 7125-9722        | 22mm           | 40mm          | 3mm            |
| 7125-9724        | 24mm           | 42mm          | 4mm            |
| 7125-9726        | 26mm           | 44mm          | 4mm            |
| 7125-9728        | 28mm           | 46mm          | 4mm            |
| 7125-9731        | 31mm           | 48mm          | 5mm            |
| 7125-9733        | 33mm           | 50mm          | 5mm            |



# Reconstructive Surgery

## Shoulder Systems

### COFIELD2 Standard Heads

8 Sizes from 14mm to 28mm Heads increase proportionally in 2mm increments

| Implant Cat. No. | Head Thickness | Head Diameter |
|------------------|----------------|---------------|
| 7125-9314        | 14mm           | 36mm          |
| 7125-9316        | 16mm           | 38mm          |
| 7125-9318        | 18mm           | 40mm          |
| 7125-9320        | 20mm           | 42mm          |
| 7125-9322        | 22mm           | 44mm          |
| 7125-9324        | 24mm           | 46mm          |
| 7125-9326        | 26mm           | 48mm          |
| 7125-9328        | 28mm           | 50mm          |



### Cofield2 145mm Stems



| Implant Cat. No. | Stem Diameter | Stem Length |
|------------------|---------------|-------------|
| 7125-9006        | 6mm           | 115mm       |
| 7125-9008        | 8mm           | 145mm       |
| 7125-9010        | 10mm          | 145mm       |
| 7125-9012        | 12mm          | 145mm       |
| 7125-9014        | 14mm          | 145mm       |
| 7125-9016        | 16mm          | 145mm       |
| 7125-9108        | 8mm           | 195mm       |
| 7125-9110        | 10mm          | 195mm       |
| 7125-9112        | 12mm          | 195mm       |
| 7125-9114        | 14mm          | 195mm       |
| 7125-9116        | 16mm          | 195mm       |
| 7125-9208        | 8mm           | 245mm       |
| 7125-9210        | 10mm          | 245mm       |
| 7125-9212        | 12mm          | 245mm       |

### COFIELD2 Unipolar Heads\*

Unipolar Humeral Head Components Chromium Cobalt (ASTM F799)  
(Not shown)

| Implant Cat. No. | Head Thickness | Head Diameter |
|------------------|----------------|---------------|
| 7125-9332        | 32mm           | 54mm          |
| 7125-9336        | 36mm           | 58mm          |

\* For use as a hemiarthroplasty only.

### MODULAR NEER 3 Heads

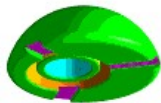

| Implant Cat. No. | Head Thickness | Head Diameter | Eccentric Offset |
|------------------|----------------|---------------|------------------|
| 7125-9914        | 14mm           | 41mm          | 3mm              |
| 7125-9918        | 18mm           | 46mm          | 4.5mm            |
| 7125-9921        | 21mm           | 49mm          | 5mm              |
| 7125-9924        | 24mm           | 50mm          | 5mm              |
| 7125-9927        | 27mm           | 51mm          | 5mm              |

### MODULAR NEER 3 125mm Stems



| Implant Cat. No. | Stem Diameter | Stem Length |
|------------------|---------------|-------------|
| 7125-9634        | 8mm           | 125mm       |
| 7125-9635        | 10mm          | 125mm       |
| 7125-9636        | 12mm          | 125mm       |
| 7125-9640        | 14mm          | 125mm       |
| 7125-9637        | 8mm           | 175mm       |
| 7125-9638        | 10mm          | 175mm       |
| 7125-9639        | 12mm          | 175mm       |
| 7125-9641        | 14mm          | 175mm       |

### Humeral Stem Components

## NEER 3 Stems



| Implant Cat. No. | Stem Diameter | Head Size   | Stem Length |
|------------------|---------------|-------------|-------------|
| 16302            | 8mm           | 15 x 41mm   | 125mm       |
| 16303            | 8mm           | 19 x 46mm   | 125mm       |
| 16304            | 8mm           | 22 x 48mm   | 125mm       |
| 16305            | 8mm           | 26 x 49.5mm | 125mm       |
| 16312            | 10mm          | 15 x 41mm   | 125mm       |
| 16313            | 10mm          | 19 x 46mm   | 125mm       |
| 16314            | 10mm          | 22 x 48mm   | 125mm       |
| 16315            | 10mm          | 26 x 49.5mm | 125mm       |
| 16322            | 12mm          | 15 x 41mm   | 125mm       |
| 16323            | 12mm          | 19 x 46mm   | 125mm       |
| 16324            | 12mm          | 22 x 48mm   | 125mm       |
| 16325            | 12mm          | 26 x 49.5mm | 125mm       |

## Instruments

### Anatomic Glenoid Angled Reamer Driver



Cat. No. 36025

### Anatomic Glenoid Case

(Tray only, no instruments)

(Not shown)

Cat. No. 37002

### Anatomic Glenoid Drill

Cat. No. 36027



### Anatomic Glenoid Drill Guide

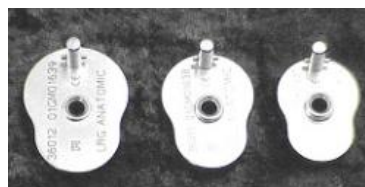

| Cat. no. | Size   |
|----------|--------|
| 36010    | Small  |
| 36011    | Medium |
| 36012    | Large  |

### Anatomic Glenoid Modular Handle

Cat. No. 36020



### Anatomic Glenoid Reamer



| Cat. No. | Size   |
|----------|--------|
| 36030    | Small  |
|          | Medium |
|          | Large  |

# Reconstructive Surgery

## Shoulder Systems

### Anatomic Glenoid Resec Guide



| Cat. No. | Size   |
|----------|--------|
| 36015    | Small  |
| 36016    | Medium |
| 36017    | Large  |

### Anatomic Glenoid Trial

| Cat. No. | Size   |
|----------|--------|
| 26001    | Small  |
| 26002    | Medium |
| 26003    | Large  |



### Canal Protector



| Cat. No. |
|----------|
| 36308    |

### COFIELD2 End Cutting Drills

| Cat. No.  | Size (mm) |
|-----------|-----------|
| 7124-8806 | 6         |
| 7124-8808 | 8         |
| 7124-8810 | 10        |
| 7124-8812 | 12        |
| 7124-8814 | 14        |
| 7124-8816 | 16        |



### COFIELD2 Head Trials Tray

(Tray only, no instruments)

| Cat. No.  |
|-----------|
| 7124-9665 |

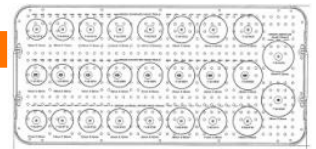

### COFIELD2 Humeral Head Trial, Eccentric

| Cat. No.  | Size      |
|-----------|-----------|
| 7124-9614 | 14 x 36mm |
| 7124-9616 | 16 x 38mm |
| 7124-9618 | 18 x 40mm |
| 7124-9620 | 20 x 42mm |
| 7124-9622 | 22 x 44mm |
| 7124-9624 | 24 x 46mm |
| 7124-9626 | 26 x 48mm |
| 7124-9628 | 28 x 50mm |



### COFIELD2 Humeral Head Trial, Offset

| Cat. No.  | Size      |
|-----------|-----------|
| 7124-9717 | 17 x 36mm |
| 7124-9719 | 19 x 38mm |
| 7124-9722 | 22 x 40mm |
| 7124-9724 | 24 x 42mm |
| 7124-9726 | 26 x 44mm |
| 7124-9728 | 28 x 46mm |
| 7124-9731 | 31 x 48mm |
| 7124-9733 | 33 x 50mm |



### COFIELD2 Humeral Head Trial, Standard

Same sizes as standard heads Off-center taper hole for more positioning options

| Cat. No.  | Size      | Eccentric Offset (mm) |
|-----------|-----------|-----------------------|
| 7124-9314 | 14 x 36mm | 1.5                   |
| 7124-9316 | 16 x 38mm | 3                     |
| 7124-9318 | 18 x 40mm | 4                     |
| 7124-9320 | 20 x 42mm | 4                     |
| 7124-9322 | 22 x 44mm | 4                     |
| 7124-9324 | 24 x 46mm | 4                     |
| 7124-9326 | 26 x 48mm | 5                     |
| 7124-9328 | 28 x 50mm | 5                     |



## COFIELD2 Humeral Stem Trial

| Cat. No.  | Size       |
|-----------|------------|
| 7124-9506 | 6 x 115mm  |
| 7124-9508 | 8 x 145mm  |
| 7124-9510 | 10 x 145mm |
| 7124-9512 | 12 x 145mm |
| 7124-9514 | 14 x 145mm |
| 7124-9516 | 16 x 145mm |



## Comma Guide

| Cat. No.  |
|-----------|
| 7124-9865 |

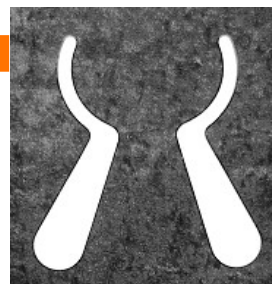

## COFIELD2 Keeled Glenoid Trial

| Cat. No.  | Size   |
|-----------|--------|
| 7124-9401 | Small  |
| 7124-9402 | Medium |
| 7124-9403 | Large  |



## Darrach Retractor

| Cat. No.  | Size  |
|-----------|-------|
| 7124-9908 | Small |
| 7124-9910 | Large |



## COFIELD2 Pegged Glenoid Trial

| Cat. No.  | Size   |
|-----------|--------|
| 7124-9601 | Small  |
| 7124-9602 | Medium |
| 7124-9603 | Large  |



## Deltoid Retractor

| Cat. No.  | Size  |
|-----------|-------|
| 7124-9904 | Small |
| 7124-9906 | Large |



## COFIELD2 Trial Caddy (Tray only, no instruments)

| Cat. No.  |
|-----------|
| 7124-9671 |

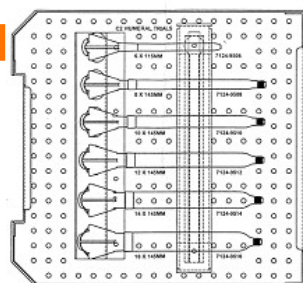

## Fukuda Retractor

| Cat. No.  | Size  |
|-----------|-------|
| 7124-9900 | Small |
| 7124-9902 | Large |



## Genesis Pin & Drill Set

(Not shown)

| Cat. No. |
|----------|
| 11-4968  |

## Glenoid Alignment Peg

| Cat. No. |
|----------|
| 11-1030  |



# Reconstructive Surgery

## Shoulder Systems

### Glenoid Drill 1

Cat. No.  
7124-9835



### Glenoid Peg Rasp

(Not shown)

Cat. No.  
7124-9863

### Glenoid Drill 2

Cat. No.  
7124-9836



### Glenoid Reamers

| Cat. No.  | Size   |
|-----------|--------|
| 7124-9801 | Small  |
| 7124-9802 | Medium |
| 7124-9803 | Large  |



### Glenoid Drill Guide 1

| Cat. No.  | Size   |
|-----------|--------|
| 7124-9851 | Small  |
| 7124-9852 | Medium |
| 7124-9853 | Large  |



### Glenoid Tray

(Tray only, no instruments)

Cat. No.  
7124-9666

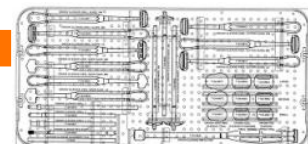

### Glenoid Drill Guides 2

| Cat. No.  | Size   |
|-----------|--------|
| 7124-9821 | Small  |
| 7124-9822 | Medium |
| 7124-9823 | Large  |



### Humeral Head Impactor

Cat. No.  
7124-9712



### Glenoid Impactor

Cat. No.  
7124-9841



### Humeral Head Removal Tool

Cat. No.  
7124-9705



### Glenoid Keel Cutter

Cat. No.  
7124-9837



### Humeral Prep Sterile Tray, Bottom

(Tray only, no instruments)

Cat. No.  
7124-9648

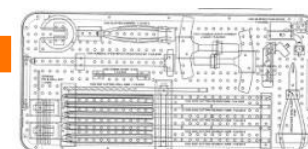

### Glenoid Keel Rasp

| Cat. No.  | Size   |
|-----------|--------|
| 7124-9831 | Small  |
| 7124-9832 | Medium |
| 7124-9833 | Large  |



## Humeral Prep Sterile Tray, Top (Tray only, no instruments)

Cat. No.  
7124-9647

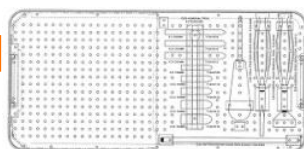

## Humeral Stem Impactor/Extractor

Cat. No.  
7124-9706



## Humeral Stem Trial Ext.

| Cat. No.  | Size       |
|-----------|------------|
| 7124-9108 | 8 x 50mm   |
| 71249110  | 10 x 50mm  |
| 7124-9112 | 12 x 50mm  |
| 7124-9114 | 14 x 50mm  |
| 7124-9116 | 16 x 50mm  |
| 7124-9208 | 8 x 100mm  |
| 7124-9210 | 10 x 100mm |
| 7124-9212 | 12 x 100mm |



## IM Resection Guide

Cat. No.  
7124-9864



## Kirschner Wire Plier

Cat. No.  
37497



## Modular Neer 3 Head Trial

(Not shown)

| Cat. No.  | Size      |
|-----------|-----------|
| 7124-9914 | 15 x 42mm |
| 7124-9918 | 18 x 46mm |
| 7124-9921 | 21 x 49mm |
| 7124-9924 | 24 x 50mm |
| 7124-9927 | 26 x 51mm |

## Modular Neer 3 Stem Trial

(Not shown)

| Cat. No.  | Size       |
|-----------|------------|
| 7124-9634 | 8 x 125mm  |
| 7124-9635 | 10 x 125mm |
| 7124-9636 | 12 x 125mm |
| 7124-9640 | 14 x 125mm |

## Modular Neer 3 Trial Caddy

(Tray only, no instruments)

Cat. No.  
7124-9669

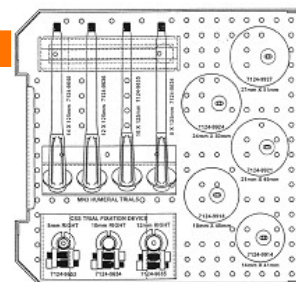

## Neer 3 Humeral Head Trial



| Cat. No. | Size |
|----------|------|
| 26301    | 15mm |
| 26302    | 19mm |
| 26303    | 22mm |
| 26304    | 26mm |

### Neer 3 Humeral Stem Trial

| Cat. No. | Size       |
|----------|------------|
| 26308    | 8 x 125mm  |
| 26310    | 10 x 125mm |
| 26312    | 12 x 125mm |



### Slotted Hammer

| Cat. No.  |
|-----------|
| 7124-9915 |



### T-Handle

| Cat. No.  |
|-----------|
| 7124-9920 |



### Neer 3 Trial Caddy (Tray only, no instruments)

| Cat. No.  |
|-----------|
| 7124-9673 |

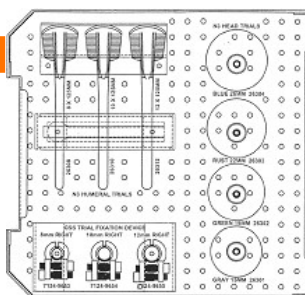

### Trial Device Driver

| Cat. No.  |
|-----------|
| 7124-9646 |

(Not shown)

### Retractors Tray (Tray only, no instruments)

| Cat. No.  |
|-----------|
| 7124-9667 |

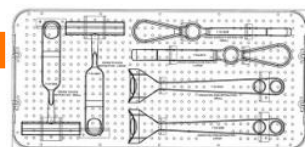

### Trial Fixation Device

| Cat. No.  | Size |
|-----------|------|
| 7124-9653 | 8mm  |
| 7124-9654 | 10mm |
| 7124-9655 | 12mm |



### Retroversion Guide Rod

| Cat. No.  |
|-----------|
| 7124-9662 |



### Universal Outer Tray, Small

| Cat. No.  |
|-----------|
| 7112-9401 |

(Not shown)

### Side Cutting Reamer

| Cat. No.  | Size (mm) |
|-----------|-----------|
| 7124-8906 | 6         |
| 7124-8908 | 8         |
| 7124-8910 | 10        |
| 7124-8912 | 12        |
| 7124-8914 | 14        |
| 7124-8916 | 16        |



### Universal Outer Tray, Large

| Cat. No.  |
|-----------|
| 7112-9400 |

(Not shown)

### Universal Tray Lid

(Not shown)

Cat. No. [Redacted]

7112-9402



## Cement & Accessories

### Vacuum Pump Connectors

Connector, D.I.S.S.

Cat. No.

7127-0052



Connector, Dragger

Cat. No.

7127-0051



Connector, Schraeder

Cat. No.

7127-0050



### Bone Cement Mixing and Delivery Components

InjectOR Cement Gun

Cat. No.

7127-2000



MixOR Hose Only

Cat. No.

7127-0041



MixOR Pump Only

Cat. No.

7127-0042



MixOR Vacuum Mixing System with Syringe

Cat. No.

7127-0020



Stryker Foot Pump Adapter

Cat. No.

7127-0060



## Vortex Cement Gun

| Cat. No.  |
|-----------|
| 7127-2001 |



## Buck Cement Restrictors



| Cat. No.               | Description   |
|------------------------|---------------|
| 91-4535                | 13mm          |
| 12-9418                | 18.5mm        |
| 12-9419                | 25mm          |
| 7127-9420              | 30mm          |
| 7127-9421              | 35mm          |
| w/ Disposable Inserter |               |
| 7127-9422              | 18.5mm        |
| 8127-9423              | 25mm          |
| 7127-9424              | 30mm          |
| 7127-9425              | 35mm          |
| 11-2428                | Buck Inserter |

## Vortex Nozzles

| Cat. No.  | Description        |
|-----------|--------------------|
| 7127-0080 | Standard Breakaway |
| 7127-0081 | Long Tapered       |
| 7127-0082 | Angled Nozzle      |
| 7127-0084 | Revision           |
| 7127-0085 | Umbrella           |
| 7127-0072 | Adaptor            |



## Vortex Vacuum Bowl

| Cat. No.  |
|-----------|
| 7127-0068 |



## Femoral Pressurizers



| Cat. No.  | Size   |
|-----------|--------|
| 7127-0028 | Large  |
| 7127-0027 | Medium |
| 7127-0026 | Small  |

## Vortex Vacuum Mixer

| Cat. No.  | Description            |
|-----------|------------------------|
| 7127-0070 |                        |
| 7127-0071 | Re-Use Kit (Not Shown) |



## Jet Vacs

| Cat. No. | Description           |
|----------|-----------------------|
| 89-0105  | Universal Tip (shown) |
| 89-0106  | Hip Tip               |
| 89-0107  | Intermediate Tip      |



## Prep-IM Total Hip Preparation Kit

| Cat. No. | Description                      |
|----------|----------------------------------|
| 12-1010  | 2 Buck Cement Restrictors        |
|          | 1 Femoral Canal Brush            |
|          | 1 Buck Disposable Inserter       |
|          | 1 Femoral Canal Suction Absorber |
|          | 2 Concise Cement Sculptors       |
|          | 1 Medium Femoral                 |



## Femoral Preparation and Bone Cement

### Prep-IM Total Hip Preparation Kit

| Cat. No. | Description |
|----------|-------------|
|          | Pressurizer |

### VersaBond Bone Cement



| Cat. No.  | Description |
|-----------|-------------|
| 7127-1140 | 40 Gram     |

### Miscellaneous

#### ACET Cement Restrictor

(Not shown)

| Cat. No. | Description |
|----------|-------------|
| 12-0708  | Small       |
| 12-0709  | Large       |

#### Acetabular Bush

(Not shown)

| Cat. No. | Description |
|----------|-------------|
| 11-0032  |             |

#### Acetabular Cement Compressor

(Not shown)

| Cat. No. | Description |
|----------|-------------|
| 11-1430  |             |

### Buck Cement Restrictor Vent Opening Tool

(Not shown)

| Cat. No. | Description |
|----------|-------------|
| 11-0028  |             |

### Cement Mixing Bowl w/ Spatula

(Not shown)

| Cat. No. | Description |
|----------|-------------|
| 21-0098  |             |

### Cement Mixing Spatula

(Not shown)

| Cat. No. | Description |
|----------|-------------|
| 21-0088  |             |

### Cement Mixing Spatula

(Not shown)

| Cat. No. | Description |
|----------|-------------|
| 89-0098  |             |

### Concise Cement Sculps Kit

(Not shown)

| Cat. No. | Description |
|----------|-------------|
| 11-1000  |             |

### Disposable Acetabular Cement Cap w/ Shield

(Not shown)

| Cat. No. | Description |
|----------|-------------|
| 11-1431  | 54mm        |
| 11-1432  | 62mm        |
| 11-1433  | 70mm        |

### Disposable Femoral Cement Compressor Cap

(Not shown)

| Cat. No. | Description |
|----------|-------------|
| 11-1435  |             |

### Femoral Canal Brush Narrow

(Not shown)

| Cat. No. | Description |
|----------|-------------|
| 11-0033  |             |

### Femoral Canal Brush Standard

(Not shown)

Cat. No.

11-0003

### Femoral Canal Suction Absorber Large

(Not shown)

Cat. No.

11-0038

### Femoral Canal Suction Absorber Standard

(Not shown)

Cat. No.

11-0037

### Femoral Cement Compressor

(Not shown)

Cat. No.

11-1434

### Femoral Cement Ventilation Tub

(Not shown)

Cat. No.

89-0100

### Jet-Vac Cement Dispenser

(Not shown)

Cat. No.

89-0105

Description

Universal

89-0106

Hip Tip

89-0107

Intermediate

### Richards Cement Hook

(Not shown)

Cat. No.

89-0095

## PowerPulse Lavage System

### Power Pulse Handpiece with Synthes Connection

Cat. No.

7127-7006



### Power Pulse Handpiece with Zimmer Coupling

Cat. No.

7127-7000



### Power Pulse Hip with Suction tip

Cat. No.

7127-7004



### Power Pulse Hip without Suction tip

Cat. No.  
7127-7005



### Power Pulse Knee without Suction tip

Cat. No.  
7127-7003



### Power Pulse Powerhose with Zimmer Coupling

Cat. No.  
7127-7001



### Supartz Joint Fluid Therapy

#### Supartz Joint Fluid Therapy

| Cat. No.  | Description |
|-----------|-------------|
| 7156-7765 |             |

